

Oracle® Revenue Management and Billing
Version 5.0.0.0.0

Banking User Guide

Revision 22.5

F72765-01

November 2022



Notices

Oracle Revenue Management and Billing Version 5.0.0.0.0 Banking User Guide

F72765-01

Copyright Notice

Copyright © 2009, 2022 Oracle and/or its affiliates. All rights reserved.

Trademark Notice

Oracle, Java, JD Edwards, PeopleSoft, and Siebel are registered trademarks of Oracle Corporation and/or its affiliates. Other names may be trademarks of their respective owners.

Intel and Intel Xeon are trademarks or registered trademarks of Intel Corporation. All SPARC trademarks are used under license and are trademarks or registered trademarks of SPARC International, Inc. AMD, Opteron, the AMD logo, and the AMD Opteron logo are trademarks or registered trademarks of Advanced Micro Devices. UNIX is a registered trademark of The Open Group.

License Restrictions Warranty/Consequential Damages Disclaimer

This software and related documentation are provided under a license agreement containing restrictions on use and disclosure, and are protected by intellectual property laws. Except as expressly permitted in your license agreement or allowed by law, you may not use, copy, reproduce, translate, broadcast, modify, license, transmit, distribute, exhibit, perform, publish, or display any part, in any form, or by any means. Reverse engineering, disassembly, or de-compilation of this software, unless required by law for interoperability, is prohibited.

Warranty Disclaimer

The information contained herein is subject to change without notice and is not warranted to be error-free. If you find any errors, please report them to us in writing.

Restricted Rights Notice

If this software or related documentation is delivered to the U.S. Government or anyone licensing it on behalf of the U.S. Government, the following notice is applicable:

U.S. GOVERNMENT RIGHTS

Oracle programs, including any operating system, integrated software, any programs installed on the hardware, documentation, and/or technical data delivered to U.S. Government end users are “commercial computer software” or “commercial technical data” pursuant to the applicable Federal Acquisition Regulation and agency-specific supplemental regulations. As such, use, duplication, disclosure, modification, and adaptation of the programs, including any operating system, integrated software, any programs installed on the hardware, documentation, and/or technical data shall be subject to license terms

U.S. GOVERNMENT RIGHTS

and restrictions as mentioned in Oracle License Agreement, and to the extent applicable, the additional rights set forth in FAR 52.227-19, Commercial Computer Software--Restricted Rights (June 1987). No other rights are granted to the U.S. Government.

Hazardous Applications Notice

This software is developed for general use in a variety of information management applications. It is not developed or intended for use in any inherently dangerous applications, including applications that may create a risk of personal injury. If you use this software in dangerous applications, then you shall be responsible to take all appropriate fail-safe, backup, redundancy, and other measures to ensure the safe use of this software. Oracle Corporation and its affiliates disclaim any liability for any damages caused by use of this software in dangerous applications.

Third Party Content, Products, and Services Disclaimer

This software and documentation may provide access to or information on content, products, and services from third parties. Oracle Corporation and its affiliates are not responsible for and expressly disclaim all warranties of any kind with respect to third party content, products, and services unless otherwise set forth in an applicable agreement between you and Oracle. Oracle Corporation and its affiliates will not be responsible for any loss, costs, or damages incurred due to your access to or use of third party content, products, or services.

Contents

Preface: About this Document.....	lix
Intended Audience.....	lix
Organization of the Document.....	lix
Conventions.....	lxiv
Related Documents.....	lxiv
Change Log.....	lxv
Chapter 1: Customer Registration.....	73
Customer Registration (Without Approval) Status Transition.....	77
Customer Registration (With Approval) Status Transition.....	77
Customer Registration Template.....	78
Search Customer Registration Template.....	79
Customer Registration Template.....	81
Searching for a Customer Registration Template.....	83
Viewing the Customer Registration Template Details.....	83
Defining a Customer Registration Template.....	84
Adding the Pages and Sections in a Customer Registration Template.....	86
Setting the Field Attributes for a Template Section.....	90
Editing a Customer Registration Template.....	96
Copying a Customer Registration Template.....	97
Deleting a Customer Registration Template.....	99
Customer Registration Type.....	99
Customer Registration Type List.....	100
Customer Registration Type.....	101
Searching for a Customer Registration Type.....	107
Defining a Customer Registration Type.....	108
Defining Additional Data for a Customer Registration Type.....	111
Defining a Characteristic for a Customer Registration Type.....	115
Associating a Customer Registration Template with a Customer Registration Type.....	116
Setting Attributes to Define a Customer Registration Using the Existing Customer Registration.....	118
Editing a Customer Registration Type.....	121
Copying a Customer Registration Type.....	124
Deleting a Customer Registration Type.....	126
Viewing the Customer Registration Type Details.....	127
Customer Registration (Used for Searching).....	127
Search Customer Registration.....	127
Searching for a Customer Registration.....	137
Viewing the Customer Registration Details.....	138
Defining a Customer Registration.....	139
Adding the Names of a Person.....	142
Adding the Phone Details of a Person.....	143
Adding the Identifier Details of a Person.....	144
Adding the Contact Details of a Person.....	145
Defining a Characteristic for a Person.....	148
Defining a Person to Person Relationship for a Person.....	149
Defining a Characteristic for a Person to Person Relationship.....	150
Adding an Account for a Person.....	152

Adding the Identifier Details of an Account.....	156
Adding the Automatic Payment Details of an Account.....	157
Associating a Person to an Account.....	159
Adding the Bill Routing Information for an Account.....	161
Defining a Characteristic for an Account.....	162
Adding the Credit Rating Details for an Account.....	164
Adding the Deal Information for a Person.....	165
Defining a Characteristic for a Customer Registration.....	167
Viewing the Details of an Account.....	168
Editing the Account Details of a Person.....	169
Copying a Customer Registration.....	172
Customer Registration (Used for Viewing).....	175
Customer Registration - Main.....	176
Customer Registration.....	176
Account Information.....	181
Customer Registration - Account.....	182
Account Information.....	182
Customer Registration - Log.....	186
Customer Registration Log.....	186
Editing the Customer Registration Details.....	187
Deleting a Customer Registration.....	190
Submitting a Customer Registration.....	190
Approving a Customer Registration.....	191
Rejecting a Customer Registration.....	192
Requesting to Resubmit a Customer Registration for Approval.....	193
Viewing the Log of a Customer Registration.....	195
Adding a Log Entry for a Customer Registration.....	195

Chapter 2: Customer 360° View..... 197

Customer 360° View.....	198
360° Search.....	198
Searching for a Person.....	203
Searching for an Account.....	204
Viewing the 360° Information of a Person.....	205
Viewing the 360° Information of an Account.....	207
Viewing Price Lists Assigned to a Person.....	209
Viewing Price Lists Assigned to an Account.....	210
Viewing Price Items of the Price List Assigned to a Person.....	211
Viewing Price Items of the Price List Assigned to an Account.....	211
Viewing Price Items Associated to a Product.....	212
Viewing Enrollment Details of a Product.....	212
Customer 360° Information.....	213
Customer 360° Information - Person.....	213
Person Information.....	214
Person Characteristics.....	215
Linked Accounts.....	215
Person Legal Hierarchy.....	216
Customer Contacts.....	217
Enrolled Products.....	217
Product Enrollment Information.....	218
Customer 360° Information - Account.....	218
Account Information.....	219
Account Characteristics.....	222
Account Persons.....	222
Enrolled Products.....	223

Auto Pay Details.....	224
Timeline.....	224
Billing History.....	227
Payment History.....	228
Dispute Details.....	228
Hold Details.....	228
Overdue Process Details.....	229
Trial Bills.....	229
Customer 360° Information - Product and Pricing.....	230
Product.....	230
Associated Price Items.....	231
Price List Assignments.....	231
Price List Price Items.....	232
Effective Price Assignments for Account.....	233
Effective Price Assignments for Person.....	237
Viewing Enrollment Details of a Product.....	241
Viewing the Bill Information.....	241
Viewing Price Items Associated to a Product.....	242
Bill Information.....	243
Bill Information.....	243
Settlement Activities.....	244
Hold Details.....	244
Offset Details.....	245
Bill Line Items.....	246
Garnishment Details.....	246
Refund and Write Off Details.....	247
Dispute Details.....	247

Chapter 3: Invoicing Group..... 249

Manage Invoicing Groups.....	251
Searching for a Master Account.....	251
Searching for a Member Account.....	252
Viewing the Master Account Details.....	254
Viewing the Member Account Details.....	255
Invoicing Group Maintenance — Add/Edit.....	255
Account Information.....	255
Member Accounts.....	256
Edit Member Account Assignment.....	256
Search Accounts to Add.....	257
Add Member.....	258
Adding a Member to the Master Account.....	259
Editing the Member Account Assignment Details.....	260
Removing a Member from the Master Account.....	261
Invoicing Group Information.....	262
Invoicing Group Information.....	262
Selected Member Account.....	262
Edit Member Account Assignment.....	263
Editing the Member Account Assignment Details.....	264
Removing a Member from the Master Account.....	265

Chapter 4: Pricing Management (Financial Services Business).....267

Prerequisites (Financial Services Business).....	269
Types of Pricing.....	270
Variance Parameter Based Pricing.....	271

Multi Parameter Based Pricing.....	271
Multiple Parameter Based Post-Processing Pricing.....	274
Price Assignment Search Mechanism.....	275
Person Relationship Type Sequence.....	278
Pricing Eligibility.....	280
Persisting Interest Rate for Rate Type Price Items.....	281
Persisting Fee for Fee Type Price Items.....	281
Repricing.....	282
Two-Dimensional Pricing.....	286
Types of Price Item Bundle.....	287
Regular Bundle.....	287
Ratio Bundle.....	288
Phantom Bundle.....	291
Parameter.....	292
Parameter (Used for Searching).....	293
Search Parameter.....	293
Searching for a Parameter.....	296
Defining a Parameter.....	296
Editing a Parameter.....	303
Deleting a Parameter.....	310
Copying a Parameter.....	310
Viewing the Parameter Details.....	317
Parameter (Used for Viewing).....	317
Parameter.....	317
Entity Hierarchy Relationship.....	320
Hierarchy Entity (Used for Searching).....	322
Search Hierarchy Entity.....	322
Searching for a Hierarchy Entity.....	324
Viewing the Hierarchy Entity Details.....	324
Defining a Hierarchy Entity.....	325
Associating a Hierarchy Entity with a Division.....	327
Defining a Characteristic for a Hierarchy Entity.....	328
Hierarchy Entity (Used for Viewing).....	329
Hierarchy Entity.....	329
Editing a Hierarchy Entity.....	331
Deleting a Hierarchy Entity.....	333
Copying a Hierarchy Entity.....	334
Entity Hierarchy Relationship (Used for Searching).....	336
Search Hierarchy.....	336
Searching for an Entity Hierarchy Relationship.....	337
Defining an Entity Hierarchy Relationship.....	338
Viewing the Entity Hierarchy Relationship Details.....	343
Entity Hierarchy Relationship (Used for Viewing).....	344
Hierarchy.....	344
Hierarchy Relationship Tree.....	345
Editing an Entity Hierarchy Relationship.....	346
Deleting an Entity Hierarchy Relationship.....	351
Copying an Entity Hierarchy Relationship.....	352
Price Item (Financial Services Business).....	356
Price Item (Used for Searching).....	358
Search Price Item.....	358
Searching for a Price Item or Price Item Bundle.....	361
Defining a Price Item or Price Item Bundle.....	361
Associating a Parameter with a Price Item or Price Item Bundle.....	369
Defining the Valid Predefined Parameter Values for a Price Item or Price Item Bundle.....	372

Associating a Price Item or Price Item Bundle with a Division.....	374
Associating an SQI with a Price Item or Price Item Bundle for a Division.....	377
Defining a Division-Specific Characteristic for a Price Item or Price Item Bundle.....	379
Defining the Accrual Type Criteria of a Price Item or Price Item Bundle for a Division.....	380
Associating a Price Item or Price Item Bundle with a Hierarchy Entity in an Entity Hierarchy Relationship of a Division.....	382
Defining the Cost of a Price Item or Price Item Bundle for a Division.....	384
Defining the Average Price Floor and Ceil Values of a Price Item or Price Item Bundle for a Division.....	387
Defining the Rate Negotiability Floor and Ceil Values of a Price Item or Price Item Bundle for a Division.....	390
Defining a Characteristic for a Price Item or Price Item Bundle.....	392
Copying a Price Item or Price Item Bundle.....	394
Viewing the Price Item or Price Item Bundle Details.....	401
Price Item (Used for Viewing).....	402
Price Item.....	403
Price Item Characteristics.....	405
Parameters.....	405
Predefined Parameter Values for Price Item.....	406
Divisions.....	406
Division-Specific SQIs for Price Item.....	407
Division-Specific Characteristics for Price Item.....	407
Division-Specific Accrual Type Criteria for Price Item.....	408
Division-Specific Hierarchy for Price Item.....	408
Division-Specific Negotiability Floor and Ceil Values for Price Item.....	409
Division-Specific Cost for Price Item.....	410
Division-Specific Average Price Floor and Ceil Values for Price Item.....	411
Price Item Relationship.....	412
Editing a Price Item or Price Item Bundle.....	413
Price Item Relationship.....	420
Assigned Price Items.....	421
Viewing the Price Items or Price Item Bundles Associated with a Parent Price Item.....	423
Viewing the Price Items or Price Item Bundles Added to a Price Item Bundle.....	423
Associating a Price Item or Price Item Bundle with a Parent Price Item.....	424
Adding a Price Item or Price Item Bundle to a Price Item Bundle.....	426
Setting the Parameters for a Price Item or Price Item Bundle.....	429
Defining Relationship-Specific Characteristics for a Price Item or Price Item Bundle.....	430
Disassociating a Price Item or Price Item Bundle from a Parent Price Item.....	432
Removing a Price Item or Price Item Bundle from a Price Item Bundle.....	432
Filtering the Price Items or Price Item Bundles Associated with a Parent Price Item.....	433
Filtering the Price Items or Price Item Bundles Added to a Price Item Bundle.....	434
Price Item Assignments.....	434
Active Price Lists where Price Item is Assigned.....	435
Persons to whom Price Item is Assigned.....	435
Accounts where Price Item is Assigned.....	436
Viewing the Price Lists, Persons, or Accounts where a Price Item is Assigned.....	437
Price List.....	437
Price List (Used for Searching).....	438
Search Price List.....	439
Price List Price Items.....	442
Price Item Pricing.....	443

Price Assignment Tree.....	448
Searching for a Price List.....	449
Viewing Price Items Assigned to a Price List.....	450
Defining a Price List.....	450
Defining the Price List Hierarchy.....	453
Defining a Characteristic for a Price List.....	454
Associating a Price List with a Division.....	455
Defining Eligibility Criteria for a Price List.....	456
Associating Eligibility Criteria of Parameters for a Price List.....	457
Copying a Price List.....	459
Viewing the Price List Details.....	461
Viewing Accounts and Persons Eligible for Price List Assignment.....	462
Price List (Used for Viewing).....	463
Price List.....	463
Eligibility Criteria.....	465
Editing a Price List.....	466
Price List Price Item Pricing.....	468
Price List Price Items.....	469
Search Price Item or Price Item Pricing.....	470
Viewing Price Items Assigned to a Price List.....	476
Removing a Price Item from a Price List.....	477
Viewing a Price Item Pricing.....	477
Editing a Price Item Pricing of a Price List.....	479
Assigning a Price Item to a Price List.....	484
Defining the Deal Information in a Price Item Pricing.....	490
Defining TFM Information in a Price Item Pricing.....	491
Defining a Characteristic for a Price Item Pricing.....	492
Defining a Parameter for a Price Item Pricing.....	493
Defining the Division-Specific Cost of a Price item in the Price Item Pricing.....	495
Defining the Division-Specific Average Price Limits of a Price item in the Price Item Pricing.....	496
Defining the Division-Specific Rate Negotiability Limits of a Price item in the Price Item Pricing.....	498
Copying a Price Item Pricing.....	499
Price List Assignment.....	500
Price List Assignments.....	501
Price List Price Items.....	503
Search Price List for Assignment.....	504
Viewing Price Lists Assigned to an Account.....	507
Viewing Price Lists Assigned to a Person.....	508
Viewing Price Items Assigned to a Price List.....	509
Assigning a Price List to an Account.....	510
Assigning a Price List to a Person.....	513
Defining a Characteristic for a Price List Assignment.....	516
Editing the Price List Assignment Details of an Account.....	517
Editing the Price List Assignment Details of a Person.....	520
Price List Assignments.....	523
Accounts where Price List is Assigned.....	523
Persons to whom Price List is Assigned.....	524
Viewing Accounts and Persons where Price List is Assigned.....	524
Entities Eligible for Price List Assignment.....	525
Eligible Accounts.....	525
Eligible Persons.....	527
Assigning a Price List to One or More Eligible Accounts.....	528
Assigning a Price List to One or More Eligible Persons.....	530
Defining a Characteristic for a Price List Assignment.....	532

Price List Simulation.....	533
Price List Simulation.....	534
Price List Simulation Request.....	540
Price List Simulation Results.....	544
Pricing (Account).....	550
Effective Price Assignments for Account.....	550
Search Price Item or Price Item Pricing.....	555
Viewing Effective Price Assignments of an Account.....	560
Filtering Effective Price Assignments of an Account.....	561
Exporting Effective Price Assignments of an Account.....	562
Copying a Price Item Pricing.....	565
Viewing a Price Item Pricing.....	566
Editing a Price Item Pricing of an Account.....	568
Overriding a Price Item Pricing of an Account.....	571
Assigning a Price Item to an Account.....	575
Defining a Characteristic for a Price Item Pricing.....	578
Defining a Parameter for a Price Item Pricing.....	579
Defining TFM Information in a Price Item Pricing.....	581
Pricing (Person).....	582
Effective Price Assignments for Person.....	583
Search Price Item or Price Item Pricing.....	587
Viewing Effective Price Assignments of a Person.....	592
Filtering Effective Price Assignments of a Person.....	593
Exporting Effective Price Assignments of a Person.....	594
Copying a Price Item Pricing.....	597
Viewing a Price Item Pricing.....	598
Editing a Price Item Pricing of a Person.....	599
Overriding a Price Item Pricing of a Person.....	603
Assigning a Price Item to a Person.....	607
Defining a Characteristic for a Price Item Pricing.....	610
Defining a Parameter for a Price Item Pricing.....	611
Defining TFM Information in a Price Item Pricing.....	612
Price Item Pricing (Used for Viewing).....	614
Price Item Pricing.....	615
Price Item Pricing.....	616
Price Assignment Tree.....	621
Price Component.....	622
Two-Dimensional Pricing.....	625
Defining a Price Item Pricing.....	626
Defining the Deal Information in a Price Item Pricing.....	632
Defining TFM Information in a Price Item Pricing.....	633
Defining a Characteristic for a Price Item Pricing.....	634
Defining a Parameter for a Price Item Pricing.....	635
Defining the Division-Specific Cost of a Price item in the Price Item Pricing.....	637
Defining the Division-Specific Average Price Limits of a Price item in the Price Item Pricing.....	638
Defining the Division-Specific Rate Negotiability Limits of a Price item in the Price Item Pricing.....	640
Viewing the Price Components of a Rate Component.....	641
Viewing the Tiering Criteria of a Price Component.....	643
Viewing the Pricing Eligibility Criteria of a Price Component.....	645
Defining a Price Component for a Rate Component.....	647
Defining a Tiering Criteria for a Price Component.....	652
Defining a Pricing Eligibility Criteria for a Price Component.....	654
Editing a Price Component.....	658
Copying a Price Component.....	662

Deleting a Price Component.....	666
Editing a Tiering Criteria of a Price Component.....	669
Editing a Pricing Eligibility Criteria of a Price Component.....	673
Editing a Price Item Pricing.....	678
Deleting a Price Item Pricing.....	685
Submitting a Price Item Pricing.....	688
Overriding a Price Item Pricing.....	691
Editing the Two-Dimensional Pricing.....	692
Pricing Simulation.....	694
Search Pricing.....	695
Simulation - Effective Pricing Information.....	699
Searching Pricing Simulation for Account or Price List.....	704
Viewing Pricing Simulation.....	704
Exporting Effective Price Simulation.....	705
Eligible Price List.....	707
Search Eligible Price Lists.....	708
Rate Definition.....	710
Rate Schedule Components.....	710
Create/Edit Rate Definition.....	711
Defining Tiering Setup of a Rate Component.....	712
Editing Tiering Setup of a Rate Component.....	713
Deleting Tiering Setup of a Rate Component.....	714
Tiering Criterion.....	715
Tiering Criterion List.....	715
Edit Tiering Criterion.....	715
Create Tiering Criterion.....	716
Creating a Tiering Criterion.....	716
Editing a Tiering Criterion.....	717
Variance Parameter.....	718
Filtering the Variance Parameters.....	718
Defining a Variance Parameter.....	719
Editing a Variance Parameter.....	719
Deleting a Variance Parameter.....	720
Person to Person Relationship Type Sequence.....	721
Search Person Relationship Type Sequence for Price Item.....	721
Search Person Relationship Type Sequence for Division.....	723
Searching Relationship Type Sequence for a Division, Price Item, and Price Item Parameters.....	724
Defining Relationship Type Sequence for a Division, Price Item, and Price Item Parameters.....	725
Editing Relationship Type Sequence of a Division, Price Item, and Price Item Parameters.....	726
Deleting Relationship Type Sequence of a Division, Price Item, and Price Item Parameters.....	727
Viewing Relationship Type Sequence of a Division, Price Item, and Price Item Parameters.....	728
Searching Relationship Type Sequence for a Division.....	729
Defining Relationship Type Sequence for a Division.....	730
Editing Relationship Type Sequence of a Division.....	731
Deleting Relationship Type Sequence of a Division.....	732
Viewing Relationship Type Sequence of a Division.....	732
Chapter 5: Division.....	735
Division.....	736
Division - Main.....	738

Division - Access Groups.....	739
Division - Price Items.....	740
Division - Price Lists.....	740
Division - Languages.....	741
Division - Invoice Currencies.....	741
Division - Person Identifier Types.....	741
Division - Algorithms.....	742
Division - Characteristics.....	742
Division - Bill Messages.....	743
Division - Party Char Types.....	743
Division - Bill Cycles.....	743
Division - Account Identifier Types.....	744
Division - Price Item Characteristics.....	744
Searching for a Division.....	745
Defining a Division.....	746
Associating an Access Group with a Division.....	749
Associating a Price Item or Price Item Bundle with a Division.....	750
Associating a Price List with a Division.....	752
Associating a Language with a Division.....	753
Associating an Invoice Currency with a Division.....	754
Associating a Person Identifier Type with a Division.....	755
Associating an Algorithm with a Division.....	756
Defining a Characteristic for a Division.....	763
Associating a Bill Message with a Division.....	764
Associating a Party Characteristic Type with a Division.....	766
Associating a Bill Cycle with a Division.....	767
Associating an Account Identifier Type with a Division.....	768
Defining a Division-Specific Characteristic for a Price Item.....	769
Associating a To Do Type and To Do Role with a Division.....	770

Chapter 6: Approval Workflow..... 773

Most Commonly Used Terms.....	775
Approval Workflow Process.....	775
Prerequisites.....	777
Approval Transaction.....	779
Search Approval Transaction.....	779
Approval Transaction Log.....	783
Searching for an Approval Transaction.....	784
Viewing the Log of an Approval Transaction.....	784
Comparison: New versus Existing.....	785
Approving an Approval Transaction.....	785
Rejecting an Approval Transaction.....	786
Canceling an Approval Transaction.....	787
Modifying an Approval Transaction.....	788
Withdrawing an Approval Transaction.....	789
Resolving an Approval Transaction.....	789
Approve Price Assignment.....	790
Search.....	790
List of Price Assignments.....	793
Approve Price Assignment - Comparison: New versus Existing.....	794
Approval Transaction Log.....	796
Approving a Price Assignment for an Account.....	796
Approving a Price Assignment for a Person.....	798
Approving a Price Assignment for a Price List.....	799
Rejecting a Price Assignment for an Account.....	800

Rejecting a Price Assignment for a Person.....	801
Rejecting a Price Assignment for a Price List.....	803
Canceling a Price Assignment for an Account.....	804
Canceling a Price Assignment for a Person.....	805
Canceling a Price Assignment for a Price List.....	807
Modify Price Assignment.....	808
Search.....	808
List of Price Assignments.....	812
Modifying a Price Assignment for an Account.....	813
Modifying a Price Assignment for a Person.....	814
Modifying a Price Assignment for a Price List.....	815
Withdrawing a Price Assignment for an Account.....	815
Withdrawing a Price Assignment for a Person.....	816
Withdrawing a Price Assignment for a Price List.....	817
Viewing the Log of an Approval Transaction.....	818
Resolve Price Assignment.....	819
Search.....	819
List of Price Assignments.....	822
Resolving a Price Assignment for an Account.....	824
Resolving a Price Assignment for a Person.....	825
Resolving a Price Assignment for a Price List.....	825
Withdrawing a Price Assignment for an Account.....	826
Withdrawing a Price Assignment for a Person.....	827
Withdrawing a Price Assignment for a Price List.....	828
Viewing the Log of an Approval Transaction.....	829
Approval Workflow Group (Used for Searching).....	830
Search Approval Workflow Group.....	830
Searching for an Approval Workflow Group.....	831
Viewing the Approval Workflow Group Details.....	832
Defining an Approval Workflow Group.....	832
Adding a Business Object.....	836
Defining a Group BO Relation.....	838
Approval Workflow Group (Used for Viewing).....	839
Approval Workflow Group.....	839
Editing an Approval Workflow Group.....	841
Deleting an Approval Workflow Group.....	842
Editing a Business Object.....	842
Deleting a Business Object.....	844
Editing a Group BO Relation.....	844
Deleting a Group BO Relation.....	846
Approval Workflow Chain (Used for Searching).....	847
Search Approval Workflow Chain.....	847
Searching for an Approval Workflow Chain.....	848
Viewing the Approval Workflow Chain Details.....	848
Defining an Approval Workflow Chain.....	848
Defining Approval Levels for an Approval Workflow Chain.....	849
Approval Workflow Chain (Used for Viewing).....	850
Approval Workflow Chain.....	850
Editing an Approval Workflow Chain.....	851
Deleting an Approval Workflow Chain.....	852
Approval Workflow Criterion Type (Used for Searching).....	853
Search Approval Workflow Criterion Type.....	853
Searching for an Approval Workflow Criterion Type.....	853
Viewing the Approval Workflow Criterion Type Details.....	854
Defining an Approval Workflow Criterion Type.....	854
Approval Workflow Criterion Type (Used for Viewing).....	856

Approval Workflow Criterion Type.....	856
Editing an Approval Workflow Criterion Type.....	857
Deleting an Approval Workflow Criterion Type.....	859
Approval Workflow Group Chain Linkage (Used for Searching).....	859
Search Approval Workflow Group Chain Linkage.....	859
Searching for an Approval Workflow Group Chain Linkage.....	860
Viewing the Approval Workflow Group Chain Linkage Details.....	861
Defining an Approval Workflow Group Chain Linkage.....	861
Defining Group Chain Linkage Criteria for an Approval Workflow.....	863
Defining a Field Approval Rule.....	863
Approval Workflow Group Chain Linkage (Used for Viewing).....	865
Approval Workflow Group Chain Linkage.....	866
Editing an Approval Workflow Group Chain Linkage.....	868
Deleting an Approval Workflow Group Chain Linkage.....	869
Approval Workflow Setting (Used for Searching).....	869
Search Approval Workflow Group.....	869
Searching for an Approval Workflow Group.....	870
Viewing the Approval Workflow Setting Details.....	871
Defining Approval Workflow Group Settings.....	871
Approval Workflow Setting (Used for Viewing).....	873
Approval Workflow Group Settings.....	873
Editing Approval Workflow Group Settings.....	875
Deleting Approval Workflow Group Settings.....	875
Regenerating Input and Display UI Maps.....	876
Approval Workflow Reason (Used for Searching).....	876
Approval Workflow Reason List.....	876
Filtering the Approval Workflow Reasons.....	877
Viewing the Approval Workflow Reason Details.....	878
Defining an Approval Workflow Reason.....	878
Approval Workflow Reason (Used for Viewing).....	879
Approval Workflow Reason.....	879
Editing an Approval Workflow Reason.....	880
Deleting an Approval Workflow Reason.....	881

Chapter 7: Multi-Currency Accounts.....883

Creating Adjustments.....	885
Generating Bills.....	885
Applying Payments.....	885
Monitoring Overdue Debt.....	885
Generating History.....	885

Chapter 8: Rules Engine.....887

Rule Type (Used for Searching).....	889
Search Rule Type.....	889
Searching for a Rule Type.....	890
Defining a Rule Type.....	891
Defining Input and Output Parameters for a Rule Type.....	893
Associating a Characteristic Entity with a Rule Type.....	895
Associating an Algorithm with a Rule Type.....	896
Editing a Rule Type.....	897
Deleting a Rule Type.....	899
Copying a Rule Type.....	900
Rule Type (Used for Viewing).....	902
Rule Type.....	902

Viewing the Rule Type Details.....	904
Editing a Rule Type.....	904
Rule.....	907
Search Rule.....	907
Searching for a Rule.....	908
Viewing the Rule Details.....	909
Defining a Rule.....	909
Editing a Rule.....	914
Deleting a Rule.....	920
Copying a Rule.....	921
Rule.....	926
Rule Information.....	927
Viewing the Rule Details.....	928
Rule Check.....	929
Rule Check.....	930

Chapter 9: Alternate Sequential Bill Numbers..... 933

Alternate Sequential Bill Number Generation Algorithms.....	934
C1_ALTBLLSYS.....	934
C1_ALTBLSYS1.....	934
C1_ALTBLDV.....	937
C1_ALTBLDIV1.....	937
Enabling the Alternate Sequential Bill Numbers Feature.....	939

Chapter 10: Currency Conversion.....943

Prerequisites.....	945
Bill Segment Generation.....	946
Adjustment Creation.....	947
Payment and Tender Creation.....	947
Transaction Aggregation.....	948
FT GL Creation.....	948
Currency Conversion Algorithms.....	949
C1_CURALGBS.....	949
C1_CURALGAD.....	951
C1_CURALGPY.....	953
C1_CURALGTFM.....	955
C1_EXCRTBS.....	957
C1_EXCRTAD.....	958
C1_EXCRTPY.....	960
C1_EXCRTTFM.....	962
FTFREZGLEXTN.....	964
C1_EXCRTOVRD.....	966
Exchange Rate (Used for Searching).....	967
Search Exchange Rate.....	967
Searching for an Exchange Rate.....	971
Defining an Exchange Rate.....	971
Defining a Characteristic for an Exchange Rate.....	974
Editing an Exchange Rate.....	975
Deleting an Exchange Rate.....	977
Exchange Rate (Used for Viewing).....	978
Exchange Rate - Main.....	978
Exchange Rate.....	978
Exchange Rate - Log.....	980
Exchange Rate Log.....	980

Viewing the Exchange Rate Details.....	981
--	-----

Chapter 11: Transaction Feed Management..... 983

Prerequisites.....	984
Transaction Rating Before Billing.....	984
Transaction Aggregation.....	992
Header Validation.....	993
Transaction Validation and Initial Price Item Determination (Specific to Financial Services Domain).....	995
Price Item Pricing Verification.....	1005
Aggregation.....	1009
Clean Up.....	1013
Transaction Aggregation Batch Processing.....	1016
Transaction Disaggregation.....	1018
Transaction Disaggregation Batch Processing.....	1025
Transaction Cancellation.....	1026
Transaction Cancellation Batch Processing.....	1029
Transaction Rollback.....	1030
Feed Status Transition.....	1032
Transaction Status Transition.....	1033
Transaction Leg Status Transition.....	1034
Transaction Data File.....	1041
Error List.....	1043
Alert Notification for Transaction Feed Management.....	1078
Feed Management Dashboard.....	1078
Search.....	1079
Division Level Information.....	1085
Transaction Level Information.....	1086
Transaction Leg Information.....	1087
Transaction Leg Service Quantity.....	1088
Transaction Leg Calculation Lines.....	1089
Transaction Leg Calc Line Characteristics.....	1090
Searching for a Transaction Feed.....	1090
Viewing Division Level Details of a Transaction Feed.....	1091
Viewing Transactions that Belong to a Division.....	1092
Viewing Legs of a Transaction.....	1092
Viewing the SQIs Calculated for a Transaction Leg.....	1093
Viewing the Calculation Lines of a Transaction Leg.....	1093
Viewing Characteristics of a Calculation Line.....	1094
Transaction Details.....	1094
Search.....	1094
Transaction Legs.....	1098
Transaction Error Messages.....	1101
Searching for a Transaction.....	1101
Viewing the Transaction Legs.....	1102
Viewing Error Messages.....	1102
Viewing the Transaction Details.....	1103
Adding a Transaction.....	1103
Copying a Transaction.....	1106
Transaction Source.....	1109
Search Transaction Source.....	1109
Searching for a Transaction Source.....	1110
Defining a Transaction Source.....	1110
Editing a Transaction Source.....	1111
Copying a Transaction Source.....	1112

Deleting a Transaction Source.....	1113
Transaction Record Type.....	1113
Search Transaction Record Type.....	1113
Searching for a Transaction Record Type.....	1114
Defining a Transaction Record Type.....	1115
Editing a Transaction Record Type.....	1120
Deleting a Transaction Record Type.....	1125
Copying a Transaction Record Type.....	1126
Transaction Aggregation Rule.....	1131
Transaction Aggregation Rules.....	1131
Defining Transaction Aggregation Rule for an SQL.....	1132
Editing Transaction Aggregation Rule of an SQL.....	1133
Deleting Transaction Aggregation Rule of an SQL.....	1134
Schedule.....	1135
Search Schedule.....	1135
Searching for a Schedule.....	1135
Viewing the Schedule Details.....	1136
Defining a Schedule.....	1136
Editing a Schedule.....	1138
Deleting a Schedule.....	1139
Disaggregation Request.....	1139
Search Disaggregation Request.....	1140
Searching for a Disaggregation Request.....	1145
Creating a Disaggregation Request for a Person.....	1145
Creating a Disaggregation Request for an Account.....	1151
Creating a Disaggregation Request for a Price item.....	1156
Creating a Disaggregation Request for a Price Assignment.....	1162
Creating a Disaggregation Request for a Billable Charge.....	1166
Deleting a Disaggregation Request.....	1170

Chapter 12: On Demand Billing..... 1171

Prerequisites.....	1173
CSV File Format for Banking Usage Data.....	1175
CSV File Format for Insurance Usage Data.....	1177
Usage Record Status Transition.....	1180
File Type.....	1181
File Types.....	1182
Defining a File Type.....	1183
Editing a File Type.....	1188
Deleting a File Type.....	1193
On Demand Billing.....	1194
Search.....	1194
Group Files.....	1196
Searching for a File Group.....	1197
Defining a File Group.....	1198
Editing a File Group.....	1199
Deleting a File Group.....	1201
Closing a File Group.....	1201
Generating Adhoc Bills for a File Group.....	1202
Freezing All Bills of a File Group.....	1203
Freezing Selected Bills of a File Group.....	1204
Viewing All Bills Generated for a File Group.....	1205
Viewing Usage Data Files of a File Group.....	1207
Usage Data Processing.....	1207
Search.....	1207

Searching for a Usage Data File.....	1210
Uploading a Usage Data File.....	1211
Replacing an Existing File.....	1214
Viewing All Records of a Usage Data File.....	1217
Viewing Valid Records of a Usage Data File.....	1221
Viewing Invalid Records of a Usage Data File.....	1224
Viewing Submitted Records of a Usage Data File.....	1227
Viewing Processed Records of a Usage Data File.....	1231
Viewing Cancelled Records of a Usage Data File.....	1234
Viewing Rejected Records of a Usage Data File.....	1238
Viewing Billed Records of a Usage Data File.....	1241
Viewing Unbilled Records of a Usage Data File.....	1245
Submitting a Valid Record.....	1248
Approving a Valid Record.....	1250
Rejecting a Valid Record.....	1252
Cancelling a Usage Data File.....	1254
Revalidating a Usage Data File.....	1255
Editing a Valid, Invalid, or Rejected Usage Record.....	1256
Exporting Usage Data into CSV file.....	1257
Filtering Usage Records.....	1257

Chapter 13: Upload Validated Payment Data..... 1259

Payment Upload Process.....	1260
Upload Payment Records in the Pre-Staging Area.....	1260
Move Payment Records to the Staging Area.....	1261
Create Payment Events and Payments.....	1261
Prerequisites.....	1262
CSV File Format.....	1263
Sample CSV.....	1265
Payment Data File Status Transition.....	1265
Payment Record Status Transition.....	1266
Error Messages.....	1268
Payment Upload.....	1272
Search Payment Data File.....	1272
Payment Data Records.....	1275
Payment Staging Records.....	1276
Payment Data File Log.....	1277
Searching for a Payment Data File.....	1277
Uploading a Payment Data File.....	1278
Replacing an Existing File.....	1279
Cancelling a Payment Data File.....	1281
Moving the Payment Records to the Staging Area.....	1281
Editing a Payment Staging Record.....	1282
Viewing the Records of a Payment Data File.....	1283
Viewing the Staging Records of a Payment Data Record.....	1283
Viewing the Log of a Payment Data File.....	1284
Viewing the Errors of a Payment Data Record.....	1284

Chapter 14: Freeze Payments on Notification..... 1287

Freeze Payments on Notification Process.....	1289
Creating Automatic Payments and Refunds.....	1289
Generating a Flat File.....	1289
Uploading Response from Auto Clearing House (ACH).....	1289
Retry Automatic Payment.....	1290

Freezing or Canceling Automatic Payments.....	1291
Voiding Refund Requests and Canceling Refund Adjustments.....	1291
Generating To Do Entries.....	1292
Creating Tender Controls.....	1292
Prerequisites.....	1292
Automatic Payment or Refund Clearing Staging Record Status Transition.....	1293
EDI 824 File Format.....	1294
Sample EDI 824 File Format.....	1295
Automatic Payment and Refund Upload Reason.....	1295
Upload Reasons.....	1296
Defining an Upload Reason.....	1296
Editing an Upload Reason.....	1298
Deleting an Upload Reason.....	1300
Automatic Payment and Refund Clearing Staging.....	1301
Search Clearing Record.....	1301
Associated Clearing Staging Records.....	1303
Clearing Staging Upload Reasons.....	1304
Clearing Staging Characteristics.....	1305
Searching for a Clearing Record.....	1305
Viewing the Clearing Staging Records Associated to a Clearing Record.....	1306
Viewing the Upload Reason Specified in the Clearing Staging Record.....	1306
Viewing the Characteristics of the Clearing Staging Record.....	1307
Editing a Clearing Staging Record.....	1307
Defining a Characteristic for a Clearing Staging Record.....	1309
Deleting a Clearing Staging Record.....	1310

Chapter 15: Construct..... 1311

Prerequisites.....	1313
Construct Status Transition.....	1313
Template.....	1314
Search Template.....	1315
Searching for a Template.....	1316
Defining a Template.....	1317
Defining a Characteristic for a Template.....	1318
Editing a Template.....	1319
Deleting a Template.....	1322
Viewing the Template Details.....	1322
Construct (Used for Searching).....	1323
Search Construct.....	1323
Searching for a Construct.....	1325
Defining a Construct.....	1326
Defining a Characteristic for a Construct.....	1328
Editing a Construct.....	1329
Copying a Construct.....	1332
Viewing the Construct Details.....	1333
Construct (Used for Viewing).....	1334
Construct - Main.....	1334
Construct Information.....	1334
Include Usage/Invoice Accounts.....	1335
Include Billable Charges.....	1336
Include Adjustments.....	1337
Include Bill Segments.....	1337
Linked Accounts.....	1338
Exclude Usage/Invoice Accounts.....	1339
Construct - Log.....	1339

Construct Log.....	1339
Including Usage Accounts in a Construct.....	1340
Including Usage and Invoice Accounts in a Construct.....	1341
Excluding Usage Accounts from a Construct.....	1342
Excluding Usage and Invoice Accounts from a Construct.....	1343
Including Billable Charges in a Construct.....	1344
Including Bill Segments in a Construct.....	1345
Including Adjustments in a Construct.....	1346
Activating a Construct.....	1347
Billing and Settlement Hierarchy.....	1348
Search Hierarchy.....	1348
Linked Accounts.....	1350
Criteria.....	1351
Viewing Person Billing Hierarchy Details.....	1351
Viewing Person Settlement Hierarchy Details.....	1352
Viewing Usage Accounts Billed through an Invoice Account.....	1352
Viewing Invoice Accounts through which a Usage Account is Billed.....	1354
Viewing Settlement Accounts through which a Usage or Invoice Account is Settled.....	1355
Viewing Settlement Hierarchy of a Invoice or Usage Account.....	1355
Chapter 16: Trial Billing.....	1357
Prerequisites.....	1359
Trial Bill (Used for Searching).....	1359
Search Trial Bill	1359
Searching for a Trial Bill.....	1361
Viewing the Trial Bill Details.....	1361
Trial Bill (Used for Viewing).....	1362
Trial Bill.....	1362
Trial Bill Segments.....	1363
Trial Bill Segment Calc Lines.....	1365
Trial Bill Segment SQ Details.....	1366
Trial Bill Segment Financial Details.....	1367
Policy Details.....	1367
Printing a Trial Bill in the PDF Format.....	1368
Viewing the Segments of a Trial Bill.....	1368
Filtering the Trial Bill Segments.....	1369
Viewing the Calc Lines of a Trial Bill Segment.....	1369
Viewing the SQ Details of a Trial Bill Segment.....	1370
Viewing the Financial Details of a Trial Bill Segment.....	1370
Viewing the Policy Details of a Trial Bill Segment.....	1371
Chapter 17: Bill Tolerance.....	1373
Prerequisites.....	1374
Chapter 18: GL Account Validation.....	1377
Static GL Account Validation.....	1378
Dynamic GL Account Validation.....	1378
Chapter 19: Upload Validated Adjustment Data.....	1379
Prerequisites.....	1381
CSV File Format.....	1381
Adjustment Upload Request (Without Approval) Status Transition.....	1382

Adjustment Upload Request (With Approval) Status Transition.....	1383
Algorithms Used in C1-ADJUPLD.....	1384
Upload Request Type.....	1387
Upload Request Type List.....	1388
Upload Request Type.....	1389
Defining an Upload Request Type.....	1392
Defining a Characteristic for an Upload Request Type.....	1397
Editing an Upload Request Type.....	1398
Copying an Upload Request Type.....	1401
Mapping an Upload Request Type.....	1405
Deleting an Upload Request Type.....	1406
Viewing the Upload Request Type Details.....	1407
Adjustment Upload Request (Used for Searching).....	1407
Search Adjustment Upload Request.....	1408
Searching for an Adjustment Upload Request.....	1409
Uploading an Adjustment Data File.....	1410
Replacing an Adjustment Data File.....	1412
Viewing the Adjustment Upload Request Details.....	1415
Viewing All Records of an Adjustment Data File.....	1415
Adjustment Upload Request (Used for Viewing).....	1416
Adjustment Upload Request - Main.....	1416
Adjustment Upload Request.....	1416
Adjustment Data Records.....	1419
Adjustment Upload Request - Log.....	1420
Adjustment Upload Request Log.....	1420
Cancelling an Adjustment Data File.....	1420
Creating Adjustments for an Adjustment Data File.....	1421
Submitting an Adjustment Data File for Approval.....	1422
Approving an Adjustment Data File.....	1423
Rejecting an Adjustment Data File.....	1424
Viewing the Log of an Adjustment Upload Request.....	1425
Adding a Log Entry for an Adjustment Upload Request.....	1426

Chapter 20: Foreign Exchange Gain Loss..... 1429

Foreign Exchange Gain Loss Calculation.....	1430
Prerequisites.....	1430
Foreign Exchange Gain Loss Scenarios.....	1431
Payment Scenarios.....	1431
Credit Adjustment Scenarios.....	1435
Write Off Adjustment Scenarios.....	1436
Write Up/Down Adjustment Scenarios.....	1438

Chapter 21: Payment Request..... 1441

Prerequisites.....	1443
Payment Creation Request (Without Approval) Status Transition.....	1444
Payment Creation Request (With Approval) Status Transition.....	1445
Payment Transfer Request (Without Approval) Status Transition.....	1446
Payment Transfer Request (With Approval) Status Transition.....	1449
Algorithms Used in C1-PaymentRequest.....	1451
C1-PAYRQ-INF.....	1452
C1-PAYREQPOS.....	1452
C1-PAYREQVAL.....	1453
C1-PAY-DFT.....	1453
C1-PAYDFTEXT.....	1453

C1-PAY-PFA.....	1453
C1-PAYPFAEXT.....	1453
F1-TODOCOMPL.....	1453
C1-PAY-APP.....	1453
C1-PAY-DIST.....	1453
C1-PAY-MONT.....	1453
C1-PAYCREATE.....	1453
C1-FRZ-VALID.....	1454
C1-PAY-V-FRZ.....	1454
C1-PAY-FRZ.....	1454
C1-PAY-RJT.....	1454
C1-ISFREEZE.....	1454
Algorithms Used in C1-PaymentTransferRequest.....	1454
C1-PYTRDF.....	1455
C1-PAY-DFT.....	1456
C1-PAYDFTEXT.....	1456
C1-PYTR-MONT.....	1456
C1-PYTR-UPDT.....	1456
C1-PAY-PFA.....	1456
C1-PAYPFAEXT.....	1456
F1-TODOCOMPL.....	1456
C1-PAY-APP.....	1456
C1-PAY-DIST.....	1457
C1-PAY-MONT.....	1457
C1-PAYCREATE.....	1457
C1-FRZ-VALID.....	1457
C1-PAY-V-FRZ.....	1457
C1-PAY-FRZ.....	1457
C1-PAY-RJT.....	1457
C1-ISFREEZE.....	1457
Payment Request Type.....	1458
Payment Request Type List.....	1458
Payment Request Type.....	1459
Defining a Payment Request Type.....	1461
Defining a Characteristic for a Payment Request Type.....	1464
Editing a Payment Request Type.....	1465
Copying a Payment Request Type.....	1468
Deleting a Payment Request Type.....	1472
Viewing the Payment Request Type Details.....	1472
Payment Request (Used for Searching).....	1473
Search Payment Request.....	1473
Searching for a Payment Request.....	1476
Viewing the Payment Request Details.....	1477
Payment Request (Used for Viewing).....	1477
Payment Request - Main.....	1478
Payment Request.....	1478
Payment Details.....	1483
Payment Distribution.....	1484
Payment Request - Log.....	1486
Payment Request Log.....	1486
Creating a Payment Creation Request.....	1487
Defining a Characteristic for a Payment Tender.....	1494
Editing the Payment Amount.....	1495
Editing a Payment Creation Request.....	1497
Deleting a Payment Creation or Transfer Request.....	1502
Distributing the Tender or Payment Amount.....	1503

Distributing and Freezing the Tender or Payment Amount.....	1504
Redistributing the Tender or Payment Amount.....	1505
Editing the Payment Segment Amount.....	1506
Freezing Payments Created Through a Payment Request.....	1507
Submitting a Payment Creation or Transfer Request for Approval.....	1508
Approving a Payment Creation or Transfer Request.....	1509
Rejecting a Payment Creation or Transfer Request.....	1510
Discarding a Payment Creation or Transfer Request.....	1512
Viewing the Log of a Payment Creation or Transfer Request.....	1512
Adding a Log Entry for a Payment Creation or Transfer Request.....	1513
Payment Event Summary.....	1514
Search Payment Event.....	1514
Payments.....	1517
Payment Segments.....	1519
Searching for a Payment Event.....	1519
Creating a Payment Transfer Request.....	1520
Editing a Payment Transfer Request.....	1524
Cancelling a Payment Tender.....	1527
Deleting a Payment Event.....	1528
Viewing Payments Created Through a Payment Event.....	1529
Cancelling a Payment.....	1529
Deleting a Payment.....	1530
Creating a Refund Request for a Payment.....	1530
Viewing the Payment Segments of a Payment.....	1531
Updating the Transfer Amount in a Payment Transfer Request.....	1531
Updating the Tender Details in a Payment Transfer Request.....	1532

Chapter 22: Account Receivable Central..... 1535

Single Offset.....	1536
Mass Offset.....	1536
Cross Currency Offset.....	1537
Hold.....	1537
Refund.....	1538
Write Off.....	1538
Dispute.....	1538
Account Receivable Central.....	1538
Search Bill	1538
Bill Information.....	1542
Offset Details.....	1542
Hold Details.....	1542
Garnishment Details.....	1542
Bill Line Items.....	1543
Searching for a Bill.....	1543
Viewing the Bill Details.....	1544

Chapter 23: Offset Request..... 1545

Single Offset.....	1547
Mass Offset.....	1548
Cross Currency Offset.....	1551
Prerequisites.....	1553
Offset Request (Without Approval) Status Transition.....	1554
Offset Request (With Approval) Status Transition.....	1555
Bill Line Items Level Offset.....	1557
Internal Offsetting of Zero Balance Bill.....	1558

Algorithms Used in C1-OffsetRequest.....	1558
C1-OFFST-INF.....	1559
F1-TODOCOMPL.....	1559
C1-OFFSUBENT.....	1559
C1-OFFAPPENT.....	1560
C1-OFFAPPEXT.....	1560
C1-OFSAPRENT.....	1560
F1-AT-RQJ.....	1560
C1-OFST-DIST.....	1560
C1-UPD-HOLD.....	1561
C1-UPD-FUND.....	1562
C1-DFRUNAPLY.....	1562
C1-UNAPOFST.....	1562
C1-UPDT-FUND.....	1562
C1-WTBS-CRBL.....	1562
Additional Algorithms Used in Offset Request.....	1562
C1-OFST-AMT.....	1563
C1-WTBS-CRBL.....	1563
Offset Request Type.....	1563
Offset Request Type List.....	1564
Offset Request Type.....	1564
Defining an Offset Request Type.....	1567
Defining a Characteristic for an Offset Request Type.....	1571
Editing an Offset Request Type.....	1572
Deleting an Offset Request Type.....	1577
Copying an Offset Request Type.....	1577
Viewing the Offset Request Type Details.....	1582
Offset Request (Used for Searching).....	1583
Search Offset Request.....	1583
Searching for an Offset Request.....	1586
Creating an Offset Request.....	1587
Viewing the Offset Request Details.....	1589
Offset Request (Used for Viewing).....	1589
Offset Request - Main.....	1590
Offset Request.....	1590
Selected Bills.....	1592
Search Bill.....	1594
Offset Request Adjustments.....	1598
Offset Request - Log.....	1599
Offset Request Log.....	1599
Viewing the Debit and Credit Bills Added to an Offset Request.....	1599
Viewing the Adjustments Created Through an Offset Request.....	1600
Adding a Debit or Credit Bill to an Offset Request.....	1600
Editing an Offset Request.....	1601
Defining a Characteristic for an Offset Request.....	1603
Editing the Offset Amount of a Debit or Credit Bill.....	1604
Removing a Debit or Credit Bill from an Offset Request.....	1606
Deleting an Offset Request.....	1606
Submitting an Offset Request.....	1607
Approving an Offset Request.....	1608
Rejecting an Offset Request.....	1611
Unapplying an Offset Request.....	1612
Viewing the Log of an Offset Request.....	1613
Adding a Log Entry for an Offset Request.....	1614

Chapter 24: Funding Request..... 1615

Prerequisites.....	1618
Funding Request (Without Approval) Status Transition.....	1618
Funding Request (With Approval) Status Transition.....	1619
Algorithms Used in C1-FundingReq.....	1620
C1-FUNDINFO.....	1621
C1-FUNDSUBMT.....	1621
C1-FUNDAPP.....	1622
C1-FUNDAPRVD.....	1622
F1-TODOCOMPL.....	1622
F1-AT-RQJ.....	1622
C1-FNDRESUBM.....	1623
C1-FUNDVAL.....	1623
C1-FUNDAPAY.....	1623
C1-FUNDADJCR.....	1623
C1-FUNDCANCL.....	1624
Funding Request Type.....	1624
Funding Request Type List.....	1624
Funding Request Type.....	1625
Defining a Funding Request Type.....	1628
Defining a Characteristic for a Funding Request Type.....	1635
Editing a Funding Request Type.....	1636
Deleting a Funding Request Type.....	1643
Copying a Funding Request Type.....	1643
Viewing the Funding Request Type Details.....	1650
Funding Request (Used for Searching).....	1650
Search Funding Request.....	1651
Searching for a Funding Request.....	1653
Creating a Funding Request.....	1654
Viewing the Funding Request Details.....	1655
Funding Request (Used for Viewing).....	1655
Funding Request - Main.....	1656
Funding Request.....	1656
Search Bill.....	1659
Funding Request - Bills.....	1663
Currency Statistics.....	1663
Selected Bills.....	1664
Funding Payment Details.....	1667
Funding Adjustments.....	1667
Funding Request - Log.....	1667
Funding Request Log.....	1667
Adding a Debit or Credit Bill to a Funding Request.....	1668
Deleting a Debit or Credit Bill from a Funding Request.....	1669
Excluding a Bill from a Funding Request.....	1669
Editing a Funding Request.....	1671
Defining a Characteristic for a Funding Request.....	1673
Deleting a Funding Request.....	1674
Cancelling a Funding Request.....	1675
Submitting a Funding Request.....	1675
Approving a Funding Request.....	1677
Rejecting a Funding Request.....	1679
Requesting to Resubmit a Funding Request.....	1681
Withdrawing a Funding Request.....	1682
Transferring the Funding Amount of a Credit Bill to a Garnishment Contract.....	1683

Viewing the Garnishment Details of a Credit Bill.....	1684
Viewing the Payments Created Through a Funding Request.....	1685
Viewing the Adjustments Created Through a Funding Request.....	1686
Viewing the Log of a Funding Request.....	1686
Adding a Log Entry for a Funding Request.....	1687

Chapter 25: Hold Request..... 1689

Hold Request (Without Approval) Status Transition.....	1691
Hold Request (With Approval) Status Transition.....	1691
Algorithms Used in C1-HoldRequest.....	1692
Prerequisites.....	1697
Approval Process for Hold Request Release.....	1697
Hold Refund.....	1698
Hold Mass Accounts Using Selection Criteria.....	1699
Hold Request Type.....	1700
Hold Request Type List.....	1700
Hold Request Type.....	1700
Defining a Hold Request Type.....	1703
Defining a Characteristic for a Hold Request Type.....	1705
Editing a Hold Request Type.....	1706
Deleting a Hold Request Type.....	1709
Copying a Hold Request Type.....	1709
Viewing the Hold Request Type Details.....	1712
Hold Request (Used for Searching).....	1713
Search Hold Request.....	1713
Searching for a Hold Request.....	1716
Creating a Hold Request.....	1717
Viewing the Hold Request Details.....	1719
Hold Request (Used for Viewing).....	1720
Hold Request - Main.....	1721
Hold Request.....	1721
Hold Entities.....	1723
Search Account.....	1725
Search Bill.....	1729
Search Person.....	1731
Hold Request - Log.....	1733
Hold Request Log.....	1733
Searching Persons.....	1733
Searching Accounts.....	1734
Searching Bills.....	1734
Adding Persons in a Hold Request.....	1735
Adding Accounts in a Hold Request.....	1735
Adding Bills in a Hold Request.....	1736
Defining an Entity for a Hold Request.....	1737
Defining a Process for a Hold Request.....	1738
Defining a Characteristic for a Hold Request.....	1739
Editing a Hold Request.....	1740
Editing Hold Request Entities.....	1742
Deleting Hold Request Entities.....	1744
Deleting a Hold Request.....	1744
Submitting a Hold Request.....	1745
Approving a Hold Request.....	1746
Releasing a Hold Request.....	1747
Rejecting a Hold Request.....	1748
Resubmitting a Hold Request.....	1750

Viewing the Log of a Hold Request.....	1750
Adding a Log Entry for a Hold Request.....	1751

Chapter 26: Delinquency Central..... 1753

Prerequisites.....	1754
Delinquency Central (Used for Viewing).....	1754
Search Overdue Process.....	1754
Overdue Events.....	1759
Searching for an Overdue Process.....	1759
Viewing Events of an Overdue Process.....	1760
Viewing the Overdue Process Details.....	1760
Overdue Process Information for Account: {Account ID}.....	1761
Person Information.....	1761
Account Information.....	1762
Customer Contact Details.....	1762
Promise To Pay.....	1762
Hold Details.....	1763
Overdue Bills.....	1763
Payment Arrangement.....	1763
Search Bill.....	1764
Searching for a Bill.....	1765
Adding the Customer Contact Details.....	1765
Creating a Hold Request for an Overdue Process.....	1766
Creating a Payment Arrangement for an Overdue Process.....	1767
Defining a Promise To Pay for an Overdue Process.....	1767

Chapter 27: Upload Request..... 1769

Prerequisites.....	1772
Upload Request (Without Approval) Status Transition.....	1773
Upload Request (With Approval) Status Transition.....	1774
Defer Upload Request Validation.....	1775
Algorithms Used in C1-BillCycleUpdateUplReq.....	1776
Algorithms Used in C1-ContractRiderUpdateUplReq.....	1781
Algorithms Used in C1-HoldUploadRequest.....	1785
Algorithms Used in C1-RefundUploadRequest.....	1790
Algorithms Used in C1-WriteOffUploadRequest.....	1794
Algorithms Used in C1-BillableChargeUploadRequest.....	1797
Algorithms Used in C1-ReinstatementUploadRequest.....	1801
Algorithms Used in C1-BillGrpSortUploadRequest.....	1805
C1-BLSRTUPLD.....	1806
C1-BLSRTDERV.....	1806
C1-BLSRTVALD.....	1806
FI-AT-RQJ.....	1807
C1-UPLSUBENT.....	1807
C1-DEFERUPLD.....	1807
C1-UPLAPPENT.....	1807
C1-UPLAPPEXT.....	1808
FI-TODOCOMPL.....	1808
C1-BLSRTPROC.....	1808
Algorithms Used in C1-BillLevelUploadRequest.....	1808
C1-BLVUPLDTL.....	1809
C1-BLVLDERIV.....	1809
C1-BLVLVALID.....	1809
FI-AT-RQJ.....	1810

C1-UPLSUBENT.....	1810
C1-DEFERUPLD.....	1810
C1-UPLAPPENT.....	1810
C1-UPLAPPEXT.....	1811
F1-TODOCOMPL.....	1811
C1-BLVVLVPRO.....	1811
CSV File Format for Account Bill Cycle Upload Request.....	1811
CSV File Format for Contract Rider Upload Request.....	1812
CSV File Format for Billable Charge Upload.....	1813
CSV File Format for Hold Upload Request.....	1816
CSV File Format for Refund Request Upload.....	1820
CSV File Format for Write Off Request Upload.....	1821
CSV File Format for Reinstatement Upload Request.....	1822
CSV File Format for Bill Group Sorting Upload Request.....	1823
CSV File Format for Bill Group Derivation and Pricing Parameters Upload Request.....	1824
Upload Request Type.....	1825
Upload Request Type List.....	1827
Upload Request Type.....	1828
Defining an Upload Request Type.....	1831
Defining a Characteristic for an Upload Request Type.....	1836
Editing an Upload Request Type.....	1837
Deleting an Upload Request Type.....	1840
Copying an Upload Request Type.....	1841
Mapping an Upload Request Type.....	1845
Viewing the Upload Request Type Details.....	1846
Upload Request (Used for Searching).....	1847
Search Upload Request.....	1847
Searching for an Upload Request.....	1848
Viewing the Upload Request Details.....	1849
Creating an Upload Request.....	1850
Defining a Characteristic for an Upload Request.....	1852
Upload Request (Used for Viewing).....	1853
Upload Request - Main.....	1853
Upload Request.....	1854
Data Records.....	1856
Upload Request - Log.....	1857
Upload Request Log.....	1857
Editing an Upload Request.....	1858
Deleting an Upload Request.....	1859
Validating an Upload Request.....	1860
Cancelling an Upload Request.....	1860
Submitting an Upload Request.....	1861
Approving an Upload Request.....	1864
Rejecting an Upload Request.....	1867
Viewing the Data Record Details.....	1869
Viewing the Log of an Upload Request.....	1869
Adding a Log Entry for an Upload Request.....	1870

Chapter 28: General Ledger (GL) Accounting Template..... 1873

GL Accounting Template (Without Approval) Status Transition.....	1878
GL Accounting Template (With Approval) Status Transition.....	1878
Algorithms Used in C1- GLAT.....	1879
Prerequisites.....	1881
GL Accounting Template (Used for Searching).....	1881
Search GL Accounting Template.....	1882

GL Accounting Template Lines.....	1883
Searching for a GL Accounting Template.....	1883
Creating a GL Accounting Template.....	1884
Viewing the GL Accounting Template Details.....	1886
Viewing the GL Accounting Template Lines Details.....	1887
GL Accounting Template (Used for Viewing).....	1887
GL Accounting Template - Main.....	1887
GL Accounting Template.....	1887
GL Accounting Template - Log.....	1889
GL Accounting Template Log.....	1889
Editing a GL Accounting Template.....	1890
Deleting a GL Accounting Template.....	1891
Submitting a GL Accounting Template.....	1892
Approving a GL Accounting Template.....	1893
Rejecting a GL Accounting Template.....	1894
Deactivating a GL Accounting Template.....	1896
Viewing the Log of a GL Accounting Template.....	1897
Adding a Log Entry for a GL Accounting Template.....	1897

Chapter 29: Accrual..... 1899

Accrual Created through UI (Without Approval) Status Transition.....	1901
Accrual Created through UI (With Approval) Status Transition.....	1901
Accrual Created through Batch (Without Approval) Status Transition.....	1902
Accrual Created through Batch (With Approval) Status Transition.....	1903
Accrual Processes.....	1904
Account's Eligibility Check for Accrual.....	1904
Accrual Calculation.....	1905
Calculate Accrual at the Bill Level Based on Historical Data.....	1905
Calculate Accrual at the Price Item Level Based on Historical Data.....	1905
Calculate Accrual at the Bill Level Based on Actual Data.....	1906
Calculate Accrual at the Price Item Level Based on Actual Data.....	1906
Accrual Creation.....	1906
Accrual Reversal.....	1906
Accrual Cycle (Used for Searching).....	1907
Search Accrual Cycle.....	1907
Searching for an Accrual Cycle.....	1907
Viewing the Accrual Cycle Details.....	1908
Defining an Accrual Cycle.....	1908
Adding a Schedule Period in an Accrual Cycle.....	1909
Accrual Cycle (Used for Viewing).....	1910
Accrual Cycle.....	1910
Editing an Accrual Cycle.....	1911
Deleting an Accrual Cycle.....	1912
Accrual Type (Used for Searching).....	1913
Search Accrual Type.....	1913
Searching for an Accrual Type.....	1914
Viewing the Accrual Type Details.....	1915
Defining an Accrual Type.....	1915
Associating an Algorithm with an Accrual Type.....	1921
Excluding an Entity from an Accrual Type.....	1923
Associating a Division with an Accrual Type.....	1924
Accrual Type (Used for Viewing).....	1925
Accrual Type.....	1925
Editing an Accrual Type.....	1929
Deleting an Accrual Type.....	1935

Accrual (Used for Searching).....	1936
Search Accrual.....	1936
Searching for an Accrual.....	1938
Viewing the Accrual Details.....	1939
Defining an Accrual.....	1939
Defining a Characteristic for an Accrual.....	1943
Adding the Details for an Accrual.....	1944
Accrual (Used for Viewing).....	1944
Accrual - Main.....	1945
Accrual.....	1945
Accrual Details.....	1948
Accrual Calculation Lines.....	1949
Accrual - Log.....	1949
Accrual Log.....	1949
Viewing the Log of an Accrual.....	1950
Adding a Log Entry for an Accrual.....	1950
Approving an Accrual.....	1951
Rejecting an Accrual.....	1952
Resubmitting an Accrual.....	1952
Editing an Accrual.....	1953
Deleting an Accrual.....	1955

Chapter 30: Payment Agreement Request..... 1957

Payment Agreement Request (Without Approval) Status Transition.....	1960
Payment Agreement Request (With Approval) Status Transition.....	1960
Prerequisites.....	1961
Algorithms Used in C1-PaymentAgreementRequest.....	1962
C1-PA-INFO.....	1962
C1-PA-PRE.....	1963
C1-PA-SUBMIT.....	1963
C1-PA-APPENT.....	1963
C1-PA-APPEXT.....	1963
C1-PA-RESUB.....	1963
C1-MONTR.....	1963
C1-ACTENT.....	1963
Payment Agreement Request Type.....	1963
Payment Agreement Request Type List.....	1963
Payment Agreement Request Type.....	1964
Defining a Payment Agreement Request Type.....	1967
Defining a Characteristic for a Payment Agreement Request Type.....	1969
Editing a Payment Agreement Request Type.....	1970
Copying a Payment Agreement Request Type.....	1973
Deleting a Payment Agreement Request Type.....	1975
Viewing the Payment Agreement Request Type Details.....	1976
Payment Agreement Request (Used for Searching).....	1976
Search Payment Agreement Request.....	1976
Bill Details.....	1980
Searching for a Payment Agreement Request.....	1980
Creating a Payment Agreement Request.....	1981
Defining a Characteristic for a Payment Agreement Request.....	1982
Defining Payment Schedule for a Payment Agreement Request.....	1983
Viewing the Bills Added in the Payment Agreement Request.....	1984
Viewing the Payment Agreement Request Details.....	1984
Payment Agreement Request (Used for Viewing).....	1985
Payment Agreement Request - Main.....	1986

Payment Agreement Request.....	1986
Bill Details.....	1988
Payment Schedule.....	1989
Payment Agreement Request - Bills.....	1989
Search Bills.....	1989
Payment Agreement Request - Log.....	1990
Payment Agreement Request Log.....	1990
Editing a Payment Agreement Request.....	1991
Deleting a Payment Agreement Request.....	1993
Submitting a Payment Agreement Request.....	1994
Removing an Overdue Bill from a Payment Agreement Request.....	1995
Approving a Payment Agreement Request.....	1996
Rejecting a Payment Agreement Request.....	1997
Resubmitting a Payment Agreement Request.....	1999
Filtering Overdue Bills of an Account.....	1999
Adding an Overdue Bill in a Payment Agreement Request.....	2000
Viewing the Log of a Payment Agreement Request.....	2001
Adding a Log Entry for a Payment Agreement Request.....	2002

Chapter 31: Dispute Request.....2005

Dispute Request (Without Approval) Status Transition.....	2011
Dispute Request (With Approval) Status Transition.....	2011
Prerequisites.....	2012
Algorithms Used in C1-DisputeRequest.....	2013
Dispute Request Type.....	2017
Dispute Request Type List.....	2021
Dispute Request Type.....	2021
Defining a Dispute Request Type.....	2024
Defining a Characteristic for a Dispute Request Type.....	2026
Editing a Dispute Request Type.....	2027
Deleting a Dispute Request Type.....	2030
Copying a Dispute Request Type.....	2031
Viewing the Dispute Request Type Details.....	2033
Dispute Request (Used for Searching).....	2034
Search Dispute Request.....	2034
Searching for a Dispute Request.....	2037
Viewing the Dispute Request Details.....	2038
Creating a Dispute Request.....	2039
Defining a Characteristic for a Dispute Request.....	2041
Dispute Request (Used for Viewing).....	2042
Dispute Request - Main.....	2043
Dispute Request.....	2043
Dispute Details.....	2045
Dispute Adjustments.....	2045
Previous Dispute Requests.....	2046
Dispute Request - Bills.....	2047
Search Bills.....	2047
Bill Line Items.....	2048
Dispute Request - Log.....	2049
Dispute Request Log.....	2049
Editing a Dispute Request.....	2050
Deleting a Dispute Request.....	2051
Submitting a Dispute Request.....	2052
Approving a Dispute Request.....	2053
Rejecting a Dispute Request.....	2054

Resubmitting a Dispute Request.....	2056
Editing the Dispute Details.....	2056
Deleting a Bill from the Dispute Request.....	2058
Viewing the Bill Line Items.....	2058
Adding a Bill to the Dispute Request.....	2059
Adding a Bill Line Item to the Dispute Request.....	2060
Viewing the Log of a Dispute Request.....	2062
Adding a Log Entry for a Dispute Request.....	2063

Chapter 32: Earnings Credit Rate2065

Prerequisites.....	2069
Financial Transaction Distribution Object Status Transition.....	2069
Algorithms Used in C1-FTDIST.....	2070
Earnings Credit Rate Eligibility.....	2074
Earnings Credit Rate Eligibility.....	2075
Defining Earnings Credit Rate Eligibility for an Account.....	2076
Financial Transaction Distribution Type.....	2077
Financial Transaction Distribution Type List.....	2077
Financial Transaction Distribution Type.....	2078
Defining a Financial Transaction Distribution Type.....	2081
Defining a Characteristic for a Financial Transaction Distribution Type.....	2084
Editing a Financial Transaction Distribution Type.....	2085
Deleting a Financial Transaction Distribution Type.....	2087
Copying a Financial Transaction Distribution Type.....	2088
Viewing the Financial Transaction Distribution Type Details.....	2091
Financial Transaction Distribution Rule.....	2091
Financial Transaction Distribution Rule List.....	2092
Financial Transaction Distribution Rule.....	2093
Financial Transaction Distribution Rule Version List.....	2094
Financial Transaction Distribution Rule Version.....	2095
Defining a Financial Transaction Distribution Rule.....	2097
Editing a Financial Transaction Distribution Rule.....	2098
Deleting a Financial Transaction Distribution Rule.....	2099
Copying a Financial Transaction Distribution Rule.....	2100
Viewing the Financial Transaction Distribution Rule Details.....	2101
Viewing the Financial Transaction Distribution Rule Version List.....	2102
Defining a Financial Transaction Distribution Rule Version.....	2102
Including Objects in a Financial Transaction Distribution Rule Version.....	2105
Excluding Objects in a Financial Transaction Distribution Rule Version.....	2106
Associating Algorithms with a Financial Transaction Distribution Rule Version.....	2107
Editing a Financial Transaction Distribution Rule Version.....	2108
Deleting a Financial Transaction Distribution Rule Version.....	2111
Copying a Financial Transaction Distribution Rule Version.....	2111
Viewing the Financial Transaction Distribution Rule Version Details.....	2114
Expiration Cycle Extendable Lookup.....	2115
Extendable Lookup Search.....	2115
Searching for an Expiration Cycle Extendable Lookup.....	2116
Extendable Lookup (Expiration Cycle).....	2117
Extendable Lookup Value List.....	2117
Extendable Lookup Value.....	2118
Defining an Expiration Cycle.....	2119
Editing an Expiration Cycle.....	2120
Deleting an Expiration Cycle.....	2121
Copying an Expiration Cycle.....	2122
Viewing the Expiration Cycle Details.....	2123

Distribution Hierarchy Extendable Lookup.....	2124
Extendable Lookup Search.....	2124
Searching for a Distribution Hierarchy Extendable Lookup.....	2124
Extendable Lookup (Distribution Hierarchy).....	2125
Extendable Lookup Value List.....	2125
Extendable Lookup Value.....	2126
Defining a Distribution Hierarchy.....	2127
Editing a Distribution Hierarchy.....	2129
Deleting a Distribution Hierarchy.....	2130
Copying a Distribution Hierarchy.....	2130
Viewing the Distribution Hierarchy Details.....	2132
Financial Transaction Distribution Object Extendable Lookup.....	2133
Extendable Lookup Search.....	2133
Extendable Lookup (Financial Transaction Distribution Object).....	2134
Extendable Lookup Value List.....	2134
Extendable Lookup Value.....	2135
Defining a Financial Transaction Distribution Object.....	2136
Editing a Financial Transaction Distribution Object.....	2137
Deleting a Financial Transaction Distribution Object.....	2139
Copying a Financial Transaction Distribution Object.....	2139
Viewing the Financial Transaction Distribution Object Details.....	2141
Financial Transaction Distribution (Used for Searching).....	2142
Financial Transaction Distribution Search.....	2142
Searching for a Financial Transaction Distribution Object.....	2144
Viewing the Financial Transaction Distribution Details.....	2144
Financial Transaction Distribution (Used for Viewing).....	2145
Financial Transaction Distribution - Main.....	2145
Financial Transaction Distribution.....	2145
Financial Transaction Distribution - Log.....	2147
Financial Transaction Distribution Log.....	2147
Viewing the Log of a Financial Transaction Distribution.....	2148
Adding a Log Entry for a Financial Transaction Distribution.....	2149

Chapter 33: Deferred Revenue Recognition..... 2151

Prerequisites.....	2153
Deferred Revenue Recognition Status Transition.....	2153
Algorithms Used in Deferred Revenue Recognition.....	2155
Deferred Revenue Recognition Template (Used for Searching).....	2159
Search Deferred Revenue Recognition Template.....	2159
Searching for a Deferred Revenue Recognition Template.....	2160
Defining a Deferred Revenue Recognition Template.....	2161
Associating Algorithms with a Deferred Revenue Recognition Template.....	2163
Associating Deferred Revenue Recognition Template With A Division.....	2164
Defining a Characteristic for a Deferred Revenue Recognition Template.....	2165
Viewing the Deferred Revenue Recognition Template Details.....	2166
Deferred Revenue Recognition Template (Used for Viewing).....	2167
Deferred Revenue Recognition Template.....	2167
Editing a Deferred Revenue Recognition Template.....	2169
Deleting a Deferred Revenue Recognition Template.....	2170
Viewing the Deferred Revenue Recognition Template Details.....	2170
Deferred Revenue Recognition (Used for Searching).....	2171
Search Deferred Revenue Recognition.....	2171
Searching for a Deferred Revenue Recognition.....	2175
Viewing the Deferred Revenue Recognition Details.....	2176
Deferred Revenue Recognition (Used for Viewing).....	2176

Deferred Revenue Recognition - Main.....	2176
Deferred Revenue Recognition.....	2177
Associated Deferred Revenue Recognitions.....	2178
Recognition Schedule.....	2179
Revenue Recognition Items.....	2179
Deferred Revenue Recognition - Log.....	2180
Deferred Revenue Recognition Log.....	2180
Editing a Deferred Revenue Recognition.....	2180
Creating the Deferred Revenue Recognition Schedule.....	2181
Defining a Characteristic for a Deferred Revenue Recognition.....	2182
Adding Related Deferred Revenue Recognitions.....	2183
Editing the Deferred Revenue Recognition Schedule Details.....	2183
Viewing the Log of a Deferred Revenue Recognition.....	2185
Adding a Log Entry for a Deferred Revenue Recognition.....	2185

Chapter 34: Product Lifecycle Management..... 2187

Prerequisites.....	2189
Product Status Transition through User Interface.....	2189
Product Status Transition through a Batch Process.....	2190
Product Version Status Transition.....	2191
Product Enrollment Status Transition through User Interface.....	2192
Product Enrollment Status Transition through a Batch Process.....	2194
Product Service (Used for Searching).....	2195
Search Product Service.....	2195
Associated Price Items.....	2196
Searching for a Product Service.....	2196
Viewing the Product Service Price Items.....	2197
Defining a Product Service.....	2197
Associating a Product Service with a Price Item.....	2199
Defining a Characteristics for a Product Service.....	2200
Viewing the Product Service Details.....	2201
Product Service (Used for Viewing).....	2202
Product Service.....	2202
Price Items.....	2203
Editing a Product Service.....	2203
Deleting a Product Service.....	2204
Copying a Product Service.....	2205
Product (Used for Searching).....	2206
Search Product.....	2206
Product Version List.....	2208
Searching for a Product.....	2208
Viewing the Product Versions.....	2209
Viewing the Product Details.....	2209
Viewing the Product Version Details.....	2210
Defining a Product.....	2210
Associating a Product with a Division.....	2211
Defining a Product to Product Relationship.....	2212
Defining a Characteristics for a Product.....	2213
Defining a Product Version.....	2215
Adding a Product Service to a Product Version.....	2217
Adding a Standard Product to a Product Version.....	2218
Adding Add-on Services to a Product Version.....	2219
Associating a Price List with a Product Version.....	2220
Defining Eligibility Criteria for a Product Version.....	2221
Defining a Characteristic for a Product Version.....	2224

Product Version (Used for Viewing).....	2225
Product Version - Main.....	2226
Product Version.....	2226
Products.....	2227
Product Services.....	2228
Add-on Product Services.....	2228
Services.....	2229
Price List.....	2229
Eligibility Criteria.....	2230
Product Version - Log.....	2232
Product Version Log.....	2232
Editing a Product Version.....	2232
Deleting a Product Version.....	2233
Copying a Product Version.....	2234
Finalizing a Product Version.....	2236
Viewing the Log of a Product Version.....	2237
Product (Used for Viewing).....	2237
Product - Main.....	2238
Product Details.....	2238
Product Version List.....	2239
Product - Log.....	2240
Product Log.....	2240
Editing a Product.....	2240
Copying a Product.....	2241
Activating a Product.....	2242
Retiring a Product.....	2243
Viewing the Log of a Product.....	2243
Product Enrollment (Used for Searching).....	2244
Search Enrollment.....	2244
Enrolled Products.....	2246
Enrolled Services.....	2247
Enrolled Standard Products.....	2247
Enrolled Add-on Services.....	2248
Searching for a Product Enrollment.....	2248
Viewing the Enrolled Products.....	2249
Viewing the Enrolled Services.....	2249
Viewing the Standard Products Included in an Enrolled Product.....	2250
Viewing the Add-on Services Enrolled with the Product	2251
Enrolling an Account for One or More Products and Services.....	2251
Viewing the Product Priority of an Account.....	2254
Defining a Characteristic for a Product Enrollment.....	2255
Product Enrollment (Used for Viewing).....	2255
Product Enrollment - Main.....	2256
Product Enrollment.....	2256
Enrolled Products.....	2257
Enrolled Services.....	2258
Enrolled Standard Products.....	2258
Enrolled Add-on Product Services.....	2259
Product Priority.....	2260
Product Enrollment - Log.....	2260
Enrollment Log.....	2260
Viewing the Standard Products Included in an Enrolled Product.....	2261
Editing a Product Enrollment.....	2261
Copying a Product Enrollment.....	2262
Enrolling a Product Enrollment.....	2263
Unenrolling a Product Enrollment.....	2263

Viewing the Log of a Product Enrollment.....	2264
--	------

Chapter 35: Subscription Billing.....2267

Prerequisites.....	2269
Subscription Type (Used for Searching).....	2269
Search Subscription Type.....	2269
Searching for a Subscription Type.....	2270
Viewing the Subscription Type Details.....	2271
Defining a Subscription Type.....	2271
Defining a Characteristic for a Subscription Type.....	2274
Subscription Type (Used for Viewing).....	2275
Subscription Type.....	2275
Editing a Subscription Type.....	2278
Copying a Subscription Type.....	2280
Deleting a Subscription Type.....	2282
Account Subscription (Used for Searching).....	2283
Search Account Subscription.....	2283
Searching for an Account Subscription.....	2284
Viewing the Account Subscription Details.....	2285
Defining an Account Subscription.....	2286
Defining a Characteristic for an Account Subscription.....	2288
Account Subscription (Used for Viewing).....	2289
Account Subscription - Main.....	2290
Account Subscription.....	2290
Subscription Services.....	2292
Subscription Service Charges.....	2292
Subscription Service Charge Entities.....	2293
Account Subscription Suspension History.....	2293
Account Subscription Termination Charges.....	2293
Account Subscription - Log.....	2293
Account Subscription Log.....	2294
Adding Services and Charges in the Account Subscription.....	2294
Editing an Account Subscription.....	2296
Deleting an Account Subscription.....	2297
Activating an Account Subscription.....	2297
Canceling an Account Subscription.....	2298
Editing the Subscription Service Details.....	2298
Deleting a Service from the Account Subscription.....	2299
Viewing the Charges of a Subscription Service.....	2300
Viewing Related Entities of a Subscription Service Charge.....	2300
Viewing Suspension History of the Account Subscription.....	2301
Viewing Termination Charges of the Account Subscription.....	2301
Suspending an Account Subscription.....	2302
Terminating an Account Subscription.....	2303
Resuming an Account Subscription.....	2304
Viewing the Log of an Account Subscription.....	2304

Chapter 36: Mass Pricing Update.....2307

Prerequisites.....	2309
Mass Pricing Update Request (Without Approval) Status Transition.....	2309
Mass Pricing Update Request (With Approval) Status Transition.....	2310
Algorithms Used in C1-MassPricingReq.....	2311
C1-REQST-INF.....	2312
C1-MPRIVALDN.....	2312

C1-MPRISUBMT.....	2312
C1-MPRIAPTD.....	2313
F1-TODOCOMPL.....	2313
F1-AT-RQJ.....	2313
C1-MPRIDEFER.....	2313
C1-MPRIAPRD.....	2313
C1-MPRIUPDPA.....	2313
C1-MPRIRJTD.....	2314
Request Type.....	2314
Request Type List.....	2314
Request Type.....	2315
Defining a Mass Pricing Update Request Type.....	2317
Editing a Mass Pricing Update Request Type.....	2320
Copying a Mass Pricing Update Request Type.....	2323
Deleting a Mass Pricing Update Request Type.....	2326
Viewing the Mass Pricing Update Request Type Details.....	2327
Mass Pricing Update Request (Used for Searching).....	2327
Search Mass Pricing Update Request.....	2328
Searching for a Mass Pricing Update Request.....	2329
Viewing the Mass Pricing Update Request Type Details.....	2330
Creating a Mass Pricing Update Request.....	2330
Mass Pricing Update Request (Used for Viewing).....	2334
Mass Pricing Update Request - Main.....	2334
Mass Pricing Update Request.....	2335
Price Assignments.....	2337
Mass Pricing Update Request - Log.....	2337
Mass Pricing Update Request Log.....	2338
Creating a Mass Pricing Update Request.....	2338
Editing a Mass Pricing Update Request.....	2342
Deleting a Mass Pricing Update Request.....	2344
Submitting a Mass Pricing Update Request.....	2344
Generating a Batch Job for a Mass Pricing Update Request.....	2345
Approving a Mass Pricing Update Request.....	2346
Rejecting a Mass Pricing Update Request.....	2347
Viewing the Log of a Mass Pricing Update Request.....	2348
Adding a Log Entry for a Mass Pricing Update Request.....	2348
Mass Pricing Update Request.....	2349
Search Price Assignments.....	2350
Account Agreed Price Assignments.....	2352
Customer Agreed Price Assignments.....	2353
Price List Price Assignments.....	2353
Product Price List Price Assignments.....	2354
Searching for Price Assignments on a Pricing Entity.....	2355
Viewing the Price Assignments Defined at the Account Level.....	2356
Viewing the Price Assignments Defined at the Person Level.....	2356
Viewing the Price Assignments Defined on the Price Lists.....	2356
Viewing the Price Assignments Defined on the Price Lists Associated to the Products.....	2357

Chapter 37: Price Item, Parameter, and SQI Upload.....2359

Uploading a Price Item File in the XML Format.....	2361
Defining a File Request Type for Uploading Price Items in the XML Format.....	2361
Uploading a Price Item File.....	2361
Creating or Updating Price Items.....	2362
Uploading a Price Item File in the CSV Format.....	2362
Defining a File Request Type for Uploading Price Items in the CSV Format.....	2362

Uploading a Price Item File.....	2363
Creating or Updating Price Items.....	2363
C1-PRCITM-PR.....	2363
C1-PRICEUPL.....	2364
XML File Format for Uploading Price Items.....	2364
Sample XML Format for Uploading Price Items.....	2373
CSV File Format for Uploading Price Items.....	2379
Sample CSV Format for Uploading Price Items.....	2385
Uploading a Parameter File in the XML Format.....	2397
Defining a File Request Type for Uploading Parameters in the XML Format.....	2397
Uploading a Parameter File.....	2398
Creating Parameters.....	2398
Uploading a Parameter File in the CSV Format.....	2398
Defining a File Request Type for Uploading Parameters in the CSV Format.....	2398
Uploading a Parameter File.....	2400
Creating Parameters.....	2400
XML File Format for Uploading Parameters.....	2400
Sample XML Format for Uploading Parameters.....	2405
CSV File Format for Uploading Parameters.....	2408
Sample CSV Format for Uploading Parameters.....	2412
Uploading an SQI File in the XML Format.....	2418
Defining a File Request Type for Uploading SQIs in the XML Format.....	2418
Uploading an SQI File.....	2419
Creating SQIs.....	2419
Uploading an SQI File in the CSV Format.....	2419
Defining a File Request Type for Uploading SQIs in the CSV Format.....	2419
Uploading an SQI File.....	2420
Creating SQIs.....	2421
XML File Format for Uploading Service Quantity Identifiers (SQIs).....	2421
Sample XML Format for Uploading Service Quantity Identifiers (SQIs).....	2421
CSV File Format for Uploading Service Quantity Identifiers (SQIs).....	2422
Sample CSV Format for Uploading SQIs.....	2423
Uploading Price Items, Parameters, and SQIs from the Same File.....	2423

Chapter 38: Product and Product Version Upload.....2425

Chapter 39: Price List and Price Item Pricing Upload.....2427

Chapter 40: Invoice Request..... 2431

Prerequisites.....	2434
Types of Invoice Request.....	2434
Manual Regular Bill Generation Invoice Request.....	2434
Manual Trial Bill Generation Invoice Request.....	2436
Automatic Regular Bill Generation Invoice Request.....	2436
Invoice Request Manual Trial Bill Generation (Without Approval) Status Transition.....	2437
Invoice Request Manual Regular Bill Generation (Without Approval) Status Transition.....	2441
Invoice Request Manual Regular Bill Generation (With Approval) Status Transition.....	2447
Invoice Request Automatic Regular Bill Generation (Without Approval) Status Transition.....	2452
Invoice Request Type.....	2455
Invoice Request Type List.....	2455
Invoice Request Type.....	2456
Defining an Invoice Request Type.....	2459
Defining a Characteristic for an Invoice Request Type.....	2463

Editing an Invoice Request Type.....	2464
Deleting an Invoice Request Type.....	2468
Copying an Invoice Request Type.....	2469
Viewing the Invoice Request Type Details.....	2473
Invoice Request (Used for Searching).....	2474
Search Invoice Request.....	2474
Searching for an Invoice Request.....	2478
Manually Creating an Invoice Request.....	2479
Viewing the Invoice Request Details.....	2480
Invoice Request (Used for Viewing).....	2481
Invoice Request - Main.....	2481
Invoice Request.....	2481
Invoice Request Details/Account List.....	2484
Excluded Accounts.....	2485
Invoice Request - Log.....	2486
Invoice Request Log.....	2486
Editing an Invoice Request.....	2487
Defining a Characteristic for an Invoice Request.....	2488
Deleting an Invoice Request.....	2490
Canceling an Invoice Request.....	2490
Submitting an Invoice Request.....	2491
Approving an Invoice Request.....	2492
Rejecting an Invoice Request.....	2493
Requesting to Resubmit an Invoice Request.....	2495
Viewing the Log of an Invoice Request.....	2496
Adding a Log Entry for an Invoice Request.....	2497

Chapter 41: Refund/Write Off Request..... 2499

Prerequisites.....	2501
Refund Request (Without Approval) Status Transition.....	2501
Refund Request (With Approval) Status Transition.....	2502
Write Off Request (Without Approval) Status Transition.....	2503
Write Off Request (With Approval) Status Transition.....	2504
Account Level Refund/Write Off.....	2505
Refund/Write Off Adjustment at Bill Level.....	2507
Algorithms Used in C1-RefundReq.....	2508
Algorithms Used in C1-WORequest.....	2511
Refund/Write Off Request Type.....	2514
Refund/Write Off Request Type List.....	2518
Refund/Write Off Request Type.....	2518
Defining a Refund or Write Off Request Type.....	2521
Defining a Characteristic for a Refund or Write Off Request Type.....	2524
Editing a Refund or Write Off Request Type.....	2525
Copying a Refund or Write Off Request Type.....	2528
Deleting a Refund or Write Off Request Type.....	2532
Viewing the Refund or Write Off Request Type Details.....	2533
Refund/Write Off Request.....	2533
Search Refund/Write Off Request.....	2533
Searching for a Refund or Write Off Request.....	2537
Creating a Refund Request.....	2538
Creating a Write Off Request.....	2541
Viewing the Refund Request Details.....	2543
Viewing the Write Off Request Details.....	2544
Refund Request.....	2545
Refund Request - Main.....	2545

Refund Request.....	2545
Refund Details.....	2548
Bill Line Items.....	2549
Refund Request - Bills.....	2549
Search Bills.....	2550
Bill Line Items.....	2551
Refund Request - Payments.....	2552
Search Payment Event.....	2552
Payments.....	2553
Refund Request - Log.....	2554
Refund Request Log.....	2554
Creating a Refund Request.....	2554
Defining a Characteristic for a Refund Request.....	2557
Adding a Payment Event to the Refund Request.....	2558
Adding a Payment to the Refund Request.....	2559
Adding a Credit Bill to the Refund Request.....	2560
Adding a Credit Bill Line Item to the Refund Request.....	2561
Editing a Refund Request.....	2563
Editing the Refund Details.....	2565
Deleting a Refund Request.....	2567
Deleting a Bill from the Refund Request.....	2568
Deleting a Bill Line Item from the Refund Request.....	2568
Submitting a Refund Request.....	2569
Approving a Refund Request.....	2571
Rejecting a Refund Request.....	2574
Viewing the Log of a Refund Request.....	2575
Adding a Log Entry for a Refund Request.....	2576
Voiding a Refund Request.....	2577
Write Off Request.....	2578
Write Off Request - Main.....	2578
Write Off Request.....	2579
Write Off Details.....	2581
Bill Line Items.....	2582
Write Off Request - Bills.....	2582
Search Bills.....	2583
Bill Line Items.....	2584
Write Off Request - Log.....	2585
Write Off Request Log.....	2585
Creating a Write Off Request.....	2585
Defining a Characteristic for a Write Off Request.....	2588
Adding a Debit Bill to the Write Off Request.....	2589
Adding a Debit Bill Line Item to the Write Off Request.....	2590
Editing a Write Off Request.....	2591
Editing the Write Off Details.....	2593
Deleting a Write Off Request.....	2595
Deleting a Bill from the Write Off Request.....	2596
Deleting a Bill Line Item from the Write Off Request.....	2596
Submitting a Write Off Request.....	2597
Approving a Write Off Request.....	2598
Rejecting a Write Off Request.....	2600
Viewing the Log of a Write Off Request.....	2602
Adding a Log Entry for a Write Off Request.....	2603
Canceling a Write Off Request.....	2604

Chapter 42: Deal Management..... 2607

Price Item Status Transition in a Deal.....	2609
Deal Status Transition.....	2612
Deal Approval Scenarios.....	2626
Deal Approval Scenario 1.....	2627
Deal Approval Scenario 2.....	2627
Deal Approval Scenario 3.....	2628
Deal Approval Scenario 4.....	2629
Deal Approval Scenario 5.....	2631
Deal Approval Scenario 6.....	2632
Deal Approval Scenario 7.....	2634
Deal Approval Scenario 8.....	2636
Deal Approval Scenario 9.....	2638
Deal Approval Scenario 10.....	2640
Different Stages in Deal Lifecycle.....	2643
Deal Creation.....	2643
Reference Selection.....	2644
Simulation.....	2645
Price Item Approval.....	2645
Division Level Approval.....	2645
Deal Level Approval.....	2646
Deal Finalization.....	2646
Customer Acceptance or Rejection.....	2646
Apply Back or Orchestration.....	2646
Deal Monitoring.....	2646
Product Level Approval for Deals.....	2648
Recommended Pricing.....	2649
Deal Currency Conversion.....	2650
Reference Selection Based on Questionnaire.....	2651
Rate Negotiability for Price Item in Deal.....	2652
Price Item Selection during Deal Creation.....	2653
Price Item and Hierarchy Entity Selection in a Deal Based on Characteristic Value.....	2653
Seasonal Pricing for Price Items in a Deal.....	2655
Include Customer Hierarchy in a Deal.....	2656
Contracted Deal.....	2657
Deal Inactivation.....	2657
Average Price Validation Using Floor and Ceil Limits.....	2658
Considering Pass Through Charges While Calculating Original Revenue.....	2660
Considering SQI Based Billable Charges While Calculating Commitments.....	2665
Stacking Commitments in Deal.....	2671
Terms and Conditions Selection in a Deal Based on Characteristic Value.....	2672
Terms and Conditions Grouping in a Deal Based on Characteristic Value.....	2673
Overriding Terms and Conditions in a Deal.....	2674
Refreshing Terms and Conditions in a Deal.....	2674
Deal Approval Profile.....	2674
Deal Approval Profile List.....	2674
Deal Approval Profile.....	2675
Defining a Deal Approval Profile.....	2678
Defining an Approval Level in the Approval Hierarchy.....	2679
Editing a Deal Approval Profile.....	2683
Copying a Deal Approval Profile.....	2684
Deleting a Deal Approval Profile.....	2686
Viewing the Deal Approval Profile Details.....	2687
Deal Type.....	2687
Deal Type List.....	2688
Deal Type.....	2688
Deal Approval Profiles.....	2692

Customer Characteristics.....	2693
Defining a Deal Type.....	2694
Associating a Deal Approval Profile with a Deal Type.....	2698
Associating an Algorithm with a Deal Type.....	2700
Defining a Characteristic for a Deal Type.....	2703
Editing a Deal Type.....	2704
Copying a Deal Type.....	2709
Deleting a Deal Type.....	2714
Viewing the Details of a Deal Type.....	2714
Questionnaire Template (Used for Searching).....	2715
Search Questionnaire Template.....	2715
Searching for a Questionnaire Template.....	2716
Defining a Questionnaire Template.....	2717
Editing a Questionnaire Template.....	2722
Copying a Questionnaire Template.....	2726
Deleting a Questionnaire Template.....	2731
Previewing a Questionnaire Template.....	2732
Viewing the Details of a Questionnaire Template.....	2732
Questionnaire Template (Used for Viewing).....	2733
Questionnaire Template.....	2733
Questions.....	2733
Viewing the Details of a Question.....	2734
Editing a Question.....	2735
Prospect.....	2739
Prospect.....	2739
Searching for a Prospect.....	2741
Editing a Prospect Person.....	2741
Editing a Prospect Account.....	2743
Defining a Prospect Person.....	2746
Defining an Address for a Prospect Person.....	2748
Defining a Characteristic for a Prospect Person.....	2749
Associating an Identifier with a Prospect Person.....	2750
Associating a Child Person with a Prospect Person.....	2751
Defining an Account for a Prospect Person.....	2753
Defining a Characteristic for a Prospect Account.....	2754
Associating an Identifier with a Prospect Account.....	2756
Deal Dashboard.....	2757
Deal Metrics.....	2757
Deal Statistics.....	2758
Deal To Do.....	2758
Search Deal.....	2758
Deal Versions.....	2771
Deal Comparison.....	2772
Searching for a Deal.....	2773
Viewing the Versions of a Deal.....	2774
Viewing the Approval Workflow Details of a Deal.....	2774
Finalizing a Deal.....	2775
Accepting a Deal.....	2776
Rejecting a Deal.....	2777
Orchestrating a Deal.....	2778
Extracting a Deal in the PDF or Excel Format.....	2779
Reviewing a Deal.....	2785
Viewing the Profitability Details of a Deal Version.....	2786
Comparing Two Deal Versions.....	2787
Viewing the Deal Metrics in the Tiles Chart.....	2787
Viewing the Deal Count in the Bar Chart.....	2788

Viewing the Deal Revenue in the Line Chart.....	2788
Viewing Statistics of Deals in a Particular Status.....	2789
Defining a Deal.....	2790
Creating a Deal using a Deal Template.....	2796
Deal Compare.....	2798
Comparing Cost, Revenue, and Profitability of Two Deal Versions.....	2801
Comparing Revenue from a Price Item or Hierarchy Entity in Two Deal Versions.....	2801
Comparing Average Price of a Price Item in Two Deal Versions.....	2802
Deal Profitability Report.....	2803
Deal Profitability.....	2804
Search Profitability Report.....	2804
Division Level Profitability.....	2808
Price Item Level Profitability.....	2809
Viewing the Deal Level Profitability Report.....	2810
Viewing the Division Level Profitability Report.....	2811
Viewing the Price Item Level Profitability Report.....	2812
Viewing the Hierarchy Entity Level Profitability Report.....	2813
Deal Approval Workflow.....	2814
Deal Information.....	2815
Deal Information - Deal.....	2816
Search Entity.....	2816
Deal.....	2822
Searching for an Entity.....	2829
Recommending a Product for a Deal.....	2830
Defining a Characteristic for a Deal.....	2831
Deal Information - Questionnaire.....	2832
Questionnaire.....	2832
Answering a Questionnaire for a Deal.....	2833
Skipping Questionnaire for a Deal.....	2833
Deal Information - Reference.....	2834
Select Reference.....	2834
Reference Details.....	2840
Searching for a Reference.....	2841
Selecting a Reference for a Deal.....	2842
Skipping Reference for a Deal.....	2843
Deal Information - Pricing and Commitments.....	2844
Deal Information.....	2845
Simulation Details.....	2847
Viewing the Customer Hierarchy of a Deal.....	2856
Viewing the Assigned Price Lists of a Person or Account.....	2856
Viewing the Proposed Price List Assignments of a Person or Account.....	2857
Viewing the Enrolled Products of an Account.....	2857
Viewing the Proposed Product Enrollments for an Account.....	2858
Viewing the Pricing and Commitment Details of a Person.....	2858
Viewing the Pricing and Commitment Details of an Account.....	2859
Viewing the Division Financial Summary in the Division Currency.....	2859
Viewing the Product Financial Summary in the Division Currency.....	2860
Viewing the Revenue and Cost in the Division or Account Currency.....	2861
Simulating a Deal.....	2861
Submitting a Deal for an Approval.....	2862
Approving a Deal.....	2862
Requesting the Submitter to Resubmit the Deal for Approval.....	2863
Finalizing a Deal.....	2864
Discarding a Deal.....	2865
Accepting a Deal.....	2865
Rejecting a Deal.....	2867

Extracting a Deal in the PDF or Excel Format.....	2868
Defining a Deal Version.....	2874
Deal Information - Simulation.....	2875
Deal Information.....	2876
Simulation Details.....	2879
Deal Information - Approvals.....	2887
Deal Information.....	2888
Simulation Details.....	2891
Deal Information - Acceptance/Rejection.....	2899
Deal Information.....	2900
Simulation Details.....	2903
Deal Information - Orchestration.....	2911
Deal Information.....	2911
Simulation Details.....	2914
Deal Information - Discarded.....	2922
Deal Information.....	2923
Simulation Details.....	2926
Pricing and Commitments.....	2934
Pass Through Charge Information.....	2935
Product Financial Summary.....	2935
Filters.....	2935
Pricing and Commitments.....	2936
Viewing the Pass Through Charge Information of an Account.....	2941
Viewing the Product Financial Summary of a Person or an Account.....	2942
Filtering the Pricing of a Person or an Account.....	2943
Viewing the Pricing and Commitments of a Person in the Division Currency.....	2944
Viewing the Pricing and Commitments of an Account in the Account's Invoice Currency.....	2945
Viewing the Original Pricing and Commitments of a Person or an Account.....	2946
Viewing the Original and Proposed Commitments of a Price Item.....	2946
Viewing the Original and Proposed Pricing of a Price Item.....	2947
Approving Pricing of a Price Item.....	2948
Submitting a Price Item for an Approval.....	2949
Selecting a Price Item or Hierarchy Entity.....	2950
Recommending a New Pricing for a Price Item.....	2955
Associating Deal-Specific Terms and Conditions with a Price Item.....	2964
Associating Deal-Specific Terms and Conditions with a Hierarchy Entity.....	2965
Editing the Deal-Specific Terms and Conditions of a Price Item or a Hierarchy Entity.....	2966
Viewing the Deal-Specific Terms and Conditions of a Price Item or a Hierarchy Entity.....	2967
Deal Pricing and Commitments.....	2968
Viewing the Pricing and Commitments of All Entities in a Customer Hierarchy.....	2975
Viewing the Pricing and Commitments of a Particular Account.....	2976
Viewing the Pricing and Commitments of a Particular Customer.....	2977
Viewing the Pricing and Commitments of a Particular Price Item.....	2977
Viewing the Pricing and Commitments of a Particular Hierarchy Entity.....	2978
Price List Assignment.....	2979
Assigning a Proposed Price List to a Person.....	2983
Assigning a Proposed Price List to an Account.....	2984
Deleting a Proposed Price List of a Person or an Account.....	2986
Product Enrollment.....	2987
Enrolling All Accounts of a Person for a Product.....	2992
Enrolling an Account for a Product.....	2997
Deleting a Proposed Product Enrollment of an Account.....	3002
Pricing and Commitments.....	3002
Projected Pricing.....	3003
Original Pricing.....	3009

Proposed Commitments.....	3013
Original Volume.....	3014
Editing a Proposed Price Item Pricing.....	3014
Overriding a Proposed Price Item Pricing.....	3024
Editing a Proposed Commitment.....	3034
Mapping Terms and Conditions.....	3035
Editing Deal-Specific Terms and Conditions.....	3036
Terms and Conditions.....	3038
Associating the Terms and Conditions with a Deal.....	3038
Editing the Terms and Conditions of a Deal.....	3039
Viewing the Terms and Conditions of a Deal.....	3040
Deal Log and Comments.....	3041
Viewing the Logs of a Deal.....	3042
Adding a Log Entry for a Deal.....	3043
Deal Version Log and Comments.....	3043
Viewing the Logs of a Deal Version.....	3045
Adding a Log Entry for a Deal Version.....	3046
Adhoc Revenue and Cost.....	3047
Adding Adhoc Revenue and Cost for a Deal.....	3048
Terms and Conditions Mapping.....	3050
Terms and Conditions Mapping List.....	3050
Terms and Conditions Mapping Details.....	3051
Associating the Terms and Conditions with a Price Item.....	3053
Associating the Terms and Conditions with a Root Level Hierarchy Entity.....	3055
Associating the Terms and Conditions with a Non-Root Level Hierarchy Entity.....	3058
Editing the Terms and Conditions of a Price Item.....	3060
Editing the Terms and Conditions of a Root Level Hierarchy Entity.....	3062
Editing the Terms and Conditions of a Non-Root Level Hierarchy Entity.....	3064
Viewing the Terms and Conditions Mapping Details.....	3066
Deal Approver Dashboard.....	3066
Deal Metrics.....	3066
Deal To Do.....	3067
Search Deal.....	3067
Searching for a Deal.....	3072
Viewing the Deal Approval Information.....	3073
Viewing the Person Information.....	3074
Viewing the Deal Approval Workflow Details.....	3074
Extracting a Deal in the PDF or Excel Format.....	3075

Chapter 43: Relationship Manager Workbench..... 3083

Relationship Manager Workbench.....	3084
RM Workbench.....	3084
Revenue Metrics.....	3085
Customer Metrics.....	3085
Customer Hierarchy.....	3086
Searching for a Customer.....	3088
Searching for an Account.....	3089
Deal Snapshot.....	3089
RM Workbench To Do Notification.....	3090
Top 10 Customers by Revenue.....	3091
Top 10 Price Items by Revenue.....	3091
Top 10 Customers Revenue Variations.....	3091
Top 10 Product By Revenue.....	3092
Viewing the Unpaid Invoices Details.....	3092
Viewing the Inactive Customer's Details.....	3093

Viewing the RM Compare UI.....	3093
Viewing the Revenue Trends.....	3094
Unpaid Invoices Page.....	3094
Receivables by Age Chart.....	3094
Unpaid Revenue Customer's Details.....	3095
Customer's Unpaid Bills Information.....	3096
Inactive Customer Details.....	3096
Inactive Customer Details.....	3097
Inactive Customers Account's Details.....	3097
Viewing the Inactive Customer's Account Details.....	3098
Revenue Trends.....	3098
RM Trends Input.....	3099
Revenue Trends.....	3100
Price Item Revenue Vs Usage Trend.....	3100

Chapter 44: Hold Request Creation, Modification, Release, and View Through Inbound Web Service..... 3101

Prerequisites.....	3102
C1-CreateHoldRequest Business Service.....	3103
Hold Request Creation Request in the XML Format.....	3104
Hold Request Creation Response in the XML Format.....	3105
Hold Request Creation Request and Response - Tags in XML Format.....	3106
Hold Request Creation Request in the JSON Format.....	3109
Hold Request Creation Response in the JSON Format.....	3110
Hold Request Creation Request and Response - Attribute/Value Pairs in JSON Format.....	3111
Sample Hold Request Creation Request and Response in the XML Format.....	3115
Sample Hold Request Creation Request and Response in the JSON Format.....	3117
C1-GetHoldRequestHistory Business Service.....	3119
Hold Request View Request in the XML Format.....	3120
Hold Request View Response in the XML Format.....	3120
Hold Request View Request and Response - Tags in XML Format.....	3121
Hold Request View Request in the JSON Format.....	3123
Hold Request View Response in the JSON Format.....	3124
Hold Request View Request and Response - Attribute/Value Pairs in JSON Format.....	3125
Sample Hold Request View Request and Response in the XML Format.....	3127
Sample Hold Request View Request and Response in the JSON Format.....	3129
C1-ReleaseHoldRequest Business Service.....	3131
Hold Request Release Request in the XML Format.....	3132
Hold Request Release Response in the XML Format.....	3132
Hold Request Release Request and Response - Tags in XML Format.....	3133
Hold Request Release Request in the JSON Format.....	3134
Hold Request Release Response in the JSON Format.....	3135
Hold Request Release Request and Response - Tags in JSON Format.....	3135
Sample Hold Request Release Request and Response in the XML Format.....	3137
Sample Hold Request Release Request and Response in the JSON Format.....	3138
C1-UpdateHoldRequest Business Service.....	3139
Hold Request Update Request in the XML Format.....	3140
Hold Request Update Response in the XML Format.....	3141
Hold Request Update Request and Response - Tags in XML Format.....	3141
Hold Request Update Request in the JSON Format.....	3145
Hold Request Update Response in the JSON Format.....	3145
Hold Request Update Request and Response - Tags in JSON Format.....	3146
Sample Hold Request Update Request and Response in the XML Format.....	3149
Sample Hold Request Update Request and Response in the JSON Format.....	3151

Chapter 45: Hold Direct Debit Instruction..... 3155

Prerequisites.....	3157
Algorithms Used in C1-AutoPayRequest.....	3157
C1-APAYRQINF.....	3157
F1-TODOCOMPL.....	3158
C1-APAYSUB.....	3158
C1-APAYAPP.....	3158
C1-UPDAPAY.....	3158
C1-APAYAPRVD.....	3158
C1-APAYRESUB.....	3159
Auto Pay Request Status Transition without Approval.....	3159
Auto Pay Request Status Transition with Approval.....	3159
Auto Pay Request Type.....	3160
Auto Pay Request Type List.....	3160
Auto Pay Request Type.....	3161
Defining an Auto Pay Request Type.....	3163
Defining a Characteristic for an Auto Pay Request Type.....	3166
Editing an Auto Pay Request Type.....	3167
Copying an Auto Pay Request Type.....	3169
Deleting an Auto Pay Request Type.....	3172
Viewing the Auto Pay Request Type Details.....	3172
Auto Pay Request (Used for Searching).....	3173
Search Auto Pay Request.....	3173
Searching for an Auto Pay Request.....	3176
Creating an Auto Pay Request.....	3177
Viewing the Auto Pay Request Details.....	3178
Auto Pay Request (Used for Viewing).....	3178
Auto Pay Request - Main.....	3179
Auto Pay Request.....	3179
Auto Pay Details.....	3181
Auto Pay Request - Bills.....	3181
Search Bills.....	3182
Auto Pay Line Items.....	3183
Auto Pay Request - Log.....	3184
Auto Pay Request Log.....	3184
Defining a Characteristic for an Auto Pay Request.....	3184
Editing the Auto Pay Request Details.....	3185
Deleting an Auto Pay Request.....	3186
Submitting an Auto Pay Request.....	3187
Approving an Auto Pay Request.....	3188
Rejecting an Auto Pay Request.....	3188
Resubmitting an Auto Pay Request for Approval.....	3189
Searching for a Bill.....	3190
Adding an Auto Pay Line Item in an Auto Pay Request.....	3190
Deleting an Auto Pay Line Item from an Auto Pay Request.....	3191
Editing the Auto Pay Line Item Details in an Auto Pay Request.....	3192
Viewing the Log of an Auto Pay Request.....	3193
Adding a Log Entry for an Auto Pay Request.....	3193

Chapter 46: Garbling Customer Information..... 3195

Chapter 47: Deleting Inactive Customer or Closed Account Information.....	3197
Chapter 48: Retail Banking Product Management.....	3199
Prerequisites.....	3201
Product Status Transition.....	3201
Market Product Status Transition.....	3202
Offer Status Transition.....	3202
Bundle Status Transition.....	3203
Algorithms Used in C1_PRODUCT.....	3204
Algorithms Used in C1_MARKET_PRODUCT.....	3205
Algorithms Used in C1_OFFER.....	3205
Algorithms Used in C1_BUNDLE.....	3206
C1-APPTXNBAS.....	3206
C1-PRDINFO.....	3206
C1-PRDPSPR.....	3207
C1-PRDCT-VAL.....	3207
C1-PRD-TRN.....	3207
C1-MPINFO.....	3207
C1-MP-VAL.....	3207
F1-AT-RQJ.....	3207
C1-OFFRINFO.....	3208
C1-OFFER-VAL.....	3208
C1-BNDLINFO.....	3208
C1-BUNDL-VAL.....	3208
Product (Used for Searching).....	3208
Search Product.....	3209
Searching for a Product.....	3210
Editing a Product.....	3211
Copying a Product.....	3213
Product (Used for Adding).....	3215
Product Information - Basic Details.....	3215
Basic Details.....	3215
Product Information - Other Details.....	3216
Other Details.....	3216
Product Information - Services.....	3217
Services.....	3217
Adding a Product.....	3217
Associating the Product with a Division.....	3219
Defining a Characteristic for the Product.....	3220
Associating the Product to a Parent Group.....	3221
Adding a Service for the Product.....	3221
Market Product (Used for Searching).....	3222
Search Market Product.....	3222
Searching for a Market Product.....	3224
Editing a Market Product.....	3225
Copying a Market Product.....	3227
Market Product (Used for Adding).....	3228
Market Product Information - Basic Details.....	3229
Search Product.....	3229
Basic Details.....	3230
Market Product Information - Other Details.....	3230
Other Details.....	3230

Market Product Information - Eligibility.....	3231
Eligibility.....	3231
Market Product Information - Services.....	3233
Services.....	3233
Market Product Information - Price List.....	3234
Price List.....	3234
Adding a Market Product.....	3235
Associating the Market Product with a Division.....	3237
Defining a Characteristic for the Market Product.....	3238
Defining Eligibility Criteria for the Market Product.....	3239
Adding a Service for the Market Product.....	3241
Associating a Price List with the Market Product.....	3242
Offer (Used for Searching).....	3243
Search Offer.....	3244
Searching for an Offer.....	3245
Editing an Offer.....	3246
Copying an Offer.....	3248
Offer (Used for Adding).....	3250
Offer Information - Basic Details.....	3250
Basic Details.....	3250
Offer Information - Other Details.....	3251
Other Details.....	3251
Offer Information - Eligibility.....	3252
Eligibility.....	3252
Offer Information - Services.....	3254
Services.....	3254
Offer Information - Price List.....	3254
Price List.....	3255
Adding an Offer.....	3256
Associating the Offer with a Market Product.....	3257
Associating the Offer with a Division.....	3258
Defining a Characteristic for the Offer.....	3259
Defining Eligibility Criteria for the Offer.....	3259
Adding a Service for an Offer.....	3261
Associating a Price List with an Offer.....	3262
Bundle (Used for Searching).....	3264
Search Bundle.....	3264
Searching for a Bundle.....	3266
Editing a Bundle.....	3267
Copying a Bundle.....	3269
Bundle (Used for Adding).....	3271
Bundle Information - Basic Details.....	3271
Basic Details.....	3271
Bundle Information - Other Details.....	3272
Other Details.....	3272
Bundle Information - Eligibility.....	3273
Eligibility.....	3273
Bundle Information - Services.....	3275
Services.....	3275
Bundle Information - Price List.....	3275
Price List.....	3276
Adding a Bundle.....	3276
Associating the Bundle with a Market Product.....	3278
Associating the Bundle with a Division.....	3279
Defining a Characteristic for the Bundle.....	3279
Defining Eligibility Criteria for the Bundle.....	3280

Adding a Service for a Bundle.....	3282
Associating a Price List with the Bundle.....	3283

Chapter 49: Retail Banking Product Inbound Web Services.....3287

Prerequisites.....	3289
C1_GETELIGIBLEPROD Business Service.....	3290
Eligible Market Products, Offers, or Bundles Derivation Request in the XML Format.....	3291
Eligible Market Products, Offers, or Bundles Derivation Response in the XML Format....	3292
Eligible Market Products, Offers, or Bundles Derivation Request and Response - Tags in XML Format.....	3294
Sample Eligible Market Product Derivation Request and Response in the XML Format....	3299
Sample Eligible Offer Derivation Request and Response in the XML Format.....	3326
Sample Eligible Bundle Derivation Request and Response in the XML Format.....	3352
Eligible Market Products, Offers, or Bundles Derivation Request in the JSON Format.....	3379
Eligible Market Products, Offers, or Bundles Derivation Response in the JSON Format..	3379
Eligible Market Products, Offers, or Bundles Derivation Request and Response - Attribute/Value Pairs in JSON Format.....	3382
Sample Eligible Market Product Derivation Request and Response in the JSON Format..	3387
Sample Eligible Offer Derivation Request and Response in the JSON Format.....	3416
Sample Eligible Bundle Derivation Request and Response in the JSON Format.....	3442
C1-GetProdDetail Business Service.....	3470
Market Product, Offer, or Bundle View Request in the XML Format.....	3471
Market Product, Offer, or Bundle View Response in the XML Format.....	3472
Market Product, Offer, or Bundle View Request - Tags in XML Format.....	3474
Sample Market Product View Request and Response in the XML Format.....	3477
Sample Offer View Request and Response in the XML Format.....	3499
Sample Bundle View Request and Response in the XML Format.....	3520
Sample Market Product View Summary Request and Response in the XML Format.....	3541
Sample Market Product View Detail Request and Response in the XML Format.....	3543
Market Product, Offer, or Bundle View Request in the JSON Format.....	3565
Market Product, Offer, or Bundle View Response in the JSON Format.....	3566
Market Product, Offer, or Bundle View Request and Response - Attribute/Value Pairs in JSON Format.....	3568
Sample Market Product View Request and Response in the JSON Format.....	3571
Sample Offer View Request and Response in the JSON Format.....	3575
Sample Bundle View Request and Response in the JSON Format.....	3598
Sample Bundle View Summary Request and Response in the JSON Format.....	3620
Sample Bundle View Detail Request and Response in the JSON Format.....	3622
C1PRDCTENRL Business Service.....	3644
Market Product, Offer, or Bundle Enrollment Request in the XML Format.....	3649
Market Product, Offer, or Bundle Enrollment Response in the XML Format.....	3650
Market Product, Offer, or Bundle Enrollment Request and Response - Tags in XML Format.....	3652
Sample Market Product Enrollment Request and Response in the XML Format.....	3660
Sample Market Product Enrollment Edit Request and Response in the XML Format.....	3661
Sample Market Product Enrollment Close Request and Response in the XML Format.....	3663
Sample Offer Enrollment Request and Response in the XML Format.....	3664
Sample Offer Enrollment Edit Request and Response in the XML Format.....	3665
Sample Offer Enrollment Close Request and Response in the XML Format.....	3667
Sample Bundle Enrollment Request and Response in the XML Format.....	3668
Sample Bundle Enrollment Edit Request and Response in the XML Format.....	3670
Sample Bundle Enrollment Close Request and Response in the XML Format.....	3671
Market Product, Offer, or Bundle Enrollment Request in the JSON Format.....	3672
Market Product, Offer, or Bundle Enrollment Response in the JSON Format.....	3674

Market Product, Offer, or Bundle Enrollment Request and Response - Attribute/Value Pairs in JSON Format.....	3676
Sample Market Product Enrollment Request and Response in the JSON Format.....	3683
Sample Market Product Enrollment Edit Request and Response in the JSON Format.....	3685
Sample Market Product Enrollment Close Request and Response in the JSON Format.....	3687
Sample Offer Enrollment Request and Response in the JSON Format.....	3688
Sample Offer Enrollment Edit Request and Response in the JSON Format.....	3690
Sample Offer Enrollment Close Request and Response in the JSON Format.....	3691
Sample Bundle Enrollment Request and Response in the JSON Format.....	3693
Sample Bundle Enrollment Edit Request and Response in the JSON Format.....	3695
Sample Bundle Enrollment Close Request and Response in the JSON Format.....	3696

Chapter 50: Deal Management through Inbound Web Services..... 3699

Prospect Creation, Modification, and View through Inbound Web Service.....	3700
Prospect Add Request in the XML Format.....	3701
Prospect Add Response in the XML Format.....	3702
Prospect Update Request in the XML Format.....	3704
Prospect Update Response in the XML Format.....	3705
Prospect View Request in the XML Format.....	3706
Prospect View Response in the XML Format.....	3707
Prospect Add Request and Response - Tags in the XML Format.....	3708
Prospect Update Request and Response - Tags in the XML Format.....	3716
Prospect View Request and Response - Tags in the XML Format.....	3723
Sample Prospect Creation Request and Response in the XML Format.....	3726
Sample Prospect Update Request and Response in the XML Format.....	3729
Sample Prospect View Request and Response in the XML Format.....	3733
Prospect Add Request in the JSON Format.....	3736
Prospect Add Response in the JSON Format.....	3737
Prospect Update Request in the JSON Format.....	3739
Prospect Update Response in the JSON Format.....	3740
Prospect View Request in the JSON Format.....	3742
Prospect View Response in the JSON Format.....	3742
Prospect Add Request and Response - Attribute/Value Pairs in the JSON Format.....	3744
Prospect Update Request and Response - Attribute/Value Pairs in the JSON Format.....	3751
Prospect View Request and Response - Attribute/Value Pairs in the JSON Format.....	3758
Sample Prospect Creation Request and Response in the JSON Format.....	3762
Sample Prospect Update Request and Response in the JSON Format.....	3765
Sample Prospect View Request and Response in the JSON Format.....	3769
Prospect Account Creation, Modification, and View through Inbound Web Service.....	3772
Prospect Account Add Request in the XML Format.....	3773
Prospect Account Add Response in the XML Format.....	3774
Prospect Account Update Request in the XML Format.....	3775
Prospect Account Update Response in the XML Format.....	3775
Prospect Account View Request in the XML Format.....	3776
Prospect Account View Response in the XML Format.....	3776
Prospect Account Add Request and Response - Tags in the XML Format.....	3777
Prospect Account Update Request and Response - Tags in the XML Format.....	3780
Prospect Account View Request and Response - Tags in the XML Format.....	3783
Sample Prospect Account Creation Request and Response in the XML Format.....	3785
Sample Prospect Account Update Request and Response in the XML Format.....	3786
Sample Prospect Account View Request and Response in the XML Format.....	3787
Prospect Account Add Request in the JSON Format.....	3788
Prospect Account Add Response in the JSON Format.....	3788
Prospect Account Update Request in the JSON Format.....	3789
Prospect Account Update Response in the JSON Format.....	3790

Prospect Account View Request in the JSON Format.....	3791
Prospect Account View Response in the JSON Format.....	3791
Prospect Account Add Request and Response - Attribute/Value Pairs in the JSON Format.....	3792
Prospect Account Update Request and Response - Attribute/Value Pairs in the JSON Format.....	3795
Prospect Account View Request and Response - Attribute/Value Pairs in the JSON Format.....	3799
Sample Prospect Account Creation Request and Response in the JSON Format.....	3800
Sample Prospect Account Update Request and Response in the JSON Format.....	3801
Sample Prospect Account View Request and Response in the JSON Format.....	3803
Price List Assignments in Deal through Inbound Web Service.....	3804
Deal Price List Assignment Add Request in the XML Format.....	3805
Deal Price List Assignment Add Response in the XML Format.....	3805
Deal Price List Assignment Delete Request in the XML Format.....	3806
Deal Price List Assignment Delete Response in the XML Format.....	3807
Deal Price List Assignment Update Request in the XML Format.....	3807
Deal Price List Assignment Update Response in the XML Format.....	3808
Deal Price List Assignment View Request in the XML Format.....	3808
Deal Price List Assignment View Response in the XML Format.....	3809
Deal Price List Assignment Add Request and Response - Tags in the XML Format.....	3809
Deal Price List Assignment Delete Request and Response - Tags in the XML Format.....	3811
Deal Price List Assignment Update Request and Response - Tags in the XML Format.....	3813
Deal Price List Assignment View Request and Response - Tags in the XML Format.....	3815
Sample Deal Price List Assignment Add Request and Response in the XML Format.....	3817
Sample Deal Price List Assignment Delete Request and Response in the XML Format.....	3818
Sample Deal Price List Assignment Update Request and Response in the XML Format.....	3819
Sample Deal Price List Assignment View Request and Response in the XML Format.....	3820
Deal Price List Assignment Add Request in the JSON Format.....	3821
Deal Price List Assignment Add Response in the JSON Format.....	3821
Deal Price List Assignment Delete Request in the JSON Format.....	3822
Deal Price List Assignment Delete Response in the JSON Format.....	3822
Deal Price List Assignment Update Request in the JSON Format.....	3823
Deal Price List Assignment Update Response in the JSON Format.....	3824
Deal Price List Assignment View Request in the JSON Format.....	3824
Deal Price List Assignment View Response in the JSON Format.....	3825
Deal Price List Assignment Add Request and Response - Attribute/Value Pairs in the JSON Format.....	3826
Deal Price List Assignment Delete Request and Response - Attribute/Value Pairs in the JSON Format.....	3828
Deal Price List Assignment Update Request and Response - Attribute/Value Pairs in the JSON Format.....	3829
Deal Price List Assignment View Request and Response - Attribute/Value Pairs in the JSON Format.....	3832
Sample Deal Price List Assignment Add Request and Response in the JSON Format.....	3834
Sample Deal Price List Assignment Delete Request and Response in the JSON Format.....	3835
Sample Deal Price List Assignment Update Request and Response in the JSON Format.....	3836
Sample Deal Price List Assignment View Request and Response in the JSON Format.....	3837
Deal Price Assignments and Commitments through Inbound Web Service.....	3838
Deal Price Assignment Override Request in the XML Format.....	3840
Deal Price Assignment Override Response in the XML Format.....	3841
Deal Price Assignment Update Request in the XML Format.....	3843
Deal Price Assignment Update Response in the XML Format.....	3844
Deal Price Assignment Recommend Request in the XML Format.....	3845
Deal Price Assignment Recommend Response in the XML Format.....	3847
Deal Price Assignment Delete Request in the XML Format.....	3848

Deal Price Assignment Delete Response in the XML Format.....	3849
Deal Price Assignment and Commitments View Request in the XML Format.....	3849
Deal Price Assignment and Commitments View Response in the XML Format.....	3849
Deal Commitments Add Request in the XML Format.....	3851
Deal Commitments Add Response in the XML Format.....	3852
Deal Commitments Update Request in the XML Format.....	3852
Deal Commitments Update Response in the XML Format.....	3853
Deal Price Assignment Override Request and Response - Tags in the XML Format.....	3854
Deal Price Assignment Update Request and Response - Tags in the XML Format.....	3862
Deal Price Assignment Recommend Request and Response - Tags in the XML Format....	3870
Deal Price Assignment Delete Request and Response - Tags in the XML Format.....	3878
Deal Price Assignment and Commitments View Request and Response - Tags in the XML Format.....	3880
Deal Commitments Add Request and Response - Tags in the XML Format.....	3886
Deal Commitments Update Request and Response - Tags in the XML Format.....	3889
Sample Deal Price Assignment Override Request and Response in the XML Format.....	3891
Sample Deal Price Assignment Update Request and Response in the XML Format.....	3894
Sample Deal Price Assignment Recommend Request and Response in the XML Format.	3897
Sample Deal Price Assignment Delete Request and Response in the XML Format.....	3899
Sample Deal Price Assignment and Commitments View Request and Response in the XML Format.....	3900
Sample Deal Commitments Add Request and Response in the XML Format.....	3902
Sample Deal Commitments Update Request and Response in the XML Format.....	3903
Deal Price Assignment Override Request in the JSON Format.....	3904
Deal Price Assignment Override Response in the JSON Format.....	3906
Deal Price Assignment Update Request in the JSON Format.....	3907
Deal Price Assignment Update Response in the JSON Format.....	3909
Deal Price Assignment Recommend Request in the JSON Format.....	3910
Deal Price Assignment Recommend Response in the JSON Format.....	3912
Deal Price Assignment Delete Request in the JSON Format.....	3913
Deal Price Assignment Delete Response in the JSON Format.....	3914
Deal Price Assignment and Commitments View Request in the JSON Format.....	3914
Deal Price Assignment and Commitments View Response in the JSON Format.....	3915
Deal Commitments Add Request in the JSON Format.....	3917
Deal Commitments Add Response in the JSON Format.....	3917
Deal Commitments Update Request in the JSON Format.....	3918
Deal Commitments Update Response in the JSON Format.....	3919
Deal Price Assignment Override Request and Response - Attribute/Value Pairs in the JSON Format.....	3920
Deal Price Assignment Update Request and Response - Attribute/Value Pairs in the JSON Format.....	3928
Deal Price Assignment Recommend Request and Response - Attribute/Value Pairs in the JSON Format.....	3936
Deal Price Assignment Delete Request and Response - Attribute/Value Pairs in the JSON Format.....	3945
Deal Price Assignment and Commitments View Request and Response - Attribute/Value Pairs in the JSON Format.....	3947
Deal Commitments Add Request and Response - Attribute/Value Pairs in the JSON Format.....	3953
Deal Commitments Update Request and Response - Attribute/Value Pairs in the JSON Format.....	3955
Sample Deal Price Assignment Override Request and Response in the JSON Format.....	3958
Sample Deal Price Assignment Update Request and Response in the JSON Format.....	3961
Sample Deal Price Assignment Recommend Request and Response in the JSON Format.	3964
Sample Deal Price Assignment Delete Request and Response in the JSON Format.....	3967

Sample Deal Price Assignment and Commitments View Request and Response in the JSON Format.....	3968
Sample Deal Commitments Add Request and Response in the JSON Format.....	3970
Sample Deal Commitments Update Request and Response in the JSON Format.....	3971
Deal Creation, Modification, and View through Inbound Web Service.....	3973
Deal Creation Request in the XML Format.....	3976
Deal Creation Response in the XML Format.....	3977
Deal Update Request in the XML Format.....	3979
Deal Update Response in the XML Format.....	3981
Deal View Request in the XML Format.....	3985
Deal View Response in the XML Format.....	3985
Deal Creation Request and Response - Tags in the XML Format.....	3989
Deal Update Request and Response - Tags in the XML Format.....	4010
Deal View Request and Response - Tags in the XML Format.....	4032
Sample Deal Creation Request and Response in the XML Format.....	4045
Sample Deal View Request and Response in the XML Format.....	4047
Sample Deal Update Request and Response in the XML Format.....	4049
Sample Deal Version Creation Request and Response in the XML Format.....	4051
Sample Deal Simulation Request and Response in the XML Format	4052
Sample Deal Submission for Approval Request and Response in the XML Format.....	4056
Sample Deal Approval Request and Response in the XML Format.....	4058
Sample Deal Return to Submitter Request and Response in the XML Format.....	4060
Sample Deal Finalization Request and Response in the XML Format	4061
Sample Deal Acceptance Request and Response in the XML Format.....	4063
Sample Deal Rejection Request and Response in the XML Format.....	4064
Sample Deal Discard Request and Response in the XML Format.....	4067
Sample Price Item Selection View Request and Response in the XML Format.....	4068
Sample Price Item Selection Request and Response in the XML Format.....	4070
Deal Creation Request in the JSON Format.....	4072
Deal Creation Response in the JSON Format.....	4074
Deal Update Request in the JSON Format.....	4076
Deal Update Response in the JSON Format.....	4078
Deal View Request in the JSON Format.....	4083
Deal View Request in the JSON Format.....	4083
Deal Creation Request and Response - Attribute Value Pairs in the JSON Format.....	4087
Deal Update Request and Response - Attribute/Value Pairs in the JSON Format.....	4108
Deal View Request and Response - Attribute/Value Pairs in the JSON Format.....	4128
Sample Deal Creation Request and Response in the JSON Format.....	4141
Sample Deal View Request Response in JSON Format.....	4143
Sample Deal Update Request and Response in the JSON Format.....	4145
Sample Deal Version Creation Request and Response in the JSON Format.....	4148
Sample Deal Simulation Request and Response in the JSON Format	4150
Sample Deal Submission for Approval Request and Response in the JSON Format.....	4154
Sample Deal Approval Request and Response in the JSON Format	4156
Sample Deal Return to Submitter Request and Response in the JSON Format.....	4158
Sample Deal Finalization Request and Response in the JSON Format	4160
Sample Deal Acceptance Request and Response in the JSON Format.....	4162
Sample Deal Rejection Request and Response in the JSON Format.....	4164
Sample Deal Discard Request and Response in the JSON Format.....	4165
Sample Price Item Selection View Request and Response in the JSON Format.....	4167
Sample Price Item Selection Request and Response in the JSON Format.....	4169
Deal Extraction through Inbound Web Service.....	4171
Deal Extraction Request in the XML Format.....	4172
Deal Extraction Response in the XML Format.....	4173
Deal Extraction Request and Response - Tags in the XML Format.....	4178
Sample Deal Extraction Request and Response in the XML Format.....	4194

Deal Extraction Request in the JSON Format.....	4202
Deal Extraction Response in the JSON Format.....	4203
Deal Extraction Request and Response - Attribute/Value Pairs in the JSON Format.....	4208
Sample Deal Extraction Request and Response in the JSON Format.....	4225

Chapter 51: Chatbot.....4235

Chapter 52: Billing Anomaly Detection with Artificial Intelligence

(AI) and Machine Learning (ML)..... 4239

Lifecycle of a ML Job.....	4241
Prerequisites.....	4241
ML Jobs.....	4242
Search ML Job.....	4242
Searching for an ML Job.....	4243
Diagnostic Central.....	4244
Search Anomaly.....	4244
Bill Segment Anomalies.....	4247
Searching for a Bill Level Anomaly.....	4248
Viewing the Bill Segment Anomaly Details.....	4248
Searching for a Bill Segment Level Anomaly.....	4249
Closing an Anomaly.....	4249
Setting the C1-PREBSEG Feature Configuration.....	4250

Chapter 53: Automatic Refund.....4253

Chapter 54: Reporting.....4257

Report Creation Using Apache FOP Framework.....	4258
Prerequisites.....	4258
PDF Generation Using Apache FOP.....	4258
Excel (XLS) Generation Using XSL Transformation.....	4258
Sample XML Format for FOP Reporting.....	4258
Sample XSL Format for FOP Reporting.....	4259
Create XSL Template for an FOP Report.....	4260
XSL Templates shipped with ORMB.....	4260
Create an Algorithm for an FOP Report.....	4263
Creating a Message for an FOP Report.....	4266
Calling the ORMB FOP Reporting API.....	4267
Setting Master Configuration for Email Notification.....	4267
Creating a Custom Algorithm for FOP Reports.....	4268
Configuring the Custom Algorithm from the User Interface.....	4269
Report Creation.....	4271
Report Search.....	4271
Searching for an FOP Report.....	4272
Defining an FOP Report.....	4273
Editing an FOP Report.....	4276
Deleting an FOP Report.....	4280
Viewing the FOP Report Details.....	4280
Report Audit.....	4280
Report Generation List.....	4281
Downloading an FOP Report.....	4281
Report Generation.....	4282

Generating an FOP Report.....	4282
FOP Reports.....	4283
Adjustment Detail Report.....	4283
Entity Hold Detail Report.....	4284
Invoice Aging Report.....	4284
Payment Detail Report.....	4284
Payment Summary Report.....	4285
Transaction Rejection Detail Report.....	4285
Transaction Rejection Summary Report.....	4285
To Do Report.....	4285
User Access Report.....	4286
Quick Response Code Generation.....	4286

Chapter 55: Invoice Extract in UBL Format..... 4287

Prerequisites.....	4288
C1-InvoiceChargeExtract Business Service.....	4288
C1-UBLBILEX Algorithm.....	4289
C1-UBLINVOICEEXTRACT Extract Template.....	4290
UBL Format.....	4293
Field Mapping for UBL Format.....	4294
Sample Invoice Extract in the UBL Format.....	4297

Appendix A: Most Commonly Used Tasks..... 4299

Changing the Layout.....	4300
Adding a Column to the Zone.....	4300
Rearranging Columns in the Zone.....	4300
Removing a Column from the Zone.....	4300

Appendix B: Administration.....4303

UI Maps.....	4304
Creating Display UI Map for an Approval Workflow Group.....	4304
Creating Input UI Map for an Approval Workflow Group.....	4305
Feature Configurations.....	4306
Setting the C1_ACCTINFO Feature Configuration.....	4306
Setting the C1_AXENTITY Feature Configuration.....	4308
Setting the C1_DIVFUNCT Feature Configuration.....	4310
Setting the C1-Deal Feature Configuration.....	4311
Setting the C1-EHRCONFIG Feature Configuration.....	4316
Setting the C1_EXCHRATE Feature Configuration.....	4317
Setting the C1_EXP_OVRD Feature Configuration.....	4318
Setting the C1_FINTRANOP Feature Configuration.....	4319
Setting the C1_FM Feature Configuration.....	4324
Setting the C1-INCT Feature Configuration.....	4329
Setting the C1_MASPRI Feature Configuration.....	4331
Setting the C1_MLTCURACC Feature Configuration.....	4331
Setting the C1-ODBFC Feature Configuration.....	4333
Setting the C1-OFFSETREQ Feature Configuration.....	4335
Setting the C1-PAYPORTAL Feature Configuration.....	4336
Setting the C1_PER_REL Feature Configuration.....	4338
Setting the C1-PLSM Feature Configuration.....	4339
Setting the C1_PPARAM_FLG Feature Configuration.....	4340
Setting the C1_PR_REC Feature Configuration.....	4341
Setting the C1_PRICING Feature Configuration.....	4342

Setting the C1_PRASNORDR Feature Configuration.....	4344
Setting the C1-PYREQSRT Feature Configuration.....	4345
Setting the C1_RLENG Feature Configuration.....	4346
Setting the C1-TXNDMYID Feature Configuration.....	4347
Setting the C1-PAYFLUPLD Feature Configuration.....	4348
Setting the C1-CFS Feature Configuration.....	4349
Setting the C1-FLUPLD Feature Configuration.....	4351
Setting the C1-REPORTVW Feature Configuration.....	4354

Preface

About this Document

This document lists and describes various features in Oracle Revenue Management and Billing which can be used in the financial services domain. It describes all screens related to these features and explains how to perform various tasks through these screens.

Intended Audience

This document is intended for the following audience:

- End-users
- System Administrators
- Consulting Team
- Implementation Team
- Development Team

Organization of the Document

Each banking feature is described in a separate chapter in this document. All screens related to the feature and tasks related to the screen are explained in each chapter. This document contains the following chapters:

Chapter Number	Chapter Name	Chapter Description
Chapter 1	Customer Registration	Describes how to create a person and account through a customer registration object.
Chapter 2	Customer 360° View	Explains how to view in-depth information about the person or account in the Customer 360° View screen. It also explains how to view the enrolled products, effective price assignments, and effective price list assignments of a person or account. In addition, it explains how to view the detailed information about the bill.
Chapter 3	Invoicing Group	Describes the invoicing group and explains how to create a master account. It also explains how to add or remove a member from a master account.
Chapter 4	Pricing Management	Explains the different concepts of the pricing model supported in the application. It explains how to define a parameter, price item, price list, tiering criterion, variance parameter, and person to person relationship type sequence. It also explains how to define pricing for a price item, how to assign a price item to a person, account, or price list, and how to assign a price list to a person or account.
Chapter 5	Division	Describes the different types of division. It also explains how to define a division.
Chapter 6	Approval Workflow	Describes the approval workflow process and explains how to perform various tasks involved in the process. It explains how to

Chapter Number	Chapter Name	Chapter Description
		implement the approval workflow process for an entity, such as account, person, and so on. It explains how to define an approval workflow group, approval workflow chain, approval workflow criterion type, approval workflow group chain linkage, approval workflow reasons, and approval workflow settings.
Chapter 7	Multi-Currency Accounts	Lists and describes the business processes that are enhanced to implement the multi-currency accounts feature.
Chapter 8	Rules Engine	Describes how the rules engine function. It explains how to define, execute, and maintain business rules separately from the application code.
Chapter 9	Alternate Sequential Bill Numbers	Explains how to generate alternate sequential bill numbers which are either unique throughout the system or within the division.
Chapter 10	Currency Conversion	Lists and describes the business processes where the currency conversion feature can be enabled in the system. It explains how to enable the currency conversion feature for each business process. It also explains how to create different types of exchange rates in the system.
Chapter 11	Transaction Feed Management	Describes the transaction feed management process and its sub-processes. It explains how to execute each sub-process. It also explains how to view the details of various transactions uploaded in the system. In addition, it explains how to create a transaction source, transaction record type, transaction aggregation rule, aggregation schedule, and disaggregation request.
Chapter 12	On Demand Billing	Explains how to generate adhoc bills using the on demand billing process. It explains how to create a file type and file group, how to upload a usage data file, how to generate adhoc bills for a file group, and how to freeze the adhoc bills of a file group.
Chapter 13	Upload Validated Payment Data	Explains how to upload and validate the payment records before you move them to the staging area. It also explains how to create payment events and payments using the validated payment records.
Chapter 14	Freeze Payments on Notification	Explains how the system freezes or cancels the automatic payments, voids the refund requests and cancels the refund adjustments when the review comments are received from the auto clearing house.
Chapter 15	Construct	Describes the construct based billing and settlement feature. It explains how to create templates and different types of constructs, such as invoice construct, invoice and settlement construct, and settlement construct. It also explains how to view the billing and settlement hierarchy of a person or account.
Chapter 16	Trial Billing	Explains how to generate trial bills before the actual bill is generated for an account. It also explains how to view the trial bills in the system.
Chapter 17	Bill Tolerance	Explains how to define the tolerance limit for the bill amount. It also describes how the system behaves when the difference between the previous and current bill amount exceeds the positive or negative tolerance limit.
Chapter 18	GL Account Validation	Explains how to enable the static or dynamic GL account validation feature.

Chapter Number	Chapter Name	Chapter Description
Chapter 19	Upload Validated Adjustment Data	Explains how to validate and upload an adjustment data file and create adjustments through an adjustment upload request.
Chapter 20	Foreign Exchange Gain Loss	Explains how the system calculates the foreign exchange gain loss on the payment and adjustment financial transactions.
Chapter 21	Payment Request	Explains how to create or transfer payments through a payment request.
Chapter 22	Account Receivable Central	Explains how to use the Account Receivable Central screen to search for a bill which you need to offset against another bill. It explains how to perform single, mass, and cross currency offset against one or more bills. It also enables you to create a hold request, refund request, write off request, and dispute request through this screen.
Chapter 23	Offset Request	Explains how to offset the bill's outstanding amount against one or more bills through an offset request. It explains how to create the offset request types and offset requests in the system.
Chapter 24	Funding Request	Describes how to change the automatic payment amount through the funding process. It explains how to create the funding request types and funding requests in the system.
Chapter 25	Hold Request	Describes how to hold some processes and/or bills at the account or person level for a time period through a hold request. It explains how to create the hold request types and hold requests in the system.
Chapter 26	Delinquency Central	Explains how to track the overdue processes of a delinquent account through the Delinquency Central screen. It also explains how to create a hold request, payment arrangement, and promise to pay for a delinquent account from this screen.
Chapter 27	Upload Request	Explains how to do the following through an upload request: <ul style="list-style-type: none"> • Update bill cycle of accounts • Update contract riders in contracts • Create hold requests, refund requests, write off requests, or billable charges • Reinstate the policies • Create sort records for bill groups • Create derivation and pricing parameters for bill groups
Chapter 28	General Ledger (GL) Accounting Template	Describes how to override the distribution code used for creating FT GL entries using the GL Accounting Template feature. It explains how to create the GL accounting templates for each process and sub processes combination.
Chapter 29	Accrual	Describes how to calculate, create, and reverse accrual for accounts. It explains how to create the accrual cycles, accrual types, and accruals for the accounts in the system.
Chapter 30	Payment Agreement Request	Describes how to schedule payments in installments for a set of unpaid bills of an account through a payment agreement request. It explains how to create the payment agreement request types and payment agreement requests in the system.

Chapter Number	Chapter Name	Chapter Description
Chapter 31	Dispute Request	Describes how to track and close a dispute against a particular bill, bill segment, and/or adjustment through a dispute request. It explains how to create the dispute request types and dispute requests in the system.
Chapter 32	Earning Credit Rate	Explains how to create the financial transaction distribution (ECR) object when the adjustment and/or bill segment financial transaction created against an ECR contract is frozen. It also explains how to distribute the credit or debit amount on the financial transaction distribution object to different accounts based on the distribution hierarchy.
Chapter 33	Deferred Revenue Recognition	Describes how to recognize the deferred revenue in the system. It explains how to create a deferred revenue recognition template for each distribution code and contract type combination. It also explains how to generate the schedule for a deferred revenue recognition. In addition, it explains how to edit the deferred revenue recognition schedule.
Chapter 34	Product Lifecycle Management	Describes the entire lifecycle of a product from inception to service and then to the retirement. It explains how to create various types of products, such as standard and packaged products. It explains how to create a product service, product, and product versions in the system. It also explains how to enroll an account for different types of products.
Chapter 35	Subscription Billing	Describes the service based billing wherein the customers pay a subscription price to have access to a product or service. It explains how to create the subscription types and subscriptions on the accounts.
Chapter 36	Mass Pricing Update	Describes how to update multiple price assignments of a person, account, price list, or product at the same time. It explains how to increase or decrease the rate in a price assignment or forcibly end date a price assignment through a mass pricing update request. It also explains how to create the mass pricing update request types and mass pricing update requests in the system.
Chapter 37	Price Item, Parameter, and SQI Upload	Describes how to upload the price item, parameter, and SQI files through the File Upload Interface utility. It explains how information should be structured while uploading the price item, parameter, and SQI files in the XML or CSV format. It also explains how to define different file request types for adding or editing the price items, parameters, and SQIs in different formats.
Chapter 38	Product and Product Version Upload	Describes how to upload the product and product version files through the File Upload Interface utility. It explains how information should be structured while uploading the product and product version files in the XML or CSV format. It also explains how to define different file request types for adding or editing the products and product versions in different formats.
Chapter 39	Price List and Price Item Pricing Upload	Describes how to upload the price list and price assignment files through the File Upload Interface utility. It explains how information should be structured while uploading the price list and price assignment files in the XML or CSV format. It also explains

Chapter Number	Chapter Name	Chapter Description
		how to define different file request types for adding or editing the price lists and price assignments in different formats.
Chapter 40	Invoice Request	Describes how to create adhoc regular and trial bills for an account through an invoice request. It explains how to create the invoice request types and invoice requests in the system.
Chapter 41	Deal Management	Describes how to create deals for an existing customer, account, or prospect using various simulation types. It explains how to simulate, approve, finalize, and accept the deals. It also explains how to apply back or orchestrate the deal on customer onboarding.
Chapter 42	Relationship Manager Workbench	Describes how a relationship manager can obtain a holistic view of all its customers.
Chapter 43	Hold Request Creation, Modification, Release, and View Through Inbound Web Service	Lists various business services using which you can create, edit, and release a hold request and view the details of a hold request.
Chapter 44	Hold Direct Debit Instruction	Describes how to hold a direct debit (i.e. automatic payment) for a bill until the confirmation is received from the customer. It explains how to create the auto pay request types and auto pay requests in the system.
Chapter 45	Garbling Customer Information	Explains how to garble the personal information of a customer, such as the customer name, address, email ID, social security number or any other identifier, birth date, gender, and so on, on receiving the data erasure request from the customer.
Chapter 46	Deleting Inactive Customer or Closed Account Information	Explains how to delete all records of a person or account from the system.
Chapter 47	Retail Banking Product Management	Explains how to maintain a variety of products and services for the retail banking domain.
Chapter 48	Retail Banking Product Inbound Web Services	Explains how to derive the eligible market product, offer, and bundle for a person or an account through an inbound web service. It also explains how to view the details of a retail banking product, market product, offer, and bundle through an inbound web service.
Chapter 49	Deal Management through Inbound Web Services	Explains how to manage prospects and deals through the inbound web services.
Chapter 50	Chatbot	Explains how the system provides digital assistance to the user to have conversational experiences with ORMB through text, chat, and voice interfaces.
Chapter 51	Billing Anomaly Detection with Artificial Intelligence (AI) and Machine Learning (ML)	Explains how to use machine learning to detect anomalies in the bills and bill segments before the bill completion.
Chapter 52	Automatic Refund Process	Explains how to create automatic refunds when a credit bill or a credit adjustment is created or when there is an overpayment.
Chapter 53	FOP Reports	Lists various FOP reports using which you can extract data from the system in the PDF format.

Chapter Number	Chapter Name	Chapter Description
Chapter 54	Invoice Extract in UBL Format	Describes how to extract the invoices in the Universal Business Language (UBL) format using the Extract Template feature.
Appendix A	Most Commonly Used Tasks	Lists and describes some of the common tasks that you may perform while using the application.
Appendix B	Administration	Describes how to create UI maps and set various feature configurations in the system.

Conventions

The following conventions are used across this document:

Convention	Meaning
boldface	Boldface indicates graphical user interface elements associated with an action, or terms defined in the text.
<i>italic</i>	Italic indicates a document or book title.
Monospace	Monospace indicates information that an end-user needs to enter in the application.

Related Documents

You can refer to the following documents for more information:

Document Name	Description
<i>Oracle Revenue Management and Billing Version 5.0.0.0.0 Release Notes</i>	Provides a brief description about the new features, enhancements, and UI level changes introduced in the current release. The new features and enhancements are classified under three distinct heads – Generic (which is intended for both domains), Financial Services, and Health Insurance. It also contains high-level information about the supported platforms, framework upgrade, supported upgrades, and documentation updates. In addition, it contains a list of discontinued features, planned deprecation notices, customer bugs fixed or forward ported and known issues in the current release.
<i>Oracle Utilities Application Framework Business Process Guide</i>	Explains how to get acquainted with the user interface. It explains the different types of pages or portals that you may come across in the application. It explains how to set the user preferences and how to create, manage, assign, and complete a To Do in the application. It also explains how to submit reports and view historic reports in the application.
<i>Oracle Utilities Application Framework Administrative Guide</i>	Explains the general, security, user, designing, developing, and scripting options available in Oracle Utilities Application Framework (OUAF). It describes the user interface, database, configuration, and reporting tools available in OUAF. In addition, it provides information about the application viewer, how to configure incoming and outgoing messages, and how to integrate Lightweight Directory Access Protocol (LDAP), Oracle Identity Manager (OIM), and Batch Scheduler with Oracle Revenue Management and Billing (ORMB).

Document Name	Description
<i>Oracle Revenue Management and Billing Business Process Guide</i>	<p>Explains how to maintain the demographic, geographic, and financial objects (i.e. accounts) of a customer. It explains how to manage a customer's bills, payments, adjustments, credits, collections processing, statements and deposits in Oracle Revenue Management and Billing (ORMB). It also describes the financial transactions, case management, sales and marketing functions, rates engine, quotations, loans, how to monitor and execute job streams, and how to manage workflows, notifications and overdue processing. In addition, it explains how to extract the data from the system using an extract template.</p> <p>The features listed and described in this document can be used in both financial services and health insurance domains.</p>
<i>Oracle Revenue Management and Billing Administrative Guide</i>	<p>Explains how to configure various features and functionalities in Oracle Revenue Management and Billing (ORMB). For example, billing, payments, adjustments, financial transactions, credits, collections processing, loans, service credits, background processes, quotations, case management, security, overdue processing, batch scheduler, workflow and notifications, etc.</p> <p>The information available in this document can be used in both financial services and health insurance domains.</p>
<i>Oracle Revenue Management and Billing TFM - Batch Execution Guide</i>	<p>Explains the sequence in which the batches should be executed while performing various tasks in the Transaction Feed Management (TFM) module.</p> <p>It provides detailed information about each TFM batch and its parameters. It also indicates the restart and multi-threading ability of each batch. In addition, it recommends values for various parameters which can be used for tuning batch performance as per the available hardware.</p>
<i>Oracle Revenue Management and Billing Batch Guide</i>	<p>Provides detailed information about various batches which are used in different modules, such as billing, payments, financial transaction, pricing management, funding request, offset request, hold request, upload request, inbound message, payment agreement request, accruals, earnings credit rate, ILM, deferred revenue recognition, reconciliation, garbling, repricing, entity audit, statements, etc. It also contains information about the batch parameters and the batch restart and multi-threading abilities.</p>

Change Log

Revision	Last Update	Chapter Name	Updated Section	Comments
22.1	24-01-2023	Chatbot	-	Updated Information
		Pricing Management	Hierarchy Relationship Tree	Added and Updated Information

Revision	Last Update	Chapter Name	Updated Section	Comments
			Defining a Price Item or Price Item Bundle	Added and Updated Information
			Editing a Price Item or Price Item Bundle	Added and Updated Information
			Copying a Price Item or Price Item Bundle	Added and Updated Information
			Defining a Hierarchy Entity	Added and Updated Information
			Copying a Hierarchy Entity	Added and Updated Information
			Editing a Hierarchy Entity	Added and Updated Information
			Price List Price Items	Added and Updated Information
			Price List Price Items	Added and Updated Information
			Price List Price Items	Added and Updated Information
			Effective Price Assignments for Account	Added and Updated Information
			Effective Price Assignments for Person	Added and Updated Information
		Deal Management	Selecting a Price Item or Hierarchy Entity	Added and Updated Information
			Filters	Added and Updated Information

Revision	Last Update	Chapter Name	Updated Section	Comments
			Filtering the Pricing of a Person or an Account	Added and Updated Information
			Accepting a Deal	Added and Updated Information
			Defining a Deal	Added and Updated Information
			Associating Deal-Specific Terms and Conditions with a Price Item	Added and Updated Information
			Associating Deal-Specific Terms and Conditions with a Hierarchy Entity	Added and Updated Information
			Pricing and Commitments	Added and Updated Information
			Associating the Terms and Conditions with a Deal	Added and Updated Information
			Editing the Deal-Specific Terms and Conditions of a Price Item or a Hierarchy Entity	Added Information
			Viewing the Deal-Specific Terms and Conditions of a Price Item or a Hierarchy Entity	Added Information
			Deal Information	Added and Updated Information
			Terms and Conditions	Added Information
			Editing the Terms and Conditions of a Deal	Added Information
			Viewing the Terms and Conditions of a Deal	Added Information

Revision	Last Update	Chapter Name	Updated Section	Comments
		Transaction Feed Management	Search	Added and Updated Information
22.2	24-03-2023	Deal Management	Filters	Updated Information
			Filtering the Pricing of a Person or an Account	Updated Information
			Deal Type	Updated Information
			Defining a Deal Type	Updated Information
			Editing a Deal Type	Updated Information
			Copying a Deal Type	Updated Information
			Associating an Algorithm with a Deal Type	Updated Information
			Search Deal	Updated Information
			Accepting a Deal	Updated Information
			Associating Deal-Specific Terms and Conditions with a Price Item	Updated Information
			Associating Deal-Specific Terms and Conditions with a Hierarchy Entity	Updated Information
			Pricing and Commitments	Updated Information
			Defining a Deal	Updated Information
			Associating the Terms and Conditions with a Deal	Updated Information
Deal Information	Updated Information			

Revision	Last Update	Chapter Name	Updated Section	Comments
			Terms and Conditions	Added Information
			Editing the Terms and Conditions of a Deal	Added Information
			Viewing the Terms and Conditions of a Deal	Added Information
			Editing the Deal-Specific Terms and Conditions of a Price Item or a Hierarchy Entity	Updated Information
			Viewing the Deal-Specific Terms and Conditions of a Price Item or a Hierarchy Entity	Updated Information
		Administration	Setting the C1-OFFSETREQ Feature Configuration	Updated Information
			Setting the C1_AXENTITY Feature Configuration	Updated Information
			Setting the C1_FINTRANOP Feature Configuration	Updated Information
			Setting the C1-PAYFLUPLD Feature Configuration	Updated Information
		Transaction Feed Management	Reseeding	Removed Section
		22.3	10-05-2023	On Demand Billing
Upload Validated Payment Data	Prerequisites			Added Information
Administration	Setting the C1-CFS Feature Configuration			Added Section
	Setting the C1-REPORTVW Feature Configuration			Added Section
	Setting the C1-FLUPLD Feature Configuration			Added Section

Revision	Last Update	Chapter Name	Updated Section	Comments
22.4	12-07-2023	Deal Management	Simulation Details	Added Information
			Defining a Deal	Added Information
			Defining a Deal Version	Added Information
			Selecting a Price Item or Hierarchy Entity	Added Information
			Defining a Prospect Person	Added Information
		Deal Management through Inbound Web Services	Prospect Add Request and Response - Tags in the XML Format	Added Information
			Prospect Add Request and Response - Attribute/Value Pairs in the JSON Format	Added Information
			Prospect Update Request and Response - Tags in the XML Format	Added Information
			Prospect Update Request and Response - Attribute/Value Pairs in the JSON Format	Added Information
			Deal Update Request and Response - Tags in the XML Format	Added Information
			Deal Update Request and Response - Attribute/Value Pairs in the JSON Format	Added Information
			Deal Creation, Modification, and View through Inbound Web Service	Added Information
			Sample Deal Discard Request and Response in the XML Format	Added Information
			Sample Deal Discard Request and Response in the JSON Format	Added Information

Revision	Last Update	Chapter Name	Updated Section	Comments
		Reporting	-	Added Chapter
		FOP Reports	-	Moved under the Reporting chapter
22.5	18-11-2023	Deal Management	Creating a Deal using a Deal Template	Added Information

Chapter 1

Customer Registration

Topics:

- [Customer Registration \(Without Approval\) Status Transition](#)
- [Customer Registration \(With Approval\) Status Transition](#)
- [Customer Registration Template](#)
- [Customer Registration Type](#)
- [Customer Registration \(Used for Searching\)](#)
- [Customer Registration \(Used for Viewing\)](#)

Until now, you were able to create person and account from the different screens. Now, ORMB provides the ability to create a person and multiple accounts for the person from the same user interface. A new object named **Customer Registration** is introduced in this release. Through a customer registration object, you can create person, accounts and contracts at the same time from the same interface. Before creating a customer registration object, you need to create the following:

- **Customer Registration Template** – A customer registration template encapsulates the following information:
 - List of pages that should appear when you create a person or account using the respective customer registration template
 - List of sections that should appear in each page
 - Field or characteristic attributes, such as:
 - Default value for a field or characteristic type
 - Default value for a person or account identifier type or phone type
 - Primary identifier type for a person or account
 - Mandatory field in each section
 - Enable or disable the field value, identifier type, identifier value, characteristic type, characteristic value, phone type, or phone number

You can create multiple customer registration templates for person and account. Depending on whether you are creating a customer registration template for person or account, you can include the following pages and define field or characteristic attributes for the following sections:

Template Category	Template Page	Template Section
Person	Main	Person Main
Person	Main	Person Names
Person	Main	Person Identifiers
Person	Main	Person Phones
Person	Contact Information	Person Address
Person	Contact Information	Person Email
Person	Accounts	-

Template Category	Template Page	Template Section
Person	Person Hierarchy	Person Hierarchy – Main
Person	Person Hierarchy	Person Hierarchy – Characteristics
Person	Person Characteristics	Person Characteristics
Person	Deal Information	Deal – Main
Person	Registration Characteristics	Customer Registration Characteristics
Account	Main	Account Information
Account	Main	Account Identifiers
Account	Auto Pay	Account Autopay
Account	Persons	Main
Account	Persons	Account Address Override Information
Account	Persons	Bill Routing
Account	Account Characteristics	Account Characteristics
Account	Credit Ratings	Credit Rating

- **Customer Registration Type** - A customer registration type encapsulates the following information:
 - Users with a particular access group can only create a customer registration object using the customer registration type.
 - Whether the customer registration type can be used to create a customer registration object from the user interface, through the inbound message, or through the **File Upload Interface** utility.
 - Whether the approval is required when you create, edit, or delete a customer registration object.
 - The business objects using which the person, account, and address should be created when a customer registration object is created using the customer registration type.
 - A customer registration template which indicates the pages and sections that should appear when you are creating a customer registration object using the customer registration type. You can specify one customer registration template for person and one or more customer registration templates for account.
- Information, such as person names, person identifiers, person phones, person characteristics, person addresses, person hierarchy, accounts, account identifiers, account characteristics, account auto pay information, account persons, account bill routing information, or credit rating history, which should be copied when you create a copy of a customer registration object which is created using the customer registration type.

While creating a customer registration object, you need to specify the following:

- A customer registration type using which the customer registration object should be created
- A source system from the customer information is received
- A type of person that you want to create through the customer registration object

Once you specify the above details, the **Customer Registration** screen appears with a set of pages and sections which are added in the respective person template. The default values for the fields, characteristic types, identifier types, and phone types are shown as specified in the person template. In addition, the field values, characteristic types, characteristic values, identifier types, identifier values, phone types, and phone numbers are disabled as specified in the person template. On the **Accounts** page, you can view one row for each account template which is added in the customer registration type. You can then edit the row and thereby create an account for the person. You can create multiple accounts for the person using the same or different template.

Note: The system creates effective dated address using the address business object which is specified in the customer registration type. By default, the account override address is effective from the date when the customer registration object is created in the system.

On clicking the **View/Edit** icon or the **Add New Account** button, the **Customer Registration - Add Account** screen appears with a set of pages and sections which are added in the respective account template. The default values for the fields, characteristic types, and identifier types are shown as specified in the account template. In addition, the field values, characteristic types, characteristic values, identifier types, and identifier values are disabled as specified in the account template.

You can save the person and account details as and when you are entering the data by clicking the **Save as Draft** button. On clicking the **Save as Draft** button, the system creates a customer registration object in the **Draft** status. Once all person and account details are specified, you can click the **Validate and Save** button. The system then validates the information. You can edit, delete, or submit a customer registration object when it is in the **Draft** status. On submitting a customer registration object, the person and accounts are created in the system. If an algorithm created using the **C1-CRECONT** algorithm type is attached to the **Post-Processing** system event of the account business object (which is specified in the customer registration type), the system creates the contracts for each account. Finally, the status of the customer registration object is changed to **Complete**.

You can optionally configure the approval process for the customer registration. If the **Approval Required** option is selected in the customer registration type, the status of the customer registration object is changed to **Approval In Progress** on submitting it. A To Do using the approval To Do type is created and assigned to the users with the approval To Do role. The approver can then review the customer registration object and accordingly approve, reject, or request the submitter to resubmit the customer registration object for approval. On approving a customer registration object, the person, accounts, and contracts (if the required algorithm is attached) are created in the system. Finally, the status of the customer registration object is changed to **Complete**.

If the approver rejects a customer registration object due to some reason, the status of the customer registration object is changed to **Rejected**. However, if the approver requests the submitter to resubmit a customer registration object for approval after making the required changes, the status of the customer

registration object is changed to **Draft**. The submitter can then make the required changes and resubmit the customer registration object for approval.

Note: The system enables you to create maximum 10 accounts for a person through a customer registration object from the user interface.

You can also create a customer registration object using the **File Upload Interface** utility. On creating a customer registration object using the **File Upload Interface** utility, the status of the customer registration object is set to **Draft**. You can then submit the customer registration object manually from the user interface. Note that, at present, only the XML format is supported for creating a customer registration object using the **File Upload Interface** utility.

To implement the **Customer Registration** feature, the following new screens are introduced in this release:

- Customer Registration Template
- Customer Registration Type
- Customer Registration

Customer Registration (Without Approval) Status Transition

The following figure graphically indicates how a customer registration object moves from one status to another when the approval process is not configured in the customer registration type:



Customer Registration (With Approval) Status Transition

The following figure graphically indicates how a customer registration object moves from one status to another when the approval process is configured in the customer registration type:

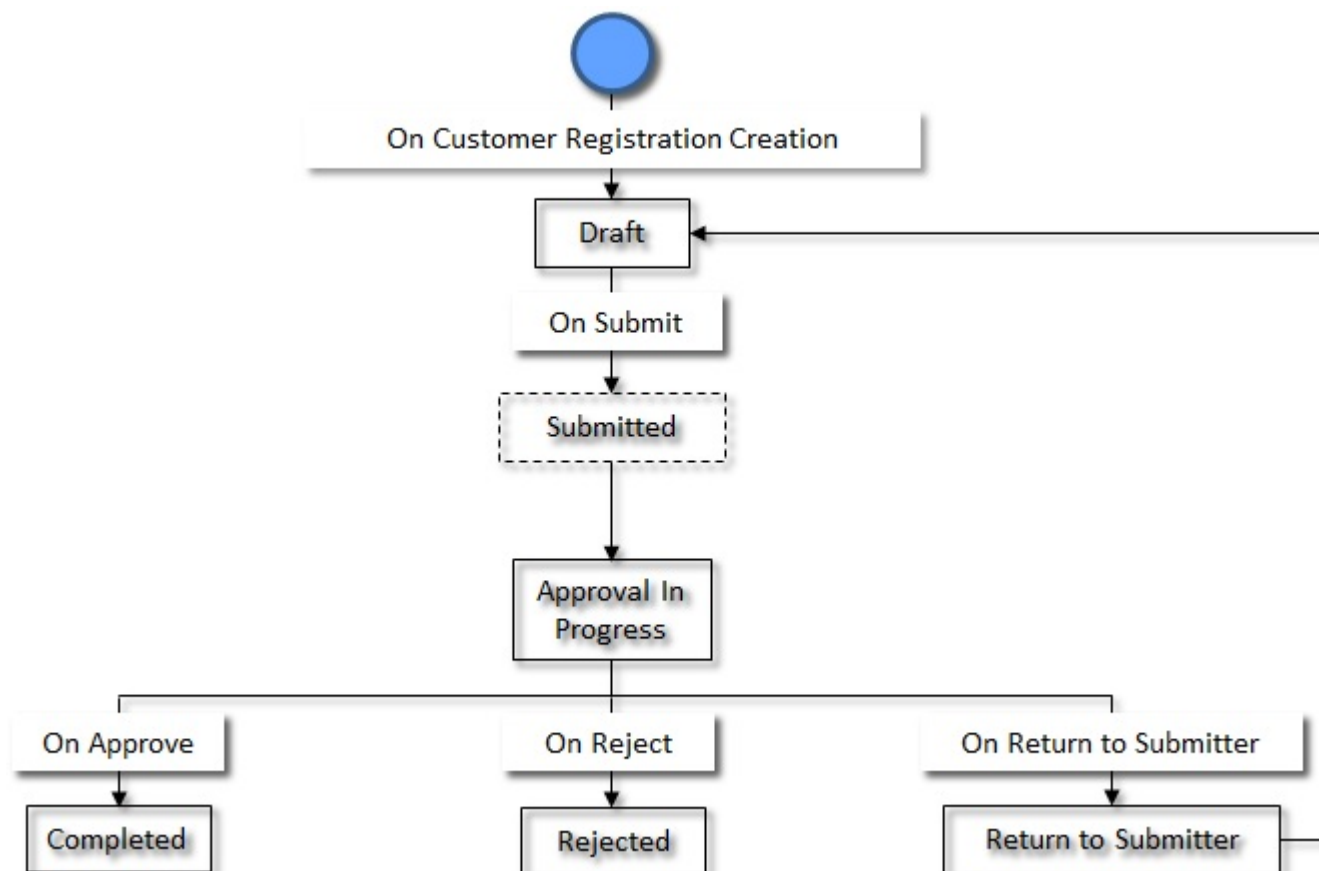

Customer Registration Template

A customer registration template encapsulates the following information:

- List of pages that should appear when you create a person, account, policy, or policy plan using the respective customer registration template
- List of sections that should appear in each page
- Field or characteristic attributes, such as:
 - Default value for a field or characteristic type
 - Default value for a person or account identifier type or phone type
 - Primary identifier type for a person or account
 - Mandatory field in each section
 - Enable or disable the field value, identifier type, identifier value, characteristic type, characteristic value, phone type, or phone number

You can create multiple customer registration templates for person, account, policy and policy plan. Depending on whether you are creating a customer registration template for person, account, policy or policy plan, you can include the following pages and define field or characteristic attributes for the following sections:

Template Category	Template Page	Template Section
Person	Main	Person Main

Template Category	Template Page	Template Section
		Person Names
		Person Identifiers
		Person Phones
	Contact Information	Person Address
		Person Email
	Accounts	-
	Person Hierarchy	Person Hierarchy – Main
		Person Hierarchy – Characteristics
	Person Characteristics	Person Characteristics
	Policies	Policies
		Parent Policies
	Registration Characteristics	Customer Registration Characteristics
	Account	Main
Account Identifiers		
Auto Pay		Account Autopay
Persons		Main
		Account Address Override Information
		Bill Routing
Account Characteristics		Account Characteristics
Policy	Policy – Main	Policy Main
		Policy Persons
		Policy Characteristics
Policy Plan	Plan	Plan - Main
		Plan - Characteristics

Search Customer Registration Template

The **Search Customer Registration Template** zone allows you to search for a customer registration template using various search criteria. It contains the following sections:

- **Search Criteria** - The **Search Criteria** section contains the following fields:

Field Name	Field Description	Mandatory (Yes or No)
Search By	<p>Used to indicate whether you want to search for customer registration templates using the banking template or the healthcare template details. The valid values are:</p> <ul style="list-style-type: none"> • Banking Template - Used to indicate whether you want to search for customer registration templates created using the C1-CustomerRegistrationTmpIBK business object. • Healthcare Template - Used to indicate whether you want to search for customer registration templates created using the C1-CustomerRegistrationTmpIHC business object. <p>Note: By default, the Banking Template option is selected.</p>	Yes
Template	Used to search for a particular template.	No
Description	Used to search for customer registration templates having a particular description.	No
Template Category	<p>Used to search for customer registration templates which belong to a particular category. The valid values are:</p> <ul style="list-style-type: none"> • Account • Person • Policy • Policy Plan <p>Note: The Policy and Policy Plan options appear when you select the Healthcare Template option from the Search By list.</p>	No

Note: You must specify at least one search criterion while searching for a customer registration template.

- **Search Results** - On clicking the **Search** button, the search results appear based on the specified search criteria. The **Search Results** section contains the following columns:

Column Name	Column Description
Template	Displays the customer registration template.
Description	Displays the description of the customer registration template.
Template Category	<p>Displays the category to which the customer registration template belongs. The valid values are:</p> <ul style="list-style-type: none"> • Account

Column Name	Column Description
	<ul style="list-style-type: none"> • Person • Policy • Policy Plan
Edit	On clicking the Edit (✎) icon, the Customer Registration Template screen appears where you can edit the details of the customer registration template.
Duplicate	On clicking the Duplicate (📄) icon, the Customer Registration Template screen appears where you can define a new customer registration template using an existing customer registration template.
Delete	On clicking the Delete (🗑) icon, you can delete the customer registration template. Note: You can delete a customer registration template when a customer registration is not yet defined using the customer registration template.

On clicking the **Broadcast** (📡) icon corresponding to a customer registration template, the **Customer Registration Template** zone appears with the details of the respective customer registration template.

By default, the **Filter** area is hidden. You can view the **Filter** area by clicking the **Filters** (🔍) icon in the upper right corner of this zone.

Note: Pagination is used to display limited number of records in the **Search Results** section. You can use the navigation links, such as **Previous** and **Next** to navigate between pages.

Related Topics

For more information on...	See...
How to search for a customer registration template	Searching for a Customer Registration Template on page 83
Customer Registration Template zone	Customer Registration Template on page 81

Customer Registration Template

The **Customer Registration Template** zone displays the details of the customer registration template. It also allows you to edit, copy, and delete the customer registration template. It contains the following sections

- **Main** - Displays the basic information about the customer registration template. It contains the following fields:

Field Name	Field Description
Template	Displays the customer registration template.
Template Category	Indicates the category for which the customer registration template is created in the system. The valid values are: <ul style="list-style-type: none"> • Account • Person • Policy • Policy Plan

Field Name	Field Description
	Note: The Policy and Policy Plan template categories appear when the customer registration template is created using the C1-CustomerRegistrationTmplHC business object.
Description	Displays the description of the customer registration template.
Detailed Description	Displays additional information about the customer registration template.

- **Template Pages** - The **Template Pages** section lists the template pages, template sections added for a particular template category in a customer registration template. It contains the following columns:

Column Name	Column Description
Template Page	Indicates the template page which is added for the template category.
Template Section	Indicates the template section which is defined for the template page.

- **Record Actions** - The **Record Actions** section contains the following buttons:

Button Name	Button Description
Edit	Used to edit the details of the customer registration template.
Delete	Used to delete the customer registration template. Note: You can delete a customer registration template when a customer registration is not yet created using the customer registration template.
Duplicate	Used to create a new customer registration template using an existing customer registration template.

- **Record Information** - The **Record Information** section contains the following field:

Field Name	Field Description
Business Object	Indicates the business object using which the customer registration template is created in the system. In addition, a context menu appears corresponding to this field which helps in navigating to other screens in the application. Note: It has a link. On clicking the link, the Business Object screen appears where you can view the details of the respective business object.

By default, the **Customer Registration Template** zone does not appear in the **Customer Registration Template** screen. It appears when you click the **Broadcast** () icon corresponding to the customer registration template in the **Search Customer Registration Template** zone.

Related Topics

For more information on...	See...
How to define a customer registration template	Defining a Customer Registration Template on page 84
How to edit a customer registration template	Editing a Customer Registration Template on page 96
How to copy a customer registration template	Copying a Customer Registration Template on page 97
How to delete a customer registration template	Deleting a Customer Registration Template on page 99

For more information on...	See...
How to view the details of a customer registration template	Viewing the Customer Registration Template Details on page 83
Customer Registration Template screen	Customer Registration Template on page 78
Search Customer Registration Template zone	Search Customer Registration Template on page 79

Searching for a Customer Registration Template

Prerequisites

To search for a customer registration template, you should have:

- Customer registration template business objects defined in the application
- Customer registration templates defined in the application
- Customer registration templates associated with the template categories

Procedure

To search for a customer registration template:

1. Click the **Admin** link in the **Application** toolbar.
A list appears.
2. From the **Admin** menu, select **C** and then click **Customer Registration Template**.
A sub-menu appears.
3. Click the **Search** option from the **Customer Registration Template** sub-menu.
The **Customer Registration Template** screen appears.
4. Enter the search criteria in the **Search Customer Registration Template** zone.

Note: ORMB search engine supports wildcard search, where you can substitute the percentage (%) symbol as a stand in for any word or letter in a search criteria. You can use the ‘%’ wildcard character in all input fields except the date and ID fields. The ‘%’ wildcard character is suffixed automatically at the end of the partial search criteria. Therefore, you may or may not specify the wildcard character at the end of the partial search criteria. However, you have to prefix the wildcard character manually wherever required.

5. Click **Search**.

A list of customer registration templates that meet the search criteria appears in the **Search Results** section.

Related Topics

For more information on...	See...
Customer Registration Template screen	Customer Registration Template on page 78
Search Customer Registration Template zone	Search Customer Registration Template on page 79

Viewing the Customer Registration Template Details

Procedure

To view the details of a customer registration template:

1. Search for the customer registration template in the **Customer Registration Template** screen.
2. In the **Search Results** section, click the **Broadcast** (📡) icon corresponding to the customer registration template whose details you want to view.

The **Customer Registration Template** zone appears.

- View the details of the customer registration template in the **Customer Registration Template** zone.

Related Topics

For more information on...	See...
How to search for a customer registration template	Searching for a Customer Registration Template on page 83
Search Customer Registration Template zone	Search Customer Registration Template on page 79
Customer Registration Template zone	Customer Registration Template on page 81

Defining a Customer Registration Template

Prerequisites

To define a customer registration template, you should have:

- Customer registration template business objects defined in the application
- Template categories defined in the application
- Template pages and sections defined in the application

Procedure

To define a customer registration template:

- Click the **Admin** link in the **Application** toolbar.
A list appears.
- From the **Admin** menu, select **C** and then click **Customer Registration Template**.
A sub-menu appears.
- Click the **Add** option from the **Customer Registration Template** sub-menu.

The **Select Business Object** screen appears. It contains the following field:

Field Name	Field Description	Mandatory (Yes or No)
Customer Registration Template Business Object	Used to indicate the business object using which you want to define the customer registration template. The valid values are: <ul style="list-style-type: none"> Customer Registration Template - Banking - Used to indicate that you want to define a customer registration template using the C1-CustomerRegistrationTmplBK business object. Customer Registration Template - Health Care - Used to indicate that you want to define a customer registration template using the C1-CustomerRegistrationTmplHC business object. 	Yes

Tip: Alternatively, you can access the **Select Business Object** screen by clicking the **Add** button in the **Page Title** area of the **Customer Registration Template** screen.

4. Select the required customer registration template business object from the respective field.
5. Click **OK**.

The **Customer Registration Template for Banking** or the **Customer Registration Template for Healthcare** screen appears depending upon the selected business object. It contains the following sections:

- **Main** - Used to specify basic details about the customer registration template.
- **Template Pages** - Used to add template pages and its related sections for the customer registration template.
- **Main** - The **Main** section contains the following fields:

Field Name	Field Description	Mandatory (Yes or No)
Template	Used to specify the customer registration template.	Yes
Template Category	Used to indicate the category for which you want to define the customer registration template. The valid values are: <ul style="list-style-type: none"> • Account • Person • Policy • Policy Plan 	Yes
	Note: The Policy and Policy Plan options appear when you are defining a customer registration template using the CI-CustomerRegistrationTmplHC business object.	
Business Object	Indicates the business object using which you want to define the customer registration template.	Not applicable
Description	Used to specify the description for the customer registration template.	Yes
Detailed Description	Used to specify additional information about the customer registration template.	No

6. Enter the required details in the **Main** section.
7. Add the template pages and template sections for the customer registration template in the **Template Pages** section.
8. Set the field attributes for the template sections in the **Template Pages** section.
9. Click **Save**.

The customer registration template is defined.

Related Topics

For more information on...	See...
Customer Registration Template screen	Customer Registration Template on page 78
How to add the pages and sections in a customer registration template	Adding the Pages and Sections in a Customer Registration Template on page 86
How to set the field attributes for a template section	Setting the Field Attributes for a Template Section on page 90

Adding the Pages and Sections in a Customer Registration Template

Prerequisites

To add a page and its related sections in a customer registration template, you should have:

- Template categories defined in the application
- Template pages and sections defined in the application

Procedure

To define a customer registration template:

1. Ensure that the **Template Pages** section is expanded when you are defining, editing, or copying a customer registration template.

The **Template Pages** section contains the following fields:

Field Name	Field Description	Mandatory (Yes or No)						
Template Page	Used to indicate the page which you want to add in a customer registration template for a particular template category.	Yes (Conditional) Note: This field is required while adding pages and sections in a customer registration template.						
Template Section	Used to indicate the section and its field attributes which you want to define for a particular page in a customer registration template. Note: On clicking the Add (⊕) icon, the following columns appear: <table border="1" data-bbox="609 1459 1104 1890"> <thead> <tr> <th>Column Name</th> <th>Column Description</th> </tr> </thead> <tbody> <tr> <td>Template Section</td> <td>Used to indicate the section for a particular page.</td> </tr> <tr> <td>Field Attributes</td> <td>Used to define the field attributes of a section. Note: On clicking the Add (⊕) icon, you can define the field attributes for the section.</td> </tr> </tbody> </table>	Column Name	Column Description	Template Section	Used to indicate the section for a particular page.	Field Attributes	Used to define the field attributes of a section. Note: On clicking the Add (⊕) icon, you can define the field attributes for the section.	Yes (Conditional) Note: This field is required while adding pages and sections in a customer registration template.
Column Name	Column Description							
Template Section	Used to indicate the section for a particular page.							
Field Attributes	Used to define the field attributes of a section. Note: On clicking the Add (⊕) icon, you can define the field attributes for the section.							

The following table lists the various pages and sections that you can include in a customer registration template:

Template Category	Template Pages		Template Sections	
	Template Page	Mandatory (Yes or No)	Template Section	Mandatory (Yes or No)
Account	Auto Pay	No	Account Autopay	No
	Account Characteristics	No	Account Characteristics	No
	Credit Ratings	No	Credit Rating	No
	<div style="border: 1px solid black; padding: 5px;"> <p>Note: This template page appears when you are defining, editing, or copying a customer registration template which is created using the C1-Customer Registration TmplBK business object.</p> </div>			
	Main	Yes	Account Identifiers	Yes
			Account Information	Yes
	Persons	Yes	Account Address Override Information	No
			Bill Routing	Yes
			Main	Yes
	Person	Accounts	No	-
Contact Information		No	Person Address	No
			Person Email	No
Deal Information		No	Deal-Main	No

Template Category	Template Pages		Template Sections	
	Template Page	Mandatory (Yes or No)	Template Section	Mandatory (Yes or No)
	<p>Note: This template page appears when you are defining, editing, or copying a customer registration template which is created using the C1-Customer Registration TmplBK business object.</p>			
	Main	Yes	Person Identifiers	Yes
			Person Main	Yes
			Person Names	Yes
			Person Phones	No
	Person Characteristics	No	Person Characteristics	No
	Person Hierarchy	No	Person Hierarchy-Characteristics	No
			Person Hierarchy-Main	No
	Policies	No	Parent Policy	No
			Policies	No

Template Category	Template Pages		Template Sections	
	Template Page	Mandatory (Yes or No)	Template Section	Mandatory (Yes or No)
	<p>Note: This template page appears only when you are defining, editing, or copying a customer registration template which is created using the</p> <p>C1-Customer Registration TmplHC business object.</p>			
	Registration Characteristics	No	Customer Registration Characteristics	No
Policy	<p>Note: This template category appears only when you are defining, editing, or copying a customer registration template which is created using the</p> <p>C1-CustomerRegistration TmplHC business object.</p>	Yes	Policy Characteristics	No
			Policy-Main	Yes
			Policy Persons	No
Policy Plan	Plan	Yes	Plan-Characteristics	No
			Plan-Main	Yes

2. Enter the required details in the **Template Pages** section.
3. Set the field attributes for the template section, if required.
4. If you want to add more than one page or section for the customer registration template, click the **Add (+)** icon and then repeat step 2.

Note: However, if you want to remove a page or section from the customer registration template, click the **Delete (🗑)** icon corresponding to the page or section.

5. Click **Save**.

The pages and sections are added in the customer registration template.

Note:

You can add all the template pages available for a particular template category by clicking the **Select All** check box in the upper left corner of the **Template Pages** section.

You cannot edit or delete a template page or section if a customer registration is already defined using the customer registration template.

Related Topics

For more information on...	See...
Customer Registration Template screen	Customer Registration Template on page 78
How to define a customer registration template	Defining a Customer Registration Template on page 84
How to set the field attributes for a template section	Setting the Field Attributes for a Template Section on page 90
How to edit a customer registration template	Editing a Customer Registration Template on page 96
How to copy a customer registration template	Copying a Customer Registration Template on page 97

Setting the Field Attributes for a Template Section

Prerequisites

To set the field attributes for a template section, you should have:

- Template pages and sections associated with the template category
- Fields for the sections defined in the application

Procedure

To set the field attributes for a template section:

1. Ensure that the **Template Pages** section is expanded when you are defining, editing, or copying a customer registration template.

The **Template Pages** section contains the following fields:

Field Name	Field Description	Mandatory (Yes or No)
Template Page	Used to indicate the page which you want to add in a customer registration template for a particular template category.	Yes (Conditional)

Field Name	Field Description	Mandatory (Yes or No)						
		Note: This field is required while adding pages and sections in a customer registration template.						
Template Section	Used to indicate the section and its field attributes which you want to define for a particular page in a customer registration template. Note: On clicking the Add (+) icon, the following columns appear:	Yes (Conditional) Note: This field is required while adding pages and sections in a customer registration template.						
	<table border="1"> <thead> <tr> <th>Column Name</th> <th>Column Description</th> </tr> </thead> <tbody> <tr> <td>Template Section</td> <td>Used to indicate the section for a particular page.</td> </tr> <tr> <td>Field Attributes</td> <td>Used to define the field attributes of a section. Note: On clicking the Add (+) icon, you can define the field attributes for the section.</td> </tr> </tbody> </table>	Column Name	Column Description	Template Section	Used to indicate the section for a particular page.	Field Attributes	Used to define the field attributes of a section. Note: On clicking the Add (+) icon, you can define the field attributes for the section.	
Column Name	Column Description							
Template Section	Used to indicate the section for a particular page.							
Field Attributes	Used to define the field attributes of a section. Note: On clicking the Add (+) icon, you can define the field attributes for the section.							

- Select the template page and template section from the respective columns.
- Click the **Add** (+) icon in the **Field Attributes** column corresponding to the template section whose field attributes you want to set.

It contains the following fields in a grid:

Field Name	Field Description	Mandatory (Yes or No)
Sequence	Used to specify the sequence of the field attribute.	Yes (Conditional) Note: This field is required while setting the field attributes for a template section.
Field	Used to indicate the field for which you want to set attributes.	Yes (Conditional) Note: This field is required while setting the field attributes for a template section.

Field Name	Field Description	Mandatory (Yes or No)
	<p>Note:</p> <p>The Search (🔍) icon appears corresponding to this field. On clicking the Search icon, the Field Search window appears.</p> <p>On specifying the field, the description of the field appears corresponding to the field.</p>	
Default Field Value	<p>Used to indicate the default value for the field in the template section.</p> <p>Note:</p> <p>On specifying a field, the Search (🔍) icon appears corresponding to the Default Field Value field. On clicking the Search icon, a window appears depending on the field that you have selected.</p> <p>On specifying the default field value, the description of the default field value appears corresponding to the default field value.</p>	<p>Yes (Conditional)</p> <p>Note: This field is required while setting the field attributes for a template section.</p>
Required	<p>Used to indicate whether the field is mandatory in the template section.</p> <p>Note: By default, the check box in the Required column is disabled. It is enabled when you specify the field in the Field column.</p>	<p>Yes (Conditional)</p> <p>Note: This field is required while setting the field attributes for a template section.</p>
Disable Field Value	<p>Used to indicate whether the field is disabled in the template section.</p> <p>Note: By default, the check box in the Disable Field Value column is disabled. It is enabled when you specify the field in the Field column.</p>	<p>Yes (Conditional)</p> <p>Note: This field is required while setting the field attributes for a template section.</p>
Identifier Type	<p>Used to indicate the type of identifier for which you want to set attributes.</p> <p>Note:</p> <p>On specifying a field, the Search (🔍) icon appears corresponding to the Identifier Type field. On clicking the Search icon, the Search Zone for Person Identifier window appears.</p> <p>On specifying the identifier type, the description of the identifier type appears corresponding to the Identifier Type field.</p>	<p>Yes (Conditional)</p> <p>Note: This field is required while setting the field attributes for a template section.</p>

Field Name	Field Description	Mandatory (Yes or No)
Identifier Value	Used to specify the value for the identifier type for which you want to set attributes.	Yes (Conditional)
	Note: By default, this field is disabled. It is enabled when you specify the identifier type in the Identifier Type column.	Note: This field is required while setting the field attributes for a template section.
Primary ID	Used to indicate whether the identifier type and identifier value are primary or not.	Yes (Conditional)
	Note: By default, the check box in the Primary ID field is disabled. It is enabled when you specify the identifier type in the Identifier Type column.	Note: This field is required while setting the field attributes for a template section.
Disable Identifier Type	Used to indicate whether the identifier type is disabled in the template section.	Yes (Conditional)
	Note: By default, the check box in the Disable Identifier Type column is disabled. It is enabled when you specify the identifier type in the Identifier Type column.	Note: This field is required while setting the field attributes for a template section.
Disable Identifier Value	Used to indicate whether the identifier value is disabled in the template section.	Yes (Conditional)
	Note: By default, the check box in the Disable Identifier Value column is disabled. It is enabled when you specify the identifier value in the Identifier Value column.	Note: This field is required while setting the field attributes for a template section.
Name Type	Used to indicate the type of name for which you want to set attributes.	Yes (Conditional)
	<p>Note:</p> <p>On specifying a field, the Search  icon appears corresponding to the Name Type field. On clicking the Search icon, the Search Zone for Person Name Type window appears.</p> <p>On specifying the name type, the description of the name type appears corresponding to the Name Type field.</p>	Note: This field is required while setting the field attributes for a template section.
Name	Used to specify the name of the person.	Yes (Conditional)
	Note: By default, this field is disabled. It is enabled when you specify the name type in the Name Type column.	Note: This field is required while setting the field attributes for a template section.
Disable Name Type	Used to indicate whether the name type is disabled in the template section.	Yes (Conditional)

Field Name	Field Description	Mandatory (Yes or No)
	Note: By default, the check box in the Disable Name Type column is disabled. It is enabled only when you specify the name type in the Name Type column.	Note: This field is required while setting the field attributes for a template section.
Disable Name	Used to indicate whether the specified name of the person is disabled in the template section. Note: By default, the check box in the Disable Name column is disabled. It is enabled when you specify the name in the Name column.	Yes (Conditional) Note: This field is required while setting the field attributes for a template section.
Phone Type	Used to specify the type of phone for which you want to set attributes. Note: On specifying a field, the Search (🔍) icon appears corresponding to the Phone Type field. On clicking the Search icon, the Search Zone for Phone Type window appears. On specifying the phone type, the description of the phone type appears corresponding to the Phone Type field.	Yes (Conditional) Note: This field is required while setting the field attributes for a template section.
Phone Number	Used to specify the phone number. Note: By default, this field is disabled. It is enabled when you specify the phone type in the Phone Type column.	Yes (Conditional) Note: This field is required while setting the field attributes for a template section.
Disable Phone Type	Used to indicate whether the phone type is disabled in the template section. Note: By default, the check box in the Disable Phone Type column is disabled. It is enabled when you specify the phone type in the Phone Type column.	Yes (Conditional) Note: This field is required while setting the field attributes for a template section.
Disable Phone Number	Used to indicate whether the specified phone number is disabled in the template section. Note: By default, the check box in the Disable Phone Number column is disabled. It is enabled when you specify the phone number in the Phone Number column.	Yes (Conditional) Note: This field is required while setting the field attributes for a template section.
Characteristic Information	Used to indicate the characteristic type and characteristic value for which you want to set attributes.	Yes (Conditional)

Field Name	Field Description	Mandatory (Yes or No)
	<p>Note:</p> <p>On specifying the characteristic type, the characteristic value field appears in the Characteristic Information column.</p> <p>On specifying a predefined characteristic type, the Search (🔍) icon appears corresponding to the characteristic value field. On clicking the Search icon, the Predefined Characteristic Search window appears.</p> <p>On specifying the value for a predefined characteristic type, the description of the characteristic value appears corresponding to the characteristic value field..</p>	<p>Note: This field is required while setting the field attributes for a template section.</p>
Disable Characteristic Type	<p>Used to indicate whether the characteristic type is disabled in the template section.</p> <p>Note: By default, the check box in the Disable Characteristic Type column is disabled. It is enabled when you specify the characteristic type in the Characteristic Type column.</p>	<p>Yes (Conditional)</p> <p>Note: This field is required while setting the field attributes for a template section.</p>
Disable Characteristic Value	<p>Used to indicate whether the characteristic is disabled in the template section.</p> <p>Note: By default, the check box in the Disable Characteristic Value column is disabled. It is enabled when you specify the characteristic value in the Characteristic Value column.</p>	<p>Yes (Conditional)</p> <p>Note: This field is required while setting the field attributes for a template section.</p>

- Enter the required details in the **Template Pages** section.
- If you want to set more than one field attribute for the template section, click the **Add** (+) icon and then repeat step 2.

Note: However, if you want to remove a field attribute from the template section, click the **Delete** (🗑️) icon corresponding to the field.

- Click **Save**.

The field attributes are set for the template section.

Related Topics

For more information on...	See...
Customer Registration Template screen	Customer Registration Template on page 78
How to define a customer registration template	Defining a Customer Registration Template on page 84

For more information on...	See...
How to edit a customer registration template	Editing a Customer Registration Template on page 96
How to copy a customer registration template	Copying a Customer Registration Template on page 97

Editing a Customer Registration Template

Prerequisites

To edit a customer registration template, you should have:

- Template categories defined in the application
- Template pages and sections defined in the application

Procedure

To edit a customer registration template:

1. Search for the customer registration template in the **Customer Registration Template** screen.
2. In the **Search Results** section, click the **Edit** (✎) icon in the **Edit** column corresponding to the customer registration template whose details you want to edit.

The **Customer Registration Template for Banking** or the **Customer Registration Template for Healthcare** screen appears depending upon the business object using which the customer registration template is defined. It contains the following sections:

- **Main** - Used to specify basic details about the customer registration template.
- **Template Pages** - Used to add template pages and its related sections for the customer registration template.
- **Main** - The **Main** section contains the following fields:

Field Name	Field Description	Mandatory (Yes or No)
Template	Displays the customer registration template.	Not applicable
Template Category	Used to indicate the category for which you want to define the customer registration template. The valid values are: <ul style="list-style-type: none"> • Account • Person • Policy • Policy Plan <p>Note: The Policy and Policy Plan options appear when you are defining a customer registration template using the C1-CustomerRegistrationTmplHC business object.</p>	Yes
Business Object	Indicates the business object using which the customer registration template is defined in the system.	Not applicable

Field Name	Field Description	Mandatory (Yes or No)
Description	Used to specify the description for the customer registration template.	Yes
Detailed Description	Used to specify additional information about the customer registration template.	No

Tip: Alternatively, you can edit the details of a customer registration template by clicking the **Edit** button in the **Customer Registration Template** zone.

3. Modify the details in the **Main** section, if required.
4. Add, edit, or remove the template pages and template sections from the customer registration template, if required.
5. Add, edit, or remove the field attributes from the template section, if required.
6. Click **Save**.

The changes made to the customer registration template are saved.

Note: You can edit a customer registration template only when a customer registration it is not yet defined using the customer registration template.

Related Topics

For more information on...	See...
Search Customer Registration Template zone	Search Customer Registration Template on page 79
Customer Registration Template screen	Customer Registration Template on page 78
Customer Registration Template zone	Customer Registration Template on page 81
How to add the pages and sections in a customer registration template	Adding the Pages and Sections in a Customer Registration Template on page 86
How to set the field attributes for a template section	Setting the Field Attributes for a Template Section on page 90

Copying a Customer Registration Template

Instead of creating a customer registration template from scratch, you can create a new customer registration template using an existing customer registration template. This is possible through copying a customer registration template. On copying a customer registration template, the details including the template pages, template sections, and field attributes for the template sections are copied to the new customer registration template. You can then edit the details, if required.

Prerequisites

To copy a customer registration template, you should have:

- Customer registration template (whose copy you want to create) defined in the application
- Template categories defined in the application
- Template pages and sections defined in the application

Procedure

To copy a customer registration template:

1. Search for the customer registration template in the **Customer Registration Template** screen.
2. In the **Search Results** section, click the **Duplicate**  icon in the **Duplicate** column corresponding to the customer registration template whose copy you want to create.

The **Customer Registration Template for Banking** or the **Customer Registration Template for Healthcare** screen appears depending upon the business object using which the customer registration template whose copy you want to create is defined. It contains the following sections:

- **Main** - Used to specify basic details about the customer registration template.
- **Template Pages** - Used to add template pages and its related sections for the customer registration template.
- **Main** - The **Main** section contains the following fields:

Field Name	Field Description	Mandatory (Yes or No)
Template	Used to specify the customer registration template.	Yes
Template Category	Used to indicate the category for which you want to define the customer registration template. The valid values are: <ul style="list-style-type: none"> • Account • Person • Policy • Policy Plan 	Yes
	Note: The Policy and Policy Plan options appear when you are defining a customer registration template using the C1-CustomerRegistrationTmplHC business object.	
Business Object	Indicates the business object using which the customer registration template is defined in the system.	Not applicable
Description	Used to specify the description for the customer registration template.	Yes
Detailed Description	Used to specify additional information about the customer registration template.	No

Tip: Alternatively, you can copy a customer registration template by clicking the **Duplicate** button in the **Customer Registration Template** zone.

3. Enter the required details in the **Main** section.
4. Add, edit, or remove the template pages and template sections from the customer registration template, if required.
5. Add, edit, or remove the field attributes from the template section, if required.
6. Click **Save**.

The new customer registration template is defined.

Related Topics

For more information on...	See...
Search Customer Registration Template zone	Search Customer Registration Template on page 79

For more information on...	See...
Customer Registration Template screen	Customer Registration Template on page 78
Customer Registration Template zone	Customer Registration Template on page 81
How to add the pages and sections in a customer registration template	Adding the Pages and Sections in a Customer Registration Template on page 86
How to set the field attributes for a template section	Setting the Field Attributes for a Template Section on page 90

Deleting a Customer Registration Template

Procedure

To delete a Customer Registration Template:

1. Search for the customer registration template in the **Customer Registration Template** screen.
2. In the **Search Results** section, click the **Delete** (🗑️) icon in the **Delete** column corresponding to the customer registration template that you want to delete.

A message appears confirming whether you want to delete the customer registration template.

3. Click **OK**.

The customer registration template is deleted.

Note: You can delete a customer registration template when a customer registration is not yet created using the customer registration template.

Tip: Alternatively, you can delete a customer registration template by clicking the **Delete** button in the **Customer Registration Template** zone.

Related Topics

For more information on...	See...
Customer Registration Template screen	Customer Registration Template on page 78
Search Customer Registration Template zone	Search Customer Registration Template on page 79
Customer Registration Template zone	Customer Registration Template on page 81

Customer Registration Type

A customer registration type encapsulates the following information:

- Users with a particular access group can only create a customer registration object using the customer registration type
- Whether the customer registration type can be used to create a customer registration object from the user interface, through the inbound message, or through the **File Upload Interface** utility
- Whether the approval is required when you create, edit, or delete a customer registration object
- Whether the final level approval is required once the approver at the first level approves the customer registration object
- Whether a To Do should be created indicating that the users have to manually create the billing hierarchy and pricing for the parent customer.

- The business objects using which the person, account, policy plan, membership, and address should be created when a customer registration object is created using the customer registration type
- A customer registration template which indicates the pages and sections that should appear when you are creating a customer registration object using the customer registration type. You can specify one customer registration template for person and one or more customer registration templates for account, policy, and policy plan.
- Information, such as person names, person identifiers, person phones, person characteristics, person addresses, person hierarchy, accounts, account identifiers, account characteristics, account auto pay information, account persons, account bill routing information, policies, policy plans, policy characteristics, or policy plan characteristics, which should be copied when you create a copy of a customer registration object which is created using the customer registration type.

Related Topics

For more information on...	See...
Customer Registration Type List zone	Customer Registration Type List on page 100
Customer Registration Type zone	Customer Registration Type on page 101
How to search for a customer registration type	Searching for a Customer Registration Type on page 107
How to view the details of a customer registration type	Viewing the Customer Registration Type Details on page 127
How to define a customer registration type	Defining a Customer Registration Type on page 108
How to edit a customer registration type	Editing a Customer Registration Type on page 121
How to copy a customer registration type	Copying a Customer Registration Type on page 124
How to delete a customer registration type	Deleting a Customer Registration Type on page 126

Customer Registration Type List

The **Customer Registration Type List** zone lists the customer registration types that are already defined in the system. It contains the following columns:

Column Name	Column Description
Customer Registration Type	Displays the customer registration type.
Description	Displays the description of the customer registration type.
Edit	On clicking the Edit (✎) icon, the Customer Registration Type screen appears where you can edit the details of the customer registration type.
Duplicate	On clicking the Duplicate (📄) icon, the Customer Registration Type screen appears where you can define a new customer registration type using an existing customer registration type.
Delete	On clicking the Delete (🗑) icon, you can delete the customer registration type.
	Note: You can delete a customer registration type when a customer registration is not yet defined using the customer registration type.

You can filter the list using various search criteria (such as, **Customer Registration Type** and **Description**) available in the **Filter** area. By default, the **Filter** area is hidden. You can view the **Filter** area by clicking the **Filters** (🔍) icon in the upper right corner of this zone.

On clicking the **Broadcast** (📡) icon corresponding to a customer registration type, the **Customer Registration Type** zone appears with the details of the respective customer registration type.

Note: Pagination is used to display limited number of records in this zone. You can use the navigation links, such as **Previous** and **Next** to navigate between pages.

Related Topics

For more information on...	See...
How to view the details of a customer registration type	Viewing the Customer Registration Type Details on page 127
How to edit a customer registration type	Editing a Customer Registration Type on page 121
How to copy a customer registration type	Copying a Customer Registration Type on page 124
How to delete a customer registration type	Deleting a Customer Registration Type on page 126

Customer Registration Type

The **Customer Registration Type** zone displays the details of the customer registration type. It contains the following sections:

- **Main** - Displays the basic information about the customer registration type. It contains the following fields:

Field Name	Field Description
Customer Registration Type	Displays the customer registration type.
Description	Displays the description of the customer registration type.
Customer Registration Business Object	<p>Indicates the business object using which the customer registration is created in the system. In addition, a context menu appears corresponding to this field which helps in navigating to other screens in the application. The valid values are:</p> <ul style="list-style-type: none"> • Customer Registration - Banking - Indicates customer registration is created using the C1-CustomerRegistrationBanking business object. • Customer Registration - Health Care - Indicates customer registration is created using the C1-CustomerRegistrationHC business object. <p>Note: It has a link. On clicking the link, the Business Object screen appears where you can view the details of the respective business object.</p>
Detailed Description	Displays additional information about the customer registration type.
Status	<p>Indicates the status of the customer registration type. The valid values are:</p> <ul style="list-style-type: none"> • Active • Inactive <p>Note: You cannot change the status of a customer registration type to Inactive when the corresponding customer registration is in a status other than Processed or Rejected.</p>
Access Group	Displays the user group that can access the customer registration created using the customer registration type.

Field Name	Field Description
	Note: It has a link. On clicking the link, the Access Group screen appears where you can view the details of the respective access group.
Registration Source	Indicates the source through which the customer registration is created using the customer registration type. The valid values are: <ul style="list-style-type: none"> • File Upload • Inbound Message • Manual

- **Additional Data** - Displays additional information about the customer registration type. It contains the following fields:

Field Name	Field Description
Approval Required	Indicates whether approval is required while creating the customer registration using the customer registration type.
Approval To Do Type	Indicates that the To Do entry of the specified To Do type is created when you submit the customer registration for approval. <p>Note: This field appears when the Approval Required check box is selected. It has a link. On clicking the link, the To Do Type screen appears with the details of the respective To Do type.</p>
Approval To Do Role	Indicates that users with the specified To Do role can only approve, reject, or resubmit the customer registration for approval. <p>Note: This field appears when the Approval Required check box is selected. It has a link. On clicking the link, the To Do Role screen appears with the details of the respective To Do role.</p>
Submitter To Do Type	Indicates the To Do entry of the specified To Do type is created when the customer registration is resubmitted by the approver. <p>Note: It has a link. On clicking the link, the To Do Type screen appears where you can view the details of the respective To Do type.</p>
Submitter To Do Role	Indicates the users with the specified To Do role for whom the To Do task is created when the customer registration is resubmitted by the approver. <p>Note: It has a link. On clicking the link, the To Do Role screen appears where you can view the details of the respective To Do role.</p>

Field Name	Field Description
Final Approval Required	<p>Indicates whether the final approval is required once the approver at the first level approves the customer registration.</p> <p>Note: This field appears when the Customer Registration Type is created using the C1-CustRegTypeHealthCare business object. The final approval is required when the Manual Billing Hierarchy and Pricing option check box is selected.</p>
Final Approval To Do Type	<p>Indicates that the To Do entry of the specified To Do type is created when you submit the customer registration for final approval.</p> <p>Note: It has a link. On clicking the link, the To Do Type screen appears with the details of the respective To Do type. This field appears when the Final Approval Required check box is selected.</p>
Final Approval To Do Role	<p>Indicates that users with the specified To Do role can only approve or resubmit the customer registration for final approval.</p> <p>Note: It has a link. On clicking the link, the To Do Role screen appears where you can view the details of the respective To Do role. This field appears when the Final Approval Required check box is selected.</p>
Manual Billing Hierarchy and Pricing	<p>Indicates whether the required bill groups for the parent customer, the bill group's accounts, pricing rules, bill group sorting information, and bill group derivation and pricing parameters are created manually by the user while defining the customer registration.</p> <p>Note: This field appears when the Customer Registration Type is created using the C1-CustRegTypeHealthCare business object. This feature is used only for customer registration objects where the person type is set to Parent Customer.</p>
Billing Hierarchy and Pricing To Do Type	<p>Indicates the To Do entry of the specified To Do type is created for the user to define or edit the billing hierarchy and pricing for the parent customer manually.</p> <p>Note: It has a link. On clicking the link, the To Do Type screen appears with the details of the respective To Do type. This field appears when the Manual Billing Hierarchy and Pricing check box is selected.</p>

Field Name	Field Description
Billing Hierarchy and Pricing To Do Role	Indicates users with the specified To Do role can only define or edit the billing hierarchy and pricing for the parent customer manually.
	<p>Note:</p> <p>It has a link. On clicking the link, the To Do Role screen appears where you can view the details of the respective To Do role.</p> <p>This field appears when the Manual Billing Hierarchy and Pricing check box is selected.</p>
Person Business Object	Indicates the business object using which the person is created while defining the customer registration.
	<p>Note: It has a link. On clicking the link, the Business Object screen appears where you can view the details of the respective business object.</p>
Account Business Object	Indicates the business object using which the account is created while defining the customer registration.
	<p>Note: It has a link. On clicking the link, the Business Object screen appears where you can view the details of the respective business object.</p>
Policy Plan Business Object	Indicates the business object using which the policy plan is created while defining the customer registration.
	<p>Note:</p> <p>It has a link. On clicking the link, the Business Object screen appears where you can view the details of the respective business object.</p> <p>This field appears when the Customer Registration Type is created using the C1-CustRegTypeHealthCare business object.</p>
Benefits Business Object	Indicates the business object using which the benefit is created while defining the customer registration.
	<p>Note: It has a link. On clicking the link, the Business Object screen appears where you can view the details of the respective business object.</p>
Membership Business Object	Indicates the business object using which the membership is created while defining the customer registration.
	<p>Note:</p> <p>It has a link. On clicking the link, the Business Object screen appears where you can view the details of the respective business object.</p> <p>This field appears when the Customer Registration Type is created using the C1-CustRegTypeHealthCare business object.</p>
Address Business Object	Indicates the business object using which the address is created while defining the customer registration.

Field Name	Field Description
	Note: It has a link. On clicking the link, the Business Object screen appears where you can view the details of the respective business object.
Statement Construct Business Object	Indicates the business object using which the statement construct is created while defining the customer registration.
	Note: It has a link. On clicking the link, the Business Object screen appears where you can view the details of the respective business object.

- **Characteristics** - Lists the characteristics defined for the customer registration type. It contains the following columns:

Column Name	Column Description
Characteristic Type	Indicates the characteristic type.
Characteristic Value	Displays the value of the characteristic type.

- **Customer Registration Templates** - Lists the templates that are associated with the customer registration type for creating a customer registration. It contains the following columns:

Column Name	Column Description
Sequence	Displays the sequence of the customer registration template.
Template Category	Indicates the category to which the customer registration template belongs. The valid values are: <ul style="list-style-type: none"> • Person • Account • Policy • Policy Plan
	Note: The Policy and Policy Plan template categories appear when the Customer Registration Type is created using the C1-CustRegTypeHealthCare business object.
Template	Displays the customer registration template associated with the customer registration type.
	Note: It has a link. On clicking the link, the Customer Registration Template screen appears where you can view the details of the respective customer registration template.

- **Record Actions** - The **Record Actions** section contains the following buttons:

Button Name	Button Description
Edit	Used to edit the details of the customer registration type.
Delete	Used to delete the customer registration type.
	Note: You can delete a customer registration type when a customer registration is not yet defined using the customer registration type.

Button Name	Button Description
Duplicate	Used to create a new customer registration type using an existing customer registration type.

- **Record Information** - The **Record Information** section contains the following field:

Field Name	Field Description
Business Object	Indicates the business object using which the customer registration type is created in the system. In addition, a context menu appears corresponding to this field which helps in navigating to other screens in the application.
	Note: It has a link. On clicking the link, the Business Object screen appears where you can view the details of the respective business object.

- **Copy Customer Registration Details** - Enables you to specify the type of information you want to copy while defining a customer registration using an existing customer registration. It contains the following fields:

Column Name	Column Description
Person Names	Indicates whether you want to copy the person details while copying a customer registration.
Accounts	Indicates whether you want to copy the account details while copying a customer registration.
Person Identifiers	Indicates whether you want to copy the person identifier details while copying a customer registration.
Account Identifiers	Indicates whether you want to copy the account identifier details while copying a customer registration.
Person Phones	Indicates whether you want to copy the phone details of the person while copying a customer registration.
Account Characteristics	Indicates whether you want to copy the characteristic details of the account while copying a customer registration.
Person Characteristics	Indicates whether you want to copy the characteristic details of the person while copying a customer registration.
Account Auto Pay Information	Indicates whether you want to copy the automatic payment details of the account while copying a customer registration.
Person Addresses	Indicates whether you want to copy the address details of the person while copying a customer registration.
Account Persons	Indicates whether you want to copy the details of the persons related to the account while copying a customer registration.
Person Hierarchy	Indicates whether you want to copy the person hierarchy details while copying a customer registration.
Account Override Address	Indicates whether you want to copy the account override address details while copying a customer registration.
Bill Routing Information	Indicates whether you want to copy the bill routing details of the account while copying a customer registration.
Credit Rating History	Indicates whether you want to copy the credit rating history details while copying a customer registration.

Column Name	Column Description
Policies	Indicates whether you want to copy the policy details while copying a customer registration.
	Note: This field appears when the Customer Registration Type is created using the C1-CustRegTypeHealthCare business object.
Policy Plans	Indicates whether you want to copy the policy plan details while copying a customer registration.
	Note: This field appears only when the Customer Registration Type is created using the C1-CustRegTypeHealthCare business object.
Policy Characteristics	Indicates whether you want to copy the policy characteristic details while copying a customer registration.
	Note: This field appears when the Customer Registration Type is created using the C1-CustRegTypeHealthCare business object.
Policy Plan Characteristics	Indicates whether you want to copy the policy plan characteristic details while copying a customer registration.
	Note: This field appears when the Customer Registration Type is created using the C1-CustRegTypeHealthCare business object.

By default, the **Customer Registration Type** zone does not appear in the **Customer Registration Type** screen. It appears when you click the **Broadcast** (📡) icon corresponding to a customer registration type in the **Customer Registration Type List** zone.

Related Topics

For more information on...	See...
How to define a customer registration type	Defining a Customer Registration Type on page 108
How to edit a customer registration type	Editing a Customer Registration Type on page 121
How to copy a customer registration type	Copying a Customer Registration Type on page 124
How to delete a customer registration type	Deleting a Customer Registration Type on page 126
How to view the details of a customer registration type	Viewing the Customer Registration Type Details on page 127

Searching for a Customer Registration Type

Prerequisites

To search for a customer registration type, you should have:

- Customer registration types defined in the application

Procedure

To search for a customer registration type:

1. Click the **Admin** link in the **Application** toolbar.
A list appears.
2. From the **Admin** menu, select **C** and then click **Customer Registration Type**.
A sub-menu appears.
3. Click the **Search** option from the **Customer Registration Type** sub-menu.
The **Customer Registration Type** screen appears with a list of customer registration types in the **Customer Registration Type List** zone.
4. Click the **Filters** (🔍) icon in the title bar of the **Customer Registration Type List** zone.
It contains the following fields:

Field Name	Field Description	Mandatory (Yes or No)
Customer Registration Type	Used to search for a particular customer registration type.	No
Description	Used to search for customer registration types having a particular description.	No

5. Enter the search criteria in the **Customer Registration Type List** zone.

Note: ORMB search engine supports wildcard search, where you can substitute the percentage (%) symbol as a stand in for any word or letter in a search criteria. You can use the ‘%’ wildcard character in all input fields except the date and ID fields. The ‘%’ wildcard character is suffixed automatically at the end of the partial search criteria. Therefore, you may or may not specify the wildcard character at the end of the partial search criteria. However, you have to prefix the wildcard character manually wherever required.

6. Click **Search**.

A list of customer registration types that meet the search criteria appears in the **Search Results** section.

Related Topics

For more information on...	See...
Customer Registration Type screen	Customer Registration Type on page 99
Customer Registration Type zone	Customer Registration Type on page 101

Defining a Customer Registration Type

Prerequisites

To define a customer registration type, you should have:

- Customer registration type business objects defined in the application
- Customer registration business objects defined in the application
- Access groups defined in the application
- Registration sources defined in the application
- Statement construct business object defined in the application
- Benefit business object defined in the application
- Person, account, policy plan, membership, and address business objects defined in the application

Note: The policy plan and membership business objects are required when you are defining a customer registration type using the **C1-CustRegTypeHealthCare** business object.

- Approval To Do types and To Do roles defined in the application
- Billing hierarchy and pricing To Do types and To Do roles defined in the application

Note: The billing hierarchy and pricing To Do types and To Do roles are required when you are defining a customer registration type using the **C1-CustRegTypeHealthCare** business object.

- Characteristic types defined in the application
- Template categories defined in the application

Procedure

To define a customer registration type:

1. Click the **Admin** link in the **Application** toolbar.
A list appears.
2. From the **Admin** menu, select **C** and then click **Customer Registration Type**.
A sub-menu appears.
3. Click the **Add** option from the **Customer Registration Type** sub-menu.

The **Select Business Object** screen appears. It contains the following field:

Field Name	Field Description	Mandatory (Yes or No)
Customer Registration Type Business Object	Used to indicate the business object using which you want to create the customer registration type. The valid values are: <ul style="list-style-type: none"> • Customer Registration Type - Banking • Customer Registration Type - Healthcare 	Yes

Tip: Alternatively, you can access the **Select Business Object** screen by clicking the **Add** button in the **Page Title** area of the **Customer Registration Type** screen.

Note: The **Select Business Object** screen appears when there are multiple customer registration type business objects defined in the application. If there is only one customer registration type business object defined in the application, the **Customer Registration Type** screen appears.

4. Select the required customer registration business object from the respective field.
5. Click **OK**.

The **Customer Registration Type** screen appears. It contains the following sections:

- **Main** - Used to specify basic details about the customer registration type.
- **Additional Data** - Used to define additional information about the customer registration type.
- **Characteristics** - Used to define a list characteristics for the customer registration type.
- **Customer Registration Templates** - Used to associate templates with the customer registration type.
- **Copy Customer Registration Details** - Used to specify the type of information you want to copy while defining a customer registration using an existing customer registration.
- **Main** - The **Main** section contains the following fields:

Field Name	Field Description	Mandatory (Yes or No)
Customer Registration Type	Used to specify the customer registration type.	Yes
Business Object	Indicates the business object using which you want to create the customer registration type.	Not applicable
Description	Used to specify the description for the customer registration type.	Yes
Customer Registration Business Object	Used to indicate the business object using which you want to create the customer registration in the system.	Yes
Detailed Description	Used to specify additional information about the customer registration type.	No
Status	Used to indicate the status of the customer registration type. <ul style="list-style-type: none"> • Active • Inactive 	Yes
Access Group	Used to specify the user group that can access the customer registration created using the customer registration type. <div style="border: 1px solid black; padding: 5px; margin-top: 10px;"> <p>Note:</p> <p>The Search (🔍) icon appears corresponding to the Access Group field. On clicking the Search icon, the Access Group Search window appears.</p> <p>On specifying the access group, the description of the access group appears corresponding to the Access Group field.</p> </div>	Yes
Registration Source	Used to indicate the source through which you want to create the customer registration in the system. The valid values are: <ul style="list-style-type: none"> • File Upload • Inbound Message • Manual 	Yes

6. Enter the required details in the **Main** section.
7. Define additional information about the customer registration type in the **Additional Data** section.
8. Define a list of characteristics for the customer registration type in the **Characteristics** section.
9. Associate customer registration templates with the customer registration type in the **Customer Registration Templates** section
10. Specify the type of information you want to copy while defining a customer registration using an existing customer registration in the **Copy Customer Registration Details** section.

11. Click Save.

The customer registration type is defined.

Related Topics

For more information on...	See...
Customer Registration Type screen	Customer Registration Type on page 99
How to define additional data for a customer registration type	Defining Additional Data for a Customer Registration Type on page 111
How to define a characteristic for a customer registration type	Defining a Characteristic for a Customer Registration Type on page 115
How to associate a customer registration template with a customer registration type	Associating a Customer Registration Template with a Customer Registration Type on page 116
How to set an attribute to define a customer registration using the existing customer registration	Setting Attributes to Define a Customer Registration Using the Existing Customer Registration on page 118

Defining Additional Data for a Customer Registration Type**Prerequisites**

To define additional data for a customer registration type, you should have:

- Person, account, policy plan, membership, and address business objects defined in the application

Note: The policy plan and membership business objects are required when you are defining, editing, or copying a customer registration type which is created using the **C1-CustRegTypeHealthCare** business object.

- Approval To Do types and To Do roles defined in the application
- Billing hierarchy and pricing To Do types and To Do roles defined in the application

Note: The billing hierarchy and pricing To Do types and To Do roles are required when you are defining, editing, or copying a customer registration type which is created using the **C1-CustRegTypeHealthCare** business object.

Procedure

To define additional data for a customer registration type:

1. Ensure that the **Additional Data** section is expanded when you are defining, editing, or copying a customer registration type.

The **Additional Data** section contains the following fields:

Field Name	Field Description	Mandatory (Yes or No)
Approval Required	Used to indicate whether approval is required while creating the customer registration using the customer registration type.	Yes (Conditional) Note: This field is required for approving the customer registration which is created using the customer registration type.
Approval To Do Type	Used to indicate the To Do entry of the specified To Do type is created when you submit the customer registration for approval.	Yes (Conditional)

Field Name	Field Description	Mandatory (Yes or No)
	<p>Note:</p> <p>The Search (🔍) icon appears corresponding to the Approval To Do Type field. On clicking the Search icon, the To Do Type Search window appears.</p> <p>On specifying the To Do type, the description of the To Do type appears corresponding to the Approval To Do Type field.</p> <p>This field appears when the Approval Required check box is selected.</p>	<p>Note: This field is required for approving the customer registration which is created using the customer registration type.</p>
Approval To Do Role	<p>Used to indicate the users with the specified To Do role can approve, reject, or resubmit the customer registration for approval.</p> <p>Note:</p> <p>This field appears when the Approval Required check box is selected.</p>	<p>Yes (Conditional)</p> <p>Note: This field is required for approving the customer registration which is created using the customer registration type.</p>
Submitter To Do Type	<p>Used to indicate the To Do entry of the specified To Do type is created when the customer registration is resubmitted by the approver.</p> <p>Note:</p> <p>The Search (🔍) icon appears corresponding to the Submitter To Do Type field. On clicking the Search icon, the To Do Type Search window appears.</p> <p>On specifying the To Do type, the description of the To Do type appears corresponding to the Submitter To Do Type field.</p>	<p>Yes (Conditional)</p> <p>Note: This field is required for resubmitting the customer registration for approval.</p>
Submitter To Do Role	<p>Used to indicate the users with the specified To Do role for whom the To Do task is created when the customer registration is resubmitted by the approver.</p>	<p>Yes (Conditional)</p> <p>Note: This field is required for resubmitting the customer registration for approval.</p>
Final Approval Required	<p>Used to indicate whether final approval is required once the approver at the first level approves the customer registration.</p>	<p>Yes (Conditional)</p> <p>Note: This field is required for approving the customer registration which is created using the customer registration type.</p>

Field Name	Field Description	Mandatory (Yes or No)
	<p>Note:</p> <p>This field appears when you are defining, editing, or copying a Customer Registration Type using the C1-CustRegTypeHealthCare business object.</p> <p>The final approval is required when the Manual Billing Hierarchy and Pricing option check box is selected.</p>	
Final Approval To Do Type	<p>Used to indicate the To Do entry of the specified To Do type is created when you submit the customer registration for final approval.</p> <p>Note:</p> <p>The Search (🔍) icon appears corresponding to the Final Approval To Do Type field. On clicking the Search icon, the To Do Type Search window appears.</p> <p>On specifying the To Do type, the description of the To Do type appears corresponding to the Final Approval To Do Type field.</p> <p>This field appears when the Final Approval Required check box is selected.</p>	<p>Yes (Conditional)</p> <p>Note: This field is required for final approval of the customer registration.</p>
Final Approval To Do Role	<p>Used to indicate the users with the specified To Do role can only approve or resubmit the customer registration for final approval.</p> <p>Note: This field appears when the Final Approval Required check box is selected.</p>	<p>Yes (Conditional)</p> <p>Note: This field is required for final approval of the customer registration.</p>
Manual Billing Hierarchy and Pricing	<p>Used to indicate whether the required bill groups for the parent customer, the bill group's accounts, pricing rules, bill group sorting information, and bill group derivation and pricing parameters are created manually by the user while defining the customer registration.</p> <p>Note:</p> <p>The Manual Billing Hierarchy and Pricing option can be used only for customer registrations where the person type is set to Parent Customer.</p> <p>This field appears when you are defining, editing, or copying a Customer Registration Type using the C1-CustRegTypeHealthCare business object.</p>	<p>Yes (Conditional)</p> <p>Note: This field is required for creating the billing hierarchy and pricing for the parent customer manually.</p>
Billing Hierarchy and Pricing To Do Type	<p>Used to indicate the To Do entry of the specified To Do type is created for the user to define or edit the billing hierarchy and pricing for the parent customer manually.</p>	<p>Yes (Conditional)</p>

Field Name	Field Description	Mandatory (Yes or No)
	<p>Note:</p> <p>The Search (🔍) icon appears corresponding to the Billing Hierarchy and Pricing To Do Type field. On clicking the Search icon, the To Do Type Search window appears.</p> <p>On specifying the To Do type, the description of the To Do type appears corresponding to the Billing Hierarchy and Pricing To Do Type field.</p> <p>This field appears when the Manual Billing Hierarchy and Pricing check box is selected.</p>	<p>Note: This field is required for creating the billing hierarchy and pricing for the parent customer manually.</p>
Billing Hierarchy and Pricing To Do Role	<p>Used to indicate the users with the specified To Do role can only define or edit the billing hierarchy and pricing for the parent customer manually.</p> <p>Note: This field appears when the Manual Billing Hierarchy and Pricing check box is selected.</p>	<p>Yes (Conditional)</p> <p>Note: This field is required for creating the billing hierarchy and pricing for the parent customer manually.</p>
Person Business Object	<p>Used to indicate the business object using which the customer registration for a person is created using the customer registration type.</p>	<p>Yes</p>
Account Business Object	<p>Used to indicate the business object using which the customer registration for an account is created using the customer registration type.</p>	<p>Yes</p>
Policy Plan Business Object	<p>Used to indicate the business object using which the customer registration for a policy plan is created using the customer registration type.</p> <p>Note: This field appears when you are defining, editing, or copying a Customer Registration Type using the C1-CustRegTypeHealthCare business object.</p>	<p>Yes</p>
Membership Business Object	<p>Used to indicate the business object using which the customer registration for a membership is created using the customer registration type.</p> <p>Note:</p> <p>The Membership Business Object is required for creating customer registrations through an Inbound Message.</p> <p>This field appears when you are defining, editing, or copying a Customer Registration Type using the C1-CustRegTypeHealthCare business object.</p>	<p>Yes</p>

Field Name	Field Description	Mandatory (Yes or No)
Benefits Business Object	Used to indicate the business object using which the customer registration for a benefit is created using the customer registration type.	No
Address Business Object	Used to indicate the business object using which the customer registration for an address is created using the customer registration type.	Yes
Statement Construct Business Object	Used to indicate the business object using which the customer registration for a statement construct is created using the customer registration type.	Yes

- Enter the required details in the **Additional Data** section.
- Click **Save**.

The additional data for the customer registration type is defined.

Related Topics

For more information on...	See...
How to define a customer registration type	Defining a Customer Registration Type on page 108
How to edit a customer registration type	Editing a Customer Registration Type on page 121
How to copy a customer registration type	Copying a Customer Registration Type on page 124

Defining a Characteristic for a Customer Registration Type

Prerequisites

To define a characteristic for a customer registration type, you should have:

- Characteristic types defined in the application (where the characteristic entity is set to **Customer Registration Type**)

Procedure

To define a characteristic for a customer registration type:

- Ensure that the **Characteristics** section is expanded when you are defining, editing, or copying a customer registration type.

The **Characteristics** section contains the following fields:

Field Name	Field Description	Mandatory (Yes or No)
Characteristic Type	Used to indicate the characteristic type.	Yes (Conditional)
	Note: The list includes only those characteristic types where the characteristic entity is set to Customer Registration Type .	Note: This field is required when you are defining a characteristic for the customer registration type.
Characteristic Value	Used to specify the value for the characteristic type.	Yes (Conditional)

Field Name	Field Description	Mandatory (Yes or No)
	<p>Note: If you select a predefined characteristic type, the Search (🔍) icon appears corresponding to the Characteristic Value field. On clicking the Search icon, the Predefined Characteristic Search window appears.</p> <p>On specifying the value for a predefined characteristic type, the description of the characteristic value appears corresponding to the Characteristic Value field.</p>	<p>Note: This field is required when you are defining a characteristic for the customer registration type.</p>

- Enter the required details in the **Characteristics** section.
- If you want to define more than one characteristic for the customer registration type, click the **Add** (+) icon and then repeat step 2.

Note: However, if you want to remove a characteristic from the customer registration type, click the **Delete** (🗑️) icon corresponding to the characteristic.

- Click **Save**.

The characteristic is defined for the customer registration type.

Related Topics

For more information on...	See...
How to define a customer registration type	Defining a Customer Registration Type on page 108
How to edit a customer registration type	Editing a Customer Registration Type on page 121
How to copy a customer registration type	Copying a Customer Registration Type on page 124

Associating a Customer Registration Template with a Customer Registration Type

Prerequisites

To associate a customer registration template with a customer registration type, you should have:

- Template categories defined in the application
- Customer registration templates associated to the template categories

Procedure

To associate a customer registration template with a customer registration type:

- Ensure that the **Customer Registration Templates** section is expanded when you are defining, editing, or copying a customer registration type.

The **Customer Registration Templates** section contains the following fields:

Field Name	Field Description	Mandatory (Yes or No)
Sequence	Used to specify the sequence for the customer registration template.	Yes (Conditional)

Field Name	Field Description	Mandatory (Yes or No)
		Note: This field is required when you are associating a customer registration template with a customer registration type.
Template Category	Used to indicate the category to which the customer registration template belongs. The valid values are: <ul style="list-style-type: none"> • Person • Account • Policy • Policy Plan 	Yes (Conditional)
	Note: The Policy and Policy Plan template categories appear when you are defining, editing, or copying a Customer Registration Type using the C1-CustRegTypeHealthCare business object. You can associate only one person template category and multiple account, policy, and policy plan template categories with the customer registration type.	Note: This field is required when you are associating a customer registration template with a customer registration type.
Template	Used to specify the customer registration template which you want to associate with the customer registration type.	Yes (Conditional)
	Note: The Search (🔍) icon appears corresponding to the Template field. On clicking the Search icon, the Customer Registration Template Search window appears. On specifying the template, the description of the template appears corresponding to the Template field.	Note: This field is required when you are associating a customer registration template with a customer registration type.

2. Enter the required details in the **Customer Registration Templates** section.
3. If you want to define more than one template for the customer registration type, click the **Add** (+) icon and then repeat step 2.

Note: However, if you want to remove a template from the customer registration type, click the **Delete** (🗑️) icon corresponding to the customer registration template.

4. Click **Save**.

The customer registration template is associated with the customer registration type.

Related Topics

For more information on...	See...
How to define a customer registration type	Defining a Customer Registration Type on page 108
How to edit a customer registration type	Editing a Customer Registration Type on page 121
How to copy a customer registration type	Copying a Customer Registration Type on page 124

Setting Attributes to Define a Customer Registration Using the Existing Customer Registration**Prerequisites**

To set an attribute for defining a customer registration using the existing customer registration, you should have:

- **Person** attributes defined in the application
- **Account** attributes defined in the application
- **Policy** attributes defined in the application

Note: The **Policy** attributes are required when you are defining a customer registration type using the **C1-CustRegTypeHealthCare** business object.

- **Policy Plan** attributes defined in the application

Note: The **Policy Plan** attributes are required when you are defining a customer registration type using the **C1-CustRegTypeHealthCare** business object.

Procedure

To set an attribute for defining a customer registration using the existing customer registration:

1. Ensure that the **Copy Customer Registration Details** section is expanded when you are defining, editing, or copying a customer registration type.

The **Copy Customer Registration Details** section contains the following fields:

Field Name	Field Description	Mandatory (Yes or No)
Person Names	Used to indicate whether you want to copy the person details while copying a customer registration.	No
Accounts	Used to indicate whether you want to copy the account details while copying a customer registration.	No
Person Identifiers	Used to indicate whether you want to copy the person identifier details while copying a customer registration.	No
Account Identifiers	Used to indicate whether you want to copy the account identifier details while copying a customer registration.	No
	Note: The check box of this field is enabled when the Accounts check box is selected in the Copy Customer Registration Details section.	

Field Name	Field Description	Mandatory (Yes or No)
Person Phones	Used to indicate whether you want to copy the phone details of the person while copying a customer registration.	No
Account Characteristics	Used to indicate whether you want to copy the characteristic details of the account while copying a customer registration. Note: The check box of this field is enabled when the Accounts check box is selected in the Copy Customer Registration Details section.	No
Person Characteristics	Used to indicate whether you want to copy the characteristic details of the person while copying a customer registration.	No
Account Auto pay Information	Used to indicate whether you want to copy the automatic payment details of the account while copying a customer registration. Note: The check box of this field is enabled when the Accounts check box is selected in the Copy Customer Registration Details section.	No
Person Addresses	Used to indicate whether you want to copy the address details of the person while copying a customer registration.	No
Account Persons	Used to indicate whether you want to copy the details of the persons related to the account while copying a customer registration. Note: The check box of this field is enabled when the Accounts check box is selected in the Copy Customer Registration Details section.	No
Person Hierarchy	Used to indicate whether you want to copy the person hierarchy details while copying a customer registration.	No
Account Override Address	Used to indicate whether you want to copy the account override address details while copying a customer registration. Note: The check box of this field is enabled when the Accounts check box is selected in the Copy Customer Registration Details section.	No
Bill Routing Information	Used to indicate whether you want to copy the bill routing details of the account while copying a customer registration.	No

Field Name	Field Description	Mandatory (Yes or No)
	<p>Note: The check box of this field is enabled when the Accounts check box is selected in the Copy Customer Registration Details section.</p>	
Credit Rating History	<p>Used to indicate whether you want to copy the credit rating history details while copying a customer registration.</p> <p>Note: The check box of this field is enabled when the Accounts check box is selected in the Copy Customer Registration Details section.</p>	No
Policies	<p>Used to indicate whether you want to copy the policy details while copying a customer registration.</p> <p>Note: This field appears only when you are defining, editing, or copying a Customer Registration Type using the C1-CustRegTypeHealthCare business object.</p>	No
Policy Plans	<p>Used to indicate whether you want to copy the policy plan details while copying a customer registration.</p> <p>Note: This field appears when you are defining, editing, or copying a Customer Registration Type using the C1-CustRegTypeHealthCare business object. The check box of this field is enabled only when the Policies check box is selected in the Copy Customer Registration Details section.</p>	No
Policy Characteristics	<p>Used to indicate whether you want to copy the policy characteristic details while copying a customer registration.</p> <p>Note: This field appears when you are defining, editing, or copying a Customer Registration Type using the C1-CustRegTypeHealthCare business object. The check box of this field is enabled only when the Policies check box is selected in the Copy Customer Registration Details section.</p>	No

Field Name	Field Description	Mandatory (Yes or No)
Policy Plan Characteristics	Used to indicate whether you want to copy the policy plan characteristic details while copying a customer registration.	No
	<p>Note:</p> <p>This field appears when you are defining, editing, or copying a Customer Registration Type using the C1-CustRegTypeHealthCare business object.</p> <p>The check box of this field is enabled when the Policy Plans check box is selected in the Copy Customer Registration Details section.</p>	

2. Select the required attributes in the **Copy Customer Registration Details** section.
3. Click **Save**.

The attributes are set for defining a customer registration using the existing customer registration.

Related Topics

For more information on...	See...
How to define a customer registration type	Defining a Customer Registration Type on page 108
How to edit a customer registration type	Editing a Customer Registration Type on page 121
How to copy a customer registration type	Copying a Customer Registration Type on page 124

Editing a Customer Registration Type

Prerequisites

To edit a customer registration type, you should have:

- Customer registration business objects defined in the application
- Access groups defined in the application
- Registration sources defined in the application
- Statement construct business object defined in the application
- Benefit business object defined in the application
- Person, account, policy plan, membership, and address business objects defined in the application

Note: The policy plan and membership business objects are required when you are editing a customer registration type which is created using the **C1-CustRegTypeHealthCare** business object.

- Approval To Do types and To Do roles defined in the application
- Billing hierarchy and pricing To Do types and To Do roles defined in the application

Note: The billing hierarchy and pricing To Do types and To Do roles are required when you are editing a customer registration type which is created using the **C1-CustRegTypeHealthCare** business object.

- Characteristic types defined in the application

- Template categories defined in the application

Procedure

To edit a customer registration type:

1. Search for the customer registration type in the **Customer Registration Type List** zone of the **Customer Registration Type** screen.
2. In the **Search Results** section, click the **Edit**  icon in the **Edit** column corresponding to the customer registration type whose details you want to edit.

The **Customer Registration Type** screen appears. It contains the following sections:

- **Main** - Used to specify basic details about the customer registration type.
- **Additional Data** - Used to define additional information about the customer registration type.
- **Characteristics** - Used to define a list characteristics for the customer registration type.
- **Customer Registration Templates** - Used to associate templates with the customer registration type.
- **Copy Customer Registration Details** - Used to specify the type of information you want to copy while defining a customer registration using an existing customer registration.
- **Main** - The **Main** section contains the following fields:

Field Name	Field Description	Mandatory (Yes or No)
Customer Registration Type	Displays the customer registration type.	Not applicable
Business Object	Indicates the business object using which the customer registration type is created in the system.	Not applicable
Description	Used to specify the description for the customer registration type.	Yes
Customer Registration Business Object	Used to indicate the business object using which you want to create the customer registration in the system.	Yes
Detailed Description	Used to specify additional information about the customer registration type.	No
Status	Used to indicate the status of the customer registration type. <ul style="list-style-type: none"> • Active • Inactive 	Yes
Access Group	Used to specify the user group that can access the customer registration created using the customer registration type.	Yes

Field Name	Field Description	Mandatory (Yes or No)
	<p>Note:</p> <p>The Search (🔍) icon appears corresponding to the Access Group field. On clicking the Search icon, the Access Group Search window appears.</p> <p>On specifying the access group, the description of the access group appears corresponding to the Access Group field.</p>	
Registration Source	<p>Used to indicate the source through which you want to create the customer registration in the system. The valid values are:</p> <ul style="list-style-type: none"> • File Upload • Inbound Message • Manual 	Yes

Tip: Alternatively, you can edit the details of a customer registration type by clicking the **Edit** button in the **Customer Registration Type** zone.

3. Modify the required details in the **Main** section, if required.
4. Modify additional information about the customer registration type in the **Additional Data** section, if required.
5. Define, edit, or remove characteristics of the customer registration type in the **Characteristics** section, if required.
6. Associate or disassociate customer registration templates from the customer registration type in the **Customer Registration Templates** section, if required.
7. Specify the type of information you want to copy while defining a customer registration using an existing customer registration in the **Copy Customer Registration Details** section, if required.
8. Click **Save**.

The changes made to the customer registration type are saved.

Related Topics

For more information on...	See...
How to search for a customer registration type	Searching for a Customer Registration Type on page 107
Customer Registration Type List zone	Customer Registration Type List on page 100
Customer Registration Type screen	Customer Registration Type on page 99
Customer Registration Type zone	Customer Registration Type on page 101
How to define additional data for a customer registration type	Defining Additional Data for a Customer Registration Type on page 111
How to define a characteristic for a customer registration type	Defining a Characteristic for a Customer Registration Type on page 115
How to associate a customer registration template with a customer registration type	Associating a Customer Registration Template with a Customer Registration Type on page 116

For more information on...	See...
How to set an attribute to define a customer registration using the existing customer registration	Setting Attributes to Define a Customer Registration Using the Existing Customer Registration on page 118

Copying a Customer Registration Type

Instead of creating a customer registration type from scratch, you can create a new customer registration type using an existing customer registration type. This is possible through copying a customer registration type. On copying a customer registration type, the details including the additional data, characteristics, customer registration templates, and attributes set to define a customer registration from the existing customer registration are copied to the new customer registration type. You can then edit the details, if required.

Prerequisites

To copy a customer registration type, you should have:

- Customer registration type (whose copy you want to create) defined in the application
- Customer registration business objects defined in the application
- Access groups defined in the application
- Registration sources defined in the application
- Statement construct business object defined in the application
- Benefit business object defined in the application
- Person, account, policy plan, membership, and address business objects defined in the application

Note: The policy plan and membership business objects are required when you are copying a customer registration type which is created using the **C1-CustRegTypeHealthCare** business object.

- Approval To Do types and To Do roles defined in the application
- Billing hierarchy and pricing To Do types and To Do roles defined in the application

Note: The billing hierarchy and pricing To Do types and To Do roles are required when you are copying a customer registration type which is created using the **C1-CustRegTypeHealthCare** business object.

- Characteristic types defined in the application
- Template categories defined in the application

Procedure

To copy a customer registration type:

1. Search for a customer registration type in the **Customer Registration Type List** zone of the **Customer Registration Type** screen.
2. In the **Search Results** section, click the **Duplicate**  icon in the **Duplicate** column corresponding to the customer registration type whose copy you want to create.

The **Customer Registration Type** screen appears. It contains the following sections:

- **Main** - Used to specify basic details about the customer registration type.
- **Additional Data** - Used to define additional information about the customer registration type.
- **Characteristics** - Used to define a list characteristics for the customer registration type.
- **Customer Registration Templates** - Used to associate templates with the customer registration type.
- **Copy Customer Registration Details** - Used to specify the type of information you want to copy while defining a customer registration using an existing customer registration.

- **Main** - The **Main** section contains the following fields:

Field Name	Field Description	Mandatory (Yes or No)
Customer Registration Type	Used to specify the customer registration type.	Yes
Business Object	Indicates the business object using which you want to create the customer registration type.	Not applicable
Description	Used to specify the description for the customer registration type.	Yes
Customer Registration Business Object	Used to indicate the business object using which you want to create the customer registration in the system.	Yes
Detailed Description	Used to specify additional information about the customer registration type.	No
Status	Used to indicate the status of the customer registration type. <ul style="list-style-type: none"> • Active • Inactive 	Yes
Access Group	Used to specify the user group that can access the customer registration created using the customer registration type. <div style="border: 1px solid black; padding: 5px; margin-top: 10px;"> <p>Note:</p> <p>The Search (🔍) icon appears corresponding to the Access Group field. On clicking the Search icon, the Access Group Search window appears.</p> <p>On specifying the access group, the description of the access group appears corresponding to the Access Group field.</p> </div>	Yes
Registration Source	Used to indicate the source through which you want to create the customer registration in the system. The valid values are: <ul style="list-style-type: none"> • File Upload • Inbound Message • Manual 	Yes

Tip: Alternatively, you can copy a customer registration type by clicking the **Duplicate** button in the **Customer Registration Type** zone.

3. Enter the required details in the **Main** section.
4. Enter additional information about the customer registration type in the **Additional Data** section.
5. Define, edit, or remove characteristics of the customer registration type in the **Characteristics** section.

6. Associate or disassociate customer registration templates from the customer registration type in the **Customer Registration Templates** section.
7. Specify the type of information you want to copy while defining a customer registration using an existing customer registration in the **Copy Customer Registration Details** section.
8. Click **Save**.

The new customer registration type is defined.

Related Topics

For more information on...	See...
How to search for a customer registration type	Searching for a Customer Registration Type on page 107
Customer Registration Type List zone	Customer Registration Type List on page 100
Customer Registration Type screen	Customer Registration Type on page 99
Customer Registration Type zone	Customer Registration Type on page 101
How to define additional data for a customer registration type	Defining Additional Data for a Customer Registration Type on page 111
How to define a characteristic for a customer registration type	Defining a Characteristic for a Customer Registration Type on page 115
How to associate a customer registration template with a customer registration type	Associating a Customer Registration Template with a Customer Registration Type on page 116
How to set an attribute to define a customer registration using the existing customer registration	Setting Attributes to Define a Customer Registration Using the Existing Customer Registration on page 118

Deleting a Customer Registration Type

Procedure

To delete a Customer Registration Type:

1. Search for the customer registration type in the **Customer Registration Type List** zone of the **Customer Registration Type** screen.
2. In the **Customer Registration Type List** zone, click the **Delete** (🗑️) icon in the **Delete** column corresponding to the customer registration type that you want to delete.

A message appears confirming whether you want to delete the customer registration type.

3. Click **OK**.

The customer registration type is deleted.

Note: You can delete a customer registration type when a customer registration is not yet defined using the customer registration type.

Tip: Alternatively, you can delete a customer registration type by clicking the **Delete** button in the **Customer Registration Type** zone.

Related Topics

For more information on...	See...
How to search for a customer registration type	Searching for a Customer Registration on page 137
Customer Registration Type List zone	Customer Registration Type List on page 100

For more information on...	See...
Customer Registration Type screen	Customer Registration Type on page 99
Customer Registration Type zone	Customer Registration Type on page 101

Viewing the Customer Registration Type Details

Procedure

To view the details of a customer registration type:

1. Search for the customer registration type in the **Customer Registration Type List** zone of the **Customer Registration Type** screen.
2. In the **Search Results** section, click the **Broadcast** () icon corresponding to the customer registration type whose details you want to view.

The **Customer Registration Type** zone appears.

3. View the details of the customer registration type in the **Customer Registration Type** zone.

Related Topics

For more information on...	See...
How to search for a customer registration type	Searching for a Customer Registration on page 137
Customer Registration Type List zone	Customer Registration Type List on page 100
Customer Registration Type screen	Customer Registration Type on page 99
Customer Registration Type zone	Customer Registration Type on page 101

Customer Registration (Used for Searching)

The **Customer Registration** screen allows you to search for a customer registration using various search criteria. It contains the following zone:

- [Search Customer Registration](#) on page 127

For more information on...	See...
How to view the details of a customer registration	Viewing the Customer Registration Details on page 138
How to define a customer registration	Defining a Customer Registration on page 139
How to copy a customer registration	Copying a Customer Registration on page 172

Search Customer Registration

The **Search Customer Registration** zone allows you to search for a customer registration using various search criteria. It contains the following two sections:

- **Search Criteria** - The **Search Criteria** section contains the following fields:

Field Name	Field Description	Mandatory (Yes or No)
Search By	Used to indicate whether you want to search for a customer registration using the customer registration details. The valid values are:	Yes

Field Name	Field Description	Mandatory (Yes or No)
	<ul style="list-style-type: none"> <li data-bbox="672 205 922 233">• Registration Details <div data-bbox="699 254 1154 363" style="border: 1px solid black; padding: 2px; margin: 2px 0;"> <p>Note: This option appears when you have access to the C1CREGSR application service.</p> </div> <li data-bbox="672 384 862 411">• Person Details <div data-bbox="699 432 1154 541" style="border: 1px solid black; padding: 2px; margin: 2px 0;"> <p>Note: This option appears when you have access to the C1CREGSR application service.</p> </div> <li data-bbox="672 562 980 590">• Inbound Message Details <div data-bbox="699 611 1154 720" style="border: 1px solid black; padding: 2px; margin: 2px 0;"> <p>Note: This option appears when you have access to the C1CTRGHC application service.</p> </div> <li data-bbox="672 741 919 768">• File Upload Details <div data-bbox="699 789 1154 898" style="border: 1px solid black; padding: 2px; margin: 2px 0;"> <p>Note: This option appears when you have access to the C1CREGSR application service.</p> </div> <div data-bbox="643 930 1151 993" style="border: 1px solid black; padding: 2px; margin-top: 10px;"> <p>Note: By default, the Registration Details option is selected.</p> </div>	
Customer Registration ID	<p data-bbox="643 1035 1151 1098">Used to search for a particular customer registration.</p> <div data-bbox="643 1119 1151 1228" style="border: 1px solid black; padding: 2px; margin-top: 5px;"> <p>Note: This field appears when you select the Registration Details option from the Search By list.</p> </div>	<p data-bbox="1172 1035 1365 1062">Yes (Conditional)</p> <div data-bbox="1172 1083 1466 1251" style="border: 1px solid black; padding: 2px; margin-top: 5px;"> <p>Note: This field is required for searching customer registrations using the customer registration details.</p> </div>
Created From	<p data-bbox="643 1287 1151 1350">Used to search customer registrations which are created from a particular date onwards.</p> <div data-bbox="643 1371 1151 1480" style="border: 1px solid black; padding: 2px; margin-top: 5px;"> <p>Note: This field appears when you select the Registration Details or Inbound Message Details options from the Search By list.</p> </div>	<p data-bbox="1172 1287 1365 1314">Yes (Conditional)</p> <div data-bbox="1172 1335 1466 1503" style="border: 1px solid black; padding: 2px; margin-top: 5px;"> <p>Note: This field is required for searching customer registrations using the customer registration or inbound message details.</p> </div>
User ID	<p data-bbox="643 1539 1151 1602">Used to search customer registration of a particular user.</p>	<p data-bbox="1172 1539 1365 1566">Yes (Conditional)</p> <div data-bbox="1172 1587 1466 1755" style="border: 1px solid black; padding: 2px; margin-top: 5px;"> <p>Note: This field is required for searching customer registrations using the customer registration or inbound message details.</p> </div>

Field Name	Field Description	Mandatory (Yes or No)
	<p>Note:</p> <p>The Search (🔍) icon appears corresponding to the User ID field. On clicking the Search icon, the User Search window appears where you can search for a particular user.</p> <p>This field appears when you select the Registration Details or Inbound Message Details options from the Search By list.</p>	
Created To	<p>Used to search customer registrations which are created till a particular date.</p> <p>Note: This field appears when you select the Registration Details or Inbound Message Details options from the Search By list.</p>	<p>Yes (Conditional)</p> <p>Note: This field is required for searching customer registrations using the customer registration or inbound message details.</p>
Status	<p>Used to search customer registrations with a particular status. The valid values are:</p> <ul style="list-style-type: none"> • Approval In Progress • Bill Group Approved • Complete • Draft • Draft for Update • Parent Customer Approved • Pending Final Approval • Pending Pricing Correction • Rejected <p>Note: The values listed above appear when the Registration Details option is selected from the Search By list.</p> <ul style="list-style-type: none"> • Pending • Processed • Rejected • Voided <p>Note: These values listed above appear when the Inbound Message Details option is selected from the Search By list.</p> <p>Note: The Status field appears when you select the Registration Details or Inbound Message Details options from the Search By list.</p>	<p>Yes (Conditional)</p> <p>Note: This field is required for searching customer registrations using the customer registration or inbound message details.</p>

Field Name	Field Description	Mandatory (Yes or No)
Customer Registration Type	Used to search customer registrations which are created using a particular customer registration type.	Yes (Conditional)
	Note: This field appears only when the Registration Details option is selected from the Search By list.	Note: This field is required for searching customer registrations using the customer registration details.
Division	Used to search customer registrations which belong to a particular division.	Yes (Conditional)
	Note: This field appears when the Person Details option is selected from the Search By list. You can view only those divisions to which you have access in the Division list.	Note: This field is required for searching customer registrations using the person details.
Person Name	Used to search customer registrations of persons with a particular name.	Yes (Conditional)
	Note: This field appears when the Person Details option is selected from the Search By list and the Advanced Search link available in the upper right corner of the Search Customer Registration zone is clicked.	Note: This field is required for searching customer registrations using the person details.
Person Type	Used to search customer registrations of persons which belong to a particular person type. The valid values are: <ul style="list-style-type: none"> • Bill Group • Broker • Business • Group • Parent Customer • Person 	Yes (Conditional)
	Note: This field appears when the Person Details option is selected from the Search By list and the Advanced Search link available in the upper right corner of the Search Customer Registration zone is clicked.	Note: This field is required for searching customer registrations using the person details.
Address	Used to search customer registrations of persons from a particular address.	Yes (Conditional)
		Note: This field is required for searching customer registrations using the person details.

Field Name	Field Description	Mandatory (Yes or No)
	Note: This field appears when the Person Details option is selected from the Search By list and the Advanced Search link available in the upper right corner of the Search Customer Registration zone is clicked.	
City	Used to search customer registrations from a particular city.	Yes (Conditional)
	Note: This field appears when the Person Details option is selected from the Search By list and the Advanced Search link available in the upper right corner of the Search Customer Registration zone is clicked.	Note: This field is required for searching customer registrations using the person details.
Phone Number	Used to search for a customer registration of a person having a particular phone number.	Yes (Conditional)
	Note: This field appears when the Person Details option is selected from the Search By list and the Advanced Search link available in the upper right corner of the Search Customer Registration zone is clicked.	Note: This field is required for searching customer registrations using the person details.
Person ID	Used to search customer registration of a particular person.	Yes (Conditional)
	Note: This field appears when the Person Details option is selected from the Search By list.	Note: This field is required for searching customer registrations using the person details.
Person Identifier Type	Used to indicate the person identifier type using which you want to search for customer registrations.	Yes (Conditional)
	Note: This field appears when the Person Details option is selected from the Search By list.	Note: If you enter the person identifier as a search criteria, you have to select the person identifier type. This field is required for searching customer registrations using the person details.
Person Identifier	Used to specify the value of the person identifier type using which you want to search for customer registrations.	Yes (Conditional)
	Note: This field appears when the Person Details option is selected from the Search By list.	

Field Name	Field Description	Mandatory (Yes or No)
		<p>Note:</p> <p>If you specify the person identifier type as a search criteria, you have to enter the person identifier.</p> <p>This field is required for searching customer registrations using the person details.</p>
Characteristic Type	<p>Used to search customer registrations of persons with a particular characteristic type.</p> <p>Note:</p> <p>The list includes only those characteristic types where the characteristic entity is set to Customer Registration.</p> <p>This field appears when the Person Details option is selected from the Search By list and the Advanced Search link available in the upper right corner of the Search Customer Registration zone is clicked.</p>	<p>Yes (Conditional)</p> <p>Note: This field is required for searching customer registrations using the person details.</p>
Characteristic Value	<p>Used to specify the value of the characteristic type using which you want to search customer registrations of persons.</p> <p>Note:</p> <p>If you select a predefined characteristic type, the Search (🔍) icon appears corresponding to the Characteristic Value field. On clicking the Search icon, the Predefined Characteristic Search window appears.</p> <p>On specifying the value for a predefined characteristic type, the description of the characteristic value appears corresponding to the Characteristic Value field.</p> <p>This field appears when the Person Details option is selected from the Search By list and the Advanced Search link available in the upper right corner of the Search Customer Registration zone is clicked.</p>	<p>Yes (Conditional)</p> <p>Note: This field is required for searching customer registrations using the person details.</p>
Inbound Message ID	Used to search for a customer registration which was created through a particular inbound message.	Yes (Conditional)

Field Name	Field Description	Mandatory (Yes or No)
	Note: This field appears only when the Inbound Message Details option is selected from the Search By list.	Note: This field is required for searching customer registrations using the inbound message details.
Source System	Used to search customer registrations whose information is received from a particular external system. Note: This field appears when the Inbound Message Details option is selected from the Search By list.	Yes (Conditional) Note: This field is required for searching customer registrations using the inbound message details.
External Source ID	Used to search for a customer registrations whose information is received from a particular external source system. Note: This field appears when the Inbound Message Details option is selected from the Search By list.	Yes (Conditional) Note: This field is required for searching customer registrations using the inbound message details.
External Transaction ID	Used to search for a customer registration which is created as a result of a particular transaction in the external source system. Note: This field appears when the Inbound Message Details option is selected from the Search By list.	Yes (Conditional) Note: This field is required for searching customer registrations using the inbound message details.
External Batch ID	Used to search customer registrations which are created through an external batch job. Note: This field appears when the Inbound Message Details option is selected from the Search By list.	Yes (Conditional) Note: This field is required for searching customer registrations using the inbound message details.
Inbound Message Type	Used to search customer registrations which are created using a particular inbound message type. Note: This field appears when the Inbound Message Details option is selected from the Search By list.	Yes (Conditional) Note: This field is required for searching customer registrations using the inbound message details.
Request Id	Used to search customer registrations which are created from a particular file uploaded through the File Upload Interface utility. Note: This field appears when the File Upload Details option is selected from the Search By list.	Yes (Conditional) Note: This field is required for searching customer registrations using the file upload details.
File Name	Used to search customer registrations created from uploading a file with a particular name.	Yes (Conditional)

Field Name	Field Description	Mandatory (Yes or No)
	Note: This field appears when the File Upload Details option is selected from the Search By list.	Note: This field is required for searching customer registrations using the file upload details.
File Status	Used to search customer registrations created from the uploaded files having a particular status. The valid values are: <ul style="list-style-type: none"> • Approval Pending • Completed • Error • Pending • Rejected 	Yes (Conditional) Note: This field is required for searching customer registrations using the file upload details.
	Note: This field appears when the File Upload Details option is selected from the Search By list.	
File Request Type	Used to search customer registrations which are created from the uploaded files with a particular file request type.	Yes (Conditional) Note: This field is required for searching customer registrations using the file upload details.
	Note: This field appears when the File Upload Details option is selected from the Search By list.	

Note: You must specify at least one search criterion while searching for a customer registration. One more search criterion is required when you are searching for a customer registration using the division and/or person type.

- **Search Results** - On clicking the **Search** button, the search results appear based on the specified search criteria. The **Search Results** section contains the following columns:

Column Name	Column Description
Creation Date Time	Displays the date and time when the customer registration is created in the system.
Customer Registration Information	Displays the concatenated string of information about the customer registration. Note: It has a link. On clicking the link, the Customer Registration screen appears where you can view the details of the respective customer registration.
Status	Indicates the status of the customer registration. The valid values are: <ul style="list-style-type: none"> • Approval In Progress • Bill Group Approved • Complete • Draft

Column Name	Column Description
	<ul style="list-style-type: none"> • Draft for Update • Parent Customer Approved • Pending Final Approval • Pending Pricing Correction • Rejected
	<p>Note: The values listed above appear when the Registration Details option is selected from the Search By list.</p>
	<ul style="list-style-type: none"> • Pending • Processed • Rejected • Voided
	<p>Note: These values listed above appear when the Inbound Message Details option is selected from the Search By list.</p>
Request Id	<p>Displays the request Id generated while uploading a file through the File Upload Interface utility for creating the customer registration object.</p> <p>Note: This column appears when the File Upload Details option is selected from the Search By list.</p>
Created By	<p>Displays the user who has created the customer registration.</p> <p>Note: This column appears when the Registration Details, Person Details, or Inbound Message Details options are selected from the Search By list.</p>
Inbound Message Information	<p>Displays the concatenated string of information about the inbound message.</p> <p>Note: It has a link. On clicking the link, the Inbound Message screen appears where you can view the details of the respective inbound message. This column appears when the Inbound Message Details option is selected from the Search By list.</p>
File ID	<p>Displays the file which is uploaded for creating the customer registration through the File Upload Interface utility.</p> <p>Note: This column appears when the File Upload Details option is selected from the Search By list.</p>
Copy	<p>On clicking the Copy  icon, the Customer Registration screen appears where you can define a new customer registration using an existing customer registration.</p>

Column Name	Column Description
	Note: This column appears when the Registration Details option is selected from the Search By list.
Person Name	Displays the name of the person for whom the customer registration is defined in the system. Note: This column appears when the Person Details option is selected from the Search By list.
Inbound Message Type	Indicates the inbound message type using which the inbound message is created in the system. Note: This column appears when the Inbound Message Details option is selected from the Search By list.
File Name	Displays the name of the file which is uploaded for creating the customer registration through the File Upload Interface utility. Note: This column appears when the File Upload Details option is selected from the Search By list.
Primary Person Identifier Type	Indicates the primary identifier type associated with the person. Note: This column appears when the Person Details option is selected from the Search By list.
Source System	Indicates the source system from where the inbound message is received for creating the customer registration. Note: This column appears when the Inbound Message Details option is selected from the Search By list.
Request Type	Indicates the request type using which the file is uploaded through the File Upload Interface utility for creating the customer registration. Note: This column appears only when the File Upload Details option is selected from the Search By list.
Primary Person Identifier	Displays the primary person identifier. Note: This column appears when the Person Details option is selected from the Search By list.

Note: Pagination is used to display limited number of records in the **Search Results** section. You can use the navigation links, such as **Previous** and **Next** to navigate between pages.

Related Topics

For more information on...	See...
How to search for a customer registration	Searching for a Customer Registration on page 137
Customer Registration screen	Customer Registration (Used for Searching) on page 127

Searching for a Customer Registration

Prerequisites

To search for a customer registration, you should have:

- Customer registration business objects defined in the application
- Customer registration statuses and customer registration types defined in the application
- Divisions associated with the access group to which the user belongs
- Person types and person identifier types defined in the application
- Characteristic types defined in the application (where the characteristic entity is set to **Customer Registration**)
- Inbound message statuses, inbound message types, and source systems defined in the application.
- File statuses and file request types defined in the application.

Procedure

To search for a customer registration:

1. Click the **Menu** link in the **Application** toolbar.
A list appears.
2. From the **Main** menu, select **Customer Management** and then click **Customer Registration**.
A sub-menu appears.
3. Click the **Search** option from the **Customer Registration** sub-menu.
The **Customer Registration** screen appears.
4. Enter the search criteria in the **Search Customer Registration** zone.

Note:

You must specify at least one search criterion while searching for a customer registration object. One more search criterion is required when you are searching for a customer registration using the division and/or person type.

The criteria are grouped as indicated by line separators between the criteria. Each group is independent from the other, and only one group is used at a time for searching. If you enter criteria in more than one group, the criteria from the former group is used for searching. For example, if you enter the person name (in the second criteria group) and person identifier (in the fourth criteria group), the system searches using the person name instead of the person identifier.

You must specify the division when you are searching for a customer registration of a person using the city.

You must specify division and/or any other criteria in the second group when you are searching for a customer registration using the person type.

If you have specified any other search criterion along with the person ID, the system ignores the additional search criterion and searches for the customer registration using the person ID.

ORMB search engine supports wildcard search, where you can substitute the percentage (%) symbol as a stand in for any word or letter in a search criteria. You can use the ‘%’ wildcard character in all input fields except the date and ID fields. The ‘%’ wildcard character is suffixed automatically at the end of the partial search criteria. Therefore, you may or may not specify the wildcard character at the end of the partial search criteria. However, you have to prefix the wildcard character manually wherever required.

The **Advanced Search** link appears in the right side of the **Search Customer Registration** zone. On clicking the **Advanced Search** link, additional fields appear in the zone which help you to refine the search.

If you select a predefined characteristic type, the **Search** (🔍) icon appears corresponding to the **Characteristic Value** field. On clicking the **Search** icon, you can search for a predefined characteristic value.

5. Click **Search**.

A list of customer registrations that meet the search criteria appears in the **Search Results** section.

Related Topics

For more information on...	See...
Customer Registration screen	Customer Registration (Used for Viewing) on page 175
Customer Registration zone	Customer Registration on page 176

Viewing the Customer Registration Details**Procedure**

To view the details of a customer registration:

1. Search for the customer registration in the **Customer Registration** screen.
2. In the **Search Results** section, click the link in the **Customer Registration Information** column corresponding to the customer registration whose details you want to view:

The **Customer Registration** screen appears.

3. Ensure that the **Main** tab is selected.
4. View the details of the customer registration in the **Customer Registration** zone.

Related Topics

For more information on...	See...
How to search for a customer registration	Searching for a Customer Registration on page 137
Customer Registration screen	Customer Registration (Used for Viewing) on page 175
Customer Registration zone	Customer Registration on page 176

Defining a Customer Registration

Prerequisites

To define a customer registration, you should have:

- Customer registration types, source systems, and person types defined in the application
- Divisions, customer segments, customer tiers, and access groups defined in the application
- Name types, phone types, and person identifier types defined in the application
- Address type codes and countries defined in the application
- Characteristic types defined in the application (where the characteristic entity is set to **Customer Registration**)
- Relationship types defined in the application
- Customer class, invoice currencies, account categories, bill cycles, accrual cycles, account identifier types, auto pay source codes, auto pay methods, auto pay route types, account relationship types, bill formats, address sources, bill route types, and collection class defined in the application

Note: The collection class is required when you are defining a customer registration using the **C1-CustomerRegistrationBanking** business object.

- Deal review frequencies and currency codes defined in the application

Note: These prerequisites are required when you are defining a customer registration using the **C1-CustomerRegistrationBanking** business object.

Procedure

To define a customer registration:

1. Click the **Menu** link in the **Application** toolbar.
A list appears.
2. From the **Main** menu, select **Customer Management** and then click **Customer Registration**.
A sub-menu appears.
3. Click the **Add** option from the **Customer Registration** sub-menu.

The **Add Customer Registration** screen appears. It contains the following fields:

Field Name	Field Description	Mandatory (Yes or No)
Customer Registration Type	Used to indicate the customer registration type using which you want to define the customer registration.	Yes
Source System	Used to indicate the external system from where the customer registration information is received.	No
Person Type	Used to indicate the type of person for whom you want to define the customer registration.	Yes

Tip: Alternatively, you can access the **Add Customer Registration** screen by clicking the **Add** button in the **Page Title** area of the **Customer Registration** screen.

4. Select the required **Customer Registration Type** from the respective field.
5. Select the required **Source System** from the respective field, if required.
6. Select the required **Person Type** from the respective field.
7. Click **OK**.

The **Customer Registration** screen appears. It contains the following pages:

- **Main** - Used to specify basic information about the person.
- **Contact** - Used to specify the contact information about the person.
- **Person Characteristics** - Used to define a list of characteristics for the person.
- **Hierarchy** - Used to define the person to person relationship for the person
- **Accounts** - Used to add the account details of the person.
- **Deal** - Used to specify information about the deals created for the person.

Note: This page appears only when you are defining a customer registration using the **C1-CustomerRegistrationBanking** business object.

- **Registration Characteristics** - Used to define a list of characteristics for the customer registration.

The **Main** page contains the following sections:

- **Main** - Used to specify basic details about the person.
- **Person Name** - Used to add the person names for customer registration.
- **Person Phones** - Used to add the person phone details for customer registration.
- **Person IDs** - Used to add the person identifiers for customer registration.

The **Main** section contains the following fields:

Field Name	Field Description	Mandatory (Yes or No)
Person Type	Indicates the person type using which you want to define the customer registration for the person.	Not applicable
Date of Birth	Used to specify the date when the person was born.	Yes
Division	Used to indicate the division to which the person belongs. Note: You can view only those divisions to which you have access in the Division list.	Yes
Person Since Date	Used to specify the date from when the person is the main customer.	Yes
Customer Segment	Used to indicate the customer segment to which the person belongs.	Yes

Field Name	Field Description	Mandatory (Yes or No)
	Note: This field appears when you are defining a customer registration using the C1-CustomerRegistrationBanking business object.	
Customer Tier	Used to indicate the customer tier of the customer segment to which the person belongs. Note: This field appears when you are defining a customer registration using the C1-CustomerRegistrationBanking business object.	Yes
Access Group	Used to indicate the user group that can access the customer registration. Note: The Search (🔍) icon appears corresponding to the Access Group field. On clicking the Search icon, the Access Group Search window appears. On specifying the access group, the description of the access group appears corresponding to the Access Group field.	Yes

8. Enter the required details in the **Main** section.
9. Add the names of the person in the **Person Names** section.
10. Add the phone details for the person in the **Person Phones** section.
11. Add the identifier details for the person in the **Person IDs** section.
12. Define the addresses of the person in the **Contact** page, if required.
13. Define a list of characteristics for the person in the **Person Characteristics** page, if required.
14. Define the person to person relationship for the person in the **Hierarchy** page, if required.
15. Add the account details of the person in the **Accounts** page, if required.
16. Add information about the deals created for the person in the **Deal** page, if required.

Note: This page appears when you are defining a customer registration using the **C1-CustomerRegistrationBanking** business object.

17. Define a list of characteristics for the customer registration in the **Registration Characteristics** page, if required.
18. Click **Validate and Save**.

The customer registration is defined.

Related Topics

For more information on...	See...
Customer Registration screen	Customer Registration (Used for Viewing) on page 175
How to add name of a person for customer registration	Adding the Names of a Person on page 142
How to add the phone details of a person for customer registration	Adding the Phone Details of a Person on page 143
How to add the identifier details of a person for customer registration	Adding the Identifier Details of a Person on page 144
How to add the contact details of a person for customer registration	Adding the Contact Details of a Person on page 145
How to define a characteristic for a person	Defining a Characteristic for a Person on page 148
How to define the hierarchy of a person	Defining a Person to Person Relationship for a Person on page 149
How to add an account for a person	Adding an Account for a Person on page 152
How to add a deal information for a person	Adding the Deal Information for a Person on page 165
How to define a characteristic for a customer registration	Defining a Characteristic for a Customer Registration on page 167

Adding the Names of a Person

Prerequisites

To add the names of a person, you should have:

- Name types defined in the application.

Procedure

To add the names of a person:

1. Ensure that the **Person Names** section is expanded in the **Main** page when you are defining, editing, or copying a customer registration.

The **Person Names** section contains the following columns:

Column Name	Column Description	Mandatory (Yes or No)
Name Type	Used to indicate the type of name which you want to add for the customer registration.	Yes (Conditional)
	Note: The list includes only those name types where the name type entity is set to Customer Registration .	Note: This field is required when you are adding a name for customer registration.
Name	Used to specify the name of the person.	Yes (Conditional)
		Note: This field is required when you are adding a name for customer registration.

2. Enter the required details in the **Person Names** section.

- If you want to add more than one person name for the customer registration, click the **Add (+)** icon and then repeat step 2.

Note: However, if you want to remove a person name from the customer registration, click the **Delete (🗑)** icon corresponding to the person name.

- Click **Validate and Save**.

The names are added for the person.

Related Topics

For more information on...	See...
How to define a customer registration	Defining a Customer Registration on page 139
How to edit a customer registration	Editing the Customer Registration Details on page 187
How to copy a customer registration	Copying a Customer Registration on page 172

Adding the Phone Details of a Person

Prerequisites

To add the phone details of a person, you should have:

- Phone types defined in the application.

Procedure

To add the phone details of a person:

- Ensure that the **Person Phones** section is expanded in the **Main** page when you are defining, editing, or copying a customer registration.

The **Person Phones** section contains the following columns:

Column Name	Column Description	Mandatory (Yes or No)
Phone Type	Used to indicate the type of the phone which you want to add for the person. The valid values are: <ul style="list-style-type: none"> Business Business Phone Fax Home Mobile 	Yes (Conditional)
		Note: This field is required when you are adding the phone details of a person.
Phone Number	Used to specify the phone number.	Yes (Conditional)
		Note: This field is required when you are adding the phone details of a person.

Column Name	Column Description	Mandatory (Yes or No)
Extension	Used to specify the extension value of the phone number.	Yes (Conditional)
		Note: This field is required when you are adding the phone details of a person.
Phone Format	Displays the format in which the phone number is specified for the person.	Not applicable

- Enter the required details in the **Person Phones** section.
- If you want to add more than one person phone for the customer registration, click the **Add (+)** icon and then repeat step 2.

Note: However, if you want to remove a person phone from the customer registration, click the **Delete (🗑)** icon corresponding to the person phone.

- Click **Validate and Save**.

The phone details are added for the person.

Related Topics

For more information on...	See...
How to define a customer registration	Defining a Customer Registration on page 139
How to edit a customer registration	Editing the Customer Registration Details on page 187
How to copy a customer registration	Copying a Customer Registration on page 172

Adding the Identifier Details of a Person

Prerequisites

To add the identifier details of a person, you should have:

- Person identifier types defined in the application.

Procedure

To add the identifier details of a person:

- Ensure that the **Person IDs** section is expanded in the **Main** page when you are defining, editing, or copying a customer registration.

The **Person IDs** section contains the following columns:

Column Name	Column Description	Mandatory (Yes or No)
Primary ID	Used to indicate whether the person identifier is primary or not.	Yes (Conditional)
		Note: This field is required while adding the identifier details of a person.
Person Identifier Type	Used to indicate the identifier type which you want to add for the person.	Yes (Conditional)

Column Name	Column Description	Mandatory (Yes or No)
	Note: The list includes only those person identifier types where the person identifier type entity is set to Customer Registration .	Note: This field is required while adding the identifier details of a person.
Person Identifier	Used to specify the value of the person identifier type.	Yes (Conditional) Note: This field is required while adding the identifier details of a person.
Identifier Format	Displays the format in which the person identifier is specified for the person.	Not applicable

- Enter the required details in the **Person IDs** section.
- If you want to add more than one person identifier for the person, click the **Add (+)** icon and then repeat step 2.

Note: However, if you want to remove a person identifier from the person, click the **Delete (🗑)** icon corresponding to the person identifier.

- Click **Validate and Save**.

The identifier details are added for the person.

Related Topics

For more information on...	See...
How to define a customer registration	Defining a Customer Registration on page 139
How to edit a customer registration	Editing the Customer Registration Details on page 187
How to copy a customer registration	Copying a Customer Registration on page 172

Adding the Contact Details of a Person

Prerequisites

To add the contact details of a person, you should have:

- Address type codes and countries defined in the application.

Procedure

To add the contact details of a person:

- Ensure that the **Person Addresses** section in the **Contact** page is expanded when you are defining, editing, or copying a customer registration.

The **Person Addresses** section contains the following fields:

Field Name	Field Description	Mandatory (Yes or No)
Address Type Code	Used to indicate the type of address that you want to add for the person.	Yes

Field Name	Field Description	Mandatory (Yes or No)
	Note: The list includes only those address type codes where the address type code entity is set to Customer Registration .	
Effective Date	Used to specify the date from when the address is effective for the person.	Yes
Season	Used to specify the season for which the address is effective for the person. Note: This field appears when you select the Person Seasonal option from the Address Type Code field.	Yes (Conditional) Note: This field is required while adding the seasonal contact details of a person.
Country	Used to indicate the country where the person is located. Note: The list includes only those countries which are already defined in the system. On selecting a country, only those address fields which are set as Optional while defining the country appear in the Person Addresses section. Also, the labels of the address fields will change depending on the business label which is defined for the respective address field in the Country screen.	Yes
Address 1	Used to specify the first line of the address. It may contain details, such as house number and apartment name.	No
Address 2	Used to specify the second line of the address. It may contain details, such as street name.	No
City	Used to specify the city name.	No
Address 3	Used to specify the third line of the address. It may contain the landmark details.	No
County	Used to specify the county name.	No
State	Used to indicate the state where the city or county is located. Note: The states listed in this field change depending on the country that you have selected.	No
Province	Used to specify the location within the country where the person is located.	No
Address 4	Used to specify the fourth line of the address.	No

Field Name	Field Description	Mandatory (Yes or No)
Postal	Used to specify the postal or zip code of the address.	No
House Type	Used to indicate the type of the house.	No
	Note: The list includes only those values which are defined in the HOUSE_TYPE lookup field.	
In City Limit	Used to indicate whether the address is within the city limit. The valid values are: <ul style="list-style-type: none"> • Yes • No 	No
Geographic Code	Used to specify the geographic code of the address.	No

Note: The above mentioned fields appear in the **Person Addresses** section when the respective data is available for the person.

In addition, the **Person Addresses** section contains the following fields:

Field Name	Field Description	Mandatory (Yes or No)
Override Mailing Name - Name1	Used to specify the name using which you want to override the person's mailing name.	Yes (Conditional)
		Note: This field is required while overriding the persons contact name.
Override Mailing Name - Name2	Used to specify the name using which you want to override the person's override mailing name 1.	Yes (Conditional)
		Note: This field is required while overriding the persons Override Mailing Name - Name1 .
Override Mailing Name - Name3	Used to specify the name using which you want to override the person's override mailing name 2.	Yes (Conditional)
		Note: This field is required while overriding the persons Override Mailing Name - Name2 .
Email Address	Used to specify the email address of the person.	No

- Enter the required details in the **Person Addresses** section.
- If you want to add more than one contact details of the person, click the **Add (+)** icon in the upper right corner of this section and then repeat step 2.

Note: However, if you want to remove the contact details of the person, click the **Delete (🗑)** icon in the upper right corner of this section.

4. Click **Validate and Save**.

The contact details are added for the person.

Related Topics

For more information on...	See...
How to define a customer registration	Defining a Customer Registration on page 139
How to edit a customer registration	Editing the Customer Registration Details on page 187
How to copy a customer registration	Copying a Customer Registration on page 172

Defining a Characteristic for a Person

Prerequisites

To define a characteristic for a person, you should have:

- Characteristic types defined in the application (where the characteristic entity is set to **Customer Registration**)

Procedure

To define a characteristic for a person:

1. Ensure that the **Characteristics** section is expanded in the **Person Characteristics** page when you are defining, editing, or copying a customer registration.

The **Characteristics** section contains the following columns:

Field Name	Field Description	Mandatory (Yes or No)
Effective Date	Used to specify the date from when the characteristic is effective for the person.	Yes (Conditional)
		Note: This field is required while defining a characteristic for the person.
Characteristic Type	Used to indicate the characteristic type. Note: The list includes only those characteristic types where the characteristic entity is set to Customer Registration .	Yes (Conditional)
		Note: This field is required while defining a characteristic for the person.
Characteristic Value	Used to specify the value for the characteristic type. Note: If you select a predefined characteristic type, the Search (🔍) icon appears corresponding to the Characteristic Value field. On clicking the Search icon, the Predefined Characteristic Search window appears. On specifying the value for a predefined characteristic type, the description of the characteristic value appears corresponding to the Characteristic Value field.	Yes (Conditional)
		Note: This field is required while defining a characteristic for the person.

2. Enter the required details in the **Characteristics** section.

- If you want to define more than one characteristic for the person, click the **Add (+)** icon and then repeat step 2.

Note: However, if you want to remove a characteristic from the person, click the **Delete (🗑)** icon corresponding to the characteristic.

- Click **Validate and Save**.

The characteristic is defined for the person.

Related Topics

For more information on...	See...
How to define a customer registration	Defining a Customer Registration on page 139
How to edit a customer registration	Editing the Customer Registration Details on page 187
How to copy a customer registration	Copying a Customer Registration on page 172

Defining a Person to Person Relationship for a Person

Prerequisites

To define a person to person relationship for a person, you should have:

- Relationship types defined in the application (where the relationship entity is set to **Customer Registration**)

Procedure

To define a person to person relationship for a person:

- Ensure that the **Related Person Information** section is expanded in the **Hierarchy** page when you are defining, editing, or copying a customer registration.

The **Related Person Information** section contains the following columns:

Column Name	Column Description	Mandatory (Yes or No)
Related Person ID	Used to indicate the person with whom you want to define the person to person relationship of the main customer.	Yes (Conditional)
	<p>Note:</p> <p>The Search (🔍) icon appears corresponding to the Related Person ID field. On clicking the Search icon, the Person Search window appears.</p> <p>On specifying the person, the description of the person appears corresponding to the Related Person ID field.</p>	<p>Note: This field is required while defining a person to person relationship for a person.</p>
Parent/Child	Used to indicate whether the related person is a parent or a child. The valid values are: <ul style="list-style-type: none"> Parent Child 	Yes (Conditional)
		<p>Note: This field is required while defining a person to person relationship for a person.</p>
Relationship Type	Used to indicate the person to person relationship type.	Yes (Conditional)

Column Name	Column Description	Mandatory (Yes or No)
	Note: The list includes only those relationship types where the relationship entity is set to Customer Registration .	Note: This field is required while defining a person to person relationship for a person.
Start Date	Used to indicate the date from when the person to person relationship is effective. Note: The start date cannot be later than the end date.	Yes (Conditional) Note: This field is required while defining a person to person relationship for a person.
End Date	Used to indicate the date till when the person to person relationship is effective. Note: The end date cannot be earlier than the start date.	No
Financial Relationship	Used to indicate whether the related person is financially responsible or not.	Yes (Conditional) Note: This field is required while defining a person to person relationship for a person.
Characteristics	On clicking the Add (+) icon, you can define a list of characteristics for the person to person relationship.	No

- Enter the required details in the **Related Person Information** section.
- If you want to define more than one person to person relationship for the person, click the **Add** (+) icon and then repeat step 2.

Note: However, if you want to remove a person to person relationship from the person, click the **Delete** (🗑️) icon corresponding to the related person.

- Click **Validate and Save**.

The person to person relationship is defined for the person.

Related Topics

For more information on...	See...
How to define a customer registration	Defining a Customer Registration on page 139
How to edit a customer registration	Editing the Customer Registration Details on page 187
How to copy a customer registration	Copying a Customer Registration on page 172

Defining a Characteristic for a Person to Person Relationship

Prerequisites

To define a characteristic for a person to person relationship, you should have:

- Characteristic types defined in the application (where the characteristic entity is set to **Person Relationship**)

Procedure

To define a characteristic for a person to person relationship:

1. Ensure that the **Related Person Information** section is expanded in the **Hierarchy** page when you are defining, editing, or copying a customer registration.
2. Click the **Add** (+) icon in the **Characteristics** column corresponding to the related person.

The following columns appear in the **Related Person Information** section.

Column Name	Column Description	Mandatory (Yes or No)
Effective Date	Used to specify the date from when the characteristic is effective for the person to person relationship.	Yes (Conditional)
		Note: This field is required while defining a characteristic for the person to person relationship.
Characteristic Type	Used to indicate the characteristic type. Note: The list includes only those characteristic types where the characteristic entity is set to Person Relationship .	Yes (Conditional)
		Note: This field is required while defining a characteristic for the person to person relationship.
Characteristic Value	Used to specify the value for the characteristic type. Note: If you select a predefined characteristic type, the Search (🔍) icon appears corresponding to the Characteristic Value field. On clicking the Search icon, the Predefined Characteristic Search window appears. On specifying the value for a predefined characteristic type, the description of the characteristic value appears corresponding to the Characteristic Value field.	Yes (Conditional)
		Note: This field is required while defining a characteristic for the person to person relationship.

3. Enter the required details in the **Related Person Information** section.
4. If you want to define more than one characteristic for the person to person relationship, click the **Add** (+) icon and then repeat step 2.

Note: However, if you want to remove a characteristic from the person to person relationship, click the **Delete** (🗑️) icon corresponding to the characteristic.

5. Click **Validate and Save**.

The characteristic is defined for the person to person relationship.

Related Topics

For more information on...	See...
How to define a customer registration	Defining a Customer Registration on page 139
How to edit a customer registration	Editing the Customer Registration Details on page 187
How to copy a customer registration	Copying a Customer Registration on page 172
How to define a person to person relationship for a person	Defining a Person to Person Relationship for a Person on page 149

Adding an Account for a Person**Prerequisites**

To add the account for a person, you should have:

- Customer class, divisions, currencies, account categories, access groups, accrual cycles, and bill cycles defined in the application
- Account identifier types defined in the application
- Auto pay source codes, auto pay methods, and auto pay route types defined in the application
- Account relationship types defined in the application
- Address sources, bill formats, and bill route types defined in the application
- Characteristic types defined in the application (where the characteristic entity is set to **Account**)
- Collection class defined in the application

Note: The collection class is required when you are defining a customer registration using the **C1-CustomerRegistrationBanking** business object.

Procedure

To add an account for a person:

1. Ensure that the **Accounts** section is expanded in the **Accounts** page when you are adding, editing, or removing an account of a person.

The **Accounts** section contains the following columns:

Column Name	Column Description	Mandatory (Yes or No)
Sequence No.	Displays the sequence number of the account.	Not applicable
Template	Displays the account template using which the account is added for the person.	Not applicable
Customer Class	Indicates the customer class to which the account belongs.	Not applicable
Division	Indicates the division to which the account belongs.	Not applicable
Primary Identifier Type	Indicates the primary identifier type using which the account is added for the person.	Not applicable
Identifier Value	Displays the value of the primary identifier type.	Not applicable

Column Name	Column Description	Mandatory (Yes or No)
Account Information	Displays the concatenated string of information about the account that is added for the person.	Not applicable
View / Edit	On clicking the View / Edit (✎) icon, you can view or edit the details of the account.	Not applicable

Note: No information appears in the above columns if an account is not yet added for the person.

- Click the **Add New Account** button in the **Accounts** section.

The **Customer Registration - Add Account** screen appears. It contains the following pages:

- **Main** - Used to specify basic information about the account.
- **Auto Pay** - Used to add the automatic payment details of the account.
- **Persons** - Used to associate a person to the account.
- **Account Characteristics** - Used to define a list of characteristics for the account.
- **Credit Ratings** - Used to add the credit rating details for the account.

Note: This page appears when you are defining a customer registration using the **C1-CustomerRegistrationBanking** business object.

The **Main** page contains the following sections:

- **Main** - Used to specify basic details about the account.
- **Account Identifiers** - Used to add the identifier details for the account.

The **Main** section contains the following fields:

Field Name	Field Description	Mandatory (Yes or No)
Customer Class	Used to indicate the customer class to which the account belongs.	Yes
Division	Used to indicate the division to which the account belongs.	Yes
	Note: You can only view those divisions to which you have access in the Division list.	
Set Up Date	Used to specify the date from when the account is configured for the person.	Yes
	Note: By default, the current date appears in this field.	
Invoice Currency	Used to indicate the currency which you want to use for generating the invoice of the account.	Yes
	Note: The list includes only those currencies which are defined in the system.	
Account Category	Used to indicate the category to which the account belongs. The valid values are:	Yes

Field Name	Field Description	Mandatory (Yes or No)
	<ul style="list-style-type: none"> • Invoice Account • Settlement Account • Usage Account <p>Note: The list includes only those values which are present in the ACCT_USAGE_FLG lookup field.</p>	
Access Group	<p>Used to indicate the user group that can access the account for the person.</p> <p>Note:</p> <p>The Search (🔍) icon appears corresponding to the Access Group field. On clicking the Search icon, the Access Group Search window appears.</p> <p>On specifying the access group, the description of the access group appears corresponding to the Access Group field.</p>	Yes
Exclude Accrual	<p>Used to indicate whether the account is eligible for accrual.</p> <p>Note: By default, the account is eligible for accrual if the division to which the account belongs is eligible for accrual. If you do not want the account to be eligible for accrual, you must select the Exclude Accrual check box. On selecting the Exclude Accrual check box, the Accrual Cycle field is disabled.</p>	No
Accrual Cycle	<p>Used to indicate the accrual cycle of the account in the division.</p> <p>Note:</p> <p>The Search (🔍) icon appears corresponding to the Accrual Cycle field. On clicking the Search icon, the Accrual Cycle Search for Cust Reg window appears.</p> <p>On specifying the accrual cycle, the description of the accrual cycle appears corresponding to the Accrual Cycle field.</p> <p>This field is disabled when you click the Exclude Accrual check box.</p>	No
Product	Used to indicate the product for which the account is enrolled.	Yes (Conditional)

Field Name	Field Description	Mandatory (Yes or No)
	<p>Note:</p> <p>The Search (🔍) icon appears corresponding to the Product field. On clicking the Search icon, the Search Product window appears.</p>	<p>Note: This field is required while enrolling an account for a product.</p>
Eligible for Repricing	<p>Used to indicate whether the account is eligible for repricing when the account attributes (defined as parameters in the system) are changed.</p> <p>Note:</p> <p>Only accounts where the person and child person are the main customers are considered for repricing.</p> <p>The system creates the repricing request for the account irrespective of whether the account is eligible for repricing or not.</p>	No
Bill Cycle	Used to indicate the bill cycle for the account.	No
Bill Lead Days	<p>Used to specify the number of days which is used to derive the cut-off date for advance billing.</p> <p>Note: In case you don't want to bill the account in advance, you must specify 0 in this field.</p>	Yes
Comments	Used to specify additional information about the account.	No

3. Enter the required details in the **Main** section.
4. Add, edit, or remove the identifier details of the account in the **Account Identifiers** section.
5. Add, edit, or remove the automatic payment details of the account in the **Auto Pay** page, if required.
6. Associate or disassociate persons from the account in the **Persons** page, if required.
7. Define, edit, or remove characteristics of the account in the **Account Characteristics** page, if required.
8. Add, edit, or remove the credit rating details of the account in the **Credit Ratings** page, if required.
9. Click **Validate and Save**.

The account is added for the person.

Related Topics

For more information on...	See...
How to define a customer registration	Defining a Customer Registration on page 139
How to edit a customer registration	Editing the Customer Registration Details on page 187
How to copy a customer registration	Copying a Customer Registration on page 172

For more information on...	See...
How to add the identifier details of an account	Adding the Identifier Details of an Account on page 156
How to add the automatic payment details of an account	Adding the Automatic Payment Details of an Account on page 157
How to associate a person to an account	Associating a Person to an Account on page 159
How to define a characteristic for an account	Defining a Characteristic for an Account on page 162
How to add the credit rating details for an account	Adding the Credit Rating Details for an Account on page 164

Adding the Identifier Details of an Account

Prerequisites

To add the identifier details of an account, you should have:

- Account identifier types defined in the application.

Procedure

To add the identifier details of an account:

- Ensure that the **Account Identifiers** section is expanded in the **Customer Registration - Add Account** screen when you are adding or editing the account of a person.

The **Account Identifiers** section contains the following columns:

Column Name	Column Description	Mandatory (Yes or No)
Primary ID	Used to indicate whether the account identifier is primary or not.	Yes
Account Identifier Type	Used to indicate the identifier type for the account.	Yes (Conditional) Note: This field is required while adding an account identifier.
Primary Account Identifier	Used to specify the primary account identifier for the account identifier type.	Yes (Conditional) Note: This field is required while adding an account identifier.

Note: You must specify at least one primary identifier while adding an account for a person.

- Enter the required details in the **Account Identifiers** section.
- If you want to add more than one account identifier for the account, click the **Add (+)** icon and then repeat step 2.

Note: However, if you want to remove an account identifier from the account, click the **Delete (🗑)** icon corresponding to the account identifier type.

- Click **Validate and Save**.

The identifier details are added for the account.

Related Topics

For more information on...	See...
How to define a customer registration	Defining a Customer Registration on page 139
How to edit a customer registration	Editing the Customer Registration Details on page 187
How to copy a customer registration	Copying a Customer Registration on page 172
How to add an account for a person	Adding an Account for a Person on page 152
How to edit the account details of a person	Editing the Account Details of a Person on page 169

Adding the Automatic Payment Details of an Account

Prerequisites

To add the automatic payment details of an account, you should have:

- Auto pay source codes, auto pay methods, and auto pay route types defined in the application

Procedure

To add the automatic payment details of an account:

1. Ensure that the **Auto Pay** page is expanded in the **Customer Registration - Add Account** screen when you are adding or editing the account of a person.

The **Auto Pay** page contains the following fields:

Field Name	Field Description	Mandatory (Yes or No)
Defer Auto Pay Date	Used to indicate the date till when you want to hold the automatic payment process of the account.	Yes (Conditional) Note: This field is required while adding the automatic payment details of the account
Rule Based Auto Pay	Used to indicate whether the automatic payment is rule based.	Yes (Conditional) Note: This field is required while adding the automatic payment details of the account
Start Date	Used to indicate the date from when the automatic payment is effective for the account. Note: The start date cannot be later than the end date.	Yes (Conditional) Note: This field is required while adding the automatic payment details of the account
End Date	Used to indicate the date till when the automatic payment is effective for the account. Note: The end date cannot be earlier than the start date.	No

Field Name	Field Description	Mandatory (Yes or No)
Percentage	Used to specify the contribution of payment amount in percentage within multiple Auto Pay IDs (i.e for Auto Pay Source Codes) having the same priority.	Yes (Conditional) Note: This field is required while adding the automatic payment details of the account
Priority	Used to specify the order in which the automatic payment option is considered for the effective date range.	Yes (Conditional) Note: This field is required while adding the automatic payment details of the account
Auto Pay Source Code	Used to indicate the financial institution that receives the automatic payment request. Note: The Search (🔍) icon appears corresponding to the Auto Pay Source Code field. On clicking the Search icon, the Auto Pay Source Search window appears. On specifying the auto pay source code, the description of the auto pay source code appears corresponding to the Auto Pay Source Code field.	Yes (Conditional) Note: This field is required while adding the automatic payment details of the account
Auto Pay Method	Used to indicate the method using which you want the system to process the automatic payment for the account. The valid values are: <ul style="list-style-type: none"> • Direct Debit • Payment Advice 	Yes (Conditional) Note: This field is required while adding the automatic payment details of the account
Auto Pay Route Type	Used to indicate when and how the automatic payment request of the account is routed to the financial institution. Note: The Search (🔍) icon appears corresponding to the Auto Pay Route Type field. On clicking the Search icon, the Auto Pay Route Type Search window appears. On specifying the auto pay route type, the description of the auto pay route type appears corresponding to the Auto Pay Route Type field.	Yes (Conditional) Note: This field is required while adding the automatic payment details of the account
Account Number	Used to specify the account number for which you want to add the automatic payment details.	Yes (Conditional)

Field Name	Field Description	Mandatory (Yes or No)
		Note: This field is required while adding the automatic payment details of the account
Expires On	Used to specify the month and year of expiry for the automatic payment of the account.	Yes (Conditional) Note: This field is required while adding the automatic payment details of the account
Name	Used to specify the account name for which you want to add the automatic payment details.	Yes (Conditional) Note: This field is required while adding the automatic payment details of the account
Maximum Withdrawal Amount	Used to specify the maximum amount which can be withdrawn from the account through the automatic payment method.	Yes (Conditional) Note: This field is required while adding the automatic payment details of the account
Comments	Used to specify additional information about the automatic payment for the account.	No

- Enter the required details in the **Auto Pay** page.
- If you want to add more than one automatic payment details of the account, click the **Add (+)** icon and then repeat step 2.

Note: However, if you want to remove an automatic payment detail from the account, click the **Delete (🗑)** icon.

- Click **Validate and Save**.

The automatic payment details are added for the account.

Related Topics

For more information on...	See...
How to define a customer registration	Defining a Customer Registration on page 139
How to edit a customer registration	Editing the Customer Registration Details on page 187
How to copy a customer registration	Copying a Customer Registration on page 172
How to add an account for a person	Adding an Account for a Person on page 152
How to edit the account details of a person	Editing the Account Details of a Person on page 169

Associating a Person to an Account

Prerequisites

To associate a person to an account, you should have:

- Account relationship types defined in the application

Procedure

To associate a person to an account:

1. Ensure that the **Persons** page is expanded in the **Customer Registration - Add Account** screen when you are adding or editing the account of a person.

The **Persons** page contains the following fields:

Field Name	Field Description	Mandatory (Yes or No)
Person ID	Used to indicate the person you want to associate with the account.	Yes (Conditional)
	<p>Note:</p> <p>The Search (🔍) icon appears corresponding to the Person ID field. On clicking the Search icon, the Person Search window appears.</p> <p>On specifying the person, the concatenated string of information about the person appears below the Person ID field.</p>	<p>Note: This field is required while associating a person to an account.</p>
Person Name	Displays the name of the person.	Not applicable
Main Customer	Used to indicate whether the associated person is the main customer of the account.	No
Financially Responsible	Used to indicate whether the associated person is financially responsible for the account's debt.	No
Account Relationship Type	Used to indicate the relationship of the associated person with the main account.	Yes (Conditional)
		<p>Note: This field is required while associating a person to an account.</p>

Note: By default, the details of the main customer appears in the **Persons** page. Click the **Add** (+) icon to associate a new person to the account.

2. Enter the required details in the **Persons** page.
3. Add the bill routing information of the person in the **Bill Routing Information** section, if required.
4. If you want to associate more than one person to the account, click the **Add** (+) icon and then repeat step 2.

Note: However, if you want to remove a person from the account, click the **Delete** (🗑️) icon.

5. Click **Validate and Save**.

The person is added to the account.

Related Topics

For more information on...	See...
How to define a customer registration	Defining a Customer Registration on page 139
How to edit a customer registration	Editing the Customer Registration Details on page 187

For more information on...	See...
How to copy a customer registration	Copying a Customer Registration on page 172
How to add an account for a person	Adding an Account for a Person on page 152
How to edit the account details of a person	Editing the Account Details of a Person on page 169

Adding the Bill Routing Information for an Account

Prerequisites

To add the bill routing information for an account, you should have:

- Bill formats, address sources, and bill route types defined in the application

Procedure

To add the bill routing information for an account:

1. Ensure that **Bill Routing Information** section is expanded in the **Persons** page when you are adding or editing the account of a person.

The **Bill Routing Information** section contains the following fields:

Field Name	Field Description	Mandatory (Yes or No)
Receives Copy of Bill	Used to indicate whether you want the person to receive a copy of the account's bill.	Yes (Conditional)
	Note: By default, the Receives Copy of Bill check box is selected if the person is the main customer of the account.	Note: This field is required while adding the bill routing information for an account.
Bill Format	Used to indicate the format in which you want the person to receive the account's bill. The valid values are: <ul style="list-style-type: none"> • Detailed • Summary 	Yes (Conditional)
	Note: By default, this field is disabled. It is enabled only when the Receives Copy of Bill check box is selected.	Note: This field is required while adding the bill routing information for an account.
Address Source	Used to indicate the address where you want to mail the account's bill. The valid values are: <ul style="list-style-type: none"> • Account Override • Main • Multiple Account Override • Person 	Yes (Conditional)
	Note: If you select the Address Source as Account Override , the Account Override Address section appears in the Persons page where you can add the account override address of the person.	Note: This field is required while adding the bill routing information for an account.

Field Name	Field Description	Mandatory (Yes or No)
Number of Bill Copies	Used to specify the number of copies of the account's bill you want the person to receive.	Yes (Conditional)
	Note: By default, this field is disabled. It is enabled when the Receives Copy of Bill check box is selected.	Note: This field is required while adding the bill routing information for an account.
Bill Route Type	Used to indicate how the account's bill is sent to the person.	Yes (Conditional)
	Note: By default, this field is disabled. It is enabled when the Receives Copy of Bill check box is selected.	Note: This field is required while adding the bill routing information for an account.
Receives Notification	Used to indicate whether you want the person to receive notifications about the account's bill.	Yes (Conditional)
	Note: By default, the Receives Notification check box is selected if the person is the main customer of the account.	Note: This field is required while adding the bill routing information for an account.

- Enter the required details in the **Bill Routing Information** section.
- If you want to add more than one bill routing information for the account, click the **Add (+)** icon and then repeat step 2.

Note: However, if you want to remove a bill routing information from the account, click the **Delete (🗑)** icon.

- Click **Validate and Save**.

The bill routing information is added for the account.

Related Topics

For more information on...	See...
How to define a customer registration	Defining a Customer Registration on page 139
How to edit a customer registration	Editing the Customer Registration Details on page 187
How to copy a customer registration	Copying a Customer Registration on page 172
How to add an account for a person	Adding an Account for a Person on page 152
How to edit the account details of a person	Editing the Account Details of a Person on page 169
How to associate a person to an account	Associating a Person to an Account on page 159

Defining a Characteristic for an Account

Prerequisites

To define a characteristic for an account, you should have:

- Characteristic types defined in the application (where the characteristic entity is set to **Account**)

Procedure

To define a characteristic for an account:

1. Ensure that the **Characteristics** section is expanded in the **Account Characteristics** page when you are adding or editing the account of a person.

The **Characteristics** section contains the following columns:

Column Name	Column Description	Mandatory (Yes or No)
Effective Date	Used to specify the date from when the characteristic is effective for the account.	Yes (Conditional)
		Note: This field is required while defining a characteristic for an account.
Characteristic Type	Used to indicate the characteristic type. Note: The list includes only those characteristic types where the characteristic entity is set to Account .	Yes (Conditional)
		Note: This field is required while defining a characteristic for an account.
Characteristic Value	Used to specify the value for the characteristic type. Note: If you select a predefined characteristic type, the Search (🔍) icon appears corresponding to the Characteristic Value field. On clicking the Search icon, the Predefined Characteristic Search window appears. On specifying the value for a predefined characteristic type, the description of the characteristic value appears corresponding to the Characteristic Value field.	Yes (Conditional)
		Note: This field is required while defining a characteristic for an account.

2. Enter the required details in the **Characteristics** section.
3. If you want to define more than one characteristic for the account, click the **Add** (+) icon and then repeat step 2.

Note: However, if you want to remove a characteristic from the account, click the **Delete** (🗑️) icon corresponding to the characteristic.

4. Click **Validate and Save**.

The characteristic is defined for the account.

Related Topics

For more information on...	See...
How to define a customer registration	Defining a Customer Registration on page 139
How to edit a customer registration	Editing the Customer Registration Details on page 187
How to copy a customer registration	Copying a Customer Registration on page 172
How to add an account for a person	Adding an Account for a Person on page 152
How to edit the account details of a person	Editing the Account Details of a Person on page 169

Adding the Credit Rating Details for an Account

Prerequisites

To add the credit rating details for an account, you should have:

- Collection classes defined in the application

Procedure

To add the credit rating details for an account:

1. Ensure that the **Credit Ratings** page is expanded in the **Customer Registration - Add Account** screen when you are adding or editing the account of a person.

The **Credit Ratings** page contains the following fields:

Field Name	Field Description	Mandatory (Yes or No)
Collection Class	Used to indicate how the account's debt is reviewed by the credit and collections processes (i.e., the account debt monitor and the write-off monitor).	Yes (Conditional) Note: This field is required while adding the credit rating details for an account.
Postpone Credit Review Until	Used to specify the date till when you want to postpone the account's debt review by the credit and collections processes (i.e., the account debt monitor and the write-off monitor).	Yes (Conditional) Note: This field is required while adding the credit rating details for an account.
Last Credit Review Date	Used to indicate the last review date of the account's debt by the account debt monitor.	Yes (Conditional) Note: This field is required while adding the credit rating details for an account.
Current Credit Rating	Displays the current credit rating.	Not applicable
Current Cash Only Score	Displays the current cash only score.	Not applicable
Start Date	Used to specify the date from when the credit rating transaction affects the account's credit rating and cash-only score. Note: The start date cannot be later than the end date	Yes (Conditional) Note: This field is required while adding the credit rating details for an account.
End Date	Used to specify the date till when the credit rating transaction affects the account's credit rating and cash-only score. Note: The end date cannot be earlier than the start date.	No
Affect Credit Rating By	Used to specify the effect of the credit rating transaction on the account's credit score.	Yes (Conditional)

Field Name	Field Description	Mandatory (Yes or No)
	Note: This should be a negative number because the lower the score, the worse the credit rating.	Note: This field is required while adding the credit rating details for an account.
Affect Cash Only Score By	Used to specify the effect of the credit rating transaction on the account's cash-only score. Note: This should be a positive number because the higher the score, the greater the chance for the account to be marked as cash-only.	Yes (Conditional) Note: This field is required while adding the credit rating details for an account.
Comments	Used to specify additional information about the credit rating for the account.	No

Note: The **Credit Ratings** page appears in the **Customer Registration - Add Account** screen when you are defining, editing, or copying a customer registration which is created using the **C1-CustomerRegistrationBanking** business object.

- Enter the required details in the **Credit Ratings** page.
- If you want to add more than one credit rating details for the account, click the **Add (+)** icon and then repeat step 2.

Note: However, if you want to remove a credit rating detail from the account, click the **Delete (🗑)** icon.

- Click **Validate and Save**.

The credit rating details are added for the account.

Related Topics

For more information on...	See...
How to define a customer registration	Defining a Customer Registration on page 139
How to edit a customer registration	Editing the Customer Registration Details on page 187
How to copy a customer registration	Copying a Customer Registration on page 172
How to add an account for a person	Adding an Account for a Person on page 152
How to edit the account details of a person	Editing the Account Details of a Person on page 169

Adding the Deal Information for a Person

Prerequisites

To add the deal information for a person, you should have:

- Deal review frequencies and currencies defined in the application.

Procedure

To add the deal information for a person:

- Ensure that the **Deal Information** section is expanded in the **Deal** page when you are defining, editing, or copying a customer registration.

The **Deal Information** section contains the following columns:

Column Name	Column Description	Mandatory (Yes or No)
Deal ID	Used to specify the deal which is created for the person.	Yes (Conditional) Note: This field is required while adding the deal information for a person.
Start Date	Used to specify the date from when the deal is effective for the person. Note: The start date cannot be later than the end date.	Yes (Conditional) Note: This field is required while adding the deal information for a person.
End Date	Used to specify the date till when the deal is effective for the person. Note: The end date cannot be earlier than the start date.	Yes (Conditional) Note: This field is required while adding the deal information for a person.
Deal Review Frequency	Used to indicate the periodic analysis of the deal usage as per the commitments made by the person. The valid values are: <ul style="list-style-type: none"> • Annual • Monthly • Weekly 	Yes (Conditional) Note: This field is required while adding the deal information for a person.
Currency Code	Used to indicate the currency in which the deal is defined in the system. Note: The list includes only those currencies which are already defined in the system.	Yes (Conditional) Note: This field is required while adding the deal information for a person.
Prospect	Used to indicate whether the person is a prospect customer or not. The valid values are: <ul style="list-style-type: none"> • Yes • No 	Yes (Conditional) Note: This field is required while adding the deal information for a person.
Relationship Manager	Used to specify the name of the relationship manager.	Yes (Conditional) Note: This field is required while adding the deal information for a person.

Note: The **Deal Information** page appears in the **Customer Registration** screen when you are defining, editing, or copying a customer registration which is created using the **C1-CustomerRegistrationBanking** business object.

2. Enter the required details in the **Deal Information** section.
3. If you want to add more than one deal information for the person, click the **Add (+)** icon and then repeat step 2.

Note: However, if you want to remove a deal information from the person, click the **Delete** (🗑️) icon corresponding to the deal.

4. Click **Validate and Save**.

The deal information is added for the person.

Related Topics

For more information on...	See...
How to define a customer registration	Defining a Customer Registration on page 139
How to edit a customer registration	Editing the Customer Registration Details on page 187
How to copy a customer registration	Copying a Customer Registration on page 172

Defining a Characteristic for a Customer Registration

Prerequisites

To define a characteristic for a customer registration, you should have:

- Characteristic types defined in the application (where the characteristic entity is set to **Customer Registration**)

Procedure

To define a characteristic for a customer registration:

1. Ensure that the **Characteristics** section is expanded in the **Registration Characteristics** page when you are defining, editing, or copying a customer registration.

The **Characteristics** section contains the following columns:

Column Name	Column Description	Mandatory (Yes or No)
Effective Date	Used to specify the date from when the characteristic is effective for the customer registration.	Yes (Conditional)
		Note: This field is required while defining a characteristic for a customer registration.
Characteristic Type	Used to indicate the characteristic type.	Yes (Conditional)
		Note: The list includes only those characteristic types where the characteristic entity is set to Customer Registration . Note: This field is required while defining a characteristic for a customer registration.
Characteristic Value	Used to specify the value for the characteristic type.	Yes (Conditional)
		Note: This field is required while defining a characteristic for a customer registration.

Column Name	Column Description	Mandatory (Yes or No)
	<p>Note:</p> <p>If you select a predefined characteristic type, the Search (🔍) icon appears corresponding to the Characteristic Value field. On clicking the Search icon, the Predefined Characteristic Search window appears.</p> <p>On specifying the value for a predefined characteristic type, the description of the characteristic value appears corresponding to the Characteristic Value field.</p>	

- Enter the required details in the **Characteristics** section.
- If you want to define more than one characteristic for the customer registration, click the **Add** (+) icon and then repeat step 2.

Note: However, if you want to remove a characteristic from the customer registration, click the **Delete** (🗑️) icon corresponding to the characteristic.

- Click **Validate and Save**.

The characteristic is defined for the customer registration.

Related Topics

For more information on...	See...
How to define a customer registration	Defining a Customer Registration on page 139
How to edit a customer registration	Editing the Customer Registration Details on page 187
How to copy a customer registration	Copying a Customer Registration on page 172

Viewing the Details of an Account

Procedure

To view the details of an account:

- Search for the customer registration in the **Customer Registration** screen.
- In the **Search Results** section, click the link in the **Customer Registration Information** column corresponding to the customer registration whose account details you want to view.

The **Main** tab appears in the **Customer Registration** screen.

- Ensure that the **Account Information** zone is expanded in the **Main** tab.
- Click the **View** (🔗) icon corresponding to the account whose details you want to view.

The **Account** tab appears.

- View the details of the account in the **Account Information** zone.

Related Topics

For more information on...	See...
How to search for a customer registration	Searching for a Customer Registration on page 137

For more information on...	See...
Customer Registration screen	Customer Registration (Used for Viewing) on page 175
Customer Registration - Main tab	Customer Registration - Main on page 176
Customer Registration - Account tab	Customer Registration - Account on page 182
Account Information zone	Account Information on page 182

Editing the Account Details of a Person

Prerequisites

To edit the account details of a person, you should have:

- Customer class, divisions, currencies, access groups, accrual cycles, and bill cycles defined in the application
- Account identifier types defined in the application
- Auto pay source codes, auto pay methods, and auto pay route types defined in the application
- Account relationship types defined in the application
- Address sources, bill formats, and bill route types defined in the application
- Characteristic types defined in the application (where the characteristic entity is set to **Account**)
- Collection class defined in the application

Note: The collection class is required when you are defining a customer registration using the **C1-CustomerRegistrationBanking** business object.

Procedure

To edit the account details of a person:

1. Search for the customer registration in the **Customer Registration** screen.
2. In the **Search Results** section, click the link in the **Customer Registration Information** column corresponding to the customer registration whose account details you want to edit.

The **Main** tab appears in the **Customer Registration** screen.

3. Click the **Edit** button in the **Customer Registration** zone.

The **Main** page appears in the **Customer Registration** screen.

4. Ensure that the **Accounts** section is expanded in the **Accounts** page.

5. Click the **Edit** (✎) icon in the **View / Edit** column corresponding to the account whose details you want to edit.

The **Customer Registration - Add Account** screen appears. It contains the following pages:

- **Main** - Used to specify basic information about the account.
- **Auto Pay** - Used to add the automatic payment details of the account.
- **Persons** - Used to associate a person to the account.
- **Account Characteristics** - Used to define a list of characteristics for the account.
- **Credit Ratings** - Used to add the credit rating details for the account.

Note: This page appears when you are defining a customer registration using the **C1-CustomerRegistrationBanking** business object.

The **Main** page contains the following sections:

- **Main** - Used to specify basic details about the account.
- **Account Identifiers** - Used to add the identifier details for the account.

The **Main** section contains the following fields:

Field Name	Field Description	Mandatory (Yes or No)
Customer Class	Used to indicate the customer class to which the account belongs.	Yes
Division	Used to indicate the division to which the account belongs.	Yes
	Note: You can only view those divisions to which you have access in the Division list.	
Set Up Date	Displays the date from when the account is configured for the person.	Not applicable
Invoice Currency	Used to indicate the currency which you want to use for generating the invoice of the account.	Yes
	Note: The list includes only those currencies which are defined in the system.	
Account Category	Displays the category to which the account belongs. The valid values are: <ul style="list-style-type: none"> • Invoice Account • Settlement Account • Usage Account 	Not applicable
	Note: The list includes only those values which are present in the ACCT_USAGE_FLG lookup field.	
Access Group	Used to indicate the user group that can access the account for the person.	Yes
	Note: The Search (🔍) icon appears corresponding to the Access Group field. On clicking the Search icon, the Access Group Search window appears. On specifying the access group, the description of the access group appears corresponding to the Access Group field.	
Exclude Accrual	Used to indicate whether the account is eligible for accrual.	No

Field Name	Field Description	Mandatory (Yes or No)
	<p>Note: By default, the account is eligible for accrual if the division to which the account belongs is eligible for accrual. If you do not want the account to be eligible for accrual, you must select the Exclude Accrual check box. On selecting the Exclude Accrual check box, the Accrual Cycle field is disabled.</p>	
Accrual Cycle	<p>Used to indicate the accrual cycle of the account in the division.</p> <p>Note:</p> <p>The Search (🔍) icon appears corresponding to the Accrual Cycle field. On clicking the Search icon, the Accrual Cycle Search for Cust Reg window appears.</p> <p>On specifying the accrual cycle, the description of the accrual cycle appears corresponding to the Accrual Cycle field.</p> <p>This field is disabled when you click the Exclude Accrual check box.</p>	No
Product	<p>Used to indicate the product for which the account is enrolled.</p> <p>Note:</p> <p>The Search (🔍) icon appears corresponding to the Product field. On clicking the Search icon, the Search Product window appears.</p>	<p>Yes (Conditional)</p> <p>Note: This field is required while enrolling an account for a product.</p>
Eligible for Repricing	<p>Used to indicate whether the account is eligible for repricing when the account attributes (defined as parameters in the system) are changed.</p> <p>Note:</p> <p>Only accounts where the person and child person are the main customers are considered for repricing.</p> <p>The system creates the repricing request for the account irrespective of whether the account is eligible for repricing or not.</p>	No
Bill Cycle	Used to indicate the bill cycle for the account.	No
Bill Lead Days	Used to specify the number of days which is used to derive the cut-off date for advance billing.	Yes

Field Name	Field Description	Mandatory (Yes or No)
	Note: In case you don't want to bill the account in advance, you must specify 0 in this field.	
Comments	Used to specify additional information about the account.	No

6. Modify the required details of the account in the **Main** page.
7. Add, edit, or remove the identifier details of the account in the **Account Identifiers** section.
8. Add, edit, or remove the automatic payment details of the account in the **Auto Pay** page, if required.
9. Associate or disassociate persons from the account in the **Persons** page, if required.
10. Define, edit, or remove characteristics of the account in the **Account Characteristics** page, if required.
11. Add, edit, or remove the credit rating details of the account in the **Credit Ratings** page, if required.
12. Click **Validate and Save**.

The changes made to the account are saved.

Related Topics

For more information on...	See...
How to search for a customer registration	Searching for a Customer Registration on page 137
Customer Registration screen	Customer Registration (Used for Viewing) on page 175
Customer Registration zone	Customer Registration on page 176
How to add an account for a person	Adding an Account for a Person on page 152
How to add the identifier details of an account	Adding the Identifier Details of an Account on page 156
How to add the automatic payment details of an account	Adding the Automatic Payment Details of an Account on page 157
How to associate a person to an account	Associating a Person to an Account on page 159
How to define a characteristic for an account	Defining a Characteristic for an Account on page 162
How to add the credit rating details for an account	Adding the Credit Rating Details for an Account on page 164

Copying a Customer Registration

Instead of creating a customer registration from scratch, you can create a new customer registration using an existing customer registration. This is possible through copying a customer registration. On copying a customer registration, the details including the characteristics are copied to the new customer registration. You can then edit the details, if required.

Prerequisites

To copy a customer registration, you should have:

- Customer registration (whose copy you want to create) defined in the application
- Divisions, customer segments, customer tiers, and access groups defined in the application
- Name types, phone types, and person identifier types defined in the application
- Address type codes and countries defined in the application
- Characteristic Types defined in the application

- Relationship types defined in the application
- Customer class, invoice currencies, account categories, bill cycles, accrual cycles, account identifier types, auto pay source codes, auto pay methods, auto pay route types, account relationship types, bill formats, address sources, bill route types, and collection class defined in the application

Note: The collection class is required when you are copying a customer registration which is created using the **C1-CustomerRegistrationBanking** business object.

- Deal review frequencies and currency codes defined in the application

Note: These prerequisites are required when you are copying a customer registration which is created using the **C1-CustomerRegistrationBanking** business object.

Procedure

To copy a customer registration:

1. Search for the customer registration in the **Customer Registration** screen.
2. Click the **Copy**  icon in the **Copy** column corresponding to the customer registration whose copy you want to create.

The **Customer Registration** screen appears. It contains the following pages:

- **Main** - Used to specify basic information about the person.
- **Contact** - Used to specify the contact information about the person.
- **Person Characteristics** - Used to define a list of characteristics for the person.
- **Hierarchy** - Used to define the person to person relationship for the person
- **Accounts** - Used to add the account details of the person.
- **Deal** - Used to specify information about the deals created for the person.

Note: This page appears only when you are defining a customer registration using the **C1-CustomerRegistrationBanking** business object.

- **Registration Characteristics** - Used to define a list of characteristics for the customer registration.

The **Main** page contains the following sections:

- **Main** - Used to specify basic details about the person.
- **Person Name** - Used to add the person names for customer registration.
- **Person Phones** - Used to add the person phone details for customer registration.
- **Person IDs** - Used to add the person identifiers for customer registration.

The **Main** section contains the following fields:

Field Name	Field Description	Mandatory (Yes or No)
Person Type	Indicates the person type using which you want to define the customer registration for the person.	Not applicable
Date of Birth	Used to specify the date when the person was born.	No
Division	Used to indicate the division to which the person belongs.	Not applicable

Field Name	Field Description	Mandatory (Yes or No)
Person Since Date	Used to specify the date from when the person is the main customer.	No
Customer Segment	Used to indicate the customer segment to which the person belongs.	No
	Note: This field appears when you are defining a customer registration using the C1-CustomerRegistrationBanking business object.	
Customer Tier	Used to indicate the customer tier of the customer segment to which the person belongs.	No
	Note: This field appears when you are defining a customer registration using the C1-CustomerRegistrationBanking business object.	
Access Group	Used to indicate the user group that can access the customer registration.	No
	Note: The Search (🔍) icon appears corresponding to the Access Group field. On clicking the Search icon, the Access Group Search window appears.	

3. Enter the required details in the **Main** section.
4. Add or remove the names of the person in the **Person Names** section.
5. Add or remove the phone details for the person in the **Person Phones** section.
6. Add, edit, or remove the identifier details for the person in the **Person IDs** section.
7. Define, edit, or remove the addresses of the person in the **Contact** page, if required.
8. Define, edit, or remove characteristics of the person in the **Person Characteristics** page, if required.
9. Define, edit, or remove the person to person relationship for the person in the **Hierarchy** page, if required.
10. Add, edit, or remove the account details of the person in the **Accounts** page, if required.
11. Add, edit, or remove information about the deals created for the person in the **Deal** page, if required.

Note: This page appears when you are defining a customer registration using the **C1-CustomerRegistrationBanking** business object.

12. Define, edit, or remove characteristics of the customer registration in the **Registration Characteristics** page, if required.
13. Click **Validate and Save**.

The new customer registration is defined.

Related Topics

For more information on...	See...
How to search for a customer registration	Searching for a Customer Registration on page 137
Search Customer Registration zone	Search Customer Registration on page 127
How to add name of a person for customer registration	Adding the Names of a Person on page 142
How to add the phone details of a person for customer registration	Adding the Phone Details of a Person on page 143
How to add the identifier details of a person for customer registration	Adding the Identifier Details of a Person on page 144
How to add the contact details of a person for customer registration	Adding the Contact Details of a Person on page 145
How to define a characteristic for a person	Defining a Characteristic for a Person on page 148
How to define the hierarchy of a person	Defining a Person to Person Relationship for a Person on page 149
How to add an account for a person	Adding an Account for a Person on page 152
How to add a deal information for a person	Adding the Deal Information for a Person on page 165
How to add a policy for a person	Defining a Policy
How to define a characteristic for a customer registration	Defining a Characteristic for a Customer Registration on page 167

Customer Registration (Used for Viewing)

The **Customer Registration** screen allows you to:

- Define a customer registration
- View the details of a customer registration
- Edit the details of a customer registration
- Delete a customer registration
- Submit a customer registration for processing
- Approve or reject a customer registration
- Request the submitter to resubmit a customer registration for approval
- View the log of a customer registration
- Add a log entry for a customer registration

It contains the following tabs:

- [Customer Registration - Main](#) on page 176
- [Customer Registration - Account](#) on page 182
- [Customer Registration - Log](#) on page 186

For more information on...	See...
How to define a customer registration	Defining a Customer Registration on page 139
How to view the details of a customer registration	Viewing the Customer Registration Details on page 138

For more information on...	See...
How to edit a customer registration	Editing the Customer Registration Details on page 187
How to delete a customer registration	Deleting a Customer Registration on page 190
How to submit a customer registration	Submitting a Customer Registration on page 190
How to approve a customer registration	Approving a Customer Registration on page 191
How to reject a customer registration	Rejecting a Customer Registration on page 192
How to request to resubmit a customer registration for approval	Requesting to Resubmit a Customer Registration for Approval on page 193
How to view the log of a customer registration	Viewing the Log of a Customer Registration on page 195
How to add a log entry for a customer registration	Adding a Log Entry for a Customer Registration on page 195

Customer Registration - Main

The **Main** tab displays information about the customer registration. It also displays information about the accounts, policies, and parent policies of the person in a customer registration. It contains the following zones:

- [Customer Registration](#) on page 176
- [Account Information](#) on page 182

Customer Registration

The **Customer Registration** zone displays the details of the customer registration. It contains of the following sections:

- **Main** - Displays the basic information about the customer registration. It contains the following fields:

Field Name	Field Description
Customer Registration Information	Displays the concatenated string of information about the customer registration separated by a comma (,).
Customer Registration Type	Indicates the customer registration type using which the customer registration is defined in the system.
Status	<p>Indicates the status of the customer registration. The valid values are:</p> <ul style="list-style-type: none"> • Approval in Progress • Bill Group Approved <div style="border: 1px solid black; padding: 5px; margin: 5px 0;"> <p>Note: This status appears when you are viewing the details of a customer registration which is created using the C1-CustomerRegistrationHC business object.</p> </div> <ul style="list-style-type: none"> • Complete • Draft • Draft For Update • Parent Customer Approved <div style="border: 1px solid black; padding: 5px; margin: 5px 0;"> <p>Note: This status appears only when you are viewing the details of a customer registration which is created using the C1-CustomerRegistrationHC business object.</p> </div> <ul style="list-style-type: none"> • Pending Final Approval

Field Name	Field Description
	<p>Note: This status appears when you are viewing the details of a customer registration which is created using the C1-CustomerRegistrationHC business object.</p> <ul style="list-style-type: none"> Pending Pricing Correction <p>Note: This status appears only when you are viewing the details of a customer registration which is created using the C1-CustomerRegistrationHC business object.</p> <ul style="list-style-type: none"> Rejected
Source System	Indicates the external system from where the customer registration information is received.
Person Information	<p>Displays the concatenated string of information about the main customer for whom the customer registration is created in the system. In addition, a context menu appears corresponding to this field which helps in navigating to other screens in the application.</p> <p>Note: It has a link. On clicking the link, the Person screen appears where you can view the details of the respective person.</p>
Registration Source	<p>Indicates the source through which the customer registration is created using the customer registration type. The valid values are:</p> <ul style="list-style-type: none"> File Upload Inbound Message Manual
Registration Source ID	Displays the source ID of the customer registration.

- **Record Actions** - The **Record Actions** section contains the following buttons:

Button Name	Button Description
Edit	Used to edit the details of the customer registration.
Delete	Used to delete the customer registration.
Submit	Used to submit the customer registration for validation and processing.
Duplicate	Used to create a new customer registration using an existing customer registration.
Approve	Used to approve the customer registration.
Reject	Used to reject the customer registration.
Return To Submitter	Used to request the submitter to resubmit the customer registration for approval.

- **Record Information** - The **Record Information** section contains the following fields:

Field Name	Field Description
Business Object	Indicates the business object using which the customer registration is created. In addition, a context menu appears corresponding to this field which helps in navigating to other screens in the application. Note: It has a link. On clicking the link, the Business Object screen appears where you can view the details of the respective business object.
Status Date/Time	Displays the date and time when the customer registration status is updated.
Create Date/Time	Displays the date and time when the customer registration is created.

- **Person Details** - Displays information about the main customer for whom the customer registration is created in the system. It contains the following fields:

Field Name	Field Description
Person Type	Indicates the person type of the main customer for whom the customer registration is defined in the system.
Date of Birth	Displays the date when the person was born.
Division	Indicates the division to which person belongs.
Person Since Date	Displays specify the date from when the person is the main customer.
Access Group	Indicates the user group that can access the customer registration. Note: It has a link. On clicking the link, the Access Group screen appears where you can view the details of the respective access group.

In addition, the **Person Details** section contains the following sub-sections:

- **Person Names** - Lists the primary and non-primary names of the person. It contains the following columns:

Column Name	Column Description
Name Type	Indicates the type of the name.
Name	Displays the name of the person.

- **Person Characteristics** - Lists the characteristics defined for the person. It contains the following columns:

Column Name	Column Description
Effective Date	Indicates the date from when the characteristic is effective for the person.
Characteristic Type	Indicates the characteristic type.
Characteristic value	Displays the value for the characteristic type.

- **Person Phones** - Lists the phone details of the person. It contains the following columns:

Column Name	Column Description
Phone Type	Indicates the type of the phone. The valid values are: <ul style="list-style-type: none"> • Business

Column Name	Column Description
	<ul style="list-style-type: none"> • Business Phone • Fax • Home • Mobile
Phone Number	Displays the phone number.
Extension	Displays the extension value of the phone number.
Phone Format	Displays the format in which the phone number is specified for the person.

- **Person IDs** - Lists the identifier details of the person. It contains the following columns:

Column Name	Column Description
Primary ID	Indicates whether the person identifier is primary or not.
Person Identifier Type	Indicates the identifier type of the person.
Person Identifier	Displays the value of the person identifier type.

- **Person Addresses** - Displays the contact information of the person. It contains the following fields:

Field Name	Field Description
Address Type	Indicates the type of the address.
Effective Date	Displays the date from when the address is effective for the person.
Country	Indicates the country where the person is located.
Address 1	Displays the first line of the address. It may contain details, such as house number and apartment name.
Address 2	Displays the second line of the address. It may contain details, such as street name.
City	Displays the city name.
Address 3	Displays the third line of the address. It may contain the landmark details.
County	Displays the county name.
State	Indicates the state where the city or county is located.
Province	Displays the location within the country where the person is located.
Address 4	Displays the fourth line of the address.
Postal	Displays the postal or zip code of the address.
House Type	Indicates the type of the house.
In City Limit	Indicates whether the address is within the city limit. The valid values are: <ul style="list-style-type: none"> • Yes • No

Field Name	Field Description
Geographic Code	Displays the geographic code of the address.

Note:

The above mentioned fields appear in the **Person Addresses** section when the respective data is available for the person.

Also, the labels of the address fields will change depending on the business label which is defined for the respective address field in the **Country** screen.

- **Override Mailing Name** - Lists the overriding mailing names for the person. It contains the following columns:

Column Name	Column Description
Override Mailing Name - Name1	Displays the name using which you want to override the person's mailing name.
Override Mailing Name - Name2	Displays the name using which you want to override the person's override mailing name 1.
Override Mailing Name - Name3	Displays the name using which you want to override the person's override mailing name 2.
Email Address	Displays the email address of the person.

- **Related Person Information** - Lists the persons that are related to the main customer. It contains the following columns:

Column Name	Column Description
Related Person Information	<p>Displays the concatenated string of information about the related person separated by a comma (.). In addition, a context menu appears corresponding to this field which helps in navigating to other screens in the application.</p> <p>Note: It has a link. On clicking the link, the Person Information screen appears where you can view the details of the respective person.</p>
Parent/Child	<p>Indicates whether the related person is a parent or a child. The valid values are:</p> <ul style="list-style-type: none"> • Parent • Child
Relationship Type	Indicates the person to person relationship type.
Start Date	Indicates indicate the date from when the person to person relationship is effective.
End Date	Indicates the date till when the person to person relationship is effective.
Financial Relationship	Indicates whether the related person is financially responsible or not.
Characteristics	On clicking the Add (+) icon, you can view the list of characteristics of the related person.

- **Registration Characteristics** - Lists the characteristics of the customer registration. It contains the following columns:

Column Name	Column Description
Effective Date	Indicates the date from when the characteristic is effective for the customer registration.
Characteristic Type	Indicates the characteristic type.
Characteristic value	Displays the value for the characteristic type.

Related Topics

For more information on...	See...
How to define a customer registration	Defining a Customer Registration on page 139
How to edit a customer registration	Editing the Customer Registration Details on page 187
How to copy a customer registration	Copying a Customer Registration on page 172
How to delete a customer registration	Deleting a Customer Registration on page 190
How to view the details of a customer registration	Viewing the Customer Registration Details on page 138

Account Information

The **Account Information** zone lists the accounts added for the person in the customer registration. It contains of the following columns:

Column Name	Column Description
Sequence	Displays the sequence number of the account.
Template	Indicates the account template using which the account is added for the person.
Customer Class	Indicates the customer class to which the account belongs.
Division	Indicates the division to which the account belongs.
Primary Identifier Type	Indicates the primary identifier type using which the account is added for the person.
Identifier Value	Displays the value of the primary identifier type.

On clicking the **View** () icon corresponding to an account, the **Account** tab appears where you can view the details of the respective account.

Note:

No information appears in the **Account Information** zone if an account is not yet added for the person.

Pagination is used to display limited number of records in this zone. You can use the navigation links, such as **Previous** and **Next** to navigate between pages.

Related Topics

For more information on...	See...
How to add an account for a person	Adding an Account for a Person on page 152
How to view the details of an account	Viewing the Details of an Account on page 168

For more information on...	See...
How to view the details of a customer registration	Viewing the Customer Registration Details on page 138

Customer Registration - Account

The **Account** tab displays information about the account of the person in a customer registration. It contains the following zone:

- [Account Information](#) on page 182

Account Information

The **Account Information** zone displays information about the account added for the person in the customer registration. It contains the following sections:

- **Main** - Displays the basic information about the account. It contains the following fields:

Field Name	Field Description
Account Information	Displays the concatenated string of information about the account separated by a comma (.). In addition, a context menu appears corresponding to this field which helps in navigating to other screens in the application. Note: It has a link. On clicking the link, the Account screen appears where you can view the details of the respective account.
Customer Class	Indicates the customer class to which the account belongs.
Division	Indicates the division to which the account belongs.
Set Up Date	Displays the date from when the account is configured for the person.
Invoice Currency	Indicates the currency which is used for generating the invoice of the account.
Account Category	Indicates the category to which the account belongs. The valid values are: <ul style="list-style-type: none"> • Invoice Account • Settlement Account • Usage Account
Access Group	Indicates the user group that can access the account for the person.
Exclude Accrual	Indicates whether the account is eligible for accrual.
Eligible for Repricing	Indicates whether the account is eligible for repricing when the account attributes (defined as parameters in the system) are changed.
Product	Indicates the product for which the account is enrolled.
Bill Cycle	Indicates the billing cycle for the account.
Bill Lead Days	Displays the number of days which is used to derive the cut-off date for advance billing.
Comments	Displays additional information about the account.

- **Account Identifiers** - Lists the identifiers details of the account. It contains the following columns:

Column Name	Column Description
Primary ID	Indicates whether the account identifier is primary or not.
Account Identifier Type	Indicates the identifier type for the account.
Primary Account Identifier	Displays the primary account identifier for the account identifier type.

- **Account Characteristics** - Lists the characteristics of the account. It contains the following columns:

Column Name	Column Description
Effective Date	Displays the date from when the characteristic is effective for the account.
Characteristic Type	Indicates the characteristic type.
Characteristic Value	Displays the value for the characteristic type.

- **Auto Pay Details** - Displays the automatic payment details of the account. It contains the following fields:

Field Name	Field Description
Defer Auto Pay Date	Displays the date till when you want to hold the automatic payment process of the account.
Rule Based Auto Pay	Indicates whether the automatic payment is rule based.
Start Date	Displays the date from when the automatic payment is effective for the account.
End Date	Displays the date till when the automatic payment is effective for the account.
Percentage	Displays the contribution of payment amount in percentage within multiple Auto Pay IDs (i.e for Auto Pay Source Codes) having the same priority.
Priority	Displays the order in which the automatic payment option is considered for the effective date range.
Auto Pay Source Code	Indicates the financial institution that receives the automatic payment request.
Auto Pay Route Type	Indicates when and how the automatic payment request of the account is routed to the financial institution.
Account Number	Displays the account number for which the automatic payment is defined.
Expires On	Displays the month and year of expiry for the automatic payment of the account.
Name	Displays the account name for which the automatic payment is defined.
Maximum Withdrawal Amount	Displays the maximum amount which can be withdrawn from the account through the automatic payment method.
Comments	Displays additional information about the automatic payment for the account.

- **Account Credit Rating** - Displays the credit rating details of the account. It contains the following fields:

Field Name	Field Description
Collection Class	Indicates how the account's debt is reviewed by the credit and collections processes (i.e., the account debt monitor and the write-off monitor).
Postpone Credit Review Until	Displays the date till when you want to postpone the account's debt review by the credit and collections processes (i.e., the account debt monitor and the write-off monitor).
Last Credit Review Date	Displays the last review date of the account's debt by the account debt monitor.
Current Credit Rating	Displays the current credit rating.
Current Cash Only Score	Displays the current cash only score.
Start Date	Displays the date from when the credit rating transaction affects the account's credit rating and cash-only score.
End Date	Displays the date till when the credit rating transaction affects the account's credit rating and cash-only score.
Affect Credit Rating By	Displays the effect of the credit rating transaction on the account's credit score.
Affect Cash-Only Score By	Displays the effect of the credit rating transaction on the account's cash-only score.
Comments	Displays additional information about the credit rating for the account.

Note: The **Account Credit Rating** section appears when you are viewing the details of a customer registration which is created using the **C1-CustomerRegistrationBanking** business object.

- **Account Persons** - Displays the details of the persons associated to the account. It contains the following fields:

Field Name	Field Description
Person ID	Indicates the person associated to the account.
Person Name	Displays the name of the person associated to the account.
Main Customer	Indicates whether the associated person is the main customer of the account.
Financially Responsible	Indicates whether the associated person is financially responsible for the account's debt.
Account Relationship Type	Indicates the relationship of the associated person with the main account.

- **Account Override Address** - Displays the overridden address of the account. It contains the following fields:

Column Name	Column Description
Country	Indicates the country where the account main customer is located.
Address 1	Displays the first line of the address. It may contain details, such as house number and apartment name.
Address 2	Displays the second line of the address. It may contain details, such as street name.
Address 3	Displays the third line of the address. It may contain the landmark details.

Column Name	Column Description
Address 4	Displays the fourth line of the address.
City	Displays the city name.
County	Displays the county name.
State	Indicates the state where the city or county is located.
Province	Displays the location within the country where the person is located.
Postal	Displays the postal or zip code of the address.
House Type	Indicates the type of the house.
In City Limit	Indicates whether the address is within the city limit. The valid values are: <ul style="list-style-type: none"> • Yes • No
Geographic Code	Displays the geographic code of the address.

Note:

The above mentioned fields appear in the **Account Override Address** section when the respective data is available for the person.

Also, the labels of the address fields will change depending on the business label which is defined for the respective address field in the **Country** screen.

- **Bill Routing Information** - Displays the bill routing information of the account. It contains the following fields:

Field Name	Field Description
Receives Copy of Bill	Indicates whether you want the person to receive a copy of the account's bill.
Bill Format	Indicates the format in which you want the person to receive the account's bill. The valid values are: <ul style="list-style-type: none"> • Detailed • Summary
Address Source	Indicates the address where you want the person to receive the account's bill. The valid values are: <ul style="list-style-type: none"> • Account Override • Main • Multiple Account Override • Person
Number of Bill copies	Displays the number of copies of the account's bill you want the person to receive.
	Note: This field appears when the Receives Copy of Bill check box is selected.
Bill Route Type	Indicates how the account's bill is sent to the person.

Field Name	Field Description
	Note: This field appears when the Receives Copy of Bill check box is selected.
Receives Notification	Indicates whether you want the person to receive notifications about the account's bill. Note: By default, the Receives Notification check box is selected if the person is the main customer of the account.

Related Topics

For more information on...	See...
How to add an account for a person	Adding an Account for a Person on page 152
How to view the details of an account	Viewing the Details of an Account on page 168
How to view the details of a customer registration	Viewing the Customer Registration Details on page 138

Customer Registration - Log

The **Log** tab allows you to view the complete trail of actions performed on the customer registration. It also allows you to manually add a log entry for the customer registration. It contains the following zone:

- [Customer Registration Log](#) on page 186

Customer Registration Log

The **Customer Registration Log** zone lists the complete trail of actions performed on the customer registration. It contains the following columns:

Column Name	Column Description
Date/Time	Displays the date and time when the action was performed on the customer registration due to which the log is created in the system.
Details	Displays the details of the actions performed on the customer registration.
User	Indicates the user who has performed the action on the customer registration.
Log Type	Indicates the type of log using which the action is performed on the customer registration.
Related Object	Indicates the object or entity which is created when the action is performed on the customer registration. Note: At present, no data appears in this column. The implementation team can build the custom logic to meet the business requirements.
Status Reason	Indicates the reason why the action is performed on the customer registration.

Note: You can manually add a log entry for the customer registration by clicking the **Add Log Entry** link in the upper right corner of the this zone.

Related Topics

For more information on...	See...
How to view the log of a customer registration	Viewing the Log of a Customer Registration on page 195
How to add a log entry for a customer registration	Adding a Log Entry for a Customer Registration on page 195
Customer Registration - Log tab	Customer Registration - Log on page 186

Editing the Customer Registration Details

Prerequisites

To define a customer registration, you should have:

- Divisions, customer segments, customer tiers, and access groups defined in the application
- Name types, phone types, and person identifier types defined in the application
- Address type codes and countries defined in the application
- Characteristic types defined in the application (where the characteristic entity is set to **Customer Registration**)
- Relationship types defined in the application
- Customer class, invoice currencies, account categories, bill cycles, accrual cycles, account identifier types, auto pay source codes, auto pay methods, auto pay route types, account relationship types, bill formats, address sources, bill route types, and collection class defined in the application

Note: The collection class is required when you are editing a customer registration which is created using the **C1-CustomerRegistrationBanking** business object.

- Deal review frequencies and currency codes defined in the application

Note: These prerequisites are required when you are editing a customer registration which is created using the **C1-CustomerRegistrationBanking** business object.

Procedure

To edit a customer registration:

1. Search for the customer registration in the **Customer Registration** screen.
2. In the **Search Results** section, click the link in the **Customer Registration Information** column corresponding to the customer registration whose details you want to edit.

The **Main** tab appears in the **Customer Registration** screen.

3. Click the **Edit** button in the **Customer Registration** zone.

The **Customer Registration** screen appears. It contains the following pages:

- **Main** - Used to specify basic information about the person.
- **Contact** - Used to specify the contact information about the person.
- **Person Characteristics** - Used to define a list of characteristics for the person.
- **Hierarchy** - Used to define the person to person relationship for the person
- **Accounts** - Used to add the account details of the person.
- **Deal** - Used to specify information about the deals created for the person.

Note: This page appears only when you are editing a customer registration which is created using the **C1-CustomerRegistrationBanking** business object.

- **Registration Characteristics** - Used to define a list of characteristics for the customer registration.

The **Main** page contains the following sections:

- **Main** - Used to specify basic details about the person.
- **Person Name** - Used to add the person names for customer registration.
- **Person Phones** - Used to add the person phone details for customer registration.
- **Person IDs** - Used to add the person identifiers for customer registration.

The **Main** section contains the following fields:

Field Name	Field Description	Mandatory (Yes or No)
Person Type	Indicates the person type using which you want to define the customer registration for the person.	Not applicable
Date of Birth	Used to specify the date when the person was born.	Yes
Division	Used to indicate the division to which the person belongs.	Yes
	Note: You can view only those divisions to which you have access in the Division list.	
Person Since Date	Used to specify the date from when the person is the main customer.	Yes
Customer Segment	Used to indicate the customer segment to which the person belongs.	Yes
	Note: This field appears when you are editing a customer registration which is created using the C1-CustomerRegistrationBanking business object.	
Customer Tier	Used to indicate the customer tier of the customer segment to which the person belongs.	Yes
	Note: This field appears when you are editing a customer registration which is created using the C1-CustomerRegistrationBanking business object.	
Access Group	Used to indicate the user group that can access the customer registration.	Yes

Field Name	Field Description	Mandatory (Yes or No)
	<p>Note:</p> <p>The Search (🔍) icon appears corresponding to the Access Group field. On clicking the Search icon, the Access Group Search window appears.</p> <p>On specifying the access group, the description of the access group appears corresponding to the Access Group field.</p>	

4. Modify the required details in the **Main** section.
5. Add, edit, or remove the names of the person in the **Person Names** section.
6. Add, edit, or remove the phone details of the person in the **Person Phones** section.
7. Add or remove the identifier details of the person in the **Person IDs** section.
8. Define, edit, or remove the address of the person in the **Contact** page, if required.
9. Define, edit, or remove characteristics of the person in the **Person Characteristics** page, if required.
10. Define, edit, or remove the person to person relationship for the person in the **Hierarchy** page, if required.
11. Add, edit, or remove the account details of the person in the **Accounts** page, if required.
12. Add, edit, or remove information about the deals created for the person in the **Deal** page, if required.

Note: This page appears when you are editing a customer registration which is created using the **C1-CustomerRegistrationBanking** business object.

13. Define, edit, or remove characteristics of the customer registration in the **Registration Characteristics** page, if required.
14. Click **Validate and Save**.

The changes made to the customer registration are saved.

Related Topics

For more information on...	See...
How to search for a customer registration	Searching for a Customer Registration on page 137
Customer Registration - Main tab	Customer Registration - Main on page 176
Customer Registration screen	Customer Registration (Used for Viewing) on page 175
Customer Registration zone	Customer Registration on page 176
How to add name of a person for customer registration	Adding the Names of a Person on page 142
How to add the phone details of a person for customer registration	Adding the Phone Details of a Person on page 143
How to add the identifier details of a person for customer registration	Adding the Identifier Details of a Person on page 144
How to add the contact details of a person for customer registration	Adding the Contact Details of a Person on page 145

For more information on...	See...
How to define a characteristic for a person	Defining a Characteristic for a Person on page 148
How to define the hierarchy of a person	Defining a Person to Person Relationship for a Person on page 149
How to add an account for a person	Adding an Account for a Person on page 152
How to add a deal information for a person	Adding the Deal Information for a Person on page 165
How to define a characteristic for a customer registration	Defining a Characteristic for a Customer Registration on page 167

Deleting a Customer Registration

Procedure

To delete a customer registration:

1. Search for the customer registration in the **Customer Registration** screen.

2. In the **Search Results** section, click the link in the **Customer Registration Information** column corresponding to the customer registration that you want to delete.

The **Main** tab appears in the **Customer Registration** screen.

3. Click the **Delete** button in the **Customer Registration** zone.

A message appears confirming whether you want to delete the customer registration.

Note: The **Delete** button appears when the customer registration is in the **Draft** status.

4. Click **OK**.

The customer registration is deleted.

Related Topics

For more information on...	See...
How to search for a customer registration	Searching for a Customer Registration on page 137
Customer Registration - Main tab	Customer Registration - Main on page 176
Customer Registration screen	Customer Registration (Used for Viewing) on page 175
Customer Registration zone	Customer Registration on page 176

Submitting a Customer Registration

Procedure

To submit a customer registration:

1. Search for the customer registration in the **Customer Registration** screen.

2. In the **Search Results** section, click the link in the **Customer Registration Information** column corresponding to the customer registration that you want to submit.

The **Main** tab appears in the **Customer Registration** screen.

3. Click the **Submit** button in the **Customer Registration** zone.

Note: The **Submit** button appears only when the customer registration is in the **Draft** status.

Related Topics

For more information on...	See...
How to search for a customer registration	Searching for a Customer Registration on page 137
Customer Registration screen	Customer Registration (Used for Viewing) on page 175
Customer Registration zone	Customer Registration on page 176

Approving a Customer Registration

You can view the number of customer registrations which are pending for an approval in the **Customer Registration** screen. The approver can review, and accordingly approve, reject, or ask the submitter to resubmit the customer registration based on the observations.

Note: The system will not allow you to approve, reject or resubmit a customer registration submitted by you.

Procedure

To approve a customer registration:

1. Do either of the following:

If you want to...	Then...
Approve a customer registration through the Customer Registration screen	<ol style="list-style-type: none"> 1. Search for the customer registration in the Customer Registration screen. 2. In the Search Results section, click the link in the Customer Registration ID column corresponding to the customer registration which you want to review.
Approve a customer registration from the To Do List screen	<ol style="list-style-type: none"> 1. Click the Menu link in the Application toolbar. A list appears. 2. From the Main menu, select To Do and then click To Do List. The To Do Type for User Search window appears. 3. Enter C1-CustomerRegistration in the To Do Type field. 4. Click the Search button corresponding to the To Do Type field. 5. Click Search. The To Do Type Search screen appears.

The **Customer Registration** screen appears.

2. Review the details in the **Customer Registration** screen.
3. If the information in the customer registration is accurate, then click the **Approve** button in the **Customer Registration** zone.

Note: The **Approve** button appears when:

- The status of customer registration is in the **Approval In Progress**.
- A user with the approval To Do role is reviewing the customer registration.

Related Topics

For more information on...	See...
How to search for a customer registration	Searching for a Customer Registration on page 137
Customer Registration screen	Customer Registration (Used for Viewing) on page 175
Customer Registration zone	Customer Registration on page 176

Rejecting a Customer Registration

Prerequisites

To reject a customer registration, you should have:

- Reasons defined for the **Rejected** status of the **C1-CustomerRegistration** business object in the **Status Reason** screen

Note: The system will not allow you to approve, reject or resubmit a customer registration submitted by you.

Procedure

To reject a customer registration:

1. Do either of the following:

If you want to...	Then...
Reject a customer registration through the Customer Registration screen	<ol style="list-style-type: none"> 1. Search for the customer registration in the Customer Registration screen. 2. In the Search Results section, click the link in the Customer Registration Information column corresponding to the customer registration which you want to review.
Reject a customer registration from the To Do List screen	<ol style="list-style-type: none"> 1. Click the Menu link in the Application toolbar. A list appears. 2. From the Main menu, select To Do and then click To Do List. The To Do Type for User Search window appears. 3. Enter C1-CustomerRegistration in the To Do Type field. 4. Click the Search button corresponding to the To Do Type field. The To Do List screen appears.

If you want to...	Then...
	<ol style="list-style-type: none"> 5. Select the Open option from the Filter by list to view all unassigned To Dos. 6. Click the link in the Message column corresponding to the To Do of the customer registration that you want to review.

The **Customer Registration** screen appears.

2. Review the details in the **Customer Registration** screen.
3. If the information in the customer registration is incorrect, then click the **Reject** button in the **Customer Registration** zone.

The **Reject Customer Registration** window appears. It contains following fields:

Field Name	Field Description	Mandatory (Yes or No)
Status Reason	Used to indicate the reason why you want to reject the customer registration. Note: The list includes only those reasons which are defined for the Rejected status of the C1-CustomerRegistration business object in the Status Reason screen.	Yes
Comments	Used to specify additional information while rejecting the customer registration.	No

Note: The **Reject** button appears when:

- The customer registration is in the **Approval In Progress** status.
- A user with the approval To Do role is reviewing the customer registration.

4. Select the reason for rejection of the customer registration from the **Status Reason** field.
5. Click **Save**.

The status of the customer registration is changed to **Rejected**.

Related Topics

For more information on...	See...
How to search for a customer registration	Searching for a Customer Registration on page 137
Customer Registration screen	Customer Registration (Used for Viewing) on page 175
Customer Registration zone	Customer Registration on page 176

Requesting to Resubmit a Customer Registration for Approval

Procedure

To initiate a resubmission request for a customer registration:

1. Do either of the following:

If you want to...	Then...
Request the submitter to resubmit a customer registration through the Customer Registration screen	<ol style="list-style-type: none"> 1. Search for the customer registration in the Customer Registration screen. 2. In the Search Results section, click the link in the Customer Registration ID column corresponding to the customer registration which you want to review.
Request the submitter to resubmit a customer registration from the To Do List screen	<ol style="list-style-type: none"> 1. Click the Menu link in the Application toolbar. A list appears. 2. From the Main menu, select To Do and then click To Do List. The To Do Type for User Search window appears. 3. Enter C1-CustomerRegistration in the To Do Type field. 4. Click the Search button corresponding to the To Do Type field. The To Do List screen appears. 5. Select the Open option from the Filter by list to view all unassigned To Dos. 6. Click the link in the Message column corresponding to the To Do of the customer registration that you want to review.

The **Customer Registration** screen appears.

2. Review the details in the **Customer Registration** screen.
3. If the information in the customer registration is incomplete and you want the submitter to make the required changes and resubmit the customer registration for approval, then click the **Re Submit** button in the **Customer Registration** zone.

The **Resubmit Customer Registration** window appears. It contains the following field:

Field Name	Field Description	Mandatory (Yes or No)
Comments	Used to specify the changes which the submitter should make in the customer registration before resubmitting it for approval.	Yes

Note: The **Re Submit** button appears when:

- The customer registration is in the **Approval In Progress** status.
- A user with the approval To Do role is reviewing the customer registration.

4. Enter the comments in the respective field and then click **Save**.

A To Do is created using the submitter To Do type and assigned to all users with a submitter To Do role specified in the customer registration type. In addition, the status of the customer registration is changed to **Draft**.

Related Topics

For more information on...	See...
How to search for a customer registration	Searching for a Customer Registration on page 137
Customer Registration screen	Customer Registration (Used for Viewing) on page 175
Customer Registration zone	Customer Registration on page 176

Viewing the Log of a Customer Registration

Procedure

To view the log of a customer registration:

1. Search for the customer registration in the **Customer Registration** screen.
2. In the **Search Results** section, click the link in the **Customer Registration Information** column corresponding to the customer registration whose log you want to view.

The **Main** tab appears in the **Customer Registration** screen.

3. Click the **Log** tab.

The **Log** tab appears.

4. View the complete trail of actions performed on the customer registration in the **Customer Registration Log** zone.

Related Topics

For more information on...	See...
How to search for a customer registration	Searching for a Customer Registration on page 137
Customer Registration - Main tab	Customer Registration - Main on page 176
Customer Registration screen	Customer Registration (Used for Viewing) on page 175
Customer Registration - Log tab	Customer Registration - Log on page 186
Customer Registration Log zone	Customer Registration Log on page 186

Adding a Log Entry for a Customer Registration

Procedure

To add a log entry for a customer registration:

1. Search for the customer registration in the **Customer Registration** screen.
2. In the **Search Results** section, click the link in the **Customer Registration Information** column corresponding to the customer registration for which you want to add a log entry.

The **Main** tab appears in the **Customer Registration** screen.

3. Click the **Log** tab.

The **Log** tab appears.

4. Click the **Add Log Entry** link in the upper right corner of the **Customer Registration Log** zone.

The **Add Request Log** screen appears. It contains the following fields:

Field Name	Field Description	Mandatory (Yes or No)
Request Information	Displays the concatenated string of information about the customer registration separated by a comma (,).	Not applicable
Log Details	Used to specify the reason for adding a log entry for the customer registration.	Yes

5. Enter the required details in the **Log Details** field.
6. Click **Save**.

The log entry is added for the **Customer Registration Log** zone.

Related Topics

For more information on...	See...
How to search for a customer registration	Searching for a Customer Registration on page 137
Customer Registration - Main tab	Customer Registration - Main on page 176
Customer Registration screen	Customer Registration (Used for Viewing) on page 175
Customer Registration - Log tab	Customer Registration - Log on page 186
Customer Registration Log zone	Customer Registration Log on page 186

Chapter

2

Customer 360° View

Topics:

- [Customer 360° View](#)
- [Customer 360° Information](#)
- [Bill Information](#)

Oracle Revenue Management and Billing provides you with the ability to quickly view in-depth information about the person by aggregating data from the application and presenting the same on a screen named **Customer 360° View**. This data can then be easily used for analysis. You can use the person or account details to view the 360° information of the person, such as:

- Basic details, characteristics, linked accounts, hierarchy, and the customer contacts of a person
- Basic details, characteristics, account persons list, automatic payment options, billing history, payment history, dispute details, hold details, and overdue processes details of the person's account
- Basic details of the bill, adjustments which are swept onto the bill, activities (such as, payment, offset, refund, or write off) through which the bill is settled, high level summary and details of the bill segments included the bill, active hold requests due to which the bill is kept on hold, offset requests through which the bill is offset against another bill, and refund and write off requests through which the bill or its bill segment is either refunded or written off.

In other words, this feature allows you to drill down to see or act on all current and historical revenue management and billing details. This allows you to professionally and efficiently handle customer inquiries and complaints at the first point of contact, raising your customer service from previously unattainable levels and reducing the associated time and cost.

Customer 360° View

The **Customer 360° View** screen allows you to search for a person and account using various search criteria. You can then view 360° information of the person and the person's account, and vice-versa. By default, whenever you login to the application, the **Customer 360° View** screen appears. This screen consists of the following zone:

- [360° Search](#) on page 198

360° Search

The **360° Search** zone allows you to search for a person and account using various search criteria. It contains the following two sections:

- **Search Criteria** - The **Search Criteria** section contains the following fields:

Field Name	Field Description	Mandatory (Yes or No)
Search By	Used to indicate whether you want to search for a person or account. The valid values are: <ul style="list-style-type: none"> • Person • Account 	Yes
	Note: By default, the Person option is selected.	
Division	Used to search persons or accounts which belong to a particular division.	No
Person Name	Used to search a particular person using its primary or secondary name. If you specify the person name while searching for an account, the system searches all accounts where the person is the main customer.	No
	Note: This field appears when: <ul style="list-style-type: none"> • The Person option is selected from the Search By list. • The Account option is selected from the Search By list and the Advanced Search link available in the right side of the 360° Search zone is clicked. 	
Person Type	Used to search persons of a particular type. The valid values are: <ul style="list-style-type: none"> • Bill Group • Broker • Business • Group • Parent Customer • Person 	No

Field Name	Field Description	Mandatory (Yes or No)
	Note: This field appears when the Advanced Search link available in the right side of the 360° Search zone is clicked.	
Customer Segment	Used to search for a persons which belong to a particular customer segment. Note: This field appears when the Person option is selected from the Search By list and the Advanced Search link available in the right side of the 360° Search zone is clicked.	No
Prospect	Used to search for persons which are prospects for whom a deal is defined in the system. The valid values are: <ul style="list-style-type: none"> • Yes • No Note: This field appears when the Person option is selected from the Search By list and the Advanced Search link available in the right side of the 360° Search zone is clicked.	No
Address	Used to search persons with a particular address or accounts' whose main customer has a particular address. Note: This field appears when the Advanced Search link available in the right side of the 360° Search zone is clicked.	No
City	Used to search persons who belong to a particular city or accounts' whose main customer belongs to a particular city. Note: This field appears when the Advanced Search link available in the right side of the 360° Search zone is clicked.	No
Phone Number	Used to search a person with a particular phone number. Note: This field appears when the Person option is selected from the Search By list and the Advanced Search link available in the right side of the 360° Search zone is clicked.	No
Person ID	Used to search a particular person. Note: This field appears when the Person option is selected from the Search By list.	No
Person Identifier Type	Used to indicate the person identifier type based on which you want to search for a person or account.	Yes (Conditional)

Field Name	Field Description	Mandatory (Yes or No)
	<p>Note:</p> <p>This field appears when:</p> <ul style="list-style-type: none"> The Person option is selected from the Search By list. The Account option is selected from the Search By list and the Advanced Search link available in the right side of the 360° Search zone is clicked. 	<p>Note: If you specify the person identifier as a search criteria, you have to select the person identifier type.</p>
Person Identifier	<p>Used to search for a person or account by specifying the person identifier.</p> <p>Note:</p> <p>This field appears when:</p> <ul style="list-style-type: none"> The Person option is selected from the Search By list. The Account option is selected from the Search By list and the Advanced Search link available in the right side of the 360° Search zone is clicked. 	<p>Yes (Conditional)</p> <p>Note: If you specify the person identifier type as a search criteria, you have to enter the person identifier.</p>
Characteristic Type	<p>Used to search persons or accounts with a particular type of characteristic.</p> <p>Note: This field appears when the Advanced Search link available in the right side of the 360° Search zone is clicked.</p>	No
Characteristic Value	<p>Used to search persons or accounts with a particular characteristic.</p> <p>Note:</p> <p>If you select a predefined characteristic type, the Search  icon appears corresponding to the Characteristic Value field. On clicking the Search icon, the Predefined Characteristic Search window appears.</p> <p>On specifying the value for a predefined characteristic type, the description of the characteristic value appears corresponding to the Characteristic Value field.</p>	<p>Yes (Conditional)</p> <p>Note: If you specify the characteristic type as a search criteria, you have to enter the characteristic value.</p>
Customer Class	<p>Used to search accounts which belong to a particular customer class.</p> <p>Note: This field appears when the Account option is selected from the Search By list.</p>	No
Account ID	Used to search a particular account.	No

Field Name	Field Description	Mandatory (Yes or No)
	Note: This field appears when the Account option is selected from the Search By list.	
Account Identifier Type	Used to indicate the account identifier type based on which you want to search for an account. Note: This field appears when the Account option is selected from the Search By list.	Yes (Conditional) Note: If you specify the account identifier as a search criteria, you have to select the account identifier type.
Primary Account Identifier	Used to search an account with a particular identifier. Note: This field appears when the Account option is selected from the Search By list.	Yes (Conditional) Note: If you specify the account identifier type as a search criteria, you have to enter the account identifier.
Account Category	Used to search for accounts which belong to a particular account category. The valid values are: <ul style="list-style-type: none"> • Invoice Account • Settlement Account • Usage Account Note: This field appears when the Account option is selected from the Search By list.	No
Product	Used to search for accounts which are enrolled for a particular product. Note: The Search (🔍) icon appears corresponding to the Product field. On clicking the Search icon, the Product Search window appears.	No

Note:

You must specify at least one search criterion while searching for a person or account. One more search criterion is required when you are searching for a person or account using the division and/or customer class.

If you have specified any other search criterion along with the person ID or account ID the system ignores the additional search criterion and searches using the person ID or account ID respectively.

- **Search Results** - On clicking the **Search** button, the search results appear based on the specified search criteria. The **Search Results** section contains the following columns:

Column Name	Column Description
Person Information	Displays information about the person. In addition, this column has a context menu which helps in navigating to other screens in the application.

Column Name	Column Description
	<p>Note:</p> <p>It has a link. On clicking the link, the Person screen appears where you can view the details of the respective person.</p> <p>This column appears when the Person option is selected from the Search By list.</p>
Person Name	<p>Displays the name of the person.</p> <p>Note: This column appears when the Person option is selected from the Search By list.</p>
Primary Person Identifier Type	<p>Indicates the primary identifier type associated with the person.</p> <p>Note: This column appears when the Person option is selected from the Search By list.</p>
Primary Person Identifier	<p>Displays the primary person identifier.</p> <p>Note: This column appears when the Person option is selected from the Search By list.</p>
Account Information	<p>Displays information about the account. In addition, this column has a context menu which helps in navigating to other screens in the application.</p> <p>Note:</p> <p>It has a link. On clicking the link, the Account screen appears where you can view the details of the respective account.</p> <p>This column appears when the Account option is selected from the Search By list.</p>
Primary Account Identifier Type	<p>Indicates the primary identifier type associated with the account.</p> <p>Note: This column appears when the Account option is selected from the Search By list.</p>
Primary Account Identifier	<p>Displays the primary account identifier.</p> <p>Note: This column appears when the Account option is selected from the Search By list.</p>
Main Customer	<p>Indicates the main customer of the account.</p> <p>Note: This column appears when the Account option is selected from the Search By list.</p>
Division	<p>Indicates the division to which the person or account belongs.</p>
Customer Class	<p>Indicates the customer class to which the account belongs.</p> <p>Note: This column appears when the Account option is selected from the Search By list.</p>

Note:

You can view the 360° information of the person or account by clicking the **View** () icon corresponding to the record in the **Search Results** section.

Pagination is used to display limited number of records in the **Search Results** section. You can use the navigation links, such as **Previous** and **Next** to navigate between pages.

Related Topics

For more information on...	See...
How to search for a person	Searching for a Person on page 203
How to search for an account	Searching for an Account on page 204
How to view the 360° information of a person	Viewing the 360° Information of a Person on page 205
How to view the 360° information of an account	Viewing the 360° Information of an Account on page 207

Searching for a Person**Prerequisites**

To search for a person, you should have:

- Divisions, customer segments, person types, and person identifier types defined in the application
- Characteristic types defined in the application (where the characteristic entity is set to **Person**)

Procedure

To search for a person:

1. Click the **Menu** link in the **Application** toolbar.
A list appears.
2. From the **Main** menu, click **Customer Management** and then click **Customer 360° View..**
The **Customer 360° View** screen appears.
3. Select the **Person** option from the **Search By** list to indicate that you want to search for a person.
4. Enter the required search criteria in the **360° Search** zone.

Note:

You must specify at least one search criterion while searching for a person. One more search criterion is required when you are searching for a person using the division and/or customer class.

The criteria are grouped as indicated by line separators between the criteria. Each group is independent from the other, and only one group is used at a time for searching. If you enter criteria in more than one group, the criteria from the former group is used for searching. For example, if you enter the person name (in the second criteria group) and person identifier (in the fourth criteria group), the system searches using the person name instead of the person identifier.

You must specify division and/or customer segment when you are searching for a person using the city.

You must specify division, customer segment, or any other criteria in the second group when you are searching for a person using the person type.

If you have specified any other search criterion along with the person ID, the system ignores the additional search criterion and searches for the person using the person ID.

ORMB search engine supports wildcard search, where you can substitute the percentage (%) symbol as a stand in for any word or letter in a search criteria. The ‘%’ wildcard character is suffixed automatically at the end of the partial search criteria. Therefore, you may or may not specify the wildcard character at the end of the partial search criteria. However, you have to prefix the wildcard character manually wherever required.

The **Advanced Search** link appears in the right side of the **360° Search** zone. On clicking the **Advanced Search** link, additional fields appear in the zone which help you to refine the search.

If you select a predefined characteristic type, the **Search** (🔍) icon appears corresponding to the **Characteristic Value** field. On clicking the **Search** icon, you can search for a predefined characteristic value.

5. Click **Search**.

A list of persons that meet the search criteria appears in the **Search Results** section.

Related Topics

For more information on...	See...
Customer 360° View screen	Customer 360° View on page 198
360° Search zone	360° Search on page 198

Searching for an Account

Prerequisites

To search for an account, you should have:

- Divisions, customer classes, person types, person identifier types, and account identifier types defined in the application
- Characteristic types defined in the application (where the characteristic entity is set to **Account**)

Procedure

To search for an account:

1. Click the **Menu** link in the **Application** toolbar.
A list appears.
2. From the **Main** menu, click **Customer Management** and then click **Customer 360° View**.
The **Customer 360° View** screen appears.

3. Select the **Account** option from the **Search By** list to indicate that you want to search for an account.
4. Enter the required search criteria in the **360° Search** zone.

Note:

You must specify at least one search criterion while searching for an account. One more search criterion is required when you are searching for an account using the division and/or customer class.

The criteria are grouped as indicated by line separators between the criteria. Each group is independent from the other, and only one group is used at a time for searching. If you enter criteria in more than one group, the criteria from the former group is used for searching. For example, if you enter the person name (in the fourth criteria group) and account identifier (in the third criteria group), the system searches using the account identifier instead of the person name.

You must specify division and/or customer class when you are searching for an account using the city.

If you have specified any other search criterion along with the account ID, the system ignores the additional search criterion and searches for the account using the account ID.

ORMB search engine supports wildcard search, where you can substitute the percentage (%) symbol as a stand in for any word or letter in a search criteria. The '%' wildcard character is suffixed automatically at the end of the partial search criteria. Therefore, you may or may not specify the wildcard character at the end of the partial search criteria. However, you have to prefix the wildcard character manually wherever required.

The **Advanced Search** link appears in the right side of the **360° Search** zone. On clicking the **Advanced Search** link, additional fields appear in the zone which help you to refine the search.

If you select a predefined characteristic type, the **Search** (🔍) icon appears corresponding to the **Characteristic Value** field. On clicking the **Search** icon, you can search for a predefined characteristic value.

5. Click **Search**.

A list of accounts that meet the search criteria appears in the **Search Results** section.

Related Topics

For more information on...	See...
Customer 360° View screen	Customer 360° View on page 198
360° Search zone	360° Search on page 198

Viewing the 360° Information of a Person**Procedure**

To view the 360° information of a person:

1. Search for the person in the **Customer 360° View** screen.
2. In the **Search Results** section, click the **View** (👁) icon corresponding to the person whose details you want to view.

The **Person** tab appears in the **Customer 360° Information** screen. It contains the following zones:

- [Person Information](#) on page 214
- [Person Characteristics](#) on page 215
- [Linked Accounts](#) on page 215
- [Person Legal Hierarchy](#) on page 216

Note: The **Person Hierarchy** zone does not appear when you are viewing the 360° information of a person whose person type is set to **Parent Customer**.

- [Customer Contacts](#) on page 217
- [Enrolled Products](#) on page 217
- [Product Enrollment Information](#) on page 218

Note: By default, the **Product Enrollment Information** zone does not appear in the **Customer 360° Information** screen. It appears when you click the **Broadcast** () icon corresponding to the product in the **Enrolled Products** zone.

3. View the basic details of the person in the **Person Information** zone.
4. View the characteristics of the person in the **Person Characteristics** zone.
5. View the accounts linked to the person in the **Linked Accounts** zone.
6. If required, you can view the details of the account to which the person is associated in the **Account** tab.

Note:

If you are viewing the 360° information of a parent customer, the following zones appears in the **Account** tab when you click the **View** () icon corresponding to the account in the **Linked Accounts** zone:

- Account Information
- Account Persons
- Enrolled Products
- Auto Pay Details
- Account Characteristics
- Timeline
- Billing History
- Payment History
- Dispute Details
- Hold Details
- Overdue Process Details
- Trial Bills

7. View the accounts and the child persons and its accounts where the person is the main customer in the **Person Legal Hierarchy** zone.
8. View information about how and when the person was contacted in the **Customer Contacts** zone.
9. View the products for which the accounts of the person are enrolled in the **Enrolled Products** zone.
10. View information about the products for which the accounts of the person are enrolled in the **Product Enrollment Information** zone.
11. If required, you can view the details of the product for which the accounts of the person are enrolled in the **Product and Pricing** tab.

Note:

If you are viewing the 360° information of a parent customer, the following zones appears in the **Product and Pricing** tab when you click the **View** () icon corresponding to the product in the **Enrolled Products** zone:

- Product
- Price List Assignments
- Price List Price Items
- Effective Price Assignments for Person

Related Topics

For more information on...	See...
How to search for a person	Searching for a Person on page 203
Customer 360° Information screen	Customer 360° Information on page 213
Person tab	Customer 360° Information - Person on page 213
Account tab	Customer 360° Information - Account on page 218
Product and Pricing tab	Customer 360° Information - Product and Pricing on page 230

Viewing the 360° Information of an Account**Procedure**

To view the 360° information of an account:

1. Search for the account in the **Customer 360° View** screen.
2. In the **Search Results** section, click the **View** () icon corresponding to the account whose details you want to view.

The **Account** tab appears in the **Customer 360° Information** screen. It contains the following zones:

- [Account Information](#) on page 219
 - [Account Persons](#) on page 222
 - [Enrolled Products](#) on page 223
 - [Auto Pay Details](#) on page 224
 - [Account Characteristics](#) on page 222
 - [Timeline](#) on page 224
 - [Billing History](#) on page 227
 - [Payment History](#) on page 228
 - [Dispute Details](#) on page 228
 - [Hold Details](#) on page 228
 - [Overdue Process Details](#) on page 229
 - [Trial Bills](#) on page 229
3. View the basic details of the account in the **Account Information** zone.

4. View the persons to which the account is linked in the **Account Persons** zone.
5. If required, you can view the details of the person to which the account is linked in the **Person** tab.

Note:

If you are viewing the 360° information of a parent customer, the following zones appears in the **Person** tab when you click the **View** (🔗) icon corresponding to the account in the **Account Persons** zone:

- Person Information
- Person Characteristics
- Linked Accounts
- Person Legal Hierarchy
- Customer Contacts
- Enrolled Products
- Product Enrollment Information

6. View the products for which the account is enrolled in the **Enrolled Products** zone.
7. If required, you can view the details of the product for which the account is enrolled in the **Product and Pricing** tab.

Note:

If you are viewing the 360° information of a parent customer, the following zones appears in the **Product and Pricing** tab when you click the **View** (🔗) icon corresponding to the product in the **Enrolled Products** zone:

- Product
- Price List Assignments
- Associated Price Items
- Price List Price Items
- Effective Price Assignments for Account

8. View the automatic payment options defined for the account in the **Auto Pay Details** zone.
9. View the characteristics of the account in the **Account Characteristics** zone.
10. View the number of customer contacts, bills, and payments created for the account in a particular month in the **Timeline** zone.
11. View the billing summary of the account in the **Billing History** zone.
12. If required, you can view the details of the bill created for the account in the **Bill Information** screen.

Note:

If you are viewing the 360° information of an account, the following zones appears in the **Bill Information** screen when you click the **View** () icon corresponding to a bill information in the **Billing History** zone:

- Bill Information
- Settlement Activities
- Hold Details
- Offset Details
- Bill Line Items
- Garnishment Details
- Refund and Write Off Details
- Dispute Details

13. View the bill payment details of the account in the **Payment History** zone.

14. View the dispute requests created for the account in the **Dispute Details** zone.

15. View the details of the hold request for the accounts whose bills are kept on hold in the **Hold Details** zone.

16. View the details of the overdue process initiated for the bills of the account in the **Overdue Process Details** zone.

17. View the trial bills which are created for the account in the **Trial Bills** zone.

Related Topics

For more information on...	See...
How to search for an account	Searching for an Account on page 204
Customer 360° Information screen	Customer 360° Information on page 213
Account tab	Customer 360° Information - Account on page 218
Person tab	Customer 360° Information - Person on page 213
Product and Pricing tab	Customer 360° Information - Product and Pricing on page 230
Bill Information screen	Bill Information on page 243

Viewing Price Lists Assigned to a Person**Procedure**

To view the price lists assigned to a person:

1. Search for the person in the **Customer 360° View** screen.
2. In the **Search Results** section, click the **View** () icon corresponding to the person whose details you want to view.
The **Person** tab appears in the **Customer 360° Information** screen.
3. Click the **Product and Pricing** tab.

The **Product and Pricing** tab contains the following zones:

- [Product](#) on page 230
- [Price List Assignments](#) on page 231
- [Price List Price Items](#) on page 232

Note: By default, the **Price List Price Items** zone does not appear in the **Customer 360° Information** screen. It appears when you click the **Broadcast** () icon corresponding to the price list in the **Price List Assignments** zone.

- [Effective Price Assignments for Person](#) on page 237
-

4. View the price lists assigned to the person in the **Price List Assignments** zone.

Related Topics

For more information on...	See...
How to search for a person	Searching for a Person on page 203
Customer 360° Information screen	Customer 360° Information on page 213
Person tab	Customer 360° Information - Person on page 213
Product & Pricing tab	Customer 360° Information - Product and Pricing on page 230

Viewing Price Lists Assigned to an Account

Procedure

To view the price lists assigned to an account:

1. Search for the account in the **Customer 360° View** screen.
2. In the **Search Results** section, click the **View** () icon corresponding to the account whose details you want to view.

The **Account** tab appears in the **Customer 360° Information** screen.

3. Click the **Product and Pricing** tab.

The **Product and Pricing** tab contains the following zones:

- [Product](#) on page 230
- [Price List Assignments](#) on page 231
- [Price List Price Items](#) on page 232

Note: By default, the **Price List Price Items** zone does not appear in the **Customer 360° Information** screen. It appears when you click the **Broadcast** () icon corresponding to the price list in the **Price List Assignments** zone.

- [Effective Price Assignments for Account](#) on page 233

4. View the price lists assigned to the account in the **Price List Assignments** zone.



Related Topics

For more information on...	See...
How to search for an account	Searching for an Account on page 204
Customer 360° Information screen	Customer 360° Information on page 213
Person tab	Customer 360° Information - Person on page 213
Product & Pricing tab	Customer 360° Information - Product and Pricing on page 230

Viewing Price Items of the Price List Assigned to a Person

Procedure

To view the price items of the price list assigned to a person:

1. Search for the person in the **Customer 360° View** screen.
2. In the **Search Results** section, click the **View** () icon corresponding to the person whose details you want to view.
The **Person** tab appears in the **Customer 360° Information** screen.
3. Click the **Product and Pricing** tab.
4. In the **Price List Assignments** zone, click the **Broadcast** () icon corresponding to the price list whose price item details you want to view.
The **Price List Price Items** zone appears.
5. View the price items of the price list assigned to the person in the **Price List Price Items** zone.

Related Topics

For more information on...	See...
How to search for a person	Searching for a Person on page 203
Customer 360° Information screen	Customer 360° Information on page 213
Person tab	Customer 360° Information - Person on page 213
Product & Pricing tab	Customer 360° Information - Product and Pricing on page 230
Price List Assignments zone	Price List Assignments on page 231
Price List Price Items zone	Price List Price Items on page 232

Viewing Price Items of the Price List Assigned to an Account

Procedure

To view the price items of the price list assigned to an account:

1. Search for the account in the **Customer 360° View** screen.
2. In the **Search Results** section, click the **View** () icon corresponding to the account whose details you want to view.
The **Account** tab appears in the **Customer 360° Information** screen.

3. Click the **Product and Pricing** tab.
4. In the **Price List Assignments** zone, click the **Broadcast** () icon corresponding to the price list whose price item details you want to view.
The **Price List Price Items** zone appears.
5. View the price items of the price list assigned to the account in the **Price List Price Items** zone.



Related Topics

For more information on...	See...
How to search for an account	Searching for an Account on page 204
Customer 360° Information screen	Customer 360° Information on page 213
Account tab	Customer 360° Information - Account on page 218
Product and Pricing tab	Customer 360° Information - Product and Pricing on page 230
Price List Assignments zone	Price List Assignments on page 231
Price List Price Items zone	Price List Price Items on page 232

Viewing Price Items Associated to a Product

Procedure

To view the price items associated to a product:

1. Search for the account or person whose accounts are enrolled for a product in the **Customer 360° View** screen.
2. In the **Search Results** section, click the **View** () icon corresponding to the account or person whose details you want to view.
The **Account** or **Person** tab appears in the **Customer 360° Information** screen respectively.
3. Click the **View** () icon corresponding to a product in the **Enrolled Products** zone.
The **Product and Pricing** tab appears.
4. In the **Product** zone, click the **Broadcast** () icon corresponding to the product whose associated price items you want to view.
The **Associated Price Items** zone appears.
5. View the associated price items of the product in the **Associated Price Items** zone.

Viewing Enrollment Details of a Product

Procedure

To view the enrollment details of a product:

1. Search for the person whose accounts are enrolled for a product in the **Customer 360° View** screen.
2. In the **Search Results** section, click the **View** () icon corresponding to the person whose product enrollment details you want to view.
The **Person** tab appears in the **Customer 360° Information** screen.

3. In the **Enrolled Products** zone, click the **Broadcast** icon () corresponding to the product whose enrollment details you want to view.
The **Product Enrollment Information** zone appears.
4. View the enrollment details of the product in the **Product Enrollment Information** zone.

Related Topics

For more information on...	See...
Customer 360° Information screen	Customer 360° Information on page 213
How to search for a person	Searching for a Person on page 203
Customer 360° Information - Person tab	Customer 360° Information - Person on page 213
Enrolled Products zone	Enrolled Products on page 217
Product Enrollment Information zone	Product Enrollment Information on page 218

Customer 360° Information

The **Customer 360° Information** screen allows you to view:

- Basic details, characteristics, hierarchy, linked accounts, and the customer contacts of a person
- Basic details, characteristics, linked persons details, auto pay details, billing history, payment history, dispute details, hold details, and overdue process details of the person's account
- Details of price list and price list price items, effective price assignments for account, effective price assignments for person

This screen consists of the following tabs:

- [Customer 360° Information - Person](#) on page 213
- [Customer 360° Information - Account](#) on page 218
- [Customer 360° Information - Product and Pricing](#) on page 230

Note: If a person does not have an account, no data appears in the **Account** tab.

Customer 360° Information - Person

The **Person** tab displays information about the person. It also displays information about the person characteristics, accounts linked to the person, legal hierarchy of the person, details of the contacts made to the person, products to which the person's accounts are enrolled, and accounts enrolled for the product version. It consists of the following zones:

- [Person Information](#) on page 214
- [Person Characteristics](#) on page 215
- [Linked Accounts](#) on page 215
- [Person Legal Hierarchy](#) on page 216
- [Customer Contacts](#) on page 217
- [Enrolled Products](#) on page 217
- [Product Enrollment Information](#) on page 218

Person Information

The **Person Information** zone displays the details of the person. It contains the following sections:

- **Main** - Displays the basic information about the person. It contains the following fields:

Field Name	Field Description
Person Information	Displays information about the person. In addition, a context menu appears corresponding to this field which helps in navigating to other screens in the application.
	Note: It has a link. On clicking the link, the Person screen appears where you can view the details of the person.
Person Type	Indicates the type of the person. The valid values are: <ul style="list-style-type: none"> • Bill Group • Broker • Business • Group • Parent Customer • Person
Date of Birth	Displays the date when the person was born.
	Note: This field appears when the respective data is available for the person.

- **Person Identifiers** - Lists various types of identification associated with the person. It contains the following columns:

Column Name	Column Description
Person Identifier Type	Indicates the person identifier type.
Person Identifier	Displays the value of the person identifier type.

- **Contact Information** - Displays the contact details of the person. It contains the following fields:

Field Name	Field Description
Country	Indicates the country where the person is located.
Address 1	Displays the first line of the person's address. It may contain details, such as house number and apartment name.
Address 2	Displays the second line of the person's address. It may contain details, such as street name.
Address 3	Displays the third line of the person's address. It may contain the landmark details.
Address 4	Displays the fourth line of the person's address.
House Type	Indicates the type of the house.
Number 1	Displays the numeric information, if any, related to the address.
Number 2	Displays the numeric information, if any, related to the address.

Field Name	Field Description
In City Limit	Indicates whether the person resides within the city limit. The valid values are: <ul style="list-style-type: none"> • Yes • No
City	Displays the city where the person is located.
Geographic Code	Displays the geographic code of the address.
County	Displays the county where the person is located.
State	Indicates the state where the city or county is located.
Postal	Displays the postal or zip code of the address.
Email ID	Displays the e-mail ID of the person.

Note: The above mentioned fields appear in the **Contact Information** section when the respective data is available for the person.

- **Phone Details** – Lists the phone details of the person. It contains the following columns:

Column Name	Column Description
Phone Type	Indicates the type of the phone number.
Phone Number	Displays the phone number of the person.

Person Characteristics

The **Person Characteristics** zone lists the characteristics of the person. It contains the following columns:

Column Name	Column Description
Effective Date	Displays the date from when the characteristic is effective for the person.
Characteristic Type	Indicates the characteristic type.
Characteristic Value	Displays the value of the characteristic type.
Description	Displays the description of the characteristic value.
	Note: The data appears in this column when the type of characteristic value is set to Predefined Value or Foreign Key Value .

You can filter the list using the **Characteristic Type** field available in the **Filter** area. By default, the **Filter** area is hidden. You can view the **Filter** area by clicking the **Filters** (∨) icon in the upper right corner of this zone.

Linked Accounts

The **Linked Accounts** zone displays all the accounts of the person. It contains the following field:

Field Name	Field Description
Search By	Used to indicate the type of search to be performed. The valid values are: <ul style="list-style-type: none"> • Linked Accounts • Billing and Settlement Hierarchy

In addition, the **Linked Accounts** zone contains the following columns:

Column Name	Column Description
Account Information	<p>Displays information about the account of the person. In addition, this column has a context menu which helps in navigating to other screens in the application.</p> <p>Note:</p> <p>It has a link. On clicking the link, the Account screen appears where you can view the details of the respective account.</p> <p>This field appears when the Linked Accounts option is selected from the Search By list.</p>
Primary Account Identifier	<p>Displays the primary account identifier of the account.</p> <p>Note: This field appears when the Linked Accounts option is selected from the Search By list.</p>
Division	Displays the division to which the account belongs.
Billing Account Information	<p>Displays information about the billing account of the person. In addition, this column has a context menu which helps in navigating to other screens in the application.</p> <p>Note: This field appears when the Billing and Settlement Hierarchy option is selected from the Search By list.</p>
Invoice Construct	<p>Displays information about the invoice construct created for the account.</p> <p>Note: This field appears when the Billing and Settlement Hierarchy option is selected from the Search By list.</p>
IGA Master Account	<p>Displays information about the IGA master membership of the account.</p> <p>Note: This field appears when the Billing and Settlement Hierarchy option is selected from the Search By list.</p>
Settlement Construct	<p>Displays information about the settlement construct created for the account.</p> <p>Note: This field appears when the Billing and Settlement Hierarchy option is selected from the Search By list.</p>
Account Autopay	<p>Indicates whether the automatic payment process is defined for the account. The valid values are:</p> <ul style="list-style-type: none"> • Yes • No <p>Note: This field appears when the Billing and Settlement Hierarchy option is selected from the Search By list.</p>

Note: Pagination is used to display limited number of records in this zone. You can use the navigation links, such as **Previous** and **Next** to navigate between pages.

Person Legal Hierarchy

The **Person Legal Hierarchy** zone lists the following in a tree structure:

- Information string of accounts where the person is the main customer
- Information string of the parent persons
- Information string of the child persons

Each node in the tree has a link. The following table indicates the information string that appears in various scenarios:

If...	Then...
The person is the main customer of the account	The account information string appears. In addition, a context menu appears corresponding to this field which helps in navigating to other screens in the application. Note: It has a link. On clicking the link, the Account screen appears where you can view the details of the respective account.
The person has a child	The child person information string appears. In addition, a context menu appears corresponding to this field which helps in navigating to other screens in the application. Note: It has a link. On clicking the link, the Person screen appears where you can view the details of the respective child person.
The person has a parent person	The person information string appears. In addition, a context menu appears corresponding to this field which helps in navigating to other screens in the application. Note: It has a link. On clicking the link, the Person screen appears where you can view the details of the respective parent person.

Note:

The **Get More...** button in the bottom of the zone appears if the hierarchy list exceeds 25 records.

Customer Contacts

The **Customer Contacts** zone displays information about when and why the person was contacted. It contains the following columns:

Column Name	Column Description
Contact Date	Displays the date when the person was contacted.
Customer Contact Information	Displays information about the customer contact. Note: It has a link. On clicking the link, the Customer Contact screen appears where you can view the details of the customer contact.
Contact Type	Indicates the reason for the customer contact.
Comments	Displays additional information about the customer contact.

You can filter the list using various search criteria (such as, **On or Before Contact Date**, **Contact Class**, **Contact Type**, and **Show Open Contacts Only**) available in the **Filter** area. By default, the **Filter** area is hidden. You can view the **Filter** area by clicking the **Filters** (🔍) icon in the upper right corner of this zone.

Enrolled Products

The **Enrolled Products** zone lists the products to which the person's accounts are enrolled. It contains the following columns:

Column Name	Column Description
Product	Displays the name of the enrolled product.
	Note: It has a link. On clicking the link, the Product screen appears where you can view the details of the respective product.
Product Type	Indicates the type of the product.
Product Version	Displays the version of the enrolled product.
	Note: It has a link. On clicking the link, the Product Version screen appears where you can view the details of the respective product version.

Note: Pagination is used to display limited number of records in this zone. You can use the navigation links, such as **Previous** and **Next** to navigate between pages.

Product Enrollment Information

The **Product Enrollment Information** zone lists the accounts of the person which are enrolled for the product version. It contains the following columns:

Column Name	Column Description
Account Information	Displays the concatenated string of information about the person's account that is enrolled for the product version. In addition, a context menu appears corresponding to this field which helps in navigating to other screens in the application.
	Note: It has a link. On clicking the link, the Account screen appears where you can view the details of the respective account.
Start Date	Displays the date from when the account is enrolled for the product version.
End Date	Displays the date till when the account is enrolled for the product version.
Product Priority	Displays the priority of the enrolled product version.

By default, the **Product Enrollment Information** zone does not appear in the **Customer 360° Information - Person** tab. It appears when you click the **Broadcast** (📡) icon corresponding to an enrolled product in the **Enrolled Products** zone.

Customer 360° Information - Account

The **Account** tab displays the basic details, account persons, enrolled products, characteristics, automatic payment details, timeline, billing history, payment history, dispute details, hold details, overdue process details, and trial bills of an account. It contains the following zones:

- [Account Information](#) on page 219
- [Account Persons](#) on page 222
- [Enrolled Products](#) on page 223
- [Auto Pay Details](#) on page 224
- [Account Characteristics](#) on page 222

- [Timeline](#) on page 224
- [Billing History](#) on page 227
- [Payment History](#) on page 228
- [Dispute Details](#) on page 228
- [Hold Details](#) on page 228
- [Overdue Process Details](#) on page 229
- [Trial Bills](#) on page 229

Account Information

The **Account Information** zone displays the details of the account. It contains the following sections:

- **Main** – Displays the basic information about the account. It contains the following fields:

Field Name	Field Description
Account Information	Displays the concatenated string of information about the account separated by a comma (.). In addition, a context menu appears corresponding to this field which helps in navigating to other screens in the application. Note: It has a link. On clicking the link, the Account screen appears where you can view the details of the account.
Division	Displays the division to which the account belongs.

- **Accounting Information** – Displays various accounting related information. It contains the following fields:

Field Name	Field Description
Eligible for Accrual	Indicates whether accrual is calculated for the account. The valid values are: <ul style="list-style-type: none"> • Yes • No
Accrual Cycle	Indicates the accrual cycle for the account.
Account on Hold	Indicates whether the account is on hold. The valid values are: <ul style="list-style-type: none"> • Yes • No
Account on Dispute	Indicates whether an account is on dispute. The valid values are: <ul style="list-style-type: none"> • Yes • No
Overdue Process for Account	Indicates whether an overdue process is created for the account. The valid values are: <ul style="list-style-type: none"> • Yes • No
ECR Eligibility	Indicates whether the account is eligible for generating the earnings credit rate (ECR). The valid values are: <ul style="list-style-type: none"> • Yes

Field Name	Field Description
	<ul style="list-style-type: none"> No
ECR Offset Eligibility	Indicates whether the account is eligible for generating the earnings credit rate (ECR) offset. The valid values are: <ul style="list-style-type: none"> Yes No
ECR Offset Distribution Type	Indicates the type of the ECR offset distribution for the account.
ECR Account Distribution Priority	Displays the priority of the ECR distribution for the account.
ECR Expiration Cycle	Indicates the ECR expiration cycle.

- **Contact Information** – Displays the contact details of the account’s main customer. It contains the following fields:

Field Name	Field Description
Address Source	Indicates which address should be used to route the account’s bills and/or quotes via the postal service.
Country	Indicates the country where the main customer is located.
Address 1	Displays the first line of the main customer’s address. It may contain details, such as house number and apartment name.
Address 2	Displays the second line of the main customer’s address. It may contain details, such as street name.
Address 3	Displays the third line of the main customer’s address. It may contain the landmark details.
Address 4	Displays the fourth line of the main customer’s address.
House Type	Indicates the type of the house.
Number 1	Displays the numeric information, if any, related to the address.
Number 2	Displays the numeric information, if any, related to the address.
In City Limit	Indicates whether the main customer resides within the city limit. The valid values are: <ul style="list-style-type: none"> Yes No
City	Displays the city where the main customer is located.
Geographic Code	Displays the geographic code of the address.
County	Displays the county where the main customer is located.
State	Indicates the state where the city or county is located.
Postal	Displays the postal or zip code of the address.

Note:

The above mentioned fields except **Address Source** appear in the **Contact Information** section when the address source of the main customer is set to **Account Override** and the respective data is available for the account.

- **Account Identifiers** – Lists various types of identification associated with the account. It contains the following columns:

Column Name	Column Description
Account Identifier Type	Indicates the account identifier type.
Account Identifier	Displays the value of the account identifier type.

- **Billing Information** – Displays the billing information of the account. It contains the following fields:

Field Name	Field Description
Bill Cycle	<p>Indicates the bill cycle of the account.</p> <p>Note: It has a link. On clicking the link, the Bill Cycle screen appears where you can view the details of the bill cycle. This field appears when the respective data is available for the account.</p>
Last Bill	<p>Displays the concatenated string of information about the last processed bill of the account separated by a comma (,).</p> <p>Note: It has a link. On clicking the link, the Bill screen appears where you can view the details of the bill. This field appears when last bill information exists for the account.</p>
Previous Bill	<p>Displays the concatenated string of information about the bill prior to the last bill of the account separated by a comma (,). It has a link. On clicking the link, the information of bill appears in the Bill screen.</p> <p>Note: It has a link. On clicking the link, the Bill screen appears where you can view the details of the bill. This field appears when previous bill information exists for the account.</p>
Pending Bill	<p>Displays the concatenated string of information about the pending bill of the account. It has a link. On clicking the link, the information of bill appears in the Bill screen.</p> <p>Note: It has a link. On clicking the link, the Bill screen appears where you can view the details of the bill. This field appears when pending bill information exists for the account.</p>

Field Name	Field Description
Auto Pay	Indicates whether automatic payment option is defined for the account. The valid values are: <ul style="list-style-type: none"> • Yes • No

- **Financial Details** – Displays the financial details of the account. It contains the following fields:

Field Name	Field Description
Current Balance	Displays the current amount payable on the account.
Payoff Balance	Displays the total amount that is paid against the account.
Overdue Amount	Displays the overdue amount payable under the overdue process of the account.
Dispute Amount	Displays the dispute amount payable under the dispute request created for the account.
Last Payment Information	Displays the concatenated string of information about the last payment made on the account. It has a link. On clicking the link, the information of payment event appears in the Payment Event screen. <div style="border: 1px solid black; padding: 5px; margin-top: 5px;"> <p>Note:</p> <p>It has a link. On clicking the link, the Payment Event screen appears where you can view the details of the payments made on the account.</p> <p>This field appears when last payment exists for the account.</p> </div>

Account Characteristics

The **Account Characteristics** zone lists the characteristics of the account. It contains the following columns:

Column Name	Column Description
Effective Date	Displays the date from when the characteristic is effective for the account.
Characteristic Type	Indicates the characteristic type.
Characteristic Value	Displays the value of the characteristic type.
Description	Displays the description of the characteristic value. <div style="border: 1px solid black; padding: 5px; margin-top: 5px;"> <p>Note: The data appears in this column when the type of characteristic value is set to Predefined Value or Foreign Key Value.</p> </div>

You can filter the list using the **Characteristic Type** field available in the **Filter** area. By default, the **Filter** area is hidden. You can view the **Filter** area by clicking the **Filters** (🔍) icon in the upper right corner of this zone.

Account Persons

The **Account Persons** zone lists all the persons to which the account is linked. It contains the following columns:

Column Name	Column Description
Person Information	Displays information about the person to which the account is linked. In addition, this column has a context menu which helps in navigating to other screens in the application.
	Note: It has a link. On clicking the link, the Person screen appears where you can view the details of the respective person.
Relationship Type	Indicates how the person is related to the account.
Main Customer	Indicates whether the person is a main customer. The valid values are: <ul style="list-style-type: none"> • Yes • No
Financially Responsible	Indicates whether the person is financially responsible. The valid values are: <ul style="list-style-type: none"> • Yes • No

Note:

Pagination is used to display limited number of records in this zone. You can use the navigation links, such as **Previous** and **Next** to navigate between pages.

You can view additional information about the person in the **Person** tab by clicking the **View** () icon corresponding to the person in the **Account Persons** zone.

Enrolled Products

The **Enrolled Products** zone lists the products for which the account is enrolled. It contains the following columns:

Column Name	Column Description
Product	Displays the product for which the account is enrolled.
	Note: It has a link. On clicking the link, the Product screen appears where you can view the details of the respective product.
Product Version	Displays the version of the enrolled product.
	Note: It has a link. On clicking the link, the Product Version screen appears where you can view the details of the respective product version.
Start Date	Displays the start date of the product enrollment.
End Date	Displays the end date of the product enrollment.
Product Type	Indicates the type of product.
Product Priority	Displays the enrollment priority of the product.

Note:

Pagination is used to display limited number of records in this zone. You can use the navigation links, such as **Previous** and **Next** to navigate between pages.

You can view additional information about the enrolled product in the **Product and Pricing** tab by clicking the **View** () icon corresponding to a product in the **Enrolled Products** zone.

Auto Pay Details

The **Auto Pay Details** zone lists the automatic payment options defined for the account. It contains the following columns:

Column Name	Column Description
Start Date	Displays the date from when the automatic payment option is effective.
End Date	Displays the date till when the automatic payment option is effective.
Auto Pay Source Code	Indicates the source of funds used to make the automatic payment. For example, debit card or credit card.
Last Four Digits of Card	Displays the last four digits of the debit or credit card.
	Note: The data appears in this column when the external type of the auto pay source code's tender type is set to Credit Card Withdrawal .
Percentage	Indicates the percentage of automatic payment that must be made through the automatic payment option.
Priority	Indicates the order in which the automatic payment option should be considered for the effective date range.

Note: Pagination is used to display limited number of records in this zone. You can use the navigation links, such as **Previous** and **Next** to navigate between pages.

Timeline

The **Timeline** zone displays the following information in a graphical presentation:

- Number of regular bills created for the account in a particular month
- Number of adhoc bills created for the account in a particular month
- Number of payments created for the account in a particular month
- Number of dispute requests created for the account in a particular month
- Number of active hold requests created for the account in a particular month

It contains the following fields:

Field Name	Field Description	Mandatory (Yes or No)
Month	Used to indicate the month till when you want to display the above stated information.	Yes
	Note: By default, the current month appears in this field.	
Year	Used to indicate the year till when you want to display the above stated information.	Yes

Field Name	Field Description	Mandatory (Yes or No)
	Note: By default, the current year appears in this field.	

Depending on the month and year specified in the above fields, the data for the respective month and previous 11 months is presented in the grid. For example, if the Month and Year is set to April 2017, then the data for the May 2016, Jun 2016, Jul 2016, Aug 2016, Sep 2016, Oct 2016, Nov 2016, Dec 2016, Jan 2017, Feb 2017, Mar 2017, and Apr 2017 appears in the grid. To view the data for a different period, you must accordingly change the month and year and then click **Search** (🔍) icon.

You can use the **Previous Year** (⏪), **Previous Month** (⏴), **Next Month** (⏵), and **Next Year** (⏩) icons to change the values specified in the above mentioned fields.

The following table indicates the data and the manner in which the data is presented in the grid:

Row Name	Row Description						
Regular Bills	<p>A small icon appears for each regular bill created for the account in the respective month. For example, if three regular bills are created for the account in the month of Jan 2017, two bills are created in the month of Feb 2017, and one bill is created in the month of Apr 2017, then three icons appear in the Jan 2017 column, two icons appear in the Feb 2017 column, and one icon appears in the Apr 2017 column. A text indicating the day of the month on which the bill was due appears on the icon. You can either display the day of the due date or bill date on the icon depending on the requirement. The following table indicates the color in which the icon appears depending on the condition which is satisfied:</p> <table border="1"> <thead> <tr> <th>If the bill is...</th> <th>Then the icon appears in...</th> </tr> </thead> <tbody> <tr> <td>Fully Matched</td> <td>Green</td> </tr> <tr> <td>Unmatched</td> <td>Red</td> </tr> </tbody> </table> <p>On clicking the icon, the corresponding bill information appears at the bottom of the zone. It has a link. On clicking the link, the Bill screen appears where you can view the details of the bill.</p> <p>Note:</p> <p>If you want to display the day of the due date on the icon, you must set the Date To Use (D-Due Date, B-Bill Date) parameter in the C1-TL-OI-EVT algorithm to D. However, if you want to display the day of the bill date on the icon, you must set the Date To Use (D-Due Date, B-Bill Date) parameter in the C1-TL-OI-EVT algorithm to B.</p> <p>You can change the color in which the text appears on the icon and the color in which the icon appears when the above stated conditions are met through the C1-TL-OI-EVT algorithm.</p>	If the bill is...	Then the icon appears in...	Fully Matched	Green	Unmatched	Red
If the bill is...	Then the icon appears in...						
Fully Matched	Green						
Unmatched	Red						
Adhoc Bills	<p>A small icon appears for each adhoc bill created for the account in the respective month. For example, if three adhoc bills are created for the account in the month of Jan 2017, two bills are created in the month of Feb 2017, and one bill is created in the month of Apr 2017, then three icons appear in the Jan 2017 column, two icons appear in the Feb 2017 column, and one icon appears in the Apr 2017 column. A text indicating the day of the month on which the bill was due appears on the icon. You can either display the day of the due date or bill date on the icon depending on the requirement. The following table indicates the color in which the icon appears depending on the condition which is satisfied:</p>						

Row Name	Row Description													
	<table border="1" data-bbox="467 205 1466 352"> <thead> <tr> <th data-bbox="467 205 963 256">If the bill is...</th> <th data-bbox="971 205 1466 256">Then the icon appears in...</th> </tr> </thead> <tbody> <tr> <td data-bbox="467 258 963 308">Fully Matched</td> <td data-bbox="971 258 1466 308">Green</td> </tr> <tr> <td data-bbox="467 310 963 352">Unmatched</td> <td data-bbox="971 310 1466 352">Red</td> </tr> </tbody> </table> <p data-bbox="467 373 1466 436">On clicking the icon, the corresponding bill information appears at the bottom of the zone. It has a link. On clicking the link, the Bill screen appears where you can view the details of the bill.</p> <p data-bbox="467 457 1466 747">Note: If you want to display the day of the due date on the icon, you must set the Date To Use (D-Due Date, B-Bill Date) parameter in the C1-TL-OI-EVT algorithm to D. However, if you want to display the day of the bill date on the icon, you must set the Date To Use (D-Due Date, B-Bill Date) parameter in the C1-TL-OI-EVT algorithm to B. You can change the color in which the text appears on the icon and the color in which the icon appears when the above stated conditions are met through the C1-TL-OI-EVT algorithm.</p>		If the bill is...	Then the icon appears in...	Fully Matched	Green	Unmatched	Red						
If the bill is...	Then the icon appears in...													
Fully Matched	Green													
Unmatched	Red													
Payments	<p data-bbox="467 770 1466 993">A small icon appears for each payment created for the account in the respective month. For example, if one payment is created for the account in the month of Aug 2016, three payments are created in the month of Dec 2016, and four payments are created in the month of Mar 2017, then one icon appears in the Aug 2016 column, three icons appear in the Dec 2016 column, and four icons appear in the Mar 2017 column. A text indicating the day of the month on which the payment was created appears on the icon. The following table indicates the color in which the icon appears depending on the status of the payment:</p> <table border="1" data-bbox="467 1014 1466 1318"> <thead> <tr> <th data-bbox="467 1014 963 1064">Status</th> <th data-bbox="971 1014 1466 1064">Color</th> </tr> </thead> <tbody> <tr> <td data-bbox="467 1066 963 1117">Frozen</td> <td data-bbox="971 1066 1466 1117">Green</td> </tr> <tr> <td data-bbox="467 1119 963 1169">Canceled</td> <td data-bbox="971 1119 1466 1169">Red</td> </tr> <tr> <td data-bbox="467 1171 963 1222">Freezable</td> <td data-bbox="971 1171 1466 1222">Blue</td> </tr> <tr> <td data-bbox="467 1224 963 1274">Error</td> <td data-bbox="971 1224 1466 1274">Red</td> </tr> <tr> <td data-bbox="467 1276 963 1318">Incomplete</td> <td data-bbox="971 1276 1466 1318">Yellow</td> </tr> </tbody> </table> <p data-bbox="467 1339 1466 1434">On clicking the icon, the corresponding payment information appears at the bottom of the zone. It has a link. On clicking the link, the Payment screen appears where you can view the details of the payment.</p> <p data-bbox="467 1455 1466 1528">Note: You can change the color in which the text appears on the icon and the color in which the icon appears in the different status through the C1-TL-PY-EVT algorithm.</p>		Status	Color	Frozen	Green	Canceled	Red	Freezable	Blue	Error	Red	Incomplete	Yellow
Status	Color													
Frozen	Green													
Canceled	Red													
Freezable	Blue													
Error	Red													
Incomplete	Yellow													
Dispute Requests	<p data-bbox="467 1562 1466 1785">A small icon appears for each dispute request created for the account in the respective month. For example, if one dispute request is created for the account in the month of Aug 2016, three dispute requests are created in the month of Dec 2016, and four dispute request are created in the month of Mar 2017, then one icon appears in the Aug 2016 column, three icons appear in the Dec 2016 column, and four icons appear in the Mar 2017 column. A text indicating the day of the month on which the dispute request was created appears on the icon. The following table indicates the color in which the icon appears depending on the status of the dispute request:</p> <table border="1" data-bbox="467 1806 1466 1900"> <thead> <tr> <th data-bbox="467 1806 963 1856">Status</th> <th data-bbox="971 1806 1466 1856">Color</th> </tr> </thead> <tbody> <tr> <td data-bbox="467 1858 963 1900">Active</td> <td data-bbox="971 1858 1466 1900">Green</td> </tr> </tbody> </table>		Status	Color	Active	Green								
Status	Color													
Active	Green													

Row Name	Row Description										
	<table border="1"> <thead> <tr> <th>Status</th> <th>Color</th> </tr> </thead> <tbody> <tr> <td>Approved</td> <td>Green</td> </tr> <tr> <td>Rejected</td> <td>Red</td> </tr> <tr> <td>Approval In Progress</td> <td>Orange</td> </tr> <tr> <td>Draft</td> <td>Orange</td> </tr> </tbody> </table> <p>On clicking the icon, the corresponding dispute information appears at the bottom of the zone. It has a link. On clicking the link, the Dispute Request screen appears where you can view the details of the dispute.</p> <p>Note: You can change the color in which the text appears on the icon and the color in which the icon appears in the different status through the C1-TL-DP-EVT algorithm.</p>	Status	Color	Approved	Green	Rejected	Red	Approval In Progress	Orange	Draft	Orange
Status	Color										
Approved	Green										
Rejected	Red										
Approval In Progress	Orange										
Draft	Orange										
Processes on Hold	<p>A small icon appears for each active hold request for the account in the respective month depending upon the number of processes on hold. For example, if there is one active hold request having two processes on hold for the account in the month of Aug 2016 and two active hold requests as H1 and H2, having one process on hold for H1 hold request and four processes on hold for H2 hold request for the month of Dec 2016, then two icon appears in the Aug 2016 column and five icons appear in the Dec 2016 column. A text indicating the day of the month on which an entity was kept on hold appears on the icon. The following table indicates the color in which the icon appears depending on the status of the hold request:</p> <table border="1"> <thead> <tr> <th>Status</th> <th>Color</th> </tr> </thead> <tbody> <tr> <td>Active</td> <td>Green</td> </tr> </tbody> </table> <p>On clicking the icon, the corresponding hold information appears at the bottom of the zone. It has a link. On clicking the link, the Hold Request screen appears where you can view the details of the dispute.</p> <p>Note: You can change the color in which the text appears on the icon and the color in which the icon appears in the different status through the C1-TL-HR-EVT algorithm.</p>	Status	Color	Active	Green						
Status	Color										
Active	Green										

Billing History

The **Billing History** zone lists all the billing information of the account. It contains the following columns:

Column Name	Column Description
Bill Information	<p>Displays the concatenated string of information about the bill separate by a comma (.). In addition, this column has a context menu which helps in navigating to other screens in the application.</p> <p>Note: It has a link. On clicking the link, the Bill screen appears where you can view the details of the bill.</p>
Bill Amount	Displays the bill amount.
Unpaid Amount	Displays the unpaid amount of the bill.
Days Past Due	Displays the number of days past after the due date.
Billing Method	Displays the method used for generating bill.

You can filter the list using the **On or before Bill Date** field available in the **Filter** area. By default, the **Filter** area is hidden. You can view the **Filter** area by clicking the **Filters** (🔍) icon in the upper right corner of this zone.

Note: You can view additional information about the bill in the **Bill Information** screen by clicking the **View** (🔗) icon corresponding to the bill in the **Billing History** zone.

Payment History

The **Payment History** zone lists all the payment information of the account. It contains the following columns:

Column Name	Column Description
Payment Event Information	Displays the concatenated string of information about the payment event of the account separated by a comma (.). Note: It has a link. On clicking the link, the Payment Event screen appears where you can view the details of the payment event.
Payment Date	Displays the date when the payment is created or canceled for the account.
Payment Amount	Displays the amount paid through the tender.
Payment Status	Displays the current status of payment. The valid values are: <ul style="list-style-type: none"> • Canceled • Error • Freezable • Frozen • Incomplete
Tender Source	Displays the tender source through which the payment is remitted.

Note: Pagination is used to display limited number of records in this zone. You can use the navigation links, such as **Previous** and **Next** to navigate between pages.

Dispute Details

The **Dispute Details** zone lists the dispute requests that are created for the account. It contains the following columns:

Column Name	Column Description
Dispute Request Information	Displays the concatenated string of information about the dispute request separated by a comma (.). Note: It has a link. On clicking the link, the Dispute Request screen appears where you can view the details of the dispute request.
Dispute Amount	Displays the amount which is on dispute for the account.
Status	Displays the status of the dispute request.

Note: Pagination is used to display limited number of records in this zone. You can use the navigation links, such as **Previous** and **Next** to navigate between pages.

Hold Details

The **Hold Details** zone lists the active hold requests due to which the bills of the account are kept on hold. It contains the following columns:

Column Name	Column Description
Hold Request Information	Displays the concatenated string of information about the hold request separated by a comma (,).
	Note: It has a link. On clicking the link, the Hold Request screen appears where you can view the details of the hold request.
Status	Indicates the status of the hold request. The valid values are: <ul style="list-style-type: none"> • Active • Approval in Progress • Deferred Processing • Draft • Rejected • Released
Entity	Indicates the type of the entity for which the hold request is created in the system. The valid value is: <ul style="list-style-type: none"> • Account
Hold Reason	Displays the reason for which the hold request is created for the account.
Hold Process	Indicates the process that is kept on hold for the account.
Start Date	Displays the date from when the hold request is effective for the account.
End Date	Displays the date till when the hold request is effective for the account.

Overdue Process Details

The **Overdue Process Details** zone lists the overdue processes created for the bills of the account. It contains the following columns:

Column Name	Column Description
Overdue Process Information	Indicates the overdue process which is initiated for the bill and is currently in the Active status. In addition, this column has a context menu which helps in navigating to other screens in the application.
	Note: It has a link. On clicking the link, the Overdue Process screen appears where you can view the details of the respective overdue process.
Overdue Amount	Displays the overdue amount for the account.
Number of Overdue Bills	Displays the total number of bills that are overdue for the account.

Note: Pagination is used to display limited number of records in this zone. You can use the navigation links, such as **Previous** and **Next** to navigate between pages.

Trial Bills

The **Trial Bills** zone lists the trial bills which are created for the account. It contains the following columns:

Column Name	Column Description
Creation Date	Displays the date when the trial bill is created.
Trial Bill Information	Displays the concatenated string of information about the trial bill separated by comma (,).
	Note: It has a link. On clicking the link, the Trial Bill screen appears where you can view the details of the respective trial bill.
Current Charges	Displays the trial bill amount.

Customer 360° Information - Product and Pricing

The **Product and Pricing** tab allows you to view the details of the following:

- Products and its associated price items to which the account or account's of the person are enrolled
- Assigned price lists and its price items for the account or person
- Effective price assignments for the account or person

The **Product and Pricing** tab contains the following zones:

- [Product](#) on page 230
- [Associated Price Items](#) on page 231

Note: By default, the **Associated Price Items** zone does not appear in the **Product and Pricing** tab. It appears when you click the **Broadcast** (📡) icon corresponding to the product in the **Product** zone.

- [Price List Assignments](#) on page 231
- [Price List Price Items](#) on page 232

Note: By default, the **Price List Price Items** zone does not appear in the **Product and Pricing** tab. It appears when you click the **Broadcast** (📡) icon corresponding to a price list in the **Price List Assignments** zone.

- [Effective Price Assignments for Account](#) on page 233

Note: The **Effective Price Assignments for Account** zone appears when you viewing the enrolled products of an account.

- [Effective Price Assignments for Person](#) on page 237

Note: The **Effective Price Assignments for Person** zone appears when you viewing the enrolled products for the persons account.

Product

The **Product** zone lists the following in a tree structure:

- Information string about the product for which the account or account's of the person are enrolled

Note: It has a link. On clicking the link, the **Product** screen appears where you can view the details of the respective product.

- Information string about the product version

Note: It has a link. On clicking the link, the **Product Version** screen appears where you can view the details of the respective product.

- Information about the product services which are offered by the product version
- Information about the add-on product services which are offered in the packaged product.

Note:

By default, the data does not appear in the **Product** zone. It appears when you click the **View** () icon corresponding to a product in the **Enrolled Products** zone of the **Account** or **Person** tab of the **Customer 360° Information** screen.

On clicking the **Broadcast** () icon corresponding to the product, the **Associated Price Items** zone appears where you can view the associated price items of the product.

For more information on...	See...
Customer 360° Information screen	Customer 360° Information on page 213
How to search for an account	Searching for an Account on page 204
How to search for a person	Searching for a Person on page 203
Product and Pricing tab	Customer 360° Information - Product and Pricing on page 230
Account tab	Customer 360° Information - Account on page 218
Person tab	Customer 360° Information - Person on page 213
How to view the price items associated to a product	Viewing Price Items Associated to a Product on page 212

Associated Price Items

The **Associated Price Items** zone displays information about the price items associated with the product. It contains the following columns:

Field Name	Field Description
Sequence No.	Displays the sequence number of the associated price item.
Pricing Information	Displays the concatenated string of information about the price item pricing. Note: It has a link. On clicking the link, the Price Item Pricing screen appears where you can view the details of the respective price item pricing.
Price Item	Displays the price item code.

Note: Pagination is used to display limited number of records in this zone. You can use the navigation links, such as **Previous** and **Next** to navigate between pages.

By default, the **Associated Price Items** zone does not appear in the **Product and Pricing** tab. It appears when you click the **Broadcast** () icon corresponding to the product in the **Product** zone.

Price List Assignments

The **Price List Assignments** zone allows you to view and filter price lists that are currently assigned to the account or account's of the person. You will not find any records in this zone if the account of account's of the person does not have any price lists assigned to it. It contains the following columns:

Column Name	Column Description
Sequence No.	Displays the sequence number of the assigned price list.

Column Name	Column Description
Price List Information	<p data-bbox="589 207 1463 268">Displays information about the price list which is assigned to the account or account's of the person.</p> <p data-bbox="589 296 1463 357">Note: It has a link. On clicking the link, the Price List screen appears where you can view the details of the assigned price list.</p>
Assignment Level	<p data-bbox="589 399 1463 459">Indicates the level at which the price item pricing is defined in the customer hierarchy. The valid values are:</p> <ul data-bbox="618 478 1463 1476" style="list-style-type: none"> <li data-bbox="618 478 1430 510">• Account Agreed – Indicates price item pricing is agreed for the account. <li data-bbox="618 527 1463 588">• Account Price List – Indicates price item pricing is defined in the price list which is assigned to the account. <li data-bbox="618 604 1463 697">• Account Inherited Price List – Indicates price item pricing is inherited from the parent price list hierarchy defined for the price list which is assigned to the account. <li data-bbox="618 714 1463 774">• Customer Agreed – Indicates price item pricing is agreed for the main customer in the customer hierarchy. <li data-bbox="618 791 1463 852">• Customer Price List – Indicates price item pricing is defined in the price list which is assigned to the main customer. <li data-bbox="618 869 1463 930">• Default Price List – Indicates price item pricing defined in the price list is available in the default price list. <li data-bbox="618 947 1463 1008">• Global Price List – Indicates price item pricing defined in the price list is available in the global price list. <li data-bbox="618 1024 1463 1117">• Customer Inherited Price List – Indicates price item pricing is inherited from the parent price list hierarchy defined for the price list which is assigned to the main customer. <li data-bbox="618 1134 1463 1194">• Parent Customer Agreed – Indicates price item pricing is agreed for the parent customer in the customer hierarchy. <li data-bbox="618 1211 1463 1272">• Parent Customer Price List – Indicates price item pricing is defined in the price list which is assigned to the parent customer. <li data-bbox="618 1289 1463 1381">• Parent Customer Inherited Price List – Indicates price item pricing is inherited from the parent price list hierarchy defined for the price list which is assigned to the parent customer. <li data-bbox="618 1398 1463 1459">• Product Default Price List – Indicates product defined in the price list is available in the default price list.

Note: Pagination is used to display limited number of records in this zone. You can use the navigation links, such as **Previous** and **Next** to navigate between pages.

On clicking the **Broadcast** () icon corresponding to the assigned price list, the **Price List Price Items** zone appears where you can view the price items assigned to the price list.

Price List Price Items

The **Price List Price Items** zone lists the price items that are assigned to the price list. You will not find any records in this zone if the price list does not have any price items assigned to it. It contains the following columns:

Column Name	Column Description
Pricing Information	Displays the concatenated string of information about the price item pricing for the price list separated by a comma (,).
	Note: It has a link. On clicking the link, the Price Item Pricing screen appears where you can view the details of the respective price item pricing.
Pricing Parameters	Displays a comma-separated list of parameter values. The order in which parameter values appear in this column is controlled by the display order (which is defined while associating a parameter with a price item).
	Note: This column appears when the Multi Price Parameter option type of the Multi Parameter Based Pricing (C1_PPARM_FLG) feature configuration is set to True .
Pricing Status	Indicates the status of the price item pricing. The valid values are: <ul style="list-style-type: none"> • Draft • Active • Inactive • Proposed • Rejected • Template
Effective Start Date	Displays the date from when the price item pricing is effective for the price list.
Effective End Date	Displays the date till when the price item pricing is effective for the price list.
Price Assignment Type	Indicates the type of the price item pricing. The valid values are: <ul style="list-style-type: none"> • Regular • Post Processing • Post Processing – Invoice Based • Post Processing – Price Item Based
	Note: This column appears when the Multi Price Parameter option type of the Multi Parameter Based Pricing (C1_PPARM_FLG) feature configuration is set to True .

By default, the **Price List Price Items** zone does not appear in the **Product and Pricing** tab of the **Customer 360° Information** screen. It appears when you click the **Broadcast** (📡) icon corresponding to the assigned price list in the **Price List Assignments** zone.

You can filter the list using the **Price Item**, **Effective Start Date** fields available in the **Filter** area. By default, the **Filter** area is hidden. You can view the **Filter** area by clicking the **Filters** (🔍) icon in the upper right corner of this zone.

You can change the layout of this zone. For more information on how to change the layout, see [Changing the Layout](#) on page 4300.

Effective Price Assignments for Account

The **Effective Price Assignments for Account** zone lists the price item pricing (i.e. price assignments) which are effective on the current date. In other words, it lists effective pricing for price items or price item bundles assigned to the account either directly or through the customer hierarchy. The order in which the price assignments are listed is

controlled by the **Price Assignment Search** algorithm defined for the division to which the account belongs. If required, you can filter effective price assignments using various search criteria.

Note:

The **Effective Price Assignments for Account** zone appears when the **Customer 360° Information** is searched for account.

If the effective pricing is available for the price item, regular bundle (to which the price item belongs), and parent (regular) bundle (i.e. to which the regular bundle belongs) at the same level, the system lists the pricing depending on the value defined for the **Prefer Price Item Over Bundle** parameter in the price assignment search algorithm. If the value of the **Prefer Price Item Over Bundle** parameter is set to **Y**, the system lists effective pricing which is available for the price item. If the effective pricing is not available for the price item, then the system lists effective pricing which is available for the regular bundle at the same level. If the effective pricing is not available for the regular bundle, then the system lists effective pricing which is available for the parent bundle at the same level. However, if the value of the **Prefer Price Item Over Bundle** parameter is set to **N**, the system lists effective pricing which is available for the parent bundle. If the effective pricing is not available for the parent bundle, then the system lists effective pricing which is available for the regular bundle at the same level. If the effective pricing is not available for the regular bundle, then the system lists effective pricing which is available for the price item at the same level.

The **Effective Price Assignments for Account** zone contains the following two sections:



- **Search Criteria** – The **Search Criteria** section contains the following fields:

Field Name	Field Description	Mandatory (Yes or No)
Account ID	Indicates the account whose effective price assignments are listed in this zone.	Not applicable
Effective Pricing Date	Used to search price assignments which are effective on a particular date.	No
	Note: By default, this field is set to the system date.	
Pricing Status	Used to search price assignments with a particular status. The valid values are: <ul style="list-style-type: none"> • Draft • Active • Pending For Approval • Proposed 	No
	Note: By default, the Active option is selected.	
Show Product, Default, and Global Pricing	Used to search price assignments inherited from the default or global price list. The valid values are: <ul style="list-style-type: none"> • Yes – Used when you want to search price assignments inherited from either of the following: <ul style="list-style-type: none"> • Product-specific default price list defined for the division • Default price list defined for the division 	No

Field Name	Field Description	Mandatory (Yes or No)
	<ul style="list-style-type: none"> Global price list No – Used when you do not want to search price assignments inherited from either of the following: <ul style="list-style-type: none"> Product-specific default price list defined for the division Default price list defined for the division Global price list <p>Note: By default, the No option is selected.</p>	
Price Item	<p>Used to search price assignments of a particular price item or price item bundle.</p> <p>Note: The Search (🔍) icon appears corresponding to this field. On clicking the Search icon, the Price Item Search window appears.</p>	No

- **Search Results** – On clicking the **Search** button, the search results are filtered based on the specified search criteria. The **Search Results** section contains the following columns:

Column Name	Column Description
Pricing Information	<p>Displays the concatenated string consisting of pricing information and pricing ID for the account.</p> <p>Note: It has a link. On clicking the link, the Price Item Pricing screen appears where you can view the details of the respective price item pricing.</p>
Price Item	Displays the price item or price item bundle code.
Pricing Parameters	<p>Displays multiple parameters based on which the pricing is defined for the price item or price item bundle for assignment.</p> <p>Note: This column appears when the Multi Price Parameter option type of the Multi Parameter Based Pricing (C1_PPARM_FLG) feature configuration is set to True.</p>
Price Assignment Type	<p>Indicates the type of price assignment. The valid values are:</p> <ul style="list-style-type: none"> Regular Post Processing Post Processing – Invoice Based Post Processing – Price Item Based
Assignment Level	<p>Indicates the level at which the price item pricing is defined in the customer hierarchy. The valid values are:</p> <ul style="list-style-type: none"> Account Agreed

Column Name	Column Description
	<ul style="list-style-type: none"> • Account Price List • Account Inherited Price List • Customer Agreed • Customer Price List • Default Price List • Global Price List • Customer Inherited Price List • Parent Customer Agreed • Parent Customer Price List • Parent Customer Inherited Price List • Product Default Price List
Price List Information	<p>Displays information about the price list which is assigned to the account.</p> <p>Note: It has a link. On clicking the link, the Price List screen appears where you can view the details of the respective price list.</p>
Rate Schedule	<p>Indicates the rate schedule which is used for defining the price item pricing.</p> <p>Note: It has a link. On clicking the link, the Rate Schedule screen appears where you can view the details of the respective rate schedule.</p>
View Rate	<p>On Clicking the View () icon, the Effective Pricing Information screen appears where you can view the details of the persisted rate of the price item pricing.</p> <p>Note: The View icon appears when the Price Item Type is set to Rate.</p>
Edit	<p>On clicking the Edit () icon, the Price Item Pricing screen appears where you can edit the details of the existing price item pricing.</p> <p>Note: The Edit icon appears when the assignment level is Account Agreed.</p>
Override	<p>On clicking the Override () icon, the Price Item Pricing screen appears where you can override the price item pricing.</p>

Column Name	Column Description
	<p>Note:</p> <p>You can override a price item pricing assigned at any level in the customer hierarchy. On overriding a price item pricing, a new price item pricing which is specific to the account is defined at the account level and is then called account agreed pricing.</p> <p>A customer agreed or account agreed price assignments are effective for a particular duration and do not expire until you specify the end date manually. However, if you set the Expire Override Switch option type of the C1_EXP_OVRD feature configuration to Y, the system will automatically expire an agreed pricing when the agreed pricing of a customer or an account without end date is overridden. If you do not want an agreed pricing to automatically expire when it is overridden, you must set the Expire Override Switch option type of the C1_EXP_OVRD feature configuration to N.</p>
Effective Start Date	Displays the date from when the price item pricing is effective.
Effective End Date	Displays the date till when the price item pricing is effective.
Pricing Currency	Indicates the currency in which the price item pricing is defined.
Parent Person	Displays the name of the parent or grandparent customer from whom the price item pricing is inherited.

<p>Note:</p> <p>Pagination is used to display limited number of records in this zone. You can use the navigation links, such as Previous and Next to navigate between pages.</p> <p>The number of records that can be displayed in the Search Results section is controlled via the C1_PR_REC feature configuration. You can change the number of records that can be displayed using the Effective Pricing RecordSet Limit option type of the C1_PR_REC feature configuration. For more information, refer to Setting the C1_PR_REC Feature Configuration on page 4341</p>
--

By default, the **Filter** area is visible. You can hide the **Filter** area by clicking the **Filters** () icon in the upper right corner of this zone.

Note: .

Related Topics

For more information on...	See...
How to view 360° information of an account	Viewing the 360° Information of an Account on page 207
Customer 360° Information - Product and Pricing tab	Customer 360° Information - Product and Pricing on page 230

Effective Price Assignments for Person

The **Effective Price Assignments for Person** zone lists the price item pricing (i.e. price assignments) which are effective on the current date. In other words, it lists effective pricing for price items or price item bundles assigned to the person either directly or through the customer hierarchy. The order in which the price assignments are listed is controlled by the **Price Assignment Search** algorithm defined for the division to which the person belongs. If required, you can filter effective price assignments using various search criteria.

Note:

The **Effective Price Assignments for Person** zone appears when the **Customer 360° Information** is searched for person.

If the effective pricing is available for the price item, regular bundle (to which the price item belongs), and parent (regular) bundle (i.e. to which the regular bundle belongs) at the same level, the system lists the pricing depending on the value defined for the **Prefer Price Item Over Bundle** parameter in the price assignment search algorithm. If the value of the **Prefer Price Item Over Bundle** parameter is set to **Y**, the system lists effective pricing which is available for the price item. If the effective pricing is not available for the price item, then the system lists effective pricing which is available for the regular bundle at the same level. If the effective pricing is not available for the regular bundle, then the system lists effective pricing which is available for the parent bundle at the same level. However, if the value of the **Prefer Price Item Over Bundle** parameter is set to **N**, the system lists effective pricing which is available for the parent bundle. If the effective pricing is not available for the parent bundle, then the system lists effective pricing which is available for the regular bundle at the same level. If the effective pricing is not available for the regular bundle, then the system lists effective pricing which is available for the price item at the same level.

The **Effective Price Assignments for Person** zone contains the following two sections:



- **Search Criteria** – The **Search Criteria** section contains the following fields:

Field Name	Field Description	Mandatory (Yes or No)
Person ID	Indicates the person whose effective price assignments are listed in this zone.	Not applicable
Effective Pricing Date	Used to search price assignments which are effective on a particular date.	No
	Note: By default, this field is set to the system date.	
Pricing Status	Used to search price assignments with a particular status. The valid values are: <ul style="list-style-type: none"> • Draft • Active • Pending For Approval • Proposed 	No
	Note: By default, the Active option is selected.	
Show Product, Default, and Global Pricing	Used to indicate whether you want to search price assignments inherited from the default or global price list. The valid values are: <ul style="list-style-type: none"> • Yes – Used when you want to search price assignments inherited from either of the following: <ul style="list-style-type: none"> • Default price list defined for the division • Global price list • No – Used when you do not want to search price assignments inherited from either of the following: 	No

Field Name	Field Description	Mandatory (Yes or No)
	<ul style="list-style-type: none"> • Default price list defined for the division • Global price list <p>Note: By default, the No option is selected.</p>	
Price Item	<p>Used to search price assignments of a particular price item or price item bundle.</p> <p>Note: The Search (🔍) icon appears corresponding to this field. On clicking the Search icon, the Price Item Search window appears.</p>	No

- **Search Results** – On clicking the **Search** button, the search results are filtered based on the specified search criteria. The **Search Results** section contains the following columns:

Column Name	Column Description
Pricing Information	<p>Displays the concatenated string consisting of pricing information and pricing ID for the person.</p> <p>Note: It has a link. On clicking the link, the Price Item Pricing screen appears with the details of the respective price item pricing.</p>
Price Item	Displays the price item or price item bundle code.
Pricing Parameters	<p>Displays multiple parameters based on which the pricing is defined for the price item or price item bundle for assignment.</p> <p>Note: This column appears when the Multi Price Parameter option type of the Multi Parameter Based Pricing (C1_PPARM_FLG) feature configuration is set to True.</p>
Price Assignment Type	<p>Indicates the type of price assignment. The valid values are:</p> <ul style="list-style-type: none"> • Regular • Post Processing • Post Processing – Invoice Based • Post Processing – Price Item Based
Assignment Level	<p>Indicates the level at which the price item pricing is defined in the customer hierarchy. The valid values are:</p> <ul style="list-style-type: none"> • Customer Agreed • Customer Price List • Customer Inherited Price List • Default Price List • Global Price List • Parent Customer Agreed

Column Name	Column Description
	<ul style="list-style-type: none"> • Parent Customer Price List • Parent Customer Inherited Price List
Price List Information	<p>Displays information about the price list which is assigned to the person.</p> <p>Note: It has a link. On clicking the link, the Price List screen appears where you can view the details of the respective price list.</p>
Rate Schedule	<p>Indicates the rate schedule which is used for defining the price item pricing.</p> <p>Note: It has a link. On clicking the link, the Rate Schedule screen appears where you can view the details of the respective rate schedule.</p>
Edit	<p>On clicking the Edit  icon, the Price Item Pricing screen appears where you can edit the details of the existing price item pricing.</p> <p>Note: The Edit icon appears when the assignment level is Customer Agreed.</p>
Override	<p>On clicking the Override  icon, the Price Item Pricing screen appears where you can override the price item pricing.</p> <p>Note:</p> <p>You can override a price item pricing assigned at any level in the customer hierarchy. On overriding a price item pricing, a new price item pricing which is specific to the account is defined at the account level and is then called account agreed pricing.</p> <p>A customer agreed or account agreed price assignments are effective for a particular duration and do not expire until you specify the end date manually. However, if you set the Expire Override Switch option type of the C1_EXP_OVRD feature configuration to Y, the system will automatically expire an agreed pricing when the agreed pricing of a customer or an account without end date is overridden. If you do not want an agreed pricing to automatically expire when it is overridden, you must set the Expire Override Switch option type of the C1_EXP_OVRD feature configuration to N.</p>
Effective Start Date	Displays the date from when the price item pricing is effective.
Effective End Date	Displays the date till when the price item pricing is effective.
Pricing Currency	Indicates the currency in which the price item pricing is defined.
Parent Person	Displays the name of the parent or grandparent customer from whom the price item pricing is inherited.

Note:

Pagination is used to display limited number of records in this zone. You can use the navigation links, such as **Previous** and **Next** to navigate between pages.

The number of records that can be displayed in the **Search Results** section is controlled via the **C1_PR_REC** feature configuration. You can change the number of records that can be displayed using the **Effective Pricing RecordSet Limit** option type of the **C1_PR_REC** feature configuration. For more information, refer to [Setting the C1_PR_REC Feature Configuration](#) on page 4341



By default, the **Filter** area is visible. You can hide the **Filter** area by clicking the **Filters** () icon in the upper right corner of this zone.

Related Topics

For more information on...	See...
How to view 360° information of a person	Viewing the 360° Information of a Person on page 205
Customer 360° Information - Product and Pricing tab	Customer 360° Information - Product and Pricing on page 230

Viewing Enrollment Details of a Product**Procedure**

To view the enrollment details of a product:

1. Search for the person whose accounts are enrolled for a product in the **Customer 360° View** screen.
2. In the **Search Results** section, click the **View** () icon corresponding to the person whose product enrollment details you want to view.
The **Person** tab appears in the **Customer 360° Information** screen.
3. In the **Enrolled Products** zone, click the **Broadcast** icon () corresponding to the product whose enrollment details you want to view.
The **Product Enrollment Information** zone appears.
4. View the enrollment details of the product in the **Product Enrollment Information** zone.

Related Topics

For more information on...	See...
Customer 360° Information screen	Customer 360° Information on page 213
How to search for a person	Searching for a Person on page 203
Customer 360° Information - Person tab	Customer 360° Information - Person on page 213
Enrolled Products zone	Enrolled Products on page 217
Product Enrollment Information zone	Product Enrollment Information on page 218

Viewing the Bill Information**Procedure**

To view the bill information:

1. Search for the account, whose bill details you want to view, in the **Customer 360° View** screen.
2. In the **Search Results** section, click the **View** () icon corresponding to the account whose details you want to view.

The **Account** tab appears in the **Customer 360° Information** screen.

3. In the **Billing History** zone, click the **View** () icon corresponding to the bill whose details you want to view.

The **Bill Information** screen appears. It consists of the following zones:

- [Bill Information](#) on page 243
 - [Settlement Activities](#) on page 244
 - [Hold Details](#) on page 244
 - [Offset Details](#) on page 245
 - [Bill Line Items](#) on page 246
 - [Garnishment Details](#) on page 246
 - [Refund and Write Off Details](#) on page 247
 - [Dispute Details](#) on page 247
4. View the basic details of the bill in the **Bill Information** zone.
 5. View the settlement activities of the bill in the **Settlement Activities** zone.
 6. View the active hold requests due to which the bill is kept on hold in the **Hold Details** zone.
 7. View the offset requests through which the bill is offset against another bill in the **Offset Details** zone.
 8. View the selected bill's bill line item in the **Bill Line Items** zone.
 9. View the garnishment adjustments of the bill in the **Garnishment Details** zone.
 10. View the refund and write off requests through which the bill or its bill segment is either refunded or written off in the **Refund and Write Off Details** zone.
 11. View the dispute requests that are created against the bill in the **Dispute Details** zone.

Related Topics

For more information on...	See...
How to search for an account	Searching for an Account on page 204
Customer 360° Information screen	Customer 360° Information on page 213
Account tab	Customer 360° Information - Account on page 218
Billing History zone	Billing History on page 227
Bill Information screen	Bill Information on page 243

Viewing Price Items Associated to a Product

Procedure

To view the price items associated to a product:

1. Search for the account or person whose accounts are enrolled for a product in the **Customer 360° View** screen.

2. In the **Search Results** section, click the **View** (🔗) icon corresponding to the account or person whose details you want to view.
The **Account** or **Person** tab appears in the **Customer 360° Information** screen respectively.
3. Click the **View** (🔗) icon corresponding to a product in the **Enrolled Products** zone.
The **Product and Pricing** tab appears.
4. In the **Product** zone, click the **Broadcast** (📡) icon corresponding to the product whose associated price items you want to view.
The **Associated Price Items** zone appears.
5. View the associated price items of the product in the **Associated Price Items** zone.

Bill Information

The **Bill Information** screen allows you to view:

- Basic details about the bill
- Settlement activities, such as payment, offset, refund, or write off through which the bill is settled
- Active hold requests due to which the bill is kept on hold
- Offset requests through which the bill is offset against another bill
- Bill line items of the bill
- Garnishment adjustments of the bill
- Refund and write off requests through which the bill or its bill segment is either refunded or written off
- Dispute requests due to which bill is kept on hold

The **Bill Information** screen contains of the following zones:

- [Bill Information](#) on page 243
- [Settlement Activities](#) on page 244
- [Hold Details](#) on page 244
- [Offset Details](#) on page 245
- [Bill Line Items](#) on page 246
- [Garnishment Details](#) on page 246
- [Refund and Write Off Details](#) on page 247
- [Dispute Details](#) on page 247

Bill Information

The **Bill Information** zone displays the details of the bill. It contains the following section:

- **Main** - Displays the basic information about the bill. It contains the following fields:

Field Name	Field Description
Bill Information	Displays the concatenated string of information about the bill separated by a comma (.). In addition, a context menu appears corresponding to this field which helps in navigating to other screens in the application.

Field Name	Field Description
	Note: It has a link. On clicking the link, the Bill screen appears where you can view the details of the bill.
Alternate Bill ID	Displays the alternate bill ID. Note: This field appears only when the respective data is available for the bill.
Account Information	Indicates the account for which the bill is generated. In addition, a context menu appears corresponding to this field which helps in navigating to other screens in the application. Note: It has a link. On clicking the link, the Account screen appears where you can view the details of the account.

Settlement Activities

You may settle a bill by making a payment, offsetting a bill, refunding a bill, or by writing off a bill against the pay instructions. The **Settlement Activities** zone lists the activities related to the bill or its bill settlement. It contains the following columns:

Column Name	Column Description
Activity Date	Displays the date when the settlement activity was performed in the system.
Activity Type	Indicates the type of the activity. The valid values are: <ul style="list-style-type: none"> • Payment • Offset • Refund • Write Off
Amount	Indicates the amount settled through the activity.
Related Object Information	Displays additional information about the settlement activity.
Related Object ID	Displays the concatenated string of information about the payment, offset request, refund request, or write off request depending on the type of the settlement activity. Note: It has a link. On clicking the link, the Payment, Offset Request, Refund Request, or Write Off Request screen appears where you can view the details of the respective settlement activity.

Hold Details

The **Hold Details** zone lists the active hold requests due to which the bill is kept on hold. It contains the following columns:

Column Name	Column Description
Hold Request Information	Displays information about the hold request. Note: It has a link. On clicking the link, the Hold Request screen appears where you can view the details of the hold request.

Column Name	Column Description
Status	Indicates the status of the hold request. The valid values are: <ul style="list-style-type: none"> • Active • Approval in Progress • Deferred Processing • Draft • Rejected • Released
Entity	Indicates the type of the entity. The valid values are: <ul style="list-style-type: none"> • Person • Account • Bill
Entity Information	Displays the concatenated string of information about the entity for which the hold request is created. In addition, this column has a context menu which helps in navigating to other screens in the application. <p>Note: It has a link. On clicking the link, the Person, Account, or Bill screen appears where you can view the details of the respective entity.</p>
Start Date	Displays the date from when the entity is kept on hold.
End Date	Displays the date till when the entity is kept on hold.

Note: Pagination is used to display limited number of records in this zone. You can use the navigation links, such as **Previous** and **Next** to navigate between pages.

Offset Details

The **Offset Details** zone lists the offset requests through which the bill is offset against another bill. It contains the following columns:

Column Name	Column Description
Offset Request Information	Displays the concatenated string of information about the offset request separated by a comma (.). <p>Note: It has a link. On clicking the link, the Offset Request screen appears where you can view the details of the respective offset request.</p>
Offset Amount	Indicates the bill amount which is offset against another bill.
Creation Mode	Indicates the mode in which the offset request is created. The valid values are: <ul style="list-style-type: none"> • Automatic • Manual

Note: Pagination is used to display limited number of records in this zone. You can use the navigation links, such as **Previous** and **Next** to navigate between pages.

Bill Line Items

The **Bill Line Items** zone lists the information about the selected bill's bill line item. It contains the following columns:

Column Name	Column Description
Bill Line Item	Displays the concatenated string of information about the bill line item of the selected bills separated by a comma (.). The valid values are: <ul style="list-style-type: none"> • Bill Segment • Adjustment
Bill Line Item Information	Displays the concatenated string of information about the bill line item separated by a comma (.). In addition, a context menu appears corresponding to this field which helps in navigating to other screens in the application. Note: It has a link. On clicking the link, the Bill Segment or Adjustments screen appears where you can view the details of the respective bill segment or adjustment
Amount	Displays the amount of the bill line item.
Contract Information	Displays the concatenated string of information about the contract against which the bill segment or adjustment is created. In addition, a context menu appears corresponding to this field which helps in navigating to other screens in the application. Note: It has a link. On clicking the link, the Contract screen appears where you can view the details of the respective contract.

Note: Pagination is used to display limited number of records in this zone. You can use the navigation links, such as **Previous** and **Next** to navigate between pages.

You can filter the list using the **Bill Segment Date From** and **To** fields available in the **Filter** area. By default, the **Filter** area is hidden. You can view the **Filter** area by clicking the **Filters** (🔍) icon in the upper right corner of this zone.

Garnishment Details

The **Garnishment Details** zone lists the garnishment adjustments that are created against the bill. It contains the following columns:

Column Name	Column Description
Garnishment Contract ID	Displays the garnishment contract ID. In addition, this column has a context menu which helps in navigating to other screens in the application. Note: It has a link. On clicking the link, the Contract screen appears where you can view the details of the contract.
Garnishment Amount	Displays the garnishment amount.

Note: Pagination is used to display limited number of records in this zone. You can use the navigation links, such as **Previous** and **Next** to navigate between pages.

You can change the layout of this zone. For more information on how to change the layout, see [Changing the Layout](#) on page 4300.

Refund and Write Off Details

The **Refund and Write Off Details** zone lists the refund and write off requests through which the bill or its bill segment is either refunded or written off. It contains the following columns:

Column Name	Column Description
Create Date/Time	Displays the date and time when the refund or write off request is created.
Refund/Write Off Request Information	Displays the concatenated string of information about the refund or write off request separated by a comma (.).
	Note: It has a link. On clicking the link, the Refund Request or Write Off Request screen appears depending on whether the request is created for refund or write off.
Refund/Write Off Amount	Displays the total refund or write off amount.
Status	Indicates the status of the refund or write off request. The valid values are: <ul style="list-style-type: none"> • Approval In Progress • Cancelled • Deferred Processing • Draft • Processed • Rejected • Voided
Action	Indicates whether the request is created for refund or write off. The valid values are: <ul style="list-style-type: none"> • Refund • Write Off
Account Information	Displays the concatenated string of information about the account for which the refund or write off request is created. In addition, this column has a context menu which helps in navigating to other screens in the application.
	Note: It has a link. On clicking the link, the Account screen appears where you can view the details of the account.
Created By	Indicates the user who has created the refund or write off request.

Note: Pagination is used to display limited number of records in this zone. You can use the navigation links, such as **Previous** and **Next** to navigate between pages.

You can filter the list using the **Action** field available in the **Filter** area. By default, the **Filter** area is hidden. You can view the **Filter** area by clicking the **Filters** (🔍) icon in the upper right corner of this zone.

Dispute Details

The **Dispute Details** zone lists the dispute requests that are created for the bill of an account. It contains the following columns:

Column Name	Column Description
Creation Date Time	Displays the date and time when the dispute request is created for the bill.
Dispute Request ID	Displays the concatenated string of information about the dispute request separated by a comma (,).
	Note: It has a link. On clicking the link, the Dispute Request screen appears where you can view the details of the respective dispute request.
Dispute Amount	Displays the amount which is on dispute for the bill.
Status	Displays the status of the dispute request.
Account Information	Displays the concatenated string of information about the account for which the bill dispute request is created separated by a comma (,). In addition, a context menu appears corresponding to this field which helps in navigating to other screens in the application.
	Note: It has a link. On clicking the link, the Account screen appears where you can view the details of the account.
Created By	Indicates the user who has created the dispute request.

Note: Pagination is used to display limited number of records in this zone. You can use the navigation links, such as **Previous** and **Next** to navigate between pages.

Chapter 3

Invoicing Group

Topics:

- [Manage Invoicing Groups](#)
- [Invoicing Group Maintenance — Add/Edit](#)
- [Invoicing Group Information](#)

Invoicing group allows you to combine the charges for multiple accounts onto one bill for each billing period. It consists of the following:

- **Master Account** - The group level account that controls the billing.
- **Member Accounts** - The accounts whose bills are aggregated at the group level.

The following figure is a graphical representation of an invoicing group:

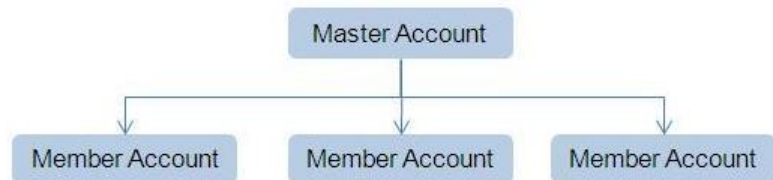

You can create an invoicing group by adding member accounts to the master account. An account can be the master account in the invoicing group when its **Invoice Group Account** characteristic type is set to **Y**. On the other hand, an account can be added as a member to the master account when its **Invoice Group Account** characteristic type is set to **N**.

Note: You can define the Invoice Group Account characteristic for the account when the **Invoice Group Account** option type in the **C1_ACCTINFO** feature configuration is set. If the **Invoice Group Account** option type in the **C1_ACCTINFO** feature configuration is not set, you will not be able to indicate whether the account is a master or member account. For more information, refer to [Setting the C1_ACCTINFO Feature Configuration](#) on page 4306.

There is no restriction on the number of accounts that can be added to the master account. The accounts in the invoicing group can belong to different persons and may have different currencies, but they should be from the same banking division and person hierarchy. If the member accounts have a different invoice currency from the master account, the member account's charges will be converted to the master account's currency during billing.

Balances are maintained at the master account level. Bills are added to the master account's balance, and payments are subtracted from that balance. However, the charges can be traced back to the originating member accounts. The master account cannot have charges of its own; all charges come from the member accounts. However, when an account does not belong to any master account, it is billed individually with its charges appearing on the bill.

The contracts linked at the member level are duplicated at the master level when member accounts are added to the master account. However, note that only contracts which are eligible for billing are duplicated at the master level. Once a contract is duplicated at the master level, you need to activate the contract at the master level. Otherwise, the charges will be billed to the member account instead of the master account.

Manage Invoicing Groups

The **Manage Invoicing Groups** screen allows you to search for the master and member accounts using various search criteria. Through this screen, you can navigate to the **Invoicing Group Maintenance – Add/Edit** and **Invoicing Group Information** screens.

This screen contains the following two sections:

- Search Criteria
- Search Results

Searching for a Master Account

Prerequisites

To search for a master account, you should have:

- Divisions, billing cycles, and customer classes defined in the application
- Master accounts created in the application

Procedure

To search for a master account:

1. Click the **Menu** link in the **Application** toolbar.
A list appears.
2. From the **Main** menu, click **Billing Management** and then click **Manage Invoicing Groups**.

The **Manage Invoicing Groups** screen appears.

Field Name	Field Description	Mandatory (Yes or No)
Invoicing Group Assignment Type	Used to indicate whether you want to search for a master or member account.	Yes
Account ID	Used to specify the account ID.	No
Division	Used to specify the division whose accounts you want to search.	No
Account Identifier Type	Used to specify the account identifier type.	Yes (Conditional) Note: If you enter the account identifier as a search criteria, you have to select the account identifier type.
Account Identifier	Used to specify the value of the account identifier type.	Yes (Conditional) Note: If you specify the account identifier type as a search criteria, you have to enter the account identifier.
Person Name	Used to specify the person whose accounts you want to search.	Yes (Conditional)

Field Name	Field Description	Mandatory (Yes or No)
		Note: If you specify the billing cycle or person class as a search criteria, you have to specify the person name.
Billing Cycle	Used to specify the billing cycle during which the account is billed.	No
Person Class	Used to specify the customer class of the account.	No

The criteria are grouped as indicated by line separators between the criteria. Each group is independent from the other, and only one group is used at a time for searching. If you enter criteria in more than one group, the criteria from the first group is used for searching. For example, if you enter Account ID and Person Name (which are in different criteria groups), the system searches using Account ID, which appears before Person Name.

Note: You must specify at least one search criterion while searching for a master account.

3. Select **Master** from the **Invoicing Group Assignment Type** list.
4. Specify the search criteria in any of the criteria groups.
5. Click **Search**.

The master accounts that meet the search criteria and to which you have access based on the account's access group appear in the search results. The **Search Results** section contains the following columns:

Column Name	Column Description
Account ID	Displays the master account ID. Note: It has a link. On clicking the link, the Invoicing Group Maintenance – Add/Edit screen appears where you can view the details of the respective master account.
Account Identifier Type	Displays the account identifier type of the master account.
Account Identifier	Displays the value of the account identifier type.
Account Currency	Displays the invoice currency of the master account.
Division	Displays the division to which the master account belongs.
Person Name	Displays the name of the main customer.
Customer Class	Displays the customer class of the master account.
Billing Cycle	Displays the billing cycle during which the master account is billed.

Related Topics

For more information on...	See...
Manage Invoicing Groups screen	Manage Invoicing Groups on page 251

Searching for a Member Account

Prerequisites

To search for a member account, you should have:

- Divisions, billing cycles, and customer classes defined in the application
- Accounts added as a member to the master accounts

Procedure

To search for a member account:

1. Click the **Menu** link in the **Application** toolbar.
A list appears.
2. From the **Main** menu, click **Billing Management** and then click **Manage Invoicing Groups**.

The **Manage Invoicing Groups** screen appears. It contains the following fields:

Field Name	Field Description	Mandatory (Yes or No)
Invoicing Group Assignment Type	Used to indicate whether you want to search for a master or member account.	Yes
Account ID	Used to specify the account ID.	No
Division	Used to specify the division whose accounts you want to search.	No
Account Identifier Type	Used to specify the account identifier type.	Yes (Conditional) Note: If you enter the account identifier as a search criteria, you have to select the account identifier type.
Account Identifier	Used to specify the value of the account identifier type.	Yes (Conditional) Note: If you specify the account identifier type as a search criteria, you have to enter the account identifier.
Person Name	Used to specify the person whose accounts you want to search.	Yes (Conditional) Note: If you specify the billing cycle or customer class as a search criteria, you have to specify the person name.
Billing Cycle	Used to specify the billing cycle during which the account is billed.	No
Customer Class	Used to specify the customer class of the account.	No

The criteria are grouped as indicated by line separators between the criteria. Each group is independent from the other, and only one group is used at a time for searching. If you enter criteria in more than one group, the criteria from the first group is used for searching. For example, if you enter Account ID and Person Name (which are in different criteria groups), the system searches using Account ID, which appears before Person Name.

Note: You must specify at least one search criterion while searching for a member account.

3. Select **Member** from the **Invoicing Group Assignment Type** list.

4. Specify the search criteria in any of the criteria groups.
5. Click **Search**.

The member accounts that meet the search criteria and to which you have access based on the account's access group appear in the search results. The **Search Results** section contains the following columns:

Column Name	Column Description
Account ID	Displays the member account ID. Note: It has a link. On clicking the link, the Invoicing Group Information screen appears where you can view the details of the respective member account.
Account Identifier Type	Displays the account identifier type of the member account.
Account Identifier	Displays the value of the account identifier type.
Account Currency	Displays the invoice currency of the member account. Note: If the member account has a different invoice currency from the master account, the member account's charges will be converted to the master account's currency during billing.
Division	Displays the division to which the member account belongs.
Person Name	Displays the main person of the member account.
Customer Class	Displays the customer class of the member account.
Master Account Identifier Type	Displays the primary account identifier type of the master account.
Master Account Identifier	Displays the value of the primary account identifier type.
Master Person Name	Displays the main person of the master account.
Billing Cycle	Displays the billing cycle during which the member account is billed.

Related Topics

For more information on...	See...
Manage Invoicing Groups screen	Manage Invoicing Groups on page 251

Viewing the Master Account Details

Procedure

To view the master account details:

1. Search for the master account in the **Manage Invoicing Groups** screen.
2. In the **Search Results** section, click the link in the **Account ID** column corresponding to the master account whose details you want to view.

The **Invoicing Group Maintenance – Add/Edit** screen appears.

3. View the accounts that are already added to the master account in the **Member Accounts** zone.

Related Topics

For more information on...	See...
How to search for a master account	Searching for a Master Account on page 251
Invoicing Group Maintenance – Add/Edit screen	Invoicing Group Maintenance — Add/Edit on page 255
Member Accounts zone	Member Accounts on page 256

Viewing the Member Account Details

Procedure

To view the member account details:

1. Search for the member account in the **Manage Invoicing Groups** screen.
2. In the **Search Results** section, click the link in the **Account ID** column corresponding to the member account whose details you want to view.

The **Invoicing Group Information** screen appears.

3. View the member account details in the **Selected Member Account** zone, and its master account details in the **Invoicing Group Information** zone.

Related Topics

For more information on...	See...
How to search for a member account	Searching for a Member Account on page 252
Invoicing Group Information screen	Invoicing Group Information on page 262
Invoicing Group Information zone	Invoicing Group Information on page 262
Selected Member Account zone	Selected Member Account on page 262

Invoicing Group Maintenance — Add/Edit

The **Invoicing Group Maintenance – Add/Edit** screen allows you to view the details of the master account. It also allows you to add, edit, and remove member accounts from the master account. This screen consists of the following zones:

- [Account Information](#) on page 255
- [Member Accounts](#) on page 256
- [Edit Member Account Assignment](#) on page 256
- [Search Accounts to Add](#) on page 257
- [Add Member](#) on page 258

Account Information

The **Account Information** zone displays the details of the master account. This zone contains the following fields:

Field Name	Field Description
Invoicing Group Assignment Type	Indicates that the selected account is a master account.
Person Name	Displays the name of the main customer.
Primary Account Identifier	Displays the primary account identifier type of the master account along with its value.
Customer Class	Displays the customer class of the master account.
Account Currency	Displays the invoice currency of the master account.
Billing Cycle	Displays the billing cycle during which the master account is billed.
Division	Displays the division to which the master account belongs.

Note: All fields in the **Account Information** zone are read-only.

Member Accounts

The **Member Accounts** zone lists the member accounts of the master account. This zone contains the following columns:

Column Name	Column Description
Account Identifier Type	Displays the primary account identifier type of the member account.
Account Identifier	Displays the value of the primary account identifier type.
Account Currency	Displays the invoice currency of the member account. Note: During billing, the charges for the member account are calculated in this currency and then converted to the master account's currency.
Effective Start Date	Displays the date from when the charges for the member account appears on the bill of the master account.
Effective End Date	Displays the date till when the charges for the member account appears on the bill of the master account.
Person Name	Displays the name of the main customer.
Customer Class	Displays the customer class of the member account.
Billing Cycle	Displays the billing cycle during which the member account is billed. Note: If the account is removed from the master account, it will be billed during this billing cycle.

On clicking the **Broadcast** () icon corresponding to the member account, the **Edit Member Account Assignment** zone appears with the details of the respective member account.

Edit Member Account Assignment

The **Edit Member Account Assignment** zone allows you to edit the assignment details of the member account. This zone contains the following fields:

Field Name	Field Description	Mandatory (Yes or No)
Effective Start Date	Used to modify the date from when you want the charges for the member account to appear on the bill of the master account.	Yes
	Note: You can modify the date when it is a future date.	
Invoicing Group Assignment Type	Indicates that the account is a member account.	Not applicable
Effective End Date	Used to modify the date till when you want the charges for the member account to appear on the bill of the master account.	No
	Note: You can modify the date when it is not a past date.	
Primary Account Identifier	Displays the primary account identifier type of the member account along with its value.	Not applicable

Note: If a bill is already generated for the master account, you cannot modify the effective start and end dates.

This zone contains the following two buttons:

Button Name	Button Description
Save	Used to save the changes made in this zone.
Remove Member	Used to remove the member from the master account.

By default, the **Edit Member Account Assignment** zone does not appear in the **Invoicing Group Maintenance – Add/Edit** screen. It appears when you click the **Broadcast** () icon corresponding to the member account in the **Member Accounts** zone.

Related Topics

For more information on...	See...
How to edit the member account assignment details	Editing the Member Account Assignment Details on page 260
How to remove a member from the master account	Removing a Member from the Master Account on page 261

Search Accounts to Add

The **Search Accounts to Add** zone lists accounts defined within the division and person hierarchy to which the master account belongs. The list also includes those accounts that are already added to the master account. You can filter the accounts using various search criteria. This zone contains the following two sections:

- **Search Criteria** — The **Search Criteria** section contains the following fields:

Field Name	Field Description	Mandatory (Yes or No)
Account ID	Used to specify the account ID.	No

Field Name	Field Description	Mandatory (Yes or No)
Account Identifier Type	Used to specify the account identifier type.	Yes (Conditional) Note: If you enter the account identifier as a search criteria, you have to select the account identifier type.
Account Identifier	Used to specify the value of the account identifier type.	Yes (Conditional) Note: If you specify the account identifier type as a search criteria, you have to enter the account identifier.
Person Name	Used to specify the person whose accounts you want to search.	No
Billing Cycle	Used to specify the billing cycle of the account.	No
Customer Class	Used to specify the customer class of the account.	No

- **Search Results** — On clicking the **Search** button, the search results appear based on the specified search criteria. The **Search Results** section contains the following columns:

Column Name	Column Description
Account ID	Displays the account ID.
Customer Name	Displays the name of the main customer.
Account Identifier Type	Displays the account identifier type.
Account Identifier	Displays the value of the account identifier type.
Account Currency	Displays the invoice currency of the account.
Division	Displays the division to which the account belongs.
Customer Class	Displays the customer class of the account.
Billing Cycle	Displays the billing cycle during which the account is billed.

On clicking the **Broadcast** () icon corresponding to the account, the **Add Member** zone appears with the details of the respective account.

Related Topics

For more information on...	See...
How to add a member to the master account	Adding a Member to the Master Account on page 259

Add Member

The **Add Member** zone allows you to add a member to the master account. This zone contains the following fields:

Field Name	Field Description	Mandatory (Yes or No)
Person Name	Displays the name of the main customer.	Not applicable

Field Name	Field Description	Mandatory (Yes or No)
Primary Account Identifier	Displays the primary account identifier type of the account along with its value.	Not applicable
Account Currency	Displays the invoice currency of the account.	Not applicable
Customer Class	Displays the customer class of the account.	Not applicable
Effective Start Date	Used to specify the date from when you want the charges for the member account to appear on the bill of the master account. Note: The effective start date should be earlier than or equal to the member account's contract end date.	Yes
Billing Cycle	Displays the billing cycle during which the account is billed.	Not applicable

This zone contains the following button:

Button Name	Button Description
Save	Used to add a member to the master account.

By default, the **Add Member** zone does not appear in the **Invoicing Group Maintenance – Add/Edit** screen. It appears when you click the **Broadcast** () icon corresponding to the account in the **Search Accounts to Add** zone.

Related Topics

For more information on...	See...
How to add a member to the master account	Adding a Member to the Master Account on page 259

Adding a Member to the Master Account

Prerequisites

To add a member to the master account, you should have:

- Accounts within the same banking division and person hierarchy where the value of the **Invoice Group Account** characteristic type is set to **N**
- Accounts with active contracts

Note: You cannot add an account as a member to a master account if that account is already a member of another master during that overlapping period.

Procedure

To add a member to the master account:

1. Access the **Invoicing Group Maintenance – Add/Edit** screen.
2. In the **Search Accounts to Add** zone, click the **Broadcast** () icon corresponding to the account that you want to add to the master account.
The **Add Member** zone appears.
3. Enter the date from when you want the charges for the member account to appear on the bill of the master account in the **Effective Start Date** field.

Note: The effective start date should be earlier than or equal to the member account's contract end date.

4. Click **Save**.

The account is added to the master account. The contracts at the member level are duplicated at the master level.

Note: Once a contract is duplicated at the master level, you need to activate the contract at the master level. Otherwise, the charges will be billed to the member account instead of the master account.

Related Topics

For more information on...	See...
How to access the Invoicing Group Maintenance – Add/Edit screen	Viewing the Master Account Details on page 254
Search Accounts to Add zone	Search Accounts to Add on page 257
Add Member zone	Add Member on page 258

Editing the Member Account Assignment Details

Procedure

You can edit the member account assignment details from both the **Invoicing Group Maintenance – Add/Edit** and **Invoicing Group Information** screens. To edit the member account assignment details:

1. Do either of the following:

If you want to	Then
Edit the member account assignment details from the Invoicing Group Maintenance – Add/Edit screen	<ol style="list-style-type: none"> 1. Access the Invoicing Group Maintenance – Add/Edit screen. 2. In the Member Accounts zone, click the Broadcast (📡) icon corresponding to the member account whose assignment details you want to edit.
Edit the member account assignment details from the Invoicing Group Information screen	<ol style="list-style-type: none"> 1. Access the Invoicing Group Information screen. 2. In the Selected Member Account zone, click the Broadcast (📡) icon corresponding to the member account whose assignment details you want to edit.

The **Edit Member Account Assignment** zone appears.

2. Modify the effective start and end dates, if required.

Note:

The effective start date should be earlier than or equal to the member account's contract end date. And, the effective end date cannot be earlier than the effective start date.

If a bill is already generated for the master account, you cannot modify the effective start and end dates.

3. Click Save.

The changes are saved.

Related Topics

For more information on...	See...
How to access the Invoicing Group Maintenance – Add/Edit screen	Viewing the Master Account Details on page 254
How to access the Invoicing Group Information screen	Viewing the Member Account Details on page 255
Edit Member Account Assignment zone	Edit Member Account Assignment on page 256

Removing a Member from the Master Account**Procedure**

You can remove a member from the master account through both the **Invoicing Group Maintenance – Add/Edit** and **Invoicing Group Information** screens. To remove a member from the master account:

1. Do either of the following:

If you want to	Then
Remove a member from the master account through the Invoicing Group Maintenance – Add/Edit screen	<ol style="list-style-type: none"> 1. Access the Invoicing Group Maintenance – Add/Edit screen. 2. In the Member Accounts zone, click the Broadcast (📡) icon corresponding to the member account that you want to remove from the master account.
Remove a member from the master account through the Invoicing Group Information screen	<ol style="list-style-type: none"> 1. Access the Invoicing Group Information screen. 2. In the Selected Member Account zone, click the Broadcast (📡) icon corresponding to the member account that you want to remove from the master account.

The **Edit Member Account Assignment** zone appears.

2. Click Remove Member.

The member is removed from the master account.

Related Topics

For more information on...	See...
How to access the Invoicing Group Maintenance – Add/Edit screen	Viewing the Master Account Details on page 254
How to access the Invoicing Group Information screen	Viewing the Member Account Details on page 255
Edit Member Account Assignment zone	Edit Member Account Assignment on page 256

Invoicing Group Information

The **Invoicing Group Information** screen allows you to view the details of the member account. It also allows you to edit and remove the member account from the master account. This screen consists of the following zones:

- [Invoicing Group Information](#) on page 262
- [Selected Member Account](#) on page 262
- [Edit Member Account Assignment](#) on page 263

Invoicing Group Information

The **Invoicing Group Information** zone displays the master account details of the member account. This zone contains the following fields:

Field Name	Field Description
Invoicing Group Assignment Type	Indicates that this zone displays information about the member's master account.
Person Name	Displays the name of the main customer.
Primary Account Identifier	Displays the primary account identifier type of the master account along with its value.
Customer Class	Displays the customer class of the master account.
Account Currency	Displays the invoice currency of the master account.
Billing Cycle	Displays the billing cycle during which the master account is billed.
Division	Displays the division to which the master account belongs.

Note: All fields in the **Invoicing Group Information** zone are read-only.

Selected Member Account

The **Selected Member Account** zone displays the details of the member account. This zone contains the following columns:

Column Name	Column Description
Account Identifier Type	Displays the primary account identifier type of the member account.
Account Identifier	Displays the value of the primary account identifier type.
Account Currency	Displays the invoice currency of the member account.

Column Name	Column Description
	Note: During billing, the charges for the member account are calculated in this currency and then converted to the master account's currency.
Effective Start Date	Displays the date from when the charges for the member account appears on the bill of the master account.
Effective End Date	Displays the date till when the charges for the member account appears on the bill of the master account.
Person Name	Displays the name of the main customer.
Customer Class	Displays the customer class of the member account.
Billing Cycle	Displays the billing cycle during which the member account is billed. Note: If the member account is removed from the master account, it will be billed during this billing cycle.

On clicking the **Broadcast** () icon corresponding to the member account, the **Edit Member Account Assignment** zone appears with the details of the respective member account.

Edit Member Account Assignment

The **Edit Member Account Assignment** zone allows you to edit the assignment details of the member account. This zone contains the following fields:

Field Name	Field Description	Mandatory (Yes or No)
Effective Start Date	Used to modify the date from when you want the charges for the member account to appear on the bill of the master account. Note: You can modify the date when it is a future date. The effective start date should be earlier than or equal to the member account's contract end date.	Yes
Invoicing Group Assignment Type	Indicates that the account is a member account.	Not applicable
Effective End Date	Used to modify the date till when you want the charges for the member account to appear on the bill of the master account. Note: You can modify the date when it is not a past date. The effective end date cannot be earlier than the effective start date.	No
Primary Account Identifier	Displays the primary account identifier type of the member account along with its value.	Not applicable

Note: If a bill is already generated for the master account, you cannot modify the effective start and end dates.

This zone contains the following two buttons:

Button Name	Button Description
Save	Used to save the changes made in this zone.
Remove Member	Used to remove the member from the master account.

By default, the **Edit Member Account Assignment** zone does not appear in the **Invoicing Group Information** screen. It appears when you click the **Broadcast** (📡) icon corresponding to the member account in the **Selected Member Account** zone.

Related Topics

For more information on...	See...
How to edit the member account assignment details	Editing the Member Account Assignment Details on page 260
How to remove a member from the master account	Removing a Member from the Master Account on page 261

Editing the Member Account Assignment Details

Procedure

You can edit the member account assignment details from both the **Invoicing Group Maintenance – Add/Edit** and **Invoicing Group Information** screens. To edit the member account assignment details:

1. Do either of the following:

If you want to	Then
Edit the member account assignment details from the Invoicing Group Maintenance – Add/Edit screen	<ol style="list-style-type: none"> 1. Access the Invoicing Group Maintenance – Add/Edit screen. 2. In the Member Accounts zone, click the Broadcast (📡) icon corresponding to the member account whose assignment details you want to edit.
Edit the member account assignment details from the Invoicing Group Information screen	<ol style="list-style-type: none"> 1. Access the Invoicing Group Information screen. 2. In the Selected Member Account zone, click the Broadcast (📡) icon corresponding to the member account whose assignment details you want to edit.

The **Edit Member Account Assignment** zone appears.

2. Modify the effective start and end dates, if required.

Note:

The effective start date should be earlier than or equal to the member account's contract end date. And, the effective end date cannot be earlier than the effective start date.

If a bill is already generated for the master account, you cannot modify the effective start and end dates.

3. Click Save.

The changes are saved.

Related Topics

For more information on...	See...
How to access the Invoicing Group Maintenance – Add/Edit screen	Viewing the Master Account Details on page 254
How to access the Invoicing Group Information screen	Viewing the Member Account Details on page 255
Edit Member Account Assignment zone	Edit Member Account Assignment on page 256

Removing a Member from the Master Account**Procedure**

You can remove a member from the master account through both the **Invoicing Group Maintenance – Add/Edit** and **Invoicing Group Information** screens. To remove a member from the master account:

1. Do either of the following:

If you want to	Then
Remove a member from the master account through the Invoicing Group Maintenance – Add/Edit screen	<ol style="list-style-type: none"> 1. Access the Invoicing Group Maintenance – Add/Edit screen. 2. In the Member Accounts zone, click the Broadcast (📡) icon corresponding to the member account that you want to remove from the master account.
Remove a member from the master account through the Invoicing Group Information screen	<ol style="list-style-type: none"> 1. Access the Invoicing Group Information screen. 2. In the Selected Member Account zone, click the Broadcast (📡) icon corresponding to the member account that you want to remove from the master account.

The **Edit Member Account Assignment** zone appears.

2. Click Remove Member.

The member is removed from the master account.

Related Topics

For more information on...	See...
How to access the Invoicing Group Maintenance – Add/Edit screen	Viewing the Master Account Details on page 254
How to access the Invoicing Group Information screen	Viewing the Member Account Details on page 255
Edit Member Account Assignment zone	Edit Member Account Assignment on page 256

Chapter 4

Pricing Management (Financial Services Business)

Topics:

- [Prerequisites \(Financial Services Business\)](#)
- [Types of Pricing](#)
- [Variance Parameter Based Pricing](#)
- [Multi Parameter Based Pricing](#)
- [Multiple Parameter Based Post-Processing Pricing](#)
- [Price Assignment Search Mechanism](#)
- [Person Relationship Type Sequence](#)
- [Pricing Eligibility](#)
- [Persisting Interest Rate for Rate Type Price Items](#)
- [Persisting Fee for Fee Type Price Items](#)
- [Repricing](#)
- [Two-Dimensional Pricing](#)
- [Types of Price Item Bundle](#)
- [Parameter](#)
- [Entity Hierarchy Relationship](#)
- [Price Item \(Financial Services Business\)](#)
- [Price List](#)
- [Pricing \(Account\)](#)
- [Pricing \(Person\)](#)
- [Price Item Pricing \(Used for Viewing\)](#)
- [Pricing Simulation](#)

Oracle Revenue Management and Billing allows you to define prices for price item and services offered to the customers. These prices are either standard prices defined in the price lists or override prices that are specific to a customer or an account. The system allows you to define prices at various levels in a customer hierarchy (for example, at the account level, main customer level, or at the parent customer level). You can also define prices in the account's price list, main customer's price list, parent customer's price list, price list's parent price list. As prices can be defined at multiple places, the order in which the system searches for effective price item pricing will affect the price charged to the customer. The search order is configurable, and can vary with each division. You need to define the search order in the price assignment search algorithm (which is also known as crawling algorithm) and then attach the algorithm to the division. You can change the search order at any time.

You need to define the price assignment search algorithm using the C1_PRASN algorithm type. The price assignment search algorithm is used while:

- Listing effective price item pricing for an account or a customer
- Fetching effective price item pricing while creating recurring and non-recurring bill segments
- Fetching effective post processing pricing while creating post processing bill segments
- Fetching effective price item pricing in the **Price Item Pricing Verification (C1-TXNVP)** batch

For more information about the price assignment search algorithm, see [Price Assignment Search Mechanism](#) on page 275.

Since a global customer is not associated to any division, the system cannot determine the price assignment search order for a global customer. Hence, the default search order is defined for global customers through the **C1_PRASNORDR** feature configuration. You can change this default search order, if required.

The prices that are specific to a customer or an account are referred to as customer agreed or account agreed prices, respectively. You can override these agreed prices. Customer agreed or account agreed prices are effective for a particular duration and do not expire until you manually specify the end date. However, if you set the **Expire Override Switch** option type of the **C1_EXP_OVRD** feature configuration to **Y**, the system will automatically expire an agreed pricing when the agreed pricing of a customer or an account without end date is overridden. If you do not want an agreed pricing to automatically expire when it is overridden, you must set the **Expire Override Switch** option type of the **C1_EXP_OVRD** feature configuration to **N**.

The system allows you to define the following types of pricing:

- [Eligible Price List](#)
- [Rate Definition](#)
- [Tiering Criterion](#)
- [Variance Parameter](#)
- [Person to Person Relationship Type Sequence](#)

- Flat Pricing
- Tiered Pricing

For more information about the types of pricing, see [Types of Pricing](#) on page 270.

The price for a price item or service may differ depending upon various transaction, customer or account attributes. Oracle Revenue Management and Billing provides a facility to define pricing for a price item based on multiple parameters. This multi parameter based pricing feature enables the price analyst to define price item and its parameters which influence pricing. You can then define pricing for the price item based on these parameters. Bundles are offered to customers to provide discounted rates. You can also define pricing for bundles based on multiple parameters. To enable the multi parameter based pricing feature, you must set the **Multi Price Parameter** option type of the **Multi Parameter Based Pricing (C1_PPARM_FLG)** feature configuration to **True**. For more information about the multi parameter based pricing feature, see [Multi Parameter Based Pricing](#) on page 271.

Prerequisites (Financial Services Business)

To setup the pricing management feature, you need to do the following:

- Define the required SQIs, divisions, To Do types, and To Do roles in the system.
- Define the required parameters in the system.
- Define the required variance parameters and tiering criterion in the system.
- Define the tiering setup for rate components in the system.
- Define the required hierarchy entities in the system.
- Define the required entity hierarchy relationships in the system.
- Define the required price items and price item relationships in the system.
- Define the required price lists in the system.
- Define an algorithm using the **C1_PRASN_PP** algorithm type and attach it to the **Price Assignment Search** algorithm spot of the required divisions.
- Define an algorithm using the **C1-CUSRLALGT** algorithm type and attach it to the **Person relationship type sequence algorithm** parameter of the **C1_PRASN_PP** algorithm.
- Set the following feature configurations in the system:
 - C1-EHRCONFIG
 - C1_EXP_OVRD
 - C1_FM
 - C1_PER_REL
 - C1_PPARAM_FLG
 - C1_PR_REC
 - C1_PRASNORDR
 - C1_PRICING
- Set the **Skip Priceitem Contract Type Validation** option type of the **C1_FINTRANOP** feature configuration.
- Set the batch control type of the **Identify Entities for Repricing (C1-REPC1)** and **Process Repricing Request (C1-REPC2)** batches to **Timed** and define the following attributes:
 - Time Interval
 - Timer Active
 - User ID
 - Batch Language
 - Email Address

For more information about these batches, see *Oracle Revenue Management and Billing Batch Guide*.

Related Topics

For more information on...	See...
How to set the C1-EHRCONFIG feature configuration	Setting the C1-EHRCONFIG Feature Configuration on page 4316

For more information on...	See...
How to set the C1_EXP_OVRD feature configuration	Setting the C1_EXP_OVRD Feature Configuration on page 4318
How to set the C1_FM feature configuration	Setting the C1_FM Feature Configuration on page 4324
How to set the C1_PER_REL feature configuration	Setting the C1_PER_REL Feature Configuration on page 4338
How to set the C1_PPARM_FLG feature configuration	Setting the C1_PPARM_FLG Feature Configuration on page 4340
How to set the C1_PR_REC feature configuration	Setting the C1_PR_REC Feature Configuration on page 4341
How to set the C1_PRASNORDR feature configuration	Setting the C1_PRASNORDR Feature Configuration on page 4344
How to set the C1_PRICING feature configuration	Setting the C1_PRICING Feature Configuration on page 4342
How to setup the C1_FINTRANOP feature configuration	Setting the C1_FINTRANOP Feature Configuration on page 4319

Types of Pricing

Note: This topic is not applicable for the health insurance business.

The system allows you to define the following types of pricing:

- **Flat Pricing** — Used when you want to charge a fixed price per unit to the customer.
- **Tiered Pricing** — Used when standard flat pricing is not sufficient to meet the business needs. Through tiered pricing, you can offer more favorable pricing to the customers based on service quantity utilization. For example, CG Limited uses wire transfer services provided by a large bank. If CG Limited initiates up to 1,000 wire transfers, the fee charged by the bank will be \$5 per transfer. If CG Limited initiates more than 1,000 wire transfers, the fee will be \$3 per transfer. To introduce this flexibility in the pricing model, the following tiered pricing is defined:

Quantity Range	Rate (\$) per transfer
0 – 1000	5
1000+	3

You can define two types of tiered pricing:

- **Step Tiered Pricing** — The rate of the first tiering range is used to calculate the charge for the maximum quantity in the range, and for incremental service quantity utilization, the rate of the progressive tiering range is used. This happens till the utilized quantity is exhausted. For example, when you define the following step tiered pricing for Price Item A and the user consumes 60,000 units of the same, the system will charge the first 45,000 units at \$2 per unit and the remaining 15,000 units at \$1 per unit:

Quantity Range	Rate (\$) per unit
0 – 45000	2
45000+	1

- **Threshold Tiered Pricing** — The rate of the tiering range within which the service quantity utilization falls is used to calculate the charge for the entire volume. For example, when you define the following threshold

tiered pricing for Price Item A and the user consumes 75,000 units of the same, the system will charge 75,000 units at \$1 per unit as the service quantity utilization falls within 45000+ tiering range:

Quantity Range	Rate (\$) per unit
0 – 45000	2
45000+	1

Variance Parameter Based Pricing

Note: This topic is not applicable for the health insurance business.

Information will be available shortly!

Multi Parameter Based Pricing

Note: This topic is not applicable for the health insurance business.

Oracle Revenue Management and Billing provides a facility to define pricing for a price item based on multiple parameters. You can also define pricing for bundles based on multiple parameters. You can enable or disable the multi parameter based pricing feature by setting the **Multi Parameter Based Pricing (C1_PPARM_FLG)** feature configuration. For more information, see [Setting the C1_PPARM_FLG Feature Configuration](#) on page 4340.

If the multi parameter based pricing feature is disabled, you can define pricing for a price item based on the variance parameter. If the multi parameter based pricing feature is enabled, you can define pricing for a price item based on multiple parameters. For example:

Price Item A	Country	Currency
Pricing 1	US	USD
Pricing 2	Germany	USD

Pricing 1 and Pricing 2 are defined for Price Item A based on two parameters — Country and Currency. Before you define pricing based on country and currency, you need to define these parameters in the system. Once you define these parameters, you need to associate them to the price item (i.e. Price item A).

Then, when you define Pricing 1 for Price item A, you need to set the following price item parameters:

- Country — US
- Currency — USD

Similarly, you need to define Pricing 2 with Country set to Germany and Currency set to USD.

The following table lists the tiering ranges defined in Pricing 1 where price item parameters are set to US, USD:

Tier Sequence	Rate	Tiering Criteria	Price Item	Price Parameters	Item	From	To
10	2	Number of Transactions	Price Item A	US, USD		0	5000
20	1	Number of Transactions	Price Item A	US, USD		5000	

The following table lists the tiering ranges defined in Pricing 2 where price item parameters are set to Germany, USD:

Tier Sequence	Rate	Tiering Criteria	Price Item	Price Parameters	Item	From	To
10	4	Number of Transactions	Price Item A	Germany, USD		0	1000
20	3	Number of Transactions	Price Item A	Germany, USD		1000	

Now, when the user performs 1500 transactions (in USD) of Price Item A in Germany, 12000 transactions (in USD) of Price Item A in US, the system creates two billable charges. In one billable charge (with Price Item A, US and USD combination), the system uses \$1 as the rate for calculating charges, and in another billable charge (with Price Item A, Germany and USD combination), the system uses \$3 as the rate for calculating charges.

Note that in this case the parameters based on which you have defined pricing and tiering ranges are same. You can use different parameters while defining pricing and tiering ranges, if required. You can also use another price item or bundle and its parameters while defining tiering ranges. For example:

The following table lists the tiering ranges of Pricing 1 defined for Price Item A where price item parameters are set to US, USD:

Tier Sequence	Rate	Tiering Criteria	Price Item	Price Parameters	Item	From	To
10	2	Number of Transactions	Price Item B	Germany, USD		0	100
20	1	Number of Transactions	Price Item B	Germany, USD		100	200
30	0.5	Number of Transactions	Price Item B	Germany, USD		200	

Now, when the user performs 1500 transactions (in USD) of Price Item A in US, 200 transactions (in USD) of Price Item B in Germany, the system creates one billable charge. The system adds the transactions with the following combinations and then determines the range of Price Item A within which the total units (i.e. 200) fall:

- Price Item B, Germany, USD

In this case, the total units fall in the 100 – 200 range of Price Item A, and therefore the system uses \$1 as the rate for calculating charges (i.e. $1500 * 1 = 1500$).

Some parameters might be mandatory and some might be optional while defining price item pricing. You can define price item pricing based on these parameters at various levels, such as:

- Account Agreed
- Account Price List
- Account Inherited Price List
- Customer Agreed
- Customer Price List
- Customer Inherited Price List
- Parent Customer Agreed
- Parent Customer Price List
- Parent Customer Inherited Price List
- Default Price List
- Global Price List

As prices can be defined at multiple levels, the system first searches for exact match at all levels (using the search order). If the system finds the exact match at multiple levels, the price assignment at the higher precedence level is considered. Let us understand this with the help of an example.

Pricing 1 is defined for Price Item A with the following parameters at the Account Agreed level:

Parameter	Mandatory (Yes or No)	Priority	Value
Type	Yes	—	BT
Country	No	1	US
Currency	No	2	USD

Pricing 2 is defined for Price Item A with the following parameters at the Parent Customer Agreed level:

Parameter	Mandatory (Yes or No)	Priority	Value
Type	Yes	—	BT
Country	No	1	US
Currency	No	2	USD

Pricing 3 is defined for Price Item A with the following parameters at the Account Price List level:

Parameter	Mandatory (Yes or No)	Priority	Value
Type	Yes	—	BT
Country	No	1	US
Currency	No	2	—

Now, when the user performs transactions (with the type set to BT in US) of Price Item A in USD, the system searches for price with exact match (Type — BT, Country — US, and Currency — USD). The exact match is available at two levels — Account Agreed and Parent Customer Agreed. The system considers the price at the Account Agreed level because this level has higher precedence.

Depending on the search order defined for the division (to which the account belongs), the level with higher precedence changes. Accordingly, the price assignment at the higher precedence level is considered for calculating the charges.

If the system does not find the exact match at any level, it searches for the best fit match at all levels. Let us understand how the best fit match is determined with the help of an example.

Pricing 1 is defined for Price Item A with the following parameters:

Parameter	Mandatory (Yes or No)	Priority	Value
Type	Yes	—	BT
Country	No	1	US
Currency	No	2	-

Pricing 2 is defined for Price Item A with the following parameters:

Parameter	Mandatory (Yes or No)	Priority	Value
Type	Yes	—	BT
Country	No	1	-
Currency	No	2	USD

Pricing 3 is defined for Price Item A with the following parameters:

Parameter	Mandatory (Yes or No)	Priority	Value
Type	Yes	—	BT
Country	No	1	-
Currency	No	2	-

Pricing 4 is defined for Price Item A with the following parameters:

Parameter	Mandatory (Yes or No)	Priority	Value
Type	Yes	—	BT
Country	No	1	US
Currency	No	2	GBP

The system has Pricing 1, Pricing 2, Pricing 3, and Pricing 4 defined for Price Item A. Now, when the user performs transactions (with the type set to BT in US) of Price Item A in USD, the system does not find price with exact match (Type — BT, Country — US, and Currency — USD). Therefore, it searches for the best fit match.

While searching for the best fit match, the system rules out the optional parameter with lowest priority (i.e. Currency) and checks whether the price (with Type — BT and Country — US) is available. If the price is available, the system considers the price as the best fit match. Therefore, in this case, Pricing 1 is considered as the best fit match.

Suppose, if the price (with Type — BT and Country — US) is not available, then the system rules out the optional parameter with next lowest priority (i.e. Country) and checks whether the price (with Type — BT and Currency — USD) is available. If the price is available, the system considers the price as the best fit match. In this case, Pricing 2 would be considered as the best fit match. If the system finds the best fit match with same weight at multiple levels, the price assignment at the higher precedence level is considered.

Multiple Parameter Based Post-Processing Pricing

Note: This topic is not applicable for the health insurance business.

Until now, while deriving the post-processing bill segments, the system aggregated the regular bill segments of related price items without considering the price item parameters. Now, if you specify a price item parameter while associating regular price items with a post-processing price item and if the pricing for the post-processing price item is based on the price item parameter, the system aggregates the bill segments of regular price item and price item parameter combination. The system searches for the exact match. In this case, if the exact match is not found, the system does not aggregate the bill segments of the related price item. For example, the PR1 post processing price item is associated with the following regular price items:

Regular Price Item	Price Item Parameter
R1	Country = US
R2	Country = US

And, the pricing for PR1 post processing price item is based on Country = US. Now, if the following bill segments are generated for R1 and R2 in a bill:

Bill Segment	Price Item	Parameter 1	Parameter 2
BS1	R1	Country = US	-
BS2	R1	Country = US	Currency = USD

Bill Segment	Price Item	Parameter 1	Parameter 2
BS3	R1	Country = US	-
BS4	R1	-	-
BS5	R2	Country = US	-
BS6	R2	Country = US	-

Then, the system will aggregate the following regular bill segments while creating the post-processing bill segment for PR1:

- BS1
- BS3
- BS5
- BS6

However, if you specify a price item parameter while associating regular price items with a post-processing price item, but the pricing for the post-processing price item is not based on the price item parameter, the system aggregates all bill segments of regular price item irrespective of the price item parameter. For example, the PR1 post processing price item is associated with the following regular price items:

Regular Price Item	Price Item Parameter
R1	Country = US
R2	-

And, the pricing for PR1 post processing price item is not based on a price item parameter. Now, if the following bill segments are generated for R1 and R2 in a bill:

Bill Segment	Price Item	Parameter 1	Parameter 2
BS1	R1	Country = US	-
BS2	R1	Country = US	Currency = USD
BS3	R1	Country = US	-
BS4	R1	-	-
BS5	R2	Country = US	-
BS6	R2	-	-

Then, the system will aggregate the following regular bill segments while creating the post-processing bill segment for PR1:

- BS1
- BS2
- BS3
- BS4
- BS5
- BS6

Price Assignment Search Mechanism

Note: This topic is not applicable for the health insurance business.

The price assignment search algorithm searches effective price item pricing based on the following parameters:

- **Search Order** — Used to indicate the order in which the system must search effective price item pricing at various levels in the customer hierarchy. This is a mandatory parameter. The valid values are:

If you select the following value...	Then the effective price item pricing is searched at the following levels in the specified order...
AGREED_PRICELIST	<ol style="list-style-type: none"> 1. Account Agreed — Means price item pricing is agreed for the account in the hierarchy. 2. Account Price List — Means price item pricing is defined within the price list which is assigned to the account. 3. Account Inherited Price List — Means price item pricing is inherited from the hierarchy defined for the price list which is assigned to the account. 4. Customer Agreed — Means price item pricing is agreed for the customer in the hierarchy. 5. Customer Price List — Means price item pricing is defined within the price list which is assigned to the customer. 6. Customer Inherited Price List — Means price item pricing is inherited from the hierarchy defined for the price list which is assigned to the customer. 7. Parent Customer Agreed — Means price item pricing is agreed for the parent customer in the hierarchy. 8. Parent Customer Price List — Means price item pricing is defined within the price list which is assigned to the parent customer. 9. Parent Customer Inherited Price List — Means price item pricing is inherited from the hierarchy defined for the price list which is assigned to the parent customer.
AGREED_FIRST	<ol style="list-style-type: none"> 1. Account Agreed — Means price item pricing is agreed for the account in the hierarchy. 2. Customer Agreed — Means price item pricing is agreed for the customer in the hierarchy. 3. Parent Customer Agreed — Means price item pricing is agreed for the parent customer in the hierarchy. 4. Account Price List — Means price item pricing is defined within the price list which is assigned to the account. 5. Account Inherited Price List — Means price item pricing is inherited from the hierarchy defined for the price list which is assigned to the account. 6. Customer Price List — Means price item pricing is defined within the price list which is assigned to the customer.

If you select the following value...	Then the effective price item pricing is searched at the following levels in the specified order...
	<p>7. Customer Inherited Price List — Means price item pricing is inherited from the hierarchy defined for the price list which is assigned to the customer.</p> <p>8. Parent Customer Price List — Means price item pricing is defined within the price list which is assigned to the parent customer.</p> <p>9. Parent Customer Inherited Price List — Means price item pricing is inherited from the hierarchy defined for the price list which is assigned to the parent customer.</p>

Note: In these price assignment search orders, the account agreed level has highest precedence and parent customer inherited price list level has lowest precedence.

- **Default Price List ID** — Used to indicate the default price list. If the effective price item pricing is not available at any level in the customer hierarchy, the system checks whether the default price list is specified in the price assignment search algorithm. If the default price list is specified in the algorithm, the system checks whether effective price item pricing is available in the default price list.
- **Global Price List** — Used to indicate whether the system should consider the price item pricing defined in the global price list. If the effective price item pricing is not available in the default price list or if the default price list is not specified in the price assignment search algorithm, the system checks whether it should consider the price item pricing defined in the global price list. The valid values are:
 - Y
 - N

Finally, if the effective price item pricing is not available in either default and/or global price list, an error message occurs indicating that the effective price item pricing is not available in the system.

- **Prefer Price Item Over Bundle** — Used to indicate whether to prefer price item, regular bundle, or parent bundle pricing when the price item, regular bundle (to which the price item belongs), and parent (regular) bundle (i.e. to which the regular bundle belongs) are assigned at the same level. The valid values are:
 - Y
 - N

If the value of the **Prefer Price Item Over Bundle** parameter is set to **Y**, the system first searches whether effective pricing is available for the price item. If the effective pricing is not available for the price item, then the system searches whether effective pricing is available for the regular bundle at the same level. If the effective pricing is not available for the regular bundle, then the system searches whether effective pricing is available for the parent bundle at the same level. However, if the value of the **Prefer Price Item Over Bundle** parameter is set to **N**, the system first searches whether effective pricing is available for the parent bundle. If the effective pricing is not available for the parent bundle, then the system searches whether effective pricing is available for the regular bundle at the same level. If the effective pricing is not available for the regular bundle, then the system searches whether effective pricing is available for the price item at the same level.

- **Person Relationship Type Sequence Algorithm** — Used to attach an algorithm which is defined using the C1-CUSRLALGT algorithm type. The attached algorithm is used while searching effective price item pricing at the parent customer level. It indicates whether the system should search person to person relationship type sequence defined:
 - For the division, price item, and price item parameters combination
 - For the division
 - In the C1_PER_REL feature configuration

Related Topics

For more information on...	See...
Person to Person Relationship Type Sequence	<i>Person Relationship Type Sequence</i> on page 278

Person Relationship Type Sequence

Note: This topic is not applicable for the health insurance business.

When the price assignment search algorithm searches effective price item pricing at the parent customer level, the system determines the parent customer's person to person relationship type whose price item pricing should be considered. The person to person relationship type sequence indicates the order in which relationship type should be considered while searching for effective price item pricing at the parent customer level. For example, if a customer has two parents – Parent 1 with the relationship type set to “Subsidiary” and Parent 2 with the relationship type set to “Franchise Owner”, and the following person to person relationship type sequence is defined in the system:

Sequence Number	Relationship Type
10	Subsidiary
20	Franchise Owner

In the above example, the system will inherit effective price item pricing (if available) from Parent 1 or within its hierarchy. If the effective price item pricing is not available in the Parent 1 hierarchy, the system will inherit effective price item pricing (if available) from Parent 2 or within its hierarchy. If the effective price item pricing is not available in the Parent 2 hierarchy, an error message occurs indicating that the effective price item pricing is not available.

While searching effective pricing at the parent customer level based on the person to person relationship type sequence, the system will use the depth first search mechanism. Let us understand this with the help of an example.

Person To Person Relationship Type Sequence	
Sequence Number	Relationship Type
10	Subsidiary (S)
20	Branch (B)
30	Franchise Owner (F)

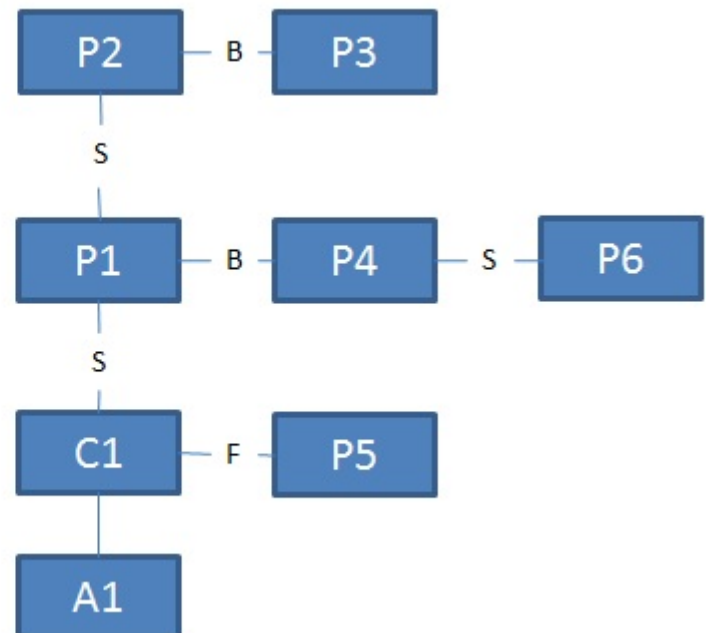

In the above example, if the effective pricing is not available at the account or customer level, the system will search effective pricing at the parent customer level in the following order:

- P1 (because the first relationship type in the sequence is Subsidiary)
- P2 (grandparent of P1 irrespective of the relationship type)
- P3 (because the second relationship type in the sequence is Branch)
- P4 (because the second relationship type in the sequence is Branch)
- P6 (grandparent of P4 irrespective of the relationship type)
- P5 (because the third relationship type in the sequence is Franchise Owner)

The system provides you the flexibility to define person to person relationship type sequence:

- For each division, price item, and price item parameters combination
- For each division
- In the C1_PER_REL feature configuration

The system will first check whether the person to person relationship type sequence is defined for the division, price item, and price item parameters combination. If the person to person relationship type sequence is defined for the division, price item, and price item parameters combination, the system will search effective price item pricing at the parent customer level based on the sequence defined for the combination. However, if the person to person relationship type sequence is not defined for the division, price item, and price item parameters combination, the system will check whether the person to person relationship type sequence is defined for the division. If the person to person relationship type sequence is defined for the division, the system will search effective price item pricing at the parent customer level based on the sequence defined for the division. However, if the person to person relationship type sequence is not defined for the division, the system will consider the person to person relationship type sequence defined in the C1_PER_REL feature configuration and accordingly search the effective price item pricing at the parent customer level.

To enable the system to search person to person relationship type sequence at different levels, you need to create an algorithm of the C1-CUSRLALGT algorithm type and attach it to the **Person Relationship Type Sequence Algorithm** parameter in the price assignment search algorithm. The C1-CUSRLALGT algorithm type has the following parameters:

- **Check on Division, Price Item and Price Item Parameters Combination** - Used to indicate whether you want the system to search person to person relationship type sequence defined for the division, price item, and price item parameters combination. This is a mandatory parameter. The valid values are:

- Y
- N

By default, the value is set to **N**.

- **Check on Division** - Used to indicate whether you want the system to search person to person relationship type sequence defined for the division. This is a mandatory parameter. The valid values are:

- Y
- N

By default, the value is set to **N**.

- **Check on Feature Configuration** – Used to indicate whether you want the system to consider the person to person relationship type sequence defined in the **C1_PER_REL** feature configuration. This is a mandatory parameter. The valid values are:

- **A** – Used when you want to consider all person to person relationship types defined in the feature configuration (in the specified sequence).
- **F** – Used when you want to only consider the person to person relationship type defined with the lowest sequence in the feature configuration.
- **N** – Used when you do not want to consider the person to person relationship type sequence defined in the C1_PER_REL feature configuration.

By default, the value is set to **F**.

Related Topics

For more information on...	See...
Person to Person Relationship Type Sequence screen	Person to Person Relationship Type Sequence on page 721
How to set the C1_PER_REL feature configuration	Setting the C1_PER_REL Feature Configuration on page 4338

Pricing Eligibility

Note: This topic is not applicable for the health insurance business.

Oracle Revenue Management and Billing enables you to define pricing eligibility criteria using the account, person, and product attributes while defining a price item pricing. For example, a bank offers a product named 12 Month Standard Certificate of Deposit (CD). The interest rate charged to a person for this product differs based on two parameters – Deposit Amount and Person Type (Preferred and Non-Preferred). The following table lists the interest rates offered for the 12 Month Standard Certificate of Deposit (CD) product:

Deposit Amount	Non-Preferred	Preferred
Less than \$5,000	0.13%	0.20%
Greater than \$5,000	0.15%	0.22%

Earlier, you were able to define different interest rates based on different parameters using the rate eligibility feature at the rate component level. Considering the above example, you had to define four rate components. The respective rate component would appear while defining price item pricing based on the following:

- The value defined for the **Deposit Amount** characteristic on the account
- The value defined for the **Customer Type** characteristic on the main customer

However, now, you can implement the above scenario using a single rate component instead of maintaining four different rate components. Now, while defining price item pricing, you need to define four different price components for a rate component. For each price component, you need to define the pricing eligibility criteria in the following manner:

Price Component	Rate	Pricing Criteria	Eligibility	If True	If False
P1	0.13%	Deposit Amount > 5000		Check Next Condition	Return False
P1	0.13%	Person Type = Non-Preferred		Return True	Return False
P2	0.15%	Deposit Amount < 5000		Check Next Condition	Return False
P2	0.15%	Person Type = Non-Preferred		Return True	Return False
P3	0.20%	Deposit Amount > 5000		Check Next Condition	Return False
P3	0.20%	Person Type = Preferred		Return True	Return False
P4	0.22%	Deposit Amount < 5000		Check Next Condition	Return False
P4	0.22%	Person Type = Preferred		Return True	Return False

You can define pricing eligibility criteria when the appropriate parameters are created in the system. These parameters must be mapped to either of the following:

- Account attributes, characteristics, usage amounts, or usage counters
- Person attributes, characteristics, usage amounts, or usage counters
- Product attributes or characteristics
- Service Quantity Identifier
- Custom algorithm which returns the appropriate value

In the above example, you can define the pricing eligibility criteria when the following parameters are defined in the system:

Parameter	Source Entity	Source Type	Source Type Code	Value Type
Deposit Amount	Account	Usage Amount	Deposit Amount	Adhoc
Customer Type	Person	Characteristic	Person Type	Predefined

You can define pricing eligibility criteria for rate components whose tiering type is set to **Flat**, **Threshold**, or **Step**. Each criterion in the pricing eligibility criteria is executed in the specified sequence. If the value of the pricing eligibility criteria is **True**, the rate of the respective price component is passed to the rate component for further calculations.

Persisting Interest Rate for Rate Type Price Items

Note: This topic is not applicable for the health insurance business.

While defining a price item, you can indicate whether the price item is available for pricing and billing or only for pricing. If the price item is available only for pricing, you can indicate the type of the price item. The valid values for the price item type are:

- Rate (i.e. Interest Rate)
- Fees

If the type of a price item is **Rate**, the system calculates and persist the rate for the price item. The rate is persisted only for the price item pricing which is either assigned or inherited by an account. If the account or person attributes are changed, the system allows you to recalculate and persist the interest rate for rate type price items. This process is known as **Repricing**.

Related Topics

For more information on...	See...
Repricing	Repricing on page 282

Persisting Fee for Fee Type Price Items

Note: This topic is not applicable for the health insurance business.

While defining a price item, you can indicate whether the price item is available for pricing and billing or only for pricing. If the price item is available only for pricing, you can indicate the type of the price item. The valid values for the price item type are:

- Rate
- Fees

The input elements Pricing Frequency, Advance Pricing should be populated if **Price Item** is available for **Pricing Only**, **Price Item Type** is **Fees** and **Price Assignment Type** is **Post-Processing**.

If the type of a price item is **Fee**, the system calculates and persist the fee for the price item.

Note: The **Process Fees Request and Persist Fees for an Account (C1-ACFEE)** batch is used to calculate and persist the fees for the account. It must be executed when a user wants to store fees.

Related Topics

For more information on...	See...
Repricing	Repricing on page 282

Repricing

Note: This topic is not applicable for the health insurance business.

If the account or person attributes are changed, the system allows you to recalculate and persist the interest rate for rate type price items. This process is known as **Repricing**. The **Repricing** process is triggered in the following scenarios when:

- You edit the attributes and characteristics of an account.
- You add or delete the usage amount and counter details of an account.
- You edit the attributes and characteristics of a person.
- You add or delete the usage amount and counter details of a person.
- You define or edit the price item pricing of an active price list which is assigned to an account or a person.
- You define, edit, override, or copy the price item pricing of an account or a person.
- You assign a price list to an account or a person, or edit the price list assignment details of an account or a person.

The system behaves in the following manner in the above scenarios:

Scenario	System Behaviour
On editing the attributes and characteristics of an account	<p>The system checks whether the account is eligible for repricing. If the account is eligible for repricing, the system checks whether a parameter for the account attribute or characteristic whichever is changed is already defined in the system. If the required parameters are available in the system, the system creates a repricing request for the account and effective date combination in the CI_REPRC_REQ_DTL table. On executing the Process Repricing Request and Persist Pricing for an Account (C1-REPC2) batch, you can recalculate and persist the rate for the account in the CI_PRCE_CALC table.</p> <p>Note: On editing the account attributes, the effective date is set to the date when you edit the account attributes. However, on editing the account's characteristic, the effective date is set to the date from when the characteristic is effective for the account.</p>
On adding or deleting the usage amount and counter details of an account	<p>The system checks whether the account is eligible for repricing. If the account is eligible for repricing, the system checks whether a parameter for the usage amount or counter whichever is changed is already defined in the system. If the required parameters are available in the system, the system creates a repricing request for the account and effective date combination in the CI_REPRC_REQ_DTL table. On executing the Process Repricing Request and Persist Pricing for an Account (C1-REPC2) batch, you can recalculate and persist the rate for the account in the CI_PRCE_CALC table.</p>

Scenario	System Behaviour
	<p>Note: The effective date is set to the date from when the usage amount or counter is effective for the account.</p>
<p>On editing the attributes and characteristics of a person</p>	<p>The system identifies all accounts which belong to the person and its child persons, and then checks whether the identified accounts are eligible for repricing. If one or more accounts are eligible for repricing, the system checks whether a parameter for the person attribute or characteristic whichever is changed is already defined in the system. If the required parameters are available in the system, the system creates a repricing request for the account and effective date combination in the CI_REPRC_REQ_DTL table. On executing the Process Repricing Request and Persist Pricing for an Account (C1-REPC2) batch, you can recalculate and persist the rate for the account in the CI_PRCE_CALC table.</p> <p>Note:</p> <p>Only accounts where the person and child person are the main customers are considered for repricing.</p> <p>On editing the person attributes, the effective date is set to the date when you edit the person attributes. However, on editing the person's characteristic, the effective date is set to the date from when the characteristic is effective for the person.</p>
<p>On adding or deleting the usage amount and counter details of a person</p>	<p>The system identifies all accounts which belong to the person and its child persons, and then checks whether the identified accounts are eligible for repricing. If one or more accounts are eligible for repricing, the system checks whether a parameter for the usage amount or counter whichever is changed is already defined in the system. If the required parameters are available in the system, the system creates a repricing request for the account and effective date combination in the CI_REPRC_REQ_DTL table. On executing the Process Repricing Request and Persist Pricing for an Account (C1-REPC2) batch, you can recalculate and persist the rate for the account in the CI_PRCE_CALC table.</p> <p>Note:</p> <p>Only accounts where the person and child person are the main customers are considered for repricing.</p> <p>The effective date is set to the date from when the usage amount or counter is effective for the person.</p>
<p>On assigning a price list to an account or editing the price list assignment details of an account</p>	<p>The system creates a repricing request for the account, price item, and effective date combination in the CI_REPRC_REQ_DTL table. If the price assignment end date and/or price list assignment end date is available, the system creates two repricing requests – one request where the effective date is set to the start date and another request where the effective date is set to the end date. The effective date is set to the price assignment start date or price list assignment start date depending on the following conditions:</p> <ul style="list-style-type: none"> • If the Price Assignment Start Date is later than the Price List Assignment Start Date, then the effective date is set to Price Assignment Start Date. • If the Price Assignment Start Date is earlier than or equal to the Price List Assignment Start Date, then the effective date is set to Price List Assignment Start Date.

Scenario	System Behaviour
	<p>However, the effective date is set to the price assignment end date or price list assignment end date depending on the following conditions:</p> <ul style="list-style-type: none"> • If the Price Assignment End Date is earlier than the Price List Assignment End Date, then the effective date is set to Price Assignment End Date + 1 Day. • If the Price Assignment End Date is later than or equal to the Price List Assignment End Date, then the effective date is set to Price List Assignment End Date + 1 Day. <p>On executing the Process Repricing Request and Persist Pricing for an Account (C1-REPC2) batch, you can recalculate and persist the rate for the account in the CI_PRCE_CALC table.</p> <p>Note: The system creates the repricing request for the account irrespective of whether the account is eligible for repricing or not.</p>
<p>On assigning a price list to a person or editing the price list assignment details of a person</p>	<p>The system identifies all accounts which belong to the person and its child persons, and then creates a repricing request for the account, price item, and effective date combination in the CI_REPRC_REQ_DTL table. If the price assignment end date and/or price list assignment end date is available, the system creates two repricing requests – one request where the effective date is set to the start date and another request where the effective date is set to the end date. The effective date is set to the price assignment start date or price list assignment start date depending on the following conditions:</p> <ul style="list-style-type: none"> • If the Price Assignment Start Date is later than the Price List Assignment Start Date, then the effective date is set to Price Assignment Start Date. • If the Price Assignment Start Date is earlier than or equal to the Price List Assignment Start Date, then the effective date is set to Price List Assignment Start Date. <p>However, the effective date is set to the price assignment end date or price list assignment end date depending on the following conditions:</p> <ul style="list-style-type: none"> • If the Price Assignment End Date is earlier than the Price List Assignment End Date, then the effective date is set to Price Assignment End Date + 1 Day. • If the Price Assignment End Date is later than or equal to the Price List Assignment End Date, then the effective date is set to Price List Assignment End Date + 1 Day. <p>Note: If the Price List Assignment Start Date and Price List Assignment End Date are earlier than the current date, repricing requests for the accounts are not created in the CI_REPRC_REQ_DTL table.</p> <p>On executing the Process Repricing Request and Persist Pricing for an Account (C1-REPC2) batch, you can recalculate and persist the rate for the account in the CI_PRCE_CALC table.</p>

Scenario	System Behaviour
	<p>Note:</p> <p>Only accounts where the person and child person are the main customers are considered for repricing.</p> <p>The system creates the repricing request for the account irrespective of whether the account is eligible for repricing or not.</p>
<p>On defining, editing, overriding, or copying the price item pricing of an account</p>	<p>The system creates a repricing request for the account, price item, and effective date combination in the CI_REPRC_REQ_DTL table. If the price assignment end date is specified, the system creates two repricing requests – one request where the effective date is set to the price assignment start date and another request where the effective date is set to the price assignment end date + 1 Day. On executing the Process Repricing Request and Persist Pricing for an Account (C1-REPC2) batch, you can recalculate and persist the rate for the account in the CI_PRCE_CALC table.</p> <p>Note: The system creates the repricing request for the account irrespective of whether the account is eligible for repricing or not.</p>
<p>On defining, editing, overriding, or copying the price item pricing of a person</p>	<p>The system identifies all accounts which belong to the person and its child persons, and then creates a repricing request for the account, price item, and effective date combination in the CI_REPRC_REQ_DTL table. If the price assignment end date is specified, the system creates two repricing requests – one request where the effective date is set to the price assignment start date and another request where the effective date is set to the price assignment end date + 1 Day. On executing the Process Repricing Request and Persist Pricing for an Account (C1-REPC2) batch, you can recalculate and persist the rate for the account in the CI_PRCE_CALC table.</p> <p>Note:</p> <p>Only accounts where the person and child person are the main customers are considered for repricing.</p> <p>The system creates the repricing request for the account irrespective of whether the account is eligible for repricing or not.</p>
<p>On defining or editing the price item pricing of an active price list which is assigned to an account or a person</p>	<p>The system creates an entry for the price item pricing in the CI_REPRC_ENTITY_DTL table. On executing the Identify Accounts for Repricing (C1-REPC1) batch, the system identifies the following in the specified order:</p> <ol style="list-style-type: none"> 1. Price list on which the price item pricing is assigned 2. Account or Person on which the price list is assigned 3. All accounts which belong to the person and its child persons when the price list is assigned to a person <p>Once the accounts are identified, the system checks whether the identified accounts are eligible for repricing. If one or more accounts are eligible for repricing, a repricing request is created for the account, price item, and effective date combination in the CI_REPRC_REQ_DTL table. If the price assignment end date is specified, the system creates two repricing requests – one request where the effective date is set to the price assignment start date and another request</p>

Scenario	System Behaviour
	<p>where the effective date is set to the price assignment end date + 1 Day. On executing the Process Repricing Request and Persist Pricing for an Account (C1-REPC2) batch, you can recalculate and persist the rate for the account in the CI_PRCE_CALC table.</p> <p>Note: Only accounts where the person and child person are the main customers are considered for repricing.</p>

For more information about the **Identify Accounts for Repricing (C1-REPC1)** and **Process Repricing Request and Persist Pricing for an Account (C1-REPC2)** batches, refer to *Oracle Revenue Management and Billing Batch Guide*.

To enable the repricing feature, you need to do the following:

- Define an algorithm using the **C1-REPRCACCT** algorithm type and attach it to the **Audit** algorithm spot of the **C1-AccountBO** business object
- Define an algorithm using the **C1-REPRCACBC** algorithm type and attach it to the **Audit** algorithm spot of the **C1-ACCBALCNT** business object
- Define an algorithm using the **C1-REPRCPERS** algorithm type and attach it to the **Audit** algorithm spot of the **C1_PERSON_BO** business object
- Define an algorithm using the **C1-REPRCPEBC** algorithm type and attach it to the **Audit** algorithm spot of the **C1-PERBALCNT** business object
- Define an algorithm using the **C1_PLASGNAUD** algorithm type and attach it to the **Audit** algorithm spot of the **C1_PLASGNADD** and **C1_PLASGNEDIT** business objects
- Define an algorithm using the **C1-PRCASGNAD** algorithm type and attach it to the **Audit** algorithm spot of the **C1_PRICEASGN_BO** business object
- Define an algorithm using the **C1-REPRCPLPA** algorithm type and attach it to the **Audit** algorithm spot of the **C1_PRICEASGN_BO** business object
- Define the required parameters for the account and person attributes, characteristics, usage amount and usage counter

Two-Dimensional Pricing

Note: This topic is not applicable for the health insurance business.

Oracle Revenue Management and Billing enables you to define two-dimensional pricing for a price item. In the two-dimensional pricing, you can offer rates based on utilization of two service quantity identifiers (SQIs). For example, the rate for a price item can vary for each customer depending on the number of ATM transactions and current monthly balance as shown below: Current Monthly Balance Number of ATM Transactions 0-25 25-50 50-75 75-100 0-10000 2 1.9 1.8 1.7 10000-50000 1.6 1.5 1.4 1.3 50000-100000 1.2 1.1 1.0 0.9 100000-500000 0.8 0.7 0.6 0.5 The system allows you to define two-dimensional pricing in a grid which has X-axis and Y-axis. Both, the X-axis and Y-axis should contain service quantity identifiers (SQIs). The two-dimensional pricing is composed of threshold and step tiered pricing. The X-axis is a threshold tier and Y-axis is a step tier. On creating two-dimensional pricing, one price component is created for each X-axis and Y-axis combination. The step tier is stored as the tiering range whereas the threshold tier is stored as the eligibility criteria in the price component. Note that the tiering ranges and eligibility criteria are automatically created in the price component. You cannot manually add a tiering range and eligibility criteria in the price component. You can define two-dimensional pricing when the tiering type of the rate components in the rate schedule is set to STEP. A new field named Pricing Rule Type is added in the Price Item Pricing screen. If you select the Two-Dimensional option from the Pricing Rule Type list, you can define two-dimensional pricing for the price item. However, if you do not select the Two-Dimensional option from the Pricing Rule Type list, you can define traditional flat, step, or tiered

pricing for the price item. Besides selecting the Two-Dimensional option from the Pricing Rule Type list, you also need to select the Pricing Eligibility option while defining the two-dimensional pricing for the price item.

Types of Price Item Bundle

Note: This topic is not applicable for the health insurance business.

The system allows you to define the following types of price item bundle:

- [Regular Bundle](#) on page 287
- [Phantom Bundle](#) on page 291
- [Ratio Bundle](#) on page 288

Regular Bundle

Note: This topic is not applicable for the health insurance business.

In case of a regular bundle, pricing is defined at the bundle level. The system determines the rate by identifying the tiering range within which the total service quantities used for all price items in the bundle fall. Note that the rate is determined from the tiering range of the price component whose pricing eligibility criteria is met. Let us understand this with the help of an example.

Bundle X, which is a regular bundle, contains the following three price items:

- Price Item A
- Price Item B
- Price Item C

The following tiered pricing is defined for Bundle X:

Quantity Range	Rate (\$) per unit
1 – 3000	3
3001 – 4000	2
4001 – 8000	1

Note: In the above example, the assumption is that there only one rate component, one price component within the rate component, and pricing eligibility criteria is not defined for the price component.

Now, when the user consumes 1500 units of Price Item A, 1000 units of Price Item B, and 2000 units of Price Item C, the system adds the quantities of services used for all price items in Bundle X (i.e. $1500+1000+2000=4500$), and then determines the range within which the total units (i.e. 4500) fall. In this case, the total units fall in the 4001 – 8000 range, and therefore the system uses \$1 as the rate for calculating charges.

If the multi parameter based pricing feature is enabled, you can define pricing for regular bundles based on multiple parameters. For example:

Bundle X	Country	Currency
Pricing 1	US	USD
Pricing 2	Germany	USD

Pricing 1 and Pricing 2 are defined for Bundle X based on two parameters — Country and Currency. Before you define pricing based on country and currency, you need to define these parameters in the system. Once you define these

parameters, you need to associate them to the regular bundle (i.e. Bundle X) and then add price items (i.e. Price Item A, Price Item B, and Price Item C) to the bundle. Note that you can add a price item to a regular bundle when the regular bundle and price item have same parameters associated with them for the specified date range. Therefore, before adding Price Item A, Price Item B, and Price Item C to Bundle X, you should ensure that Country and Currency are also associated with these price items.

Then, when you define Pricing 1 for Bundle X, you need to set the following price item parameters:

- Country — US
- Currency — USD

Similarly, you need to define Pricing 2 with Country set to Germany and Currency set to USD.

The following table lists the tiering ranges defined in Pricing 1 where price item parameters are set to US, USD:

Tier Sequence	Rate	Tiering Criteria	Price Item	Price Parameters	Item	From	To
10	2	Number of Transactions	Bundle X	US, USD		0	500
20	1	Number of Transactions	Bundle X	US, USD		500	

The following table lists the tiering ranges defined in Pricing 2 where price item parameters are set to Germany, USD:

Tier Sequence	Rate	Tiering Criteria	Price Item	Price Parameters	Item	From	To
10	4	Number of Transactions	Bundle X	Germany, USD		0	1000
20	3	Number of Transactions	Bundle X	Germany, USD		1000	

Now, when the user performs 500 transactions (in USD) of Bundle X in Germany, 1200 transactions (in USD) of Bundle X in US, the system creates two billable charges. In one billable charge (with Bundle X, US and USD combination), the system uses \$1 as the rate for calculating charges, and in another billable charge (with Bundle X, Germany and USD combination), the system uses \$4 as the rate for calculating charges.

Ratio Bundle

Note: This topic is not applicable for the health insurance business.

In case of a ratio bundle, pricing is not defined at the bundle level. Instead, pricing is defined separately for each price item in the bundle.

A ratio expresses the magnitude of quantities relative to each other. It has two factors — Numerator and Denominator. For ratio bundle, the ratio of price item quantities is used to determine the rate for volume based pricing. To determine within which range of ratio limit does the price item utilization falls, the ratio of price item quantities is used. Once the range limits are determined, the rate specified for that range is applied to the quantity of the price item used. Let us understand this with the help of an example.

Bundle X, which is a ratio bundle, contains the following price items:

- **Price Item A** — It has been added to the bundle using the price item relationship type as Numerator. It has the following tiered pricing defined in the system:

Quantity Range	Rate (\$) per unit
0 – 0.6	4

Quantity Range	Rate (\$) per unit
0.6 – 0.9	3
0.9+	2

- **Price Item B** — It has been added to the bundle using the price item relationship type as Numerator. It has the following tiered pricing defined in the system:

Quantity Range	Rate (\$) per unit
0 – 0.6	5
0.6 – 0.9	4
0.9+	3

- **Price Item C** — It has been added to the bundle using the price item relationship type as Denominator. It has the following tiered pricing defined in the system:

Quantity Range	Rate (\$) per unit
0 – 0.6	3
0.6 – 0.9	2
0.9+	1

Now, when the user consumes 500 units of Price Item A, 2500 units of Price Item B, and 4000 units of Price Item C, the system calculates the ratio of price item quantities (i.e. $(500+2500)/4000=0.75$). Once the ratio is calculated, the system determines the range of each price item within which the ratio (i.e. 0.75) falls. In this case, the ratio falls in the 0.6 – 0.9 range of Price Item A, B, and C. Therefore, the system uses \$3, \$4, and \$2, respectively, as the rate for calculating charges (i.e. $(500*3)=1500$, $(2500*4)=10000$, and $(4000*2)=8000$).

If the multi parameter based pricing feature is enabled, you can determine the price item utilization in a ratio bundle based on multiple parameters. For example:

Bundle X	Country	Currency
Price Item A	US	USD
Price Item B	Germany	USD
Price Item C	England	USD

Price Item A, Price Item B, and Price Item C are added in Bundle X. Price Item A, Price Item B, and Price Item C utilization in Bundle X is determined based on two parameters — Country and Currency. Before you add price item to a ratio bundle, you need to define these parameters in the system. Once you define these parameters, you need to associate them to the price items (i.e. Price Item A, Price Item B, and Price Item C) and then add these price items to the bundle (i.e. Bundle X).

While adding Price Item A to Bundle X, you need to set the following price item parameters:

- Country — US
- Currency — USD

Similarly, you need to add Price Item B to Bundle X with Country set to Germany and Currency set to USD, and Price Item C with Country set to England and Currency set to USD.

The following table lists the tiered pricing defined for Price Item A:

Tier Sequence	Rate	Tiering Criteria	Price Item	Price Parameters	Item	From	To
10	5	Number of Transactions	Bundle X			0	1.75
20	4	Number of Transactions	Bundle X			1.75	2.50
30	3	Number of Transactions	Bundle X			2.50	

The following table lists the tiered pricing defined for Price Item B:

Tier Sequence	Rate	Tiering Criteria	Price Item	Price Parameters	Item	From	To
10	5	Number of Transactions	Bundle X			0	3.5
20	4	Number of Transactions	Bundle X			3.5	

The following table lists the tiered pricing defined for Price Item C:

Tier Sequence	Rate	Tiering Criteria	Price Item	Price Parameters	Item	From	To
10	2	Number of Transactions	Bundle X			0	2.0
20	1	Number of Transactions	Bundle X			2.0	

Now, when the user performs 5000 transactions (in USD) of Price Item A in US, 6000 transactions (in USD) of Price Item B in Germany, and 5000 transactions (in USD) of Price Item C in England, the system creates three billable charges — one for each price item (i.e. Price Item A, Price Item B, and Price Item C). The system calculates the ratio of transactions with the following combinations and then determines the range of each price item within which the ratio (i.e. 2.2) falls:

- Price Item A, US, USD
- Price Item B, Germany, USD
- Price Item C, England, USD

In this case, the ratio falls in the 1.75 – 2.50 range of Price Item A, the 0 – 3.5 range of Price Item B, and in the 2.0 — Infinite range of Price Item C. Therefore, the system uses \$4, \$5, and \$1 as the rate for calculating charges (i.e. $(5000*4)=20000$, $(6000*5)=30000$, and $(5000*1)=5000$).

You can also add a price item more than once in a ratio bundle with different set of parameters. For example:

Bundle X	Relationship Type	Country	Currency
Price Item A	Numerator	US	USD
Price Item A	Numerator	England	USD
Price Item B	Numerator	Germany	USD
Price Item C	Denominator	England	USD
Price Item C	Denominator	US	USD

In this case, the system calculates the ratio of transactions with the following combinations and then determines the range of each price item (i.e. Price Item A, Price Item B, and Price Item C) within which the ratio falls:

- Price Item A, US, USD
- Price Item A, England, USD
- Price Item B, Germany, USD
- Price Item C, England, USD

- Price Item C, US, USD

Phantom Bundle

Note: This topic is not applicable for the health insurance business.

In case of a phantom bundle, pricing is not defined at the bundle level. Instead, pricing is defined separately for each price item in the bundle. The system determines the price by identifying the tiering range of each price item within which the total quantities of services used for all price items in the bundle fall. Let us understand this with the help of an example.

Bundle A, which is a phantom bundle, contains the following two price items:

- **Price Item X** — The following tiered pricing is defined for Price Item X:

Quantity Range	Rate (\$) per unit
1 – 3000	3
3001 – 6000	2

- **Price Item Y** — The following tiered pricing is defined for Price Item Y:

Quantity Range	Rate (\$) per unit
1 – 5000	2
5001 – 10000	1

Now, when the user consumes 2500 units of Price Item X and 3500 units of Price Item Y, the system adds the quantities of services used for all price items in Bundle A (i.e. 2500+3500=6000), and then determines the range of each price item within which the total units (i.e. 6000) fall. In this case, the total units fall in the 3001 – 6000 range of Price Item X and the 5001 – 10000 range of Price Item Y, and therefore the system uses \$2 and \$1, respectively, as the rate for calculating charges (i.e. (2500*2)= 5000 and (3500*1)=3500). This helps the customer to take advantage of the lowest rate.

If the multi parameter based pricing feature is enabled, you can determine the price item utilization in a phantom bundle based on multiple parameters. For example:

Bundle A	Country	Currency
Price Item X	US	USD
Price Item Y	Germany	USD

Price Item X and Price Item Y are added in Bundle A. Price Item X and Price Item Y utilization in Bundle A is determined based on two parameters — Country and Currency. Before you add price item to a phantom bundle, you need to define these parameters in the system. Once you define these parameters, you need to associate them to the price items (i.e. Price Item X and Price Item Y) and then add these price items to the bundle (i.e. Bundle A).

While adding Price Item X to Bundle A, you need to set the following price item parameters:

- Country — US
- Currency — USD

Similarly, you need to add Product Y to Bundle A with Country set to Germany and Currency set to USD.

The following table lists the tiered pricing defined for Price Item X:

Tier Sequence	Rate	Tiering Criteria	Price Item	Price Parameters	Item	From	To
10	3	Number of Transactions	Bundle A			0	5000
20	2	Number of Transactions	Bundle A			5000	10000

Tier Sequence	Rate	Tiering Criteria	Price Item	Price Parameters	Item	From	To
30	1	Number of Transactions	Bundle A			10000	

The following table lists the tiered pricing defined for Price Item Y:

Tier Sequence	Rate	Tiering Criteria	Price Item	Price Parameters	Item	From	To
10	5	Number of Transactions	Bundle A			0	5000
20	4	Number of Transactions	Bundle A			5000	

Now, when the user performs 5000 transactions (in USD) of Price Item Y in Germany, 6000 transactions (in USD) of Price Item X in US, the system creates two billable charges — one for Price Item X and another for Price Item Y. The system adds the transactions with the following combinations and then determines the range of each price item within which the total units (i.e. 11000) fall:

- Price Item X, US, USD
- Price Item Y, Germany, USD

In this case, the total units fall in the 10000 – Infinite range of Price Item X and the 5000 – Infinite range of Price Item Y, and therefore the system uses \$1 and \$4, respectively, as the rate for calculating charges (i.e. $(5000*4)=20000$ and $(6000*1)=6000$).

You can also add a price item more than once in a phantom bundle with different set of parameters. For example:

Bundle A	Country	Currency
Price Item X	US	USD
Price Item X	Germany	USD
Price Item Y	Germany	USD
Price Item Y	US	USD

In this case, the system adds the transactions with the following combinations and then determines the range of each price item (i.e. Price Item X and Price Item Y) within which the total units fall:

- Price Item X, US, USD
- Price Item X, Germany, USD
- Price Item Y, Germany, USD
- Price Item Y, US, USD

Parameter

The pricing for a price item may differ depending upon various transaction, person, account, or product attributes. Oracle Revenue Management and Billing provides a facility to define pricing for a price item based on multiple parameters. In addition, you can define the pricing, price list, and product eligibility criteria using one or more parameters.

Each parameter must be mapped to the following:

- **Source Entity** - Indicates the entity from where the parameter value is derived. A source entity can be account, person, product, transaction, service quantity identifier, or an algorithm.
- **Source Type** - Indicates the type of source from where the parameter value is derived. A source type can be field, characteristic, usage amount, or usage counter.

- **Source Type Code** - Indicates the source (such as, field, characteristic, usage amount, usage counter, SQL, or algorithm) from where the parameter value is derived.

The system allows you to define the following types of parameters:

- **Adhoc** - Used to store an adhoc value.
- **Predefined** - Used to store a predefined value. For example, you can create a parameter named **Country** where the value type is set to **Predefined** and the following predefined values are added in the parameter:

Parameter Value	Description
AUT	Austria
AUS	Australia
CAN	Canada
CHN	China

In such case, while defining the pricing for a price item using the **Country** parameter, you can use any one of the above mentioned parameter values.

Another example, you can create a parameter named **Health Coverage Class** where the value type is set to **Predefined** and the following predefined values are added in the parameter:

Parameter Value	Description
MEDICAL	Medical
DENTAL	Dental
VISION	Vision

In such case, while defining the pricing for a price item using the **Health Coverage Class** parameter, you can use any one of the above mentioned parameter values.

- **Reference** - Used to store a value which is already present in a table. For example, you can create a parameter named **Country** where the value type is set to **Reference** and the reference entity is set to **CI_COUNTRY_L** (i.e. where the description of all countries is stored). In such case, while defining the pricing for a price item using the **Country** parameter, you can specify a country which is present in the **CI_COUNTRY_L** table in the parameter value.

Parameter (Used for Searching)

The **Parameter** screen allows you to define, view, edit, delete and copy a parameter. It contains the following zone:

- [Search Parameter](#) on page 293

Search Parameter

The **Search Parameter** zone allows you to search for a parameter using various search criteria. It contains the following two sections:





- **Search Criteria** - The **Search Criteria** section contains the following fields:

Field Name	Field Description	Mandatory (Yes or No)
Parameter	Used to search a particular parameter.	No
Value Type	Used to search parameters in which a particular type of value is stored. The valid values are: <ul style="list-style-type: none"> • Adhoc 	No

Field Name	Field Description	Mandatory (Yes or No)
	<ul style="list-style-type: none"> • Predefined • Reference 	
Source Entity	<p>Used to search parameters whose value is derived from a particular entity. The valid values are:</p> <ul style="list-style-type: none"> • Account • Algorithm • Benefit • Health Plan • Health Product • Membership • Membership Person • Person • Policy Plan • Product • Service Quantity Identifier • State • Transaction 	No
Source Type	<p>Used to search parameters whose value is derived from a particular type of source. The valid values are:</p> <ul style="list-style-type: none"> • Characteristic • Field • Usage Amount • Usage Counter 	No
Description	Used to search parameters having a particular description.	No

- **Search Results** - On clicking the **Search** button, the search results appear based on the specified search criteria. The **Search Results** section contains the following columns:

Column Name	Column Description
Parameter	Displays the parameter.
Description	Displays the description of the parameter.
Value Type	<p>Indicates the type of value that you want to store in the parameter. The valid values are:</p> <ul style="list-style-type: none"> • Adhoc • Predefined • Reference

Column Name	Column Description
Source Entity	<p>Indicates the entity from where the parameter value is derived. The valid values are:</p> <ul style="list-style-type: none"> • Account • Algorithm • Benefit • Health Plan • Health Product • Membership • Membership Person • Person • Policy Plan • Product • Service Quantity Identifier • State • Transaction
Source Type	<p>Indicates the type of source from where the parameter value is derived. The valid values are:</p> <ul style="list-style-type: none"> • Characteristic • Field • Usage Amount • Usage Counter
View	<p>On clicking the View () icon corresponding to a parameter, the Parameter screen appears where you can view the details of the respective parameter.</p>
Edit	<p>On clicking the Edit () icon corresponding to a parameter, the Parameter screen appears where you can edit the details of the parameter.</p>
Delete	<p>On clicking the Delete () icon corresponding to a parameter, you can delete the parameter.</p> <div style="border: 1px solid black; padding: 5px; margin-top: 10px;"> <p>Note:</p> <p>You can delete a parameter when the following conditions are met:</p> <ul style="list-style-type: none"> • It is not yet associated to any price item or price item bundle. • It is not yet used while defining the pricing, price list, or pricing eligibility criteria. </div>
Copy	<p>On clicking the Copy () icon corresponding to a parameter, the Parameter screen appears where you can define a new parameter using an existing parameter.</p>

Note: Pagination is used to display limited number of records in the **Search Results** section. You can use the navigation links, such as **Previous** and **Next** to navigate between pages.

Related Topics

For more information on...	See...
How to search for a parameter	Searching for a Parameter on page 296
How to view the details of a parameter	Viewing the Parameter Details on page 317
How to edit a parameter	Editing a Parameter on page 303
How to delete a parameter	Deleting a Parameter on page 310
How to copy a parameter	Copying a Parameter on page 310

Searching for a Parameter

Procedure

To search for a parameter:

1. Click the **Admin** link in the **Application** toolbar.
A list appears.
2. From the **Admin** menu, select **P** and then click **Parameter**.
The **Parameter** screen appears.
3. Enter the search criteria in the **Search Parameter** zone.

Note: ORMB search engine supports wildcard search, where you can substitute the percentage (%) symbol as a stand in for any word or letter in a search criteria. You can use the ‘%’ wildcard character in all input fields except the date and ID fields. The ‘%’ wildcard character is suffixed automatically at the end of the partial search criteria. Therefore, you may or may not specify the wildcard character at the end of the partial search criteria. However, you have to prefix the wildcard character manually wherever required.

4. Click **Search**.
A list of parameters that meet the search criteria appears in the **Search Results** section.

Related Topics

For more information on...	See...
Parameter screen	Parameter (Used for Searching) on page 293
Search Parameter zone	Search Parameter on page 293

Defining a Parameter

Prerequisites

To define a parameter, you should have:

- Validation algorithm defined using the **C1_PPARM_VAL** algorithm type (in case you want to validate an adhoc parameter value)
- An algorithm defined using the **C1-PPARM-ENT** algorithm type (in case you want to use the algorithm while validating the pricing eligibility criteria)

Note:

A sample algorithm type named **C1_PPARM_VAL** is shipped with the product. At present, it allows you to specify any special characters except ampersand (&), comma (,), underscore (_), equal to (=), tilde (~), and semi-colon(;) in the parameter value.

A sample algorithm type named **C1-PPARM-ENT** is shipped with the product. At present, it returns a boolean value true. You can build custom logic in this algorithm which returns a value. This value can then be compared against the parameter value specified in the pricing eligibility criteria.

Procedure

To define a parameter:

1. Click the **Admin** link in the **Application** toolbar.

A list appears.

2. From the **Admin** menu, select **P** and then click **Parameter**.

The **Parameter** screen appears.

3. Click the **Add** button available in the **Page Title** area of the **Parameter** screen.

The **Parameter** screen appears. It contains the following fields:

Field Name	Field Description	Mandatory (Yes or No)
Parameter	Used to specify the parameter. Note: You cannot specify any special character except underscore (_) in the parameter name.	Yes
Source Entity	Used to indicate the entity from where the parameter value is derived. The valid values are: <ul style="list-style-type: none"> • Account • Algorithm • Benefit • Health Plan Note: This option is not applicable for the banking business. <ul style="list-style-type: none"> • Health Product Note: This option is not applicable for the banking business. <ul style="list-style-type: none"> • Membership Note: This option is not applicable for the banking business. <ul style="list-style-type: none"> • Membership Person Note: This option is not applicable for the banking business. <ul style="list-style-type: none"> • Person 	Yes

Field Name	Field Description	Mandatory (Yes or No)
	<ul style="list-style-type: none"> • Policy Plan <div style="border: 1px solid black; padding: 2px; margin: 5px 0;"> <p>Note: This option is not applicable for the banking business.</p> </div> <ul style="list-style-type: none"> • Product <div style="border: 1px solid black; padding: 2px; margin: 5px 0;"> <p>Note: This option is not applicable for the health insurance business.</p> </div> <ul style="list-style-type: none"> • Service Quantity Identifier • State • Transaction 	
Description	Used to specify the description for the parameter.	Yes
Source Type	<p>Used to indicate the type of source from where the parameter value is derived. The valid values are:</p> <ul style="list-style-type: none"> • Characteristic • Field • Usage Amount • Usage Counter <div style="border: 1px solid black; padding: 5px; margin-top: 10px;"> <p>Note:</p> <p>This field appears when the Account, Person, Benefit, Health Plan, Health Product, Membership, Membership Person, Person, Policy Plan, Product, or State option is selected from the Source Entity list.</p> <p>The Usage Amount and Usage Counter options do not appear in the Source Type list when the Benefit, Health Plan, Health Product, Membership, Membership Person, Policy Plan, Product, or State option is selected from the Source Entity list.</p> </div>	Yes
Value Type	<p>Used to indicate the type of value that you want to store in the parameter. The valid values are:</p> <ul style="list-style-type: none"> • Adhoc • Predefined • Reference 	Yes
Source Type Code	Used to indicate the source, such as field, characteristic, usage amount, usage counter, SQL, or algorithm, from where the parameter value is derived.	Yes

Field Name	Field Description	Mandatory (Yes or No)																														
	<p>Note:</p> <p>This field does not appear when the Transaction option is selected from the Source Entity list.</p> <p>The following table indicates the values that are listed in the Source Type Code field depending on the source entity and source type combination:</p> <table border="1" data-bbox="634 457 1170 2091"> <thead> <tr> <th data-bbox="634 457 773 537">Source Entity</th> <th data-bbox="773 457 927 537">Source Type</th> <th data-bbox="927 457 1170 537">Source Type Code</th> </tr> </thead> <tbody> <tr> <td data-bbox="634 537 773 716">Account</td> <td data-bbox="773 537 927 716">Characteristic</td> <td data-bbox="927 537 1170 716">Lists all characteristics where the characteristic entity is set to Account.</td> </tr> <tr> <td data-bbox="634 716 773 798">Account</td> <td data-bbox="773 716 927 798">Field</td> <td data-bbox="927 716 1170 798">Lists all fields of the CI_ACCT table.</td> </tr> <tr> <td data-bbox="634 798 773 942">Account</td> <td data-bbox="773 798 927 942">Usage Amount</td> <td data-bbox="927 798 1170 942">Lists all values defined for the BAL_FLG lookup field.</td> </tr> <tr> <td data-bbox="634 942 773 1087">Account</td> <td data-bbox="773 942 927 1087">Usage Counter</td> <td data-bbox="927 942 1170 1087">Lists all values defined for the CNT_FLG lookup field.</td> </tr> <tr> <td data-bbox="634 1087 773 1266">Algorithm</td> <td data-bbox="773 1087 927 1266">—</td> <td data-bbox="927 1087 1170 1266">Lists all algorithms which are defined using the C1-PPARM-ENT algorithm type.</td> </tr> <tr> <td data-bbox="634 1266 773 1444">Benefit</td> <td data-bbox="773 1266 927 1444">Characteristic</td> <td data-bbox="927 1266 1170 1444">Lists all characteristics where the characteristic entity is set to Benefit.</td> </tr> <tr> <td data-bbox="634 1444 773 1558">Benefit</td> <td data-bbox="773 1444 927 1558">Field</td> <td data-bbox="927 1444 1170 1558">Lists all fields of the C1_BENEFITS table.</td> </tr> <tr> <td data-bbox="634 1558 773 1940">Health Plan</td> <td data-bbox="773 1558 927 1940">Characteristic</td> <td data-bbox="927 1558 1170 1940"> Lists all characteristics where the characteristic entity is set to Health Plan. <div data-bbox="932 1776 1166 1923" style="border: 1px solid black; padding: 2px; margin-top: 10px;"> Note: This option is not applicable for the banking business. </div> </td> </tr> <tr> <td data-bbox="634 1940 773 2091">Health Plan</td> <td data-bbox="773 1940 927 2091">Field</td> <td data-bbox="927 1940 1170 2091">Lists all the fields of the C1_HEALTH_PLAN table.</td> </tr> </tbody> </table>	Source Entity	Source Type	Source Type Code	Account	Characteristic	Lists all characteristics where the characteristic entity is set to Account .	Account	Field	Lists all fields of the CI_ACCT table.	Account	Usage Amount	Lists all values defined for the BAL_FLG lookup field.	Account	Usage Counter	Lists all values defined for the CNT_FLG lookup field.	Algorithm	—	Lists all algorithms which are defined using the C1-PPARM-ENT algorithm type.	Benefit	Characteristic	Lists all characteristics where the characteristic entity is set to Benefit .	Benefit	Field	Lists all fields of the C1_BENEFITS table.	Health Plan	Characteristic	Lists all characteristics where the characteristic entity is set to Health Plan . <div data-bbox="932 1776 1166 1923" style="border: 1px solid black; padding: 2px; margin-top: 10px;"> Note: This option is not applicable for the banking business. </div>	Health Plan	Field	Lists all the fields of the C1_HEALTH_PLAN table.	
Source Entity	Source Type	Source Type Code																														
Account	Characteristic	Lists all characteristics where the characteristic entity is set to Account .																														
Account	Field	Lists all fields of the CI_ACCT table.																														
Account	Usage Amount	Lists all values defined for the BAL_FLG lookup field.																														
Account	Usage Counter	Lists all values defined for the CNT_FLG lookup field.																														
Algorithm	—	Lists all algorithms which are defined using the C1-PPARM-ENT algorithm type.																														
Benefit	Characteristic	Lists all characteristics where the characteristic entity is set to Benefit .																														
Benefit	Field	Lists all fields of the C1_BENEFITS table.																														
Health Plan	Characteristic	Lists all characteristics where the characteristic entity is set to Health Plan . <div data-bbox="932 1776 1166 1923" style="border: 1px solid black; padding: 2px; margin-top: 10px;"> Note: This option is not applicable for the banking business. </div>																														
Health Plan	Field	Lists all the fields of the C1_HEALTH_PLAN table.																														

Field Name	Field Description	Mandatory (Yes or No)
Validation Algorithm	Used to indicate the algorithm using which you want to validate the adhoc parameter value.	No
	<p>Note:</p> <p>This field appears when the Adhoc option is selected from the Value Type list.</p> <p>The Search (🔍) icon appears corresponding to the Validation Algorithm field. On clicking the Search icon, the Algorithm Search window appears where you can search for the required algorithm.</p>	
Reference Entity	Used to indicate the table whose primary key (column) you want to set as the reference entity.	Yes
	<p>Note:</p> <p>This field appears only when the Reference option is selected from the Value Type list.</p> <p>The Search (🔍) icon appears corresponding to the Reference Entity field. On clicking the Search icon, the Reference Table Search window appears where you can search for the required table.</p> <p>You can only specify a language table, where the DESCR column is available, in the Reference Entity field.</p>	
Field Name	Indicates the column which is the primary key of the table. The parameter value is then validated against the primary column of the table.	Not applicable
	<p>Note: This field appears when the Reference option is selected from the Value Type list.</p>	

In addition, this screen contains the following two sections:

- **Parameter Values** - Used to define the predefined values for the parameter. It contains the following fields in a grid:

Field Name	Field Description	Mandatory (Yes or No)
Parameter Values	Used to specify the value for the parameter.	Yes (Conditional)
	<p>Note: You can specify any special characters except ampersand (&), comma (,), underscore (_), equal to (=), tilde (~), and semi-colon(:) in the predefined parameter value.</p>	<p>Note: This field is required while defining the predefined parameter values.</p>
Description	Used to specify the description for the parameter value.	Yes (Conditional)

Field Name	Field Description	Mandatory (Yes or No)
		Note: This field is required while defining the predefined parameter values.

Note:

The **Parameter Values** section appears only when the **Predefined** option is selected from the **Value Type** list.

At least one parameter value should be defined for a parameter where the value type is set to **Predefined**.

If you want to define more than one predefined value for the parameter, click the **Add (+)** icon and then specify the details.

However, if you want to remove a predefined value of the parameter, click the **Delete (🗑)** icon corresponding to the parameter value.

- **Parameter Usage** - Used to indicate where you want to use the parameter in the system. It contains the following options:

Option Name	Option Description	Mandatory (Yes or No)
Price Item	Used to indicate whether the parameter is associated with a price item or price item bundle. If the parameter is associated with a price item or price item bundle, you can use the parameter while defining the price item pricing.	Yes (Conditional)
	Note: This option does not appear when the Algorithm , Health Product , or the Service Quantity Identifier option is selected from the Source Entity list.	Note: This option is required while associating the parameter with a price item.
Pricing Eligibility Criteria	Used to indicate whether the parameter is used for defining the pricing eligibility criteria.	Yes (Conditional)
	Note: This option does not appear when the Transaction option is selected from the Source Entity list.	Note: This option is required while defining a pricing eligibility criteria using the parameter.
Pricing Rule Eligibility Criteria	Used to indicate whether the parameter is used for defining a rule based pricing eligibility criteria.	Yes (Conditional)
	Note: This option appears only when the Membership or the Membership Person option is selected from the Source Entity list.	Note: This option is required while using the parameter for defining a rule based pricing eligibility criteria.
Business Rule Eligibility Criteria	Used to indicate whether the parameter is used for defining a rule based business eligibility criteria.	Yes (Conditional)

Option Name	Option Description	Mandatory (Yes or No)
	Note: This option appears only when the Health Plan, Health Product, Membership, or the Membership Person option is selected from the Source Entity list.	Note: This option is required while using the parameter for defining a rule based business eligibility criteria.
Price List Eligibility Criteria	Used to indicate whether the parameter is used for defining the price list eligibility criteria.	Yes (Conditional)
	Note: This option does not appear when the Health Product or the Transaction option is selected from the Source Entity list.	Note: This option is required while defining a price list eligibility criteria using the parameter.
Product Eligibility Criteria	Used to indicate whether the parameter is used for defining the product eligibility criteria.	Yes (Conditional)
	Note: This option does not appear when the Algorithm, Health Product, Service Quantity Identifier, or the Transaction option is selected from the Source Entity list.	Note: This option is required while defining a product eligibility criteria using the parameter.
Rule Eligibility Criteria	Used to indicate whether the parameter is used while defining the parameter based rule type.	Yes (Conditional)
	Note: This option does not appear when the Health Product, Product, Service Quantity Identifier, or the Transaction option is selected from the Source Entity list.	Note: This option is required while defining a parameter based rule type.

Note: You must select at least one option in the **Parameter Usage** section.

4. Enter the required details in the **Parameter** screen.
5. Click **Save**.

The parameter is defined.

Note: If a parameter is already defined using the source entity, source type, and source type code combination, the system will not allow you to define another parameter with the same combination.

Related Topics

For more information on...	See...
Parameter screen	Parameter (Used for Searching) on page 293

Editing a Parameter

Prerequisites

To edit a parameter, you should have:

- Validation algorithm defined using the **C1_PPARM_VAL** algorithm type (in case you want to validate an adhoc parameter value)
- An algorithm defined using the **C1-PPARM-ENT** algorithm type (in case you want to use the algorithm while validating the pricing eligibility criteria)

Note:

A sample algorithm type named **C1_PPARM_VAL** is shipped with the product. At present, it allows you to specify any special characters except ampersand (&), comma (,), underscore (_), equal to (=), tilde (~), and semi-colon(;) in the parameter value.

A sample algorithm type named **C1-PPARM-ENT** is shipped with the product. At present, it returns a boolean value true. You can build custom logic in this algorithm which returns a value. This value can then be compared against the parameter value specified in the pricing eligibility criteria.

Procedure

To edit a parameter:

1. Search for the parameter in the **Parameter** screen.
2. In the **Search Results** section, click the **Edit** (✎) icon in the **Edit** column corresponding to the parameter whose details you want to edit.

The **Parameter** screen appears. It contains the following fields:

Field Name	Field Description	Mandatory (Yes or No)
Parameter	Displays the parameter. Note: You cannot specify any special character except underscore (_) in the parameter name.	Not applicable
Source Entity	Used to indicate the entity from where the parameter value is derived. The valid values are: <ul style="list-style-type: none"> • Account • Algorithm • Benefit • Health Plan Note: This option is not applicable for the banking business. <ul style="list-style-type: none"> • Health Product Note: This option is not applicable for the banking business. <ul style="list-style-type: none"> • Membership 	Yes

Field Name	Field Description	Mandatory (Yes or No)
	<p>Note: This option is not applicable for the banking business.</p> <ul style="list-style-type: none"> • Membership Person <p>Note: This option is not applicable for the banking business.</p> <ul style="list-style-type: none"> • Person • Policy Plan <p>Note: This option is not applicable for the banking business.</p> <ul style="list-style-type: none"> • Product <p>Note: This option is not applicable for the health insurance business.</p> <ul style="list-style-type: none"> • Service Quantity Identifier • State • Transaction 	
Description	Used to specify the description for the parameter.	Yes
Source Type	<p>Used to indicate the type of source from where the parameter value is derived. The valid values are:</p> <ul style="list-style-type: none"> • Characteristic • Field • Usage Amount • Usage Counter <p>Note:</p> <p>This field appears when the Account, Person, Benefit, Health Plan, Health Product, Membership, Membership Person, Person, Policy Plan, Product, or State option is selected from the Source Entity list.</p> <p>The Usage Amount and Usage Counter options do not appear in the Source Type list when the Benefit, Health Plan, Health Product, Membership, Membership Person, Policy Plan, Product, or State option is selected from the Source Entity list.</p>	Yes
Value Type	<p>Displays the type of value that you want to store in the parameter. The valid values are:</p> <ul style="list-style-type: none"> • Adhoc • Predefined 	Not applicable

Field Name	Field Description	Mandatory (Yes or No)
	<ul style="list-style-type: none"><li data-bbox="662 205 808 231">Reference	
Source Type Code	Used to indicate the source, such as field, characteristic, usage amount, usage counter, SQL, or algorithm, from where the parameter value is derived.	Yes

Field Name	Field Description	Mandatory (Yes or No)																														
	<p>Note:</p> <p>This field does not appear when the Transaction option is selected from the Source Entity list.</p> <p>The following table indicates the values that are listed in the Source Type Code field depending on the source entity and source type combination:</p> <table border="1" data-bbox="634 457 1170 2095"> <thead> <tr> <th data-bbox="634 457 773 537">Source Entity</th> <th data-bbox="773 457 927 537">Source Type</th> <th data-bbox="927 457 1170 537">Source Type Code</th> </tr> </thead> <tbody> <tr> <td data-bbox="634 537 773 716">Account</td> <td data-bbox="773 537 927 716">Characteristic</td> <td data-bbox="927 537 1170 716">Lists all characteristics where the characteristic entity is set to Account.</td> </tr> <tr> <td data-bbox="634 716 773 798">Account</td> <td data-bbox="773 716 927 798">Field</td> <td data-bbox="927 716 1170 798">Lists all fields of the CI_ACCT table.</td> </tr> <tr> <td data-bbox="634 798 773 945">Account</td> <td data-bbox="773 798 927 945">Usage Amount</td> <td data-bbox="927 798 1170 945">Lists all values defined for the BAL_FLG lookup field.</td> </tr> <tr> <td data-bbox="634 945 773 1092">Account</td> <td data-bbox="773 945 927 1092">Usage Counter</td> <td data-bbox="927 945 1170 1092">Lists all values defined for the CNT_FLG lookup field.</td> </tr> <tr> <td data-bbox="634 1092 773 1270">Algorithm</td> <td data-bbox="773 1092 927 1270">—</td> <td data-bbox="927 1092 1170 1270">Lists all algorithms which are defined using the C1-PPARM-ENT algorithm type.</td> </tr> <tr> <td data-bbox="634 1270 773 1449">Benefit</td> <td data-bbox="773 1270 927 1449">Characteristic</td> <td data-bbox="927 1270 1170 1449">Lists all characteristics where the characteristic entity is set to Benefit.</td> </tr> <tr> <td data-bbox="634 1449 773 1562">Benefit</td> <td data-bbox="773 1449 927 1562">Field</td> <td data-bbox="927 1449 1170 1562">Lists all fields of the C1_BENEFITS table.</td> </tr> <tr> <td data-bbox="634 1562 773 1940">Health Plan</td> <td data-bbox="773 1562 927 1940">Characteristic</td> <td data-bbox="927 1562 1170 1940"> Lists all characteristics where the characteristic entity is set to Health Plan. <div data-bbox="932 1776 1166 1923" style="border: 1px solid black; padding: 2px; margin-top: 10px;"> Note: This option is not applicable for the banking business. </div> </td> </tr> <tr> <td data-bbox="634 1940 773 2095">Health Plan</td> <td data-bbox="773 1940 927 2095">Field</td> <td data-bbox="927 1940 1170 2095">Lists all the fields of the C1_HEALTH_PLAN table.</td> </tr> </tbody> </table>	Source Entity	Source Type	Source Type Code	Account	Characteristic	Lists all characteristics where the characteristic entity is set to Account .	Account	Field	Lists all fields of the CI_ACCT table.	Account	Usage Amount	Lists all values defined for the BAL_FLG lookup field.	Account	Usage Counter	Lists all values defined for the CNT_FLG lookup field.	Algorithm	—	Lists all algorithms which are defined using the C1-PPARM-ENT algorithm type.	Benefit	Characteristic	Lists all characteristics where the characteristic entity is set to Benefit .	Benefit	Field	Lists all fields of the C1_BENEFITS table.	Health Plan	Characteristic	Lists all characteristics where the characteristic entity is set to Health Plan . <div data-bbox="932 1776 1166 1923" style="border: 1px solid black; padding: 2px; margin-top: 10px;"> Note: This option is not applicable for the banking business. </div>	Health Plan	Field	Lists all the fields of the C1_HEALTH_PLAN table.	
Source Entity	Source Type	Source Type Code																														
Account	Characteristic	Lists all characteristics where the characteristic entity is set to Account .																														
Account	Field	Lists all fields of the CI_ACCT table.																														
Account	Usage Amount	Lists all values defined for the BAL_FLG lookup field.																														
Account	Usage Counter	Lists all values defined for the CNT_FLG lookup field.																														
Algorithm	—	Lists all algorithms which are defined using the C1-PPARM-ENT algorithm type.																														
Benefit	Characteristic	Lists all characteristics where the characteristic entity is set to Benefit .																														
Benefit	Field	Lists all fields of the C1_BENEFITS table.																														
Health Plan	Characteristic	Lists all characteristics where the characteristic entity is set to Health Plan . <div data-bbox="932 1776 1166 1923" style="border: 1px solid black; padding: 2px; margin-top: 10px;"> Note: This option is not applicable for the banking business. </div>																														
Health Plan	Field	Lists all the fields of the C1_HEALTH_PLAN table.																														

Field Name	Field Description	Mandatory (Yes or No)
Validation Algorithm	<p>Used to indicate the algorithm using which you want to validate the adhoc parameter value.</p> <p>Note: This field appears when the Adhoc option is selected from the Value Type list.</p> <p>The Search (🔍) icon appears corresponding to the Validation Algorithm field. On clicking the Search icon, the Algorithm Search window appears where you can search for the required algorithm.</p>	No
Reference Entity	<p>Used to indicate the table whose primary key (column) you want to set as the reference entity.</p> <p>Note: This field appears only when the Reference option is selected from the Value Type list.</p> <p>The Search (🔍) icon appears corresponding to the Reference Entity field. On clicking the Search icon, the Reference Table Search window appears where you can search for the required table.</p> <p>You can only specify a language table, where the DESCR column is available, in the Reference Entity field.</p>	Yes
Field Name	<p>Indicates the column which is the primary key of the table. The parameter value is then validated against the primary column of the table.</p> <p>Note: This field appears when the Reference option is selected from the Value Type list.</p>	Not applicable

In addition, this screen contains the following two sections:

- **Parameter Values** - Used to define the predefined values for the parameter. It contains the following fields in a grid:

Field Name	Field Description	Mandatory (Yes or No)
Parameter Values	<p>Used to specify the value for the parameter.</p> <p>Note: You can specify any special characters except ampersand (&), comma (,), underscore (_), equal to (=), tilde (~), and semi-colon(;) in the predefined parameter value.</p>	<p>Yes (Conditional)</p> <p>Note: This field is required while defining the predefined parameter values.</p>
Description	Used to specify the description for the parameter value.	Yes (Conditional)

Field Name	Field Description	Mandatory (Yes or No)
		Note: This field is required while defining the predefined parameter values.

Note:

The **Parameter Values** section appears only when the **Predefined** option is selected from the **Value Type** list.

At least one parameter value should be defined for a parameter where the value type is set to **Predefined**.

If you want to define more than one predefined value for the parameter, click the **Add (+)** icon and then specify the details.

However, if you want to remove a predefined value of the parameter, click the **Delete (🗑)** icon corresponding to the parameter value.

- **Parameter Usage** - Used to indicate where you want to use the parameter in the system. It contains the following options:

Option Name	Option Description	Mandatory (Yes or No)
Price Item	Used to indicate whether the parameter is associated with a price item or price item bundle. If the parameter is associated with a price item or price item bundle, you can use the parameter while defining the price item pricing.	Yes (Conditional)
	Note: This option does not appear when the Algorithm , Health Product , or the Service Quantity Identifier option is selected from the Source Entity list.	Note: This option is required while associating the parameter with a price item.
Pricing Eligibility Criteria	Used to indicate whether the parameter is used for defining the pricing eligibility criteria.	Yes (Conditional)
	Note: This option does not appear when the Transaction option is selected from the Source Entity list.	Note: This option is required while defining a pricing eligibility criteria using the parameter.
Pricing Rule Eligibility Criteria	Used to indicate whether the parameter is used for defining a rule based pricing eligibility criteria.	Yes (Conditional)
	Note: This option appears only when the Membership or the Membership Person option is selected from the Source Entity list.	Note: This option is required while using the parameter for defining a rule based pricing eligibility criteria.
Business Rule Eligibility Criteria	Used to indicate whether the parameter is used for defining a rule based business eligibility criteria.	Yes (Conditional)

Option Name	Option Description	Mandatory (Yes or No)
	Note: This option appears only when the Health Plan, Health Product, Membership, or the Membership Person option is selected from the Source Entity list.	Note: This option is required while using the parameter for defining a rule based business eligibility criteria.
Price List Eligibility Criteria	Used to indicate whether the parameter is used for defining the price list eligibility criteria.	Yes (Conditional)
	Note: This option does not appear when the Health Product or the Transaction option is selected from the Source Entity list.	Note: This option is required while defining a price list eligibility criteria using the parameter.
Product Eligibility Criteria	Used to indicate whether the parameter is used for defining the product eligibility criteria.	Yes (Conditional)
	Note: This option does not appear when the Algorithm, Health Product, Service Quantity Identifier, or the Transaction option is selected from the Source Entity list.	Note: This option is required while defining a product eligibility criteria using the parameter.
Rule Eligibility Criteria	Used to indicate whether the parameter can be used while defining the parameter based rule type.	Yes (Conditional)
	Note: This option does not appear when the Health Product, Product, Service Quantity Identifier, or the Transaction option is selected from the Source Entity list.	Note: This option is required while defining a parameter based rule type.

Note: You must select at least one option in the **Parameter Usage** section.

3. Modify the required details in the **Parameter** screen.
4. Click **Save**.

The changes made to the parameter are saved.

Related Topics

For more information on...	See...
How to search for a parameter	Searching for a Parameter on page 296
Parameter screen	Parameter (Used for Searching) on page 293

Deleting a Parameter

Procedure

To delete a parameter:

1. Search for the parameter in the **Parameter** screen.
2. In the **Search Results** section, click the **Delete** (🗑️) icon in the **Delete** column corresponding to the parameter that you want to delete.

A message appears confirming whether you want to delete the parameter.

3. Click **OK**.

The parameter is deleted.

Note:

You can delete a parameter only when:

- It is not yet associated to any price item or price item bundle.
- It is not yet used while defining the pricing, business rule, price list, product eligibility, or rule eligibility criteria.

Related Topics

For more information on...	See...
How to search for a parameter	Searching for a Parameter on page 296
Parameter screen	Parameter (Used for Searching) on page 293

Copying a Parameter

Instead of creating a parameter from scratch, you can define a new parameter using an existing parameter. This is possible through copying a parameter. When you copy a parameter, the predefined values, validation algorithm, and reference entity (depending upon the value type) are copied along with the parameter usage details. You can then edit the details, if required.

Note: You cannot change the value type that is stored in the new parameter (which is created using an existing parameter).

Prerequisites

To copy a parameter, you should have:

- Parameter (whose copy you want to create) defined in the application
- Validation algorithm defined using the **C1_PPARM_VAL** algorithm type (in case you want to validate an adhoc parameter value)
- An algorithm defined using the **C1-PPARM-ENT** algorithm type (in case you want to use the algorithm while validating the pricing eligibility criteria)

Note:

A sample algorithm type named **C1_PPARAM_VAL** is shipped with the product. At present, it allows you to specify any special characters except ampersand (&), comma (,), underscore (_), equal to (=), tilde (~), and semi-colon(;): in the parameter value.

A sample algorithm type named **C1-PPARM-ENT** is shipped with the product. At present, it returns a boolean value true. You can build custom logic in this algorithm which returns a value. This value can then be compared against the parameter value specified in the pricing eligibility criteria.

Procedure

To copy a parameter:

1. Search for the parameter in the **Parameter** screen.
2. In the **Search Results** section, click the **Copy** (📄) icon in the **Copy** column corresponding to the parameter whose copy you want to create.

The **Parameter** screen appears. It contains the following fields:

Field Name	Field Description	Mandatory (Yes or No)
Parameter	Used to specify the parameter.	Yes
	Note: You cannot specify any special character except underscore (_) in the parameter name.	
Source Entity	Used to indicate the entity from where the parameter value is derived. The valid values are: <ul style="list-style-type: none"> • Account • Algorithm • Benefit • Health Plan 	Yes
	Note: This option is not applicable for the banking business.	
	• Health Product	
	Note: This option is not applicable for the banking business.	
	• Membership	
	Note: This option is not applicable for the banking business.	
	• Membership Person	
	Note: This option is not applicable for the banking business.	
• Person		
• Policy Plan		

Field Name	Field Description	Mandatory (Yes or No)
	<div data-bbox="691 205 1179 281" style="border: 1px solid black; background-color: #f2f2f2; padding: 2px;"> <p>Note: This option is not applicable for the banking business.</p> </div> <ul style="list-style-type: none"> • Product <div data-bbox="691 352 1179 428" style="border: 1px solid black; background-color: #f2f2f2; padding: 2px;"> <p>Note: This option is not applicable for the health insurance business.</p> </div> <ul style="list-style-type: none"> • Service Quantity Identifier • State • Transaction 	
Description	Used to specify the description for the parameter.	Yes
Source Type	<p>Used to indicate the type of source from where the parameter value is derived. The valid values are:</p> <ul style="list-style-type: none"> • Characteristic • Field • Usage Amount • Usage Counter <div data-bbox="630 940 1179 1388" style="border: 1px solid black; background-color: #f2f2f2; padding: 2px;"> <p>Note:</p> <p>This field appears when the Account, Person, Benefit, Health Plan, Health Product, Membership, Membership Person, Person, Policy Plan, Product, or State option is selected from the Source Entity list.</p> <p>The Usage Amount and Usage Counter options do not appear in the Source Type list when the Benefit, Health Plan, Health Product, Membership, Membership Person, Policy Plan, Product, or State option is selected from the Source Entity list.</p> </div>	Yes
Value Type	<p>Used to indicate the type of value that you want to store in the parameter. The valid values are:</p> <ul style="list-style-type: none"> • Adhoc • Predefined • Reference 	Not applicable
Source Type Code	Used to indicate the source, such as field, characteristic, usage amount, usage counter, SQL, or algorithm, from where the parameter value is derived.	Yes

Field Name	Field Description	Mandatory (Yes or No)																														
	<p>Note:</p> <p>This field does not appear when the Transaction option is selected from the Source Entity list.</p> <p>The following table indicates the values that are listed in the Source Type Code field depending on the source entity and source type combination:</p> <table border="1" data-bbox="634 457 1174 2089"> <thead> <tr> <th data-bbox="634 457 773 537">Source Entity</th> <th data-bbox="773 457 927 537">Source Type</th> <th data-bbox="927 457 1174 537">Source Type Code</th> </tr> </thead> <tbody> <tr> <td data-bbox="634 537 773 716">Account</td> <td data-bbox="773 537 927 716">Characteristic</td> <td data-bbox="927 537 1174 716">Lists all characteristics where the characteristic entity is set to Account.</td> </tr> <tr> <td data-bbox="634 716 773 798">Account</td> <td data-bbox="773 716 927 798">Field</td> <td data-bbox="927 716 1174 798">Lists all fields of the CI_ACCT table.</td> </tr> <tr> <td data-bbox="634 798 773 945">Account</td> <td data-bbox="773 798 927 945">Usage Amount</td> <td data-bbox="927 798 1174 945">Lists all values defined for the BAL_FLG lookup field.</td> </tr> <tr> <td data-bbox="634 945 773 1092">Account</td> <td data-bbox="773 945 927 1092">Usage Counter</td> <td data-bbox="927 945 1174 1092">Lists all values defined for the CNT_FLG lookup field.</td> </tr> <tr> <td data-bbox="634 1092 773 1270">Algorithm</td> <td data-bbox="773 1092 927 1270">—</td> <td data-bbox="927 1092 1174 1270">Lists all algorithms which are defined using the C1-PPARM-ENT algorithm type.</td> </tr> <tr> <td data-bbox="634 1270 773 1449">Benefit</td> <td data-bbox="773 1270 927 1449">Characteristic</td> <td data-bbox="927 1270 1174 1449">Lists all characteristics where the characteristic entity is set to Benefit.</td> </tr> <tr> <td data-bbox="634 1449 773 1562">Benefit</td> <td data-bbox="773 1449 927 1562">Field</td> <td data-bbox="927 1449 1174 1562">Lists all fields of the C1_BENEFITS table.</td> </tr> <tr> <td data-bbox="634 1562 773 1940">Health Plan</td> <td data-bbox="773 1562 927 1940">Characteristic</td> <td data-bbox="927 1562 1174 1940"> Lists all characteristics where the characteristic entity is set to Health Plan. <div data-bbox="932 1776 1167 1923" style="border: 1px solid black; padding: 2px; margin-top: 10px;"> Note: This option is not applicable for the banking business. </div> </td> </tr> <tr> <td data-bbox="634 1940 773 2089">Health Plan</td> <td data-bbox="773 1940 927 2089">Field</td> <td data-bbox="927 1940 1174 2089">Lists all the fields of the C1_HEALTH_PLAN table.</td> </tr> </tbody> </table>	Source Entity	Source Type	Source Type Code	Account	Characteristic	Lists all characteristics where the characteristic entity is set to Account .	Account	Field	Lists all fields of the CI_ACCT table.	Account	Usage Amount	Lists all values defined for the BAL_FLG lookup field.	Account	Usage Counter	Lists all values defined for the CNT_FLG lookup field.	Algorithm	—	Lists all algorithms which are defined using the C1-PPARM-ENT algorithm type.	Benefit	Characteristic	Lists all characteristics where the characteristic entity is set to Benefit .	Benefit	Field	Lists all fields of the C1_BENEFITS table.	Health Plan	Characteristic	Lists all characteristics where the characteristic entity is set to Health Plan . <div data-bbox="932 1776 1167 1923" style="border: 1px solid black; padding: 2px; margin-top: 10px;"> Note: This option is not applicable for the banking business. </div>	Health Plan	Field	Lists all the fields of the C1_HEALTH_PLAN table.	
Source Entity	Source Type	Source Type Code																														
Account	Characteristic	Lists all characteristics where the characteristic entity is set to Account .																														
Account	Field	Lists all fields of the CI_ACCT table.																														
Account	Usage Amount	Lists all values defined for the BAL_FLG lookup field.																														
Account	Usage Counter	Lists all values defined for the CNT_FLG lookup field.																														
Algorithm	—	Lists all algorithms which are defined using the C1-PPARM-ENT algorithm type.																														
Benefit	Characteristic	Lists all characteristics where the characteristic entity is set to Benefit .																														
Benefit	Field	Lists all fields of the C1_BENEFITS table.																														
Health Plan	Characteristic	Lists all characteristics where the characteristic entity is set to Health Plan . <div data-bbox="932 1776 1167 1923" style="border: 1px solid black; padding: 2px; margin-top: 10px;"> Note: This option is not applicable for the banking business. </div>																														
Health Plan	Field	Lists all the fields of the C1_HEALTH_PLAN table.																														

Field Name	Field Description	Mandatory (Yes or No)
Validation Algorithm	Used to indicate the algorithm using which you want to validate the adhoc parameter value.	No
	<p>Note:</p> <p>This field appears when the Adhoc option is selected from the Value Type list.</p> <p>The Search (🔍) icon appears corresponding to the Validation Algorithm field. On clicking the Search icon, the Algorithm Search window appears where you can search for the required algorithm.</p>	
Reference Entity	Used to indicate the table whose primary key (column) you want to set as the reference entity.	Yes
	<p>Note:</p> <p>This field appears only when the Reference option is selected from the Value Type list.</p> <p>The Search (🔍) icon appears corresponding to the Reference Entity field. On clicking the Search icon, the Reference Table Search window appears where you can search for the required table.</p> <p>You can only specify a language table, where the DESCR column is available, in the Reference Entity field.</p>	
Field Name	Indicates the column which is the primary key of the table. The parameter value is then validated against the primary column of the table.	Not applicable
	<p>Note: This field appears when the Reference option is selected from the Value Type list.</p>	

In addition, this screen contains the following two sections:

- **Parameter Values** - Used to define the predefined values for the parameter. It contains the following fields in a grid:

Field Name	Field Description	Mandatory (Yes or No)
Parameter Values	Used to specify the value for the parameter.	Yes (Conditional)
	<p>Note: You can specify any special characters except ampersand (&), comma (,), underscore (_), equal to (=), tilde (~), and semi-colon(:) in the predefined parameter value.</p>	<p>Note: This field is required while defining the predefined parameter values.</p>
Description	Used to specify the description for the parameter value.	Yes (Conditional)

Field Name	Field Description	Mandatory (Yes or No)
		Note: This field is required while defining the predefined parameter values.

Note:

The **Parameter Values** section appears only when the **Predefined** option is selected from the **Value Type** list.

At least one parameter value should be defined for a parameter where the value type is set to **Predefined**.

If you want to define more than one predefined value for the parameter, click the **Add (+)** icon and then specify the details.

However, if you want to remove a predefined value of the parameter, click the **Delete (🗑)** icon corresponding to the parameter value.

- **Parameter Usage** - Used to indicate where you want to use the parameter in the system. It contains the following options:

Option Name	Option Description	Mandatory (Yes or No)
Price Item	Used to indicate whether the parameter is associated with a price item or price item bundle. If the parameter is associated with a price item or price item bundle, you can use the parameter while defining the price item pricing.	Yes (Conditional)
	Note: This option does not appear when the Algorithm , Health Product , or the Service Quantity Identifier option is selected from the Source Entity list.	Note: This option is required while associating the parameter with a price item.
Pricing Eligibility Criteria	Used to indicate whether the parameter is used for defining the pricing eligibility criteria.	Yes (Conditional)
	Note: This option does not appear when the Transaction option is selected from the Source Entity list.	Note: This option is required while defining a pricing eligibility criteria using the parameter.
Pricing Rule Eligibility Criteria	Used to indicate whether the parameter is used for defining a rule based pricing eligibility criteria.	Yes (Conditional)
	Note: This option appears only when the Membership or the Membership Person option is selected from the Source Entity list.	Note: This option is required while using the parameter for defining a rule based pricing eligibility criteria.
Business Rule Eligibility Criteria	Used to indicate whether the parameter is used for defining a rule based business eligibility criteria.	Yes (Conditional)

Option Name	Option Description	Mandatory (Yes or No)
	Note: This option appears only when the Health Plan, Health Product, Membership, or the Membership Person option is selected from the Source Entity list.	Note: This option is required while using the parameter for defining a rule based business eligibility criteria.
Price List Eligibility Criteria	Used to indicate whether the parameter is used for defining the price list eligibility criteria.	Yes (Conditional)
	Note: This option does not appear when the Health Product or the Transaction option is selected from the Source Entity list.	Note: This option is required while defining a price list eligibility criteria using the parameter.
Product Eligibility Criteria	Used to indicate whether the parameter is used for defining the product eligibility criteria.	Yes (Conditional)
	Note: This option does not appear when the Algorithm, Health Product, Service Quantity Identifier, or the Transaction option is selected from the Source Entity list.	Note: This option is required while defining a product eligibility criteria using the parameter.
Rule Eligibility Criteria	Used to indicate whether the parameter can be used while defining the parameter based rule type.	Yes (Conditional)
	Note: This option does not appear when the Health Product, Product, Service Quantity Identifier, or the Transaction option is selected from the Source Entity list.	Note: This option is required while defining a parameter based rule type.

Note: You must select at least one option in the **Parameter Usage** section.

3. Enter the required details in the **Parameter** screen.
4. Click **Save**.

The new parameter is defined.

Note: If a parameter is already defined using the source entity, source type, and source type code combination, the system will not allow you to define another parameter with the same combination.

Related Topics

For more information on...	See...
How to search for a parameter	Searching for a Parameter on page 296
Parameter screen	Parameter (Used for Searching) on page 293

Viewing the Parameter Details

Procedure

To view the details of a parameter:

1. Search for the parameter in the **Parameter** screen.
2. In the **Search Results** section, click the **View** () icon in the **View** column corresponding to the parameter whose details you want to view.

The **Parameter** screen appears.

3. View the details of the parameter in the **Parameter** zone.

Related Topics

For more information on...	See...
How to search for a parameter	Searching for a Parameter on page 296
Parameter screen	Parameter (Used for Viewing) on page 317
Parameter zone	Parameters on page 405

Parameter (Used for Viewing)

The **Parameter** screen allows you to view the details of a parameter. It contains the following zone:

- [Parameter](#) on page 317

Parameter

The **Parameter** zone displays the details of the parameter. It contains the following sections:

- **Main** – Displays basic information about the parameter. It contains the following fields:

Field Name	Field Description
Parameter	Displays the parameter name.
Description	Displays the description of the parameter.
Value Type	Indicates the type of value that you want to store in the parameter. The valid values are: <ul style="list-style-type: none"> • Adhoc • Predefined • Reference
Validation Algorithm	Indicates the algorithm using which you want to validate the adhoc parameter value.

Field Name	Field Description
	<p>Note:</p> <p>This field appears when the Adhoc option is selected from the Value Type list. It has a link. On clicking the link, the Algorithm screen appears where you can view the details of the respective algorithm.</p>
Referenced Table	<p>Indicates the table whose primary key (i.e. column) is used to validate the parameter value.</p> <p>Note:</p> <p>This field appears when the Reference option is selected from the Value Type list. It has a link. On clicking the link, the Table screen appears where you can view the details of the respective table.</p>
Source Entity	<p>Indicates the entity from where the parameter value is derived. The valid values are:</p> <ul style="list-style-type: none"> • Account • Algorithm • Benefit • Health Plan <p>Note: This option is not applicable for the banking business.</p> <ul style="list-style-type: none"> • Health Product <p>Note: This option is not applicable for the banking business.</p> <ul style="list-style-type: none"> • Membership <p>Note: This option is not applicable for the banking business.</p> <ul style="list-style-type: none"> • Membership Person <p>Note: This option is not applicable for the banking business.</p> <ul style="list-style-type: none"> • Person • Policy Plan <p>Note: This option is not applicable for the banking business.</p> <ul style="list-style-type: none"> • Product <p>Note: This option is not applicable for the health insurance business.</p> <ul style="list-style-type: none"> • Service Quantity Identifier • State • Transaction

Field Name	Field Description
Source Type	<p>Indicates the type of source from where the parameter value is derived. The valid values are:</p> <ul style="list-style-type: none"> • Characteristic • Field • Usage Amount • Usage Counter <p>Note:</p> <p>This field appears when the Account, Person, Benefit, Health Plan, Health Product, Membership, Membership Person, Person, Policy Plan, Product, or State option is selected from the Source Entity list.</p> <p>The Usage Amount and Usage Counter options do not appear in the Source Type list when the Benefit, Health Plan, Health Product, Membership, Membership Person, Policy Plan, Product, or State option is selected from the Source Entity list.</p>
Source Type Code	<p>Indicates the source, such as field, characteristic, usage amount, usage counter, SQL, or algorithm, from where the parameter value is derived.</p> <p>Note: This field does not appear when the Transaction option is selected from the Source Entity list.</p>

- **Parameter Values** - Lists the predefined values of the parameter. It contains the following columns:

Column Name	Column Description
Parameter Value	Displays the value of the parameter.
Description	Displays the description of the parameter value.

Note: The **Parameter Values** section appears when the **Predefined** option is selected from the **Value Type** list.

- **Parameter Usage** – Indicates where you can use the parameter in the system. It contains the following options:

Option Name	Option Description
Price Item	<p>Indicates whether the parameter is associated with a price item or price item bundle. If a parameter is associated with a price item or price item bundle, you can use the parameter while defining the price item pricing.</p> <p>The following table lists the source entity and source type combinations when the Price Item option does not appear in the Parameter Usage section:</p> <p>Note: This option does not appear when the Algorithm, Health Product, or the Service Quantity Identifier option is selected from the Source Entity list.</p>
Pricing Eligibility Criteria	<p>Indicates whether the parameter is used for defining the pricing eligibility criteria.</p> <p>Note: This option does not appear when the Transaction option is selected from the Source Entity list.</p>

Option Name	Option Description
Pricing Rule Eligibility Criteria	Indicates whether the parameter is used for defining a rule based pricing eligibility criteria.
	Note: This option appears only when the Membership or the Membership Person option is selected from the Source Entity list.
Business Rule Eligibility Criteria	Indicates whether the parameter is used for defining a rule based business eligibility criteria.
	Note: This option appears only when the Health Plan, Health Product, Membership, or the Membership Person option is selected from the Source Entity list.
Price List Eligibility Criteria	Indicates whether the parameter is used for defining the price list eligibility criteria.
	Note: This option does not appear when the Health Product or the Transaction option is selected from the Source Entity list.
Product Eligibility Criteria	Indicates whether the parameter is used for defining the product eligibility criteria.
	Note: This option does not appear when the Algorithm, Health Product, Service Quantity Identifier, or the Transaction option is selected from the Source Entity list.
Rule Eligibility Criteria	Indicates whether the parameter is used while defining the parameter based rule type.
	Note: This option does not appear when the Health Product, Product, Service Quantity Identifier, or the Transaction option is selected from the Source Entity list.

Related Topics

For more information on...	See...
Parameter screen	Parameter (Used for Viewing) on page 317

Entity Hierarchy Relationship

Note: This topic is not applicable for the health insurance business.

An entity hierarchy relationship enables you to group related services (i.e. price items) offered to the customers under one group header for the reporting purposes. You can define group headers as hierarchy entities in the system. For example, you can group all payment services, such as Auto Clearing House (ACH) Transfer, Auto Clearing

House (ACH) Reversal, Lockbox Service, Dealer Debit, and so on under a group header (i.e. hierarchy entity) named Payments.

You can include hierarchy entities at different levels and thereby design the structure for an entity hierarchy relationship. For example, you can create three hierarchy entities named Cash Management, Payments, and e-Statements. Then, while designing the structure of an entity hierarchy relationship named CASHMGT, you include the Cash Management hierarchy entity at the first or root level and then the Payments and e-Statements hierarchy entities at the second level.

While defining a hierarchy entity, you need to specify the following:

- Level at which you can include the hierarchy entity in an entity hierarchy relationship.
- Division to which the hierarchy entity is associated.

You can include a hierarchy entity in an entity hierarchy relationship when the hierarchy entity is associated with the division for which the entity hierarchy relationship is created. You can associate a hierarchy entity with one or more divisions. While associating a hierarchy entity with a division, you need to specify the date from when the hierarchy entity is associated with the division. The system allows you to include a hierarchy entity in an entity hierarchy relationship when the hierarchy entity is effective for the division on the entity hierarchy relationship start date.

At present, the system supports maximum 10 levels in an entity hierarchy relationship. Therefore, you can define hierarchy entities for upto 9 levels (i.e. Level 1, Level 2, ..., Level 9). The last level (i.e. Level 10) is reserved for a price item that you want to include in an entity hierarchy relationship. If you do not require 10 levels in an entity hierarchy relationship, you can set a lower maximum limit in the **Maximum Hierarchy Level** option type of the **C1-EHRCONFIG** feature configuration. However, note that the system will allow you to create a hierarchy entity upto one level less than the level specified in the **Maximum Hierarchy Level** option type. For example, if you set the value of the **Maximum Hierarchy Level** option type to 5, the system allows you to create hierarchy entities for upto four levels (i.e. Level 1, Level 2, Level 3, and Level 4). The last level (i.e. Level 5) is reserved for a price item that you want to include in an entity hierarchy relationship. Therefore, you need to accordingly set the value as per the business requirements.

While defining an entity hierarchy relationship, you need to specify the following:

- Division for which you want to create the entity hierarchy relationship.
- The date range for which the entity hierarchy relationship is effective for the division.
- The hierarchy entity that you want to include at the first or root level (i.e. Level 1) in the entity hierarchy relationship. Here, you can only specify a hierarchy entity where the entity level is set to Level 1.

Note: This is the root from where the entity hierarchy relationship starts and hence only Level 1 entities are allowed to be placed at the root of the entity hierarchy relationship.

- The hierarchy entities that you want to include at the subsequent levels (i.e. Level 2, Level 3, and so on) in the entity hierarchy relationship and their respective parent hierarchy entity.

Note: You can include only those hierarchy entities which are associated with the division for which the entity hierarchy relationship is created and which are effective for the division on the entity hierarchy relationship start date.

You can include multiple hierarchy entities at the same level. But, you need to ensure that the parent hierarchy entity for such parallel levels is same. For example, when you include the Payments and e-Statements hierarchy entities at the same level, you need to ensure that their parent hierarchy entity is set to Cash Management.

```
Cash Management
  Payments
    ACH Transfer
```

Associating a price item or price item bundle with a hierarchy entity does not have any impact on the billing module. At present, the price item hierarchy is only displayed in the Deal Modelling and Simulation module.

While editing an entity hierarchy relationship, you cannot change the hierarchy entity at the first level when a price item is associated with a hierarchy entity either at the first or subsequent level in the entity hierarchy relationship. In addition, you cannot delete an entity level from the entity hierarchy relationship or change the details of an entity level when a

price item is associated with the hierarchy entity at the respective entity level or at any level in the vertical hierarchy of the entity hierarchy relationship. Let us assume we have the following entity hierarchy relationship...

```
Cash Management
  Payments
    ACH Transfer
    ACH Reversal
    Lockbox Service
    Dealer Debit
  e-Statements
    TWIST Statement
    CAMT Statement
    SWIFT Statement
```

In the above entity hierarchy relationship, you cannot remove the `Payments` or `e-Statements` entity level or change the details of the `Payments` or `e-Statements` entity level because the price items are associated with the `Payments` and `e-Statements` hierarchy entities. In addition, you cannot change the hierarchy entity at the root level because the price items are associated with the `Payments` and `e-Statements` entity levels which is in the vertical hierarchy of `Cash Management`.

Hierarchy Entity (Used for Searching)

Note: This topic is not applicable for the health insurance business.

The **Hierarchy Entity** screen allows you to search for a hierarchy entity using various search criteria. It also allows you to define a hierarchy entity. It contains the following zone:

- [Search Hierarchy Entity](#) on page 322

Through this screen, you can navigate to the following screen:

- [Hierarchy Entity \(Used for Viewing\)](#) on page 329

Search Hierarchy Entity

Note: This topic is not applicable for the health insurance business.

The **Search Hierarchy Entity** zone allows you to search for a hierarchy entity using various search criteria. It contains the following two sections:

- **Search Criteria** - The **Search Criteria** section contains the following fields:

Field Name	Field Description	Mandatory (Yes or No)
Hierarchy Entity	Used to search a particular hierarchy entity.	No
Description	Used to search hierarchy entities with a particular description.	No
Entity Level	Used to search hierarchy entities which can be included at a particular level in an entity hierarchy relationship. The valid values are: <ul style="list-style-type: none"> • Level 1 • Level 2 • Level 3 • Level 4 • Level 5 • Level 6 	No

Field Name	Field Description	Mandatory (Yes or No)
	<ul style="list-style-type: none"> Level 7 Level 8 Level 9 	
Status	Used to search hierarchy entities with a particular status. The valid values are: <ul style="list-style-type: none"> Active Inactive 	No
Division	Used to search hierarchy entities which are associated with a particular division.	No

Note: You must specify at least one search criterion while searching for a hierarchy entity.

- **Search Results** - On clicking the **Search** button, the search results appear based on the specified search criteria. The **Search Results** section contains the following columns:

Column Name	Column Description
Hierarchy Entity Information	Displays information about the hierarchy entity.
	Note: It has a link. On clicking the link, the Hierarchy Entity screen appears where you can view the details of the respective hierarchy entity.
Entity Level	Indicates the level at which the hierarchy entity can be included in an entity hierarchy relationship. The valid values are: <ul style="list-style-type: none"> Level 1 Level 2 Level 3 Level 4 Level 5 Level 6 Level 7 Level 8 Level 9
Status	Indicates the status of the hierarchy entity. The valid values are: <ul style="list-style-type: none"> Active Inactive
Division	Indicates the division to which the hierarchy entity is associated.
Effective Date	Displays the date from when the hierarchy entity is associated with the division.

Note: Pagination is used to display limited number of records in the **Search Results** section. You can use the navigation links, such as **Previous** and **Next** to navigate between pages.

Related Topics

For more information on...	See...
How to search for a hierarchy entity	Searching for a Hierarchy Entity on page 324
How to view the details of a hierarchy entity	Viewing the Hierarchy Entity Details on page 324

Searching for a Hierarchy Entity

Note: This topic is not applicable for the health insurance business.

Prerequisites

To search for a hierarchy entity, you should have:

- Divisions defined in the application

Procedure

To search for a hierarchy entity:

1. Click the **Admin** link in the **Application** toolbar.
A list appears.
2. From the **Admin** menu, select **H** and then click **Hierarchy Entity**.
A sub-menu appears.
3. Click the **Search** option from the **Hierarchy Entity** sub-menu.
The **Hierarchy Entity** screen appears.
4. Enter the search criteria in the **Search Hierarchy Entity** zone.

Note: ORMB search engine supports wildcard search, where you can substitute the percentage (%) symbol as a stand in for any word or letter in a search criteria. You can use the ‘%’ wildcard character in all input fields except the date and ID fields. The ‘%’ wildcard character is suffixed automatically at the end of the partial search criteria. Therefore, you may or may not specify the wildcard character at the end of the partial search criteria. However, you have to prefix the wildcard character manually wherever required.

5. Click **Search**.

A list of hierarchy entities that meet the search criteria appears in the **Search Results** section.

Related Topics

For more information on...	See...
Hierarchy Entity screen	Hierarchy Entity (Used for Searching) on page 322
Search Hierarchy Entity zone	Search Hierarchy Entity on page 322

Viewing the Hierarchy Entity Details

Note: This topic is not applicable for the health insurance business.

Procedure

To view the details of a hierarchy entity:

1. Search for the hierarchy entity in the **Hierarchy Entity** screen.
2. In the **Search Results** section, click the link in the **Hierarchy Entity Information** column corresponding to the hierarchy entity whose details you want to view.

The **Hierarchy Entity** screen appears. It contains the following zone:

- [Hierarchy Entity](#) on page 329

3. View the details of the hierarchy entity in the **Hierarchy Entity** zone.

Related Topics

For more information on...	See...
How to search for a hierarchy entity	Searching for a Hierarchy Entity on page 324
Hierarchy Entity screen	Hierarchy Entity (Used for Viewing) on page 329

Defining a Hierarchy Entity

Note: This topic is not applicable for the health insurance business.

Prerequisites

To define a hierarchy entity, you should have:

- Value defined for the **Maximum Hierarchy Level** option type in the **C1-EHRCONFIG** feature configuration

Procedure

To define a hierarchy entity:

1. Click the **Admin** link in the **Application** toolbar.
A list appears.
2. From the **Admin** menu, select **H** and then click **Hierarchy Entity**.
A sub-menu appears.
3. Click the **Add** option from the **Hierarchy Entity** sub-menu.

The **Select Business Object** screen appears. It contains the following field:

Field Name	Field Description	Mandatory (Yes or No)
Hierarchy Entity Business Object	Used to indicate the business object using which you want to create the hierarchy entity in the system.	Yes

Tip: Alternatively, you can access the **Select Business Object** screen by clicking the **Add** button in the **Page Title** area of the **Hierarchy Entity** screen.

Note: The **Select Business Object** screen appears when there are multiple hierarchy entity business objects defined in the application. If there is only one hierarchy entity business object defined in the application, the **Hierarchy Entity** screen appears.

4. Select the required hierarchy entity business object from the respective field.
5. Click **OK**.

The **Hierarchy Entity** screen appears. It contains the following sections:

- **Main** - Used to specify basic details about the hierarchy entity.
- **Divisions** - Used to associate the hierarchy entity with one or more divisions.
- **Characteristics** - Used to define the characteristics for the hierarchy entity.

The **Main** section contains the following fields:

Field Name	Field Description	Mandatory (Yes or No)
Hierarchy Entity	Used to specify the hierarchy entity.	Yes
Description	Used to specify the description for the hierarchy entity.	Yes
Entity Level	<p>Used to indicate the level at which the hierarchy entity can be included in an entity hierarchy relationship. The valid values are:</p> <ul style="list-style-type: none"> • Level 1 • Level 2 • Level 3 • Level 4 • Level 5 • Level 6 • Level 7 • Level 8 • Level 9 <p>Note: At present, the system supports maximum 10 levels in an entity hierarchy relationship. Therefore, you can define hierarchy entities for upto 9 levels (i.e. Level 1, Level 2,, Level 9). The last level (i.e. Level 10) is reserved for a price item that you want to include in an entity hierarchy relationship. If you do not require 10 levels in an entity hierarchy relationship, you can set a lower maximum limit in the Maximum Hierarchy Level option type of the C1-EHRCONFIG feature configuration. However, note that the system will allow you to create a hierarchy entity upto one level less than the level specified in the Maximum Hierarchy Level option type. For example, if you set the value of the Maximum Hierarchy Level option type to 5, the system allows you to create hierarchy entities for upto four levels (i.e. Level 1, Level 2, Level 3, and Level 4). The last level (i.e. Level 5) is reserved for a price item that you want to include in an entity hierarchy relationship. Therefore, you need to accordingly set the value as per the business requirements. In such case, the system will list only the first four levels in the Entity Level field.</p>	Yes
Status	Indicates the status of the hierarchy entity. By default, the value is set to Active .	Not applicable
Business Object	Indicates the business object using which you are defining the hierarchy entity.	Not applicable

Field Name	Field Description	Mandatory (Yes or No)
Sort Sequence	Used to specify the sequence in which the hierarchy entity should appear in the price item hierarchy of the deal management module.	No

- Enter the required details in the **Main** section.
- Associate the hierarchy entity with one or more divisions in the **Division** section.
- Define characteristics for the hierarchy entity in the **Characteristics** section, if required.
- Click **Save**.

The hierarchy entity is defined.

Related Topics

For more information on...	See...
Hierarchy Entity screen	Hierarchy Entity (Used for Searching) on page 322
How to associate a hierarchy entity with a division	Associating a Hierarchy Entity with a Division on page 327
How to define a characteristic for a hierarchy entity	Defining a Characteristic for a Hierarchy Entity on page 328
How to set the C1-EHRCONFIG feature configuration	Setting the C1-EHRCONFIG Feature Configuration on page 4316

Associating a Hierarchy Entity with a Division

Note: This topic is not applicable for the health insurance business.

Prerequisites

To associate a hierarchy entity with a division, you should have:

- Divisions defined in the application

Procedure

To associate a hierarchy entity with a division:

- Ensure that the **Divisions** section is expanded when you are defining, editing, or copying a hierarchy entity.

The **Divisions** section contains the following fields in a grid:

Field Name	Field Description	Mandatory (Yes or No)
Effective Date	Used to specify the date from when you want to associate the hierarchy entity with the division.	Yes
Division	Used to indicate the division to which you want to associate the hierarchy entity.	Yes
	Note: You can only view those divisions to which you have access in the Division list.	

- Enter the required details in the **Divisions** section.

Note: You cannot change the details of a division when the hierarchy entity is included in an entity hierarchy relationship which is created for the division.

- If you want to associate the hierarchy entity with more than one division, click the **Add (+)** icon and then repeat step 2.

Note: If you want to remove the hierarchy entity from a division, click the **Delete** (🗑️) icon corresponding to the division. However, note that you cannot remove a hierarchy entity from a division when the hierarchy entity is included in an entity hierarchy relationship which is created for the division.

- Click **Save**.

The hierarchy entity is associated with the division.

Related Topics

For more information on...	See...
How to define a hierarchy entity	Defining a Hierarchy Entity on page 325
How to edit a hierarchy entity	Editing a Hierarchy Entity on page 331
How to copy a hierarchy entity	Copying a Hierarchy Entity on page 334

Defining a Characteristic for a Hierarchy Entity

Note: This topic is not applicable for the health insurance business.

Prerequisites

To define a characteristic for a hierarchy entity, you should have:

- Characteristic types defined in the application (where the characteristic entity is set to **Hierarchy Entity**)

Procedure

To define a characteristic for a hierarchy entity:

- Ensure that the **Characteristics** section is expanded when you are defining, editing, or copying a hierarchy entity.

The **Characteristics** section contains the following fields in a grid:

Field Name	Field Description	Mandatory (Yes or No)
Effective Date	Used to specify the date from when the characteristic is effective for the hierarchy entity.	Yes (Conditional)
		Note: This field is required when you are defining a characteristic for the hierarchy entity.
Characteristic Type	Used to indicate the characteristic type. Note: The list includes only those characteristic types where the characteristic entity is set to Hierarchy Entity .	Yes (Conditional)
		Note: This field is required when you are defining a characteristic for the hierarchy entity.
Characteristic Value	Used to specify the value for the characteristic type.	Yes (Conditional)

Field Name	Field Description	Mandatory (Yes or No)
	<p>Note:</p> <p>If you select a predefined characteristic type, the Search (🔍) icon appears corresponding to the Characteristic Value field. On clicking the Search icon, the Predefined Characteristic Search window appears.</p> <p>On specifying the value for a predefined characteristic type, the description of the characteristic value appears corresponding to the Characteristic Value field.</p>	<p>Note: This field is required when you are defining a characteristic for the hierarchy entity.</p>

- Enter the required details in the **Characteristics** section.
- If you want to define more than one characteristic for the hierarchy entity, click the **Add** (+) icon and then repeat step 2.

Note: However, if you want to remove a characteristic from the hierarchy entity, click the **Delete** (🗑️) icon corresponding to the characteristic.

- Click **Save**.

The characteristic is defined for the hierarchy entity.

Related Topics

For more information on...	See...
How to define a hierarchy entity	Defining a Hierarchy Entity on page 325
How to edit a hierarchy entity	Editing a Hierarchy Entity on page 331
How to copy a hierarchy entity	Copying a Hierarchy Entity on page 334

Hierarchy Entity (Used for Viewing)

Note: This topic is not applicable for the health insurance business.

The **Hierarchy Entity** screen allows you to view the details of the hierarchy entity. It also allows you to edit, delete, and copy the hierarchy entity. It contains the following zone:

- [Hierarchy Entity](#) on page 329

Hierarchy Entity

Note: This topic is not applicable for the health insurance business.

The **Hierarchy Entity** zone displays the details of the hierarchy entity. It contains the following sections:

- Main** - Displays basic information about the hierarchy entity. It contains the following fields:

Field Name	Field Description
Hierarchy Entity	Displays the hierarchy entity.
Description	Displays the description of the hierarchy entity.

Field Name	Field Description
Entity Level	Indicates the level at which the hierarchy entity can be included in an entity hierarchy relationship. The valid values are: <ul style="list-style-type: none"> • Level 1 • Level 2 • Level 3 • Level 4 • Level 5 • Level 6 • Level 7 • Level 8 • Level 9
Status	Indicates the status of the hierarchy entity. The valid values are: <ul style="list-style-type: none"> • Active • Inactive
Sort Sequence	Displays the sequence in which the hierarchy entity appears in a particular hierarchy entity level.

- **Divisions** - Lists the divisions to which the hierarchy entity is associated. It contains the following columns:

Column Name	Column Description
Effective Date	Displays the date from when the hierarchy entity is associated with the division.
Division	Indicates the division to which the hierarchy entity is associated. Note: It has a link. On clicking the link, the Division screen appears where you can view the details of the respective division.

- **Characteristics** - Lists the characteristics defined for the hierarchy entity. It contains the following columns:

Column Name	Column Description
Effective Date	Displays the date from when the characteristic is effective for the hierarchy entity.
Characteristic Type	Displays the characteristic type.
Characteristic Value	Displays the value of the characteristic type.

- **Record Actions** - The **Record Actions** section contains the following buttons:

Button Name	Button Description
Edit	Used to edit the details of the hierarchy entity.
Delete	Used to delete the hierarchy entity. Note: You can delete a hierarchy entity only when it is not yet included in any entity hierarchy relationship.

Button Name	Button Description
Duplicate	Used to create a new hierarchy entity using an existing hierarchy entity.

- **Record Information** - The **Record Information** section contains the following field:

Field Name	Field Description
Business Object	Indicates the business object using which the hierarchy entity is created in the system. In addition, a context menu appears corresponding to this field which helps in navigating to other screens in the application.
	Note: It has a link. On clicking the link, the Business Object screen appears where you can view the details of the respective business object.

Related Topics

For more information on...	See...
How to associate a hierarchy entity with a division	Associating a Hierarchy Entity with a Division on page 327
How to define a characteristic for a hierarchy entity	Defining a Characteristic for a Hierarchy Entity on page 328
How to edit a hierarchy entity	Editing a Hierarchy Entity on page 331
How to delete a hierarchy entity	Deleting a Hierarchy Entity on page 333
How to copy a hierarchy entity	Copying a Hierarchy Entity on page 334

Editing a Hierarchy Entity

Note: This topic is not applicable for the health insurance business.

Prerequisites

To edit a hierarchy entity, you should have:

- Value defined for the **Maximum Hierarchy Level** option type in the **C1-EHRCONFIG** feature configuration

Procedure

To edit a hierarchy entity:

1. Search for the hierarchy entity in the **Hierarchy Entity** screen.
2. In the **Search Results** section, click the link in the **Hierarchy Entity Information** column corresponding to the hierarchy entity whose details you want to edit.

The **Hierarchy Entity** screen appears.

3. Click the **Edit** button in the **Hierarchy Entity** zone.

The **Hierarchy Entity** screen appears. It contains the following sections:

- **Main** - Used to specify basic details about the hierarchy entity.
- **Divisions** - Used to associate the hierarchy entity with one or more divisions.
- **Characteristics** - Used to define the characteristics for the hierarchy entity.

The **Main** section contains the following fields:

Field Name	Field Description	Mandatory (Yes or No)
Hierarchy Entity	Displays the hierarchy entity.	Not applicable
Description	Used to specify the description for the hierarchy entity.	Yes
Entity Level	<p>Used to indicate the level at which the hierarchy entity can be included in an entity hierarchy relationship. The valid values are:</p> <ul style="list-style-type: none"> • Level 1 • Level 2 • Level 3 • Level 4 • Level 5 • Level 6 • Level 7 • Level 8 • Level 9 <p>Note:</p> <p>At present, the system supports maximum 10 levels in an entity hierarchy relationship. Therefore, you can define hierarchy entities for upto 9 levels (i.e. Level 1, Level 2, ..., Level 9). The last level (i.e. Level 10) is reserved for a price item that you want to include in an entity hierarchy relationship. If you do not require 10 levels in an entity hierarchy relationship, you can set a lower maximum limit in the Maximum Hierarchy Level option type of the C1-EHRCONFIG feature configuration. However, note that the system will allow you to create a hierarchy entity upto one level less than the level specified in the Maximum Hierarchy Level option type. For example, if you set the value of the Maximum Hierarchy Level option type to 5, the system allows you to create hierarchy entities for upto four levels (i.e. Level 1, Level 2, Level 3, and Level 4). The last level (i.e. Level 5) is reserved for a price item that you want to include in an entity hierarchy relationship. Therefore, you need to accordingly set the value as per the business requirements. In such case, the system will list only the first four levels in the Entity Level field.</p> <p>You cannot change the entity level of a hierarchy entity when the hierarchy entity is already included in an entity hierarchy relationship.</p>	Yes

Field Name	Field Description	Mandatory (Yes or No)
Status	Used to indicate the status of the hierarchy entity. The valid values are: <ul style="list-style-type: none"> Active Inactive 	Yes
	Note: You cannot inactivate a hierarchy entity when the hierarchy entity is already included in an entity hierarchy relationship.	
Business Object	Indicates the business object which is used while defining the hierarchy entity.	Not applicable
Sort Sequence	Used to specify the sequence in which the hierarchy entity should appear in the price item hierarchy of the deal management module.	No

4. Modify the required details in the **Main** section.
5. Associate or disassociate the hierarchy entity from the divisions, if required.

Note: If the hierarchy entity is associated to a division to which you do not have access, then the corresponding row in the **Divisions** section is grayed out.

6. Define, edit, or remove characteristics from the hierarchy entity, if required.
7. Click **Save**.

The changes made to the hierarchy entity are saved.

Related Topics

For more information on...	See...
Hierarchy Entity screen	Hierarchy Entity (Used for Searching) on page 322
Hierarchy Entity screen	Hierarchy Entity (Used for Viewing) on page 329
How to search for a hierarchy entity	Searching for a Hierarchy Entity on page 324
How to associate a hierarchy entity with a division	Associating a Hierarchy Entity with a Division on page 327
How to define a characteristic for a hierarchy entity	Defining a Characteristic for a Hierarchy Entity on page 328
How to set the C1-EHRCONFIG feature configuration	Setting the C1-EHRCONFIG Feature Configuration on page 4316

Deleting a Hierarchy Entity

Note: This topic is not applicable for the health insurance business.

Procedure

To delete a hierarchy entity:

1. Search for the hierarchy entity in the **Hierarchy Entity** screen.
2. In the **Search Results** section, click the link in the **Hierarchy Entity Information** column corresponding to the hierarchy entity that you want to delete.

The **Hierarchy Entity** screen appears.

- Click the **Delete** button in the **Hierarchy Entity** zone.

A message appears confirming whether you want to delete the hierarchy entity.

Note: You can delete a hierarchy entity only when it is not yet included in any entity hierarchy relationship.

- Click **OK**.

The hierarchy entity is deleted.

Related Topics

For more information on...	See...
How to search for a hierarchy entity	Searching for a Hierarchy Entity on page 324
Hierarchy Entity screen	Hierarchy Entity (Used for Searching) on page 322
Hierarchy Entity screen	Hierarchy Entity (Used for Viewing) on page 329
Hierarchy Entity zone	Hierarchy Entity on page 329

Copying a Hierarchy Entity

Note: This topic is not applicable for the health insurance business.

Instead of creating a hierarchy entity from scratch, you can create a new hierarchy entity using an existing hierarchy entity. This is possible through copying a hierarchy entity. On copying a hierarchy entity, the details including the divisions and characteristics are also copied to the new hierarchy entity. You can then edit the details, if required.

Prerequisites

To copy a hierarchy entity, you should have:

- Hierarchy entity (whose copy you want to create) defined in the application
- Value defined for the **Maximum Hierarchy Level** option type in the **C1-EHRCONFIG** feature configuration

Procedure

To copy a hierarchy entity:

- Search for the hierarchy entity in the **Hierarchy Entity** screen.
- In the **Search Results** section, click the link in the **Hierarchy Entity Information** column corresponding to the hierarchy entity whose copy you want to create.

The **Hierarchy Entity** screen appears.

- Click the **Duplicate** button in the **Hierarchy Entity** zone.

The **Hierarchy Entity** screen appears. It contains the following sections:

- Main** - Used to specify basic details about the hierarchy entity.
- Divisions** - Used to associate the hierarchy entity with one or more divisions.
- Characteristics** - Used to define the characteristics for the hierarchy entity.

The **Main** section contains the following fields:

Field Name	Field Description	Mandatory (Yes or No)
Hierarchy Entity	Used to specify the hierarchy entity.	Yes

Field Name	Field Description	Mandatory (Yes or No)
Description	Used to specify the description for the hierarchy entity.	Yes
Entity Level	<p>Used to indicate the level at which the hierarchy entity can be included in an entity hierarchy relationship. The valid values are:</p> <ul style="list-style-type: none"> • Level 1 • Level 2 • Level 3 • Level 4 • Level 5 • Level 6 • Level 7 • Level 8 • Level 9 <p>Note: At present, the system supports maximum 10 levels in an entity hierarchy relationship. Therefore, you can define hierarchy entities for upto 9 levels (i.e. Level 1, Level 2,, Level 9). The last level (i.e. Level 10) is reserved for a price item that you want to include in an entity hierarchy relationship. If you do not require 10 levels in an entity hierarchy relationship, you can set a lower maximum limit in the Maximum Hierarchy Level option type of the C1-EHRCONFIG feature configuration. However, note that the system will allow you to create a hierarchy entity upto one level less than the level specified in the Maximum Hierarchy Level option type. For example, if you set the value of the Maximum Hierarchy Level option type to 5, the system allows you to create hierarchy entities for upto four levels (i.e. Level 1, Level 2, Level 3, and Level 4). The last level (i.e. Level 5) is reserved for a price item that you want to include in an entity hierarchy relationship. Therefore, you need to accordingly set the value as per the business requirements. In such case, the system will list only the first four levels in the Entity Level field.</p>	Yes
Status	Indicates the status of the hierarchy entity. By default, the value is set to Active .	Not applicable
Business Object	Indicates the business object which is used while defining the hierarchy entity.	Not applicable

Field Name	Field Description	Mandatory (Yes or No)
Sort Sequence	Used to specify the sequence in which the hierarchy entity should appear in the price item hierarchy of the deal management module.	No

- Enter the required details in the **Main** section.
- Associate or disassociate the hierarchy entity from the divisions, if required.

Note: If the hierarchy entity is associated to a division to which you do not have access, then the corresponding row in the **Divisions** section is grayed out.

- Define, edit, or remove characteristics of the hierarchy entity, if required.
- Click **Save**.

The new hierarchy entity is defined.

Related Topics

For more information on...	See...
How to search for a hierarchy entity	Searching for a Hierarchy Entity on page 324
Hierarchy Entity screen	Hierarchy Entity (Used for Searching) on page 322
Hierarchy Entity screen	Hierarchy Entity (Used for Viewing) on page 329
Hierarchy Entity zone	Hierarchy Entity on page 329
How to associate a hierarchy entity with a division	Associating a Hierarchy Entity with a Division on page 327
How to define a characteristic for a hierarchy entity	Defining a Characteristic for a Hierarchy Entity on page 328
How to set the C1-EHRCONFIG feature configuration	Setting the C1-EHRCONFIG Feature Configuration on page 4316

Entity Hierarchy Relationship (Used for Searching)

Note: This topic is not applicable for the health insurance business.

The **Entity Hierarchy Relationship** screen allows you to search for an entity hierarchy relationship using various search criteria. It also allows you to define an entity hierarchy relationship. It contains the following zone:

- [Search Hierarchy](#) on page 336

Through this screen, you can navigate to the following screen:

- [Entity Hierarchy Relationship \(Used for Viewing\)](#) on page 344

Search Hierarchy

Note: This topic is not applicable for the health insurance business.

The **Search Hierarchy** zone allows you to search for an entity hierarchy relationship using various search criteria. It contains the following two sections:

- Search Criteria** - The **Search Criteria** section contains the following fields:

Field Name	Field Description	Mandatory (Yes or No)
Hierarchy	Used to search a particular entity hierarchy relationship.	No
Start Date	Used to search entity hierarchy relationships which are effective from a particular date onwards.	No
Division	Used to search entity hierarchy relationships which are created for a particular division.	No
End Date	Used to search entity hierarchy relationships which are effective till a particular date.	No
Description	Used to search entity hierarchy relationships having a particular description.	No

Note: You must specify at least one search criterion while searching for an entity hierarchy relationship.

- **Search Results** - On clicking the **Search** button, the search results appear based on the specified search criteria. The **Search Results** section contains the following columns:

Column Name	Column Description
Hierarchy Information	Displays information about the entity hierarchy relationship.
	Note: It has a link. On clicking the link, the Entity Hierarchy Relationship screen appears where you can view the details of the respective entity hierarchy relationship.
Division	Indicates the division for which the entity hierarchy relationship is created.
Start Date	Displays the date from when the entity hierarchy relationship is effective for the division.
End Date	Displays the date till when the entity hierarchy relationship is effective for the division.

Note: Pagination is used to display limited number of records in the **Search Results** section. You can use the navigation links, such as **Previous** and **Next** to navigate between pages.

Related Topics

For more information on...	See...
How to search for an entity hierarchy relationship	Searching for an Entity Hierarchy Relationship on page 337
How to view the details of an entity hierarchy relationship	Viewing the Entity Hierarchy Relationship Details on page 343

Searching for an Entity Hierarchy Relationship

Note: This topic is not applicable for the health insurance business.

Prerequisites

To search for an entity hierarchy relationship, you should have:

- Divisions defined in the application

Procedure

To search for an entity hierarchy relationship:

1. Click the **Menu** link in the **Application** toolbar.
A list appears.
2. From the **Main** menu, select **Pricing Management** and then click **Entity Hierarchy Relationship**.
A sub-menu appears.
3. Click the **Search** option from the **Entity Hierarchy Relationship** sub-menu.
The **Entity Hierarchy Relationship** screen appears.
4. Enter the search criteria in the **Search Hierarchy** zone.

Note: ORMB search engine supports wildcard search, where you can substitute the percentage (%) symbol as a stand in for any word or letter in a search criteria. You can use the ‘%’ wildcard character in all input fields except the date and ID fields. The ‘%’ wildcard character is suffixed automatically at the end of the partial search criteria. Therefore, you may or may not specify the wildcard character at the end of the partial search criteria. However, you have to prefix the wildcard character manually wherever required.

5. Click **Search**.

A list of entity hierarchy relationships that meet the search criteria appears in the **Search Results** section.

Related Topics

For more information on...	See...
Entity Hierarchy Relationship screen	Entity Hierarchy Relationship (Used for Searching) on page 336
Search Hierarchy zone	Search Hierarchy on page 336

Defining an Entity Hierarchy Relationship

Note: This topic is not applicable for the health insurance business.

Prerequisites

To define an entity hierarchy relationship, you should have:

- Hierarchy entities defined in the application
- Hierarchy entities associated with the division for which you want to create an entity hierarchy relationship
- Value defined for the **Maximum Hierarchy Level** option type in the **C1-EHRCONFIG** feature configuration

Procedure

To define an entity hierarchy relationship:

1. Click the **Menu** link in the **Application** toolbar.
A list appears.
2. From the **Main** menu, select **Pricing Management** and then click **Entity Hierarchy Relationship**.
A sub-menu appears.
3. Click the **Add** option from the **Entity Hierarchy Relationship** sub-menu.
The **Select Business Object** screen appears. It contains the following field:

Field Name	Field Description	Mandatory (Yes or No)
Entity Hierarchy Relationship Business Object	Used to indicate the business object using which you want to create the entity hierarchy relationship.	Yes

Tip: Alternatively, you can access the **Select Business Object** screen by clicking the **Add** button in the **Page Title** area of the **Entity Hierarchy Relationship** screen.

Note: The **Select Business Object** screen appears when there are multiple entity hierarchy relationship business objects defined in the application. If there is only one entity hierarchy relationship business object defined in the application, the **Entity Hierarchy Relationship** screen appears.

4. Select the required entity hierarchy relationship business object from the respective field.
5. Click **OK**.

The **Entity Hierarchy Relationship** screen appears. It contains the following sections:

- **Main** - Used to specify basic details about the entity hierarchy relationship. It contains the following fields:

Field Name	Field Description	Mandatory (Yes or No)
Hierarchy	Used to specify the entity hierarchy relationship.	Yes
Description	Used to specify the description for the entity hierarchy relationship.	Yes
Division	Used to indicate the division for which you want to create the entity hierarchy relationship.	Yes
Start Date	Used to specify the date from when the entity hierarchy relationship is effective for the division.	Yes
	Note: The entity hierarchy relationship start date cannot be later than the entity hierarchy relationship end date.	
End Date	Used to specify the date till when the entity hierarchy relationship is effective for the division.	No
	Note: The entity hierarchy relationship end date cannot be earlier than the entity hierarchy relationship start date.	
Entity Level	Indicates the level at which you want to include the hierarchy entity. By default, the value is set to Level 1 .	Not applicable
Hierarchy Entity	Used to indicate the hierarchy entity that you want to include at the first level in the entity hierarchy relationship.	Yes

Field Name	Field Description	Mandatory (Yes or No)
	<p>Note:</p> <p>The Search (🔍) icon appears corresponding to the Hierarchy Entity field. On clicking the Search icon, the Hierarchy Entity Child Search window appears where you can search for the respective hierarchy entity.</p> <p>The search results appear in the Hierarchy Entity Child Search window only when the division and start date is specified for the entity hierarchy relationship.</p> <p>The list includes only those hierarchy entities:</p> <ul style="list-style-type: none"> • Which can be included at the first level in the entity hierarchy relationship • Which are effective for the specified division on the entity hierarchy relationship start date 	
Business Object	Indicates the business object using which you are defining the entity hierarchy relationship.	Not applicable

- **Hierarchy Details** - Used to design the entity hierarchy relationship structure (i.e. specify the child and parent hierarchy entities for each level (i.e. Level 2, Level 3, Level 4,, Level 9)). It contains the following fields in a grid:

Field Name	Field Description	Mandatory (Yes or No)
Entity Level	<p>Used to indicate the subsequent level at which you want to include the hierarchy entity. The valid values are:</p> <ul style="list-style-type: none"> • Level 2 • Level 3 • Level 4 • Level 5 • Level 6 • Level 7 • Level 8 • Level 9 	Yes

Field Name	Field Description	Mandatory (Yes or No)
	<p>Note: The levels listed in this field vary depending on the value specified in Maximum Hierarchy Level option type of the C1-EHRCONFIG feature configuration. For example, if the Maximum Hierarchy Level option type is set to 5, the system will list only three levels (i.e. Level 2, Level 3, and Level 4) in the Entity Level field. However, if the Maximum Hierarchy Level option type is set to 10, the system will list only eight levels (i.e. Level 2, Level 3, Level 4, Level 5, Level 6, Level 7, Level 8, and Level 9) in the Entity Level field.</p>	
Hierarchy Entity	<p>Used to indicate the hierarchy entity that you want to include at the specified level (for example, Level 2) in the entity hierarchy relationship.</p> <p>Note: This field is enabled when you select the entity level from the respective field. The list appears only when the division and start date is specified for the entity hierarchy relationship. The list includes only those hierarchy entities:</p> <ul style="list-style-type: none"> • Which can be included at the specified level in the entity hierarchy relationship • Which are effective for the specified division on the entity hierarchy relationship start date 	Yes
Parent Hierarchy Entity	Used to indicate the parent hierarchy entity.	Yes

Field Name	Field Description	Mandatory (Yes or No)
	<p>Note:</p> <p>This field is enabled when you select the entity level from the respective field.</p> <p>The list appears when the division and start date is specified for the entity hierarchy relationship.</p> <p>The list includes only those hierarchy entities:</p> <ul style="list-style-type: none"> • Which can be included at the specified level minus one level in the entity hierarchy relationship • Which are effective for the specified division on the entity hierarchy relationship start date <p>For example, if you specify the hierarchy entity for Level 2, the system will list hierarchy entities which can be included at the first level in the Parent Hierarchy Entity field. And, if you specify the hierarchy entity for Level 5, the system will list hierarchy entities which can be included at the fourth level in the Parent Hierarchy Entity field. Here, note that you must select the hierarchy entity which is already included in the entity hierarchy relationship.</p>	
Start Date	<p>Used to specify the date from when the hierarchy entity is associated in the entity hierarchy relationship at the specified entity level.</p> <p>Note: The Start Date cannot be later than the End Date.</p>	Yes
End Date	<p>Used to specify the date till when the hierarchy entity is associated in the entity hierarchy relationship at the specified entity level.</p> <p>Note: The End Date cannot be earlier than the Start Date.</p>	No
Price Items	<p>Used to associate price items with the hierarchy entity at the specified entity level of the entity hierarchy relationship.</p>	No

6. Enter the required details in the **Main** section.
7. Enter the hierarchy entity and its parent hierarchy entity for the subsequent levels in the **Hierarchy Details** section.

Note: You can include multiple hierarchy entities at the same level. But, you need to ensure that the parent hierarchy entity for such parallel levels is same.

8. If you want to add more than two levels in the entity hierarchy relationship, click the **Add (+)** icon and then repeat step 7.

Note: However, if you want to remove an entity level from the entity hierarchy relationship, click the **Delete** (🗑️) icon corresponding to the entity level.

9. Associate price items or price item bundles with the hierarchy entity for the subsequent levels in the **Hierarchy Details** section, if required.

10. Click **Save**.

The entity hierarchy relationship is defined.

Note: You cannot define multiple entity hierarchy relationships for a division with the same entity hierarchy relationship start date.

Related Topics

For more information on...	See...
Entity Hierarchy Relationship screen	Entity Hierarchy Relationship (Used for Searching) on page 336
How to associate a price item or price item bundle with a hierarchy entity in an entity hierarchy relationship	Associating a Price Item or Price Item Bundle with a Hierarchy Entity in an Entity Hierarchy Relationship

Viewing the Entity Hierarchy Relationship Details

Note: This topic is not applicable for the health insurance business.

Procedure

To view the details of an entity hierarchy relationship:

1. Search for the entity hierarchy relationship in the **Entity Hierarchy Relationship** screen.
2. In the **Search Results** section, click the link in the **Hierarchy Information** column corresponding to the entity hierarchy relationship whose details you want to view.

The **Entity Hierarchy Relationship** screen appears. It contains the following zones:

- [Hierarchy](#) on page 344
- [Hierarchy Relationship Tree](#) on page 345

3. View the basic details of the entity hierarchy relationship in the **Hierarchy** zone.
4. View the structure of the entity hierarchy relationship (i.e. how the hierarchy entities are included at different levels) in the **Hierarchy Relationship Tree** zone.

Related Topics

For more information on...	See...
How to search for an entity hierarchy relationship	Searching for an Entity Hierarchy Relationship on page 337
Entity Hierarchy Relationship screen	Entity Hierarchy Relationship (Used for Viewing) on page 344

Entity Hierarchy Relationship (Used for Viewing)

Note: This topic is not applicable for the health insurance business.

The **Entity Hierarchy Relationship** screen allows you to view the details of the entity hierarchy relationship. It also allows you to edit, delete, and copy the entity hierarchy relationship. It contains the following zones:

- [Hierarchy](#) on page 344
- [Hierarchy Relationship Tree](#) on page 345

Hierarchy

Note: This topic is not applicable for the health insurance business.

The **Hierarchy** zone displays the details of the entity hierarchy relationship. It contains the following sections:

- **Main** - Displays basic information about the entity hierarchy relationship. It contains the following fields:

Field Name	Field Description
Hierarchy	Displays the entity hierarchy relationship code.
Description	Displays the description of the entity hierarchy relationship.
Division	Indicates the division for which the entity hierarchy relationship is created. Note: It has a link. On clicking the link, the Division screen appears where you can view the details of the respective division.
Hierarchy Entity	Indicates the hierarchy entity that is included at the first level in the entity hierarchy relationship.
Start Date	Displays the date from when the entity hierarchy relationship is effective for the division.
End Date	Displays the date till when the entity hierarchy relationship is effective for the division.

- **Record Actions** - This section contains the following buttons:

Button Name	Button Description
Edit	Used to edit the details of the entity hierarchy relationship.
Delete	Used to delete the entity hierarchy relationship. Note: You can delete an entity hierarchy relationship when price items are not yet associated with a hierarchy entity at any level in the entity hierarchy relationship.
Duplicate	Used to define a new entity hierarchy relationship using an existing entity hierarchy relationship.

- **Record Information** - This section contains the following field:

Field Name	Field Description
Business Object	Indicates the business object using which the entity hierarchy relationship is created. In addition, a context menu appears corresponding to this field which helps in navigating to other screens in the application.

Field Name	Field Description
	Note: It has a link. On clicking the link, the Business Object screen appears where you can view the details of the respective business object.

Related Topics

For more information on...	See...
How to edit an entity hierarchy relationship	Editing an Entity Hierarchy Relationship on page 346
How to delete an entity hierarchy relationship	Deleting an Entity Hierarchy Relationship on page 351
How to copy an entity hierarchy relationship	Copying an Entity Hierarchy Relationship on page 352

Hierarchy Relationship Tree

Note: This topic is not applicable for the health insurance business.

The **Hierarchy Relationship Tree** zone lists the following in a tree structure:

- Information string of the hierarchy entity at the first level in the entity hierarchy relationship
- Information string of the hierarchy entities at the subsequent levels in the entity hierarchy relationship
- Information string of the price items which are associated with the hierarchy entities at different levels in the entity hierarchy relationship

For example,

- ▲ [Cash Management, US](#)
 - ▲ [Payments, US](#)
 - [ACH Payment](#)
 - [ACH Return](#)
 - [ACH Reversal](#)
 - ▲ [Statements, US](#)
 - [Mini Statement](#)
 - [Yearly Statement](#)

The following table indicates the node type of each node shown in the above example:

Node	Node Type
Cash Management, US (at the first level)	Hierarchy Entity
Payments, US (at the second level)	Hierarchy Entity
ACH Payment	Price Item
ACH Return	Price Item
ACH Reversal	Price Item
Statements, US (at the second level)	Hierarchy Entity

Node	Node Type
Mini Statement	Price Item
Yearly Statement	Price Item

Each node in the tree has a link. If you click the link on the hierarchy entity node, the **Hierarchy Entity** screen appears where you can view the details of the respective hierarchy entity. However, if you click the link on the price item node, the **Price Item** screen appears where you can view the details of the respective price item.

It contains the following field:

Field Name	Field Description
Hierarchy	Displays the entity hierarchy relationship code.

In addition, it contains the following buttons:

Button Name	Button Description
Expand All	Used to expand all nodes at once in the entity hierarchy relationship.
Collapse All	Used to collapse all nodes at once in the entity hierarchy relationship.

Note: The hierarchy entities and price items are sorted in the **Hierarchy Relationship Tree** zone based on their respective sort sequence. If two or more hierarchy entities and price items have the same sort sequence, then the system sorts them in the ascending alphabetical order of the information string. Also, if the sort sequence is not defined for the hierarchy entities and price items, then the system sorts them in the ascending alphabetical order of the information string.

Editing an Entity Hierarchy Relationship

Note: This topic is not applicable for the health insurance business.

Prerequisites

To edit an entity hierarchy relationship, you should have:

- Hierarchy entities defined in the application
- Hierarchy entities associated with the division whose entity hierarchy relationship you want to edit
- Value defined for the **Maximum Hierarchy Level** option type in the **C1-EHRCONFIG** feature configuration

Procedure

To edit an entity hierarchy relationship:

1. Search for the entity hierarchy relationship in the **Entity Hierarchy Relationship** screen.
2. In the **Search Results** section, click the link in the **Hierarchy Information** column corresponding to the entity hierarchy relationship whose details you want to edit.

The **Entity Hierarchy Relationship** screen appears.

3. Click the **Edit** button in the **Hierarchy** zone.

The **Entity Hierarchy Relationship** screen appears. It contains the following sections:

- **Main** - Used to specify basic details about the entity hierarchy relationship. It contains the following fields:

Field Name	Field Description	Mandatory (Yes or No)
Hierarchy	Displays the entity hierarchy relationship code.	Not applicable
Description	Used to specify the description for the entity hierarchy relationship.	Yes
Division	Used to indicate the division for which you want to create the entity hierarchy relationship. Note: This field is editable only when price items are not yet associated with the hierarchy entity at any level in the entity hierarchy relationship.	Yes
Start Date	Used to specify the date from when the entity hierarchy relationship is effective for the division. Note: This field is editable only when price items are not yet associated with the hierarchy entity at any level in the entity hierarchy relationship. The entity hierarchy relationship start date cannot be later than the entity hierarchy relationship end date.	Yes
End Date	Used to specify the date till when the entity hierarchy relationship is effective for the division. Note: The entity hierarchy relationship end date cannot be earlier than the entity hierarchy relationship start date.	No
Entity Level	Indicates the level at which you want to include the hierarchy entity. By default, the value is set to Level 1 .	Not applicable
Hierarchy Entity	Used to indicate the hierarchy entity that you want to include at the first level in the entity hierarchy relationship.	Yes

Field Name	Field Description	Mandatory (Yes or No)
	<p>Note:</p> <p>The list appears when the division and start date is specified for the entity hierarchy relationship.</p> <p>The list includes only those hierarchy entities:</p> <ul style="list-style-type: none"> • Which can be included at the first level in the entity hierarchy relationship • Which are effective for the specified division on the entity hierarchy relationship start date <p>You cannot change the hierarchy entity at the first level because a price item is associated with a hierarchy entity either at the first or subsequent level in the entity hierarchy relationship.</p>	
Business Object	Indicates the business object which is used while defining the entity hierarchy relationship.	Not applicable

- **Hierarchy Details** - Used to design the entity hierarchy relationship structure (i.e. specify the child and parent hierarchy entities for each level (i.e. Level 2, Level 3, Level 4,, Level 9)). It contains the following fields in a grid:

Field Name	Field Description	Mandatory (Yes or No)
Entity Level	<p>Used to indicate the subsequent level at which you want to include the hierarchy entity. The valid values are:</p> <ul style="list-style-type: none"> • Level 2 • Level 3 • Level 4 • Level 5 • Level 6 • Level 7 • Level 8 • Level 9 	Yes

Field Name	Field Description	Mandatory (Yes or No)
	<p>Note: The levels listed in this field vary depending on the value specified in Maximum Hierarchy Level option type of the C1-EHRCONFIG feature configuration. For example, if the Maximum Hierarchy Level option type is set to 5, the system will list only three levels (i.e. Level 2, Level 3, and Level 4) in the Entity Level field. However, if the Maximum Hierarchy Level option type is set to 10, the system will list only eight levels (i.e. Level 2, Level 3, Level 4, Level 5, Level 6, Level 7, Level 8, and Level 9) in the Entity Level field.</p>	
Hierarchy Entity	<p>Used to indicate the hierarchy entity that you want to include at the specified level (for example, Level 2) in the entity hierarchy relationship.</p> <p>Note: This field is enabled when you select the entity level from the respective field.</p> <p>The list appears only when the division and start date is specified for the entity hierarchy relationship.</p> <p>The list includes only those hierarchy entities:</p> <ul style="list-style-type: none"> • Which can be included at the specified level in the entity hierarchy relationship • Which are effective for the specified division on the entity hierarchy relationship start date 	Yes
Parent Hierarchy Entity	Used to indicate the parent hierarchy entity.	Yes

Field Name	Field Description	Mandatory (Yes or No)
	<p>Note:</p> <p>This field is enabled when you select the entity level from the respective field.</p> <p>The list appears when the division and start date is specified for the entity hierarchy relationship.</p> <p>The list includes only those hierarchy entities:</p> <ul style="list-style-type: none"> • Which can be included at the specified level minus one level in the entity hierarchy relationship • Which are effective for the specified division on the entity hierarchy relationship start date <p>For example, if you specify the hierarchy entity for Level 2, the system will list hierarchy entities which can be included at the first level in the Parent Hierarchy Entity field. And, if you specify the hierarchy entity for Level 5, the system will list hierarchy entities which can be included at the fourth level in the Parent Hierarchy Entity field. Here, note that you must select the hierarchy entity which is already included in the entity hierarchy relationship.</p>	
Start Date	<p>Used to specify the date from when the hierarchy entity is associated in the entity hierarchy relationship at the specified entity level.</p> <p>Note: The Start Date cannot be later than the End Date.</p>	Yes
End Date	<p>Used to specify the date till when the hierarchy entity is associated in the entity hierarchy relationship at the specified entity level.</p> <p>Note: The End Date cannot be earlier than the Start Date.</p>	No
Price Items	Used to associate price items with the hierarchy entity at the specified entity level of the entity hierarchy relationship.	No

Note: You cannot delete an entity level from the entity hierarchy relationship or change the details of an entity level when a price item is associated with the hierarchy entity at the respective entity level or at any level in the vertical hierarchy of the entity hierarchy relationship.

4. Modify the required details in the **Main** section.

5. Add or remove levels from the entity hierarchy relationship, if required.

Note:

If you want to add more levels in the entity hierarchy relationship, click the **Add** (+) icon and then enter the details for the entity level. However, if you want to remove an entity level from the entity hierarchy relationship, click the **Delete** (🗑️) icon corresponding to the entity level.

You can include multiple hierarchy entities at the same level. But, you need to ensure that the parent hierarchy entity for such parallel levels is same.

6. Associate or disassociate price items or price item bundles from the hierarchy entity for the subsequent levels in the **Hierarchy Details** section, if required.
7. Click **Save**.

The changes made to the entity hierarchy relationship are saved.

Related Topics

For more information on...	See...
How to search for an entity hierarchy relationship	Searching for an Entity Hierarchy Relationship on page 337
Entity Hierarchy Relationship screen	Entity Hierarchy Relationship (Used for Viewing) on page 344
Hierarchy zone	Hierarchy on page 344
How to associate a price item or price item bundle with a hierarchy entity in an entity hierarchy relationship	Associating a Price Item or Price Item Bundle with a Hierarchy Entity in an Entity Hierarchy Relationship

Deleting an Entity Hierarchy Relationship

Note: This topic is not applicable for the health insurance business.

Procedure

To delete an entity hierarchy relationship:

1. Search for the entity hierarchy relationship in the **Entity Hierarchy Relationship** screen.
2. In the **Search Results** section, click the link in the **Hierarchy Information** column corresponding to the entity hierarchy relationship that you want to delete.

The **Entity Hierarchy Relationship** screen appears.

3. Click the **Delete** button in the **Hierarchy** zone.

A message appears confirming whether you want to delete the entity hierarchy relationship.

Note: You can delete an entity hierarchy relationship when price items are not yet associated with a hierarchy entity at any level in the entity hierarchy relationship.

4. Click **OK**.

The entity hierarchy relationship is deleted.

Related Topics

For more information on...	See...
How to search for an entity hierarchy relationship	Searching for an Entity Hierarchy Relationship on page 337
Entity Hierarchy Relationship screen	Entity Hierarchy Relationship (Used for Viewing) on page 344
Hierarchy zone	Hierarchy on page 344

Copying an Entity Hierarchy Relationship

Note: This topic is not applicable for the health insurance business.

Instead of creating an entity hierarchy relationship from scratch, you can create a new entity hierarchy relationship using an existing entity hierarchy relationship. This is possible through copying an entity hierarchy relationship. On copying an entity hierarchy relationship, the details including the entity levels are copied to the new entity hierarchy relationship. You can then edit the details, if required.

Note: On copying an entity hierarchy relationship, if a price item is associated to a hierarchy entity at any level in the entity hierarchy relationship, the price item is not copied to the new entity hierarchy relationship.

Prerequisites

To copy an entity hierarchy relationship, you should have:

- Entity hierarchy relationship (whose copy you want to create) defined in the application
- Hierarchy entities defined in the application
- Hierarchy entities associated with the division for which you want to create an entity hierarchy relationship
- Value defined for the **Maximum Hierarchy Level** option type in the **C1-EHRCONFIG** feature configuration

Procedure

To copy an entity hierarchy relationship:

1. Search for the entity hierarchy relationship in the **Entity Hierarchy Relationship** screen.
2. In the **Search Results** section, click the link in the **Hierarchy Information** column corresponding to the entity hierarchy relationship whose copy you want to create.

The **Entity Hierarchy Relationship** screen appears.

3. Click the **Duplicate** button in the **Hierarchy** zone.

The **Entity Hierarchy Relationship** screen appears. It contains the following sections:

- **Main** - Used to specify basic details about the entity hierarchy relationship. It contains the following fields:

Field Name	Field Description	Mandatory (Yes or No)
Hierarchy	Used to specify the entity hierarchy relationship code.	Yes
Description	Used to specify the description for the entity hierarchy relationship.	Yes
Division	Used to indicate the division for which you want to create the entity hierarchy relationship.	Yes

Field Name	Field Description	Mandatory (Yes or No)
Start Date	Used to specify the date from when the entity hierarchy relationship is effective for the division.	Yes
	Note: The entity hierarchy relationship start date cannot be later than the entity hierarchy relationship end date.	
End Date	Used to specify the date till when the entity hierarchy relationship is effective for the division.	No
	Note: The entity hierarchy relationship end date cannot be earlier than the entity hierarchy relationship start date.	
Entity Level	Indicates the level at which you want to include the hierarchy entity. By default, the value is set to Level 1 .	Not applicable
Hierarchy Entity	Used to indicate the hierarchy entity that you want to include at the first level in the entity hierarchy relationship.	Yes
	Note: The list appears when the division and start date is specified for the entity hierarchy relationship. The list includes only those hierarchy entities: <ul style="list-style-type: none"> • Which can be included at the first level in the entity hierarchy relationship • Which are effective for the specified division on the entity hierarchy relationship start date 	
Business Object	Indicates the business object using which you are defining the entity hierarchy relationship.	Not applicable

- **Hierarchy Details** - Used to design the entity hierarchy relationship structure (i.e. specify the child and parent hierarchy entities for each level (i.e. Level 2, Level 3, Level 4,, Level 9)). It contains the following fields in a grid:

Field Name	Field Description	Mandatory (Yes or No)
Entity Level	Used to indicate the subsequent level at which you want to include the hierarchy entity. The valid values are: <ul style="list-style-type: none"> • Level 2 • Level 3 	Yes

Field Name	Field Description	Mandatory (Yes or No)
	<ul style="list-style-type: none"> • Level 4 • Level 5 • Level 6 • Level 7 • Level 8 • Level 9 <p>Note: The levels listed in this field vary depending on the value specified in Maximum Hierarchy Level option type of the C1-EHRCONFIG feature configuration. For example, if the Maximum Hierarchy Level option type is set to 5, the system will list only three levels (i.e. Level 2, Level 3, and Level 4) in the Entity Level field. However, if the Maximum Hierarchy Level option type is set to 10, the system will list only eight levels (i.e. Level 2, Level 3, Level 4, Level 5, Level 6, Level 7, Level 8, and Level 9) in the Entity Level field.</p>	
Hierarchy Entity	<p>Used to indicate the hierarchy entity that you want to include at the specified level (for example, Level 2) in the entity hierarchy relationship.</p> <p>Note:</p> <p>This field is enabled when you select the entity level from the respective field.</p> <p>The list appears only when the division and start date is specified for the entity hierarchy relationship.</p> <p>The list includes only those hierarchy entities:</p> <ul style="list-style-type: none"> • Which can be included at the specified level in the entity hierarchy relationship • Which are effective for the specified division on the entity hierarchy relationship start date 	Yes
Parent Hierarchy Entity	Used to indicate the parent hierarchy entity.	Yes

Field Name	Field Description	Mandatory (Yes or No)
	<p>Note:</p> <p>This field is enabled when you select the entity level from the respective field.</p> <p>The list appears when the division and start date is specified for the entity hierarchy relationship.</p> <p>The list includes only those hierarchy entities:</p> <ul style="list-style-type: none"> • Which can be included at the specified level minus one level in the entity hierarchy relationship • Which are effective for the specified division on the entity hierarchy relationship start date <p>For example, if you specify the hierarchy entity for Level 2, the system will list hierarchy entities which can be included at the first level in the Parent Hierarchy Entity field. And, if you specify the hierarchy entity for Level 5, the system will list hierarchy entities which can be included at the fourth level in the Parent Hierarchy Entity field. Here, note that you must select the hierarchy entity which is already included in the entity hierarchy relationship.</p>	
Start Date	<p>Used to specify the date from when the hierarchy entity is associated in the entity hierarchy relationship at the specified entity level.</p> <p>Note: The Start Date cannot be later than the End Date.</p>	Yes
End Date	<p>Used to specify the date till when the hierarchy entity is associated in the entity hierarchy relationship at the specified entity level.</p> <p>Note: The End Date cannot be earlier than the Start Date.</p>	No
Price Items	Used to associate price items with the hierarchy entity at the specified entity level of the entity hierarchy relationship.	No

4. Enter the required details in the **Main** section.
5. Add or remove levels from the entity hierarchy relationship, if required.

Note:

If you want to add more levels in the entity hierarchy relationship, click the **Add** (+) icon and then enter the details for the entity level. However, if you want to remove an entity level from the entity hierarchy relationship, click the **Delete** (🗑️) icon corresponding to the entity level.

You can include multiple hierarchy entities at the same level. But, you need to ensure that the parent hierarchy entity for such parallel levels is same.

6. Associate price items or price item bundles with the hierarchy entity for the subsequent levels in the **Hierarchy Details** section, if required.
7. Click **Save**.

The new entity hierarchy relationship is defined.

Note: You cannot define multiple entity hierarchy relationships for a division with the same entity hierarchy relationship start date.

Related Topics

For more information on...	See...
How to search for an entity hierarchy relationship	Searching for an Entity Hierarchy Relationship on page 337
Entity Hierarchy Relationship screen	Entity Hierarchy Relationship (Used for Viewing) on page 344
Hierarchy zone	Hierarchy on page 344
How to associate a price item or price item bundle with a hierarchy entity in an entity hierarchy relationship	Associating a Price Item or Price Item Bundle with a Hierarchy Entity in an Entity Hierarchy Relationship

Price Item (Financial Services Business)

A bank may offer wide range of services to its customers. For example, Direct Debit, Credit Transfer, Stop Payment, etc. Oracle Revenue Management and Billing enables you to define each service as a price item. Once a price item is created, you can define pricing for the price item and then create charges against it in the system. You can define pricing at various levels in the customer hierarchy. For more information, see [Price Assignment Search Mechanism](#) on page 275.

You can group two or more price items together. While associating a price item with another price item, you need to indicate how the child price item is related to the parent price item. The system enables you to relate two price items using either of the following relationship types:

- Child Price Item
- Custom
- Other
- Price Item
- Product Group
- Service
- Service Group

For example, you can create two price items named Credit Transfer (CRTRN) and Credit Refund (CRRFD) and then associate the CRRFD price item with the CRTRN price item using the **Child Price Item** relationship type. The grouping of price items is done only for the informational purposes and it does not have any billing impact.

You can also create a price item bundle and then add price items to the price item bundle. For example, you can create a price item bundle named Fund Transfer (FDTRN) and then add the CRTRN and CRRFD price items to the bundle. You may use a price item bundle in the following scenarios:

- To offer volume discounts by charging a lower price for a group of services
- To group high and low selling services together

Based on the requirements, you can define the following types of price item bundles in the system:

- *Regular Bundle* on page 287
- *Phantom Bundle* on page 291
- *Ratio Bundle* on page 288

The system enables you to create price items or price item bundles which can be used for:

- **Pricing** - It means that pricing can be defined for the price item or price item bundle, but no charges can be created against it in the system.
- **Pricing and Billing** - It means that pricing can be defined for the price item or price item bundle and charges can be created against it in the system.

The system enables you to create the following types of price items or price item bundles:

- **Rate Based Price Items** - The interest rate based services would include services on which interest is charged to the customers (for example, loan interest which is calculated on the borrowed amount) or services on which the interest is paid to the customers (for example, savings interest which is calculated on the daily outstanding balance). At present, you can define interest rate based price items which can be used for only pricing and not pricing and billing. Also, you cannot create interest rate based price item bundles in the system.
- **Fees Based Price Items** - The fees based services would include services on which fees are charged to the customers either annually or at regular intervals (for example, ATM service for which the bank charges annual fee). You can create fees based price items or price item bundles which can be used for pricing or pricing and billing in the system.

You need to associate a contract type with a price item or price item bundle. The system allows you to create a charge (i.e. billable charge) for a price item or price item bundle on an account when a contract of the contract type which is associated with the price item or price item bundle is already present on the account. You can specify a contract type when a price item or price item bundle is used for pricing and billing. If a price item or price item bundle is used for only pricing and not pricing and billing, the system automatically associates the contract type, which is specified in the **Default Contract Type** option type of the **C1_PRICING** feature configuration, with the price item or price item bundle.

You can assign a price item or price item bundle to a person, account, or price list. While assigning a price item or price item bundle, you need to define a pricing for the price item or price item bundle. You can define a standard price for a price item or price item bundle in the price list and then assign the price list to one or more persons or accounts. For more information about price list, see *Price List* on page 437. You can also define an override price for a price item or price item bundle that is specific to a person or account.

You can create price items or price item bundles which can be assigned to any price list except global price list or which can be assigned to only global price lists. For more information about global price list, see *Price List* on page 437.

You can define a price item manager To Do type and To Do role for each price item or price item bundle. The system creates a To Do using the price item manager To Do type when the deal creator or approver requests the price item manager (i.e. clicks the **Send Price Items for Approval** button) to approve the average price for the price item or price item bundle offered in a deal. The users with the price item manager To Do role can only approve the average price for the price item or price item bundle offered in a deal. Note that the price item manager can approve the average price when it is within the average price floor and ceiling limits of the price item manager To Do role.

You can associate one or more parameters where the parameter usage is set to **Price Item** with a price item or price item bundle. These parameters can then be used for:

- Aggregating transactions which are mapped to the price item or price item bundle
- Defining multi parameter based pricing for the price item or price item bundle

If the parameter usage is set to **Aggregation** while associating a parameter with a price item or price item bundle, the parameter is only used for aggregating transactions which are mapped to the price item or price item bundle. However, if the parameter usage is set to **Pricing** while associating a parameter with a price item or price item bundle, the parameter is used for aggregating transactions as well as for defining multi parameter based pricing for the price item or price item bundle. Note that you can associate parameters only to regular price item bundles and not to ratio and phantom price item bundles.

You can associate a price item or price item bundle to one or more divisions. You can assign a price item or price item bundle to an account, person, or price list when the account, person, or price list belongs to the division to which the price item or price item bundle is associated. In addition, you can do the following when a price item or price item bundle is associated to a division:

- Associate the Service Quantity Identifiers (SQIs) with the Price Item or Price Item Bundle for the Division
- Define the Accrual Type Criteria of the Price Item or Price Item Bundle for the Division
- Associate the Price Item or Price Item Bundle with a Hierarchy Entity in an Entity Hierarchy Relationship of the Division
- Define the Cost of the Price Item or Price Item Bundle for the Division
- Define the Average Price Floor and Ceil Limits of the Price Item or Price Item Bundle for the Division
- Define the Division-Specific Characteristics for the Price Item or Price Item Bundle

Price Item (Used for Searching)

The **Price Item** screen allows you to search for a price item or price item bundle using various search criteria. It also allows you to create and copy a price item or price item bundle. It contains the following zone:

- [Search Price Item](#) on page 358

Through this screen, you can navigate to the following screens:

- [Price Item \(Used for Viewing\)](#) on page 402
- [Price Item Relationship](#) on page 420
- [Price Item Assignments](#) on page 434

Search Price Item

The **Search Price Item** zone allows you to search for a price item or price item bundle using various search criteria. It contains the following two sections:

- **Search Criteria** – The **Search Criteria** section contains the following fields:



Field Name	Field Description	Mandatory (Yes or No)
Search By	Used to indicate whether you want to search for a price item or price item bundle using the price item details. The valid value is: <ul style="list-style-type: none"> • Price Item Details 	Yes
	Note: By default, the Price Item Details option is selected.	

Field Name	Field Description	Mandatory (Yes or No)
Price Item	Used to search a particular price item or price item bundle.	No
Description	Used to search price items or price item bundles with a particular description.	No
Division	Used to search price items or price item bundles which are associated with a particular division.	No
	Note: You can only view those divisions to which you have access in the Division list.	
Global Price List	Used to search price items or price item bundles which can be assigned to a global price list. The valid values are: <ul style="list-style-type: none"> • Yes • No 	No
Price Item Usage	Used to search price items or price item bundles which is available for pricing or pricing and billing. The valid values are: <ul style="list-style-type: none"> • Pricing • Pricing and Billing 	No
	Note: By default, the Pricing and Billing option is selected.	
Bundle	Used to indicate whether you want to search a price item bundle. The valid values are: <ul style="list-style-type: none"> • Yes • No 	No
Price Item Type	Used to search a particular type of price items or price item bundles. The valid values are: <ul style="list-style-type: none"> • Fees • Rate 	No
	Note: This field appears when the Pricing option is selected from the Price Item Usage list.	

Note: You must specify at least one search criterion while searching for a price item or price item bundle.

- **Search Results** – On clicking the **Search** button, the search results appear based on the specified search criteria. The **Search Results** section contains the following columns:

Column Name	Column Description
Price Item Information	Displays information about the price item or price item bundle.

Column Name	Column Description
	Note: It has a link. On clicking the link, the Price Item screen appears where you can view the details of the respective price item or price item bundle.
Bundle Type	Indicates the type of the price item bundle. If the price item bundle is available for pricing and billing, the valid values are: <ul style="list-style-type: none"> • Phantom • Ratio • Regular However, if the price item bundle is available for pricing and its price item type is set to Fees , the valid value is: <ul style="list-style-type: none"> • Regular
Price Item Type	Indicates the type of the price item or price item bundle. The valid values are: <ul style="list-style-type: none"> • Rate • Fees
Price Item Usage	Indicates whether the price item or price item bundle is available for pricing or pricing and billing. The valid values are: <ul style="list-style-type: none"> • Pricing • Pricing and Billing
Duplicate	On clicking the Duplicate () icon, the Price Item screen appears where you can create a new price item or price item bundle using an existing price item or price item bundle.
Price Item Assigned To	On clicking the View () icon in the Price Item Assigned To column, the Price Item Assignments screen appears where you can view the persons, accounts, and active price lists to which the price item or price item bundle is assigned.
Price Item Relationship	On clicking the View () icon in the Price Item Relationship column, the Price Item Relationship screen appears where you can view the list of the price items and price item bundles associated with the parent price item or added to the price item bundle.

Note: Pagination is used to display limited number of records in the **Search Results** section. You can use the navigation links, such as **Previous** and **Next** to navigate between pages.

Related Topics

For more information on...	See...
Price Item screen	Price Item (Used for Searching) on page 358
How to search for a price item or price item bundle	Searching for a Price Item or Price Item Bundle on page 361
How to view the details of a price item or price item bundle	Viewing the Price Item or Price Item Bundle Details on page 401

For more information on...	See...
How to copy a price item or price item bundle	Copying a Price Item or Price Item Bundle on page 394
Price Item Assignments screen	Price Item Assignments on page 434
Price Item Relationship screen	Price Item Relationship on page 420

Searching for a Price Item or Price Item Bundle

Prerequisites

To search for a price item or price item bundle, you should have:

- Divisions defined in the application
- Price items or price item bundles associated with the division to which the user (i.e. who is performing this action) belongs

Procedure

To search for a price item or price item bundle:

1. Click the **Menu** link in the **Application** toolbar.
A list appears.
2. From the **Main** menu, select **Pricing Management** and then click **Price Item**.
A sub-menu appears.
3. Click the **Search** option from the **Price Item** sub-menu.
The **Price Item** screen appears.
4. Enter the search criteria in the **Search Price Item** zone depending on whether you want to search for a price item or price item bundle.

Note: ORMB search engine supports wildcard search, where you can substitute the percentage (%) symbol as a stand in for any word or letter in a search criteria. You can use the ‘%’ wildcard character in all input fields except the date and ID fields. The ‘%’ wildcard character is suffixed automatically at the end of the partial search criteria. Therefore, you may or may not specify the wildcard character at the end of the partial search criteria. However, you have to prefix the wildcard character manually wherever required.

5. Click **Search**.

A list of price items or price item bundles that meet the search criteria appears in the **Search Results** section.

Related Topics

For more information on...	See...
Price Item screen	Price Item (Used for Searching) on page 358
Search Price Item zone	Search Price Item on page 358

Defining a Price Item or Price Item Bundle

Prerequisites

To define a price item or price item bundle, you should have:

- Contract types, To Do types, and To Do roles defined in the application
- To Do roles associated with the required To Do type
- Value defined for the **Default Contract Type** option type in the **C1_PRICING** feature configuration

Procedure

To define a price item or price item bundle:

1. Click the **Menu** link in the **Application** toolbar.
A list appears.
2. From the **Main** menu, select **Pricing Management** and then click **Price Item**.
A sub-menu appears.
3. Click the **Add** option from the **Price Item** sub-menu.

The **Price Item** screen appears. It contains the following sections:

- **Main** - Used to specify basic details about the price item or price item bundle.
- **Parameters** - Used to associate a parameter with the price item or price item bundle. These associated parameters are then used for aggregating transactions and/or for defining the price item pricing.

Note:

The **Parameters** section appears in the **Price Item** screen when the **Multi Price Parameter** option type of the **C1_PPARM_FLG** feature configuration is set to **True**.

You cannot associate parameters to the ratio and phantom price item bundles. Therefore, while defining a ratio or phantom price item bundle, the **Parameters** section does not appear in the **Price Item** screen.

- **Divisions** - Used to associate the price item or price item bundle with one or more divisions. In addition, it enables you to:
 - Associate the service quantity identifiers (SQIs) with the price item or price item bundle for a division
 - Define the accrual type criteria of the price item or price item bundle for a division

Note: This step is not applicable for the health insurance business.

- Associate the price item or price item bundle with a hierarchy entity in an entity hierarchy relationship of a division

Note: This step is not applicable for the health insurance business.

- Define the cost of the price item or price item bundle for a division

Note: This step is not applicable for the health insurance business.

- Define the average price floor and ceil limits of the price item or price item bundle for a division

Note: This step is not applicable for the health insurance business.

- Define the negotiability floor and ceil values of the price item or price item bundle for a division

Note: This step is not applicable for the health insurance business.

- Define the division-specific characteristics for the price item or price item bundle
- **Price Item Characteristics** - Used to define characteristics (which are applicable across divisions) for the price item or price item bundle.

The **Main** section contains the following fields:

Field Name	Field Description	Mandatory (Yes or No)
Price Item	Used to specify the price item or price item bundle.	Yes
Description	Used to specify the description for the price item or price item bundle.	Yes
Price Item Usage	<p>Used to indicate whether the price item or price item bundle is available for pricing or pricing and billing. The valid values are:</p> <ul style="list-style-type: none"> • Pricing - Used when you want to define pricing for the price item or price item bundle, but no charges should be created against it in the system. <div style="border: 1px solid black; padding: 2px; margin: 5px 0;"> <p>Note: This option is not applicable for the health insurance business.</p> </div> <ul style="list-style-type: none"> • Pricing and Billing - Used when you want to define pricing and create charges for the price item or price item bundle in the system. <div style="border: 1px solid black; padding: 2px; margin: 5px 0;"> <p>Note: By default, the Pricing and Billing option is selected.</p> </div>	Yes
Price Item Type	<p>Used to indicate the type of the price item or price item bundle. The valid values are:</p> <ul style="list-style-type: none"> • Rate - Used when you want to create a rate based price item or price item bundle. For example, savings, current, and loan interest services (i.e. price items) are rate based price items. <div style="border: 1px solid black; padding: 2px; margin: 5px 0;"> <p>Note: This option is not applicable for the health insurance business.</p> </div> <ul style="list-style-type: none"> • Fees - Used when you want to create a fee based price item or price item bundle. For example, debit credit service (i.e. price item) is a fee based price item. 	Yes

Field Name	Field Description	Mandatory (Yes or No)
	<p>Note:</p> <p>This field appears when the Pricing option is selected from the Price Item Usage list.</p> <p>By default, the Fees option is selected.</p> <p>You cannot create a price item bundle when the Pricing option is selected from the Price Item Usage list and Rate option is selected from the Price Item Type list.</p> <p>The system automatically sets the price item type of those price items or price item bundles which are available for pricing and billing to Fees. Therefore, this field does not appear when the Pricing and Billing option is selected from the Price Item Usage list.</p>	
Bundle	<p>Used to indicate whether you want to create a price item bundle. The valid values are:</p> <ul style="list-style-type: none"> • Yes • No <p>Note:</p> <p>By default, the No option is selected.</p> <p>This field is not applicable for the health insurance business.</p>	Yes
Bundle Type	<p>Used to indicate the type of the price item bundle. If the Pricing and Billing option is selected from the Price Item Usage list, the valid values are:</p> <ul style="list-style-type: none"> • <i>Regular Bundle</i> on page 287 • <i>Phantom Bundle</i> on page 291 • <i>Ratio Bundle</i> on page 288 <p>However, if the Pricing option is selected from the Price Item Usage list and the Fees option is selected from the Price Item Type list, you can only define a regular price item bundle. Therefore, by default, the value is set to Regular.</p>	<p>Yes (Conditional)</p> <p>Note: This field is required when you are creating a price item bundle.</p>

Field Name	Field Description	Mandatory (Yes or No)
	<p>Note:</p> <p>This field appears when the Yes option is selected from the Bundle list.</p> <p>This field is enabled when the Pricing and Billing option is selected from the Price Item Usage list and the Yes option is selected from the Bundle list.</p> <p>You cannot define a price item bundle when the Pricing option is selected from the Price Item Usage list and Rate option is selected from the Price Item Type list.</p> <p>This field is not applicable for the health insurance business.</p>	
Global Price List	<p>Used to indicate whether the price item or price item bundle can be assigned to a global price list. The valid values are:</p> <ul style="list-style-type: none"> • Yes • No <p>Note: By default, the No option is selected.</p>	Yes
Contract Type	<p>Used to indicate the contract type that you want to associate with the price item or price item bundle.</p> <p>Note:</p> <p>This field appears when the Pricing and Billing option is selected from the Price Item Usage list.</p> <p>The Search (🔍) icon appears corresponding to the Contract Type field. On clicking the Search icon, the Contract Type Search window appears.</p>	Yes
Price Item Manager To Do Type	<p>Used to indicate the To Do type using which a To Do should be created when the deal creator or approver requests the price item manager (i.e. clicks the Send Price Items for Approval button) to approve the average price for the price item or price item bundle offered in a deal.</p>	No

Field Name	Field Description	Mandatory (Yes or No)
	<p>Note:</p> <p>The Search (🔍) icon appears corresponding to the Price Item Manager To Do Type field. On clicking the Search icon, the To Do Type Search window appears.</p> <p>On specifying the To Do type, the description of the To Do type appears corresponding to the Price Item Manager To Do Type field.</p> <p>This field is not applicable for the health insurance business.</p>	
Price Item Manager To Do Role	<p>Used to indicate that users with the specified To Do role can approve the average price for the price item or price item bundle offered in a deal. Note that the price item manager can approve the average price when it is within the average price floor and ceil limits defined for the To Do role.</p> <p>Note:</p> <p>The list appears when the price item manager To Do type is selected from the respective field. It includes only those To Do roles which are associated with the price item manager To Do type.</p> <p>This field is not applicable for the health insurance business.</p>	<p>Yes (Conditional)</p> <p>Note: This field is required when the price item manager To Do type is specified for the price item or price item bundle.</p>
Average Price Floor and Ceil Type	<p>Used to indicate the manner in which you want to define the average price floor and ceil limits for the price item or price item bundle. The valid value is:</p> <ul style="list-style-type: none"> • Absolute Value Range - Used when you want to define the average price floor and ceil limits in the absolute values. For example, the average price for the price item or price item bundle should be between 10\$ to 15\$. • Spread Amount - Used when you want to define the average floor and ceil limits based on the spread amount. • Spread Percentage – Used when you want to define the average floor and ceil limits based on the spread percentage. 	<p>Yes (Conditional)</p> <p>Note: This field is required when you are defining the average price floor and ceil limits of the price item or price item bundle for a division.</p>

Field Name	Field Description	Mandatory (Yes or No)
	<p>Note:</p> <ul style="list-style-type: none"> Incase of Spread Amount and Spread Percentage options, the system calculates the average price of a price item and based on the average price and the spread amount or spread percentage, the average floor and ceil limits are derived. This field is not applicable for the health insurance business. 	
Sort Sequence	Used to specify the sequence in which the price item should appear in the price item hierarchy of the deal management module.	No
Variable Price	<p>Used to indicate whether the system inherits the pricing of the price item from the price list while orchestrating a deal in the deal management module.</p> <p>Note:</p> <p>If the Variable Price option is selected, the pricing offered for a price item to an entity in the deal is overridden when the price list pricing is changed after orchestrating the deal in the system.</p> <p>However, if the Variable Price option is not selected, the pricing offered for a price item to an entity in the deal is not overridden when the price list pricing is changed in the system. This enables the relationship manager to create deals for an existing customers, accounts, and prospects where the pricing of the price items are fixed for a particular timeframe.</p>	No

Tip: Alternatively, you can access the **Price Item** screen by clicking the **Add** button in the **Page Title** area of the **Price Item** screen.

- Enter the required details in the **Main** section.
- Associate the parameters with the price item or price item bundle, if required.

Note: For each predefined parameter which is associated with the price item or price item bundle, you can define a set of valid predefined parameter values for the price item or price item bundle, if required.

- Associate the price item or price item bundle with the required divisions.
- Associate the SQIs with the price item or price item bundle for the required divisions.
- Define the accrual type criteria of the price item or price item bundle for the required divisions.

Note: This step is not applicable for the health insurance business.

9. Associate the price item or price item bundle with a hierarchy entity in an entity hierarchy relationship of the required divisions.

Note: This step is not applicable for the health insurance business.

10. Define the cost of the price item or price item bundle for the required divisions.

Note: This step is not applicable for the health insurance business.

11. Define the average price floor and ceil limits of the price item or price item bundle for the required divisions.

Note: This step is not applicable for the health insurance business.

12. Define the negotiability floor and ceil values of the price item or price item bundle for the required divisions.

Note: This step is not applicable for the health insurance business.

13. Define the division-specific characteristics for the price item or price item bundle. if required.

14. Define the characteristics for the price item or price item bundle, if required.

15. Click **Save**.

The price item is defined.

Note: While creating a price item or price item bundle which is available for pricing, the contract type specified in the **Default Contract Type** option type of the **C1_PRICING** feature configuration is automatically associated to the price item or price item bundle.

Related Topics

For more information on...	See...
Price Item screen	Price Item (Used for Searching) on page 358
How to associate a parameter with a price item or price item bundle	Associating a Parameter with a Price Item or Price Item Bundle on page 369
How to associate a price item or price item bundle with a division	Associating a Price Item or Price Item Bundle with a Division on page 374
How to associate an SQI with a price item or price item bundle for a division	Associating an SQI with a Price Item or Price Item Bundle for a Division on page 377
How to define the accrual type criteria of a price item or price item bundle for a division	Defining the Accrual Type Criteria of a Price Item or Price Item Bundle for a Division on page 380
How to associate a price item or price item bundle with a hierarchy entity in an entity hierarchy relationship of a division	Associating a Price Item or Price Item Bundle with a Hierarchy Entity in an Entity Hierarchy Relationship of a Division on page 382
How to define the cost of a price item or price item bundle for a division	Defining the Cost of a Price Item or Price Item Bundle for a Division on page 384
How to define the average price floor and ceil limits of a price item or price item bundle for a division	Defining the Average Price Floor and Ceil Values of a Price Item or Price Item Bundle for a Division on page 387
How to define the rate negotiability floor and ceil values of a price item or price item bundle for a division	Defining the Rate Negotiability Floor and Ceil Values of a Price Item or Price Item Bundle for a Division on page 390
How to define a division-specific characteristic for a price item or price item bundle	Defining a Division-Specific Characteristic for a Price Item or Price Item Bundle on page 379

For more information on...	See...
How to define a characteristic for a price item or price item bundle	Defining a Characteristic for a Price Item or Price Item Bundle on page 392
How to set the C1_PRICING feature configuration	Setting the C1_PRICING Feature Configuration on page 4342

Associating a Parameter with a Price Item or Price Item Bundle

You can define multi parameter based pricing for a price item or price item bundle when the parameters using which you want to define the price item pricing are associated with the respective price item or price item bundle during the pricing date range. Let us understand this with the help of an example from the financial institution domain.

The following table illustrates how a financial institution can offer different price for a price item based on the return codes:

Service	Price Item	Parameter	Parameter Value	Price
SEPA Direct Debit Return	SEPADDR	Return Code (RTURNCD)	AC01	0.1\$
			AC04	0.2\$
			AC06	0.3\$
			AG01	0.10\$

In such case, you need to first define a predefined parameter named Return Code where the parameter usage is set to **Price Item**). In the Return Code parameter, you must specify the above listed return codes (i.e. AC01, AC04, AC06, and AG01) as the predefined values. Then, in order to define multi parameter based pricing for the SEPADDR price item using the Return Code parameter, you must associate the Return Code parameter with the SEPADDR price item using the following specifications:

Parameter	Display Order	Mandatory (Yes or No)	Optional Priority
Return Code	10	Yes	-

Let us understand this with the help of another example from the health insurance domain.

The following table illustrates how a self-funded customer can be charged different admin fee for the services based on health coverage class and network type:

Service	Price Item	Health Coverage Class	Network Type	Fees
Claim Based Fees	CLBDFS	Medical	In	\$100
		Medical	Out	\$150
		Dental	In	\$50
		Dental	Out	\$75

In such case, you need to first define two predefined parameters named Health Coverage Class and Network Type where the parameter usage is set to **Price Item**). In the Health Coverage Class parameter, you must specify the above listed values (i.e. Medical and Dental) as the predefined values. And, in the Network Type parameter, you must specify the above listed values (i.e. In and Out) as the predefined values. Then, in order to define parameter based pricing for the CLBDFS price item using the Health Coverage Class and Network Type parameters, you must associate these parameters with the CLBDFS price item using the following specifications:

Parameter	Display Order	Mandatory (Yes or No)	Optional Priority
Health Coverage Class	10	Yes	-
Network Type	20	Yes	-

Prerequisites

To associate a parameter with a price item or price item bundle, you should have:

- Parameters defined in the application (where the parameter usage is set to **Price Item**)

Procedure

To associate a parameter with a price item or price item bundle:

- Click the **Parameters** or **Show All** link in the **Section** pane when you are defining, editing, or copying a price item or price item bundle.

The **Parameters** section appears. It contains the following fields in a grid:

Field Name	Field Description	Mandatory (Yes or No)
Effective Start Date	Used to specify the date from when the parameter is associated with the price item or price item bundle.	Yes
Effective End Date	Used to specify the date till when the parameter is associated with the price item or price item bundle.	No
Parameter	<p>Used to indicate the parameter that you want to associate with the price item or price item bundle.</p> <p>Note:</p> <p>The Search (🔍) icon appears corresponding to the Parameter field. On clicking the Search icon, the Parameter Search window appears.</p> <p>In the Parameter Search window, the system allows you to search only those parameters where the parameter usage is set to Price Item.</p> <p>If you select a predefined parameter, the Add (➕) icon appears corresponding to the Parameter field. On clicking the Add icon, a grid appears where you can specify a list of predefined parameter values which are valid for the price item or price item bundle while defining its pricing. If you do not list any predefined parameter value in this grid, the system enables you to specify any predefined value of the parameter while defining the pricing for the price item or price item bundle.</p>	Yes
Business Label	Used to specify a business label for the parameter. If you specify the business label for a parameter, the business label appears	No

Field Name	Field Description	Mandatory (Yes or No)
	throughout the application instead of the parameter name.	
Display Order	Used to indicate the order in which the parameter and its value should appear in the pricing parameter information string across the application.	Yes
Parameter Usage	Used to indicate whether you want to use the parameter for aggregation and/or for defining the price item pricing. The valid values are: <ul style="list-style-type: none"> • Aggregation – Used when you want to use the parameter for aggregating transactions. • Pricing – Used when you want to use the parameter for aggregating transactions as well as for defining the price item pricing. 	Yes
Mandatory	Used to indicate whether the parameter is mandatory while defining the price item pricing.	No
Priority	Used to indicate the priority in which optional parameters should be considered while determining best fit price for the price item or price item bundle. <p>Note: This field is disabled when the Mandatory option is selected.</p>	Yes (Conditional)
		Note: This field is required when the Mandatory option is not selected.

Note:

The **Parameters** section appears in the **Price Item** screen when the **Multi Price Parameter** option type of the **C1_PPARM_FLG** feature configuration is set to **True**.

You cannot associate parameters to the ratio and phantom price item bundles. Therefore, while defining a ratio or phantom price item bundle, the **Parameters** section does not appear in the **Price Item** screen.

2. Enter the required details in the **Parameters** section.
3. If you want to associate more than one parameter with the price item or price item bundle, click the **Add (+)** icon and then repeat step 2.

Note:

However, if you want to remove a parameter from the price item or price item bundle, click the **Delete (🗑)** icon corresponding to the parameter. You can edit the parameter details and remove a parameter from the price item or price item bundle when the parameter or any other parameter from the same date range is not yet used for aggregation or for defining the price item pricing.

You can add a parameter which is used for aggregation, whenever required. However, you can add a parameter which is used for pricing when any other parameter from the same date range is not yet used for aggregation or for defining the price item pricing.

4. For each predefined parameter which is associated with the price item or price item bundle, you can define a set of valid predefined parameter values for the price item or price item bundle, if required.

5. Click **Save**.

The parameters are associated with the price item or price item bundle.

Note: By default, the priority of all parameters which are mandatory is set to 0.

Related Topics

For more information on...	See...
How to define a price item or price item bundle	Defining a Price Item or Price Item Bundle on page 361
How to edit a price item or price item bundle	Editing a Price Item or Price Item Bundle on page 413
How to copy a price item or price item bundle	Copying a Price Item or Price Item Bundle on page 394
How to define the valid predefined parameter values for a price item or price item bundle	Defining the Valid Predefined Parameter Values for a Price Item or Price Item Bundle on page 372

Defining the Valid Predefined Parameter Values for a Price Item or Price Item Bundle

A predefined parameter may have hundreds of values defined in the system. But, there might be situations when only certain predefined parameter values are applicable for a price item or price item bundle while defining its pricing. In such case, you can define a set of valid predefined parameter values for a price item or price item bundle. For example, the Return Code parameter has the following predefined parameter values:

Parameter Value	Description
AC01	Account Identifier Incorrect (i.e. invalid IBAN)
AC04	Account Closed
AC06	Account Blocked
AG01	Direct Debit Forbidden for Regulatory Reasons
AG02	Operation/Transaction Code Incorrect
AM04	Insufficient Funds
AM05	Duplicate Collection
MD01	Unauthorized Transaction
MD06	Disputed Authorized Transaction

If only the MD01 and MD06 predefined parameter values are applicable for the SEPA Debit Refund (SEPADRF) price item, you can define MD01 and MD06 as the valid predefined parameter values for the SEPADRF price item. In such case, the system will allow you to define the pricing for the SEPADRF price item only using the MD01 or MD06 parameter value. However, if all the above listed predefined parameter values are applicable for the SEPA Direct Debit Return (SEPADDR) price item, you must not define the valid predefined parameter values for the SEPADDR price item. In such case, the system will allow you to define the pricing for the SEPADDR price item using any of the above listed parameter value.

Another example, the Health Coverage Class parameter has the following predefined parameter values:

Parameter Value	Description
MEDICAL	Medical
DENTAL	Dental
VISION	Vision

If only the MEDICAL and DENTAL predefined parameter values are applicable for the Claim Based Fees (CLBDFS) price item, you can define MEDICAL and DENTAL as the valid predefined parameter values for the CLBDFS price item. In such case, the system will allow you to define the pricing for the CLBDFS price item only using the MEDICAL or DENTAL parameter value. However, if all the above listed predefined parameter values are applicable for the Claim Based Fees (CLBDFS) price item, you must not define the valid predefined parameter values for the CLBDFS price item. In such case, the system will allow you to define the pricing for the CLBDFS price item using any of the above listed parameter value.

Prerequisites

To define the valid predefined parameter values for a price item or price item bundle, you should have:

- Predefined values defined for the parameter which is associated with the price item or price item bundle
- Price items or price item bundles associated with the division to which the user (i.e. who is performing this action) belongs

Procedure

To define the valid predefined parameter values for a price item or price item bundle:

1. Click the **Parameters** or **Show All** link in the **Section** pane when you are defining, editing, or copying a price item or price item bundle.

The **Parameters** section appears.

2. Click the **Add** () icon in the **Parameter** column corresponding to the predefined parameter which is associated with the price item or price item bundle.

The following field appears in a grid:

Field Name	Field Description	Mandatory (Yes or No)
Parameter Value	Used to indicate the predefined parameter value which you can use for the price item or price item bundle while defining the pricing.	Yes (Conditional)
	<p>Note:</p> <p>The Search () icon appears corresponding to the Parameter Value field. On clicking the Search icon, the Predefined Parameter Value Search window appears.</p> <p>On specifying the valid predefined parameter value for a price item or price item bundle, the description of the predefined parameter value appears corresponding to the Parameter Value field.</p>	<p>Note: This field is required when you are defining the valid predefined parameter values for the price item or price item bundle.</p>

3. Enter a predefined parameter value which is valid for the price item or price item bundle while defining its pricing.
4. If you want to define more than one valid predefined parameter value for the price item or price item bundle, click the **Add** () icon and then repeat step 3.

Note: However, if you want to remove a valid predefined parameter value from the price item or price item bundle, click the **Delete** () icon corresponding to the parameter value. You can remove a valid predefined parameter value from the price item or price item bundle when the parameter value is not yet used for defining the price item pricing.

5. Click **Save**.

The valid predefined parameter values are defined for the price item or price item bundle.

Related Topics

For more information on...	See...
How to associate a parameter with a price item or price item bundle	Associating a Parameter with a Price Item or Price Item Bundle on page 369

Associating a Price Item or Price Item Bundle with a Division

You can assign a price item or price item bundle to a person or account when the price item or price item bundle is associated with the division to which the person or account belongs. Let us understand this with the help of an example from the financial institution domain.

The following table illustrates how a price item can be associated with one or more divisions in the financial institution domain:

Price Item	Division
SEPA Direct Debit Return (SEPADDR)	001-AL
	002-CA
	003-FL
	004-IN
Stop Payment (STPPMT)	002-CA
	003-FL
	004-IN

In such case, you can assign the SEPADDR price item to any person or account which belongs to the 001-AL, 002-CA, 003-FL, or 004-IN division. However, you can assign the STPPMT price item to any person or account which belongs to the 002-CA, 003-FL, or 004-IN division.

Let us understand this with the help of an example from the health insurance domain.

The following table illustrates how a price item can be associated with one or more divisions in the health insurance domain:

Price Item	Division
Claim Based Fees (CLBDFS)	002-CA
	003-FL
	004-IN

In such case, you can charge the CLBDFS price item to any person or account which belongs to the 002-CA, 003-FL, or 004-IN division.

Prerequisites

To associate a price item or price item bundle with a division, you should have:

- Divisions defined in the application
- Divisions associated with the access group to which the user (i.e. who is performing this action) belongs

Procedure

To associate a price item or price item bundle with a division:

1. Click the **Divisions** or **Show All** link in the **Section** pane when you are defining, editing, or copying a price item or price item bundle.

The **Divisions** section appears. It contains the following fields in a grid:

Field Name	Field Description	Mandatory (Yes or No)
SQIs	On clicking the Add (⊕) icon, you can associate an SQI with the price item or price item bundle for the division.	Not applicable
Division Characteristics	On clicking the Add (⊕) icon, you can define a division-specific characteristic for the price item or price item bundle.	Not applicable
Accrual Type Criteria	On clicking the Add (⊕) icon, you can define the accrual type criteria of the price item or price item bundle for the division.	Not applicable
	Note: This feature is not applicable for the health insurance business.	
Entity Hierarchy	On clicking the Add (⊕) icon, you can associate the price item or price item bundle with a hierarchy entity of an entity hierarchy relationship for the division.	Not applicable
	Note: This feature is not applicable for the health insurance business.	
Costs	On clicking the Add (⊕) icon, you can define the cost of the price item or price item bundle for the division.	Not applicable
	Note: This feature is not applicable for the health insurance business.	
Average Price Floor and Ceil Limits	On clicking the Add (⊕) icon, you can define the average price floor and ceil limits of the price item or price item bundle for the division.	Not applicable
	Note: This feature is not applicable for the health insurance business.	
Negotiability	On clicking the Add (⊕) icon, you can define the negotiability floor and ceil limits of the price item or price item bundle for the division.	No
	Note: This feature is not applicable for the health insurance business.	
Division	Used to indicate the division to which you want to associate the price item or price item bundle.	Yes (Conditional)

Field Name	Field Description	Mandatory (Yes or No)
	Note: You can only view those divisions to which you have access in the Division list.	Note: This field is required while associating the price item or price item bundle with a division.

- Select the division from the respective field.
- If you want to associate the price item or price item bundle with more than one division, click the **Add (+)** icon and then repeat step 2.

Note: However, if you want to remove the price item or price item bundle from a division, click the **Delete** (🗑️) icon corresponding to the division. You cannot remove the price item or price item bundle from a division when it is assigned to a person or account which belongs to the division.

- Associate the SQIs with the price item or price item bundle for the required divisions.
- Define the accrual type criteria of the price item or price item bundle for the required divisions.

Note: This step is not applicable for the health insurance business object.

- Associate the price item or price item bundle with a hierarchy entity of an entity hierarchy relationship for the required divisions.

Note: This step is not applicable for the health insurance business object.

- Define the cost of the price item or price item bundle for the required divisions.

Note: This step is not applicable for the health insurance business object.

- Define the average price floor and ceil limits of the price item or price item bundle for the required divisions.

Note: This step is not applicable for the health insurance business object.

- Define the rate negotiability floor and ceil limits of the price item or price item bundle for the required divisions.

Note: This step is not applicable for the health insurance business object.

- Define the division-specific characteristics for the price item or price item bundle. if required.

- Click **Save**.

The price item or price item bundle is associated with the divisions.

Tip: Alternatively, you can associate a price item or price item bundle with a division using the **Division** screen. For more information, see [Associating a Price Item or Price Item Bundle with a Division](#) on page 750.

Related Topics

For more information on...	See...
How to define a price item or price item bundle	Defining a Price Item or Price Item Bundle on page 361
How to edit a price item or price item bundle	Editing a Price Item or Price Item Bundle on page 413
How to copy a price item or price item bundle	Copying a Price Item or Price Item Bundle on page 394
How to associate an SQI with a price item or price item bundle for a division	Associating an SQI with a Price Item or Price Item Bundle for a Division on page 377

For more information on...	See...
How to define the accrual type criteria of a price item or price item bundle for a division	Defining the Accrual Type Criteria of a Price Item or Price Item Bundle for a Division on page 380
How to associate a price item or price item bundle with a hierarchy entity of an entity hierarchy relationship for a division	Associating a Price Item or Price Item Bundle with a Hierarchy Entity in an Entity Hierarchy Relationship of a Division on page 382
How to define the cost of a price item or price item bundle for a division	Defining the Cost of a Price Item or Price Item Bundle for a Division on page 384
How to define the average price floor and ceil limits of a price item or price item bundle for a division	Defining the Average Price Floor and Ceil Values of a Price Item or Price Item Bundle for a Division on page 387
How to define a division-specific characteristic for a price item or price item bundle	Defining a Division-Specific Characteristic for a Price Item or Price Item Bundle on page 379

Associating an SQI with a Price Item or Price Item Bundle for a Division

In the transaction aggregation process, an SQI based billable charge is created for a price item or price item bundle (to which a transaction is mapped) when:

- The SQIs are associated with the price item or price item bundle for the division to which the account (i.e. for which the billable charge is created) belongs.
- The transaction aggregation rules are defined for such SQIs in the system.

Let us assume that the A1 account belongs to the 201-NJ division and the A2 account belongs to the 209-CA division.

The following table illustrates how you can define division-specific SQIs for a price item in the financial institution domain:

Price Item	Division	Service Quantity Identifiers (SQIs)
Stop Payments (STPY)	201-NJ	Number of Transactions (NBRTXN)
		Transaction Volume (TXNVOL)
		Transaction Amount (TXNAMT)
	209-CA	Number of Transactions (NBRTXN)
		Transaction Amount (TXNAMT)

Now, when an SQI based billable charge is created for the A1 account through the transaction aggregation process, the system calculates the following SQIs using the respective transaction aggregation rule:

- Number of Transactions (NBRTXN)
- Transaction Volume (TXNVOL)
- Transaction Amount (TXNAMT)

And, when an SQI based billable charge is created for the A2 account through the transaction aggregation process, the system calculates the following SQIs using the respective transaction aggregation rule:

- Number of Transactions (NBRTXN)
- Transaction Amount (TXNAMT)

Another example, you can calculate the enrollment based fees for a self-funded customer based on Per Subscriber Per Month or Per Member Per Month for the 201-NJ and 209-CA divisions. Therefore, you need to associate two SQIs — Subscriber Count and Member Count with the Enrollment Based Fees (ERBDFS) price item.

The following table illustrates how you can define division-specific SQIs for a price item in the health insurance domain:

Price Item	Division	Service Quantity Identifiers (SQIs)
Enrollment Based Fees (ERBDFS)	201-NJ	Subscriber Count (SUBCNT)
		Member Count (MEMCNT)
	209-CA	Subscriber Count (SUBCNT)
		Member Count (MEMCNT)

Prerequisites

To associate an SQI with a price item or price item bundle for a division, you should have:

- Service Quantity Identifiers (SQIs) defined in the application
- Price items or price item bundles associated with the division to which the user (i.e. who is performing this action) belongs

Procedure

To associate an SQI with a price item or price item bundle for a division:

1. Click the **Divisions** or **Show All** link in the **Section** pane when you are defining, editing, or copying a price item or price item bundle.

The **Divisions** section appears.

2. Click the **Add** (+) icon in the **SQIs** column corresponding to the division for which you want to associate SQIs with the price item or price item bundle.

The following field appears in a grid:

Field Name	Field Description	Mandatory (Yes or No)
SQI	Used to indicate the SQI that you want to associate with the price item or price item bundle for the division.	Yes (Conditional)
	<p>Note:</p> <p>The Search (🔍) icon appears corresponding to the SQI field. On clicking the Search icon, the Service Quantity Identifier Search window appears.</p> <p>On specifying the SQI, the description of the SQI appears corresponding to the SQI field.</p>	<p>Note: This field is required while associating an SQI with the price item or price item bundle for the division.</p>

3. Enter the required details in the **SQIs** grid.
4. If you want to associate more than one SQI with the price item or price item bundle for the division, click the **Add** (+) icon and then repeat step 3.

Note: However, if you want to remove an SQI from the price item or price item bundle for the division, click the **Delete** (🗑️) icon corresponding to the SQI. You cannot remove an SQI from the price item or price item bundle for the division when an SQI based billable charge is created using the SQI.

5. Click **Save**.

The SQIs are associated with the price item or price item bundle for the division.

Related Topics

For more information on...	See...
How to define a price item or price item bundle	Defining a Price Item or Price Item Bundle on page 361
How to edit a price item or price item bundle	Editing a Price Item or Price Item Bundle on page 413
How to copy a price item or price item bundle	Copying a Price Item or Price Item Bundle on page 394
How to associate a price item or price item bundle with a division	Associating a Price Item or Price Item Bundle with a Division on page 374

Defining a Division-Specific Characteristic for a Price Item or Price Item Bundle

Prerequisites

To define a division-specific characteristic for a price item or price item bundle, you should have:

- Characteristic types defined in the application (where the characteristic entity is set to **Division/Price Item Combination**)
- Price items or price item bundles associated with the division to which the user (i.e. who is performing this action) belongs

Procedure

To define a division-specific characteristic for a price item or price item bundle:

1. Click the **Divisions** or **Show All** link in the **Section** pane when you are defining, editing, or copying a price item or price item bundle.

The **Divisions** section appears.

2. Click the **Add** (➕) icon in the **Division Characteristics** column corresponding to the division for which you want to define division-specific price item or price item bundle characteristics.

The following fields appear in the grid:

Field Name	Field Description	Mandatory (Yes or No)
Effective Date	Used to specify the date from when the price item or price item bundle characteristic is effective for the division.	Yes (Conditional) Note: This field is required while defining a division-specific characteristic for the price item or price item bundle.
Characteristic Type	Used to indicate the characteristic type. Note: The list includes only those characteristic types where the characteristic entity is set to Division/Price Item Combination .	Yes (Conditional)

Field Name	Field Description	Mandatory (Yes or No)
		Note: This field is required while defining a division-specific characteristic for the price item or price item bundle.
Characteristic Value	Used to specify the value for the characteristic type.	Yes (Conditional)
	<p>Note:</p> <p>If you select a predefined characteristic type, the Search (🔍) icon appears corresponding to the Characteristic Value field. On clicking the Search icon, the Predefined Characteristic Search window appears.</p> <p>On specifying the value for a predefined characteristic type, the description of the characteristic value appears corresponding to the Characteristic Value field.</p>	Note: This field is required while defining a division-specific characteristic for the price item or price item bundle.

- Enter the required details in the **Divisions** section.
- If you want to define more than one division-specific characteristic for the price item or price item bundle, click the **Add** (+) icon and then repeat step 3.

Note: However, if you want to remove a division-specific characteristic from the price item or price item bundle, click the **Delete** (🗑️) icon corresponding to the characteristic.

- Click **Save**.

The division-specific characteristics are defined for the price item or price item bundle.

Related Topics

For more information on...	See...
How to define a price item or price item bundle	Defining a Price Item or Price Item Bundle on page 361
How to edit a price item or price item bundle	Editing a Price Item or Price Item Bundle on page 413
How to copy a price item or price item bundle	Copying a Price Item or Price Item Bundle on page 394
How to associate a price item or price item bundle with a division	Associating a Price Item or Price Item Bundle with a Division on page 374

Defining the Accrual Type Criteria of a Price Item or Price Item Bundle for a Division

Note: This topic is not applicable for the health insurance business.

The accrual type criteria of a price item or price item bundle is referred when the accrual is calculated for an account using an accrual type where the **Price Item Accrual Criteria Required** option is selected. The system behaves in the following manner when the **Price Item Accrual Criteria Required** option is selected in the accrual type:

If the accrual type criteria of a price item or price item bundle is set to...	Then...
Actual	The system considers the billable charges of the price item for accrual when the following conditions are met: <ul style="list-style-type: none"> • The price item is not excluded in the accrual type. • The accrual is calculated for an account using the accrual type where the accrual criteria is set to Actual.
Historical	The system considers the billable charges of the price item for accrual when the following conditions are met: <ul style="list-style-type: none"> • The price item is not excluded in the accrual type. • The accrual is calculated for an account using the accrual type where the accrual criteria is set to Historical.
Not Applicable	The system considers the billable charges of the price item for accrual when the following conditions are met: <ul style="list-style-type: none"> • The price item is not excluded in the accrual type • The accrual is calculated for an account using the accrual type where the accrual criteria is set to Actual or Historical.

The system enables you to define accrual type criteria of a price item or price item bundle for each division. For example, you can maintain different accrual type criteria of the Stop Payments (STPY) price item for each division as shown below:

The following table illustrates how you can define different accrual type criteria for a price item in each division:

Price Item	Division	Accrual Type Criteria
Stop Payments (STPY)	201-NJ	Actual
	209-CA	Historical
	210-FL	Not Applicable
	215-OX	Actual
	220-AL	Historical
	223-NJ	Not Applicable

Prerequisites

To define the accrual type criteria of a price item or price item bundle for a division, you should have:

- Price items or price item bundles associated with the division to which the user (i.e. who is performing this action) belongs

Procedure

To define the accrual type criteria of a price item or price item bundle for a division:

1. Click the **Divisions** or **Show All** link in the **Section** pane when you are defining, editing, or copying a price item or price item bundle.

The **Divisions** section appears.

- Click the **Add**  icon in the **Accrual Type Criteria** column corresponding to the division for which you want to define accrual type criteria of the price item or price item bundle.

The following field appears in a grid:

Field Name	Field Description	Mandatory (Yes or No)
Accrual Type Criteria	<p>Used to indicate whether the billable charges of the price item should be considered for accrual depending on the accrual criteria specified in the accrual type. The valid values are:</p> <ul style="list-style-type: none"> Actual - Used when you want the system to consider billable charges of the price item for accrual when the accrual criteria in the accrual type is set to Actual. Historical - Used when you want the system to consider billable charges of the price item for accrual when the accrual criteria in the accrual type is set to Historical. Not Applicable - Used when you want the system to consider billable charges of the price item for accrual when the accrual criteria in the accrual type is set to Actual or Historical. 	Yes (Conditional)
		Note: This field is required while defining the accrual type criteria of the price item or price item bundle for the division.
		Note: By default, the Not Applicable option is selected.

- Select the accrual type criteria from the respective field.
- Click **Save**.

The accrual type criteria of the price item or price item bundle is defined for the division.

Related Topics

For more information on...	See...
How to define a price item or price item bundle	Defining a Price Item or Price Item Bundle on page 361
How to edit a price item or price item bundle	Editing a Price Item or Price Item Bundle on page 413
How to copy a price item or price item bundle	Copying a Price Item or Price Item Bundle on page 394
How to associate a price item or price item bundle with a division	Associating a Price Item or Price Item Bundle with a Division on page 374

Associating a Price Item or Price Item Bundle with a Hierarchy Entity in an Entity Hierarchy Relationship of a Division

Note: This topic is not applicable for the health insurance business.

Once you design the structure of an entity hierarchy relationship, you can associate a price item or price item bundle with a hierarchy entity at any level in the entity hierarchy relationship. You can associate a price item or price item bundle with a hierarchy entity only from the **Price Item** screen. The system enables you to define division-specific hierarchy for a price item or price item bundle. Therefore, while associating a price item or price item bundle with a

hierarchy entity, you can select a hierarchy entity from any entity hierarchy relationship which is created for the division. However, the system checks whether the association date range is within the entity hierarchy relationship date range.

For example, you can associate the ACH Transfer (ACHTRN) price item with the Payments hierarchy entity in the Cash Management entity hierarchy relationship as shown below:

```
Cash Management
  Payments
    ACH Transfer
```

Associating a price item or price item bundle with a hierarchy entity does not have any impact on the billing module. At present, the price item hierarchy is only displayed in the Deal Modelling and Simulation module.

Prerequisites

To associate a price item or price item bundle with a hierarchy entity in an entity hierarchy relationship of a division, you should have:

- Entity hierarchy relationships defined for the required divisions
- Hierarchy entities included at the required levels in the entity hierarchy relationship
- Price items or price item bundles associated with the division to which the user (i.e. who is performing this action) belongs

Procedure

To associate a price item or price item bundle with a hierarchy entity in an entity hierarchy relationship of a division:

1. Click the **Divisions** or **Show All** link in the **Section** pane when you are defining, editing, or copying a price item or price item bundle.

The **Divisions** section appears.

2. Click the **Add**  icon in the **Entity Hierarchy** column corresponding to the division for which you want to define price item or price item bundle hierarchy.

The following fields appear in a grid:

Field Name	Field Description	Mandatory (Yes or No)
Hierarchy	Used to indicate the entity hierarchy relationship in which you want to include the price item or price item bundle.	Yes (Conditional)
	Note: The Search  icon appears corresponding to the Hierarchy field. On clicking the Search icon, the Hierarchy Search window appears.	Note: This field is required while associating the price item or price item bundle with a hierarchy entity in an entity hierarchy relationship of the division.
Parent Entity	Used to indicate the hierarchy entity to which you want to associate the price item or price item bundle.	Yes (Conditional)
	Note: The list appears when the entity hierarchy relationship is specified in the Hierarchy field. It contains the hierarchy entities which are included at the root and subsequent levels in the entity hierarchy relationship.	Note: This field is required while associating the price item or price item bundle with a hierarchy entity in an entity hierarchy relationship of the division.
Start Date	Used to specify the date from when the price item or price item bundle is associated with	Yes (Conditional)

Field Name	Field Description	Mandatory (Yes or No)
	<p>the hierarchy entity in the entity hierarchy relationship.</p> <p>Note: The start date cannot be later than the end date. The start date cannot be earlier than the entity hierarchy relationship start date.</p>	<p>Note: This field is required while associating the price item or price item bundle with a hierarchy entity in an entity hierarchy relationship of the division.</p>
End Date	<p>Used to specify the date till when the price item or price item bundle is associated with the hierarchy entity in the entity hierarchy relationship.</p> <p>Note: The end date cannot be earlier than the start date. The end date cannot be later than the entity hierarchy relationship end date.</p>	No

- Enter the required details in the **Entity Hierarchy** grid.
- If you want to associate the price item or price item bundle to more the one hierarchy entity in the same or different entity hierarchy relationship, click the **Add (+)** icon and then repeat step 3.

Note:

You cannot associate the price item or price item bundle to multiple hierarchy entities in the same or different entity hierarchy relationship for the same or overlapping date range.

However, if you want to disassociate the price item or price item bundle from a hierarchy entity of an entity hierarchy relationship, click the **Delete (X)** icon corresponding to the hierarchy and parent entity combination.

- Click **Save**.

The price item or price item bundle is associated with a hierarchy entity in an entity hierarchy relationship of the division.

Related Topics

For more information on...	See...
How to define a price item or price item bundle	Defining a Price Item or Price Item Bundle on page 361
How to edit a price item or price item bundle	Editing a Price Item or Price Item Bundle on page 413
How to copy a price item or price item bundle	Copying a Price Item or Price Item Bundle on page 394
How to associate a price item or price item bundle with a division	Associating a Price Item or Price Item Bundle with a Division on page 374

Defining the Cost of a Price Item or Price Item Bundle for a Division

Note: This topic is not applicable for the health insurance business.

Oracle Revenue Management and Billing enables you to maintain the different types of fixed and variable costs of a price item or price item bundle for each division. The system uses the fixed and variable cost information while calculating

the cost of a price item or price item bundle in a deal. It considers the cost which is defined for the division to which the account or person belongs. It derives the fixed and/or variable cost which is effective on the deal start date.

The system enables you to maintain the following types of costs in different currencies:

- Additional Fixed Cost
- Additional Variable Cost
- Fixed Third Party Cost
- Fixed Internal Cost
- Variable Internal Cost
- Variable Third Party Cost

While calculating the cost of a price item or price item bundle in a deal, the system converts the cost in the deal currency when the cost currency is different from the deal currency. As the name implies, the fixed cost is an expense that does not change with the increase or decrease in the price item volume or commitments. Therefore, the total fixed cost is equal to the sum of fixed cost which is effective on the deal start date for the division. However, the variable cost is an expense that change with the increase or decrease in the price item volume or commitments. Therefore, the total variable cost is equal to the sum of multiplication of variable cost (which is effective on the deal start date for the division) and price item volume or commitments.

Let us understand this with the help of an example:

The following table illustrates how you can define division-specific costs for a price item:

Price Item	Division	Cost Type	Cost Amount
PI1	201-NJ	Fixed Third Party Cost	\$5
		Fixed Internal Cost	\$3
		Additional Fixed Cost	\$1
		Variable Third Party Cost	\$0.1
		Variable Internal Cost	\$0.65
		Additional Variable Cost	\$0.5

If a deal is created for a person who belongs to the 201-NJ division and if the PI1 price item is assigned to the person in the deal and if the original volume and proposed commitment of the PI1 price item in the deal is set to 100 and 200, respectively, the system calculates the cost of the PI1 price item in the following manner:

The following table illustrates how the original and proposed cost is calculated for a price item in a deal:

Original Cost	
Total Fixed Cost	$\$5 + \$3 + \$1 = \9
Total Variable Cost	$(100 * \$0.1) + (100 * \$0.65) + (100 * \$0.5) = \$10 + \$65 + \$50 = \$125$
Total Cost	$\$9 + \$125 = \$134$
Proposed Cost	
Total Fixed Cost	$\$5 + \$3 + \$1 = \9

Total Variable Cost	$(200 * \$0.1) + (200 * \$0.65) + (200 * \$0.5) = \$20 + \$130 + \$100 = \$250$
Total Cost	$\$9 + \$250 = \$259$

Here, the assumption is the deal and cost currency is same (i.e. USD). The system then uses the total original and proposed costs for calculating the original and proposed profitability of the deal.

Prerequisites

To define the cost of a price item or price item bundle for a division, you should have:

- Currencies defined in the application
- Price items or price item bundles associated with the division to which the user (i.e. who is performing this action) belongs

Procedure

To define the cost of a price item or price item bundle for a division:

1. Click the **Divisions** or **Show All** link in the **Section** pane when you are defining, editing, or copying a price item or price item bundle.

The **Divisions** section appears.

2. Click the **Add**  icon in the **Costs** column corresponding to the division for which you want to define the costs of the price item or price item bundle.

The following fields appear in a grid:

Field Name	Field Description	Mandatory (Yes or No)
Effective Date	Used to specify the date from when the cost of the price item or price item bundle is effective for the division.	Yes (Conditional) Note: This field is required while defining the cost of the price item or price item bundle for the division.
Cost Type	Used to indicate the type of cost incurred in the division for the price item or price item bundle. The valid values are: <ul style="list-style-type: none"> • Additional Fixed Cost • Additional Variable Cost • Fixed Third Party Cost • Fixed Internal Cost • Variable Internal Cost • Variable Third Party Cost 	Yes (Conditional) Note: This field is required while defining the cost of the price item or price item bundle for the division.
Cost Value	Used to specify the cost amount.	Yes (Conditional) Note: This field is required while defining the cost of the price item or price item bundle for the division.

Field Name	Field Description	Mandatory (Yes or No)
Cost Currency	Used to specify the currency in which you want to define the cost. The system does currency conversion when the cost currency is different from the deal currency.	Yes (Conditional)
	Note: The list includes only those currencies which are already defined in the system.	Note: This field is required while defining the cost of the price item or price item bundle for the division.

- Enter the required details in the **Costs** grid.
- If you want to define more than one cost of the price item or price item bundle for the division, click the **Add (+)** icon and then repeat step 3.

Note: However, if you want to remove the cost of the price item or price item bundle from the division, click the **Delete (🗑)** icon corresponding to the cost.

- Click **Save**.

The cost of the price item or price item bundle is defined for the division.

Related Topics

For more information on...	See...
How to define a price item or price item bundle	Defining a Price Item or Price Item Bundle on page 361
How to edit a price item or price item bundle	Editing a Price Item or Price Item Bundle on page 413
How to copy a price item or price item bundle	Copying a Price Item or Price Item Bundle on page 394
How to associate a price item or price item bundle with a division	Associating a Price Item or Price Item Bundle with a Division on page 374

Defining the Average Price Floor and Ceil Values of a Price Item or Price Item Bundle for a Division

Note: This topic is not applicable for the health insurance business.

Oracle Revenue Management and Billing enables you to define the average price floor and ceil limits of a price item or price item bundle for each division. Before you define the average price floor and ceil limits, you need to specify the floor and ceiling type for the price item or price item bundle. At present, the system supports the following floor and ceiling types for a price item or price item bundle:

- Absolute Value Range

Once the floor and ceiling type of a price item or price item bundle is set to **Absolute Value Range**, you can define the average price floor and ceil limits of the price item or price item bundle for the required divisions. The system enables you to define different average price floor and ceil limits for different To Do roles. The system uses the average price floor and ceil limits while approving the average price of the price item or price item bundle in a deal. The deal creator or an approver at any level in the division or deal approval hierarchy can approve the average price of a price item or price item bundle when the average price is within the floor and ceil limits of the To Do role to which the deal creator or approver belongs. For example, if the average price of the P1 price item in a deal is \$25 and the floor and ceil limits of the deal creator's To Do role is set to \$10-\$15, then the deal creator cannot approve the average price of the P1 price item in the deal.

If the average price floor and ceil limits is not defined for the deal creator's or approver's To Do role, the status of the price item or price item bundle in the deal is changed to **Error**. If the average price floor and ceil limits is defined for the deal creator's or approver's To Do role, but the average price of the price item or price item bundle is not within the floor and ceil limits, the status of the price item or price item bundle in the deal is changed to **Pending for Approval**. However, if the average price floor and ceil limits is defined for the deal creator's or approver's To Do role and the

average price of the price item or price item bundle is within the floor and ceil limits, the status of the price item or price item bundle in the deal is changed to **Approved**.

Here, you can also define the average price floor and ceil limits for the price item manager's To Do role. Note that the price item manager can approve the average price of the price item or price item bundle in a deal when the average price of the price item or price item bundle is within the floor and ceil limits of the price item manager's To Do role.

- Spread Amount

Once the average price floor and ceil type of a price item or price item bundle is set to **Spread Amount**, the system calculates the average price floor and ceil limits based on the average price and spread amount. The system calculates the average price of the price item or price item bundle. The system searches for the eligible price list in the price assignments assigned to the To Do roles. If a flat pricing is defined in the price assignment, then the system sets the average price to the flat rate. However, if a tiered pricing is defined in the price assignment, the system calculates the average price using the following formula:

$$\text{Average Price} = \text{Price Item Revenue} / \text{Price Item Commitments}$$

The system then considers the spread amount specified for the relationship manager's To Do role in the price item. Using the spread amount and average price, the system calculates the average price floor and ceil limit values. The deal creator or an approver at any level in the division or deal approval hierarchy can approve the average price of a price item or price item bundle when the average price is within the floor and ceil limits of the To Do role to which the deal creator or approver belongs. For example, if the spread amount set by you is 10 and the system calculated average price of the P1 price item in a deal is \$25 then the system sets the floor and ceil limits of the deal creator's To Do role to \$15-\$35. In this case the deal creator can approve the average price of the P1 price item in the deal.

The system then checks whether the average price of the price item in the deal is within the derived average price floor and ceil limits. If so, the system changes the status of the price item to **Approved**. However, if the average price of the price item in the deal is not within the derived average price floor and ceil limits, the status of the price item remains as **Pending for Approval**.

- Spread Percentage

Once the average price floor and ceil type of a price item is set to the **Spread Percentage**, the system calculates the average price floor and ceil limits based on the average price and spread percentage. The system calculates the average price of the price item or price item bundle. The system searches for the eligible price list in the price assignments assigned to the To Do roles. If a flat pricing is defined in the price assignment, then the system sets the average price to the flat rate. However, if a tiered pricing is defined in the price assignment, the system calculates the average price using the following formula:

$$\text{Average Price} = \text{Price Item Revenue} / \text{Price Item Commitments}$$

The system then considers the spread percentage specified for the relationship manager's To Do role in the price item. Using the spread percentage and average price, the system calculates the average price floor and ceil values. The deal creator or an approver at any level in the division or approver system then checks whether the average price of the price item in the deal is within the derived average price floor and ceil limits of the To Do role to which the deal creator or approver belongs. For example, if the spread percentage set by you is 10 and the system calculated average price of the P1 price item in a deal is \$50 then the system sets the floor and ceil limits of the deal creator's To Do role to \$45-\$55. In this case the deal creator can approve the average price of the P1 price item in the deal.

The system then checks whether the average price of the price item in the deal is within the derived average price floor and ceil limits. If so, the system changes the status of the price item to **Approved**. However, if the average price of the price item in the deal is not within the derived average price floor and ceil limits, the status of the price item remains as **Pending for Approval**.

Prerequisites

To define the average price floor and ceil limits of a price item or price item bundle for a division, you should have:

- To Do roles and currencies defined in the application
- Price items or price item bundles associated with the division to which the user (i.e. who is performing this action) belongs

Procedure

To define the average price floor and ceil limits of a price item or price item bundle for a division:

1. Click the **Divisions** or **Show All** link in the **Section** pane when you are defining, editing, or copying a price item or price item bundle.

The **Divisions** section appears.

2. Click the **Add**  icon in the **Average Price Floor and Ceil Limits** column corresponding to the division for which you want to define the average price floor and ceil limits of the price item or price item bundle.

The following fields appear in a grid:

Field Name	Field Description	Mandatory (Yes or No)
To Do Role	Used to indicate that users with the specified To Do role can approve the average price of the price item or price item bundle in a deal when it is within the specified floor and ceil limits.	Yes (Conditional)
	<p>Note:</p> <p>The Search  icon appears corresponding to the To Do Role field. On clicking the Search icon, the To Do Role Search window appears.</p> <p>On specifying the To Do role, the description of the To Do role appears corresponding to the To Do Role field.</p>	<p>Note: This field is required while defining the average price floor and ceil limits of the price item or price item bundle for the division.</p>
Floor Value	Used to specify the floor (i.e. lower) limit for the To Do role. The users who belong to the To Do role cannot approve the average price of the price item or price item bundle when it is below the floor limit.	Yes (Conditional)
	<p>Note: The floor value cannot be greater than the ceil value.</p>	<p>Note: This field is required while defining the average price floor and ceil limits of the price item or price item bundle for the division.</p>
Ceil Value	Used to specify the ceil (i.e. upper) limit for the To Do role. The users who belong to the To Do role cannot approve the average price of the price item or price item bundle when it is above the ceil limit.	Yes (Conditional)
	<p>Note: The ceil value cannot be lower than the floor value.</p>	<p>Note: This field is required while defining the average price floor and ceil limits of the price item or price item bundle for the division.</p>
Spread Amount	Used to specify the spread amount specified while defining a price item or price item bundle or assigned to a To Do role.	Yes (Conditional)
	<p>Note: This column appears when you select the Spread Amount option from the Average Price Floor and Ceil Type list for a price item or price item bundle.</p>	<p>Note: This field is required while defining the average price floor and ceil limits of the price item or price item bundle for the division.</p>

Field Name	Field Description	Mandatory (Yes or No)
Spread Percentage	Used to specify the spread percentage specified while defining a price item or price item bundle or assigned to a To Do role.	Yes (Conditional)
	Note: This column appears only when you select the Spread Percentage option from the Average Price Floor and Ceil Type list for a price item or price item bundle.	Note: This field is required while defining the average price floor and ceil limits of the price item or price item bundle for the division.
Floor and Ceil Currency	Used to indicate the currency in which you want to define the floor and ceil limits. The system does the currency conversion when the pricing currency is different from the floor and ceil currency.	Yes (Conditional)
	Note: The list includes only those currencies which are already defined in the system.	Note: This field is required while defining the average price floor and ceil limits of the price item or price item bundle for the division.

- Enter the required details in the **Average Price Floor and Ceil Limits** grid.
- If you want to define the average price floor and ceil limits for more than one To Do role, click the **Add (+)** icon and then repeat step 3.

Note: However, if you want to remove the average price floor and ceil limits of a To Do role from the division, click the **Delete** (🗑️) icon corresponding to the To Do role.

- Click **Save**.

The average price floor and ceil limits of the price item or price item bundle are defined for the division.

Related Topics

For more information on...	See...
How to define a price item or price item bundle	Defining a Price Item or Price Item Bundle on page 361
How to edit a price item or price item bundle	Editing a Price Item or Price Item Bundle on page 413
How to copy a price item or price item bundle	Copying a Price Item or Price Item Bundle on page 394
How to associate a price item or price item bundle with a division	Associating a Price Item or Price Item Bundle with a Division on page 374

Defining the Rate Negotiability Floor and Ceil Values of a Price Item or Price Item Bundle for a Division

Note: This topic is not applicable for the health insurance business.

Oracle Revenue Management and Billing enables you to indicate whether the rate is negotiable for a price item or price item bundle for each division. If you wish to enable the rate negotiability, you need to define the negotiability floor and ceil limits for a division of a price item at the price item level or at the price assignment level. You can set different negotiability criteria for the divisions with which the price item is associated. If the rate negotiability feature is configured for a price item, the system enables:

- The relationship manager to propose a negotiated rate for the price item
- The product level approver, division level approver, and deal level approver to recommend a rate for the price item

In order to indicate whether the rate is negotiable or not, the **Rate Negotiability** field is introduced in the system. On enabling this field, the system allows you to edit or override rate of the deal. Once the negotiability option is set, you need to specify the rate negotiability floor and ceil limits for a price item or price item bundle.

Once the floor and ceil limits are defined, you can also choose to validate whether the negotiated rate is within the range of negotiability floor and ceil limits or not. To implement this, the **Negotiate Rate Only within Range** field is introduced. If this field is enabled, the system validates the negotiated rate is within the specified range or not. However, you can disable this validation as well. If the negotiated rate is found to be within the specified negotiability floor and ceil limits, the system allows you to edit or override the rate of a price item in a deal. However, if the negotiated rate is not within the negotiability floor and ceil limits then an error occurs indicating the negotiability rate is not within the specified negotiability floor and ceil limits.

Once you enable the rate negotiability option for a division of a price item, you can edit or override the rate of a price item in a deal when the customer or account to which the price item is assigned belongs to the division. If you disable the rate negotiability option, you cannot edit or override the rate of a price item in a deal when the customer or account to which the price item is assigned belongs to the division.

Prerequisites

To define the rate negotiability floor and ceil limits of a price item or price item bundle for a division, you should have:

- Currencies defined in the application
- Price items or price item bundles associated with the division to which the user (i.e. who is performing this action) belongs

Procedure

To define the rate negotiability floor and ceil limits of a price item or price item bundle for a division:

1. Click the **Divisions** or **Show All** link in the **Section** pane when you are defining, editing, or copying a price item or price item bundle.

The **Divisions** section appears.

2. Click the **Add**  icon in the **Rate Negotiability** column corresponding to the division for which you want to define the rate negotiability floor and ceil limits of the price item or price item bundle.

The following fields appear in a grid:

Field Name	Field Description	Mandatory (Yes or No)
Rate Negotiability	Used to specify whether the rate is negotiable for a price item or not. The valid values are: <ul style="list-style-type: none"> • Yes • No If you select yes option then you can edit or override the rate of a price item or price item bundle in a deal when the customer or account to which is the price item is assigned belongs to the division otherwise not.	No
Negotiate Rate Only Within Range	Used to validate whether the negotiated rate is within the floor and ceil limits or not. The valid values are: <ul style="list-style-type: none"> • Yes • No 	No

Field Name	Field Description	Mandatory (Yes or No)
	Note: This field is enabled when you select Yes option for the Rate Negotiability field.	
Floor Value	Used to specify the floor (i.e. lower) limit for the rate negotiation. Note: The floor value cannot be greater than the ceil value.	No
Ceil Value	Used to specify the ceil (i.e. upper) limit for the rate negotiation. Note: The ceil value cannot be lower than the floor value.	No
Floor and Ceil Currency	Used to indicate the currency in which you want to define the rate negotiability floor and ceil limits. The system does the currency conversion when the pricing currency is different from the floor and ceil currency. Note: The list includes only those currencies which are already defined in the system.	No

- Enter the required details in the **Rate Negotiability** grid.
- If you want to define more than one rate negotiability floor and ceil value of a price item or price item bundle for the division, click the **Add (+)** icon and then repeat step 3.

Note: However, if you want to remove the rate negotiability floor and ceil value of a price item or price item bundle from the division, click the **Delete (🗑)** icon corresponding to the To Do role.

- Click **Save**.

The rate negotiability floor and ceil limits of the price item or price item bundle are defined for the division.

Related Topics

For more information on...	See...
How to define a price item or price item bundle	Defining a Price Item or Price Item Bundle on page 361
How to edit a price item or price item bundle	Editing a Price Item or Price Item Bundle on page 413
How to copy a price item or price item bundle	Copying a Price Item or Price Item Bundle on page 394
How to associate a price item or price item bundle with a division	Associating a Price Item or Price Item Bundle with a Division on page 374

Defining a Characteristic for a Price Item or Price Item Bundle

Prerequisites

To define a characteristic for a price item or price item bundle, you should have:

- Characteristic types defined in the application (where the characteristic entity is set to **Price Item**)

Procedure

To define a characteristic for a price item or price item bundle:

1. Click the **Price Item Characteristics** or **Show All** link in the **Section** pane when you are defining, editing, or copying a price item or price item bundle.

The **Price Item Characteristics** section appears. It contains the following fields in a grid:

Field Name	Field Description	Mandatory (Yes or No)
Effective Date	Used to specify the date from when the characteristic is effective for the price item or price item bundle.	Yes (Conditional) Note: This field is required while defining a characteristic for the price item or price item bundle.
Characteristic Type	Used to indicate the characteristic type. Note: The list includes only those characteristic types where the characteristic entity is set to Price Item .	Yes (Conditional) Note: This field is required while defining a characteristic for the price item or price item bundle.
Characteristic Value	Used to specify the value for the characteristic type. Note: If you select a predefined characteristic type, the Search (🔍) icon appears corresponding to the Characteristic Value field. On clicking the Search icon, the Predefined Characteristic Search window appears. On specifying the value for a predefined characteristic type, the description of the characteristic value appears corresponding to the Characteristic Value field.	Yes (Conditional) Note: This field is required while defining a characteristic for the price item or price item bundle.

2. Enter the required details in the **Price Item Characteristics** section.
3. If you want to define more than one characteristic for the price item or price item bundle, click the **Add** (+) icon and then repeat step 2.

Note: However, if you want to remove a characteristic from the price item or price item bundle, click the **Delete** (🗑️) icon corresponding to the characteristic.

4. Click **Save**.

The characteristics are defined for the price item or price item bundle.

Related Topics

For more information on...	See...
How to define a price item or price item bundle	Defining a Price Item or Price Item Bundle on page 361
How to edit a price item or price item bundle	Editing a Price Item or Price Item Bundle on page 413
How to copy a price item or price item bundle	Copying a Price Item or Price Item Bundle on page 394

Copying a Price Item or Price Item Bundle

Instead of creating a price item or price item bundle from scratch, you can create a new price item or price item bundle using an existing price item or price item bundle. This is possible through copying a price item or price item bundle. On copying a price item or price item bundle, the details including the following are copied to the new price item or price item bundle:

- Parameters and Divisions associated with the price item or price item bundle
- SQIs associated with the price item or price item bundle for the divisions
- Division-specific characteristics of the price item or price item bundle
- Accrual type criteria of the price item or price item bundle for the divisions
- Hierarchy entity to which the price item or price item bundle is associated in the divisions
- Cost of the price item or price item bundle for the divisions
- Average price floor and ceil limits of the price item or price item bundle for the divisions
- Negotiability floor and ceil values of the price item or price item bundle for the required divisions

You can then edit the details, if required.

Prerequisites

To copy a price item or price item bundle, you should have:

- Price item or price item bundle (whose copy you want to create) defined in the application
- Price item or price item bundle (whose copy you want to create) associated with the division to which the user (i.e. who is performing this action) belongs
- Contract types, To Do types, and To Do roles defined in the application
- To Do roles associated with the required To Do type
- Value defined for the **Default Contract Type** option type in the **C1_PRICING** feature configuration

Procedure

To copy a price item or price item bundle:

1. Search for the price item or price item bundle in the **Price Item** screen.
2. In the **Search Results** section, click the **Duplicate**  icon in the **Duplicate** column corresponding to the price item or price item bundle whose copy you want to create.

The **Price Item** screen appears. It contains the following sections:

- **Main** - Used to specify basic details about the price item or price item bundle.
- **Parameters** - Used to associate a parameter with the price item or price item bundle. These associated parameters are then used for aggregating transactions and/or for defining the price item pricing.

Note:

The **Parameters** section appears in the **Price Item** screen when the **Multi Price Parameter** option type of the **C1_PPARM_FLG** feature configuration is set to **True**.

You cannot associate parameters to the ratio and phantom price item bundles. Therefore, while defining a ratio or phantom price item bundle, the **Parameters** section does not appear in the **Price Item** screen.

- **Divisions** - Used to associate the price item or price item bundle with one or more divisions. In addition, it enables you to:
 - Associate the service quantity identifiers (SQIs) with the price item or price item bundle for a division

- Define the accrual type criteria of the price item or price item bundle for a division

Note: This step is not applicable for the health insurance business.

- Associate the price item or price item bundle with a hierarchy entity in an entity hierarchy relationship of a division

Note: This step is not applicable for the health insurance business.

- Define the cost of the price item or price item bundle for a division

Note: This step is not applicable for the health insurance business.

- Define the average price floor and ceil limits of the price item or price item bundle for a division

Note: This step is not applicable for the health insurance business.

- Define the negotiability floor and ceil values of the price item or price item bundle for a division

Note: This step is not applicable for the health insurance business.

- Define the division-specific characteristics for the price item or price item bundle
- **Price Item Characteristics** - Used to define characteristics (which are applicable across divisions) for the price item or price item bundle.

The **Main** section contains the following fields:

Field Name	Field Description	Mandatory (Yes or No)
Price Item	Used to specify the price item or price item bundle.	Yes
Description	Used to specify the description for the price item or price item bundle.	Yes
Price Item Usage	<p>Used to indicate whether the price item or price item bundle is available for pricing or pricing and billing. The valid values are:</p> <ul style="list-style-type: none"> • Pricing - Used when you want to define pricing for the price item or price item bundle, but no charges should be created against it in the system. <p>Note: This option is not applicable for the health insurance business.</p> <ul style="list-style-type: none"> • Pricing and Billing - Used when you want to define pricing and create charges for the price item or price item bundle in the system. 	Yes
Price Item Type	<p>Used to indicate the type of the price item or price item bundle. The valid values are:</p> <ul style="list-style-type: none"> • Rate - Used when you want to create a rate based price item or price item bundle. For example, savings, current, and loan interest services (i.e. price items) are rate based price items. 	Yes

Field Name	Field Description	Mandatory (Yes or No)
	<div data-bbox="703 212 1153 275" style="border: 1px solid black; padding: 2px;"> <p>Note: This option is not applicable for the health insurance business.</p> </div> <ul style="list-style-type: none"> • Fees - Used when you want to create a fee based price item or price item bundle. For example, debit credit service (i.e. price item) is a fee based price item. <div data-bbox="643 453 1153 936" style="border: 1px solid black; padding: 2px;"> <p>Note: This field appears when the Pricing option is selected from the Price Item Usage list. You cannot create a price item bundle when the Pricing option is selected from the Price Item Usage list and Rate option is selected from the Price Item Type list. The system automatically sets the price item type of those price items or price item bundles which are available for pricing and billing to Fees. Therefore, this field does not appear when the Pricing and Billing option is selected from the Price Item Usage list.</p> </div>	
Bundle	<p>Used to indicate whether you want to create a price item bundle. The valid values are:</p> <ul style="list-style-type: none"> • Yes • No <div data-bbox="643 1167 1153 1245" style="border: 1px solid black; padding: 2px;"> <p>Note: This field is not applicable for the health insurance business.</p> </div>	Yes
Bundle Type	<p>Used to indicate the type of the price item bundle. If the Pricing and Billing option is selected from the Price Item Usage list, the valid values are:</p> <ul style="list-style-type: none"> • <i>Regular Bundle</i> on page 287 • <i>Phantom Bundle</i> on page 291 • <i>Ratio Bundle</i> on page 288 <p>However, if the Pricing option is selected from the Price Item Usage list and the Fees option is selected from the Price Item Type list, you can only define a regular price item bundle. Therefore, by default, the value is set to Regular.</p>	<p>Yes (Conditional)</p> <div data-bbox="1170 1329 1468 1434" style="border: 1px solid black; padding: 2px;"> <p>Note: This field is required when you are creating a price item bundle.</p> </div>

Field Name	Field Description	Mandatory (Yes or No)
	<p>Note:</p> <p>This field appears when the Yes option is selected from the Bundle list.</p> <p>This field is enabled when the Pricing and Billing option is selected from the Price Item Usage list and the Yes option is selected from the Bundle list.</p> <p>You cannot define a price item bundle when the Pricing option is selected from the Price Item Usage list and Rate option is selected from the Price Item Type list.</p> <p>This field is not applicable for the health insurance business.</p>	
Global Price List	<p>Used to indicate whether the price item or price item bundle can be assigned to a global price list. The valid values are:</p> <ul style="list-style-type: none"> • Yes • No 	Yes
Contract Type	<p>Used to indicate the contract type that you want to associate with the price item or price item bundle.</p> <p>Note:</p> <p>This field appears when the Pricing and Billing option is selected from the Price Item Usage list.</p> <p>The Search (🔍) icon appears corresponding to the Contract Type field. On clicking the Search icon, the Contract Type Search window appears.</p>	Yes
Price Item Manager To Do Type	<p>Used to indicate the To Do type using which a To Do should be created when the deal creator or approver requests the price item manager (i.e. clicks the Send Price Items for Approval button) to approve the average price for the price item or price item bundle offered in a deal.</p>	No

Field Name	Field Description	Mandatory (Yes or No)
	<p>Note:</p> <p>The Search (🔍) icon appears corresponding to the Price Item Manager To Do Type field. On clicking the Search icon, the To Do Type Search window appears.</p> <p>On specifying the To Do type, the description of the To Do type appears corresponding to the Price Item Manager To Do Type field.</p> <p>This field is not applicable for the health insurance business.</p>	
Price Item Manager To Do Role	<p>Used to indicate that users with the specified To Do role can approve the average price for the price item or price item bundle offered in a deal. Note that the price item manager can approve the average price when it is within the average price floor and ceil limits defined for the To Do role.</p>	<p>Yes (Conditional)</p> <p>Note: This field is required when the price item manager To Do type is specified for the price item or price item bundle.</p>
	<p>Note:</p> <p>The list appears when the price item manager To Do type is selected from the respective field. It includes only those To Do roles which are associated with the price item manager To Do type.</p> <p>This field is not applicable for the health insurance business.</p>	
Floor and Ceiling Type	<p>Used to indicate the manner in which you want to define the average price floor and ceil limits for the price item or price item bundle. The valid value is:</p> <ul style="list-style-type: none"> • Absolute Value Range - Used when you want to define the average price floor and ceil limits in the absolute values. For example, the average price for the price item or price item bundle should be between 10\$ to 15\$. • Spread Amount - Used when you want to define the average floor and ceil limits based on the spread amount. • Spread Percentage – Used when you want to define the average floor and ceil limits based on the spread percentage. 	<p>Yes (Conditional)</p> <p>Note: This field is required when you are defining the average price floor and ceil limits of the price item or price item bundle for a division.</p>

Field Name	Field Description	Mandatory (Yes or No)
	<p>Note:</p> <ul style="list-style-type: none"> Incase of Spread Amount and Spread Percentage options, the system calculates the average price of a price item and based on the average price and the spread amount or spread percentage, the average floor and ceil limits are derived. This field is not applicable for the health insurance business. 	
Sort Sequence	Used to specify the sequence in which the price item should appear in the price item hierarchy of the deal management module.	No
Variable Price	<p>Used to indicate whether the system inherits the pricing of the price item from the price list while orchestrating a deal in the deal management module.</p> <p>Note:</p> <p>If the Variable Price option is selected, the pricing offered for a price item to an entity in the deal is overridden when the price list pricing is changed after orchestrating the deal in the system.</p> <p>However, if the Variable Price option is not selected, the pricing offered for a price item to an entity in the deal is not overridden when the price list pricing is changed in the system. This enables the relationship manager to create deals for an existing customers, accounts, and prospects where the pricing of the price items are fixed for a particular timeframe.</p>	No

- Enter the required details in the **Main** section.
- Associate, edit, or disassociate parameters from the price item or price item bundle, if required.

Note: For each predefined parameter which is associated with the price item or price item bundle, you can define a set of valid predefined parameter values for the price item or price item bundle, if required.

- Associate or disassociate the price item or price item bundle from the required divisions.
- Associate or disassociate the SQIs from the price item or price item bundle for the required divisions.
- Define, edit, or remove the accrual type criteria of the price item or price item bundle from the required divisions.

Note: This step is not applicable for the health insurance business.

- Associate or disassociate the price item or price item bundle from a hierarchy entity in an entity hierarchy relationship of the required divisions.

Note: This step is not applicable for the health insurance business.

9. Define, edit, or remove the cost of the price item or price item bundle from the required divisions.

Note: This step is not applicable for the health insurance business.

10. Define, edit, or remove the average price floor and ceil limits of the price item or price item bundle from the required divisions.

Note: This step is not applicable for the health insurance business.

11. Define, edit or remove the negotiability floor and ceil values of the price item or price item bundle for the required divisions.

Note: This step is not applicable for the health insurance business.

12. Define, edit, or remove the division-specific characteristics from the price item or price item bundle. if required.

13. Define, edit, or remove characteristics of the price item or price item bundle, if required.

14. Click **Save**.

The new price item is defined.

Note:

While creating a price item or price item bundle which is available for pricing, the contract type specified in the **Default Contract Type** option type of the **C1_PRICING** feature configuration is automatically associated to the price item or price item bundle.

The system allows you to add a price item to the new price item bundle when:

- Price item and price item bundle (whose copy you are creating) are associated to the same contract type.
- Price item is associated with the division to which the price item bundle (whose copy you are creating) is associated.
- Another price item bundle with the same price item, relationship type, and date range combination does not exist in the system.

Related Topics

For more information on...	See...
How to search for a price item or price item bundle	Searching for a Price Item or Price Item Bundle on page 361
How to associate a parameter with a price item or price item bundle	Associating a Parameter with a Price Item or Price Item Bundle on page 369
How to associate a price item or price item bundle with a division	Associating a Price Item or Price Item Bundle with a Division on page 374
How to associate an SQI with a price item or price item bundle for a division	Associating an SQI with a Price Item or Price Item Bundle for a Division on page 377
How to define the accrual type criteria of a price item or price item bundle for a division	Defining the Accrual Type Criteria of a Price Item or Price Item Bundle for a Division on page 380
How to associate a price item or price item bundle with a hierarchy entity in an entity hierarchy relationship of a division	Associating a Price Item or Price Item Bundle with a Hierarchy Entity in an Entity Hierarchy Relationship of a Division on page 382
How to define the cost of a price item or price item bundle for a division	Defining the Cost of a Price Item or Price Item Bundle for a Division on page 384

For more information on...	See...
How to define the average price floor and ceil limits of a price item or price item bundle for a division	Defining the Average Price Floor and Ceil Values of a Price Item or Price Item Bundle for a Division on page 387
How to define the rate negotiability floor and ceil values of a price item or a price item bundle for a division	Defining the Rate Negotiability Floor and Ceil Values of a Price Item or Price Item Bundle for a Division on page 390
How to define a division-specific characteristic for a price item or price item bundle	Defining a Division-Specific Characteristic for a Price Item or Price Item Bundle on page 379
How to define a characteristic for a price item or price item bundle	Defining a Characteristic for a Price Item or Price Item Bundle on page 392
How to set the C1_PRICING feature configuration	Setting the C1_PRICING Feature Configuration on page 4342

Viewing the Price Item or Price Item Bundle Details

Procedure

To view the details of a price item or price item bundle:

1. Search for the price item or price item bundle in the **Price Item** screen.
2. In the **Search Results** section, click the link in the **Price Item Information** column corresponding to the price item or price item bundle whose details you want to view.

The **Price Item** screen appears. It contains the following zones:

- [Price Item](#) on page 403
 - [Price Item Characteristics](#) on page 405
 - [Parameters](#) on page 405
 - [Predefined Parameter Values for Price Item](#) on page 406
 - [Divisions](#) on page 406
 - [Division-Specific SQIs for Price Item](#) on page 407
 - [Division-Specific Characteristics for Price Item](#) on page 407
 - [Division-Specific Accrual Type Criteria for Price Item](#) on page 408
 - [Division-Specific Hierarchy for Price Item](#) on page 408
 - [Division-Specific Cost for Price Item](#) on page 410
 - [Division-Specific Average Price Floor and Ceil Values for Price Item](#) on page 411
 - [Division-Specific Negotiability Floor and Ceil Values for Price Item](#) on page 409
 - [Price Item Relationship](#) on page 412
3. View the basic details of the price item or price item bundle in the **Price Item** zone.
 4. View the characteristics of the price item or price item bundle in the **Price Item Characteristics** zone.
 5. View the parameters associated with the price item or price item bundle in the **Parameters** zone.
 6. View the valid predefined parameter values of the price item or price item bundle in the **Predefined Parameter Values for Price Item** zone.
 7. View the divisions to which the price item or price item bundle is associated in the **Divisions** zone.

8. View the SQIs associated with the price item or price item bundle for a division in the **Division-Specific SQIs for Price Item** zone.
9. View the division-specific characteristics of the price item or price item bundle in the **Division-Specific Characteristics for Price Item** zone.
10. View the accrual type criteria of the price item or price item bundle for a division in the **Division-Specific Accrual Type Criteria for Price Item** zone.

Note: This step is not applicable for the health insurance business.

11. View the hierarchy entity to which the price item or price item bundle is associated in a division in the **Division-Specific Hierarchy for Price Item** zone.

Note: This step is not applicable for the health insurance business.

12. View the cost of the price item or price item bundle for a division in the **Division-Specific Cost for Price Item** zone.

Note: This step is not applicable for the health insurance business.

13. View the average price floor and ceil limits of the price item or price item bundle for a division in the **Division-Specific Floor and Ceil Values for Price Item** zone.

Note: This step is not applicable for the health insurance business.

14. View the negotiability floor and ceil values of the price item or price item bundle for a division in the **Division-Specific Negotiability Floor and Ceil Values for Price Item** zone.

Note: This step is not applicable for the health insurance business.

15. View the price items or price item bundles related to the parent price item or price item bundle in the **Price Item Relationship** zone.

Note: This step is not applicable for the health insurance business.

Related Topics

For more information on...	See...
How to search for a price item or price item bundle	Searching for a Price Item or Price Item Bundle on page 361
Price Item screen	Price Item (Used for Viewing) on page 402

Price Item (Used for Viewing)

The **Price Item** screen allows you to view the details of the price item or price item bundle. It also allows you to edit the details of the price item or price item bundle. It contains the following zones:

- [Price Item](#) on page 403
- [Price Item Characteristics](#) on page 405
- [Parameters](#) on page 405
- [Predefined Parameter Values for Price Item](#) on page 406
- [Divisions](#) on page 406
- [Division-Specific SQIs for Price Item](#) on page 407
- [Division-Specific Characteristics for Price Item](#) on page 407

- [Division-Specific Accrual Type Criteria for Price Item](#) on page 408
- [Division-Specific Hierarchy for Price Item](#) on page 408
- [Division-Specific Negotiability Floor and Ceil Values for Price Item](#) on page 409
- [Division-Specific Cost for Price Item](#) on page 410
- [Division-Specific Average Price Floor and Ceil Values for Price Item](#) on page 411
- [Price Item Relationship](#) on page 412

Price Item

The **Price Item** zone displays the details of the price item or price item bundle. It contains the following sections:

- **Main** – Displays basic information about the price item or price item bundle. It contains the following fields:

Field Name	Field Description
Price Item	Displays the price item or price item bundle.
Description	Displays the description of the price item or price item bundle.
Price Item Usage	Indicates whether the price item or price item bundle is available for pricing or pricing and billing. The valid values are: <ul style="list-style-type: none"> • Pricing • Pricing and Billing
Price Item Type	Indicates the type of the price item or price item bundle. The valid values are: <ul style="list-style-type: none"> • Rate • Fees
	Note: This field appears when the Pricing option is selected from the Price Item Usage list.
Bundle	Indicates whether the price item is a bundle. The valid values are: <ul style="list-style-type: none"> • Yes • No
Bundle Type	Indicates the type of the price item bundle. The valid values are: <ul style="list-style-type: none"> • Phantom • Ratio • Regular
	Note: This field appears when the Yes option is selected from the Bundle list.
Global Price List	Indicates whether the price item or price item bundle can be assigned to a global price list. The valid values are: <ul style="list-style-type: none"> • Yes • No
Contract Type	Displays the contract type to which the price item or price item bundle is associated.

Field Name	Field Description
Price Item Manager To Do Type	<p>Indicates the To Do type using which a To Do should be created when the deal creator or approver requests the price item manager (i.e. clicks the Send Price Items for Approval button) to approve the average price for the price item or price item bundle offered in a deal.</p> <p>Note: It has a link. On clicking the link, the To Do Type screen appears where you can view the details of the respective To Do type.</p>
Price Item Manager To Do Role	<p>Indicates that users with the specified To Do role can approve the average price of the price item or price item bundle offered in a deal. Note that the price item manager can approve the average price when it is within the average price floor and ceil limits of the To Do role.</p> <p>Note: It has a link. On clicking the link, the To Do Role screen appears where you can view the details of the respective To Do role.</p>
Average Price Floor and Ceil Type	<p>Indicates the manner in which you want to define the average price floor and ceil limits of the price item or price item bundle. The valid values are:</p> <ul style="list-style-type: none"> • Absolute Value Range • Spread Amount • Spread Percentage
Sort Sequence	Displays the sequence in which the price item appears in the price item hierarchy of the deal management module.
Variable Price	<p>Indicates whether the system inherits the pricing of the price item from the price list while orchestrating a deal in the deal management module.</p> <p>Note:</p> <p>If the Variable Price option is selected, the pricing offered for a price item to an entity in the deal is overridden when the price list pricing is changed after orchestrating the deal in the system.</p> <p>However, if the Variable Price option is not selected, the pricing offered for a price item to an entity in the deal is not overridden when the price list pricing is changed in the system. This enables the relationship manager to create deals for an existing customers, accounts, and prospects where the pricing of the price items are fixed for a particular timeframe.</p>

- **Record Actions** – The **Record Actions** section contains the following button:

Button Name	Button Description
Edit	Used to edit the details of the price item or price item bundle.

- **Record Information** – The **Record Information** section contains the following field:

Field Name	Field Description
Business Object	Indicates the business object using which the price item or price item bundle is created in the system. In addition, a context menu appears corresponding to this field which helps in navigating to other screens in the application.

Field Name	Field Description
	Note: It has a link. On clicking the link, the Business Object screen appears where you can view the details of the respective business object.

Related Topics

For more information on...	See...
Price Item screen	Price Item (Used for Viewing) on page 402
How to edit a price item or price item bundle	Editing a Price Item or Price Item Bundle on page 413

Price Item Characteristics

The **Price Item Characteristics** zone lists the characteristics of the price item or the price item bundle. It contains the following columns:

Column Name	Column Description
Effective Date	Displays the date from when the characteristic is effective for the price item or price item bundle.
Characteristic Type	Indicates the characteristic type.
Characteristic Value	Displays the value of the characteristic type.
Description	Displays the description of the characteristic.

Related Topics

For more information on...	See...
Price Item screen	Price Item (Used for Viewing) on page 402

Parameters

The **Parameters** zone lists the parameters which are associated with the price item or price item bundle. It contains the following columns:

Column Name	Column Description
Effective Start Date	Displays the date from when the parameter is associated with the price item or price item bundle.
Effective End Date	Displays the date till when the parameter is associated with the price item or price item bundle.
Parameter	Indicates the parameter which is associated with the price item or price item bundle. Note: It has a link. On clicking the link, the Parameter screen appears where you can view the details of the respective parameter.
Business Label	Displays the business label of the parameter.
Display Order	Indicates the order in which the parameter and its value should appear in the pricing parameter information string across the application.
Parameter Usage	Indicates whether you can use the parameter for aggregation and/or for defining the price item pricing. The valid values are:

Column Name	Column Description
	<ul style="list-style-type: none"> • Aggregation • Pricing
Mandatory	Indicates whether the parameter is mandatory while defining the price item pricing.
Priority	Indicates the priority in which optional parameters should be considered while determining best fit price for the price item or price item bundle.

On clicking the **Broadcast** (📡) icon corresponding to a parameter, the **Predefined Parameter Values for Price Item** zone appears where you can view the valid predefined parameter values of the price item or price item bundle.

Related Topics

For more information on...	See...
Price Item screen	Price Item (Used for Viewing) on page 402
Predefined Parameter Values for Price Item zone	Predefined Parameter Values for Price Item on page 406

Predefined Parameter Values for Price Item

The **Predefined Parameter Values for Price Item** zone lists the predefined parameter values which are valid for the price item or price item bundle. It contains the following columns:

Column Name	Column Description
Parameter Value	Displays the predefined parameter value.
Description	Displays the description of the predefined parameter value.

By default, the **Predefined Parameter Values for Price Item** zone does not appear in the **Price Item** screen. It appears when you click the **Broadcast** (📡) icon corresponding to a parameter in the **Parameters** zone.

Related Topics

For more information on...	See...
Price Item screen	Price Item (Used for Viewing) on page 402
Parameters zone	Parameters on page 405

Divisions

The **Divisions** zone lists the divisions to which the price item or price item bundle is associated. It contains the following column:

Column Name	Column Description
Division	Indicates the division to which the price item or price item bundle is associated.
	Note: It has a link. On clicking the link, the Division screen appears where you can view the details of the respective division.

On clicking the **Broadcast** (📡) icon corresponding to a division, the **Division-Specific SQIs for Price Item**, **Division-Specific Characteristics for Price Item**, **Division-Specific Accrual Type Criteria for Price Item**, **Division-Specific Hierarchy for Price Item**, **Division-Specific Cost for Price Item**, **Division-Specific Average Price Floor and Ceil Values for Price Item** and **Division-Specific Negotiability Floor and Ceil Values for Price Item** zones appear.

You can filter the list using the **Division** field available in the **Filter** area. By default, the **Filter** area is hidden. You can view the **Filter** area by clicking the **Filters** () icon in the upper right corner of this zone.

Related Topics

For more information on...	See...
Price Item screen	Price Item (Used for Viewing) on page 402
Division-Specific SQIs for Price Item zone	Division-Specific SQIs for Price Item on page 407
Division-Specific Characteristics for Price Item zone	Division-Specific Characteristics for Price Item on page 407
Division-Specific Accrual Type Criteria for Price Item zone	Division-Specific Accrual Type Criteria for Price Item on page 408
Division-Specific Hierarchy for Price Item zone	Division-Specific Hierarchy for Price Item on page 408
Division-Specific Cost for Price Item zone	Division-Specific Cost for Price Item on page 410
Division-Specific Negotiability Floor and Ceil Values for Price Item zone	Division-Specific Negotiability Floor and Ceil Values for Price Item on page 409
Division-Specific Floor and Ceil Values for Price Item zone	Division-Specific Average Price Floor and Ceil Values for Price Item on page 411

Division-Specific SQIs for Price Item

The **Division-Specific SQIs for Price Item** zone lists the SQIs associated with the price item or price item bundle for the division. It contains the following column:

Column Name	Column Description
SQI	Indicates the SQI associated with the price item or price item bundle for the division. Note: It has a link. On clicking the link, the Service Quantity Identifier screen appears where you can view the details of the respective SQI.

By default, the **Division-Specific SQIs for Price Item** zone does not appear in the **Price Item** screen. It appears when you click the **Broadcast** () icon corresponding to a division in the **Divisions** zone.

Related Topics

For more information on...	See...
Price Item screen	Price Item (Used for Viewing) on page 402
Divisions zone	Divisions on page 406

Division-Specific Characteristics for Price Item

The **Division-Specific Characteristics for Price Item** zone lists the characteristics of the price item or price item bundle which are defined for the division. It contains the following columns:

Column Name	Column Description
Effective Date	Displays the date from when the price item or price item bundle characteristic is effective for the division.
Characteristic Type	Indicates the characteristic type.

Column Name	Column Description
	Note: It has a link. On clicking the link, the Characteristic Type screen appears where you can view the details of the respective characteristic type.
Characteristic Value	Displays the value of the characteristic type.

By default, the **Division-Specific Characteristics for Price Item** zone does not appear in the **Price Item** screen. It appears when you click the **Broadcast** () icon corresponding to a division in the **Divisions** zone.

Related Topics

For more information on...	See...
Price Item screen	Price Item (Used for Viewing) on page 402
Divisions zone	Divisions on page 406

Division-Specific Accrual Type Criteria for Price Item

Note: This topic is not applicable for the health insurance business.

The **Division-Specific Accrual Type Criteria for Price Item** zone lists the accrual type criteria of the price item or price item bundle which is defined for the division. It contains the following column:

Column Name	Column Description
Accrual Type Criteria	Indicates whether the billable charges of the price item should be considered for accrual depending on the accrual criteria specified in the accrual type. The valid values are: <ul style="list-style-type: none"> • Actual • Historical • Not Applicable

By default, the **Division-Specific Accrual Type Criteria for Price Item** zone does not appear in the **Price Item** screen. It appears when you click the **Broadcast** () icon corresponding to a division in the **Divisions** zone.

Related Topics

For more information on...	See...
Price Item screen	Price Item (Used for Viewing) on page 402
Divisions zone	Divisions on page 406

Division-Specific Hierarchy for Price Item

Note: This topic is not applicable for the health insurance business.

The **Division-Specific Hierarchy for Price Item** zone lists the following in a tree structure:

- Information string of the hierarchy entity at the first level in the entity hierarchy relationship
- Information string of the hierarchy entities at the subsequent levels in the entity hierarchy relationship
- Information string of the price items which are associated with the hierarchy entities at different levels in the entity hierarchy relationship

For example,

- ▲ [Cash Management, US](#)
 - ▲ [Payments, US](#)
 - > [ACH Payment](#)
 - > [ACH Return](#)
 - > [ACH Reversal](#)
 - ▲ [Statements, US](#)
 - > [Mini Statement](#)
 - > [Yearly Statement](#)

Here, the Cash Management, US (at the first level), Payments, US (at the second level), and Statements, US (at the second level) are the hierarchy entity nodes. And, the ACH Payment, ACH Return, ACH Reversal, Mini Statement, and Yearly Statement are the price item nodes.

Each node in the tree has a link. If you click the link on the hierarchy entity node, the **Hierarchy Entity** screen appears where you can view the details of the respective hierarchy entity. However, if you click the link on the price item node, the **Price Item** screen appears where you can view the details of the respective price item.

It contains the following field:

Field Name	Field Description
Hierarchy	Displays the entity hierarchy relationship code.

In addition, it contains the following buttons:

Button Name	Button Description
Expand All	Used to expand all nodes at once in the entity hierarchy relationship.
Collapse All	Used to collapse all nodes at once in the entity hierarchy relationship.

By default, the **Division-Specific Hierarchy for Price Item** zone does not appear in the **Price Item** screen. It appears when you click the **Broadcast** (📡) icon corresponding to a division in the **Divisions** zone.

Related Topics

For more information on...	See...
Price Item screen	Price Item (Used for Viewing) on page 402
Divisions zone	Divisions on page 406

Division-Specific Negotiability Floor and Ceil Values for Price Item

Note: This topic is not applicable for the health insurance business.

The **Division-Specific Negotiability Floor and Ceil Values for Price Item** zone lists the negotiability floor and ceil limits of a price item or price item bundle which are defined for the division. It contains the following columns:

Column Name	Column Description
Floor Value	Indicates the floor (i.e. lower) limit for the rate negotiation.

Column Name	Column Description
Ceil Value	Indicates the ceil (i.e. upper) limit for the rate negotiation.
Floor and Ceil Currency	Indicates the currency used to define the rate negotiability floor and ceil limits. Note: The system does the currency conversion when the pricing currency is different from the floor and ceil currency.
Rate Negotiability	Indicates if the rate of a price item is negotiable or not in a deal. The valid values are: <ul style="list-style-type: none"> • Yes • No
Negotiate Rate Only Within Range	Indicates that the system should validate whether the negotiated rate is within the negotiability floor and ceil limits or not. The valid values are: <ul style="list-style-type: none"> • Yes • No Note: This field is enabled when the Yes option is selected for the Negotiability Switch list

By default, the **Division-Specific Negotiability Floor and Ceil Values for Price Item** zone does not appear in the **Price Item** screen. It appears when you click the **Broadcast** () icon corresponding to a division in the **Divisions** zone.

Related Topics

For more information on...	See...
Price Item screen	Price Item (Used for Viewing) on page 402
Divisions zone	Divisions on page 406

Division-Specific Cost for Price Item

Note: This topic is not applicable for the health insurance business.

The **Division-Specific Cost for Price Item** zone lists the costs of the price item or price item bundle which is defined for the division. It contains the following columns:

Column Name	Column Description
Effective Date	Displays the date from when the cost of the price item or price item bundle is effective for the division.
Cost Type	Indicates the type of cost incurred in the division for the price item or price item bundle. The valid values are: <ul style="list-style-type: none"> • Additional Fixed Cost • Additional Variable Cost • Fixed Third Party Cost • Fixed Internal Cost • Variable Internal Cost • Variable Third Party Cost

Column Name	Column Description
Cost Value	Displays the cost amount.
Cost Currency	Indicates the currency in which the cost is specified. Note: It has a link. On clicking the link, the Currency screen appears where you can view the details of the respective currency.

By default, the **Division-Specific Cost for Price Item** zone does not appear in the **Price Item** screen. It appears when you click the **Broadcast** () icon corresponding to a division in the **Divisions** zone.

Related Topics

For more information on...	See...
Price Item screen	Price Item (Used for Viewing) on page 402
Divisions zone	Divisions on page 406

Division-Specific Average Price Floor and Ceil Values for Price Item

Note: This topic is not applicable for the health insurance business.

The **Division-Specific Average Price Floor and Ceil Values for Price Item** zone lists the average price floor and ceil limits of the price item or price item bundle which are defined for the division. It contains the following columns:

Column Name	Column Description
To Do Role	Indicates that users with the specified To Do role can approve the average price of the price item or price item bundle in a deal when it is within the specified floor and ceil limits. Note: It has a link. On clicking the link, the To Do Role screen appears where you can view the details of the respective To Do role.
Floor Value	Displays the floor (i.e. lower) limit of the To Do role. Note: This column appears when the Absolute Value Range option is selected for the Average Price Floor and Ceil Limits list for a price item or price item bundle.
Ceil Value	Displays the ceil (i.e. upper) limit of the To Do role. Note: This column appears when the Absolute Value Range option is selected for the Average Price Floor and Ceil Type list for a price item or price item bundle.
Floor and Ceil Currency	Indicates the currency in which the average price floor and ceil limits are defined for the price item or price item bundle. Note: It has a link. On clicking the link, the Currency screen appears where you can view the details of the respective currency.
Spread Amount	Indicates the spread amount specified while defining a price item or price item bundle or assigned to a To Do role. Note: This column appears when the Spread Amount option is selected for the Average Price Floor and Ceil Type list for a price item or price item bundle.

Column Name	Column Description
Spread Percentage	Indicates the spread percentage specified while defining a price item or price item bundle or assigned to a To Do role.
	Note: This column appears when the Spread Percentage option is selected for the Average Price Floor and Ceil Type list for a price item or price item bundle.

By default, the **Division-Specific Average Price Floor and Ceil Values for Price Item** zone does not appear in the **Price Item** screen. It appears when you click the **Broadcast** () icon corresponding to a division in the **Divisions** zone.

Related Topics

For more information on...	See...
Price Item screen	Price Item (Used for Viewing) on page 402
Divisions zone	Divisions on page 406

Price Item Relationship

Note: This topic is not applicable for the health insurance business.

The **Price Item Relationship** zone lists the price items or price item bundles which are associated with the parent price item or added to the price item bundle. It contains the following columns:

Column Name	Column Description
Price Item Information	Displays information about the price item or price item bundle.
	Note: It has a link. On clicking the link, the Price Item screen appears where you can view the details of the respective price item or price item bundle.
Effective Start Date	Displays the date from when the price item or price item bundle is associated with the parent price item or added to the price item bundle.
Effective End Date	Displays the date till when the price item or price item bundle is associated with the parent price item or added to the price item bundle.
Relationship Type	Indicates how the price item or price item bundle is related to the parent price item or price item bundle. The valid values are: <ul style="list-style-type: none"> • Bundle • Child Price Item • Custom • Denominator • Numerator • Other • Price Item • Product Group • Service • Service Group
Bundle Type	Indicates the type of the price item bundle. The valid values are:

Column Name	Column Description
	<ul style="list-style-type: none"> Phantom Ratio Regular
	Note: The data appears in this column when the associated price item is a bundle.
Price Item Parameters	Displays the parameters and their values based on which you want to determine pricing for the price item or price item bundle.

Note: Pagination is used to display limited number of records in this zone. You can use the navigation links, such as **Previous** and **Next** to navigate between pages.

You can filter the list using various search criteria (such as, **Price Item**, **Description**, **Effective Start Date**, and **Relationship Type**) available in the **Filter** area. By default, the **Filter** area is hidden. You can view the **Filter** area by clicking the **Filters** (∨) icon in the upper right corner of this zone.

You can change the layout of this zone. For more information on how to change the layout, see [Changing the Layout](#) on page 4300.

You can associate or disassociate a price item or price item bundle from a parent price item and add or remove a price item or price item bundle from a price item bundle by clicking the **Add/Edit** link in the upper right corner of this zone.

Related Topics

For more information on...	See...
Price Item screen	Price Item (Used for Viewing) on page 402
How to associate a price item or price item bundle with a parent price item	Associating a Price Item or Price Item Bundle with a Parent Price Item on page 424
How to add a price item or price item bundle to a price item bundle	Adding a Price Item or Price Item Bundle to a Price Item Bundle on page 426
How to disassociate a price item or price item bundle from a parent price item	Disassociating a Price Item or Price Item Bundle from a Parent Price Item on page 432
How to remove a price item or price item bundle from a price item bundle	Removing a Price Item or Price Item Bundle from a Price Item Bundle on page 432

Editing a Price Item or Price Item Bundle

Prerequisites

To edit a price item or price item bundle, you should have:

- Contract types, To Do types, and To Do roles defined in the application
- To Do roles associated with the required To Do type
- Value defined for the **Default Contract Type** option type in the **C1_PRICING** feature configuration

Procedure

To edit a price item or price item bundle:

- Search for the price item or price item bundle in the **Price Item** screen.
- In the **Search Results** section, click the link in the **Price Item Information** column corresponding to the price item or price item bundle whose details you want to edit.

The **Price Item** screen appears.

3. Click the **Edit** button in the **Price Item** zone.

The **Price Item** screen appears. It contains the following sections:

- **Main** - Used to specify basic details about the price item or price item bundle.
- **Parameters** - Used to associate a parameter with the price item or price item bundle. These associated parameters are then used for aggregating transactions and/or for defining the price item pricing.

Note:

The **Parameters** section appears in the **Price Item** screen when the **Multi Price Parameter** option type of the **C1_PPARM_FLG** feature configuration is set to **True**.

You cannot associate parameters to the ratio and phantom price item bundles. Therefore, while defining a ratio or phantom price item bundle, the **Parameters** section does not appear in the **Price Item** screen.

- **Divisions** - Used to associate the price item or price item bundle with one or more divisions. In addition, it enables you to:
 - Associate the service quantity identifiers (SQIs) with the price item or price item bundle for a division
 - Define the accrual type criteria of the price item or price item bundle for a division

Note: This step is not applicable for the health insurance business.

- Associate the price item or price item bundle with a hierarchy entity in an entity hierarchy relationship of a division

Note: This step is not applicable for the health insurance business.

- Define the cost of the price item or price item bundle for a division

Note: This step is not applicable for the health insurance business.

- Define the average price floor and ceil limits of the price item or price item bundle for a division

Note: This step is not applicable for the health insurance business.

- Define the negotiability floor and ceil values of the price item or price item bundle for a division

Note: This step is not applicable for the health insurance business.

- Define the division-specific characteristics for the price item or price item bundle
- **Price Item Characteristics** - Used to define characteristics (which are applicable across divisions) for the price item or price item bundle.

The **Main** section contains the following fields:

Field Name	Field Description	Mandatory (Yes or No)
Price Item	Displays the price item or price item bundle.	Not applicable
Description	Used to specify the description for the price item or price item bundle.	Yes
Price Item Usage	Used to indicate whether the price item or price item bundle is available for pricing or pricing and billing. The valid values are: <ul style="list-style-type: none"> • Pricing - Used when you want to define pricing for the price item or price item 	Yes

Field Name	Field Description	Mandatory (Yes or No)
	<p>bundle, but no charges should be created against it in the system.</p> <div data-bbox="699 285 1154 359" style="border: 1px solid black; padding: 2px;"> <p>Note: This option is not applicable for the health insurance business.</p> </div> <ul style="list-style-type: none"> • Pricing and Billing - Used when you want to define pricing and create charges for the price item or price item bundle in the system. <div data-bbox="639 531 1154 699" style="border: 1px solid black; padding: 2px;"> <p>Note: You can change the price item usage of a price item or price item bundle from Pricing to Pricing and Billing. But, you cannot change the price item usage of a price item or price item bundle from Pricing and Billing to Pricing.</p> </div>	
Price Item Type	<p>Used to indicate the type of the price item or price item bundle. The valid values are:</p> <ul style="list-style-type: none"> • Rate - Used when you want to create a rate based price item or price item bundle. For example, savings, current, and loan interest services (i.e. price items) are rate based price items. <div data-bbox="699 993 1154 1066" style="border: 1px solid black; padding: 2px;"> <p>Note: This option is not applicable for the health insurance business.</p> </div> <ul style="list-style-type: none"> • Fees - Used when you want to create a fee based price item or price item bundle. For example, debit credit service (i.e. price item) is a fee based price item. <div data-bbox="639 1234 1154 1728" style="border: 1px solid black; padding: 2px;"> <p>Note: This field appears when the Pricing option is selected from the Price Item Usage list. You cannot create a price item bundle when the Pricing option is selected from the Price Item Usage list and Rate option is selected from the Price Item Type list. The system automatically sets the price item type of those price items or price item bundles which are available for pricing and billing to Fees. Therefore, this field does not appear when the Pricing and Billing option is selected from the Price Item Usage list.</p> </div>	Yes
Bundle	<p>Used to indicate whether you want to create a price item bundle. The valid values are:</p> <ul style="list-style-type: none"> • Yes • No 	Yes

Field Name	Field Description	Mandatory (Yes or No)
	<p>Note: This field is not applicable for the health insurance business.</p>	
<p>Bundle Type</p>	<p>Used to indicate the type of the price item bundle. If the Pricing and Billing option is selected from the Price Item Usage list, the valid values are:</p> <ul style="list-style-type: none"> • <i>Regular Bundle</i> on page 287 • <i>Phantom Bundle</i> on page 291 • <i>Ratio Bundle</i> on page 288 <p>However, if the Pricing option is selected from the Price Item Usage list and the Fees option is selected from the Price Item Type list, you can only define a regular price item bundle. Therefore, by default, the value is set to Regular.</p> <p>Note: This field appears when the Yes option is selected from the Bundle list.</p> <p>This field is enabled when the Pricing and Billing option is selected from the Price Item Usage list and the Yes option is selected from the Bundle list.</p> <p>You cannot define a price item bundle when the Pricing option is selected from the Price Item Usage list and Rate option is selected from the Price Item Type list.</p> <p>This field is not applicable for the health insurance business.</p>	<p>Yes (Conditional)</p> <p>Note: This field is required when you are creating a price item bundle.</p>
<p>Global Price List</p>	<p>Used to indicate whether the price item or price item bundle can be assigned to a global price list. The valid values are:</p> <ul style="list-style-type: none"> • Yes • No 	<p>Yes</p>
<p>Contract Type</p>	<p>Used to indicate the contract type that you want to associate with the price item or price item bundle.</p>	<p>Yes</p>

Field Name	Field Description	Mandatory (Yes or No)
	<p>Note:</p> <p>This field appears when the Pricing and Billing option is selected from the Price Item Usage list.</p> <p>The Search (🔍) icon appears corresponding to the Contract Type field. On clicking the Search icon, the Contract Type Search window appears.</p>	
Price Item Manager To Do Type	<p>Used to indicate the To Do type using which a To Do should be created when the deal creator or approver requests the price item manager (i.e. clicks the Send Price Items for Approval button) to approve the average price for the price item or price item bundle offered in a deal.</p> <p>Note:</p> <p>The Search (🔍) icon appears corresponding to the Price Item Manager To Do Type field. On clicking the Search icon, the To Do Type Search window appears.</p> <p>On specifying the To Do type, the description of the To Do type appears corresponding to the Price Item Manager To Do Type field.</p> <p>This field is not applicable for the health insurance business.</p>	No
Price Item Manager To Do Role	<p>Used to indicate that users with the specified To Do role can approve the average price for the price item or price item bundle offered in a deal. Note that the price item manager can approve the average price when it is within the average price floor and ceil limits defined for the To Do role.</p> <p>Note:</p> <p>The list appears when the price item manager To Do type is selected from the respective field. It includes only those To Do roles which are associated with the price item manager To Do type.</p> <p>This field is not applicable for the health insurance business.</p>	<p>Yes (Conditional)</p> <p>Note: This field is required when the price item manager To Do type is specified for the price item or price item bundle.</p>
Average Price Floor and Ceil Type	Used to indicate the manner in which you want to define the average price floor and ceil limits for the price item or price item bundle. The valid value is:	Yes (Conditional)

Field Name	Field Description	Mandatory (Yes or No)
	<ul style="list-style-type: none"> • Absolute Value Range - Used when you want to define the average price floor and ceil limits in the absolute values. For example, the average price for the price item or price item bundle should be between 10\$ to 15\$. • Spread Amount - Used when you want to define the average floor and ceil limits based on the spread amount. • Spread Percentage – Used when you want to define the average floor and ceil limits based on the spread percentage. <p>Note:</p> <ul style="list-style-type: none"> • In case of Spread Amount and Spread Percentage options, the system calculates the average price of a price item and based on the average price and the spread amount or spread percentage, the average floor and ceil limits are derived. • This field is not applicable for the health insurance business. 	<p>Note: This field is required when you are defining the average price floor and ceil limits of the price item or price item bundle for a division.</p>
Sort Sequence	Used to specify the sequence in which the price item should appear in the price item hierarchy of the deal management module.	No
Variable Price	<p>Used to indicate whether the system inherits the pricing of the price item from the price list while orchestrating a deal in the deal management module.</p> <p>Note:</p> <p>If the Variable Price option is selected, the pricing offered for a price item to an entity in the deal is overridden when the price list pricing is changed after orchestrating the deal in the system.</p> <p>However, if the Variable Price option is not selected, the pricing offered for a price item to an entity in the deal is not overridden when the price list pricing is changed in the system. This enables the relationship manager to create deals for an existing customers, accounts, and prospects where the pricing of the price items are fixed for a particular timeframe.</p>	No

4. Modify the required details in the **Main** section.
5. Associate, edit, or disassociate parameters from the price item or price item bundle, if required.

Note:

You can edit the parameter details and remove a parameter from the price item or price item bundle when the parameter or any other parameter from the same date range is not yet used for aggregation or for defining the price item pricing.

You can add a parameter which is used for aggregation, whenever required. However, you can add a parameter which is used for pricing when any other parameter from the same date range is not yet used for aggregation or for defining the price item pricing.

For each predefined parameter which is associated with the price item or price item bundle, you can define a set of valid predefined parameter values for the price item or price item bundle, if required.

6. Associate or disassociate the price item or price item bundle from the divisions, if required.

Note: If the price item or price item bundle is associated to a division to which you do not have access, then the corresponding row in the **Divisions** section is grayed out.

7. Associate or disassociate the SQIs from the price item or price item bundle for the required divisions.
8. Define, edit, or remove the accrual type criteria of the price item or price item bundle from the required divisions.

Note: This step is not applicable for the health insurance business.

9. Associate or disassociate the price item or price item bundle from a hierarchy entity in an entity hierarchy relationship of the required divisions.

Note: This step is not applicable for the health insurance business.

10. Define, edit, or remove the cost of the price item or price item bundle from the required divisions.

Note: This step is not applicable for the health insurance business.

11. Define, edit, or remove the average price floor and ceil limits of the price item or price item bundle from the required divisions.

Note: This step is not applicable for the health insurance business.

12. Define, edit or remove the rate negotiability floor and ceil values of the price item or price item bundle for the required divisions.

Note: This step is not applicable for the health insurance business.

13. Define, edit, or remove the division-specific characteristics from the price item or price item bundle. if required.

14. Define, edit, or remove characteristics of the price item or price item bundle, if required.

15. Click **Save**.

The changes made to the price item or price item bundle are saved.

Related Topics

For more information on...	See...
How to search for a price item or price item bundle	Searching for a Price Item or Price Item Bundle on page 361
How to associate a parameter with a price item or price item bundle	Associating a Parameter with a Price Item or Price Item Bundle on page 369

For more information on...	See...
How to associate a price item or price item bundle with a division	Associating a Price Item or Price Item Bundle with a Division on page 374
How to associate an SQI with a price item or price item bundle for a division	Associating an SQI with a Price Item or Price Item Bundle for a Division on page 377
How to define the accrual type criteria of a price item or price item bundle for a division	Defining the Accrual Type Criteria of a Price Item or Price Item Bundle for a Division on page 380
How to associate a price item or price item bundle with a hierarchy entity in an entity hierarchy relationship of a division	Associating a Price Item or Price Item Bundle with a Hierarchy Entity in an Entity Hierarchy Relationship of a Division on page 382
How to define the cost of a price item or price item bundle for a division	Defining the Cost of a Price Item or Price Item Bundle for a Division on page 384
How to define the average price floor and ceil limits of a price item or price item bundle for a division	Defining the Average Price Floor and Ceil Values of a Price Item or Price Item Bundle for a Division on page 387
How to define the rate negotiability floor and ceil values for a price item or price item bundle	Defining the Rate Negotiability Floor and Ceil Values of a Price Item or Price Item Bundle for a Division on page 390
How to define a division-specific characteristic for a price item or price item bundle	Defining a Division-Specific Characteristic for a Price Item or Price Item Bundle on page 379
How to define a characteristic for a price item or price item bundle	Defining a Characteristic for a Price Item or Price Item Bundle on page 392
How to set the C1_PRICING feature configuration	Setting the C1_PRICING Feature Configuration on page 4342

Price Item Relationship

Note: This topic is not applicable for the health insurance business.

Oracle Revenue Management and Billing allows you to associate two or more price items with each other, and thereby group them for various reasons, such as reporting, billing, and so on. In other words, you can define a price item to price item relationship. The price item to which a set of price items are associated is called a parent price item. You can also create a price item bundle and then add price items to the price item bundle. The main objective behind grouping price items or creating price item bundles is to offer discounts based on the volume across price items, facilitate minimum or maximum charge calculations across price items, or offer common price across price items.

While associating a price item with a parent price item or adding a price item to a price item bundle, you need to specify how the price item is related to the parent price item or price item bundle. You can add a price item to a price item bundle using the following relationship types:

- **Bundle** – Used while adding price items in the regular and phantom price item bundles.
- **Denominator** – Used while adding price items in the ratio price item bundles.
- **Numerator** – Used while adding price items in the ratio price item bundles.

However, you can associate a price item or price item bundle with a parent price item using the following relationship types:

- Other
- Custom
- Price Item

- Service
- Service Group

Note:

You cannot add same set of price items using the same relationship type while defining two or more bundles with the same bundle type. For example, you cannot add P1 and P2 using the relationship type as Bundle while defining regular bundles named BUN1 and BUN2. However, you can use same set of price items while defining two or more price item to price item relationships.

If the multi parameter based pricing feature is enabled, you can add same set of price item and price item parameter combination (using the same relationship type) in more than one bundle (having the same bundle type) provided the price item parameter values are different.

The **Price Item Relationship** screen allows you to view the price items that are already associated with the parent price item or added to the price item bundle. It also allows you to associate or disassociate a price item or price item bundle from the parent price item, or add or remove a price item or price item bundle from the price item bundle. This screen consists of the following zone:

- [Assigned Price Items](#) on page 421

Assigned Price Items

Note: This topic is not applicable for the health insurance business.

The **Assigned Price Items** zone lists the price items or price item bundles that are already associated with the parent price item or added to the price item bundle. You will not find any records in this zone if the parent price item does not have any price item or price item bundle associated with it or if the price item bundle does not have any price item or price item bundle added to it. It contains the following sections:

- **Search Criteria** - The **Search Criteria** section contains the following fields:

Field Name	Field Description	Mandatory (Yes or No)
Price Item	Used to search a particular price item or price item bundle which is associated with the parent price item or added to the price item bundle.	No
Description	Used to search price items or price item bundles with a particular description.	No
Effective Start Date	Used to search price items or price item bundles which are associated with the parent price item or added to the price item bundle from a particular date.	No
Relationship Type	Used to search price items or price item bundles which are related to the parent price item or added to the price item bundle using a particular relationship type. The valid values are: <ul style="list-style-type: none"> • Bundle • Child Price Item • Custom • Denominator • Numerator • Other 	No

Field Name	Field Description	Mandatory (Yes or No)
	<ul style="list-style-type: none"> Price Item Product Group Service Service Group 	

- **Search Results** - On clicking the **Search** button, the search results are filtered based on the specified search criteria. The **Search Results** section contains the following columns:

Column Name	Column Description
Price Item Information	Displays information about the price item or price item bundle. Note: It has a link. On clicking the link, the Price Item screen appears where you can view the details of the respective price item or price item bundle.
Effective Start Date	Displays the date from when the price item or price item bundle is associated with the parent price item or added to the price item bundle.
Effective End Date	Displays the date till when the price item or price item bundle is associated with the parent price item or added to the price item bundle.
Relationship Type	Indicates how the price item or price item bundle is related to the parent price item or price item bundle. The valid values are: <ul style="list-style-type: none"> Bundle Child Price Item Custom Denominator Numerator Other Price Item Product Group Service Service Group Note: The Bundle relationship type is used while adding price items in the regular and phantom price item bundles. The Denominator and Numerator relationship types are used while adding price items in the ratio price item bundles. And, all other relationship types, such as Other , Custom , Price Item , Service , and Service Group are used while associating price items to the parent price item.
Price Item Parameters	Indicates the parameters based on which you want to determine pricing for the price item.

You can associate or disassociate a price item or price item bundle from a parent price item, or add or remove a price item or price item bundle from a price item bundle by clicking the **Add/Edit** link in the upper right corner of this zone.

Related Topics

For more information on...	See...
Price Item Relationship screen	Price Item Relationship on page 420
How to view the price items or price item bundles associated with a parent price item	Viewing the Price Items or Price Item Bundles Associated with a Parent Price Item on page 423
How to view the price items or price item bundles added to a price item bundle	Viewing the Price Items or Price Item Bundles Added to a Price Item Bundle on page 423
How to associate a price item or price item bundle with a parent price item	Associating a Price Item or Price Item Bundle with a Parent Price Item on page 424
How to add a price item or price item bundle to a price item bundle	Adding a Price Item or Price Item Bundle to a Price Item Bundle on page 426
How to disassociate a price item or price item bundle from a parent price item	Disassociating a Price Item or Price Item Bundle from a Parent Price Item on page 432
How to remove a price item or price item bundle from a price item bundle	Removing a Price Item or Price Item Bundle from a Price Item Bundle on page 432
How to filter the price items or price item bundles associated with a parent price item	Filtering the Price Items or Price Item Bundles Associated with a Parent Price Item on page 433
How to filter the price items or price item bundles added to a price item bundle	Filtering the Price Items or Price Item Bundles Added to a Price Item Bundle on page 434

Viewing the Price Items or Price Item Bundles Associated with a Parent Price Item

Note: This topic is not applicable for the health insurance business.

Procedure

To view the price items or price item bundles associated with a parent price item:

1. Search for the price item in the **Price Item** screen.
2. In the **Search Results** section, click the **Price Item Relationship**  icon in the **Price Item Relationship** column corresponding to the price item whose relationship details you want to view.

The **Price Item Relationship** screen appears.

3. View the price items or price item bundles that are associated with the parent price item in the **Assigned Price Items** zone.

Related Topics

For more information on...	See...
How to search for a price item	Searching for a Price Item or Price Item Bundle on page 361
Price Item Relationship screen	Price Item Relationship on page 420
Assigned Price Items zone	Assigned Price Items on page 421

Viewing the Price Items or Price Item Bundles Added to a Price Item Bundle

Note: This topic is not applicable for the health insurance business.

Procedure

To view the price items or price item bundles added to a price item bundle:

1. Search for the price item bundle in the **Price Item** screen.
2. In the **Search Results** section, click the **Price Item Relationship**  icon in the **Price Item Relationship** column corresponding to the price item bundle whose relationship details you want to view.
The **Price Item Relationship** screen appears.
3. View the price items or price item bundles that are added to the price item bundle in the **Assigned Price Items** zone.

Related Topics

For more information on...	See...
How to search for a price item bundle	Searching for a Price Item or Price Item Bundle on page 361
Price Item Relationship screen	Price Item Relationship on page 420
Assigned Price Items zone	Assigned Price Items on page 421

Associating a Price Item or Price Item Bundle with a Parent Price Item

Note: This topic is not applicable for the health insurance business.

Prerequisites

To associate a price item or price item bundle with a parent price item, you should have:

- Parent price item associated with the division to which the user belongs
- Price item or price item bundle associated to at least one division to which the parent price item belongs.

Procedure

To associate a price item or price item bundle with a parent price item:

1. Search for the parent price item in the **Price Item** screen.
2. In the **Search Results** section, click the **Price Item Relationship**  icon in the **Price Item Relationship** column corresponding to the parent price item to which you want to associate a price item or price item bundle.
The **Price Item Relationship** screen appears.
3. Click the **Add/Edit** link in the upper right corner of the **Assigned Price Items** zone.

The **Price Item Relationship** screen appears. It contains the following fields in a grid:

Field Name	Field Description	Mandatory (Yes or No)
Price Item	Used to indicate the price item or price item bundle that you want to associate with the parent price item.	Yes
	Note: The Search  icon appears corresponding to this field. On clicking the Search icon, the Price Item Search window appears.	
Relationship Type	Used to indicate how the price item or price item bundle is related with the parent price item. The valid values are: <ul style="list-style-type: none"> • Bundle 	Yes

Field Name	Field Description	Mandatory (Yes or No)
	<ul style="list-style-type: none"> • Custom • Denominator • Numerator • Other • Price Item • Service • Service Group <p>Note: You can use the Other, Custom, Price Item, Service, or Service Group relationship type while associating a price item or price item bundle to the parent price item.</p>	
Effective Start Date	<p>Used to specify the date from when you want to associate the price item or price item bundle with the parent price item.</p> <p>Note: The effective start date cannot be later than the effective end date.</p>	Yes
Effective End Date	<p>Used to specify the date till when you want to associate the price item or price item bundle with the parent price item.</p> <p>Note: The effective end date cannot be earlier than the effective start date.</p>	No
Price Item Parameters	<p>Used to specify the parameters and their values based on which you want to determine pricing for the price item or price item bundle.</p> <p>Note:</p> <p>This field appears when the Multi Price Parameter option type of the Multi Parameter Based Pricing (C1_PPARM_FLG) feature configuration is set to True.</p> <p>The Search (🔍) icon appears corresponding to this field. On clicking the Search icon, the Price Item Parameters screen appears.</p> <p>You must not use the Price Item Parameters field while associating a price item or price item bundle with a parent price item. This is because it is designed to be used while adding a price item or price item bundle to the ratio and phantom price item bundles.</p>	Not applicable

Field Name	Field Description	Mandatory (Yes or No)
Characteristics	On clicking the Add (+) icon, you can define relationship-specific characteristics for the price item or price item bundle.	Not applicable

- Enter the required details in the **Price Item Relationship** screen.

Note: You can associate the same set of price items or price item bundles using the same relationship type to more than one parent price item. For example, you can associate the **P1** and **P2** price items using the **Service** relationship type to the **PP1** and **PP2** price items.

- Define relationship-specific characteristics for the price item or price item bundle, if required.
- If you want to associate more than one price item or price item bundle with the parent price item, click the **Add** (+) icon and then repeat the steps from 4 to 5.

Note: However, if you want to disassociate a price item or price item bundle from a parent price item, click the **Delete** (–) icon corresponding to the price item or price item bundle.

- Click **Save**.

The price item or price item bundle is associated with the parent price item.

Related Topics

For more information on...	See...
How to search for a parent price item	Searching for a Price Item or Price Item Bundle on page 361
Price Item Relationship screen	Price Item Relationship on page 420
Assigned Price Items zone	Assigned Price Items on page 421
How to define relationship-specific characteristics for a price item or price item bundle	Defining Relationship-Specific Characteristics for a Price Item or Price Item Bundle on page 430

Adding a Price Item or Price Item Bundle to a Price Item Bundle

Note: This topic is not applicable for the health insurance business.

Prerequisites

To add a price item or price item bundle to a price item bundle, you should have:

- Price item bundle (to which you want to add a price item or price item bundle) associated with the division to which the user belongs
- Price item bundle (to which you want to add a price item or price item bundle) and price item or price item bundle (which you want to add) associated to the same contract type
- Parameters associated with the price item or price item bundle (which you want to add) when you want to determine pricing for the price item based on the parameters in the ratio and phantom price item bundles
- Regular price item bundle (to which you want to add a price item or price item bundle) and price item or price item bundle (which you want to add) associated with the same parameters

Note: Not only the parameters, but also their details such as parameter usage, mandatory flag, and priority should be identical. Also, the date from when the parameters are effective for the price item bundle (to which you want to add a price item or price item bundle) should be earlier than or equal to the date from when the parameters are effective for the price item or price item bundle (which you want to add).

- Price item or price item bundle (which you want to add) associated to at least one division to which the price item bundle (to which you want to add a price item or price item bundle) belongs

Procedure

To add a price item or price item bundle to a price item bundle:

1. Search for the price item bundle in the **Price Item** screen.
2. In the **Search Results** section, click the **View** () icon in the **Price Item Relationship** column corresponding to the price item bundle to which you want to add a price item or price item bundle.

The **Price Item Relationship** screen appears.

3. Click the **Add/Edit** link in the upper right corner of the **Assigned Price Items** zone.

The **Price Item Relationship** screen appears. It contains the following fields in a grid:

Field Name	Field Description	Mandatory (Yes or No)
Price Item	Used to indicate the price item or price item bundle that you want to add to the price item bundle. Note: The Search () icon appears corresponding to the Price Item field. On clicking the Search icon, the Price Item Search window appears.	Yes
Relationship Type	Used to indicate how the price item or price item bundle is related to the price item bundle. The valid values are: <ul style="list-style-type: none"> • Bundle • Custom • Denominator • Numerator • Other • Price Item • Service • Service Group Note: You can use the Bundle relationship type while adding a price item or price item bundle in the regular and phantom price item bundles. However, you can use the Denominator and Numerator relationship type while adding a price item or price item bundle in the ratio price item bundles.	Yes
Effective Start Date	Used to specify the date from when the price item or price item bundle is added to the price item bundle. Note: The effective start date cannot be later than the effective end date.	Yes

Field Name	Field Description	Mandatory (Yes or No)
Effective End Date	Used to specify the date till when the price item or price item bundle is added to the price item bundle.	No
	Note: The effective end date cannot be earlier than the effective start date.	
Price Item Parameters	Used to specify the parameters and their values based on which you want to determine pricing for the price item or price item bundle.	No
	Note: This field appears when the Multi Price Parameter option type of the Multi Parameter Based Pricing (C1_PPARM_FLG) feature configuration is set to True . The Search (🔍) icon appears corresponding to the Price Item Parameters field. On clicking the Search icon, the Price Item Parameters screen appears.	
Characteristics	On clicking the Add (+) icon, you can define relationship-specific characteristics for the price item or price item bundle.	Not applicable

- Enter the required details in the **Price Item Relationship** screen.

Note:

You can add a price item or price item bundle to a regular price item bundle when the regular price item bundle (to which you want to add a price item or price item bundle) and price item or price item bundle (which you want to add) are associated with the same parameters for the specified date range.

You cannot add the same set of price items using the same relationship type to two or more price item bundles with the same bundle type. For example, you cannot add **P1** and **P2** using the **Bundle** relationship type to the **BUN1** and **BUN2** regular price item bundles.

If the multi parameter based pricing feature is enabled, you can add the same set of price item and price item parameter combination (using the same relationship type) to more than one bundle (with the same bundle type) provided the price item parameter values are different.

You cannot add the same price item or price item bundle in numerator and denominator while defining a ratio price item bundle.

- Define relationship-specific characteristics for the price item or price item bundle, if required.
- If you want to add more than one price item or price item bundle to the price item bundle, click the **Add** (+) icon and then repeat the steps from 4 to 5.

Note: However, if you want to remove a price item or price item bundle from a price item bundle, click the **Delete** (🗑️) icon corresponding to the price item or price item bundle.

- Click **Save**.

The price item or price item bundle is added to the price item bundle.

Related Topics

For more information on...	See...
How to search for a price item bundle	Searching for a Price Item or Price Item Bundle on page 361
Price Item Relationship screen	Price Item Relationship on page 420
Assigned Price Items zone	Assigned Price Items on page 421
How to set the parameters for a price item or price item bundle	Setting the Parameters for a Price Item or Price Item Bundle on page 429
How to define relationship-specific characteristics for a price item or price item bundle	Defining Relationship-Specific Characteristics for a Price Item or Price Item Bundle on page 430

Setting the Parameters for a Price Item or Price Item Bundle

Note: This topic is not applicable for the health insurance business.

Prerequisites

To set the parameters for a price item or price item bundle, you should have:

- Parameters (where the **Parameter Usage** field is set to **Pricing**) associated with the price item or price item bundle

Procedure

To set the parameters for a price item or price item bundle:

1. Click the **Search** (🔍) icon corresponding to the **Price Item Parameters** field.

The **Price Item Parameters** screen appears. It contains the following fields:

Field Name	Field Description
Price Item	Indicates the price item or price item bundle for which you want to set the parameters.
Description	Displays the description of the price item or price item bundle.

In addition, this screen contains the following fields in a grid:

Field Name	Field Description	Mandatory (Yes or No)
Price Item Parameter	Indicates the parameter which is associated with the price item or price item bundle. Note: Here, the system displays the price item parameter where the Parameter Usage field is set to Pricing .	Not applicable
Mandatory	Indicates whether the parameter is mandatory while defining the price item pricing. The valid values are: <ul style="list-style-type: none"> • Yes • No 	Not applicable
Priority	Indicates the priority in which optional parameters should be considered while	Not applicable

Field Name	Field Description	Mandatory (Yes or No)
	determining best fit price for the price item or price item bundle. Note: The priority for all parameters which are mandatory is set to 0.	
Parameter Value	Used to specify the parameter value. Note: If the parameter value type is Predefined or Reference , the Search (🔍) icon appears corresponding to the Parameter Value field. On clicking the Search icon, you can search for a parameter value. You can specify any special characters except ampersand (&), comma (,), underscore (_), equal to (=), tilde (~), and semi-colon(;) in the parameter value.	Yes (Conditional) Note: This field is required when you want to determine pricing for the price item or price item bundle based on the parameter.

- Enter the required details in the **Price Item Parameters** screen.
- Click **OK**.

A comma-separated list of values appear in the **Price Item Parameters** column corresponding to the price item or price item bundle. The order in which parameter values appear in the price item parameter information string is controlled by the display order (which is defined while associating a parameter with a price item).

Note: The value specified for a parameter whose value type is set to **Adhoc** is validated using the validation algorithm attached to the respective parameter.

Related Topics

For more information on...	See...
How to add a price item or price item bundle to a price item bundle	Adding a Price Item or Price Item Bundle to a Price Item Bundle on page 426

Defining Relationship-Specific Characteristics for a Price Item or Price Item Bundle

Note: This topic is not applicable for the health insurance business.

Prerequisites

To define relationship-specific characteristics for a price item or price item bundle, you should have:

- Characteristic types defined in the application (where the characteristic entity is set to **Price Item Relationship**)

Procedure

To define relationship-specific characteristics for a price item or price item bundle:

- Click the **Add** (➕) icon in the **Characteristics** column corresponding to the price item or price item bundle for which you want to define relationship-specific characteristics.

A grid appears corresponding to the price item or price item bundle with the following fields:

Field Name	Field Description	Mandatory (Yes or No)
Effective Date	Used to specify the date from when the relationship-specific characteristic is effective for the price item or price item bundle.	Yes (Conditional)
		Note: This field is required when you are defining a relationship-specific characteristic for the price item or price item bundle.
Characteristic Type	Used to indicate the characteristic type. Note: The list includes only those characteristic types where the characteristic entity is set to Price Item Relationship .	Yes (Conditional)
		Note: This field is required when you are defining a relationship-specific characteristic for the price item or price item bundle.
Characteristic Value	Used to specify the value for the characteristic type. Note: If you select a predefined characteristic type, the Search (🔍) icon appears corresponding to the Characteristic Value field. On clicking the Search icon, the Predefined Characteristic Search window appears. On specifying the value for a predefined characteristic type, the description of the characteristic value appears corresponding to the Characteristic Value field.	Yes (Conditional)
		Note: This field is required when you are defining a relationship-specific characteristic for the price item or price item bundle.

- Enter the required details in the **Characteristics** grid.
- If you want to define more than one relationship-specific characteristic for the price item or price item bundle, click the **Add** (+) icon and then repeat step 2.

Note: However, if you want to remove a relationship-specific characteristic from the price item or price item bundle, click the **Delete** (🗑️) icon corresponding to the characteristic.

- Click **Save**.

The relationship-specific characteristics are defined for the price item or price item bundle.

Related Topics

For more information on...	See...
How to associate a price item or price item bundle with a parent price item	Associating a Price Item or Price Item Bundle with a Parent Price Item on page 424
How to add a price item or price item bundle to a price item bundle	Adding a Price Item or Price Item Bundle to a Price Item Bundle on page 426

Disassociating a Price Item or Price Item Bundle from a Parent Price Item

Note: This topic is not applicable for the health insurance business.

Prerequisites

To disassociate a price item or price item bundle from a parent price item, you should have:

- Parent price item associated with the division to which the user belongs

Procedure

To disassociate a price item or price item bundle from a parent price item:

1. Search for the parent price item in the **Price Item** screen.
2. In the **Search Results** section, click the **View** () icon in the **Price Item Relationship** column corresponding to the parent price item from which you want to disassociate a price item or price item bundle.

The **Price Item Relationship** screen appears.

3. Click the **Add/Edit** link in the upper right corner of the **Assigned Price Items** zone.

The **Price Item Relationship** screen appears.

4. Filter the price items or price item bundles associated to the parent price item, if required.

5. In the **Search Results** section, click the **Delete** () icon corresponding to the price item or price item bundle that you want to disassociate from the parent price item.

6. Click **Save**.

The price item or price item bundle is disassociated from the parent price item.

Related Topics

For more information on...	See...
How to search for a parent price item	Searching for a Price Item or Price Item Bundle on page 361
Price Item Relationship screen	Price Item Relationship on page 420
Assigned Price Items zone	Assigned Price Items on page 421
How to filter the price items or price item bundles associated with the parent price item	Filtering the Price Items or Price Item Bundles Associated with a Parent Price Item on page 433

Removing a Price Item or Price Item Bundle from a Price Item Bundle

Note: This topic is not applicable for the health insurance business.

Prerequisites

To remove a price item or price item bundle from a price item bundle, you should have:

- Price item bundle associated with the division to which the user belongs

Procedure

To remove a price item or price item bundle from a price item bundle:

1. Search for the price item bundle in the **Price Item** screen.

- In the **Search Results** section, click the **View** () icon in the **Price Item Relationship** column corresponding to the price item bundle from which you want to remove a price item or price item bundle.

The **Price Item Relationship** screen appears.

- Click the **Add/Edit** link in the upper right corner of the **Assigned Price Items** zone.

The **Price Item Relationship** screen appears.

- Filter the price items or price item bundles added to the price item bundle, if required.

- In the **Search Results** section, click the **Delete** () icon corresponding to the price item or price item bundle that you want to remove from the price item bundle.

- Click **Save**.

The price item or price item bundle is removed from the price item bundle.

Related Topics

For more information on...	See...
How to search for a price item bundle	Searching for a Price Item or Price Item Bundle on page 361
Price Item Relationship screen	Price Item Relationship on page 420
Assigned Price Items zone	Assigned Price Items on page 421
How to filter the price items or price item bundles added to the price item bundle	Filtering the Price Items or Price Item Bundles Added to a Price Item Bundle on page 434

Filtering the Price Items or Price Item Bundles Associated with a Parent Price Item

Note: This topic is not applicable for the health insurance business.

Prerequisites

To filter the price items or price item bundles associated with a parent price item, you should have:

- Parent price item associated with the division to which the user belongs

Procedure

To filter the price items or price item bundles associated with a parent price item:

- Search for the parent price item in the **Price Item** screen.
- In the **Search Results** section, click the **View** () icon in the **Price Item Relationship** column corresponding to the parent price item whose details you want to view.

The **Price Item Relationship** screen appears.

- Enter the search criteria in the **Assigned Price Items** zone.

Note: ORMB search engine supports wildcard search, where you can substitute the percentage (%) symbol as a stand in for any word or letter in a search criteria. You can use the ‘%’ wildcard character in all input fields except the date and ID fields. The ‘%’ wildcard character is suffixed automatically at the end of the partial search criteria. Therefore, you may or may not specify the wildcard character at the end of the partial search criteria. However, you have to prefix the wildcard character manually wherever required.

- Click **Search**.

The search results are filtered based on the specified criteria.

Related Topics

For more information on...	See...
How to search for a parent price item	Searching for a Price Item or Price Item Bundle on page 361
Price Item Relationship screen	Price Item Relationship on page 420
Assigned Price Items zone	Assigned Price Items on page 421

Filtering the Price Items or Price Item Bundles Added to a Price Item Bundle

Note: This topic is not applicable for the health insurance business.

Prerequisites

To filter the price items or price item bundles added to a price item bundle, you should have:

- Price item bundle associated with the division to which the user belongs

Procedure

To filter the price items or price item bundles added to a price item bundle:

1. Search for the price item bundle in the **Price Item** screen.
2. In the **Search Results** section, click the **View** (🔗) icon in the **Price Item Relationship** column corresponding to the price item bundle whose details you want to view.

The **Price Item Relationship** screen appears.

3. Enter the search criteria in the **Assigned Price Items** zone.

Note: ORMB search engine supports wildcard search, where you can substitute the percentage (%) symbol as a stand in for any word or letter in a search criteria. You can use the ‘%’ wildcard character in all input fields except the date and ID fields. The ‘%’ wildcard character is suffixed automatically at the end of the partial search criteria. Therefore, you may or may not specify the wildcard character at the end of the partial search criteria. However, you have to prefix the wildcard character manually wherever required.

4. Click **Search**.

The search results are filtered based on the specified criteria.

Related Topics

For more information on...	See...
How to search for a price item bundle	Searching for a Price Item or Price Item Bundle on page 361
Price Item Relationship screen	Price Item Relationship on page 420
Assigned Price Items zone	Assigned Price Items on page 421

Price Item Assignments

Note: This topic is not applicable for the health insurance business.

The **Price Item Assignments** screen allows you to view the active price lists, persons, and accounts where the price item or price item bundle is assigned. It contains the following zones:

- [Active Price Lists where Price Item is Assigned](#) on page 435
- [Persons to whom Price Item is Assigned](#) on page 435
- [Accounts where Price Item is Assigned](#) on page 436

Active Price Lists where Price Item is Assigned

Note: This topic is not applicable for the health insurance business.

The **Active Price Lists where Price Item is Assigned** zone lists the active price lists where the pricing is defined for the price item or price item bundle. It contains the following columns:

Column Name	Column Description
Price List Information	Indicates the price list where the price item or price item bundle is assigned.
	Note: It has a link. On clicking the link, the Price List screen appears where you can view the details of the respective price list.
Effective Start Date	Displays the date from when the price list is effective.
Effective End Date	Displays the date till when the price list is effective.
Availability Start Date	Displays the date from when the price list is available for assignment.
Availability End Date	Displays the date till when the price list is available for assignment.

Note: Pagination is used to display limited number of records in this zone. You can use the navigation links, such as **Previous** and **Next** to navigate between pages.

You can filter the list using various search criteria (such as, **Description**, **Price Assignment Start Date**, **Price Assignment End Date**, **Availability Start Date**, and **Availability End Date**) available in the **Filter** area. By default, the **Filter** area is hidden. You can view the **Filter** area by clicking the **Filters** (🔍) icon in the upper right corner of this zone.

You can change the layout of this zone. For more information on how to change the layout, see [Changing the Layout](#) on page 4300.

Related Topics

For more information on...	See...
Price Item Assignments screen	Price Item Assignments on page 434
How to view the price lists where a price item is assigned	Viewing the Price Lists, Persons, or Accounts where a Price Item is Assigned on page 437

Persons to whom Price Item is Assigned

Note: This topic is not applicable for the health insurance business.

The **Persons to whom Price Item is Assigned** zone lists the persons for whom the pricing is defined for the price item or price item bundle. It contains the following columns:

Column Name	Column Description
Person ID	Indicates the person to whom the price item or price item bundle is assigned.
Person Information	Displays information about the person. In addition, this column has a context menu which helps in navigating to other screens in the application.
	Note: It has a link. On clicking the link, the Person screen appears where you can view the details of the respective person.
Price Assignment Start Date	Displays the date from when the price item is assigned to the person.

Column Name	Column Description
Price Assignment End Date	Displays the date till when the price item is assigned to the person.
Division	Indicates the division to which the person belongs.
Price Assignment ID	Indicates the price item pricing which is assigned to the person.

Note: Pagination is used to display limited number of records in this zone. You can use the navigation links, such as **Previous** and **Next** to navigate between pages.

You can filter the list using various search criteria (such as, **Person ID**, **Price Assignment Start Date**, **Price Assignment End Date**, and **Division**) available in the **Filter** area. By default, the **Filter** area is hidden. You can view the **Filter** area by clicking the **Filters** (∨) icon in the upper right corner of this zone.

You can change the layout of this zone. For more information on how to change the layout, see [Changing the Layout](#) on page 4300.

Related Topics

For more information on...	See...
Price Item Assignments screen	Price Item Assignments on page 434
How to view the persons to whom a price item is assigned	Viewing the Price Lists, Persons, or Accounts where a Price Item is Assigned on page 437

Accounts where Price Item is Assigned

Note: This topic is not applicable for the health insurance business.

The **Accounts where Price Item is Assigned** zone lists the accounts for which the pricing is defined for the price item or price item bundle. It contains the following columns:

Column Name	Column Description
Account ID	Indicates the account where the price item or price item bundle is assigned.
Account Information	Displays information about the account. In addition, this column has a context menu which helps in navigating to other screens in the application. Note: It has a link. On clicking the link, the Account screen appears where you can view the details of the respective account.
Price Assignment Start Date	Displays the date from when the price item is assigned to the account.
Price Assignment End Date	Displays the date till when the price item is assigned to the account.
Division	Indicates the division to which the account belongs.
Price Assignment ID	Indicates the price item pricing which is assigned to the account.

Note: Pagination is used to display limited number of records in this zone. You can use the navigation links, such as **Previous** and **Next** to navigate between pages.

You can filter the list using various search criteria (such as, **Account ID**, **Price Assignment Start Date**, **Price Assignment End Date**, and **Division**) available in the **Filter** area. By default, the **Filter** area is hidden. You can view the **Filter** area by clicking the **Filters** (∨) icon in the upper right corner of this zone.

You can change the layout of this zone. For more information on how to change the layout, see [Changing the Layout](#) on page 4300.

Related Topics

For more information on...	See...
Price Item Assignments screen	Price Item Assignments on page 434
How to view the accounts where a price item is assigned	Viewing the Price Lists, Persons, or Accounts where a Price Item is Assigned on page 437

Viewing the Price Lists, Persons, or Accounts where a Price Item is Assigned

Note: This topic is not applicable for the health insurance business.

Procedure

To view the price lists, persons, or accounts where a price item or price item bundle is assigned:

1. Search for the price item or price item bundle in the **Price Item** screen.
2. In the **Search Results** section, click the **View** (🔗) icon in the **Price Item Assigned To** column corresponding to the price item or price item bundle whose assignment details you want to view.

The **Price Item Assignments** screen appears.

3. View the price lists where the pricing is defined for the price item or price item bundle in the **Active Price Lists where Price Item is Assigned** zone.
4. View the accounts for which the pricing is defined for the price item or price item bundle in the **Accounts where Price Item is Assigned** zone.
5. View the persons for whom the pricing is defined for the price item or price item bundle in the **Persons to whom Price Item is Assigned** zone.

Related Topics

For more information on...	See...
How to search for a price item or price item bundle	Searching for a Price Item or Price Item Bundle on page 361
Price Item Assignments screen	Price Item Assignments on page 434
Active Price Lists where Price Item is Assigned zone	Active Price Lists where Price Item is Assigned on page 435
Accounts where Price Item is Assigned zone	Accounts where Price Item is Assigned on page 436
Persons to whom Price Item is Assigned zone	Persons to whom Price Item is Assigned on page 435

Price List

A price list allows you to define standard prices for a group of price items. In other words, a price list is a rate card for price items or services which are offered to the accounts or persons. You can create more than one price list. For example, you can create a price list for large, medium-sized, and small customers. You can also create a set of price lists for different regions. You can define two types of price lists — **Standard** and **Promotional**. You can also set eligibility criteria for the price list with effective start date, end date, and description. At present, there is no functionality associated with the price list type. The implementation team can use the price list type to define the custom logic as per the business requirements.

A price list and price item pricing within the price list are effective for a particular duration. You can define multiple pricing for the same price item and variance parameter or product parameters combination within a price list when the

price item pricing date range is different. You can assign the same price item in multiple price lists and define different pricing for the price item in each price list based on the business requirements.

The system enables you to specify the duration for which the price list is available for assignment to an account or a person. However, note that at present, the availability start and end dates are not used in the product while assigning a price list to an account or a person. If required, the implementation team can build the custom logic using the availability start and end dates in the product.

Once you create a price list, you have to assign price items to the price list and define pricing for each price item assigned to the price list. The price lists are then assigned to accounts or persons to indicate the prices that will be charged for various price items or services offered to them. You can assign multiple price lists to an account or a person for an overlapping date range. But, you need to specify the priority or order for the price list in which the pricing from the price list should be considered. You can also assign the same price list to multiple accounts or persons.

You can define whether the account or person can avail the price item pricing listed on the parent or grandparent price list if it is not available on the assigned price list. In other words, you can define whether the account or person can inherit price item pricing from the price list hierarchy.

The system allows you to create the following:

- **Default Price List** – You can create a price list and set it as a default price list for a particular division. To define a default price list for a division, you need to set the value for the **Default Price List ID** parameter in the price assignment search algorithm which is attached to the division. If the effective price item pricing is not available at any level in the customer hierarchy, the system checks whether the default price list is specified in the price assignment search algorithm. If the default price list is specified in the algorithm, the system checks whether effective price item pricing is available in the default price list and accordingly uses the price item pricing. You can have the same price list as a the default price list for multiple divisions.
- **Global Price List** – You can create one global price list in the system. It is used when the price item pricing is not available at any level in the customer hierarchy and in the default price list associated with the division. You can assign only those price items in the global price list whose the **Global Price List** option is set to **Yes**. The global price list is used while searching an effective price item pricing when the **Global Price List** parameter in the price assignment search algorithm (attached to the division) is set to **Y**. Finally, if the effective price item pricing is not available in the default and/or global price list, an error message occurs indicating that the effective price item pricing is not available in the system.
- **Template Price List** – You can define a template price list and assign template price item pricing to a template price list. You cannot assign template price list to an account or a person. You can only create a copy of a template price item pricing which is assigned to a template price list. Once you create a copy of the template price item pricing, you can save the new price item pricing in either **Active** or **Proposed** status.

Price List (Used for Searching)

The **Price List** screen allows you to search for a price list using various search criteria. It also allows you to define a price list. It contains the following zones:

- [Search Price List](#) on page 439
- [Price List Price Items](#) on page 442
- [Price Item Pricing](#) on page 443
- [Price Assignment Tree](#) on page 448

Through this screen, you can navigate to the following screens:

- [Price List Price Item Pricing](#) on page 468
- [Price List Assignments](#) on page 523
- [Entities Eligible for Price List Assignment](#) on page 525
- [Price Item Pricing \(Used for Viewing\)](#) on page 614

Search Price List

The **Search Price List** zone allows you to search for a price list using various search criteria. It contains the following two sections:

- **Search Criteria** - The **Search Criteria** section contains the following fields:





Field Name	Field Description	Mandatory (Yes or No)
Search By	Used to indicate whether you want to search for a price list using the price list details. The valid value is: <ul style="list-style-type: none"> • Price List Details 	Yes
	Note: By default, the Price List Details option is selected.	
Price List ID	Used to search a particular price list.	No
Price List Description	Used to search price lists with a particular description.	No
Effective Start Date	Used to search price lists which are effective from a particular date onwards.	No
Effective End Date	Used to search price lists which are effective till a particular date.	No
Price List Type	Used to search price lists which belong to a particular type. The valid values are: <ul style="list-style-type: none"> • Promotional • Standard 	No
	Note: By default, the Standard option is selected.	
Global Price List	Used to indicate whether you want to search global price lists. The valid values are: <ul style="list-style-type: none"> • Yes • No 	No
Availability Start Date	Used to search price lists which are available for assignment to an account or a person from a particular date.	No
	Note: This field appears when you click the Advanced Search link in the top right corner of this zone.	
Availability End Date	Used to search price lists which are available for assignment to an account or a person till a particular date.	No

Field Name	Field Description	Mandatory (Yes or No)
	Note: This field appears when you click the Advanced Search link in the top right corner of this zone.	
Status	Used to search price lists with a particular status. The valid values are: <ul style="list-style-type: none"> • Active • Inactive • Proposed • Template Note: This field appears when you click the Advanced Search link in the top right corner of this zone.	No
Division	Used to search price lists which are associated with a particular division. Note: You can only view those divisions to which you have access in the Division list.	No
Parent Price List	Used to search price lists which inherit pricing from a particular parent price list. Note: <p>The Search (🔍) icon appears corresponding to this field. On clicking the Search icon, the Price List Search window appears where you can search for the respective parent price list.</p> <p>This field appears when you click the Advanced Search link in the top right corner of this zone.</p>	No
Parent Price List Effective Date	Used to search price lists that inherit pricing from a particular parent price list which is effective from a particular date onwards. Note: This field appears when you click the Advanced Search link in the top right corner of this zone.	No

Note: You must specify at least one search criterion while searching for a price list.

- **Search Results** – On clicking the **Search** button, the search results appear based on the specified search criteria. The **Search Results** section contains the following columns:

Column Name	Column Description
Price List Information	Displays the concatenated string of information about the price list separated by a comma (,).

Column Name	Column Description
	Note: It has a link. On clicking the link, the Price List screen appears where you can view the details of the respective price list.
Status	Indicates the current status of the price list. The valid values are: <ul style="list-style-type: none"> • Active • Inactive • Proposed • Template
Effective Start Date	Displays the date from when the price list is effective.
Effective End Date	Displays the date till when the price list is effective.
Availability Start Date	Displays the date from when the price list is available for assignment to an account or a person.
Availability End Date	Displays the date till when the price list is available for assignment to an account or a person.
Duplicate	On clicking the Duplicate () icon, the Price List screen appears where you can create a new price list using an existing price list.
Price List Pricing	On clicking the View () icon in the Price List Pricing column, the Price List Price Item Pricing screen appears where you can view and edit a list of price items pricing information assigned to the price list.
Price List Assigned To	On clicking the View () icon in the Price List Assigned To column, the Price List Assignments screen appears where you can view the details of the persons and accounts to which the price list is assigned.
Eligible Accounts/Persons	On clicking the View () icon in the Eligible Accounts/Persons column, the Entities Eligible for Price List Assignment screen appears where you can search for a list of eligible accounts and persons to which you want to assign the price list in a particular division.

Note:

However, when you search for a price list by specifying the date (which can be current, past or future date) in the **Parent Price List Effective Date** field, the system retrieves the price lists that meet the search criteria along with the details of the parent price list that is effective on that date.

Pagination is used to display limited number of records in the **Search Results** section. You can use the navigation links, such as **Previous** and **Next** to navigate between pages.

By default, the **Filter** area is visible. You can hide the **Filter** area by clicking the **Filters** () icon in the upper right corner of this zone.

On clicking the **Broadcast** () icon corresponding to the **Price List Information** field, the **Price List Price Items** zone appears where you can view a list of price items to which the price list is assigned.

Related Topics

For more information on...	See...
Price List Price Items zone	Price List Price Items on page 469
How to search for a price list	Searching for a Price List on page 449
How to view price items assigned to a price list	Viewing Price Items Assigned to a Price List on page 450
How to define a price list	Defining a Price List on page 450
How to copy a price list	Copying a Price List on page 459
How to view price list price items and assign price items	Price List Price Item Pricing on page 468
How to view the details of the price list assigned	Price List Assignments on page 523
How to search for eligible accounts and persons to be assigned to the price list.	Entities Eligible for Price List Assignment on page 525

Price List Price Items

The **Price List Price Items** zone lists price items that are assigned to the price list. You will not find any records in this zone if the price list does not have any price items assigned to it. It contains the following columns:

Column Name	Column Description
Pricing Information	<p>Displays the concatenated string consisting of pricing information and pricing ID which are separated by a comma (,) for the price list.</p> <p>Note: It has a link. On clicking the link, the Price Item Pricing screen appears where you can view the pricing information of the respective price list.</p>
Price Item	Displays the price item or price item bundle.
Pricing Parameters	<p>Used to specify multiple parameters based on which you want to determine the pricing utilization.</p> <p>Note: This column appears only when the Multi Price Parameter option type of the Multi Parameter Based Pricing (C1_PPARAM_FLG) feature configuration is set to True.</p>
Pricing Status	<p>Displays the status of pricing for the price item. The valid values are:</p> <ul style="list-style-type: none"> • Active • Inactive
Rate Info	<p>Displays the rate of the price item.</p> <p>Note:</p> <p>If the price assignment has only one price component, you can view the rate defined in the pricing directly through the Rate Info column.</p> <p>However, if the price assignment has more than one price components, then the Rate Info column contains a string indicating the tiering type and pricing currency. It also contains “...” which indicates that for more information about the pricing you should navigate to the Price Item Pricing screen.</p>
Start Date	Displays the date from when the price item pricing is effective for the price list.

Column Name	Column Description
End Date	Displays the date till when the price item pricing is effective for the price list.
Price Assignment Type	<p>Indicates the type of the price item pricing. The valid values are:</p> <ul style="list-style-type: none"> • Regular • Post Processing • Post Processing – Invoice Based • Post Processing – Price Item Based <p>Note: This column appears when the Multi Price Parameter option type of the Multi Parameter Based Pricing (C1_PPARM_FLG) feature configuration is set to True.</p>
Duplicate	On clicking the Duplicate () icon, the Price Item Pricing screen appears where you can define a new price item pricing using an existing price item pricing.

By default, the **Price List Price Items** zone does not appear in the **Price List** screen. It appears when you click the **Broadcast** () icon corresponding to the price list in the **Search Price List** zone.

You can filter the list using various search criteria (such as, **Price Item** and **Effective Start Date**) available in the **Filter** area. By default, the **Filter** area is hidden. You can view the **Filter** area by clicking the **Filters** () icon in the upper right corner of this zone.

On clicking the **Broadcast** () icon corresponding to the **Pricing Information** field, the **Price Item Pricing** and **Pricing Structure** zones appear where you can view the details about the price item pricing and its structure.

You can change the layout of this zone. For more information on how to change the layout, see [Changing the Layout](#) on page 4300.

Related Topics

For more information on...	See...
Search Price List zone	Search Price List on page 439
Price Item Pricing zone	Price Item Pricing on page 443
Pricing Structure zone	Price Assignment Tree on page 448
How to view price items assigned to a price list	Viewing Price Items Assigned to a Price List on page 450
How to view price item pricing of a price list	Viewing a Price Item Pricing on page 477

Price Item Pricing

The **Price Item Pricing** zone displays the details of the price item pricing. It contains the following sections:

- **Main** - Displays basic information about the pricing of the price item. It contains the following fields:

Field Name	Field Description
Start Date	Displays the date from when the pricing of the price item is effective.
End Date	Displays the date till when the pricing of the price item is effective.
Price Assignment Type	Indicates the type of price assignment. The valid values are:

Field Name	Field Description
	<ul style="list-style-type: none"> • Post Processing – Indicates that the pricing is used to generate post processing bill segment. This type of price assignment can be done on usage accounts. The post processing bill segment is generated when you generate the bill for the usage account and not when you bill the usage account through an invoice account. • Post Processing – Invoice Based – Indicates that the pricing is used to generate post processing bill segment. This type of price assignment is done on an invoice account, and, as a result, the post processing bill segment is generated on the invoice account. <div style="border: 1px solid black; padding: 5px; margin: 5px 0;"> <p>Note: This is not applicable for price items which are defined for Pricing and where the Price Item Type field is set to Fees.</p> </div> <ul style="list-style-type: none"> • Post Processing – Price Item Based – Indicates that the pricing is used to generate post processing bill segment. This type of price assignment is done on both invoice and usage accounts, but the post processing bill segment is generated only on the invoice account. • Regular – Indicates that the pricing is used to generate regular bill segment. <div style="border: 1px solid black; padding: 5px; margin: 5px 0;"> <p>Note: This is not applicable for price items which are defined for Pricing and where the Price Item Type field is set to Fees. By default, the Regular option is selected in the Bundle Type field for price item which are applicable for Pricing and cannot be edited. The post processing bill segment is generated when the Post Processing Sequence (PPSEQ) characteristic is defined for the price item and when the price item is associated with another price item using the Price Item relationship type.</p> </div>
Pricing Eligibility	Indicates whether the price item pricing is eligible for pricing assignment or not.
Pricing Status	<p>Indicates the pricing assignment status of the price item pricing. The valid values are:</p> <ul style="list-style-type: none"> • Draft • Active • Inactive • Proposed • Rejected • Template
Pricing Currency	<p>Indicates the currency in which the price item pricing is defined.</p> <div style="border: 1px solid black; padding: 5px; margin-top: 5px;"> <p>Note: It has a link. On clicking the link, the Currency screen appears where you can view the details of the currency.</p> </div>
Rate Schedule	Indicates the rate schedule that is used to define the price item pricing.

Field Name	Field Description
	Note: It has a link. On clicking the link, the Rate Schedule screen appears where you can view the details of the rate schedule.
Pricing Rule Type	Indicates the pricing rule type. The valid value is: <ul style="list-style-type: none"> Two-Dimensional
Print Zero	Indicates the zero pricing displayed in the bill. The valid values are: <ul style="list-style-type: none"> Yes No
Price Assignment Usage	Indicates whether the price item pricing is applicable to all customers or only to new customers. The valid values are: <ul style="list-style-type: none"> All Customers New Customers

- **Deal Information** – Displays the average price floor and ceil type defined in a price item pricing. It contains the following fields:

Field Name	Field Description
Average Price Floor and Ceil Type	Indicates the manner in which you want to define the average price floor and ceil limits of the price item or price item bundle in a deal. The valid values are: <ul style="list-style-type: none"> Absolute Value Range Spread Amount Spread Percentage

- **TFM Information** – Displays the transactions mapped to the price item pricing. It contains the following fields:

Field Name	Field Description
Ignore Transaction	Indicates whether the transactions mapped to the price item pricing is considered for billing or not. The valid values are: <ul style="list-style-type: none"> Yes No
Aggregate Transactions	Indicates whether the transactions mapped to the price item pricing is aggregated for billing or not. The valid values are: <ul style="list-style-type: none"> Yes No
Aggregation Schedule	Indicates the transaction aggregation cycle. The valid values are: <ul style="list-style-type: none"> Daily Weekly Monthly Quarterly Yearly

Field Name	Field Description
Transaction Rating Criteria	Indicates how and when the transaction legs mapped to the price item are rated. The valid values are: <ul style="list-style-type: none"> Aggregate Transactions and Then Rate Aggregated SQs Do Not Rate Transactions

Note:

TFM Information section appears when the value for **Show Default Values in Price Item Pricing** option type of **C1_FM feature configuration** is set to **Y** and **Price Item Usage** field is set to **Pricing and Billing**.

TFM Information section does not appear when the **Price Item Usage** field is set to **Only Pricing** and the **Price Item Type** field is set to **Fees**, then, only the **Pricing Frequency** field appears.

- **Characteristics** – Lists the characteristics defined for the price item pricing. It contains the following columns:

Column Name	Column Description
Effective Date	Displays the date from when the characteristic is effective for the price item pricing.
Characteristic Type	Indicates the characteristic type.
Characteristic Value	Displays the value of the characteristic type.

- **Price Item and Parameter Information** – Displays the parameter details for the price item pricing. It contains the following field:

Field Name	Field Description
Price Item Information	Indicates the price item or price item bundle whose pricing details are listed in this section.

In addition, this section contains the following columns:

Column Name	Column Description
Parameter	Indicates the parameter that is associated with the price item pricing.
Parameter Value	Displays the parameter value.

- **Division-Specific Average Price Floor and Ceil Values for Price Item** – lists the characteristics of the price item pricing. It contains the following columns:

Column Name	Column Description
To Do Role	Indicates that the users with the specified To Do role can approve the average price of the price item or price item bundle in a deal when it is within the specified floor and ceil limits. <p>Note: It has a link. On clicking the link, the To Do Role screen appears where you can view the details of the respective To Do role.</p>
Floor Value	Displays the floor (i.e. lower) limit of the To Do role. <p>Note: This column appears when the Absolute Value Range option is selected for the Average Price Floor and Ceil Type list for a price item or price item bundle.</p>
Ceil Value	Displays the ceil (i.e. upper) limit of the To Do role.

Column Name	Column Description
	Note: This column appears when the Absolute Value Range option is selected for the Average Price Floor and Ceil Type list for a price item or price item bundle.
Spread Amount	Indicates the spread amount specified while defining a price item or price item bundle or assigned to a To Do role. Note: This column appears when the Spread Amount option is selected for the Average Price Floor and Ceil Type list for a price item or price item bundle.
Spread Percentage	Indicates the spread percentage specified while defining a price item or price item bundle or assigned to a To Do role. Note: This column appears when the Spread Percentage option is selected for the Average Price Floor and Ceil Type list for a price item or price item bundle.
Floor and Ceil Currency	Indicates the currency in which the average price floor and ceil limits are defined for the price item or price item bundle.
Division	Indicates the division to which the price item belongs.

- **Division-Specific Negotiability Floor and Ceil Values for Price Item** – lists the characteristics of the price item pricing. It contains the following columns:

Column Name	Column Description
Division	Indicates the division to which the price item belongs.
Floor Value	Indicates the floor (i.e. lower) limit for the rate negotiation.
Ceil Value	Indicates the ceil (i.e. lower) limit for the rate negotiation.

- **Division-Specific SQIs for Price Item** – lists the characteristics of the price item pricing. It contains the following columns:

Column Name	Column Description
SQI	Displays the Service Quantity Identifier (SQI) associated with the price item or price item bundle for a division.
Daily Service Quantity	Displays the SQI value which is calculated using the transaction aggregation rule defined for the price item - division combination.
Usage Period	Displays the period for which you want to aggregate the deal data to determine the scope of the deal.
Division	Indicates the division to which the price item belongs.

- **Division-Specific Cost for Price Item** – lists the characteristics of the price item pricing. It contains the following columns:

Column Name	Column Description
Cost Type	Indicates the type of cost incurred in the division for the price item or price item.
Cost Value	Displays the cost amount.

- **Record Actions** – This section contains the following buttons:

Column Name	Column Description
Edit	Used to edit the details of the price item pricing.
	Note: The Edit button appears when the price item pricing is in the Draft status.
Delete	Used to delete the price item pricing.
	Note: The Delete button appears when the price item pricing is in the Draft status.
Submit	Used to submit the price item pricing for validation and processing.
	Note: The Submit button appears when the price item pricing is in the Draft status.

- **Record Information** – This section contains the following field:

Field Name	Field Description
Business Object	Indicates the business object using which the price item pricing is created. In addition, a context menu appears corresponding to this field which helps in navigating to other screens in the application.
	Note: It has a link. On clicking the link, the Business Object screen appears where you can view the details of the respective business object.

By default, the **Price Item Pricing** zone does not appear in the **Price List** screen. It appears when you click the **Broadcast** () icon corresponding to the price item pricing in the **Price List Price Item** zone.

Related Topics:

For more information on...	See...
Price List screen	Price List (Used for Searching) on page 438
Price List Price Item zone	Price List Price Items on page 442

Price Assignment Tree

Note: This topic is not applicable for the health insurance business.

The **Price Assignment Tree** zone displays the details about the rate components and its price components for the price item along with the tiering criteria and pricing eligibility details.

It also allows you to do the following:

- Define, edit, copy, or delete the price component of the rate component

Note: You can define, edit, copy, or delete the price component of the rate component when the price item pricing is in **Draft**, **Proposed**, or **Template** status.

- Define, edit, copy, or delete the tiering criteria of the price component

Note: You can define, edit, copy, or delete the tiering criteria of the price component when the price item pricing is in **Draft**, **Proposed**, or **Template** status.

- Define, edit, copy, or delete the pricing eligibility criteria of the price component

Note: You can define, edit, copy, or delete the eligibility criteria of the price component when the price item pricing is in **Draft**, **Proposed**, or **Template** status.

Note: You cannot define, edit, copy, or delete a price component when you are accessing the **Price Assignment Tree** zone from the **Price List** screen.

Related Topics:

For more information on...	See...
How to view a price component of a rate component in a price item pricing	Viewing the Price Components of a Rate Component on page 641
How to view a tiering criteria of a price component	Viewing the Tiering Criteria of a Price Component on page 643
How to view a pricing eligibility criteria of a price component	Viewing the Pricing Eligibility Criteria of a Price Component on page 645
How to define price component of a rate component in a price item pricing	Defining a Price Component for a Rate Component on page 647
How to edit a price component of a rate component in a price item pricing	Editing a Price Component on page 658
How to copy a price component of a rate component in a price item pricing	Copying a Price Component on page 662
How to delete a price component of a rate component in a price item pricing	Deleting a Price Component on page 666
How to define tiering criteria of a price component in a price item pricing	Defining a Tiering Criteria for a Price Component on page 652
How to define pricing eligibility criteria of a price component in a price item pricing	Defining a Pricing Eligibility Criteria for a Price Component on page 654

Searching for a Price List

Prerequisites

To search for a price list, you should have:

- Divisions defined in the application
- Price list associated with the division to which the user belongs

Procedure

To search for a price list:

1. Click the **Menu** link in the **Application** toolbar.
A list appears.
2. From the **Main** menu, select **Pricing Management** and then click **Price List**.
A sub-menu appears.
3. Click the **Search** option from the **Price List** sub-menu.
The **Price List** screen appears.
4. Enter the search criteria in the **Search Price List** zone.

Note: ORMB search engine supports wildcard search, where you can substitute the percentage (%) symbol as a stand in for any word or letter in a search criteria. You can use the ‘%’ wildcard character in all input fields except the date and ID fields. The ‘%’ wildcard character is suffixed automatically at the end of the partial search criteria. Therefore, you may or may not specify the wildcard character at the end of the partial search criteria. However, you have to prefix the wildcard character manually wherever required.

5. Click **Search**.

A list of price lists that meet the search criteria appears in the **Search Results** section.

Note: Pagination is used to display limited number of records in the **Search Results** section. You can use the navigation links, such as **Previous** and **Next** to navigate between pages.

Related Topics

For more information on...	See...
Price List screen	Price List (Used for Viewing) on page 463
Search Price List zone	Search Price List on page 439

Viewing Price Items Assigned to a Price List

Prerequisites

To view price items assigned to a price list, you should have:

- An algorithm defined using the **C1-PLPINFO** algorithm type and attached to **Pricelist Products Assignment Information** system event in the **Algorithms** tab of the **Installation Options – Framework** screen

Procedure

To view price items assigned to a price list:

1. Search for the price list in the **Price List** screen.
2. In the **Search Results** section, click the **Broadcast** (📡) icon corresponding to the price list whose price items details you want to view.

The **Price List Price Items** zone appears.

3. View the price items that are assigned to the price list in the **Price List Price Items** zone.

Related Topics

For more information on...	See...
How to search for a price list	Searching for a Price List on page 449
Price List Price Items zone	Price List Price Items on page 442

Defining a Price List

Procedure

To define a price list:

1. Click the **Menu** link in the **Application** toolbar.
A list appears.
2. From the **Main** menu, select **Pricing Management** and then click **Price List**.
A sub-menu appears.
3. Click the **Add** option from the **Price List** sub-menu.

The **Price List** screen appears. It consists the following sections:

- **Main** - Used to specify basic details about the price list.
- **Hierarchy** - Used to associate the price list with one or more parent price lists for a particular duration.
- **Divisions** - Used to associate the price list with one or more divisions.
- **Eligibility** - Used to define eligibility criteria for the price list.
- **Characteristics** - Used to define the characteristics for the price list.

The **Main** section contains the following fields:

Field Name	Field Description	Mandatory (Yes or No)
Price List Description	Used to specify the description for the price list.	Yes
Effective Start Date	Used to specify the date from when the price list is effective.	Yes
	Note: By default, the current date appears in this field.	
Effective End Date	Used to specify the date till when the price list is effective.	No
	Note: The effective end date cannot be earlier than the effective start date.	
Price List Type	Used to indicate the type of the price list. The valid values are: <ul style="list-style-type: none"> • Standard • Promotional 	Yes
	Note: By default, the Standard option is selected.	
Global Price List	Used to indicate whether the price list is a global price list. The valid values are: <ul style="list-style-type: none"> • Yes • No 	Yes
Availability Start Date	Used to the specify the date from when the price list is available for assignment to an account or a person.	No
	Note: At present, the availability start date is not used in the price item while assigning a price list to an account or a person. It is available for future use.	
Availability End Date	Used to the specify the date till when the price list is available for assignment to an account or a person.	No

Field Name	Field Description	Mandatory (Yes or No)
	<p>Note:</p> <p>The availability end date cannot be earlier than the availability start date.</p> <p>At present, the availability end date is not used in the price item while assigning a price list to an account or a person. It is available for future use.</p>	
Available for Deal Pricing	Used to indicate whether the price list is available for deal pricing or not.	No
Standard for Deal Pricing	Used to indicate whether the price list is applicable for defining costs or floor and ceil limits or commitments at the time of deal pricing.	No
Validity Period (in Days)	Used to specify the period in days for which the price list is valid. It is used to calculate price list assignment validity end date while assigning the price list to an account or a person.	No
Status	<p>Used to indicate the status of the price list. The valid values are:</p> <ul style="list-style-type: none"> • Active - Used to indicate that the price list is used for billing. • Inactive - Used to indicate that the price list is no longer used for billing. • Proposed - Used to indicate that the price list is used for quotations. • Template - Used to indicate that the price list is a template price list. 	Yes
	<p>Note: By default, the Active option is selected.</p>	

Tip: Alternatively, you can access the **Price List** screen by clicking the **Add** button in the **Page Title** area of the **Price List** screen.

4. Enter the required details in the **Main** section.

Note: By default the **Main** section is displayed.

5. Click the **Show All** link from the **Section** to view all the sections and define or associate the following:
- Associate the price list with one or more parent price list, if required.
 - Associate price list with one or more divisions, if required.
 - Define eligibility criteria for the price list, if required.
 - Define characteristics for the price list, if required.
6. Click **Save**.

Note: The price list ID is generated automatically when the price list is created.

Related Topics

For more information on...	See...
Price List screen	Price List (Used for Viewing) on page 463
Price List screen	Price List (Used for Searching) on page 438
How to define the price list hierarchy	Defining the Price List Hierarchy on page 453
How to define a characteristic for a price list	Defining a Characteristic for a Price List on page 454
How to associate a price list with a division	Associating a Price List with a Division on page 455
How to define eligibility criteria for a price list	Defining Eligibility Criteria for a Price List on page 456

Defining the Price List Hierarchy

Oracle Revenue Management and Billing allows you to define the price list hierarchy. It helps you to inherit the price item pricing from the parent price list if the price item pricing is not available in the price list (assigned to the account, person, or parent person). And, if the price item pricing is not available in the parent price list, the system will search for the price item pricing in the parent's parent price list (i.e. in the grandparent price list) and continue till it reaches the last level in the hierarchy.

In other words, when you define the price list hierarchy and assign the price list to an account or a person, the account or person can avail the price item pricing listed on the parent or grandparent price list if it is not available on the assigned price list. However, if the price item pricing is available on both the assigned and parent price lists, the system derives the price item pricing from the assigned price list.

You can define multiple parent price lists for a price list. But, only one parent price list is effective for a particular duration. Two or more price lists can have the same parent price list.

Procedure

To define the price list hierarchy:

1. Click the **Hierarchy** or **Show All** link from the **Section** in the **Price List** screen when you are defining, editing, or copying a price list.

The **Hierarchy** section appears. It contains the following fields in a grid:

Field Name	Field Description	Mandatory (Yes or No)
Parent Price List Effective From Date	Used to specify the date from when the price list inherits pricing from the parent price list.	Yes (Conditional) Note: This field is required when you are associating the price list with a parent price list.
Parent Price List Effective To Date	Used to specify the date till when the price list inherits pricing from the parent price list. Note: The parent price list effective to date cannot be earlier than the parent price list effective from date and later than price list effective end date.	No
Parent Price List	Used to specify the parent price list ID to which you want to associate the price list.	Yes (Conditional) Note: This field is required when you are associating the price list with a parent price list.

Field Name	Field Description	Mandatory (Yes or No)
	<p>Note:</p> <p>The Search (🔍) icon appears corresponding to this field. On clicking the Search icon, the Price List Search window appears.</p> <p>On specifying the parent price list, the description of the parent price list appears corresponding to the Parent Price List field.</p>	

- Enter the required details in the **Hierarchy** section.

Note: You can search for a price list by clicking the **Search** (🔍) icon corresponding to the **Parent Price List** field.

- If you want to associate the price list with more than one parent price list, click the **Add** (+) icon corresponding to the parent price list and then repeat step 2.

Note:

You can associate a price list with multiple parent price lists. But, only one parent price list is effective for a particular duration. Also, while associating a price list with a parent price list, you can only specify a price list which is effective during the specified duration.

If you want to remove a parent price list from the price list hierarchy, click the **Delete** (🗑️) icon corresponding to the parent price list.

- Click **Save**.

The price list is associated with the parent price lists.

Related Topics

For more information on...	See...
How to define a price list	Defining a Price List on page 450
How to edit a price list	Editing a Price List on page 466
How to copy a price list	Copying a Price List on page 459

Defining a Characteristic for a Price List

Prerequisites

To define a characteristic for a price list, you should have:

- Characteristic types defined in the application (where the characteristic entity is set to **Price List**)

Procedure

To define a characteristics for a price list:

- Click the **Characteristics** or **Show All** link from the **Section** in the **Price List** window when you are defining, editing, or copying a price list.

The **Characteristics** section appears. It contains the following fields in a grid:

Field Name	Field Description	Mandatory (Yes or No)
Effective Date	Used to specify the date from when the characteristic is effective for the price list.	Yes (Conditional)
		Note: This field is required when you are defining a characteristic for the price list.
Characteristic Type	Used to indicate the characteristic type. Note: The list includes only those characteristic types where the characteristic entity is set to Price List .	Yes (Conditional)
		Note: This field is required when you are defining a characteristic for the price list.
Characteristic Value	Used to specify the value for the characteristic type. Note: The Search (🔍) icon appears corresponding to this field. On clicking the Search icon, the Predefined Characteristic Search window appears. On specifying the value for a predefined characteristic type, the description of the characteristic value appears corresponding to the Characteristic Value field.	Yes (Conditional)
		Note: This field is required when you are defining a characteristic for the price list.

- Enter the required details in the **Characteristics** section.

Note: If you select a predefined characteristic type, the **Search** (🔍) icon appears corresponding to the **Characteristic Value** field. On clicking the **Search** icon, you can search for a predefined characteristic value.

- If you want to define more than one characteristic for the price list, click the **Add** (+) icon and then repeat step 2.

Note: However, if you want to remove a characteristic from the price list, click the **Delete** (🗑️) icon corresponding to the characteristic.

- Click **Save**.

The characteristics are defined for the price list.

Related Topics

For more information on...	See...
How to define a price list	Defining a Price List on page 450
How to edit a price list	Editing a Price List on page 466
How to copy a price list	Copying a Price List on page 459

Associating a Price List with a Division

You can assign a price list only to those accounts or persons which belong to the division to which the price list is associated. Therefore, you need to associate the price list with appropriate divisions.

Prerequisites

To associate a price list with a division, you should have:

- Divisions defined in the application

Procedure

To associate a price list with a division:

1. Click the **Divisions** or **Show All** link from the **Section** in the **Price List** window when you are defining, editing, or copying a price list.

The **Divisions** section appears. It contains the following field in a grid:

Field Name	Field Description	Mandatory (Yes or No)
Division	Used to indicate the division to which you want to associate the price list.	No
	Note: You can only view those divisions to which you have access in the Division list.	

2. Select the required division from the list.
3. If you want to associate the price list with more than one division, click the **Add (+)** icon corresponding to the division and then repeat step 2.

Note: However, if you want to remove the price list from a division, click the **Delete** (🗑️) icon corresponding to the division.

4. Click **Save**.

The price list is associated with the divisions.

Tip: Alternatively, you can associate a price list with a division using the **Division** screen.

Related Topics

For more information on...	See...
How to define a price list	Defining a Price List on page 450
How to edit a price list	Editing a Price List on page 466
How to copy a price list	Copying a Price List on page 459

Defining Eligibility Criteria for a Price List**Prerequisites**

To define eligibility criteria for a price list, you should have:

- The **Price List Eligibility Criteria** check box selected in the **Parameter Usage** section while defining the parameter

Procedure

To define eligibility criteria for a price list:

1. Click the **Eligibility** or **Show All** link from the **Section** in the **Price List** screen when you are defining, editing, or copying a price list.

The **Eligibility** section appears. It contains the following fields in a grid:

Column Name	Column Description	Mandatory (Yes or No)
Criteria	On clicking the Add (+) icon, you can associate eligibility criteria of parameters for the price list.	Yes (Conditional) Note: This field is required when you are defining an eligibility criteria for the price list.
Effective Start Date	Used to specify the date from when the criteria is effective for the price list.	Yes (Conditional) Note: This field is required when you are defining an eligibility criteria for the price list.
Effective End Date	Used to specify the date till when the criteria is effective for the price list.	No
Description	Used to specify the description for the criteria type.	Yes

- Enter the required details in the **Eligibility** section.
- If you want to define more than one eligibility criteria for the price list, click the **Add** (+) icon and then repeat step 2.

Note: However, if you want to remove the eligibility criteria, click the **Delete** (🗑️) icon corresponding to the criteria.

- Associate eligibility criteria of parameter for the price list, if required.
- If you want to define more than one eligibility criteria of parameter for the price item, click the **Add** (+) icon corresponding to the parameter.

Note: However, if you want to remove the eligibility criteria of parameter for the price item, click the **Delete** (🗑️) icon corresponding to the parameter.

- Click **Save**.

The eligibility criteria are defined for the price list.

Related Topics

For more information on...	See...
How to create a price list	Defining a Price List on page 450
How to edit a price list	Editing a Price List on page 466
How to associate eligibility criteria of parameter for a price list	Associating Eligibility Criteria of Parameters for a Price List on page 457

Associating Eligibility Criteria of Parameters for a Price List

Prerequisites

To associate eligibility criteria of parameter for a price list, you should have:

- Parameter value types defined in the application
- Price list eligibility criteria associated with the parameter

Procedure

To associate eligibility criteria of parameters for a price list:

1. Click the **Eligibility** or **Show All** link from the **Section** in the **Price List** screen when you are defining, editing or copying a price list.

The **Eligibility** section appears.

2. Click the **Add**  icon in the **Criteria** column to associate eligibility criteria of parameters for the price list.

The following fields appear in a grid:

Column Name	Column Description	Mandatory (Yes or No)
Sequence Number	Used to indicate the order in which the price list eligibility criteria should be executed.	Yes
Parameter	Used to indicate the parameter (on the left hand side) which is used in the pricing eligibility criteria.	Yes
Operator	Used to specify the relational operator to define the relation between the parameter name and value.	Yes
Parameter Value Type	Used to indicate whether the parameter (on the left hand side) must be compared against another parameter (on the right hand side) or directly against a parameter value.	Yes
Parameter	Used to indicate the parameter (on the right hand side) against which you want to compare the parameter (on the left hand side).	Yes
Parameter Value	Used to indicate the parameter value against which you want to compare the parameter (on the left hand side).	Yes
Is True	Used to indicate what should happen when the condition is true (satisfied). The valid values are: <ul style="list-style-type: none"> • Check Next Condition – Used to indicate that the condition with consecutive sequence number should be executed. • Rule Is False – Used to indicate that the action specified in the Rule False Action field should be executed • Rule Is True – Used to indicate that the action specified in the Rule True Action field should be executed. 	Yes
Is False	Used to indicate what should happen when the condition is false (not satisfied). The valid values are:	Yes

Column Name	Column Description	Mandatory (Yes or No)
	<ul style="list-style-type: none"> • Check Next Condition – Used to indicate that the condition with consecutive sequence number should be executed. • Rule Is False – Used to indicate that the action specified in the Rule False Action field should be executed • Rule Is True – Used to indicate that the action specified in the Rule True Action field should be executed. 	
Is Insufficient	<p>Used to indicate what should happen when the data is insufficient. The valid values are:</p> <ul style="list-style-type: none"> • Check Next Condition – Used to indicate that the condition with consecutive sequence number should be executed. • Rule Is False – Used to indicate that the action specified in the Rule False Action field should be executed • Rule Is True – Used to indicate that the action specified in the Rule True Action field should be executed. 	Yes

3. Enter the required details for the **Eligibility Criteria Parameters** in the **Eligibility Criteria** section.

Note: You can search for a parameter by clicking the **Search** (🔍) icon appears corresponding to the respective field.

4. If you want to associate more than one parameter with eligibility-criteria for the price list, click the **Add** (+) icon and then repeat step 3.

Note: However, if you want to remove a parameter with eligibility-criteria from the price list, click the **Delete** (🗑️) icon corresponding to it.

5. Click **Save**.

The parameter with eligibility-criteria are associated for the price list.

Related Topics

For more information on...	See...
How to define a price item or price item bundle	Defining a Price Item or Price Item Bundle on page 361
How to copy a price item or price item bundle	Copying a Price Item or Price Item Bundle on page 394
How to define eligibility-criteria for a price list	Defining Eligibility Criteria for a Price List on page 456

Copying a Price List

Instead of creating a price list from scratch, you can create a new price list using an existing price list. This is possible through copying a price list. On copying a price list, the details including the pricing parameters, divisions, characteristics, eligibility criteria, and the assigned price items are copied to the new price list. You can then edit the details, if required.

Prerequisites

To copy a price list, you should have:

- Price list (whose copy you want to create) defined in the application
- Price list (whose copy you want to create) associated with the division to which the user belongs

Procedure

To copy a price list:

1. Search for the price list in the **Price List** screen.
2. In the **Search Results** section, click the **Copy**  icon in the **Copy** column corresponding to the price list using which you want to define a new price list.

The **Price List** screen appears. It contains the following sections:

- **Main** – Used to specify basic details about the price list.
- **Hierarchy** – Used to define parent price list for the price list for a particular duration.
- **Divisions** – Used to associate price list with one or more divisions.
- **Eligibility Criteria** – Used to define eligibility criteria for price list.
- **Characteristics** – Used to define the characteristics (which are applicable across divisions) for the price list.

The **Main** section contains the following fields:

Field Name	Field Description	Mandatory (Yes or No)
Price List Description	Used to specify the description for the price list.	Yes
Effective Start Date	Used to specify the date from when the price list is effective	Yes
Effective End Date	Used to specify the date till when the price list is effective.	No
Price List Type	Used to indicate the type of the price list. The valid values are: <ul style="list-style-type: none"> • Standard • Promotional 	Yes
Global Price List	Used to Indicate whether the price list is a global price list. The valid values are: <ul style="list-style-type: none"> • Yes • No 	Yes
Availability Start Date	Used to specify the date from when the price list is available for assignment to an account or a person.	Yes
Availability End date	Used to specify the date till when the price list is available for assignment to an account or a person.	No
Available for Deal Pricing	Used to indicate whether the price list is available for deal pricing or not.	No
Standard for Deal Pricing	Used to indicate whether the price list is applicable for defining costs or floor and ceil limits or commitments at the time of deal pricing.	No

Field Name	Field Description	Mandatory (Yes or No)
Validity Period (in Days)	Used to specify the period in days for which the price list is valid. It is used to calculate price list assignment validity end date while assigning the price list to an account or a person.	Yes
Status	Used to indicate the status of the price list. The valid values are: <ul style="list-style-type: none"> Active Proposed Template 	Yes
Copy Pricing	Used to indicate whether you want to copy the pricing information to the price list. The valid values are: <ul style="list-style-type: none"> All None 	Yes (Conditional)

- Enter the required details in the **Main** section.
- Add, edit, or remove the parent price list details, if required.
- Associate or disassociate the price list from the required divisions.
- Define, edit, or remove the price list eligibility criteria and parameter eligibility criteria for price list in the, if required.
- Define, edit, or remove characteristics of the price list, if required.
- Click **Save**.

The new price list is defined.

Note: The price list ID is generated automatically when the price list is defined.

Related Topics

For more information on...	See...
How to search for a price list	Searching for a Price List on page 449
How to define the price list hierarchy	Defining the Price List Hierarchy on page 453
How to define a characteristic for a price list	Defining a Characteristic for a Price List on page 454
How to associate a price list with a division	Associating a Price List with a Division on page 455
How to define eligibility criteria for the price list	Defining Eligibility Criteria for a Price List on page 456

Viewing the Price List Details

Procedure

To view the details of a price list:

- Search for the price list in the **Price List** screen.
- In the **Search Results** section, click the link in the **Price List Information** column corresponding to the price list whose details you want to view.

The **Price List** screen appears. It contains the following zones:

- [Price List](#) on page 463

- [Eligibility Criteria](#) on page 465
 - [Price List Price Items](#) on page 442
3. View the basic details, hierarchy, divisions, and characteristics of the price list in the **Price List** zone.
 4. View the eligibility criteria to which the price list is associated in the **Eligibility Criteria** zone.
 5. View the price items that are assigned to the price list in the **Price List Price Items** zone.

Related Topics

For more information on...	See...
How to search for a price list	Searching for a Price List on page 449
Price List screen	Price List (Used for Viewing) on page 463

Viewing Accounts and Persons Eligible for Price List Assignment

Prerequisites

To view accounts and persons eligible for price list assignment, you should have:

- Accounts and Persons created in the application.
- Price list defined in the application

Procedure

To view accounts and persons eligible for price list assignment:

1. Click the **Menu** link in the **Application** toolbar.
A list appears.
2. From the **Main** menu, select **Pricing Management** and then click **Price List**.
The **Price List** screen appears.
3. You can search for a price list by entering the search criteria in the **Search Price List** zone.

Note: ORMB search engine supports wildcard search, where you can substitute the percentage (%) symbol as a stand in for any word or letter in a search criteria. You can use the ‘%’ wildcard character in all input fields except the date and ID fields. The ‘%’ wildcard character is suffixed automatically at the end of the partial search criteria. Therefore, you may or may not specify the wildcard character at the end of the partial search criteria. However, you have to prefix the wildcard character manually wherever required.

4. Click **Search**.
A list of price lists that meet the search criteria appears in the search results.
5. In the **Search Results** section, click the **Eligible Accounts and Persons** () icon in the **Eligible Accounts and Persons** column corresponding to the price list whose details you want to view.
The **Eligible Accounts and Persons** screen appears.
6. You can search for the accounts and persons which are eligible for Price List Assignment in the **Accounts Eligible for Price List Assignment** zone and **Persons Eligible for Price List Assignment** zone respectively.

Related Topics

For more information on...	See...
How to search for a price list	Searching for a Price List on page 449

For more information on...	See...
Eligible Persons zone	Eligible Persons on page 527
Eligible Accounts zone	Eligible Accounts on page 525
How to define a characteristic for a Price List Assignment	Defining a Characteristic for a Price List Assignment on page 532

Price List (Used for Viewing)

The **Price List** screen allows you to view the details of a price list. It also allows you to edit a price list. It contains the following zones:

- **Price List** - Displays the basic details of the price list.
- **Eligibility Criteria** - Displays the eligibility criteria for the price list.
- **Price List Price Items** - Displays the price items that are assigned to the price list.
- **Price Item Pricing**
 - Displays the price item pricing for price items that are assigned to the price list.
- **Pricing Structure**
 - Displays the structure of the price item pricing for price item that are assigned to the price list.

Price List

The **Price List** zone displays the details of the price list. It contains the following sections:

- **Main** - Displays basic information about the price list. It contains the following fields:

Field Name	Field Description
Price List ID	Displays the price list ID.
Price List Description	Displays the description for the price list.
Effective Start Date	Displays the date from when the price list is effective.
Effective End Date	Displays the date till when the price list is effective.
Price List Type	Indicates the type of the price list. The valid values are: <ul style="list-style-type: none"> • Standard • Promotional
Global Price List	Indicates whether the price list is a global price list. The valid values are: <ul style="list-style-type: none"> • Yes • No
Availability Start Date	Displays the date from when the price list is available for assignment to an account or a person.
Availability End date	Displays the date till when the price list is available for assignment to an account or a person.
Available for Deal Pricing	Indicates whether the price list can be assigned with a person or an account.

Field Name	Field Description
Standard for Deal Pricing	Indicates whether the price list can be considered to compare the average floor and ceil limit with the standard and average price of a price item associated with a price list.
Validity Period (in Days)	Displays the period in days for which the price list is valid. It is used to calculate price list assignment validity end date while assigning the price list to an account or a person.
Status	Indicates the status of the price list. The valid values are: <ul style="list-style-type: none"> • Active – Indicates that the price list is used for billing. • Inactive – Indicates that the price list is no longer used for billing. • Proposed – Indicates that the price list is used for quotations. • Template – Indicates that the price list is a template price list.

- **Hierarchy** - Lists the parent price list from which the price list has inherited the price item pricing for a particular duration. It contains the following columns:

Column Name	Column Description
Parent Price List ID	Displays the ID of the parent price list.
Parent Price List Effective From Date	Displays the date from when the price list can inherit pricing from the parent price list.
Parent Price List Effective To Date	Displays the date till when the price list can inherit pricing from the parent price list.

- **Divisions** - Lists the divisions to which the price list is associated. It contains the following column:

Column Name	Column Description
Division	Displays the division to which the price list is associated. Note: It has a link. On clicking the link, the Division screen appears where you can view the details of the respective division.

- **Characteristics** - Lists the characteristics that are associated with the price list. It contains the following columns:

Column Name	Column Description
Effective Date	Displays the date from when the characteristic is effective for the price list.
Characteristic Type	Displays the characteristic type.
Characteristic Value	Displays the value for the characteristic type.

- **Record Actions** - This section contains the following button:

Button Name	Button Description
Edit	Used to edit the details of the price list.

- **Record Information** - This section contains the following field:

Field Name	Field Description
Business Object	Indicates the business object using which the price list is created. In addition, a context menu appears corresponding to this field which helps in navigating to other screens in the application.
	Note: It has a link. On clicking the link, the Business Object screen appears where you can view the details of the respective business object.

Related Topics

For more information on...	See...
Price List screen	Price List (Used for Viewing) on page 463
How to define a price list	Defining a Price List on page 450
How to edit a price list	Editing a Price List on page 466

Eligibility Criteria

The **Eligibility Criteria** zone lists the eligibility criteria of the price list. It contains the following columns:

Field Name	Field Description
Effective Start Date	Displays the date from when the criteria is effective for the price list.
Effective End Date	Displays the date till when the criteria is effective for the price list.
Description	Displays the description for the criteria type.
Sequence	Indicates the order in which the price list eligibility criteria should be executed.
Parameter	Indicates the parameter (on the left hand side) is used in the pricing eligibility criteria.
Operator	Displays the relational operator to define the relation between the parameter name and value.
Parameter Value Type	Indicates whether the parameter (on the left hand side) must be compared against another parameter (on the right hand side) or directly against a parameter value.
Parameter	Indicates the parameter (on the right hand side) against which you want to compare the parameter (on the left hand side).
Parameter Value	Indicates the parameter value against which you want to compare the parameter (on the left hand side).
Is True	Indicates what happens when the condition is true (satisfied). The valid values are: <ul style="list-style-type: none"> • Check Next Condition – Indicates that the condition with consecutive sequence number should be executed. • Rule Is False – Indicates that the action specified in the Rule False Action field should be executed • Rule Is True – Indicates that the action specified in the Rule True Action field should be executed.
Is False	Indicates what happens when the condition is false (not satisfied). The valid values are:

Field Name	Field Description
	<ul style="list-style-type: none"> • Check Next Condition – Indicates that the condition with consecutive sequence number should be executed. • Rule Is False – Indicates that the action specified in the Rule False Action field should be executed • Rule Is True – Indicates that the action specified in the Rule True Action field should be executed.
Is Insufficient	<p>Indicates what happens when the data is insufficient. The valid values are:</p> <ul style="list-style-type: none"> • Check Next Condition – Indicates that the condition with consecutive sequence number should be executed. • Rule Is False – Indicates that the action specified in the Rule False Action field should be executed • Rule Is True – Indicates that the action specified in the Rule True Action field should be executed.

Related Topics

For more information on...	See...
Price List screen	Price List (Used for Viewing) on page 463

Editing a Price List

Procedure

To edit a price list:

1. Search for the price list in the **Price List** screen.
2. In the **Search Results** section, click the link in the **Price List Information** column corresponding to the price list whose details you want to edit.

The **Price List** screen appears.

3. Click the **Edit** button in the **Price List** zone.

The **Price List** screen appears. It contains the following sections:

- **Main** - Used to specify basic details about the price list.
- **Hierarchy** - Used to define parent price list to inherit price item pricing for the price list for a particular duration.
- **Divisions** - Used to associate price list with one or more divisions.
- **Eligibility Criteria** - Used to define eligibility criteria for the price list.
- **Characteristics** - Used to define the characteristics (which are applicable across divisions) for the price list.

The **Main** section contains the following fields:

Field Name	Field Description	Mandatory (Yes or No)
Price List Description	Used to specify the description for the price list.	Yes
Effective Start Date	Used to specify the date from when the price list is effective.	Yes

Field Name	Field Description	Mandatory (Yes or No)
	<p>Note: The system will not allow you to change the effective start date when:</p> <ul style="list-style-type: none"> • There is a price item assigned to the price list on that date. • The price list is assigned to an account or a person on that date. 	
Effective End Date	<p>Used to specify the date till when the price list is effective.</p> <p>Note: The effective end date cannot be earlier than the effective start date.</p>	No
Price List Type	<p>Used to indicate the type of the price list. The valid values are:</p> <ul style="list-style-type: none"> • Standard • Promotional 	Yes
Global Price List	<p>Used to indicate whether the price list is a global price list. The valid values are:</p> <ul style="list-style-type: none"> • Yes • No 	Yes
Availability Start Date	<p>Used to the specify the date from when the price list is available for assignment to an account or a person.</p> <p>Note: At present, the availability start date is not used in the product while assigning a price list to an account or a person. It is available for future use.</p>	No
Availability End Date	<p>Used to the specify the date till when the price list is available for assignment to an account or a person.</p> <p>Note:</p> <p>The availability end date cannot be earlier than the availability start date.</p> <p>At present, the availability end date is not used in the product while assigning a price list to an account or a person. It is available for future use.</p>	No
Validity Period (in Days)	<p>Used to specify the period in days for which the price list is valid. It is used to calculate price list assignment validity end date while assigning the price list to an account or a person.</p>	No
Status	<p>Used to indicate the status of the price list. The valid values are:</p>	Yes

Field Name	Field Description	Mandatory (Yes or No)
	<ul style="list-style-type: none"> Active – Used to indicate that the price list is used for billing. This value appears when you are editing a proposed price list Proposed – Used to indicate that the price list is used for quotations. Template – Used to indicate that the price list is a template price list. 	
	Note: You cannot change the status of an active and a template price list.	

- Modify the details in the **Main** section, if required.

Note: By default the **Main** section is displayed.

- Add, edit or remove parent price list from the price list hierarchy, if required.
- Associate or disassociate the price list from the divisions, if required.

Note: You can only view those divisions to which you have access in the **Division** list. If the price list is associated to a division to which you do not have access, then the **Divisions** section is grayed out.

- Define, edit, or remove eligibility criteria from the price list, if required
- Define, edit, or remove characteristics of the price list, if required.
- Click **Save**.

The changes made to the price list are saved.

Related Topics

For more information on...	See...
How to search for a price list	Searching for a Price List on page 449
How to define the price list hierarchy	Defining the Price List Hierarchy on page 453
How to define a characteristic for a price list	Defining a Characteristic for a Price List on page 454
How to associate a price list with a division	Associating a Price List with a Division on page 455
How to define eligibility criteria for the price list	Defining Eligibility Criteria for a Price List on page 456

Price List Price Item Pricing

Once a price list is created, you can either assign a price item to the price list and then define pricing for the price item, or you can copy an existing price item pricing and assign it to the price list. The **Price List Price Item Pricing** screen allows you to:

- View and filter the price items that are assigned to the price list
- Search and assign price items to the price list
- Copy a price item pricing and assign it to the price list



The **Price List Price Item Pricing** screen contains the following zones:

- [Price List Price Items](#) on page 469
- [Search Price Item or Price Item Pricing](#) on page 470

Price List Price Items

The **Price List Price Items** zone lists the price items that are assigned to the price list. You will not find any records in this zone if the price list does not have any price items assigned to it. It contains the following columns:

Column Name	Column Description
Pricing Information	Displays the concatenated string of information about the price item pricing separated by a comma (,).
	Note: It has a link. On clicking the link, the Price Item Pricing screen appears where you can view the details of the respective price item pricing.
Price Item	Displays the price item or price item bundle.
Pricing Parameters	Displays a comma-separated list of parameter values based on which the pricing is defined for the price item. The order in which the parameter values appear in this column is controlled by the display order (which is defined while associating a parameter with a price item).
	Note: This column appears when the Multi Price Parameter option type of the Multi Parameter Based Pricing (C1_PPARM_FLG) feature configuration is set to True .
Pricing Status	Indicates the current status of the price item pricing. The valid values are: <ul style="list-style-type: none"> • Active – Indicates that the price assignment is used for billing. • Draft – Indicates that the price assignment is created as a draft. • Inactive – Indicates that the price assignment is no longer used for billing. • Proposed – Indicates that the price assignment is to be used for quotations. • Rejected – Indicates that the price assignment is rejected. • Template – Indicates that the price assignment is a template price list.
Rate Info	Displays the rate of the price item.
	Note: If the price assignment has only one price component, you can view the rate defined in the pricing directly through the Rate Info column. However, if the price assignment has more than one price components, then the Rate Info column contains a string indicating the tiering type and pricing currency. It also contains “...” which indicates that for more information about the pricing you should navigate to the Price Item Pricing screen.
Effective Start Date	Displays the date from when the price item pricing is effective for the price list.
Effective End Date	Displays the date till when the price item pricing is effective for the price list.
Price Assignment Type	Indicates the type of price assignment. The valid values are: <ul style="list-style-type: none"> • Post Processing – Indicates that the pricing is used to generate post processing bill segment. This type of price assignment can be done on usage accounts. The post processing bill segment is generated when you

Column Name	Column Description
	<p>generate the bill for the usage account and not when you bill the usage account through an invoice account.</p> <ul style="list-style-type: none"> • Post Processing – Invoice Based – Indicates that the pricing is used to generate post processing bill segment. This type of price assignment is done on an invoice account, and, as a result, the post processing bill segment is generated on the invoice account. <p>Note: This is not applicable for price items which are defined for Pricing and where the Price Item Type field is set to Fees.</p> <ul style="list-style-type: none"> • Post Processing – Price Item Based – Indicates that the pricing is used to generate post processing bill segment. This type of price assignment is done on both invoice and usage accounts, but the post processing bill segment is generated only on the invoice account. • Regular – Indicates that the pricing is used to generate regular bill segment. <p>Note: This column appears when the Multi Price Parameter option type of the Multi Parameter Based Pricing (C1_PPARM_FLG) feature configuration is set to True.</p>
Edit	On clicking the Edit () icon, you can edit the price item pricing for the price list.
Delete	<p>On clicking the Delete () icon, you can remove the price item pricing from the price list.</p> <p>Note:</p> <p>The Delete icon appears in this column only when the price list is not yet assigned to any account or person.</p> <p>This column appears when the Multi Price Parameter option type of the Multi Parameter Based Pricing (C1_PPARM_FLG) feature configuration is set to False.</p>

You can filter the list using various search criteria (such as, **Price Item** and **Effective Start Date**) available in the **Filter** area. By default, the **Filter** area is hidden. You can view the **Filter** area by clicking the **Filters** () icon in the upper right corner of this zone.

You can change the layout of this zone. For more information on how to change the layout, see [Changing the Layout](#) on page 4300.

Related Topics

For more information on...	See...
How to edit a price item from the price list	Editing a Price Item Pricing of a Price List on page 479
How to remove a price item from the price list	Removing a Price Item from a Price List on page 477

Search Price Item or Price Item Pricing

You can assign a price item or price item bundle to a price list and then define pricing for the price item or price item bundle, or you can copy an existing price item pricing and assign it to a price list. The **Search Price Item or Price Item Pricing** zone allows you to search for a price item pricing which is assigned to an account, person, or price list. You

can then create a new price item pricing using an existing price item pricing through copying the price item pricing. Once you create a copy of an existing price item pricing, the new price item pricing is assigned to the price list. On copying a price item pricing, the pricing details including the price components, eligibility and tiering criteria for each price component, and characteristics are copied to the new price item pricing. You can then edit the details, if required.

The system allows you to create a copy of active, proposed, inactive, rejected, and template price item pricing. Once you create the copy of a template price item pricing, you can save the new price item pricing in either **Active** or **Proposed** status.

The **Search Price Item or Price Item Pricing** zone contains the following two sections:

- **Search Criteria** – The **Search Criteria** section contains the following fields:

Field Name	Field Description	Mandatory (Yes or No)
Search By	Used to indicate whether you want to search price item, pricing assigned to price list and override pricing for an account, or person. The valid values are: <ul style="list-style-type: none"> • Price Item • Price list Pricing • Account Override Pricing • Person Override Pricing 	Yes
Price Item	Used to search a particular price item or price item bundle.	No
Description	Used to search price items or price item bundles with a particular description.	No
	Note: This field appears when you select the Price Item option from the Search By list.	
Global Price List	Used to search price items or price item bundles which can be assigned to a global price list. The valid values are: <ul style="list-style-type: none"> • Yes • No 	No
Bundle	Used to indicate whether you want to search for price item bundles. The valid values are: <ul style="list-style-type: none"> • Yes • No 	No
Price List ID	Used to search pricing of price items or price item bundles which are assigned to a particular price list.	No
	Note: This field appears when you select the Price List Pricing option from the Search By list.	
Effective Start Date	Used to search price item pricing on price lists which are effective from a particular date onwards.	No

Field Name	Field Description	Mandatory (Yes or No)
	<p>Note: This field appears when you select the Price List Pricing, Account Override Pricing, or Person Override Pricing option from the Search By list.</p>	
Pricing Status	<p>Used to search price item pricing with a particular status. The valid values are:</p> <ul style="list-style-type: none"> • Active • Inactive • Proposed • Rejected • Template <p>Note: This field appears when you select the Price List Pricing, Account Override Pricing, or Person Override Pricing option from the Search By list.</p>	No
Effective End Date	<p>Used to search price item pricing on price lists which are effective till a particular date.</p> <p>Note: This field appears when you select the Price List Pricing, Account Override Pricing, or Person Override Pricing option from the Search By list.</p>	No
Price Assignment Type	<p>Used to search a particular type of the price item pricing. The valid values are:</p> <ul style="list-style-type: none"> • Regular • Post Processing • Post Processing – Invoice Based • Post Processing – Price Item Based <p>Note: This field appears when you select the Price List Pricing, Account Override Pricing, or Person Override Pricing option from the Search By list.</p>	No
Account ID	<p>Used to search pricing of price items or price item bundles which are assigned to a particular account.</p> <p>Note: This field appears when you select the Account Override Pricing option from the Search By list.</p>	Yes

Field Name	Field Description	Mandatory (Yes or No)
Person ID	Used to search pricing of price items or price item bundles which are assigned to a particular person.	Yes
	Note: This field appears when you select the Person Override Pricing option from the Search By list.	
Product Code		

Note:

You must specify at least one search criterion while searching for a price item or price item bundle.

You can search for an account, person by clicking the **Search** (🔍) icon corresponding to the respective field.

- **Search Results** – On clicking the **Search** button, the search results appear based on the specified search criteria. The search results include only those price items or price item bundles that are associated with the division to which the price list belongs. It may also include price items or price item bundles that are already assigned to the price list in case those price items or price item bundles match the search criteria.

The **Search Results** section contains the following columns:

Column Name	Column Description
Assign	On clicking the Assign (📌) icon, the Price Item Pricing screen appears where you can define a new price item pricing.
Price Item Information	Displays details of the price item or price item bundle.
	Note: It has a link. On clicking the link, the Price Item screen appears where you can view the details of the respective price item or price item bundle.
Copy	On clicking the Copy (📄) icon, the Price Item Pricing screen appears where you can define a new price item pricing using an existing price item pricing.
Pricing Information	Displays details of the price item pricing.
	Note: It has a link. On clicking the link, the View Price Item Pricing window appears with the details of the respective price item pricing.
Account Information	Indicates the account to which the price item pricing is assigned. In addition, this column has a context menu which helps in navigating to other screens in the application.

Column Name	Column Description
	<p>Note:</p> <p>This column appears when you select the Account Override Pricing option from the Search By list.</p> <p>It has a link. On clicking the link, the Account screen appears where you can view the details of the respective account.</p> <p>The account information string appears when an algorithm defined using the C1-AC-INFO algorithm type is attached to the Account Information system event in the Algorithms tab of the Installation Options – Framework screen.</p>
Person Information	<p>Indicates the person to which the price item pricing is assigned. In addition, this column has a context menu which helps in navigating to other screens in the application.</p> <p>Note:</p> <p>This column appears only when you select the Person Override Pricing option from the Search By list.</p> <p>It has a link. On clicking the link, the Person screen appears where you can view the details of the respective person.</p> <p>The person information string appears when an algorithm defined using the PERS-INFO algorithm type is attached to the Person Information system event in the Algorithms tab of the Installation Options – Framework screen.</p>
Price List Information	<p>Indicates the price list to which the price item pricing is assigned. In addition, this column has a context menu which helps in navigating to other screens in the application.</p> <p>Note:</p> <p>This column appears when you select the Price List Pricing option from the Search By list.</p> <p>It has a link. On clicking the link, the Price List screen appears where you can view the details of the respective person.</p>
Variance Parameter	<p>Indicates the variance parameter which is used for defining the price item pricing.</p> <p>Note: This column appears when the Multi Price Parameter option type of the Multi Parameter Based Pricing (C1_PPARM_FLG) feature configuration is set to False.</p>
Pricing Parameters	<p>Displays a comma-separated list of parameter values. The order in which parameter values appear in this column is controlled by the display order (which is defined while associating a parameter with a price item or price item bundle).</p> <p>Note: This column appears when the Multi Price Parameter option type of the Multi Parameter Based Pricing (C1_PPARM_FLG) feature configuration is set to True.</p>
Effective Start Date	<p>Displays the date from when the price item pricing is effective.</p>

Column Name	Column Description
Effective End Date	Displays the date till when the price item pricing is effective.
Pricing Currency	Indicates the currency in which the price item pricing is defined.
Pricing Status	Indicates the status of the price item pricing. The valid values are: <ul style="list-style-type: none"> • Active • Inactive • Proposed • Rejected • Template
Rate Schedule	Indicates the rate schedule which is used for defining the price item pricing.
Price Assignment Usage	Indicates whether the price item pricing is applicable to all customers or only to new customers. The valid values are: <ul style="list-style-type: none"> • AC • NC
Price Assignment Type	Indicates the type of the price item pricing. The valid values are: <ul style="list-style-type: none"> • Regular • Post Processing • Post Processing – Invoice Based • Post Processing – Price Item Based <p>Note: This column appears when the Multi Price Parameter option type of the Multi Parameter Based Pricing (C1_PPARM_FLG) feature configuration is set to False.</p>
Price Item	Displays the price item or price item bundle code. <p>Note: It has a link. On clicking the link, the Price Item Pricing screen appears where you can define the pricing for the respective price item or price item bundle.</p>
Description	Displays the description of the price item or price item bundle.
Global Price List	Indicates whether the price item or price item bundle can be assigned to a global price list. The valid values are: <ul style="list-style-type: none"> • Y • N
Unit of Measure	Indicates the unit of measure associated with the price item or price item bundle.
Bundle	Indicates whether the price item is a bundle or not. The valid values are: <ul style="list-style-type: none"> • Y • N
Owner ID	Displays the ID of the person for whose account the price list is created.
Party ID	Displays the third party ID.

Column Name	Column Description
Price List ID	Indicates the price list to which the price item pricing is assigned.
	Note: This column appears when you select the Price List Pricing option from the Search By list.
Price Assignment ID	Displays the price assignment ID.
Price Assignment Owner Type Flag	Displays whether price list or party is the owner of the price assignment.
Bundle Type	Indicates the type of the price item bundle. If the price item bundle is available for pricing and billing, the valid values are: <ul style="list-style-type: none"> • Phantom • Ratio • Regular <p>However, if the price item bundle is available for only pricing and the price item type is Fees then the valid value is Regular.</p>
	Note: This column appears when you select the Yes option from the Bundle list.
Price Item Type	Indicates the type of the price item or price item bundle. The valid values are: <ul style="list-style-type: none"> • Rate • Fees

Related Topics

For more information on...	See...
How to view price item pricing	Viewing a Price Item Pricing on page 477
How to assign a price item to a price list	Assigning a Price Item to a Price List on page 484
Price Item Pricing screen	Price Item Pricing (Used for Viewing) on page 614
How to copy a price item pricing and assign it to a price list	Copying a Price Item Pricing on page 499
How to view price items assigned to a price list	Viewing Price Items Assigned to a Price List on page 476

Viewing Price Items Assigned to a Price List

Procedure

To view price items assigned to a price list:

1. Search for the price list in the **Price List** screen.
2. In the **Search Results** section, click the **View** () icon from the **Price Item Pricing** column corresponding to the price list whose price items you want to view.

The **Price List Price Item Pricing** screen appears.

3. View the price items that are assigned to the price list in the **Price List Price Items** zone.



Related Topics

For more information on...	See...
How to search for a price list	Searching for a Price List on page 449
Price List Price Item Pricing screen	Price List Price Item Pricing on page 468
Price List Price Items zone	Price List Price Items on page 469

Removing a Price Item from a Price List

Procedure

To remove a price item from a price list:

1. Search for the price list in the **Price List** screen.
2. In the **Search Results** section, click the **View** () icon corresponding to the price list from which you want to remove a price item.
The **Price List Price Item Pricing** screen appears.
3. Filter the list in the **Price List Price Items** zone, if required.
4. Click the **Delete** () icon in the **Delete** column corresponding to the price item that you want to remove from the price list.

A message appears confirming whether you want to remove the price item from the price list.

Note: The **Delete** icon appears in the **Delete** column when the price list is not yet assigned to any account or person.

5. Click **OK**.

The price item is removed from the price list.

Related Topics

For more information on...	See...
How to search for a price list	Searching for a Price List on page 449



Viewing a Price Item Pricing

Procedure

To view a price item pricing and assignment details:

1. Do either of the following:

If you want to view...	Then...
Price Item Pricing of a Price List from the Price List Price Item Pricing screen	<ol style="list-style-type: none"> 1. . Search for the price list in the Price List screen. 2. In the Search Results section, click the View () icon corresponding to the price list whose details you want to view. The Price List Price Item Pricing screen appears. 3. Price assignments effective for the price list appears in the Price List Price Item zone.

If you want to view...	Then...
	<p>4. Click the link in the Pricing Information column corresponding to the price list whose pricing details you want to view.</p>
Price Item Pricing of a Price List from the Price List screen	<p>1. .</p> <p>Search for the price list in the Price List screen.</p> <p>2. In the Search Results section, click the Broadcast () icon corresponding to the price list whose price item pricing you want to view.</p> <p>The Price List Price Item zone appears.</p> <p>3. Click the link in the Pricing Information column corresponding to the price item whose price item pricing you want to view.</p> <p>Tip: Alternatively, you can click on the Broadcast () icon corresponding to the price list whose price item pricing you want to view. The Price Item Pricing zone appears in the Price List screen.</p>

The **Price Item Pricing** screen appears. It contains the following zones:

- **Price Item Pricing Information** – Displays the price item pricing details. It contains the following sections:
 - **Main** – Displays the pricing information of the price item.
 - **Deal Information** – Displays the deal information of the price item.
 - **TFM Information** – Displays the transaction feed management information of the price item.
 - **Characteristics** – Displays the details of price item pricing characteristics.
 - **Price Item and Parameter Information** – Displays the price item parameter details.
 - **Division-Specific Average Price Floor and Ceil Values** – Displays the floor and ceil values of a price item.
 - **Division-Specific SQIs for Price Item** – Displays the details of the SQIs associated with the price item.
 - **Division-Specific Cost for Price Item** – Displays the details of the costs associated with the price item.
 - **Division-Specific Negotiability Floor and Ceil Values for Price Item** – Displays the negotiability floor and ceil values of a price item.
 - **Record Actions** – Displays the record actions of the price item pricing.
 - **Record Information** – Displays the record information of the price item pricing.
 - **Pricing Structure** – Displays the details of the rate and price component of the price item.
2. View the basic details of price item pricing in the **Price Item Pricing** zone.
 3. View the rate and price component details of price item in the **Pricing Structure** zone.

4. View the tiering criteria of price item pricing in the **Pricing Structure** zone.
5. View the pricing eligibility criteria of price item pricing in the **Pricing Structure** zone.

Note: You can define, edit, copy, or delete the pricing price components of a rate component when the price item pricing status is **Draft**, **Proposed**, or **Template**.

Related Topics

For more information on...	See...
How to search for a price list	Searching for a Price List on page 449
Price List Price Item Pricing screen	Price List Price Item Pricing on page 468
Price List Price Items zone	Price List Price Items on page 442
Price Item Pricing screen	Price Item Pricing (Used for Viewing) on page 614
Price Item Pricing zone	Price Item Pricing on page 616
Rate and Price Component Summary zone	Rate and Price Component Summary
Rate Components zone	Rate Components
Price Components zone	Price Component on page 622
Tiering Criteria zone	Tiering Criteria
Pricing Eligibility Criteria zone	Pricing Eligibility Criteria

Editing a Price Item Pricing of a Price List

Prerequisites

To edit a price item pricing of a price list, you should have:



- Transactions mapped to the price item defined in the application
- Rate schedules, rate versions, rate components defined in the application
- Parameters associated with the price item (in case you want to define price item pricing based on those parameters)

Procedure

To edit a price item pricing of a price list:

1. Do either of the following:

If you want to...	Then...
Edit pricing of a price item that is assigned to a price list from Price List screen	<ol style="list-style-type: none"> 1. Search for the price list in the Price List screen. 2. In the Search Results section of Price List Price Items zone, click the link in the Pricing Information column corresponding to the price item whose pricing details you want to view. The Price Item Pricing screen appears. 3. Click the Edit button in the Record Actions section. The Price Item Pricing screen appears to edit the pricing details of a price item.

If you want to...	Then...
	<div style="border: 1px solid black; padding: 5px;"> <p>Note: The Edit button appears when the price item pricing is in the Draft status.</p> </div>
<p>Edit pricing of a price item that is assigned to a price list from Price List Price Item Pricing screen</p>	<ol style="list-style-type: none"> 1. Search for the price list in the Price List screen. In the Search Results section, click the Price List Pricing () icon corresponding to the price list whose <i>details</i> you want to view. The Price List Price Item Pricing screen appears. 2. Price items assigned to the price list appears in the Price List Price Items zone. 3. You can edit the pricing item pricing through the following alternatives: <ol style="list-style-type: none"> a. First alternative, <ul style="list-style-type: none"> • In the Search Results section of Price List Price Items zone, click the Edit () icon in the Edit column corresponding to the price item pricing whose details you want to edit. The Price Item Pricing screen appears to edit the pricing details of a price item. b. Second alternative, <ul style="list-style-type: none"> • Search for a price item in the Search Price Item or Price Item Pricing zone. In the Search Results section, click the Assign () icon corresponding to the price item. • Enter the required details in the Price Item Pricing screen and click Save. The Price Item Pricing screen appears. • Click the Edit button in the Record Actions section. The Price Item Pricing screen appears to edit the pricing details of a price item.

If you want to...	Then...
	<div data-bbox="1003 205 1396 317" style="border: 1px solid black; padding: 5px;"> <p>Note: The Edit button appears when the price item pricing is in the Draft status.</p> </div>

The **Price Item Pricing** screen appears. It contains the following sections:

- **Main** – Used to specify basic details about the price item pricing.
- **Deal Information** – Used to indicate the average price floor and ceil type to define the floor and ceil limits for the price item or price item bundle
- **TFM Information** – Used to specify the transaction feed management information about the price item pricing.

Note: This section appears in the **Price Item Pricing** screen when the value for the **Show Default Values in Price Item Pricing** option type for **C1_FM** feature configuration is set to **Y** and **Price Item Available For** is **Pricing and Billing**.

- **Characteristics** – Used to define the characteristics for the price item pricing.
- **Price Item and Parameter Information** – Used to define the parameter details segment for the price item pricing.

Note: This section appears when **Price Assignment Type** is **Regular**.

- **Commitments** – Used to indicate the basic details about the pricing and commitments such as costs, floor and ceil limits, and negotiability specific to a division.

The **Main** section contains the following fields:

Field Name	Field Description	Mandatory (Yes or No)
Start Date	<p>Used to specify the date from when the price item pricing is effective.</p> <div data-bbox="537 1276 1203 1617" style="border: 1px solid black; padding: 5px;"> <p>Note:</p> <p>The effective start date cannot be later than the effective end date.</p> <p>If you change the effective start and end dates while editing a price item pricing, you need to specify the parameters which are effective during that date range.</p> <p>This field will be in read-only mode when the price assignment has been used.</p> </div>	Yes
End Date	<p>Used to specify the date till when the price item pricing is effective.</p> <div data-bbox="537 1724 1203 1808" style="border: 1px solid black; padding: 5px;"> <p>Note: The effective end date cannot be earlier than the effective start date.</p> </div>	No
Price Assignment Type	Used to indicate the type of price assignment. The valid values are:	Yes

Field Name	Field Description	Mandatory (Yes or No)
	<ul style="list-style-type: none"> • Regular – Used to indicate that the pricing must be used to generate regular bill segment. • Post Processing – Used to indicate that the pricing must be used to generate post processing bill segment. This type of price assignment can be done on usage accounts. The post processing bill segment is generated when you generate the bill for the usage account and not when you bill the usage account through an invoice account. <div style="border: 1px solid black; padding: 5px; margin: 5px 0;"> <p>Note: The post processing bill segment is generated when the Post Processing Sequence (PPSEQ) characteristic is defined for the price item and when the price item is associated with another price item using the Price Item relationship type.</p> </div> <ul style="list-style-type: none"> • Post Processing – Invoice Based – Used to indicate that the pricing must be used to generate post processing bill segment. This type of price assignment can be done on an invoice account, and, as a result, the post processing bill segment is generated on the invoice account. <div style="border: 1px solid black; padding: 5px; margin: 5px 0;"> <p>Note: This will not be applicable for price item which are defined for Only Pricing.</p> </div> <ul style="list-style-type: none"> • Post Processing – Price Item Based – Used to indicate that the pricing must be used to generate post processing bill segment. This type of price assignment can be done on both invoice and usage accounts, but the post processing bill segment is generated only on the invoice account. <div style="border: 1px solid black; padding: 5px; margin: 5px 0;"> <p>Note: This will not be applicable for price item which are defined for Only Pricing.</p> </div>	
Pricing Eligibility	<p>Used to select pricing eligibility criteria for price item pricing.</p> <div style="border: 1px solid black; padding: 5px; margin-top: 5px;"> <p>Note: This field will be enabled for selection if the checkbox is not selected. If the checkbox appears selected then this field will be in read-only mode.</p> </div>	No
Pricing Status	<p>Used to indicate the status of the price assignment. The valid values are:</p> <ul style="list-style-type: none"> • Draft – Indicates that the price assignment is created as a draft. • Active – Indicates that the price assignment is used for billing. • Inactive – Indicates that the price assignment is no longer used for billing. 	Yes

Field Name	Field Description	Mandatory (Yes or No)
	<ul style="list-style-type: none"> • Proposed – Indicates that the price assignment is to be used for quotations. • Template – Indicates that the price assignment is a template price list. <p>Note: If a price assignment is in Active status, you can change its status to Inactive. If a price assignment is in Draft status, you cannot change its status to Proposed.</p>	
Pricing Currency	Used to indicate the currency in which you want to define the price item pricing.	Yes
Rate Schedule	Used to specify the rate schedule that you want to use while defining price item pricing. Note: Rate schedules control how the bills for the price item will be calculated. The Search (🔍) icon appears corresponding to this field. On clicking the Search icon, the Rate Schedule Search screen appears.	Yes
Pricing Rule Type	Used to indicate the pricing rule type. The valid value is: <ul style="list-style-type: none"> • Two-Dimensional 	Yes (Conditional) Note: This field is required when you are editing a two-dimensional pricing rule.
Print Zero	Used to indicate whether zero pricing should be displayed in the bill. The valid values are: <ul style="list-style-type: none"> • Yes • No <p>Note: By default, Yes is selected.</p>	Yes
Price Assignment Usage	Used to indicate whether the price item pricing is applicable to all customers or only to new customers. The valid values are: <ul style="list-style-type: none"> • All Customers • New Customers 	Yes
Pricing Frequency	Used to indicate pricing frequency for the price item.	Yes

Field Name	Field Description	Mandatory (Yes or No)
	Note: This field appears when Price Item is defined as Only Pricing and Price Item Type is defined as Fees .	

2. Modify the details in the **Main** section, if required.
3. Edit the deal information in a price item pricing, if required.
4. Edit the TFM information in a price item pricing, if required.
5. Edit the characteristics for a price item pricing, if required.
6. Edit the parameters for a price item pricing, if required.
7. Edit the pricing commitments, if required.
8. Click **Save**.

The changes made to the price item pricing are saved.

Related Topics

For more information on...	See...
Price List Price Item Pricing screen	Price List Price Item Pricing on page 468
Price List Price Items zone	Price List Price Items on page 442
How to search for a price list	Searching for a Price List on page 449
How to define a price item pricing.	Defining a Price Item Pricing on page 626
How to define a characteristic for a price item pricing.	Defining a Characteristic for a Price Item Pricing on page 492
How to define parameters for a price item pricing.	Defining a Parameter for a Price Item Pricing on page 579
How to define TFM Information in a price item pricing.	Defining TFM Information in a Price Item Pricing on page 491
How to define deal information in a price item pricing	Defining the Deal Information in a Price Item Pricing on page 490
How to define a division-specific cost of a price item in the price item pricing	Defining the Division-Specific Cost of a Price item in the Price Item Pricing on page 495
How to define a division-specific average price limit of a price item in the price item pricing	Defining the Division-Specific Average Price Limits of a Price item in the Price Item Pricing on page 496
How to define a division-specific rate negotiability limit of a price item in the price item pricing	Defining the Division-Specific Rate Negotiability Limits of a Price item in the Price Item Pricing on page 498

Assigning a Price Item to a Price List

Prerequisites



To assign a price item to a price list, you should have:

- Transactions mapped to the price item defined in the application
- Rate schedules, rate versions, and rate components defined in the application
- Parameters associated with the price item (in case you want to define price item pricing based on multiple parameters)

Procedure

To assign a price item to a price list:

1. Do either of the following:

If you want to...	Then...
<p>Define pricing of a price item that is assigned to a price list from Price List screen</p>	<ol style="list-style-type: none"> 1. Search for the price list in the Price List screen. 2. In the Search Results section of Price List Price Items zone, click the link in the Pricing Information column corresponding to the price item whose pricing details you want to view. The Price Item Pricing screen appears. 3. Click the Edit button in the Record Actions section. The Price Item Pricing screen appears to edit the pricing details of a price item. <div style="border: 1px solid black; padding: 5px; margin-top: 10px;"> <p>Note: The Edit button appears when the price item pricing is in the Draft status.</p> </div>
<p>Define pricing of a price item that is assigned to a price list from Price List Price Item Pricing screen</p>	<ol style="list-style-type: none"> 1. Search for the price list in the Price List screen. In the Search Results section, click the Price List Pricing () icon corresponding to the price list whose <i>details</i> you want to view. The Price List Price Item Pricing screen appears. 2. Price items assigned to the price list appears in the Price List Price Items zone. 3. You can edit the pricing item pricing through the following alternatives: <ol style="list-style-type: none"> a. First alternative, <ul style="list-style-type: none"> • In the Search Results section of Price List Price Items zone, click the Edit () icon in the Edit column corresponding to the price item pricing whose details you want to edit. The Price Item Pricing screen appears to edit the pricing details of a price item. b. Second alternative, <ul style="list-style-type: none"> • Search for a price item in the Search Price Item or Price Item Pricing zone.

If you want to...	Then...
	<p>In the Search Results section, click the Assign  icon corresponding to the price item.</p> <ul style="list-style-type: none"> Enter the required details in the Price Item Pricing screen and click Save. <p>The Price Item Pricing screen appears.</p> <ul style="list-style-type: none"> Click the Edit button in the Record Actions section. <p>The Price Item Pricing screen appears to edit the pricing details of a price item.</p> <div style="border: 1px solid black; padding: 5px; margin-top: 10px;"> <p>Note: The Edit button appears when the price item pricing is in the Draft status.</p> </div>

The **Price Item Pricing** screen appears. It contains the following sections:

- **Main** – Used to specify basic details about the price item pricing.
- **Deal Information** – Used to indicate the average price floor and ceil type to define the floor and ceil limits for the price item or price item bundle
- **TFM Information** – Used to specify the transaction feed management information about the price item pricing.

Note: This section appears in the **Price Item Pricing** screen when the value for the **Show Default Values in Price Item Pricing** option type for **C1_FM** feature configuration is set to **Y** and **Price Item Available For** is **Pricing and Billing**.

- **Characteristics** – Used to define the characteristics for the price item pricing.
- **Price Item and Parameter Information** – Used to define the parameter details segment for the price item pricing.

Note: This section appears when **Price Assignment Type** is **Regular**.

- **Commitments** – Used to indicate the basic details about the pricing and commitments such as costs, floor and ceil limits, and negotiability specific to a division.

The **Main** section contains the following fields:

Field Name	Field Description	Mandatory (Yes or No)
Start Date	Used to specify the date from when the price item pricing is effective.	Yes

Field Name	Field Description	Mandatory (Yes or No)
	<p>Note:</p> <p>The effective start date cannot be later than the effective end date.</p> <p>If you change the effective start and end dates while editing a price item pricing, you need to specify the parameters which are effective during that date range.</p> <p>This field will be in read-only mode when the price assignment has been used.</p>	
End Date	<p>Used to specify the date till when the price item pricing is effective.</p> <p>Note: The effective end date cannot be earlier than the effective start date.</p>	No
Price Assignment Type	<p>Used to indicate the type of price assignment. The valid values are:</p> <ul style="list-style-type: none"> • Regular – Used to indicate that the pricing must be used to generate regular bill segment. • Post Processing – Used to indicate that the pricing must be used to generate post processing bill segment. This type of price assignment can be done on usage accounts. The post processing bill segment is generated when you generate the bill for the usage account and not when you bill the usage account through an invoice account. <p>Note:</p> <p>The post processing bill segment is generated when the Post Processing Sequence (PPSEQ) characteristic is defined for the price item and when the price item is associated with another price item using the Price Item relationship type.</p> <ul style="list-style-type: none"> • Post Processing – Invoice Based – Used to indicate that the pricing must be used to generate post processing bill segment. This type of price assignment can be done on an invoice account, and, as a result, the post processing bill segment is generated on the invoice account. <p>Note: This will not be applicable for price item which are defined for Only Pricing.</p> <ul style="list-style-type: none"> • Post Processing – Price Item Based – Used to indicate that the pricing must be used to generate post processing bill segment. This type of price assignment can be done on both invoice and usage accounts, but 	Yes

Field Name	Field Description	Mandatory (Yes or No)
	<p>the post processing bill segment is generated only on the invoice account.</p> <p>Note: This will not be applicable for price item which are defined for Only Pricing.</p>	
Pricing Eligibility	<p>Used to select pricing eligibility criteria for price item pricing.</p> <p>Note: This field will be enabled for selection if the checkbox is not selected. If the checkbox appears selected then this field will be in read-only mode.</p>	No
Pricing Status	<p>Used to indicate the status of the price assignment. The valid values are:</p> <ul style="list-style-type: none"> • Draft – Indicates that the price assignment is created as a draft. • Active – Indicates that the price assignment is used for billing. • Inactive – Indicates that the price assignment is no longer used for billing. • Proposed – Indicates that the price assignment is to be used for quotations. • Template – Indicates that the price assignment is a template price list. <p>Note: If a price assignment is in Active status, you can change its status to Inactive. If a price assignment is in Draft status, you cannot change its status to Proposed.</p>	Yes
Pricing Currency	Used to indicate the currency in which you want to define the price item pricing.	Yes
Rate Schedule	<p>Used to specify the rate schedule that you want to use while defining price item pricing.</p> <p>Note: Rate schedules control how the bills for the price item will be calculated.</p> <p>The Search (🔍) icon appears corresponding to this field. On clicking the Search icon, the Rate Schedule Search screen appears.</p>	Yes
Pricing Rule Type	<p>Used to indicate the pricing rule type. The valid value is:</p> <ul style="list-style-type: none"> • Two-Dimensional 	Yes (Conditional)

Field Name	Field Description	Mandatory (Yes or No)
		Note: This field is required when you are editing a two-dimensional pricing rule.
Print Zero	Used to indicate whether zero pricing should be displayed in the bill. The valid values are: <ul style="list-style-type: none"> • Yes • No Note: By default, Yes is selected.	Yes
Price Assignment Usage	Used to indicate whether the price item pricing is applicable to all customers or only to new customers. The valid values are: <ul style="list-style-type: none"> • All Customers • New Customers 	Yes
Pricing Frequency	Used to indicate pricing frequency for the price item. Note: This field appears when Price Item is defined as Only Pricing and Price Item Type is defined as Fees .	Yes

2. Define the details in the **Main** section.
3. Define the deal information in a price item pricing.
4. Define the TFM information in a price item pricing.
5. Define the characteristics for a price item pricing.
6. Define the parameters for a price item pricing.
7. Select the required division from the **Commitments** section to define the commitments of a price item pricing.
8. Define the cost of the price item or price item bundle for the required divisions
9. Define the average price floor and ceil limits of the price item or price item bundle for the required divisions.
10. Define the negotiability floor and ceil values of the price item or price item bundle for the required divisions
11. Click **Save**.

The pricing is defined for a price item.

Related Topics

For more information on...	See...
Price List Price Item Pricing screen	Price List Price Item Pricing on page 468
Search Price Item or Price Item Pricing zone	Search Price Item or Price Item Pricing on page 470
How to search for an person	Searching for a Price List on page 449
How to define a characteristic for a price item pricing.	Defining a Characteristic for a Price Item Pricing on page 492

For more information on...	See...
How to define parameters for a price item pricing.	Defining a Parameter for a Price Item Pricing on page 579
How to define deal Information in a price item pricing.	Defining the Deal Information in a Price Item Pricing on page 490
How to define TFM Information in a price item pricing.	Defining TFM Information in a Price Item Pricing on page 491
How to define a division-specific cost of a price item in the price item pricing	Defining the Division-Specific Cost of a Price item in the Price Item Pricing on page 495
How to define a division-specific average price limit of a price item in the price item pricing	Defining the Division-Specific Average Price Limits of a Price item in the Price Item Pricing on page 496
How to define a division-specific rate negotiability limit of a price item in the price item pricing	Defining the Division-Specific Rate Negotiability Limits of a Price item in the Price Item Pricing on page 498

Defining the Deal Information in a Price Item Pricing

Note: This topic is not applicable for the health insurance business.

Procedure

To define the deal information in a price item pricing:

1. Ensure that the **Deal Information** section is expanded when you are defining, editing, or overriding a price item pricing.

The **Deal Information** section contains the following field:

Field Name	Field Description	Mandatory (Yes or No)
Average Price Floor and Ceil Type	<p>Used to indicate the manner in which the average price floor and ceil limits of the price item pricing is defined for the deal. The valid values are:</p> <ul style="list-style-type: none"> • Absolute Value Range - Used to indicate that the average price floor and ceil limits for the price item pricing is defined using absolute values. • Spread Amount - Used to indicate that the average price floor and ceil limits for the price item pricing is defined based on the spread amount. • Spread Percentage - Used to indicate that the average price floor and ceil limits for the price item pricing is defined based on the spread percentage. 	Yes (Conditional)
	<p>Note: Incase of Spread Amount and Spread Percentage options, the system calculates the average price of a price item and based on the average price and the spread amount or spread percentage the average floor and ceil limits of the price item are derived for the deal.</p>	<p>Note: This field is required while defining the average price floor and ceil limits of the price item for the deal.</p>

2. Enter the required details in the **Deal Information** section.
3. Click **Save**.

The deal information is defined for the price item pricing.

Related Topics

For more information on...	See...
How to define a price item pricing	Defining a Price Item Pricing on page 626
How to edit a price item pricing	Editing a Price Item Pricing on page 678
How to override a price item pricing	Overriding a Price Item Pricing on page 691

Defining TFM Information in a Price Item Pricing

Note: This topic is not applicable for the health insurance business.

Prerequisites

To define the TFM information in a price item pricing, you should have:

- Transactions mapped to the price item defined in the application
- Aggregation or rating criteria to be defined for the price item pricing

Procedure

To define the TFM information in a price item pricing:

1. Ensure that the **TFM Information** section is expanded when you are defining, editing, or overriding a price item pricing.

The **TFM Information** section contains the following fields:

Field Name	Field Description	Mandatory (Yes or No)
Ignore Transaction	Used to indicate whether the transactions mapped to the price item are considered for billing or not. The valid values are: <ul style="list-style-type: none"> • Yes • No 	Yes (Conditional)
	Note: By default, the No option is selected.	Note: This field is required while defining the TFM information in a price item pricing.
Aggregate Transactions	Used to indicate whether aggregation is required while rating the transactions mapped to the price item pricing before billing. The valid values are: <ul style="list-style-type: none"> • Yes - Indicates that aggregation is required while rating the transactions mapped to the price item pricing before billing. • No - Indicates that aggregation is not required while rating the transactions mapped to the price item pricing before billing. 	Yes (Conditional)
		Note: This field is required while defining the TFM information in a price item pricing.

Field Name	Field Description	Mandatory (Yes or No)
	Note: By default, the Yes option is selected.	
Aggregation Schedule	Used to indicate the transaction aggregation cycle. The valid values are: <ul style="list-style-type: none"> • Daily • Weekly • Monthly • Quarterly • Yearly 	Yes (Conditional) Note: This field is required while defining the TFM information in a price item pricing.
Transaction Rating Criteria	Used to indicate how and when the transaction legs mapped to the price item are rated. The valid values are: <ul style="list-style-type: none"> • Aggregate Transactions and Then Rate Aggregated SQs • Do Not Rate Transactions • Rate Transaction and Aggregate Calc Lines 	Yes (Conditional) Note: This field is required while defining the TFM information in a price item pricing.
	Note: By default, the Do Not Rate Transactions option is selected.	

2. Enter the required details in the **TFM Information** section.

Note: **TFM Information** section appears when the value for **Show Default Values in Price Item Pricing** option type of **C1_FM feature configuration** is set to **Y** and **Price Item Available For** is **Pricing and Billing**.

3. Click **Save**.

The TFM information is defined in the price item pricing.

Related Topics

For more information on...	See...
How to define a price item pricing	Defining a Price Item Pricing on page 626
How to edit a price item pricing	Editing a Price Item Pricing on page 678
How to override a price item pricing	Overriding a Price Item Pricing on page 691

Defining a Characteristic for a Price Item Pricing

Note: This topic is not applicable for the health insurance business.

Prerequisites

To define a characteristic for a price item pricing, you should have:

- Characteristic types defined in the application (where the characteristic entity is set to **Price Item**)

Procedure

To define a characteristic for a price item pricing:

1. Ensure that the **Characteristics** section is expanded when you are defining, editing, or overriding a price item pricing.

The **Characteristics** section contains the following fields in a grid:

Field Name	Field Description	Mandatory (Yes or No)
Effective Date	Used to specify the date from when the characteristic is effective for the price item pricing.	Yes (Conditional)
		Note: This field is required while defining a characteristic for the price item pricing.
Characteristic Type	Used to indicate the characteristic type. Note: The list includes only those characteristic types where the characteristic entity is set to Price Item .	Yes (Conditional)
		Note: This field is required while defining a characteristic for the price item pricing.
Characteristic Value	Used to specify the value for the characteristic type. Note: If you select a predefined characteristic type, the Search (🔍) icon appears corresponding to the Characteristic Value field. On clicking the Search icon, the Predefined Characteristic Search window appears. On specifying the value for a predefined characteristic type, the description of the characteristic value appears corresponding to the Characteristic Value field.	Yes (Conditional)
		Note: This field is required while defining a characteristic for the price item pricing.

2. Enter the required details in the **Characteristics** section.
3. If you want to define more than one characteristic for the price item pricing, click the **Add** (+) icon and then repeat step 2.

Note: However, if you want to remove a characteristic from the price item pricing, click the **Delete** (🗑️) icon corresponding to the characteristic.

4. Click **Save**.

The characteristic is defined for the price item pricing.

Related Topics

For more information on...	See...
How to define a price item pricing	Defining a Price Item Pricing on page 626
How to edit a price item pricing	Editing a Price Item Pricing on page 678
How to override a price item pricing	Overriding a Price Item Pricing on page 691

Defining a Parameter for a Price Item Pricing

Note: This topic is not applicable for the health insurance business.

Prerequisites

To define a parameter for a price item pricing, you should have:

- Parameters associated with the price item, in case, you want to define price item pricing based on multiple parameters

Procedure

To define a parameter for a price item pricing:

1. Ensure that the **Price Item and Parameter Information** section is expanded when you are defining, editing, or overriding a price item pricing.

The **Price Item and Parameter Information** section contains the following field:

Field Name	Field Description
Price Item	Indicates the price item or price item bundle for whom you want to define a parameter.

In addition, this section contains the following fields in a grid:

Field Name	Field Description	Mandatory (Yes or No)
Parameter	Used to indicate the parameter that you want to associate with the price item pricing. Note: The Search (🔍) icon appears corresponding to the Parameter field. On clicking the Search icon, the Price Item Parameter Search window appears where you can search for the required parameter. The search results displays only those parameters where the Price Item check box is selected.	Yes
Parameter Information	Displays the concatenated string of information about the parameter separated by a comma (,).	Not applicable
Parameter Value	Used to specify the value of the parameter.	Yes

2. Enter the required details in the **Price Item and Parameter Information** section.
3. If you want to define more than one parameter for the price item pricing, click the **Add** (+) icon and then repeat step 2.

Note: However, if you want to remove a parameter from the price item pricing, click the **Delete** (🗑️) icon corresponding to the parameter.

4. Click **Save**.

The parameter is defined for the price item pricing.

Related Topics

For more information on...	See...
How to define a price item pricing	Defining a Price Item Pricing on page 626
How to edit a price item pricing	Editing a Price Item Pricing on page 678
How to override a price item pricing	Overriding a Price Item Pricing on page 691

Defining the Division-Specific Cost of a Price item in the Price Item Pricing

Note: This topic is not applicable for the health insurance business.

Prerequisites

To define the division-specific cost of a price item in the price item pricing you should have:

- Price items or price item bundles associated with the division to which the user belongs

Procedure

To define the division-specific cost of a price item in the price item pricing:

1. Ensure that the **Commitments** section is expanded when you are defining, editing, or overriding a price item pricing.
2. Click the **Add** (+) icon in the **Costs** column corresponding to the division for which you want to define the cost of the price item in the price item pricing.

The following fields appear in a grid:

Field Name	Field Description	Mandatory (Yes or No)
Cost Type	Used to indicate the type of cost incurred in the division for the price item pricing. The valid values are: <ul style="list-style-type: none"> • Additional Cost-Fixed • Additional Cost-Variable • Fixed Internal • Fixed Third Party • Variable Internal • Variable Third Party 	Yes (Conditional) Note: This field is required while defining the division-specific cost of the price item in the price item pricing.
Cost Value	Used to specify the cost amount.	Yes (Conditional) Note: This field is required while defining the division-specific cost of the price item in the price item pricing.

Note: By default, the **Pricing Currency** is considered as the currency for defining the division-specific cost of the price item in the price item pricing.

3. Enter the required details in the **Costs** grid.
4. If you want to define more than one division-specific cost of the price item in the price item pricing, click the **Add** (+) icon and then repeat step 3.

Note: However, if you want to remove the division-specific cost of the price item from the price item pricing, click the **Delete** (🗑️) icon corresponding to the cost.

5. Click **Save**.

The division-specific cost of the price item in the price item pricing is defined.

Related Topics

For more information on...	See...
How to define a price item pricing	Defining a Price Item Pricing on page 626
How to edit a price item pricing	Editing a Price Item Pricing on page 678
How to override a price item pricing	Overriding a Price Item Pricing on page 691

Defining the Division-Specific Average Price Limits of a Price item in the Price Item Pricing

Note: This topic is not applicable for the health insurance business.

Prerequisites

To define the division-specific average price limits of a price item in the price item pricing, you should have:

- To Do roles and currencies defined in the application
- Price items or price item bundles associated with the division to which the user belongs

Procedure

To define the division-specific average price limits of the price item in the price item pricing:

1. Ensure that the **Commitments** section is expanded when you are defining, editing, or overriding a price item pricing.
2. Click the **Add** (➕) icon in the **Floor and Ceiling Type** column corresponding to the division for which you want to define the division-specific average price item pricing.

The following fields appear in a grid:

Field Name	Field Description	Mandatory (Yes or No)
To Do Role	Used to indicate that users with the specified To Do role can approve the average price of the price item in the price item pricing when it is within the specified floor and ceil limits.	Yes (Conditional) Note: This field is required while defining the division-specific average price floor and ceil limits of the price item in the price item pricing.
	<p>Note:</p> <p>The Search (🔍) icon appears corresponding to the To Do Role field. On clicking the Search icon, the To Do Role Search window appears.</p> <p>On specifying the To Do role, the description of the To Do role appears corresponding to the To Do Role field.</p>	
Floor Value	Used to specify the floor (i.e. lower) limit of the To Do role for approving the average price of the price item in the price item pricing.	Yes (Conditional)

Field Name	Field Description	Mandatory (Yes or No)
	<p>Note: The floor value cannot be greater than the ceil value.</p> <p>This field appears only when you select Absolute Value Range option from the Average Price Floor and Ceil Type list while defining the deal information in the price item pricing.</p>	<p>Note: This field is required while defining the division-specific average price floor and ceil limits of the price item in the price item pricing.</p>
Ceil Value	<p>Used to specify the ceil (i.e. upper) limit of the To Do role for approving the average price of the price item in the price item pricing.</p> <p>Note: The ceil value cannot be lower than the floor value.</p> <p>This field appears only when you select Absolute Value Range option from the Average Price Floor and Ceil Type list while defining the deal information in the price item pricing.</p>	<p>Yes (Conditional)</p> <p>Note: This field is required while defining the division-specific average price floor and ceil limits of the price item in the price item pricing.</p>
Spread Amount	<p>Used to specify the spread amount of the To Do role for approving the average price of the price item in the price item pricing.</p> <p>Note: This field appears only when you select the Spread Amount option from the Average Price Floor and Ceil Type list while defining the deal information in the price item pricing.</p>	<p>Yes (Conditional)</p> <p>Note: This field is required while defining the division-specific average price floor and ceil limits of the price item in the price item pricing.</p>
Spread Percentage	<p>Used to specify the spread percentage of the To Do role for approving the average price of the price item in the price item pricing.</p> <p>Note: This field appears only when you select the Spread Percentage option from the Average Price Floor and Ceil Type list while defining the deal information in the price item pricing.</p>	<p>Yes (Conditional)</p> <p>Note: This field is required while defining the division-specific average price floor and ceil limits of the price item in the price item pricing.</p>
Floor and Ceil Currency	<p>Used to indicate the currency in which you want to define the average price floor and ceil limits of the price item in the price item pricing.</p>	<p>Yes (Conditional)</p> <p>Note: This field is required while defining the division-specific average price floor and ceil limits of the price item in the price item pricing.</p>

Field Name	Field Description	Mandatory (Yes or No)
	<p>Note:</p> <p>The list includes only those currencies which are already defined in the system.</p> <p>The system does the currency conversion when the pricing currency is different from the floor and ceil currency.</p>	

- Enter the required details in the **Floor and Ceiling Type** grid.

Note: The **Floor and Ceiling Type** grid appears only when you select an option from the **Average Price Floor and Ceil Type** field in the **Deal Information** section.

- If you want to define the average price limits for more than one To Do role in the division, click the **Add (+)** icon and then repeat step 3.

Note: However, if you want to remove the average price limits of a To Do role from the division, click the **Delete (🗑)** icon corresponding to the To Do role.

- Click **Save**.

The division-specific average price limits of the price item in the price item pricing is defined.

Related Topics

For more information on...	See...
How to define a price item pricing	Defining a Price Item Pricing on page 626
How to edit a price item pricing	Editing a Price Item Pricing on page 678
How to override a price item pricing	Overriding a Price Item Pricing on page 691

Defining the Division-Specific Rate Negotiability Limits of a Price item in the Price Item Pricing

Note: This topic is not applicable for the health insurance business.

Prerequisites

To define the division-specific rate negotiability limits of a price item in the price item pricing, you should have:

- Currencies defined in the application
- Price items associated with the division to which the user belongs

Procedure

To define the division-specific rate negotiability limits of a price item in the price item pricing:

- Ensure that the **Commitments** section is expanded when you are defining, editing, or overriding a price item pricing.

- Click the **Add (+)** icon in the

Negotiability column corresponding to the division for which you want to define the division-specific rate negotiability limits

The following fields appear in a grid:

Field Name	Field Description	Mandatory (Yes or No)
Negotiability Floor Value	Used to specify the floor (i.e. lower) limit for the rate negotiation.	Yes (Conditional)
	Note: The floor value cannot be greater than the ceil value.	Note: This field is required while defining the division-specific rate negotiability limits of the price item in the price item pricing.
Negotiability Ceil Value	Used to specify the ceil (i.e. upper) limit for the rate negotiation.	Yes (Conditional)
	Note: The ceil value cannot be lower than the floor value.	Note: This field is required while defining the division-specific rate negotiability limits of the price item in the price item pricing.

Note: By default, the **Pricing Currency** is considered as the currency for defining the division-specific rate negotiability limits of the price item in the price item pricing.

3. Enter the required details in the **Negotiability** grid.
4. Click **Save**.

The division-specific rate negotiability limits of the price item in the price item pricing is defined.

Related Topics

For more information on...	See...
How to define a price item pricing	Defining a Price Item Pricing on page 626
How to edit a price item pricing	Editing a Price Item Pricing on page 678
How to override a price item pricing	Overriding a Price Item Pricing on page 691

Copying a Price Item Pricing

Prerequisites

To copy a price item pricing and assign it to a price list, you should have:

- Price list (to which you want to assign the price item pricing) defined in the application
- Price list associated with the division to which the user belongs
- Price item pricing (whose copy you want to create) defined in the application

Procedure

To copy a price item pricing and assign it to a price list:

1. Search for the price list in the **Price List** screen.
2. In the **Search Results** section, click the **Price List Pricing** () icon in the **Price List Pricing** column corresponding to the price list to which you want to assign a price item pricing.
The **Price List Price Item Pricing** screen appears.
3. In the **Search Price Item** zone, select the required option from the **Search By** list to indicate whether you want to search price item pricing assigned to an account, person, or a price list.

The fields in the **Search Criteria** section change depending on the option that you select from the **Search By** list.

4. Enter the search criteria in the **Search Price Item** zone to search for the price item pricing whose copy you want to create and assign it to the price list.
5. Click **Search**.

A list of price item pricing that meet the search criteria appears in the **Search Results** section.

6. In the **Search Results** section, click the **Copy** (📄) icon in the **Copy** column corresponding to the price item pricing whose copy you want to create.

The **Price Item Pricing** screen appears.

7. Modify the required pricing details.

Note:

If you change the effective start and end dates while copying a price item pricing, you need to specify the parameters which are effective during that date range.

While copying a price item pricing, you can not only edit the existing tiering combination details, but can also add additional tiering combinations until the maximum tiering combinations limit is met.

If you are creating a copy of active, proposed, inactive, rejected, or template price item pricing, you can save the new price item pricing in the **Active**, **Proposed**, or **Template** status.

8. Edit the characteristics of the price item pricing, if required.
9. Click **Save**.

A new price item pricing is defined and assigned to the price list.

Related Topics

For more information on...	See...
How to search for a price list	Searching for a Price List on page 449
Price List Price Item Pricing screen	Price List Price Item Pricing on page 468
Search Price Item zone	Search Price Item on page 358
How to edit a price item pricing	Editing a Price Item Pricing
How to edit characteristics of a price item pricing	Editing the Price Assignment Characteristics

Price List Assignment

Once a price list is defined, you can assign it to accounts or persons to indicate the prices that will be charged for the price items or services offered to the accounts or persons. You can assign multiple price lists to an account or a person along with the priority or order in which the pricing should be considered. You can also define whether the account or person can avail the price item pricing listed on the parent or grandparent price list if it is not available on the assigned price list. In other words, you can define whether the account or person can inherit the price item pricing from the price list hierarchy.

For example, suppose you have PL1 (with priority 10) and PL2 (with priority 20) assigned to an account or a person. While determining pricing for a price item, the system will search for the price item pricing in PL1. If the system does not find the price item pricing in PL1, it will search for the price item pricing in PL2. The system will behave in this manner when the price list inheritance for PL1 is set to **No** during the price list assignment.

If the price list inheritance while assigning PL1 and PL2 to an account or a person is set to **Yes**, the system will search for the price item pricing in PL1. If the system does not find the price item pricing in PL1, it will search for the price item pricing from the price list hierarchy defined for PL1. However, if the system does not find the price item pricing from the price list hierarchy of PL1, it will then search for the price item pricing in PL2 (assigned to the account or person with priority 20). If the system still does not find the price item pricing in PL2, it will search for the price item pricing from the price list hierarchy defined for PL2.

The **Price List Assignment** screen allows you to search and assign a price list to an account or a person. It also allows you to view the price lists that are already assigned to an account or a person. It contains the following zones:

- [Price List Assignments](#) on page 501
- [Price List Price Items](#) on page 503
- [Search Price List for Assignment](#) on page 504

Price List Assignments

The **Price List Assignments** zone allows you to view and filter price lists that are currently assigned to the account or person. You can also search for the price lists assigned to the account or person which are either inactive or expired. You will not find any records in this zone if the account does not have any price lists assigned to it. It contains the following two sections:

- **Search Criteria** - The **Search Criteria** section contains the following fields:

Field Name	Field Description	Mandatory (Yes or No)
Search By	Used to indicate whether you want to search for the current, inactive, or historical price list assignments. The valid values are: <ul style="list-style-type: none"> • Current Price List Assignments • Inactive Price List Assignments • Historical Price List Assignments 	Yes
	Note: By default, the Current Price List Assignments option is selected.	
Price List ID	Used to search a particular price list assigned to an account or a person.	No
	Note: The Search (🔍) icon appears corresponding to the Price List ID field. On clicking the Search icon, the Price List Search window appears.	
Price List Description	Used to search price lists which are assigned to the account or person having a particular description.	No
Effective Start Date	Used to search price lists which are assigned to the account or person from a particular date.	No
Effective End Date	Used to search price lists which are assigned to the account or person till a particular date.	No
Assignment Status	Used to search price list assignments with a particular status. The valid values are: <ul style="list-style-type: none"> • Active • Rejected 	No

Field Name	Field Description	Mandatory (Yes or No)
	<ul style="list-style-type: none"> Proposed Inactive <p>Note: The Inactive option is not available in the Assignment Status list when you have selected the Current Price List Assignments or Historical Price List Assignments option from the Search By list.</p> <p>This field is disabled, and by default, the Inactive option is selected when you select the Inactive Price List Assignments option from the Search By list.</p>	
Price List Inheritance	<p>Used to search price list assignments where the account or person inherits price item pricing from the price list hierarchy. The valid values are:</p> <ul style="list-style-type: none"> Yes No 	No

Note: You must specify at least one search criterion while searching for price list assignments.

- **Search Results** - On clicking the **Search** button, the search results appear based on the specified search criteria. The **Search Results** section contains the following columns:

Column Name	Column Description
Price List Information	<p>Displays information about the price list which is assigned to the account or person.</p> <p>Note: It has a link. On clicking the link, the Price List screen appears with the details of the respective price list.</p>
Effective Start Date	Displays the date from when the price list is assigned to the account or person.
Effective End Date	Displays the date till when the price list is assigned to the account or person.
Priority	Indicates the order in which the assigned price list must be considered while determining the price item pricing for the account or person.
Assignment Status	<p>Indicates the status of the price list assignment. The valid values are:</p> <ul style="list-style-type: none"> Active Rejected Proposed Inactive
Price List Inheritance	Indicates whether the account or person can avail the price item pricing listed on the parent or grandparent price list if it is not available on the assigned price list. In other words, it indicates whether the account or person can inherit the price item pricing from the price list hierarchy.

Column Name	Column Description
Edit	On clicking the Edit (✎) icon, the Price List Assignment screen appears where you can edit the price list assignment details.

Note: Pagination is used to display limited number of records in the **Search Results** section. You can use the navigation links, such as **Previous** and **Next** to navigate between pages.

On clicking the **Broadcast** (📡) icon corresponding to the assigned price list, the **Price List Price Items** zone appears where you can view the price items assigned to the price list.

Related Topics

For more information on...	See...
Price List Price Items zone	Price List Price Items on page 469
How to view price items assigned to the price list	Viewing Price Items Assigned to a Price List on page 509
How to edit the price list assignment details of an account	Editing the Price List Assignment Details of an Account on page 517
How to edit the price list assignment details of a person	Editing the Price List Assignment Details of a Person on page 520
How to view price lists assigned to an account	Viewing Price Lists Assigned to an Account on page 507
How to view price lists assigned to a person	Viewing Price Lists Assigned to a Person on page 508

Price List Price Items

The **Price List Price Items** zone lists the price items that are assigned to the price list. You will not find any records in this zone if the price list does not have any price items assigned to it. It contains the following columns:

Column Name	Column Description
Pricing	Displays information about the price item pricing. Note: It has a link. On clicking the link, the Price Item Pricing screen appears where you can view the details of the price item pricing.
Pricing Parameters	Displays a comma-separated list of parameter values. The order in which parameter values appear in this column is controlled by the display order (which is defined while associating a parameter with a price item). Note: This column appears when the Multi Price Parameter option type of the Multi Parameter Based Pricing (C1_PPARM_FLG) feature configuration is set to True .
Pricing Status	Indicates the status of the price item pricing. The valid values are: <ul style="list-style-type: none"> • Active • Inactive • Proposed • Rejected • Template
Rate Info	Displays the rate of the price item.

Column Name	Column Description
	<p>Note:</p> <p>If the price assignment has only one price component, you can view the rate defined in the pricing directly through the Rate Info column.</p> <p>However, if the price assignment has more than one price components, then the Rate Info column contains a string indicating the tiering type and pricing currency. It also contains “...” which indicates that for more information about the pricing you should navigate to the Price Item Pricing screen.</p>
Effective Start Date	Displays the date from when the price item pricing is effective for the price list.
Effective End Date	Displays the date till when the price item pricing is effective for the price list.
Price Assignment Type	<p>Indicates the type of the price assignment for price item pricing. The valid values are:</p> <ul style="list-style-type: none"> • Regular • Post Processing • Post Processing – Invoice Based • Post Processing – Price Item Based <p>Note: This column appears when the Multi Price Parameter option type of the Multi Parameter Based Pricing (C1_PPARM_FLG) feature configuration is set to True.</p>
Copy	On clicking the Copy (📄) icon, the Price Item Pricing screen appears where you can define a new price item pricing using an existing price item pricing.

By default, the **Price List Price Items** zone does not appear in the **Price List Assignment** screen. It appears when you click the **Broadcast** (📡) icon corresponding to the assigned price list in the **Price List Assignments** zone.

You can filter the list using various search criteria (such as, **Price Item** and **Effective Start Date**) available in the **Filter** area. By default, the **Filter** area is hidden. You can view the **Filter** area by clicking the **Filters** (🔍) icon in the upper right corner of this zone.

You can change the layout of this zone. For more information on how to change the layout, see [Changing the Layout](#) on page 4300.

Related Topics

For more information on...	See...
How to view price items assigned to a price list	Viewing Price Items Assigned to a Price List on page 509

Search Price List for Assignment

The **Search Price List for Assignment** zone allows you to search for a price list that you want to assign to the account or person. It contains the following two sections:

- **Search Criteria** – The **Search Criteria** section contains the following fields:

Field Name	Field Description	Mandatory (Yes or No)
Search By	Used to indicate whether you want to search against all price lists or against those price lists which are already assigned to an account or a person. The valid values are:	Yes

Field Name	Field Description	Mandatory (Yes or No)
	<ul style="list-style-type: none"> Price List Assigned Price List <p>Note: By default, the Price List option is selected.</p>	
Price List ID	Used to search a particular price list.	No
Price List Description	Used to search price lists with a particular description.	No
Effective Start Date	If you have selected the Price List option from the Search By list, this field is used to search price lists which are effective from a particular date onwards. However, if you have selected the Assigned Price List option from the Search By list, this field is used to search price lists which are assigned to an account or a person from a particular date onwards.	No
Effective End Date	If you have selected the Price List option from the Search By list, this field is used to search price lists which are effective till a particular date. However, if you have selected the Assigned Price List option from the Search By list, this field is used to search price lists which are assigned to an account or a person till a particular date.	No
Account ID	Used to search price lists assigned to a particular account. Note: This field appears when you have selected the Assigned Price List option from the Search By list.	No
Person ID	Used to search price lists assigned to a particular person. Note: This field appears when you have selected the Assigned Price List option from the Search By list.	No
Status	Used to search price lists with a particular status. The valid values are: <ul style="list-style-type: none"> Active Proposed <p>Note: This field appears when you have selected the Price List option from the Search By list.</p>	No
Price List Type	Used to search a particular type of price lists. The valid values are: <ul style="list-style-type: none"> Standard Promotional 	No

Field Name	Field Description	Mandatory (Yes or No)
	Note: This field appears when you have selected the Price List option from the Search By list.	
Only Eligible Price Lists	Used to search price lists which are eligible for the account or person. Note: This field appears when you have selected the Price List option from the Search By list.	No
Eligibility Date	Used to search price lists which are eligible for the account or person from a particular date. Note: This field appears only when you have selected the Price List option from the Search By list. By default, the current date appears in this field when the Only Eligible Price Lists option is selected. You can change the value, if required.	No

Note: You must specify at least one search criterion while searching for a price list.

- **Search Results** – On clicking the **Search** button, the search results appear based on the specified search criteria. The search results include only those price lists that are associated with the division to which the account belongs. It may also include price lists that are already assigned to the account in case those price lists match the search criteria.

The **Search Results** section contains the following columns:

Column Name	Column Description
Assign	On clicking the Assign  icon, the Price List Assignment screen appears where you can assign the price list to the account or person.
Price List Information	Displays the information about the price list. Note: It has a link. On clicking the link, the Price List screen appears where you can view the details of the respective price list.
Account Information	Displays the information about the account. Note: It has a link. On clicking the link, the Account screen appears where you can view the details of the respective account.
Person Information	Displays the information about the person. Note: It has a link. On clicking the link, the Person screen appears where you can view the details of the respective person.
Effective Start Date	If you have selected the Price List option from the Search By list, the date from when the price list is effective appears in this column. However, if you have selected the Assigned Price List option from the Search By list, the date from when the price list is assigned to the account or person appears in this column.

Column Name	Column Description
Effective End Date	If you have selected the Price List option from the Search By list, the date till when the price list is effective appears in this column. However, if you have selected the Assigned Price List option from the Search By list, the date till when the price list is assigned to the account or person appears in this column.
Availability Start Date	Displays the date from when the price list is available for assignment to an account or a person.
Availability End Date	Displays the date till when the price list is available for assignment to an account or a person.

Related Topics

For more information on...	See...
How to assign a price list to an account	Assigning a Price List to an Account on page 510
How to assign a price list to a person	Assigning a Price List to a Person on page 513

Viewing Price Lists Assigned to an Account

Procedure

To view the price lists assigned to an account:

1. Search for the account in the **Customer 360° View** screen.
2. In the **Search Results** section, click the **Show Context Menu** () icon corresponding to the account whose details you want to view.

A menu appears.

3. Click the **Go To Price List Assignment** menu option.

The **Price List Assignment** screen appears. It contains the following zones:

- **Price List Assignments** – Lists the price lists that are already assigned to the account.
- **Price List Price Items** – Lists the price items that are assigned to the price list.
- **Search Price List for Assignment** – Enables you to search for a price list that you want to assign to the account.

4. Do either of the following:

If...	Then
If you want to view the price lists which are currently assigned to an account	<ol style="list-style-type: none"> 1. Ensure that the Current Price List Assignments option is selected from the Search By list. 2. Enter the required search criteria and then click Search. <p>The price lists which are currently assigned to the account appears in the search results.</p>
If you want to view the price lists assigned to an account which are inactive	<ol style="list-style-type: none"> 1. Select the Inactive Price List Assignments option from the Search By list.

If...	Then
	<ol style="list-style-type: none"> 2. Enter the required search criteria and then click Search. The price lists assigned to an account which are inactive appears in the search results.
If you want to view the price lists assigned to an account which are expired	<ol style="list-style-type: none"> 1. Select the Historical Price List Assignments option from the Search By list. 2. Enter the required search criteria and then click Search. The price lists assigned to an account which are expired appears in the search results.

Related Topics

For more information on...	See...
How to search for a person	Searching for an Account on page 204
Price List Assignment screen	Price List Assignment on page 500
Price List Assignments zone	Price List Assignments on page 501

Viewing Price Lists Assigned to a Person

Procedure

To view the price lists assigned to a person:

1. Search for the person in the **Customer 360° View** screen.
2. In the **Search Results** section, click the **Show Context Menu** (▼) icon corresponding to the person whose details you want to view.

A menu appears.

3. Click the **Go To Price List Assignment** menu option.

The **Price List Assignment** screen appears. It contains the following zones:

- **Price List Assignments** – Lists the price lists that are already assigned to the person.
- **Price List Price Items** – Lists the price items that are assigned to the price list.
- **Search Price List for Assignment** – Enables you to search for a price list that you want to assign to the person.

4. Do either of the following:

If...	Then
If you want to view the price lists which are currently assigned to a person	<ol style="list-style-type: none"> 1. Ensure that the Current Price List Assignments option is selected from the Search By list. 2. Enter the required search criteria and then click Search.

If...	Then
	The price lists which are currently assigned to the person appears in the search results.
If you want to view the price lists assigned to a person which are inactive	<ol style="list-style-type: none"> 1. Select the Inactive Price List Assignments option from the Search By list. 2. Enter the required search criteria and then click Search. <p>The price lists assigned to a person which are inactive appears in the search results.</p>
If you want to view the price lists assigned to a person which are expired	<ol style="list-style-type: none"> 1. Select the Historical Price List Assignments option from the Search By list. 2. Enter the required search criteria and then click Search. <p>The price lists assigned to a person which are expired appears in the search results.</p>

Related Topics

For more information on...	See...
How to search for a person	Searching for a Person on page 203
Price List Assignment screen	Price List Assignment on page 500
Price List Assignments zone	Price List Assignments on page 501

Viewing Price Items Assigned to a Price List

Prerequisites

To view the price items assigned to a price list, you should have:

- An algorithm defined using the **C1-PLPINFO** algorithm type and attached to **Pricelist Products Assignment Information** system event in the **Algorithms** tab of the **Installation Options – Framework** screen

Procedure

To view the price items assigned to a price list:

1. Do either of the following:

If you want to view...	Then...
Price items assigned to the price list which is assigned to the account	<ol style="list-style-type: none"> 1. Search for the account in the Customer 360° View screen. 2. In the Search Results section, click the Show Context Menu () icon corresponding to the account whose <i>details</i> you want to view. A menu appears. 3. Click the Go To Price List Assignment menu option.

If you want to view...	Then...
	<p>The Price List Assignment screen appears.</p> <p>4. In the Price List Assignments zone, click the Broadcast (📡) icon corresponding to the assigned price list whose price items you want to view.</p>
Price items assigned to the price list which is assigned to the person	<p>1. Search for the person in the Customer 360° View screen.</p> <p>2. In the Search Results section, click the Show Context Menu (▼) icon corresponding to the person whose <i>details</i> you want to view.</p> <p>A menu appears.</p> <p>3. Click the Go To Price List Assignment menu option.</p> <p>The Price List Assignment screen appears.</p> <p>4. In the Price List Assignments zone, click the Broadcast (📡) icon corresponding to the assigned price list whose price items you want to view.</p>

The **Price List Price Items** zone appears.

- View the price items that are assigned to the price list in the **Price List Price Items** zone.

Related Topics

For more information on...	See...
How to search for an account	Searching for an Account on page 204
How to search for a person	Searching for a Person on page 203
Price List Assignment screen	Price List Assignment on page 500
Price List Assignments zone	Price List Assignments on page 501
Price List Price Items zone	Price List Price Items on page 503

Assigning a Price List to an Account

Prerequisites

To assign a price list to an account, you should have:

- Price list defined in the application
- Price list associated with the division to which the account belongs
- Value defined for the **Default Price List Priority** option type in the **C1_PRICING** feature configuration

Procedure

To assign a price list to an account:

- Search for the account in the **Customer 360° View** screen.
- In the **Search Results** section, click the **Show Context Menu** (▼) icon corresponding to the account whose *details* you want to edit.

A menu appears.

3. Click the **Go To Price List Assignment** menu option.

The **Price List Assignment** screen appears. It contains the following zones:

- **Price List Assignments** – Lists the price lists that are already assigned to the account.
 - **Price List Price Items** – Lists the price items that are assigned to the price list.
 - **Search Price List for Assignment** – Enables you to search for a price list that you want to assign to the account.
4. In the **Search Price List for Assignment** zone, select the **Price List** or **Assigned Price List** option from the **Search By** list depending on whether you want to search against all price lists or against those price lists which are already assigned to an account or a person.
 5. Enter the search criteria in the **Search Price List for Assignment** zone.

Note: ORMB search engine supports wildcard search, where you can substitute the percentage (%) symbol as a stand in for any word or letter in a search criteria. You can use the ‘%’ wildcard character in all input fields except the date and ID fields. The ‘%’ wildcard character is suffixed automatically at the end of the partial search criteria. Therefore, you may or may not specify the wildcard character at the end of the partial search criteria. However, you have to prefix the wildcard character manually wherever required.

6. Click **Search**.

A list of price lists that meet the search criteria appears in the **Search Results** section.

Note: The search results include only those price lists that are associated with the division to which the account belongs. It may also include price lists that are already assigned to the account in case those price lists match the search criteria.

7. In the **Search Results** section, click the **Assign**  icon corresponding to the price list that you want to assign to the account.

The **Price List Assignment** screen appears. It consists of the following sections:

- **Main** – Used to specify basic information while assigning the price list to the account.
- **Characteristics** – Used to define the characteristics for the price list assignment.

The **Main** section contains the following fields:

Field Name	Field Description	Mandatory (Yes or No)
Account Information	Indicates the account to which you want to assign the price list.	Not applicable
Price List Information	Displays the information about the price list.	Not applicable
Effective Start Date	Used to specify the date from when you want to assign the price list to the account. Note: The price list assignment start date cannot be earlier than the price list effective start date or later than the price list effective end date.	Yes
Effective End Date	Used to specify the date till when you want to assign the price list to the account.	No

Field Name	Field Description	Mandatory (Yes or No)										
	<p>Note:</p> <p>The effective end date cannot be earlier than the effective start date.</p> <p>If the validity period is specified for the price list, the price list assignment end date should be earlier than or equal to the following whichever is earlier:</p> <ul style="list-style-type: none"> • Price list assignment validity end date (which is price list assignment start date + validity period) • Price list effective end date <p>Let us understand this with the help of the following example:</p> <table border="1"> <tr> <td>Price List Effective Start Date</td> <td>01-Jan-2015</td> </tr> <tr> <td>Price List Effective End Date</td> <td>31-Jan-2015</td> </tr> <tr> <td>Validity Period</td> <td>15 Days</td> </tr> <tr> <td>Price List Assignment Start Date</td> <td>15-Jan-2015</td> </tr> <tr> <td>Price List Assignment Validity End Date</td> <td>30-Jan-2015 (i.e. 15-Jan-2015 + 15 Days)</td> </tr> </table> <p>In the above example, the price list assignment end date must be earlier than or equal to the price list assignment validity end date because the price list assignment validity end date is earlier than the price list effective end date.</p>	Price List Effective Start Date	01-Jan-2015	Price List Effective End Date	31-Jan-2015	Validity Period	15 Days	Price List Assignment Start Date	15-Jan-2015	Price List Assignment Validity End Date	30-Jan-2015 (i.e. 15-Jan-2015 + 15 Days)	
Price List Effective Start Date	01-Jan-2015											
Price List Effective End Date	31-Jan-2015											
Validity Period	15 Days											
Price List Assignment Start Date	15-Jan-2015											
Price List Assignment Validity End Date	30-Jan-2015 (i.e. 15-Jan-2015 + 15 Days)											
Priority	Used to specify the order in which the price list should be considered while determining the price item pricing for the account.	Yes										
Price List Inheritance	Used to indicate whether the account can avail the price item pricing listed on the parent or grandparent price list if it is not available on the price list. The valid values are: <ul style="list-style-type: none"> • Yes – Used to indicate that the account can inherit the price item pricing from the price list hierarchy. • No – Used to indicate that the account cannot inherit the price item pricing from the price list hierarchy. 	Yes										
Assignment Status	Used to indicate the status of the price list assignment. The valid values are: <ul style="list-style-type: none"> • Active – Used to indicate that you want to use the price item pricing on the price list for billing. • Proposed – Used to indicate that you want to use the price item pricing on the price list for quotations. 	Yes										

8. Enter the required details in the **Main** section.

9. Define characteristics for the price list assignment, if required.

10. Click **Save**.

The price list is assigned to the account.

Related Topics

For more information on...	See
How to search for an account	Searching for an Account on page 204
Price List Assignment screen	Price List Assignment on page 500
Search Price List for Assignment zone	Search Price List for Assignment on page 504
How to define a characteristic for a price list assignment	Defining a Characteristic for a Price List Assignment on page 516
How to set the C1_PRICING feature configuration	Setting the C1_PRICING Feature Configuration on page 4342

Assigning a Price List to a Person

Prerequisites

To assign a price list to a person, you should have:

- Price list defined in the application
- Price list associated with the division to which the person belongs
- Value defined for the **Default Price List Priority** option type in the **C1_PRICING** feature configuration

Procedure

To assign a price list to a person:

1. Search for the person in the **Customer 360° View** screen.
2. In the **Search Results** section, click the **Show Context Menu** () icon corresponding to the person whose details you want to edit.

A menu appears.

3. Click the **Go To Price List Assignment** menu option.

The **Price List Assignment** screen appears. It contains the following zones:

- **Price List Assignments** – Lists the price lists that are already assigned to the person.
 - **Price List Price Items** – Lists the price items that are assigned to the price list.
 - **Search Price List for Assignment** – Enables you to search for a price list that you want to assign to the person.
4. In the **Search Price List for Assignment** zone, select the **Price List** or **Assigned Price List** option from the **Search By** list depending on whether you want to search against all price lists or against those price lists which are already assigned to an account or a person.
 5. Enter the search criteria in the **Search Price List for Assignment** zone.

Note: ORMB search engine supports wildcard search, where you can substitute the percentage (%) symbol as a stand in for any word or letter in a search criteria. You can use the ‘%’ wildcard character in all input fields except the date and ID fields. The ‘%’ wildcard character is suffixed automatically at the end of the partial search criteria. Therefore, you may or may not specify the wildcard character at the end of the partial search criteria. However, you have to prefix the wildcard character manually wherever required.

6. Click **Search**.

A list of price lists that meet the search criteria appears in the **Search Results** section.

Note: The search results include only those price lists that are associated with the division to which the person belongs. It may also include price lists that are already assigned to the person in case those price lists match the search criteria.

7. In the **Search Results** section, click the **Assign** () icon corresponding to the price list that you want to assign to the person.

The **Price List Assignment** screen appears. It consists of the following sections:

- **Main** – Used to specify basic information while assigning the price list to the person.
- **Characteristics** – Used to define the characteristics for the price list assignment.

The **Main** section contains the following fields:

Field Name	Field Description	Mandatory (Yes or No)
Person Information	Indicates the person to whom you want to assign the price list.	Not applicable
Price List Information	Displays the information about the price list.	Not applicable
Effective Start Date	Used to specify the date from when you want to assign the price list to the person. Note: The price list assignment start date cannot be earlier than the price list effective start date or later than the price list effective end date.	Yes
Effective End Date	Used to specify the date till when you want to assign the price list to the person.	No

Field Name	Field Description	Mandatory (Yes or No)										
	<p>Note:</p> <p>The effective end date cannot be earlier than the effective start date.</p> <p>If the validity period is specified for the price list, the price list assignment end date should be earlier than or equal to the following whichever is earlier:</p> <ul style="list-style-type: none"> • Price list assignment validity end date (which is price list assignment start date + validity period) • Price list effective end date <p>Let us understand this with the help of the following example:</p> <table border="1" data-bbox="516 663 1138 1041"> <tr> <td>Price List Effective Start Date</td> <td>01-Jan-2015</td> </tr> <tr> <td>Price List Effective End Date</td> <td>31-Jan-2015</td> </tr> <tr> <td>Validity Period</td> <td>15 Days</td> </tr> <tr> <td>Price List Assignment Start Date</td> <td>15-Jan-2015</td> </tr> <tr> <td>Price List Assignment Validity End Date</td> <td>30-Jan-2015 (i.e. 15-Jan-2015 + 15 Days)</td> </tr> </table> <p>In the above example, the price list assignment end date must be earlier than or equal to the price list assignment validity end date because the price list assignment validity end date is earlier than the price list effective end date.</p>	Price List Effective Start Date	01-Jan-2015	Price List Effective End Date	31-Jan-2015	Validity Period	15 Days	Price List Assignment Start Date	15-Jan-2015	Price List Assignment Validity End Date	30-Jan-2015 (i.e. 15-Jan-2015 + 15 Days)	
Price List Effective Start Date	01-Jan-2015											
Price List Effective End Date	31-Jan-2015											
Validity Period	15 Days											
Price List Assignment Start Date	15-Jan-2015											
Price List Assignment Validity End Date	30-Jan-2015 (i.e. 15-Jan-2015 + 15 Days)											
Priority	Used to specify the order in which the price list should be considered while determining the price item pricing for the person.	Yes										
Price List Inheritance	<p>Used to indicate whether the person can avail the price item pricing listed on the parent or grandparent price list if it is not available on the price list. The valid values are:</p> <ul style="list-style-type: none"> • Yes – Used to indicate that the person can inherit the price item pricing from the price list hierarchy. • No – Used to indicate that the person cannot inherit the price item pricing from the price list hierarchy. 	Yes										
Assignment Status	<p>Used to indicate the status of the price list assignment. The valid values are:</p> <ul style="list-style-type: none"> • Active – Used to indicate that you want to use the price item pricing on the price list for billing. • Proposed – Used to indicate that you want to use the price item pricing on the price list for quotations. 	Yes										

8. Enter the required details in the **Main** section.

9. Define characteristics for the price list assignment, if required.

10. Click **Save**.

The price list is assigned to the person.

Related Topics

For more information on...	See
How to search for a person	Searching for a Person on page 203
Price List Assignment screen	Price List Assignment on page 500
Search Price List for Assignment zone	Search Price List for Assignment on page 504
How to define a characteristic for a price list assignment	Defining a Characteristic for a Price List Assignment on page 516
How to set the C1_PRICING feature configuration	Setting the C1_PRICING Feature Configuration on page 4342

Defining a Characteristic for a Price List Assignment

Prerequisites

To define a characteristic for a price list assignment, you should have:

- Characteristic types defined in the application (where the characteristic entity is set to **Price List Assignment**)

Procedure

To define a characteristic for a price list assignment:

1. Ensure that the **Characteristics** section is expanded when you are defining or editing characteristics for a price list assignment.

The **Characteristics** section contains the following fields:

Field Name	Field Description	Mandatory (Yes or No)
Effective Date	Used to specify the date from when the characteristic is effective for the price list assignment.	Yes (Conditional) Note: This field is required when you are defining a characteristic for the price list assignment.
Characteristic Type	Used to indicate the characteristic type. Note: The list includes only those characteristic types where the characteristic entity is set to Price List Assignment .	Yes (Conditional) Note: This field is required when you are defining a characteristic for the price list assignment.
Characteristic Value	Used to specify the value for the characteristic type. Note: On specifying the value for a predefined characteristic type, the description of the characteristic value appears corresponding to the Characteristic Value field.	Yes (Conditional) Note: This field is required when you are defining a characteristic for the price list assignment.

2. Enter the required details in the **Characteristics** section.

Note: If you select a predefined characteristic type, the **Search** (🔍) icon appears corresponding to the **Characteristic Value** field. On clicking the **Search** icon, you can search for a predefined characteristic value.

- If you want to define more than one characteristic for the price list assignment, click the **Add** (+) icon and then repeat step 2.

Note: However, if you want to remove a characteristic from the price list assignment, click the **Delete** (🗑️) icon corresponding to the characteristic.

- Click **Save**.

The characteristics are defined for the price list assignment.

Related Topics

For more information on...	See...
How to assign a price list to an account	Assigning a Price List to an Account on page 510
How to assign a price list to a person	Assigning a Price List to a Person on page 513
How to edit the price list assignment details of an account	Editing the Price List Assignment Details of an Account on page 517
How to edit the price list assignment details of a person	Editing the Price List Assignment Details of a Person on page 520

Editing the Price List Assignment Details of an Account

Procedure

To edit the price list assignment details of an account:

- Search for the account in the **Customer 360° View** screen.
- In the **Search Results** section, click the **Show Context Menu** (▼) icon corresponding to the account whose details you want to edit.

A menu appears.

- Click the **Go To Price List Assignment** menu option.

The **Price List Assignment** screen appears. It contains the following zones:

- **Price List Assignments** – Lists the price lists that are already assigned to the account.
- **Price List Price Items** – Lists the price items that are assigned to the price list.
- **Search Price List for Assignment** – Enables you to search for a price list that you want to assign to the account.

- Do either of the following:

If you want to...	Then...
Edit the details of the price list assignment which is currently effective	<ol style="list-style-type: none"> Select the Current Price List Assignments option from the Search By list. Enter the required search criteria and then click Search. <p>The price lists which are currently assigned to the account appears in the search results.</p>

If you want to...	Then...
	<p>3. In the Search Results section, click the Edit (✎) icon in the Edit column corresponding to the price list whose assignment details you want to edit.</p>
<p>Edit the details of the price list assignment which is expired</p>	<p>1. Select the Historical Price List Assignments option from the Search By list.</p> <p>2. Enter the required search criteria and then click Search.</p> <p>The price lists assigned to an account which are expired appears in the search results.</p> <p>3. In the Search Results section, click the Edit (✎) icon in the Edit column corresponding to the price list whose assignment details you want to edit.</p>

The **Price List Assignment** screen appears. It contains the following sections:

- **Main** – Used to specify basic information while assigning the price list to the account.
- **Characteristics** – Used to define the characteristics for the price list assignment.

The **Main** section contains the following fields:

Field Name	Field Description	Mandatory (Yes or No)
Account Information	Indicates the account whose price list assignment details you want to edit.	Not applicable
Price List Information	Displays the information about the price list.	Not applicable
Effective Start Date	Displays the date from when the price list is assigned to the account.	Not applicable
Effective End Date	Used to specify the date till when you want to assign the price list to the account.	No

Field Name	Field Description	Mandatory (Yes or No)										
	<p>Note:</p> <p>The effective end date cannot be earlier than the effective start date.</p> <p>If the validity period is specified for the price list, the price list assignment end date should be earlier than or equal to the following whichever is earlier:</p> <ul style="list-style-type: none"> • Price list assignment validity end date (which is price list assignment start date + validity period) • Price list effective end date <p>Let us understand this with the help of the following example:</p> <table border="1" data-bbox="516 663 1138 1041"> <tr> <td>Price List Effective Start Date</td> <td>01-Jan-2015</td> </tr> <tr> <td>Price List Effective End Date</td> <td>31-Jan-2015</td> </tr> <tr> <td>Validity Period</td> <td>15 Days</td> </tr> <tr> <td>Price List Assignment Start Date</td> <td>15-Jan-2015</td> </tr> <tr> <td>Price List Assignment Validity End Date</td> <td>30-Jan-2015 (i.e. 15-Jan-2015 + 15 Days)</td> </tr> </table> <p>In the above example, the price list assignment end date must be earlier than or equal to the price list assignment validity end date because the price list assignment validity end date is earlier than the price list effective end date.</p>	Price List Effective Start Date	01-Jan-2015	Price List Effective End Date	31-Jan-2015	Validity Period	15 Days	Price List Assignment Start Date	15-Jan-2015	Price List Assignment Validity End Date	30-Jan-2015 (i.e. 15-Jan-2015 + 15 Days)	
Price List Effective Start Date	01-Jan-2015											
Price List Effective End Date	31-Jan-2015											
Validity Period	15 Days											
Price List Assignment Start Date	15-Jan-2015											
Price List Assignment Validity End Date	30-Jan-2015 (i.e. 15-Jan-2015 + 15 Days)											
Priority	Used to specify the order in which the price list should be considered while determining the price item pricing for the account.	Yes										
Price List Inheritance	<p>Used to indicate whether the account can avail the price item pricing listed on the parent or grandparent price list if it is not available on the price list. The valid values are:</p> <ul style="list-style-type: none"> • Yes – Used to indicate that the account can inherit the price item pricing from the price list hierarchy. • No – Used to indicate that the account cannot inherit the price item pricing from the price list hierarchy. 	Yes										
Assignment Status	<p>Used to indicate the status of the price list assignment. The valid values are:</p> <ul style="list-style-type: none"> • Active – Used to indicate that you want to use the price item pricing on the price list for billing. This value appears when you are editing an active and proposed price list assignment. • Proposed – Used to indicate that you want to use the price item pricing on the price list for quotations. This 	Yes										

Field Name	Field Description	Mandatory (Yes or No)
	<p>value appears when you are editing a proposed price list assignment.</p> <ul style="list-style-type: none"> • Rejected – Used to indicate that you want to reject the price list assignment. This value appears only when you are editing a proposed price list assignment. • Inactive – Used to indicate that you no longer want to use the price list assignment. This value appears when you are editing an active price list assignment. 	
	<p>Note: You cannot change the status of a rejected price list assignment.</p>	

5. Modify the required details in the **Main** section.
6. Define, edit, or remove characteristics of the price list assignment, if required.
7. Click **Save**.

The changes made to the price list assignment are saved.

Related Topics

For more information on...	See
How to search for an account	Searching for an Account on page 204
Price List Assignment screen	Price List Assignment on page 500
Price List Assignments zone	Price List Assignments on page 501
How to define a characteristic for a price list assignment	Defining a Characteristic for a Price List Assignment on page 516

Editing the Price List Assignment Details of a Person

Procedure

To edit the price list assignment details of a person:

1. Search for the person in the **Customer 360° View** screen.
2. In the **Search Results** section, click the **Show Context Menu** () icon corresponding to the person whose details you want to edit.



A menu appears.

3. Click the **Go To Price List Assignment** menu option.

The **Price List Assignment** screen appears. It contains the following zones:

- **Price List Assignments** – Lists the price lists that are already assigned to the person.
- **Price List Price Items** – Lists the price items that are assigned to the price list.
- **Search Price List for Assignment** – Enables you to search for a price list that you want to assign to the person.

4. Do either of the following:

If you want to...	Then...
Edit the details of the price list assignment which is currently effective	<ol style="list-style-type: none"> 1. Select the Current Price List Assignments option from the Search By list. 2. Enter the required search criteria and then click Search. The price lists which are currently assigned to the person appears in the search results. 3. In the Search Results section, click the Edit  icon in the Edit column corresponding to the price list whose assignment details you want to edit.
Edit the details of the price list assignment which is expired	<ol style="list-style-type: none"> 1. Select the Historical Price List Assignments option from the Search By list. 2. Enter the required search criteria and then click Search. The price lists assigned to a person which are expired appears in the search results. 3. In the Search Results section, click the Edit  icon in the Edit column corresponding to the price list whose assignment details you want to edit.

The **Price List Assignment** screen appears. It contains the following sections:

- **Main** – Used to specify basic information while assigning the price list to the person.
- **Characteristics** – Used to define the characteristics for the price list assignment.

The **Main** section contains the following fields:

Field Name	Field Description	Mandatory (Yes or No)
Person Information	Indicates the person whose price list assignment details you want to edit.	Not applicable
Price List Information	Displays the information about the price list.	Not applicable
Effective Start Date	Displays the date from when the price list is assigned to the person.	Not applicable
Effective End Date	Used to specify the date till when the price list is assigned to the person.	No

Field Name	Field Description	Mandatory (Yes or No)										
	<p>Note:</p> <p>The effective end date cannot be earlier than the effective start date.</p> <p>If the validity period is specified for the price list, the price list assignment end date should be earlier than or equal to the following whichever is earlier:</p> <ul style="list-style-type: none"> • Price list assignment validity end date (which is price list assignment start date + validity period) • Price list effective end date <p>Let us understand this with the help of the following example:</p> <table border="1" data-bbox="516 663 1138 1041"> <tr> <td>Price List Effective Start Date</td> <td>01-Jan-2015</td> </tr> <tr> <td>Price List Effective End Date</td> <td>31-Jan-2015</td> </tr> <tr> <td>Validity Period</td> <td>15 Days</td> </tr> <tr> <td>Price List Assignment Start Date</td> <td>15-Jan-2015</td> </tr> <tr> <td>Price List Assignment Validity End Date</td> <td>30-Jan-2015 (i.e. 15-Jan-2015 + 15 Days)</td> </tr> </table> <p>In the above example, the price list assignment end date must be earlier than or equal to the price list assignment validity end date because the price list assignment validity end date is earlier than the price list effective end date.</p>	Price List Effective Start Date	01-Jan-2015	Price List Effective End Date	31-Jan-2015	Validity Period	15 Days	Price List Assignment Start Date	15-Jan-2015	Price List Assignment Validity End Date	30-Jan-2015 (i.e. 15-Jan-2015 + 15 Days)	
Price List Effective Start Date	01-Jan-2015											
Price List Effective End Date	31-Jan-2015											
Validity Period	15 Days											
Price List Assignment Start Date	15-Jan-2015											
Price List Assignment Validity End Date	30-Jan-2015 (i.e. 15-Jan-2015 + 15 Days)											
Priority	Used to specify the order in which the price list should be considered while determining the price item pricing for the person.	Yes										
Price List Inheritance	<p>Used to indicate whether the person can avail the price item pricing listed on the parent or grandparent price list if it is not available on the price list. The valid values are:</p> <ul style="list-style-type: none"> • Yes – Used to indicate that the person can inherit the price item pricing from the price list hierarchy. • No – Used to indicate that the person cannot inherit the price item pricing from the price list hierarchy. 	Yes										
Assignment Status	<p>Used to indicate the status of the price list assignment. The valid values are:</p> <ul style="list-style-type: none"> • Active – Used to indicate that you want to use the price item pricing on the price list for billing. This value appears when you are editing an active and proposed price list assignment. • Proposed – Used to indicate that you want to use the price item pricing on the price list for quotations. This 	Yes										

Field Name	Field Description	Mandatory (Yes or No)
	<p>value appears when you are editing a proposed price list assignment.</p> <ul style="list-style-type: none"> • Rejected – Used to indicate that you want to reject the price list assignment. This value appears only when you are editing a proposed price list assignment. • Inactive – Used to indicate that you no longer want to use the price list assignment. This value appears when you are editing an active price list assignment. 	
	<p>Note: You cannot change the status of a rejected price list assignment.</p>	

5. Modify the required details in the **Main** section.
6. Define, edit, or remove characteristics of the price list assignment, if required.
7. Click **Save**.

The changes made to the price list assignment are saved.

Related Topics

For more information on...	See
How to search for a person	Searching for a Person on page 203
Price List Assignment screen	Price List Assignment on page 500
Price List Assignments zone	Price List Assignments on page 501
How to define a characteristic for a price list assignment	Defining a Characteristic for a Price List Assignment on page 516

Price List Assignments

The **Price List Assignments** screen allows you to view the persons and accounts where the price list is assigned. It contains the following zones:

- [Persons to whom Price List is Assigned](#) on page 524
- [Accounts where Price List is Assigned](#) on page 523

Accounts where Price List is Assigned

The **Accounts where Price List is Assigned** zone displays the details of the accounts where the price list is assigned. It contains the following columns:

Column Name	Column Description
Account ID	Displays the account ID.
Account Information	<p>Displays the concatenated string of information about the account separated by a comma (.). In addition, a context menu appears corresponding to this field which helps in navigating to other screens in the application.</p> <p>Note: It has a link. On clicking the link, the Account screen appears where you can view the details of the respective account.</p>

Column Name	Column Description
Price List Assignment Start Date	Displays the date from when the price list assigned to the account.
Price List Assignment End Date	Displays the date till when the price list assigned to the account.
Division	Displays the division to which the account belongs.
Price List Assignment ID	Displays the price list assignment ID.

Note: Pagination is used to display limited number of records in this zone. You can use the navigation links, such as **Previous** and **Next** to navigate between pages.

Related Topics

For more information on...	See...
How to search a price list	Searching for a Price List on page 449
How to view the accounts and persons where the price list is assigned	Viewing Accounts and Persons where Price List is Assigned on page 524

Persons to whom Price List is Assigned

The **Persons to whom Price List is Assigned** zone displays the details of the persons to whom the price list is assigned. It contains the following columns:

Column Name	Column Description
Person ID	Displays the person ID.
Person Information	Displays the concatenated string of information about the person separated by a comma (.). In addition, a context menu appears corresponding to this field which helps in navigating to other screens in the application. Note: It has a link. On clicking the link, the Person screen appears where you can view the details of the respective person.
Price List Assignment Start Date	Displays the date from when the price list is assigned to the person.
Price List Assignment End Date	Displays the date till when the price list is assigned to the person.
Division	Displays the division to which the person belongs.
Price List Assignment ID	Displays the price list assignment ID.

Note: Pagination is used to display limited number of records in this zone. You can use the navigation links, such as **Previous** and **Next** to navigate between pages.

Related Topics

For more information on...	See...
How to search a price list	Searching for a Price List on page 449
How to view the accounts and persons where the price list is assigned	Viewing Accounts and Persons where Price List is Assigned on page 524

Viewing Accounts and Persons where Price List is Assigned

Procedure

To view the accounts and persons where the price list is assigned:

1. Search for the price list in the **Price List** screen.
2. In the **Search Results** section, click the **View** (🔗) icon in the **Price List Assigned To** column corresponding to the price list whose assignment details you want to view.
The **Price List Assignments** screen appears.
3. View the persons to whom the price list is assigned in the **Persons to whom Price List is Assigned** zone and view the accounts where the price list is assigned in the **Accounts where Price List is Assigned** zone.

Related Topics

For more information on...	See...
How to search a price list	Searching for a Price List on page 449
Accounts where Price List is Assigned zone	Accounts where Price List is Assigned on page 523
Persons to whom Price List is Assigned zone	Persons to whom Price List is Assigned on page 524

Entities Eligible for Price List Assignment

The **Entities Eligible for Price List Assignment** screen allows you to view the accounts and persons that are eligible for the price list assignment. It also allows you to search for a list of eligible accounts and persons and assign them to the price list. It contains the following zones:

- [Eligible Accounts](#) on page 525
- [Eligible Persons](#) on page 527

Eligible Accounts

The **Eligible Accounts** zone allows you to search for the accounts that are eligible for the price list assignment. It also allows you to assign the price list to one or more eligible accounts. It contains the following two sections:

- **Search Criteria** - The **Search Criteria** section contains the following fields:

Field Name	Field Description	Mandatory (Yes or No)
Division	Used to indicate the division whose eligible accounts you want to search for the price list assignment. Note: You can view only those divisions to which you have access in the Division list. Also, the list shows only those divisions to which the price list is associated.	Yes
Effective Date	Used to search accounts by specifying the date from when they are eligible for price list assignment.	No
Account ID	Used to search a particular account to which you want to assign the price list.	No

Field Name	Field Description	Mandatory (Yes or No)
	<p>Note:</p> <p>The Search (🔍) icon appears corresponding to the Account ID field. On clicking the Search icon, the Account Search window appears where you can search for the respective account.</p> <p>On specifying the account, the account information appears corresponding to the Account ID field. The account information has a link. On clicking the link, the Account screen appears where you can view the details of the respective account.</p>	

- **Search Results** - On clicking the **Search** button, the search results appear based on the specified search criteria. The **Search Results** section contains the following columns:

Column Name	Column Description
Account Information	<p>Displays the concatenated string of information about the account separated by a comma (.). In addition, a context menu appears corresponding to this field which helps in navigating to other screens in the application.</p> <p>Note: It has a link. On clicking the link, the Account screen appears where you can view the details of the respective account.</p>
Assigned	<p>Indicates whether the price list is assigned to the account or not. The valid values are:</p> <ul style="list-style-type: none"> • Yes • No

You can select one or more accounts for price list assignment by clicking the check box corresponding to the **Account Information** column.

Note: Pagination is used to display limited number of records in the **Search Results** section. You can use the navigation links, such as **Previous** and **Next** to navigate between pages.

In addition, the **Search Results** section contains the following button:

Button Name	Button Description
Assign	On clicking the Assign button, you can assign the price list to the selected account/accounts.

Related Topics

For more information on...	See...
How to search for a price list	Searching for a Price List on page 449
How to view the accounts and persons eligible for price list assignment	Viewing Accounts and Persons Eligible for Price List Assignment on page 462

For more information on...	See...
How to define a characteristic for a price list assignment	Defining a Characteristic for a Price List Assignment on page 532

Eligible Persons

The **Eligible Persons** zone allows you to search for the persons that are eligible for the price list assignment. It also allows you to assign the price list to one or more eligible persons. It contains the following two sections:

- **Search Criteria** - The **Search Criteria** section contains the following fields:

Field Name	Field Description	Mandatory (Yes or No)
Division	<p>Used to indicate the division whose eligible persons you want to search for the price list assignment.</p> <p>Note: You can view only those divisions to which you have access in the Division list. Also, the list shows only those divisions to which the price list is associated.</p>	Yes
Effective Date	Used to search persons by specifying the date from when they are eligible for price list assignment.	No
Person ID	<p>Used to search a particular person to whom you want to assign the price list.</p> <p>Note: The Search (🔍) icon appears corresponding to the Person ID field. On clicking the Search icon, the Person Search window appears where you can search for the respective person. On specifying the person, the person information appears corresponding to the Person ID field. The person information has a link. On clicking the link, the Person screen appears where you can view the details of the respective person.</p>	No

- **Search Results** - On clicking the **Search** button, the search results appear based on the specified search criteria. The **Search Results** section contains the following columns:

Column Name	Column Description
Person Information	Displays the concatenated string of information about the person separated by a comma (.). In addition, a context menu appears corresponding to this field which helps in navigating to other screens in the application.

Column Name	Column Description
	Note: It has a link. On clicking the link, the Person screen appears where you can view the details of the respective person.
Assigned	Indicates whether the price list is assigned to the person or not. The valid values are: <ul style="list-style-type: none"> • Yes • No

You can select one or more persons for price list assignment by clicking the check box corresponding to the **Person Information** column.

Note: Pagination is used to display limited number of records in the **Search Results** section. You can use the navigation links, such as **Previous** and **Next** to navigate between pages.

In addition, the **Search Results** section contains the following button:

Button Name	Button Description
Assign	On clicking the Assign button, you can assign the price list to the selected person/persons.

Related Topics

For more information on...	See...
How to search for a price list	Searching for a Price List on page 449
How to view the accounts and persons eligible for price list assignment	Viewing Accounts and Persons Eligible for Price List Assignment on page 462
How to define a characteristic for a Price List Assignment	Defining a Characteristic for a Price List Assignment on page 532

Assigning a Price List to One or More Eligible Accounts

Prerequisites

To assign a price list to one or more eligible accounts, you should have:

- Price list defined in the application
- Accounts created in the application
- Price list associated with the division to which the account/accounts belong.
- Value defined for the **Default Price List Priority** option type in the **C1_PRICING** feature configuration

Procedure

To assign a price list to one or more eligible accounts:

1. Search for the eligible accounts in the **Eligible Accounts** zone of the **Entities Eligible for Price List Assignment** screen.
2. In the **Search Results** section, click the check box corresponding to the account/accounts to which you want to assign the price list.
3. Click the **Assign** button available in the upper left corner of the **Search Results** section.

The **Price List Assignment** screen appears. It contains the following two sections:

- **Main** - Used to specify basic details about the price list assignment.
- **Characteristics** - Used to define a list of characteristics for the price list assignment.

The **Main** section contains the following fields:

Field Name	Field Description	Mandatory (Yes or No)
Price List Information	Displays the concatenated string of information about the price list separated by a comma (,).	Not applicable
Effective Start Date	Used to specify the date from when the price list assignment is effective for the account/accounts.	Yes
Effective End Date	Used to specify the date till when the price list assignment is effective for the account/accounts.	No
Priority	Used to specify the order in which the price list is considered while determining the price item pricing for the account.	No
Price List Inheritance	Used to indicate whether the account can avail the price item pricing listed on the parent or grandparent price list if it is not available on the price list. The valid values are: <ul style="list-style-type: none"> • Yes • No 	No
Assignment Status	Used to indicate the status of the price list assignment. The valid values are: <ul style="list-style-type: none"> • Active • Proposed 	No
Priority Indicator	Used to set the priority of the price list assignment. The valid values are: <ul style="list-style-type: none"> • Highest - Used when you want the price list assignment to have the highest priority. It checks whether there are any other price list assignments for the account, derives the priority of each such price list assignment, and then sets the priority of the new price list assignment to the existing price list assignment with highest priority minus one. • Lowest - Used when you want the price list assignment to have the lowest priority. It checks whether there are any other price list assignments for the account, derives the priority of each such price list assignment, and then sets the priority of the new price list assignment to the existing price list 	No

Field Name	Field Description	Mandatory (Yes or No)
	assignment with lowest priority plus one.	

- Enter the required details in the **Main** section.
- Define a list of characteristics for the price list assignment in the **Characteristics** section, if required/
- Click **Save**.

The price list is assigned to the selected account/accounts.

Related Topics

For more information on...	See...
How to search for a price list	Searching for a Price List on page 449
Eligible Accounts zone	Eligible Accounts on page 525
Entities Eligible for Price List Assignment screen.	Entities Eligible for Price List Assignment on page 525
How to define a characteristic for a Price List Assignment	Defining a Characteristic for a Price List Assignment on page 532
How to set the C1_PRICING feature configuration	Setting the C1_PRICING Feature Configuration on page 4342

Assigning a Price List to One or More Eligible Persons

Prerequisites

To assign a price list to one or more eligible persons, you should have:

- Price list defined in the application
- Persons created in the application
- Price list associated with the division to which the person/persons belong.
- Value defined for the **Default Price List Priority** option type in the **C1_PRICING** feature configuration

Procedure

To assign a price list to one or more eligible persons:

- Search for the eligible persons in the **Eligible Persons** zone of the **Entities Eligible for Price List Assignment** screen.
- In the **Search Results** section, click the check box corresponding to the person/persons to whom you want to assign the price list.
- Click the **Assign** button available in the upper left corner of the **Search Results** section.

The **Price List Assignment** screen appears. It contains the following two sections:

- Main** - Used to specify basic details about the price list assignment.
- Characteristics** - Used to define a list of characteristics for the price list assignment.

The **Main** section contains the following fields:

Field Name	Field Description	Mandatory (Yes or No)
Price List Information	Displays the concatenated string of information about the price list separated by a comma (,).	Not applicable
Effective Start Date	Used to specify the date from when the price list assignment is effective for the person/persons.	Yes
Effective End Date	Used to specify the date till when the price list assignment is effective for the person/persons.	No
Priority	Used to specify the order in which the price list is considered while determining the price item pricing for the person.	No
Price List Inheritance	Used to indicate whether the person can avail the price item pricing listed on the parent or grandparent price list if it is not available on the price list. The valid values are: <ul style="list-style-type: none"> • Yes • No 	No
Assignment Status	Used to indicate the status of the price list assignment. The valid values are: <ul style="list-style-type: none"> • Active • Proposed 	No
Priority Indicator	Used to set the priority of the price list assignment. The valid values are: <ul style="list-style-type: none"> • Highest - Used when you want the price list assignment to have the highest priority. It checks whether there are any other price list assignments for the person, derives the priority of each such price list assignment, and then sets the priority of the new price list assignment to the existing price list assignment with highest priority minus one. • Lowest - Used when you want the price list assignment to have the lowest priority. It checks whether there are any other price list assignments for the person, derives the priority of each such price list assignment, and then sets the priority of the new price list assignment to the existing price list assignment with lowest priority plus one. 	No

4. Enter the required details in the **Main** section.
5. Define a list of characteristics for the price list assignment in the **Characteristics** section, if required/
6. Click **Save**.

The price list is assigned to the selected person/persons.

Related Topics

For more information on...	See...
How to search for a price list	Searching for a Price List on page 449
Eligible Persons zone	Eligible Persons on page 527
Entities Eligible for Price List Assignment screen.	Entities Eligible for Price List Assignment on page 525
How to define a characteristic for a Price List Assignment	Defining a Characteristic for a Price List Assignment on page 532
How to set the C1_PRICING feature configuration	Setting the C1_PRICING Feature Configuration on page 4342

Defining a Characteristic for a Price List Assignment

Prerequisites

To define a characteristic for a price list assignment, you should have:

- Characteristic types defined in the application (where the characteristic entity is set to **Price List Assignment**)

Procedure

To define a characteristic for a price list assignment:

1. Ensure that the **Characteristics** section is expanded when you are assigning a price list to multiple persons or accounts or when you are editing the price list assignment details of multiple persons or accounts.

The **Characteristics** section contains the following fields in a grid:

Field Name	Field Description	Mandatory (Yes or No)
Effective Date	Used to specify the date from when the characteristic is effective for the price list assignment.	Yes (Conditional) Note: This field is required while defining a characteristic for the price list assignment.
Characteristic Type	Used to indicate the characteristic type. Note: The list includes only those characteristic types where the characteristic entity is set to Price List Assignment .	Yes (Conditional) Note: This field is required while defining a characteristic for the price list assignment.
Characteristic Value	Used to specify the value for the characteristic type.	Yes (Conditional) Note: This field is required while defining a characteristic for the price list assignment.

Field Name	Field Description	Mandatory (Yes or No)
	<p>Note: If you select a predefined characteristic type, the Search (🔍) icon appears corresponding to the Characteristic Value field. On clicking the Search icon, the Predefined Characteristic Search window appears.</p> <p>On specifying the value for a predefined characteristic type, the description of the characteristic value appears corresponding to the Characteristic Value field.</p>	

- Enter the required details in the **Characteristics** section.
- If you want to define more than one characteristic for the price list assignment, click the **Add** (+) icon and then repeat step 2.

Note: However, if you want to remove a characteristic from the price list assignment, click the **Delete** (🗑️) icon corresponding to the characteristic.

- Click **Save**.

The characteristic is defined for the price list assignment.

Related Topics

For more information on...	See...
How to assign a price list to a person	Assigning a Price List to a Person on page 513
How to edit the price list assignment details of a person	Editing the Price List Assignment Details of a Person on page 520

Price List Simulation

Oracle Revenue Management and Billing provides you a price list simulator wherein you can simulate the pricing and analyze the revenue impact. A new screen named **Price List Simulation** is introduced in this release. It enables you to search for a price list whose price item pricing you want to simulate. You can search for:

- Price lists assigned to customers or accounts where a particular characteristic is defined
- Price lists where a particular price item is assigned
- Price list which is associated with a particular product
- Price lists with a particular description

Once you search for a price list, you can simulate the pricing in a particular currency. On clicking the icon in the **Price List Simulation – Proposal** column, the **Price List Simulation – Proposal** screen appears where you can individually update the price and/or volume of a price item or mass update the price and/or volume of the price items in the price list. On simulating the price list, the **Price List Simulation Results** screen appears where you view the details of the simulation. The details include:

- List of accounts which would be affected with the change in price
- Original and proposed revenue and the revenue impact due to change in the price

On clicking the **Simulate** button, the system creates the simulation in the **Pending** status. On clicking the **Request Approval** button corresponding to a simulation, the system changes the status of the simulation to **Approved**. The system enables you to extract the effective pricing and simulation results in the Excel format.

Price List Simulation

The **Price List Simulation** screen allows you to search for a price list whose price item pricing you want to simulate using various search criteria. You can create a price list simulation request and also view the simulation details of a price list. This screen contains the following zone:

- [Search Price List](#) on page 534

Search Price List

The **Search Price List** zone allows you to search for a price list using various search criteria. It contains the following sections:

- **Characteristic Filters** - The **Characteristic Filters** section contains the following fields:

Field Name	Field Description	Mandatory (Yes or No)
Entity	Used to indicate whether you want to search for a price list using the entities. The valid value is: <ul style="list-style-type: none"> • Account • Person 	No
Characteristic Type	Used to search price lists defined for entities using a particular characteristic type.	No
Operator	Used to indicate relational operators used to define the relation between the characteristic type and characteristic value. The valid values are: <ul style="list-style-type: none"> • < • <= • = • > • >= • In • Between 	No
Characteristic Value	Used to specify the value of the characteristic type using which you want to search customer registrations of persons.	No

- **Search By Price List, Product, or Price Item** - Used to search a price list using price list, price item or product. This section contains the following fields:

Field Name	Field Description	Mandatory (Yes or No)
Price Item	Used to search a price list associated with a particular price item. <div style="border: 1px solid black; padding: 5px; margin-top: 10px;"> <p>Note:</p> <p>The Search (🔍) icon appears corresponding to this field. On clicking the Search icon, the Price Item Search window appears.</p> </div>	No

Field Name	Field Description	Mandatory (Yes or No)
Product	Used to search price lists assigned to a particular product.	No
	Note: The Search (🔍) icon appears corresponding to this field. On clicking the Search icon, the Price Item Search window appears.	
Price List ID	Used to search a particular price list.	No
Price List Description	Used to search a price list with a particular description.	No

- **Results** - On clicking the **Search** button, the search results appear based on the specified search criteria. The **Results** section contains the following columns:

Column Name	Column Description
Price List ID	Displays the price list ID.
Price List Information	Displays the description of the price list.
Status	Displays the status of the price list. The valid values are: <ul style="list-style-type: none"> • Active • Inactive
Effective Start Date	Displays the date from when the price list is available for assignment to an account or a person.
Effective End Date	Displays the date till when the price list is available for assignment to an account or a person.
Simulation Currency	Used to specify the currency for simulation.
Price List Simulation Request	On clicking the Price List Simulation Request (+) icon in the Price List Simulation Request column, the Price List Simulation Request screen appears where you can modify volume and pricing of the price items to simulate a price list.
	Note: The Price List Simulation Request icon appears when you select the required currency from the Simulation Currency list.
Price List Simulation Results	On clicking the Price List Simulation Results (🔗) icon in the Price List Simulation Results column, the Price List Simulation Results screen appears where you can view the results for all simulated versions for the price lists for a particular entity.

Related Topics

For more information on...	See...
Price List Simulation Request screen	Price List Simulation Request on page 540
Price List Simulation Results screen	Price List Simulation Results on page 544
How to search for a price list	Searching for a Price List on page 536
How to create a request for the price list simulation	Creating a Request for Price List Simulation on page 537

For more information on...	See...
How to view the price list simulation details	Viewing the Price List Simulation Details on page 536

Searching for a Price List

Prerequisites

To search for a price list, you should have:

- Price list simulation entities and their characteristics defined in the application

Procedure

To search for a price list:

1. Click the **Menu** link in the **Application** toolbar.
A list appears.
2. From the **Main** menu, select **Pricing Management** and then click **Price List Simulation**.
The **Price List Simulation** screen appears.
3. Enter the search criteria in the **Search Price List** zone.

Note: ORMB search engine supports wildcard search, where you can substitute the percentage (%) symbol as a stand in for any word or letter in a search criteria. You can use the ‘%’ wildcard character in all input fields except the date and ID fields. The ‘%’ wildcard character is suffixed automatically at the end of the partial search criteria. Therefore, you may or may not specify the wildcard character at the end of the partial search criteria. However, you have to prefix the wildcard character manually wherever required.

4. Click **Search**.

A list of price lists that meet the search criteria appears in the **Results** section.

Related Topics

For more information on...	See...
Price List Simulation screen	Price List Simulation on page 534
Search Price List zone	Search Price List on page 534

Viewing the Price List Simulation Details

Procedure

To view the details of a price list simulation:

1. Search for the price list in the **Price List Simulation** screen.
2. In the **Results** section, click the **Price List Simulation Results**  icon in the **Price List Simulation Results** column corresponding to the price list whose details you want to view.

The **Price List Simulation Results** screen appears. It contains the following zones:

- Price List Simulation View
3. View the basic details of the price list simulation **Price List Simulation View** zone.
 4. View the simulation details for each price item associated with the price list.
 5. View the revenue impact of the simulation for the price list and the price items that are assigned to the price list.

Related Topics

For more information on...	See...
Price List Simulation screen	Price List Simulation on page 534
How to search for a price list	Searching for a Price List on page 536

Creating a Request for Price List Simulation

Prerequisites

To define a mass pricing update request, you should have:

- Mass pricing update request types defined in the application
- A currency conversion algorithm attached to the **Currency Conversion For Bill Segments** algorithm spot of the respective division

Procedure

To define a mass pricing update request:

1. Click the **Menu** link in the **Application** toolbar.
A list appears.
2. From the **Main** menu, select **Pricing Management** and then click **Price List Simulation**.
The **Price List Simulation** screen appears.
3. Do either of the following:

If you want to...	Then...
Create a new simulation request for a price list	<ol style="list-style-type: none"> 1. Search for the required price list which you want to simulate from the Search Price List zone. A list of the price lists matching the search criteria appears in the Results section. 2. Select the simulation currency from the Simulation Currency list corresponding to the price list which you want to simulate. Click the Add (+) icon in the Price List Simulation Request column corresponding to the price list whose details you want to simulate.
Create a new simulation request for an already simulated price list	<ol style="list-style-type: none"> 1. Search for the price list whose simulation details you want to view from the Search Price List zone. A list of price lists matching with the search criteria appears in the Results zone. 2. Click on the Price List Simulation Results  icon in the Price List Simulation Results column corresponding to the price list whose price list simulation details you want to view. The Price List Simulation Results screen appears. 3. View the price list simulation details.

If you want to...	Then...
	<p>4. If you want to further simulate the respective price list then click on the Perform Simulation link in the upper right corner of the Price List Simulation View zone.</p>

The **Price List Simulation Request** screen appears. It contains the following field:

Field Name	Field Description	Mandatory (Yes or No)
Mass Pricing Update Request Type	Used to indicate the mass pricing update request type using which you want to create a mass pricing update request.	Yes

4. Select the required mass pricing update request type from the respective field.
5. Click **OK**.

The **Mass Pricing Update Request** screen appears. It contains the following fields:

Field Name	Field Description	Mandatory (Yes or No)
Request Information	Displays information about the mass pricing update request.	Not applicable
Mass Pricing Update Criteria	Used to indicate whether you want to increase or decrease the rate in the price item pricing or whether you want to forcibly end the price item pricing on the update date. The valid values are: <ul style="list-style-type: none"> • Decrease Price • End Date Price • Increase Price 	Yes
Mass Pricing Update Type	Used to indicate whether you want to increase or decrease the rate by an absolute value or in percentage. The valid values are: <ul style="list-style-type: none"> • Absolute • Percentage 	Yes (Conditional)
	Note: This field appears when the mass pricing update criteria is set to Increase Price or Decrease Price .	Note: This field is required when the mass pricing update criteria is set to Increase Price or Decrease Price .
Rate Value	Used to specify the rate by which you want to increase or decrease the price.	Yes (Conditional)
	Note: This field appears when the mass pricing update criteria is set to Increase Price or Decrease Price . You cannot specify a negative value or zero in the Rate Value field.	Note: This field is required when the mass pricing update criteria is set to Increase Price or Decrease Price .

Field Name	Field Description	Mandatory (Yes or No)
Currency	Used to indicate the currency in which the rate is specified.	Yes (Conditional)
	<p>Note:</p> <p>This field appears when the mass pricing update type is set to Absolute.</p> <p>If the pricing currency is different from the currency which is specified in the mass pricing update request, the system does the currency conversion using the algorithm which is attached to the Currency Conversion For Bill Segments algorithm spot of the respective division.</p>	<p>Note: This field is required when the mass pricing update type is set to Absolute.</p>
Update Date	<p>Displays the date when you want to update the price assignments. The system fetches the price assignments which are effective on the update date. If you want to forcibly end a price item pricing through the mass pricing update request, the end date in the price item pricing is set to the update date. However, if you want to increase or decrease the rate in a price item pricing through the mass pricing update request, the system behaves in the following manner:</p> <ul style="list-style-type: none"> • If a price assignment is referred in past, the existing price assignment is end dated and a new price assignment is created. • If a price assignment is not yet referred in the system, the existing price assignment is updated. <p>Note: You cannot update a price assignment through a mass pricing update request when the start or end date of the price assignment is equal to the update date.</p>	Not applicable

6. Enter the required details in the **Price List Simulation Request** screen.
7. Propose new pricing and/or volume for the price items of the price list.
8. Click **Simulate** to simulate the price list.

Related Topics

For more information on...	See...
Price List Simulation screen	Mass Pricing Update Request on page 2349
Search Price List zone	Search Price Assignments on page 2350
Price List Simulation Request screen	Price List Simulation Request on page 540
Propose Price and Volume zone	Propose Price and Volume on page 540
Price List Simulation Results screen	Price List Simulation Results on page 544

For more information on...	See...
How to simulate a price list	Simulating a Price List on page 541

Price List Simulation Request

The **Price List Simulation Request** screen allows you to propose or modify the volume and/or pricing of the price items in a price list in order to simulate a price list. You can individually or mass update the volume and/or pricing of the price items associated with the price list. Once an update is proposed in the volume and/or pricing of the price item, you can simulate the price list to analyze the results and the overall revenue impact. This screen contains the following zone:

- [Propose Price and Volume](#) on page 540

Propose Price and Volume

The **Propose Price and Volume** zone allows you to propose or modify the volume and/or pricing for the price items associated with a price list/product/price item pricing. You can either increase or decrease the volume and/or pricing of the price items. Once an update is proposed in the volume and/or pricing of the price item, you can simulate the respective price list. It contains the following sections:

- **Filters** - This section contains the following fields:

Field Name	Field Description
Price List ID	Indicates the price list whose details you want to simulate.
Product	Used to search a product with a particular description.
Simulation Period	Used to specify the period which is back calculated from the system date to fetch the validity for the proposed pricing. The valid values are: <ul style="list-style-type: none"> • 1 month • 3 months • 6 months • 12 months • 36 months
	Note: By default, the 12 months option is selected.

- **Simulation Details** - Used to propose or modify the volume and/or pricing for the price items associated with a price list, product, or price item hierarchy. It contains the following columns:

Field Name	Field Description
Description	Used to specify the description of the price list simulation version.
Detailed Description	Used to specify the additional information about the price list simulation.
Simulation Currency	Used to specify the currency in which you want to calculate the simulation results of the price list. <p>Note: If the simulation currency is different from the pricing currency, the system does the currency conversion.</p>
Mass Volume Update	Used to update the mass commitments in percentage which is applicable for the entire price list. You can slide the range slider in the backward or forward direction in order to increase or decrease the volume respectively.

Field Name	Field Description
	Note: You can exclude a price item of the price list, product, or price item hierarchy from the Mass Volume Update by selecting the Exclude checkbox corresponding to the respective price item.
Mass Price Update	Used to update the mass pricing of the price items in percentage which is applicable for the entire price list. You can slide the range slider in the backward or forward direction in order to increase or decrease the pricing respectively. Note: You can exclude a price item of the price list, product, or price item hierarchy from the Mass Price Update by selecting the Exclude checkbox corresponding to the respective price item.
Total Affected Accounts	Displays the total number of affected price items or products associated with a particular account for which you want to perform the simulation.
SQI	Indicates the SQI associated with the price item pricing.
Pricing Information	Displays the concatenated string consisting of the pricing information such as rate component, pricing type and pricing currency which are separated by a comma (,) for the price list. Note: This link appears when you expand the respective price item. It has a link. On clicking the link, the Rate Component Tree screen appears where you can view the pricing structure details of the respective price item.
Actual Volume	Displays the actual commitments of the price item for a particular account.
Actual Average Unit Price	Displays the actual average price charged for each unit of a price item. It is represented by the following formula: $\text{Actual Average Unit Price} = \text{Actual Revenue} / \text{Actual Volume}$
Actual Revenue	Displays the revenue generated through the actual price item pricing and actual volume of a price item.
Proposed Volume	Displays the proposed commitments of the price item for a particular account.
Proposed Average Unit Price	Displays the proposed average price charged for each unit of a price item. $\text{Proposed Average Unit Price} = \text{Proposed Revenue} / \text{Proposed Volume}$
Exclude Simulation	Used to specify whether you want to exclude a price item of a price list, product, or a price item hierarchy from the mass volume and/or pricing update.

Related Topics

For more information on...	See...
Price List Simulation Request screen	Price List Simulation Request on page 540
Price List Simulation Results screen	Price List Simulation Results on page 544
How to simulate a price list	Simulating a Price List on page 541

Simulating a Price List

Prerequisites

To simulate a price list, you should have:

- Account details defined in the application
- Price items of a price list associated with a product
- Price item pricing defined for the respective price list associated with the account
- Bill generated for the account

Procedure

To simulate a price list:

1. Search for the price list in the **Price List Simulation** screen.
2. In the **Results** section, select the required currency from the **Simulation Currency** list corresponding to the price list which you want to simulate..
3. On selecting the currency, the **Price List Simulation Request** (+) icon appears.
4. Click **Price List Simulation Request** icon.

The **Price List Simulation Request** screen appears. It contains the following zone:

- **Propose Price and Volume** - Used to propose or modify the volume and pricing of the price items associated with a price list/product/price item hierarchy. It contains following sections:
- **Filters** - This section contains the following fields:

Field Name	Field Description	Mandatory (Yes or No)
Price List ID	Indicates the price list that is to be simulated.	No
Product	Used to search a product with a particular description.	No
Simulation Period	Used to specify the period which is back calculated from the system date to fetch the validity for the proposed pricing. The valid values are: <ul style="list-style-type: none"> • 1 month • 3 months • 6 months • 12 months • 36 months 	No
	Note: By default, the 12 months option is selected.	

- **Simulation Details** - Used to propose or modify the volume and/or pricing for the price items associated with a price list, product, or price item hierarchy. It contains the following columns:

Field Name	Field Description	Mandatory (Yes or No)
Description	Used to specify description for the price list simulation version.	No

Field Name	Field Description	Mandatory (Yes or No)
Detailed Description	Used to specify additional information about the price list simulation.	No
Simulation Currency	Used to specify the currency in which you want to calculate the simulation results of the price list. Note: <ul style="list-style-type: none"> By default, it displays the currency value selected while requesting a simulation from the Price List Simulation screen. If the simulation currency is different from the currency which is specified in the price list simulation request, the system does the currency conversion. 	No
Mass Volume Update	Used to update the mass commitments in percentage which is applicable for the entire price list. You can slide move the range slider in the backward or forward direction in order to increase or decrease the volume respectively. Note: You can exclude a price item of the price list, product, or price item hierarchy from the Mass Volume Update by selecting the Exclude checkbox corresponding to the respective price item.	No
Mass Price Update	Used to update the mass pricing of the price items in percentage which is applicable for the entire price list. You can move the range slider backward or forward direction in order to increase or decrease the pricing respectively. Note: You can exclude a price item of the price list, product, or price item hierarchy from the Mass Price Update by selecting the Exclude checkbox corresponding to the respective price item.	No
Affected Accounts	Displays the total number of affected price items or products of a particular account for which you want to perform the simulation.	No
SQI	Indicates the SQIs associated with the price item pricing.	No
Pricing Information	Displays the concatenated string consisting of pricing information such as rate component, pricing type and pricing currency which are separated by a comma (,) for the price list. Note: This link appears when you expand the respective price item. It has a link. On clicking the link, the Rate Component Tree screen appears where you can view the pricing structure details of the respective price item.	

Field Name	Field Description	Mandatory (Yes or No)
Actual Volume	Displays the actual commitments of the price item for a particular account.	No
Actual Average Unit Price	Displays the actual average price charged for each unit of a price item. It is represented by the following formula: Actual Average Unit Price = Actual Revenue / Actual Volume	No
Actual Revenue	Displays the revenue generated through the actual price item pricing and actual volume of a price item.	No
Proposed Volume	Displays the proposed commitments of the price item for a particular account.	No
Proposed Average Unit Price	Displays the proposed average price charged for each unit of a price item. Proposed Average Unit Price = Proposed Revenue / Proposed Volume	No
Exclude Simulation	Used to specify whether you want to exclude a price item of a price list, product, or a price item hierarchy from the mass volume and/or pricing update.	No

- Filter the results using the **Filters** section, if required.
- Propose or modify new values for **Mass Volume Update** and/or **Mass Price Update** fields, if required.
- Click **Simulate**.

The **Price List Simulation Results** screen appears where you can analyze the simulation results.

Related Topics

For more information on...	See...
How to search a price list	Searching for a Price List on page 536
How to analyze the price list simulation	Analyzing the Results of a Price List Simulation on page 546
Price List Simulation screen	Price List Simulation on page 534
Price List Simulation Request screen	Price List Simulation Request on page 540
Price List Simulation Results screen	Price List Simulation Results on page 544
Propose Price and Volume zone	Propose Price and Volume on page 540

Price List Simulation Results

The **Price List Simulation Results** screen allows you to view all the simulation results of a price list. You can analyze the simulation results of a price list. You can also request the approval for the price list simulation. The system enables you to extract the effective pricing and simulation results in the Excel format. This screen contains the following zone:

- Price List Simulation List**



Price List Simulation List

The **Price List Simulation List** zone lists all the simulations associated with the price list. You can view the details of all the simulations performed for the associated price list. Also, you can request approval for a particular price list simulation. It allows you to extract the effective pricing and/or simulation results in excel format. This zone contains the following sections:

- **Filters** - The **Filters** section contains the following fields:

Field Name	Field Description
Price List ID	Used to specify the price list for which the simulation is requested.
Product	Used to search a product with a particular description.
Simulation Period	Used to specify the period which is back calculated from the system date to fetch the validity for the proposed pricing. The valid values are: <ul style="list-style-type: none"> • 1 month • 3 months • 6 months • 12 months • 36 months <p>Note: By default, the Simulation Period is set to 12 months option is selected.</p>
View Person and Account Level Details	Used to indicate whether you want to show or hide the person or account details associated with the price list.
Price List Simulation Request	On clicking this link, you can create a new simulation request for the price list whose simulation details you are viewing.
Total Affected Accounts	Displays the total number of affected price items or products of a particular account whose simulation details you are viewing. <p>Note: This field appears when you expand the simulation details which you want to view.</p>
Pricing Information	Displays the price item pricing information associated with a particular account.
Actual Volume	Displays the actual commitments of the price item for a particular account.
Proposed Volume	Displays the proposed commitments of the price item for a particular account
Actual Average Unit Price	Displays the actual average price charged for each unit of a price item. It is represented by the following formula: $\text{Actual Average Unit Price} = \text{Actual Revenue} / \text{Actual Volume}$
Proposed Average Unit Price	Displays the proposed average price charged for each unit of a price item. It is represented by the following formula: $\text{Proposed Average Unit Price} = \text{Proposed Revenue} / \text{Proposed Volume}$
Original Revenue	Displays the revenue generated from the actual price item pricing and actual volume of a price item.
Proposed Revenue	Displays the revenue generated from the proposed price item pricing and proposed volume of a price item..

Field Name	Field Description
Revenue Variation (%)	Displays the average revenue generated from the price item pricing and commitments. It is represented by the following formula: Revenue Variation (%) = (Proposed Revenue – Original Revenue)*100 / Original Revenue
Extract Effective Pricing	Used to extract the effective pricing details in the excel format.
Extract Simulation Results	Used to extract the simulation results in the excel format.
Approve Simulation	On clicking this button, the system updates the status of the corresponding price list simulation as Approved .

Legend	Legend Description
 ORIGINAL	Indicates the original commitments and pricing statistics of a price item.
 PROPOSED	Indicates the proposed commitments and pricing statistics of a price item.

Related Topics

For more information on...	See...
Price List Simulation Request screen	Price List Simulation Request on page 540
Price List Simulation Results screen	Price List Simulation Results on page 544
How to analyze the results of a price list simulation	Analyzing the Results of a Price List Simulation on page 546
How to extract the effective pricing details of a price list simulation	Extracting the Effective Pricing of a Price List Simulation on page 549
How to extract the simulation results of a price list simulation	Extracting the Simulation Results of a Price List Simulation on page 549
How to submit a price list simulation for approval	Submitting a Price List Simulation for Approval on page 548
How to create a price list simulation request	Creating a Request for Price List Simulation on page 537

Analyzing the Results of a Price List Simulation

Procedure

To analyze the results of a price list simulation:

1. Search for the price list in the **Price List Simulation** screen.
2. In the **Results** section, click the **Price List Simulation Request** (+ icon in the **Price List Simulation Request** column corresponding to the price list you want to simulate.
The **Price List Simulation Request** screen appears.
3. Propose new volume and price for the price item of the price list you want to simulate.
4. Click **Simulate**.

Note: Alternatively, you can click on the **Price List Simulation Results** (🔗 icon) in the **Price List Simulation Results** column corresponding to the price list whose simulation results you want to analyze in the price list search results section.



The **Price List Simulation Results** screen appears. It contains the following zone:

- **Price List Simulation List** - Lists all the simulation results associated with a particular price list. It contains the following section:

Filters - The **Filters** section contains the following fields:

Field Name	Field Description
Price List ID	Used to specify the price list for which the simulation is requested.
Product	Used to search a product with a particular description.
Simulation Period	Used to specify the period which is back calculated from the system date to fetch the validity for the proposed pricing. The valid values are: <ul style="list-style-type: none"> • 1 month • 3 months • 6 months • 12 months • 36 months
	Note: By default, the Simulation Period is set to 12 months option is selected.
View Person and Account Level Details	Used to indicate whether you want to show or hide the person or account details associated with the price list.
Price List Simulation Request	On clicking this link, you can create a new simulation request for the price list whose simulation details you are viewing.
Total Affected Accounts	Displays the total number of affected price items or products of a particular account whose simulation details you are viewing.
	Note: This field appears when you expand the simulation details which you want to view.
Pricing Information	Displays the price item pricing information associated with a particular account.
Actual Volume	Displays the actual commitments of the price item for a particular account.
Proposed Volume	Displays the proposed commitments of the price item for a particular account
Actual Average Unit Price	Displays the actual average price charged for each unit of a price item. It is represented by the following formula: $\text{Actual Average Unit Price} = \text{Actual Revenue} / \text{Actual Volume}$
Proposed Average Unit Price	Displays the proposed average price charged for each unit of a price item. It is represented by the following formula: $\text{Proposed Average Unit Price} = \text{Proposed Revenue} / \text{Proposed Volume}$
Original Revenue	Displays the revenue generated from the actual price item pricing and actual volume of a price item.

Field Name	Field Description
Proposed Revenue	Displays the revenue generated from the proposed price item pricing and proposed volume of a price item..
Revenue Variation (%)	Displays the average revenue generated from the price item pricing and commitments. It is represented by the following formula: Revenue Variation (%) = (Proposed Revenue – Original Revenue)*100 / Original Revenue
Extract Effective Pricing	Used to extract the effective pricing details in the excel format.
Extract Simulation Results	Used to extract the simulation results in the excel format.
Approve Simulation	On clicking this button, the system updates the status of the corresponding price list simulation as Approved .

Legend	Legend Description
 ORIGINAL	Indicates the original commitments and pricing statistics of a price item.
 PROPOSED	Indicates the proposed commitments and pricing statistics of a price item.

5. Expand the simulation version that you want to view.
6. Analyze the updated volume and pricing for the price items of the price list.
7. Analyze the percentage variation in the revenue of the price items.

Related Topics

For more information on...	See...
Price List Simulation screen	Price List Simulation on page 534
Price List Simulation Results screen	Price List Simulation Results on page 544
How to search for a price list	Searching for a Price List on page 536
How to simulate a price list	Simulating a Price List on page 541

Submitting a Price List Simulation for Approval

Prerequisites

To submit a price list simulation for approval, you should have:

- Price list simulation available in the pending status

Procedure

To submit a a price list simulation for approval:

1. Search for the price list whose simulation details you want submit for approval in the **Price List Simulation** screen.
2. In the **Results** section, click the **Price List Simulation Result**  icon in the **Price List Simulation Result** column corresponding to the price list whose simulation results you want to submit for an approval.

Note: Alternatively, you can click on the **Price List Simulation Results**  icon in the **Price List Simulation Results** column corresponding to the price list whose simulation results you want to submit for approval.

The **Price List Simulation Result** screen appears.

3. Analyze the details of the price list simulation which you want to submit for approval.
4. Click **Approve Simulation** button corresponding to the price list simulation which you want to submit for approval.

The price list simulation is approved.

Related Topics

For more information on...	See...
How to search for a price list	Searching for a Price List on page 536
Price List Simulation screen	Price List Simulation on page 534
Price List Simulation Results screen	Price List Simulation Results on page 544

Extracting the Effective Pricing of a Price List Simulation

Procedure

To extract the effective pricing of a price list simulation:

1. Search for the price list whose simulation details you want submit for approval in the **Price List Simulation** screen.
2. In the **Results** section, click the **Price List Simulation Result** (🔗) icon in the **Price List Simulation Result** column corresponding to the price list whose simulation results you want to submit for an approval.

The **Price List Simulation Result** screen appears.

3. Click on the **Extract Effective Pricing** link corresponding to the price list simulation whose effective pricing details you want to extract.

The effective pricing details are extracted in the excel format.

Related Topics

For more information on...	See...
How to search for a price list	Searching for a Price List on page 536
Price List Simulation screen	Price List Simulation on page 534
Price List Simulation Results screen	Price List Simulation Results on page 544

Extracting the Simulation Results of a Price List Simulation

Procedure

To extract the effective pricing of a price list simulation:

1. Search for the price list whose simulation details you want submit for approval in the **Price List Simulation** screen.
2. In the **Results** section, click the **Price List Simulation Result** (🔗) icon in the **Price List Simulation Result** column corresponding to the price list whose simulation results you want to submit for an approval.

The **Price List Simulation Result** screen appears.

3. Click on the **Extract Simulation Details** link corresponding to the price list simulation whose simulation details you want to extract.

The price list simulation details are extracted in the excel format.

Related Topics

For more information on...	See...
How to search for a price list	Searching for a Price List on page 536
Price List Simulation screen	Price List Simulation on page 534
Price List Simulation Results screen	Price List Simulation Results on page 544

Pricing (Account)

Note: This topic is not applicable for the health insurance business.

The **Pricing (Account)** screen allows you to:

- View effective price assignments of an account
- View the details of an assigned or inherited price item pricing
- Search and assign price items or price item bundles to an account
- Edit or override a price item pricing
- Copy a price item pricing and assign it to an account

This screen consists of the following zones:

- [Effective Price Assignments for Account](#) on page 550
- [Search Price Item or Price Item Pricing](#) on page 555

Effective Price Assignments for Account

Note: This topic is not applicable for the health insurance business.

The **Effective Price Assignments for Account** zone lists the price item pricing (i.e. price assignments) which are effective on the current date. In other words, it lists effective pricing for price items or price item bundles assigned to the account either directly or through the customer hierarchy. The order in which the price assignments are listed is controlled by the **Price Assignment Search** algorithm defined for the division to which the account belongs. If required, you can filter effective price assignments using various search criteria.

Note: If the effective pricing is available for the price item, regular bundle (to which the price item belongs), and parent (regular) bundle (i.e. to which the regular bundle belongs) at the same level, the system lists the pricing depending on the value defined for the **Prefer Price Item Over Bundle** parameter in the price assignment search algorithm. If the value of the **Prefer Price Item Over Bundle** parameter is set to **Y**, the system lists effective pricing which is available for the price item. If the effective pricing is not available for the price item, then the system lists effective pricing which is available for the regular bundle at the same level. If the effective pricing is not available for the regular bundle, then the system lists effective pricing which is available for the parent bundle at the same level. However, if the value of the **Prefer Price Item Over Bundle** parameter is set to **N**, the system lists effective pricing which is available for the parent bundle. If the effective pricing is not available for the parent bundle, then the system lists effective pricing which is available for the regular bundle at the same level. If the effective pricing is not available for the regular bundle, then the system lists effective pricing which is available for the price item at the same level.

This zone contains the following two sections:

- **Search Criteria** – The **Search Criteria** section contains the following fields:

Field Name	Field Description	Mandatory (Yes or No)
Account ID	Indicates the account whose effective price assignments are listed in this zone.	Not applicable
Effective Pricing Date	Used to search price assignments which are effective on a particular date.	No
	Note: By default, this field is set to the system date.	
Assignment Level	<p>Used to search price assignments at a particular level in the customer hierarchy. The valid values are:</p> <ul style="list-style-type: none"> • Account Agreed – Means price item pricing is agreed for the account. • Account Price List – Means price item pricing is defined in the price list which is assigned to the account. • Account Inherited Price List – Means price item pricing is inherited from the parent price list hierarchy defined for the price list which is assigned to the account. • Customer Agreed – Means price item pricing is agreed for the main customer in the customer hierarchy. • Customer Price List – Means price item pricing is defined in the price list which is assigned to the main customer. • Default Price List – Means price item pricing defined in the price list is available in the default price list. • Global Price List – Means price item pricing defined in the price list is available in the global price list. • Customer Inherited Price List – Means price item pricing is inherited from the parent price list hierarchy defined for the price list which is assigned to the main customer. • Parent Customer Agreed – Means price item pricing is agreed for the parent customer in the customer hierarchy. • Parent Customer Price List – Means price item pricing is defined in the price list which is assigned to the parent customer. • Parent Customer Inherited Price List – Means price item pricing is inherited from the parent price list hierarchy defined for the price list which is assigned to the parent customer. 	No

Field Name	Field Description	Mandatory (Yes or No)
	<ul style="list-style-type: none"> • Product Default Price List – Means product defined in the price list is available in the default price list. 	
Parent Person	Used to search price assignments which are inherited from a particular parent customer.	No
Pricing Status	Used to search price assignments with a particular status. The valid values are: <ul style="list-style-type: none"> • Active • Proposed 	No
	Note: By default, the Active option is selected.	
Show Default and Global Pricing	Used to search price assignments inherited from the default or global price list. The valid values are: <ul style="list-style-type: none"> • Yes – Used when you want to search price assignments inherited from either of the following: <ul style="list-style-type: none"> • Product-specific default price list defined for the division • Default price list defined for the division • Global price list • No – Used when you do not want to search price assignments inherited from either of the following: <ul style="list-style-type: none"> • Product-specific default price list defined for the division • Default price list defined for the division • Global price list 	No
	Note: By default, the No option is selected.	
Price Item	Used to search price assignments of a particular price item or price item bundle.	No
Description	Used to search price assignments of a price item or price item bundle having a particular description.	No
Search Type	Used to search the price list using the following values: <ul style="list-style-type: none"> • Best Fit • Exact Match 	No
	Note: By default, the Exact Match option is selected.	

Note: The **Search** (🔍) icon appears corresponding to the **Price Item** field. On clicking the **Search** icon, you can search for a price item.

- **Price Item Parameters** – The **Price Item Parameters** section contains the following fields:

Field Name	Field Description	Mandatory (Yes or No)
Parameter	Used to search price assignments which are defined using a particular parameter.	No
	Note: This field appears when the Multi Price Parameter option type of the Multi Parameter Based Pricing (C1_PPARM_FLG) feature configuration is set to True .	
Parameter Value	Used to search price assignments which are defined using a particular parameter value.	No
	Note: This field appears when the Multi Price Parameter option type of the Multi Parameter Based Pricing (C1_PPARM_FLG) feature configuration is set to True .	

Note:



The **Search** (🔍) icon appears corresponding to the **Parameter** field. On clicking the **Search** icon, you can search for a parameter.

You can only use those parameters where the source entity is set to **Transaction**.

The **Search** (🔍) icon appears corresponding to the **Parameter Value** field when the value type of the parameter is **Predefined** or **Reference**. If the value type of the parameter is **Predefined** then on clicking the **Search** icon, you can search for a predefined parameter value. However, if the value type of the parameter is **Reference** then on clicking the **Search** icon, you can search for a reference parameter value.

- **Search Results** – On clicking the **Search** button, the search results are filtered based on the specified search criteria. The **Search Results** section contains the following columns:

Column Name	Column Description
Pricing Information	Displays the concatenated string consisting of pricing information and pricing ID for the account.
	Note: It has a link. On clicking the link, the View Price Item Pricing screen appears with the details of the respective price item pricing.
Price Item	Displays the price item or price item bundle code.
Pricing Parameters	Used to specify multiple parameters based on which you want to determine the pricing utilization.
	Note: This column appears only when the Multi Price Parameter option type of the Multi Parameter Based Pricing (C1_PPARM_FLG) feature configuration is set to True .

Column Name	Column Description
Price Assignment Type	<p>Indicates the type of price assignment. The valid values are:</p> <ul style="list-style-type: none"> • Regular • Post Processing • Post Processing – Invoice Based • Post Processing – Price Item Based
Assignment Level	<p>Indicates the level at which the price item pricing is defined in the customer hierarchy. The valid values are:</p> <ul style="list-style-type: none"> • Account Agreed • Account Price List • Account Inherited Price List • Customer Agreed • Customer Price List • Default Price List • Global Price List • Customer Inherited Price List • Parent Customer Agreed • Parent Customer Price List • Parent Customer Inherited Price List • Product Default Price List
Rate Info	<p>Displays the rate of the price item.</p> <div style="border: 1px solid black; padding: 5px; background-color: #f0f0f0;"> <p>Note:</p> <p>If the price assignment has only one price component, you can view the rate defined in the pricing directly through the Rate Info column.</p> <p>However, if the price assignment has more than one price components, then the Rate Info column contains a string indicating the tiering type and pricing currency. It also contains “...” which indicates that for more information about the pricing you should navigate to the Price Item Pricing screen.</p> </div>
Price List Information	Displays the information about the price list which is assigned to the account.
Rate Schedule	Indicates the rate schedule which is used for defining the price item pricing.
Edit	<p>On clicking the Edit () icon, the Price Item Pricing screen appears where you can edit the details of the price item pricing.</p> <div style="border: 1px solid black; padding: 5px; background-color: #f0f0f0;"> <p>Note: The Edit icon appears when the assignment level is Account Agreed.</p> </div>
Override	<p>On clicking the Override () icon, the Price Item Pricing screen appears where you can override the price item pricing.</p>

Column Name	Column Description
	<p>Note:</p> <p>You can override a price item pricing assigned at any level in the customer hierarchy. On overriding a price item pricing, a new price item pricing which is specific to the account is defined at the account level and is then called account agreed pricing.</p> <p>A customer agreed or account agreed price assignments are effective for a particular duration and do not expire until you specify the end date manually. However, if you set the Expire Override Switch option type of the C1_EXP_OVRD feature configuration to Y, the system will automatically expire an agreed pricing when the agreed pricing of a customer or an account without end date is overridden. If you do not want an agreed pricing to automatically expire when it is overridden, you must set the Expire Override Switch option type of the C1_EXP_OVRD feature configuration to N.</p>
Effective Start Date	Displays the date from when the price item pricing is effective.
Effective End Date	Displays the date till when the price item pricing is effective.
Pricing Currency	Indicates the currency in which the price item pricing is defined.
Parent Person	Displays the name of the parent or grandparent customer from whom the price item pricing is inherited.

Note: The number of records that can be displayed in the **Search Results** section is controlled via the **C1_PR_REC** feature configuration. You can change the number of records that can be displayed using the **Effective Pricing RecordSet Limit** option type of the **C1_PR_REC** feature configuration. For more information, refer to [Setting the C1_PR_REC Feature Configuration](#) on page 4341.

Related Topics

For more information on...	See...
How to view effective price assignments of an account	Viewing Effective Price Assignments of an Account on page 560
How to override a price item pricing	Overriding a Price Item Pricing on page 691
How to edit a price item pricing	Editing a Price Item Pricing on page 678
How to filter effective price assignments of an account	Filtering Effective Price Assignments of an Account on page 561

Search Price Item or Price Item Pricing

Note: This topic is not applicable for the health insurance business.

You can either assign a price item to a price list and then define pricing for the price item, or you can copy an existing price item pricing and assign it to a price list. The **Search Price Item** zone allows you to search for a price item pricing which is assigned to an account, person, or a price list. You can then create a new price item pricing using an existing price item pricing through copying the price item pricing. Once you create a copy of an existing price item pricing, the new price item pricing is assigned to the price list. On copying a price item pricing, the pricing details including the price components, eligibility and tiering criteria for each price component, and characteristics are copied to the new price item pricing. You can then edit the details, if required.

The system allows you to create a copy of active, proposed, inactive, rejected, and template price item pricing. Once you create the copy of a template price item pricing, you can save the new price item pricing in either **Active** or **Proposed** status.

The **Search Price Item** zone contains the following two sections:

- **Search Criteria** – The **Search Criteria** section contains the following fields:

Field Name	Field Description	Mandatory (Yes or No)
Search By	Used to search whether you want to search price item pricing for a price item, account, person, or a price list. The valid values are: <ul style="list-style-type: none"> • Price Item • Price List Pricing • Account Override Pricing • Person Override Pricing 	Yes
Price Item	Used to search pricing for a particular price item or price item bundle.	No
Description	Used to search price items or price item bundles with a particular description.	No
	Note: This field appears when you select the Price Item option from the Search By list.	
Global Price List	Used to search price items or price item bundles which can be assigned to a global price list. The valid values are: <ul style="list-style-type: none"> • Yes • No 	No
	Note: This field appears when you select the Price Item option from the Search By list.	
Bundle	Used to search whether the price item is a bundle or not. The valid values are: <ul style="list-style-type: none"> • Yes • No 	No
	Note: This field appears when you select the Price Item option from the Search By list.	
Price List ID	Used to search the price list to which the price item pricing is assigned.	No
	Note: This field appears when you select the Price List Pricing option from the Search By list.	
Effective Start Date	Used to search price item pricing on price lists which are effective from a particular date onwards.	No

Field Name	Field Description	Mandatory (Yes or No)
	Note: This field appears when you select the Price List Pricing, Account Override Pricing, or Person Override Pricing option from the Search By list.	
Effective End Date	Used to search price item pricing on price lists which are effective till a particular date. Note: This field appears when you select the Price List Pricing, Account Override Pricing, or Person Override Pricing option from the Search By list.	No
Pricing Status	Used to search price item pricing with a particular status. The valid values are: <ul style="list-style-type: none"> • Active • Inactive • Proposed • Rejected • Template Note: This field appears when you select the Price List Pricing, Account Override Pricing, or Person Override Pricing option from the Search By list.	No
Price Assignment Type	Used to search a particular type of the price item pricing. The valid values are: <ul style="list-style-type: none"> • Regular • Post Processing • Post Processing – Invoice Based • Post Processing – Price Item Based Note: This field appears when you select the Price List Pricing, Account Override Pricing, or Person Override Pricing option from the Search By list.	No
Account ID	Used to search pricing of price items which are assigned to a particular account. Note: This field appears when you select the Account Override Pricing option from the Search By list.	No
Person ID	Used to search pricing of price items which are assigned to a particular person. Note: This field appears when you select the Person Override Pricing option from the Search By list.	No

Note:

You must specify at least one search criterion while searching for a price item or price item bundle.

The **Search** (🔍) icon appears corresponding to the **Price List ID**, **Price Item**, **Account ID**, and **Person ID** fields. On clicking the **Search** icon, you can search for a price list, price item, an account, and person.

- **Search Results** – On clicking the **Search** button, the search results appear based on the specified search criteria. The search results include only those price items or price item bundles that are associated with the division to which the account belongs. It may also include price items or price item bundles that are already assigned to the account in case those price items or price item bundles match the search criteria.

The **Search Results** section contains the following columns:

Column Name	Column Description
Assign	<p>On clicking the Assign (📌) icon, the Price Item Pricing screen appears where you can define a new price item pricing.</p> <p>Note: This column appears when you select the Price Item option from the Search By list.</p>
Price Item Information	<p>Displays details of the price item or price item bundle.</p> <p>Note: It has a link. On clicking the link, the Price Item screen appears where you can view the details of the respective price item or price item bundle. This column appears when you select the Price Item option from the Search By list.</p>
Copy	<p>On clicking the Copy (📄) icon, the Price Item Pricing screen appears where you can define a new price item pricing using an existing price item pricing.</p>
Pricing Information	<p>Displays details of the price item pricing.</p> <p>Note: This column appears when you select the Price List Pricing, Account Override Pricing, or Person Override Pricing option from the Search By list.</p>
Account Information	<p>Indicates the account to which the price item pricing is assigned. In addition, this column has a context menu which helps in navigating to other screens in the application.</p> <p>Note: This column appears when you select the Account Override Pricing option from the Search By list. It has a link. On clicking the link, the Account screen appears where you can view the details of the respective account. The account information string appears when an algorithm defined using the C1-AC-INFO algorithm type is attached to the Account Information system event in the Algorithms tab of the Installation Options – Framework screen.</p>

Column Name	Column Description
Person Information	<p>Indicates the person to which the price item pricing is assigned. In addition, this column has a context menu which helps in navigating to other screens in the application.</p> <p>Note:</p> <p>This column appears only when you select the Person Override Pricing option from the Search By list.</p> <p>It has a link. On clicking the link, the Person screen appears where you can view the details of the respective person.</p> <p>The person information string appears when an algorithm defined using the PERS-INFO algorithm type is attached to the Person Information system event in the Algorithms tab of the Installation Options – Framework screen.</p>
Price List Information	<p>Indicates the price list to which the price item pricing is assigned. In addition, this column has a context menu which helps in navigating to other screens in the application.</p> <p>Note:</p> <p>This column appears when you select the Price List Pricing option from the Search By list.</p> <p>It has a link. On clicking the link, the Price List screen appears where you can view the details of the respective price list.</p>
Pricing Parameters	<p>Displays a comma-separated list of parameter values. The order in which parameter values appear in this column is controlled by the display order (which is defined while associating a parameter with a price item or price item bundle).</p> <p>Note: This column appears when the Multi Price Parameter option type of the Multi Parameter Based Pricing (C1_PPARM_FLG) feature configuration is set to False.</p>
Effective Start Date	<p>Displays the date from when the price item pricing is effective.</p> <p>Note: This column appears when you select the Price List Pricing, Account Override Pricing, or Person Override Pricing option from the Search By list.</p>
Effective End Date	<p>Displays the date till when the price item pricing is effective.</p> <p>Note: This column appears when you select the Price List Pricing, Account Override Pricing, or Person Override Pricing option from the Search By list.</p>
Pricing Currency	<p>Indicates the currency in which the price item pricing is defined.</p> <p>Note: This column appears when you select the Price List Pricing, Account Override Pricing, or Person Override Pricing option from the Search By list.</p>
Rate Schedule	<p>Indicates the rate schedule which is used for defining the price item pricing.</p>

Column Name	Column Description
	<p>Note:</p> <p>It has a link. On clicking the link Rate Schedule screen appears.</p> <p>This column appears when you select the Price List Pricing, Account Override Pricing, or Person Override Pricing option from the Search By list.</p>
Price Usage Assignment	<p>Indicates whether the price item pricing is applicable to all customers or only to new customers. The valid values are:</p> <ul style="list-style-type: none"> • All Customers • New Customers <p>Note: This column appears when you select the Price List Pricing, Account Override Pricing, or Person Override Pricing option from the Search By list.</p>
Price Assignment Type	<p>Indicates the type of the price item pricing. The valid values are:</p> <ul style="list-style-type: none"> • Regular • Post Processing • Post Processing – Invoice Based • Post Processing – Price Item Based <p>Note: This column appears when the Multi Price Parameter option type of the Multi Parameter Based Pricing (C1_PPARM_FLG) feature configuration is set to False.</p>

Related Topics

For more information on...	See...
How to assign a price item or price item bundle to an account	Assigning a Price Item to an Account on page 575
How to copy a price item pricing	Copying a Price Item Pricing on page 565

Viewing Effective Price Assignments of an Account

Note: This topic is not applicable for the health insurance business.

Prerequisites

To view effective price assignments of an account, you should have:

- Price items or price item bundles assigned to the account either directly or through the customer hierarchy

Procedure

To view effective price assignments of an account:

1. Search for the account in the **Customer 360° View** screen.
2. In the **Search Results** section, click the **Show Context Menu** () icon corresponding to the account whose details you want to view.

A menu appears.

3. Click the **Go To Effective Pricing** menu option.

The **Pricing (Account)** screen appears.

4. View the pricing for price items or price item bundles assigned to the account (either directly or through the customer hierarchy) in the **Effective Price Assignments for Account** zone.
5. Filter the effective price assignments of the account, if required.

Related Topics

For more information on...	See...
How to search for an account	Searching for an Account on page 204
Pricing (Account) screen	Pricing (Account) on page 550
Effective Price Assignments for Account zone	Effective Price Assignments for Account on page 550
How to filter effective price assignments of an account	Filtering Effective Price Assignments of an Account on page 561

Filtering Effective Price Assignments of an Account

Note: This topic is not applicable for the health insurance business.

Prerequisites

To filter effective price assignments of an account, you should have:

- Price items or price item bundles defined in the application
- Parameters defined in the application (where the source entity is set to **Transaction**)
- Price items or price item bundles assigned to the account either directly or through the customer hierarchy

Procedure

To filter effective price assignments of an account:

1. Search for the account in the **Customer 360° View** screen.
2. In the **Search Results** section, click the **Show Context Menu** () icon corresponding to the account whose details you want to view.
A menu appears.
3. Click the **Go To Effective Pricing** menu option.
The **Pricing (Account)** screen appears.
4. Enter the search criteria in the **Effective Price Assignments for Account** zone.

Note:

You can search for a price item, parameter, or parameter value by clicking the **Search** (🔍) icon corresponding to the respective field.

If you want to add more than one parameter in the search criteria, click the **Add** (+) icon and then enter the parameter name and its value. However, if you want to remove a parameter from the search criteria, click the **Delete** (🗑️) icon corresponding to the parameter.

You can only use those parameters where the source entity is set to **Transaction**.

ORMB search engine supports wildcard search, where you can substitute the percentage (%) symbol as a stand in for any word or letter in a search criteria. You can use the ‘%’ wildcard character in all input fields except the date and ID fields. The ‘%’ wildcard character is suffixed automatically at the end of the partial search criteria. Therefore, you may or may not specify the wildcard character at the end of the partial search criteria. However, you have to prefix the wildcard character manually wherever required.

5. Click Search.

A list of price assignments which are effective on the specified date and that meet the search criteria are listed in the **Effective Price Assignments for Account** zone.

Related Topics

For more information on...	See...
How to search for an account	Searching for an Account on page 204
Pricing (Account) screen	Pricing (Account) on page 550
Effective Price Assignments for Account zone	Effective Price Assignments for Account on page 550

Exporting Effective Price Assignments of an Account

Note: This topic is not applicable for the health insurance business.

Prerequisites

To export effective price assignments of an account in the CSV format, you should have:

- Price items or price item bundles assigned to the account either directly or through the customer hierarchy

Procedure

To export effective price assignments of an account in the CSV format:

1. Search for the account in the **Customer 360° View** screen.
2. In the **Search Results** section, click the **Show Context Menu** (▼) icon corresponding to the account whose details you want to view.

A menu appears.

3. Click the **Go To Effective Pricing** menu option.

The **Pricing (Account)** screen appears.

4. Filter the effective price assignments of the account, if required.
5. Click the **Export to Excel** link in the **Effective Price Assignment** zone.

A message appears confirming whether you want to open or save the EffectivePricing.csv file.

6. Select the **Save As** option from the **Save** list.

The **Save As** dialog box appears.

7. Browse to the location where you want to save the file.
8. Enter the file name in the respective field, and click **Save**.

The search results are exported in the CSV format.

9. Open the CSV file in Microsoft Excel.

The sheet contains the following columns:

Column Name	Column Description
Price Item	Displays the price item or price item bundle code.
Description	Displays the description of the price item or price item bundle.
Variance	Indicates the variance parameter which is used for defining the price item pricing. Note: This column appears when the Multi Price Parameter option type of the Multi Parameter Based Pricing (C1_PPARM_FLG) feature configuration is set to False .
Price Item Parameters	Displays a comma-separated list of parameter values. The order in which parameter values appear in this column is controlled by the display order (which is defined while associating a parameter with a price item). A tool tip appears when you hover over this column corresponding to the price item. It indicates the price item parameters and their values which are used for defining the price item pricing. Note: This column appears when the Multi Price Parameter option type of the Multi Parameter Based Pricing (C1_PPARM_FLG) feature configuration is set to True .
Price Assignment Type	Indicates the type of price assignment. The valid values are: <ul style="list-style-type: none"> • Regular • Post Processing • Post Processing — Invoice Based • Post Processing — Price Item Based
Assignment Level	Indicates the level at which the price item pricing is defined in the customer hierarchy. The valid values are: <ul style="list-style-type: none"> • Account Agreed • Account Price List • Account Inherited Price List • Customer Agreed • Customer Price List • Customer Inherited Price List • Parent Customer Agreed • Parent Customer Price List • Parent Customer Inherited Price List
Price List Description	Displays the description of the price list.

Column Name	Column Description
	Note: The description appears when the assignment level is Account Price List, Account Inherited Price List, Customer Price List, Customer Inherited Price List, Parent Customer Price List, or Parent Customer Inherited Price List.
Rate Description	Displays the description of the rate schedule which is used for defining the price item pricing.
Rate Component Information	Displays a comma-separated string which consists of the following: <ul style="list-style-type: none"> • Rate Component Sequence • Tiering Setup of the Rate Component
Price Component Sequence	Indicates the sequence number of the price component.
Price Component Description	Displays the description of the price component.
Rate	Indicates the rate defined for the price component.
Effective Start Date	Displays the date from when the price item pricing is effective.
Effective End Date	Displays the date till when the price item pricing is effective.
Pricing Currency	Indicates the currency in which the price item pricing is defined.
From	Displays the lower limit of the tiering range.
To	Displays the upper limit of the tiering range.
Price Assignment Usage	Indicates whether the price item pricing is applicable to all customers or only to the new customers. The valid values are: <ul style="list-style-type: none"> • AC • NC
Price Assignment ID	Displays the price assignment ID.
Parent Level	Indicates the numerical level of the parent in the customer hierarchy from whom the price item pricing is inherited.
Price List ID	Indicates the price list from where the price item pricing is inherited.
Price List Start Date	Displays the date from when the price list is effective.
Parent Person	Displays the name of the parent or grandparent customer from whom the price item pricing is inherited.
Parent Pricelist Level	Indicates the parent level when price item pricing is inherited from the price list hierarchy. If the pricing is inherited from the assigned price list, the parent price list level will be 0. However, if the pricing is inherited from the parent price list in the hierarchy, the parent price list level will be 1. And, if the pricing is inherited from the grandparent price list in the hierarchy, the parent price list level will be 2, and so on.
Ignore Transaction	Indicates whether the transactions mapped to the price item is considered for billing. The valid values are: <ul style="list-style-type: none"> • Y • N

Column Name	Column Description
Aggregate Transaction	Indicates whether the transactions mapped to the price item is aggregated for billing. The valid values are: <ul style="list-style-type: none"> • Y • N
Aggregation Schedule	Indicates the transaction aggregation cycle. The valid values are: <ul style="list-style-type: none"> • Daily • Weekly • Monthly • Quarterly • Yearly
Tiering Criterion	Indicates the tiering criterion which is used in the tiering range.
Tiering Price Item	Indicates whether the price item is billed individually or at the price item bundle level.

Related Topics

For more information on...	See...
How to search for an account	Searching for an Account on page 204
Pricing (Account) screen	Pricing (Account) on page 550
Effective Price Assignment zone	Effective Price Assignments for Account on page 550

Copying a Price Item Pricing

Note: This topic is not applicable for the health insurance business.

Prerequisites

To copy a price item pricing and assign it to an account, you should have:

- Account (to which you want to assign the price item pricing) defined in the application
- Account associated with the division to which the user belongs
- Price item pricing (whose copy you want to create) defined in the application

Procedure

To copy a price item pricing and assign it to an account:

1. Search for the account in the **Customer 360° View** screen.
2. In the **Search Results** section, click the **Show Context Menu** () icon corresponding to the account whose details you want to view.
A menu appears.
3. Click the **Go To Effective Pricing** menu option.
The **Pricing (Account)** screen appears.

4. In the **Search Price Item** zone, select the required option from the **Search By** list to indicate whether you want to search price item pricing assigned to an account, person, or a price list.

The fields in the **Search Criteria** section change depending on the option that you select from the **Search By** list.

5. Enter the search criteria in the **Search Price Item** zone to search for the price item pricing whose copy you want to create and assign it to the account.
6. Click **Search**.

A list of price assignments that meet the search criteria appears in the **Search Results** section.

7. In the **Search Results** section, click the **Copy** (📄) icon in the **Copy** column corresponding to the price item pricing whose copy you want to create.

The **Price Item Pricing** screen appears.

8. Modify the required pricing details.

Note:

If you change the effective start and end dates while copying a price item pricing, you need to specify the parameters which are effective during that date range.

While copying a price item pricing, you can not only edit the existing tiering combination details, but can also add additional tiering combinations until the maximum tiering combinations limit is met.

If you are creating a copy of active, proposed, inactive, rejected, or template price item pricing, you can save the new price item pricing in the **Active** or **Proposed** status.

9. Edit the characteristics of the price item pricing, if required.

10. Click **Save**.

A new price item pricing is defined and assigned to the account.

Related Topics

For more information on...	See...
How to search for an account	Searching for an Account on page 204
Pricing (Account) screen	Pricing (Account) on page 550
Search Price Item zone	Search Price Item or Price Item Pricing on page 555
How to edit a price item pricing of an account	Editing a Price Item Pricing of an Account on page 568
How to define a characteristic for a price item pricing	Defining a Characteristic for a Price Item Pricing on page 492

Viewing a Price Item Pricing

Note: This topic is not applicable for the health insurance business.

Procedure

To view a price item pricing and assignment details:

1. Search for the account in the **Customer 360° View** screen.
2. In the **Search Results** section, click the **Show Context Menu** (▼) icon corresponding to the account whose details you want to view.

A menu appears.

- Click the **Go To Effective Pricing** menu option.

The **Pricing (Account)** screen appears.

- Price assignments effective for the account appears in the **Effective Price Assignments for Account** zone.
- In the **Search Results** section, click the link in the **Pricing Information** column corresponding to the price item whose pricing details you want to view.

The **Price Item Pricing** screen appears. It contains the following zones:

- Price Item Pricing** – Displays the price item pricing details. It contains the following sections:
 - Pricing Information** – Displays the pricing information of the price item.
 - TFM Information** – Displays the transaction feed management information of the price item.
 - Characteristics** – Displays the details of price item pricing characteristics.
 - Price Item and Parameter Information** – Displays the price item parameter details.
 - Record Actions** – Displays the record actions of the price item pricing.
 - Record Information** – Displays the record information of the price item pricing.
- Rate and Price Component Summary** – Displays the rate and price component summary of the price item.
- Rate Components** – Displays the rate components of the price item.
- Price Components** – Displays the details of price components of the price item.
- Tiering Criteria** – Displays the tiering criteria of the price item pricing.

Note: This zone appears only when **Tiering Type** for the rate component is **STEP** or **Threshold**

- Pricing Eligibility Criteria** – Displays the pricing eligibility criteria of the price item pricing.

Note: This zone appears when eligibility checkbox is selected in the **Price Item Pricing** screen and details for pricing eligibility criteria is added in the **Price Component** screen.

- View the basic details of price item pricing in the **Price Item Pricing** zone.
- View the rate and price component summary of price item in the **Rate and Price Component Summary** zone.
- View the rate components of price item in the **Rate Components** zone.
- View the details of price components of price item in the **Price Components** zone.
- View the tiering criteria of price item pricing in the **Tiering Criteria** zone.
- View the pricing eligibility criteria of price item pricing in the **Pricing Eligibility Criteria** zone.

Related Topics

For more information on...	See...
How to search for an account	Searching for an Account on page 204
Pricing (Account) screen	Pricing (Account) on page 550
Effective Price Assignments for Account zone	Effective Price Assignments for Account on page 550
Price Item Pricing screen	Price Item Pricing (Used for Viewing) on page 614
Price Item Pricing zone	Price Item Pricing on page 616
Price Assignment Tree zone	Price Assignment Tree on page 448
Price Components zone	Price Component on page 622

Editing a Price Item Pricing of an Account

Note: This topic is not applicable for the health insurance business.

Prerequisites

To edit a price item pricing of an account, you should have:

- Transactions mapped to the price item defined in the application
- Rate schedules, rate versions, rate components defined in the application
- Parameters associated with the price item (in case you want to define price item pricing based on those parameters)

Procedure

To edit a price item pricing of an account:

1. Search for the account in the **Customer 360° View** screen.
2. In the **Search Results** section, click the **Show Context Menu** () icon corresponding to the account whose details you want to view.

A menu appears.

3. Click the **Go To Effective Pricing** menu option.

The **Pricing (Account)** screen appears.

4. Price assignments effective for the account appears in the **Effective Price Assignments for Account** zone.

5. In the **Search Results** section, click the **Edit** () icon in the **Edit** column corresponding to the price item pricing whose details you want to edit.

The **Price Item Pricing** screen appears. It contains the following sections:

- **Main** – Used to specify basic details about the price item pricing.
- **TFM Information** – Used to specify the transaction feed management information about the price item pricing.

Note: This section appears in the **Price Item Pricing** screen when the value for the **Show Default Values in Price Item Pricing** option type for **C1_FM** feature configuration is set to **Y** and **Price Item Available For** is **Pricing and Billing**.

- **Characteristics** – Used to define the characteristics for the price item pricing.
- **Price Item and Parameter Information** – Used to define the parameter details segment for the price item pricing.

Note: This section appears when **Price Assignment Type** is **Regular**.

The **Main** section contains the following fields:

Field Name	Field Description	Mandatory (Yes or No)
Start Date	Used to specify the date from when the price item pricing is effective.	Yes

Field Name	Field Description	Mandatory (Yes or No)
	<p>Note:</p> <p>The effective start date cannot be later than the effective end date.</p> <p>If you change the effective start and end dates while editing a price item pricing, you need to specify the parameters which are effective during that date range.</p> <p>This field will be in read-only mode when the price assignment has been used.</p>	
End Date	<p>Used to specify the date till when the price item pricing is effective.</p> <p>Note: The effective end date cannot be earlier than the effective start date.</p>	No
Price Assignment Type	<p>Used to indicate the type of price assignment. The valid values are:</p> <ul style="list-style-type: none"> • Regular – Used to indicate that the pricing must be used to generate regular bill segment. • Post Processing – Used to indicate that the pricing must be used to generate post processing bill segment. This type of price assignment can be done on usage accounts. The post processing bill segment is generated when you generate the bill for the usage account and not when you bill the usage account through an invoice account. <p>Note:</p> <p>The post processing bill segment is generated when the Post Processing Sequence (PPSEQ) characteristic is defined for the price item and when the price item is associated with another price item using the Price Item relationship type.</p> <ul style="list-style-type: none"> • Post Processing – Invoice Based – Used to indicate that the pricing must be used to generate post processing bill segment. This type of price assignment can be done on an invoice account, and, as a result, the post processing bill segment is generated on the invoice account. <p>Note: This will not be applicable for price item which are defined for Only Pricing.</p> <ul style="list-style-type: none"> • Post Processing – Price Item Based – Used to indicate that the pricing must be used to 	Yes

Field Name	Field Description	Mandatory (Yes or No)
	<p>generate post processing bill segment. This type of price assignment can be done on both invoice and usage accounts, but the post processing bill segment is generated only on the invoice account.</p> <p>Note: This will not be applicable for price item which are defined for Only Pricing.</p>	
Pricing Eligibility	<p>Used to select pricing eligibility criteria for price item pricing.</p> <p>Note: This field will be enabled for selection if the checkbox is not selected. If the checkbox appears selected then this field will be in read-only mode.</p>	No
Pricing Status	<p>Used to indicate the status of the price assignment. The valid values are:</p> <ul style="list-style-type: none"> • Draft – Indicates that the price assignment is created as a draft. • Active – Indicates that the price assignment is used for billing. • Inactive – Indicates that the price assignment is no longer used for billing. • Proposed – Indicates that the price assignment is used for quotations. <p>Note: If a price assignment is in Active status, you can change its status to Inactive. If a price assignment is in Draft status, you cannot change its status to Proposed.</p>	Yes
Pricing Currency	Used to indicate the currency in which you want to define the price item pricing.	Yes
Rate Schedule	<p>Used to specify the rate schedule that you want to use while defining price item pricing.</p> <p>Note: Rate schedules control how the bills for the price item will be calculated.</p> <p>The Search (🔍) icon appears corresponding to this field. On clicking the Search icon, the Rate Schedule Search screen appears.</p>	Yes
Pricing Rule Type	<p>Used to indicate the pricing rule type. The valid value is:</p> <ul style="list-style-type: none"> • Two-Dimensional 	Yes (Conditional)

Field Name	Field Description	Mandatory (Yes or No)
		Note: This field is required when you are editing a two-dimensional pricing rule.
Print Zero	Used to indicate whether zero pricing should be displayed in the bill. The valid values are: <ul style="list-style-type: none"> • Yes • No Note: By default, Yes is selected.	Yes
Pricing Frequency	Used to indicate pricing frequency for the price item. Note: This field appears when Price Item is defined as Only Pricing and Price Item Type is defined as Fees .	Yes

6. Modify the details in the **Main** section, if required.
7. Edit the TFM Information in a price item pricing, if required.
8. Edit the characteristics for a price item pricing, if required.
9. Edit the parameters for a price item pricing, if required.
10. Click **Save**.

The changes made to the price item pricing are saved.

Related Topics

For more information on...	See...
How to search for an account	Searching for an Account on page 204
Pricing (Account) screen	Pricing (Account) on page 550
Effective Price Assignments for Account zone	Effective Price Assignments for Account on page 550
How to define a price item pricing.	Defining a Price Item Pricing on page 626
How to define a characteristic for a price item pricing.	Defining a Characteristic for a Price Item Pricing on page 492
How to define parameters for a price item pricing.	Defining a Parameter for a Price Item Pricing on page 579
How to define TFM Information in a price item pricing.	Defining TFM Information in a Price Item Pricing on page 491

Overriding a Price Item Pricing of an Account

Note: This topic is not applicable for the health insurance business.

Prerequisites

To override a price item pricing of an account, you should have:

- Transactions mapped to the price item defined in the application

- Rate schedules, rate versions, rate components defined in the application
- Parameters associated with the price item (in case you want to define price item pricing based on multiple parameters)

Procedure

To override a price item pricing of an account:

1. Search for the account in the **Customer 360° View** screen.
2. In the **Search Results** section, click the **Show Context Menu** () icon corresponding to the account whose details you want to view.

A menu appears.

3. Click the **Go To Effective Pricing** menu option.

The **Pricing (Account)** screen appears.

4. Price assignments effective for the account appears in the **Effective Price Assignments for Account** zone.

5. In the **Search Results** section, click the **Override** () icon in the **Override** column corresponding to the price item pricing whose details you want to override.

The **Price Item Pricing** screen appears. It contains the following sections:

- **Main** – Used to specify basic details about the price item pricing.
- **TFM Information** – Used to specify the transaction feed management information about the price item pricing.

Note: This section appears in the **Price Item Pricing** screen when the value for the **Show Default Values in Price Item Pricing** option type for **C1_FM** feature configuration is set to **Y** and **Price Item Available For** is **Pricing and Billing**.

- **Characteristics** – Used to define the characteristics for the price item pricing.
- **Price Item and Parameter Information** – Used to define the parameter details segment for the price item pricing.

Note: This section appears when **Price Assignment Type** is **Regular**.

The **Main** section contains the following fields:

Field Name	Field Description	Mandatory (Yes or No)
Start Date	Used to specify the date from when the price item pricing is effective. Note: The effective start date cannot be later than the effective end date. If you change the effective start and end dates while overriding a price item pricing, you need to specify the parameters which are effective during that date range. This field will be in read-only mode when the price assignment has been used.	Yes
End Date	Used to specify the date till when the price item pricing is effective.	No

Field Name	Field Description	Mandatory (Yes or No)
	<p>Note: The effective end date cannot be earlier than the effective start date.</p>	
Price Assignment Type	<p>Used to indicate the type of price assignment. The valid values are:</p> <ul style="list-style-type: none"> • Regular – Used to indicate that the pricing must be used to generate regular bill segment. • Post Processing – Used to indicate that the pricing must be used to generate post processing bill segment. This type of price assignment can be done on usage accounts. The post processing bill segment is generated when you generate the bill for the usage account and not when you bill the usage account through an invoice account. <p>Note: The post processing bill segment is generated when the Post Processing Sequence (PPSEQ) characteristic is defined for the price item and when the price item is associated with another price item using the Price Item relationship type.</p> <ul style="list-style-type: none"> • Post Processing – Invoice Based – Used to indicate that the pricing must be used to generate post processing bill segment. This type of price assignment can be done on an invoice account, and, as a result, the post processing bill segment is generated on the invoice account. <p>Note: This will not be applicable for price item which are defined for Only Pricing.</p> <ul style="list-style-type: none"> • Post Processing – Price Item Based – Used to indicate that the pricing must be used to generate post processing bill segment. This type of price assignment can be done on both invoice and usage accounts, but the post processing bill segment is generated only on the invoice account. <p>Note: This will not be applicable for price item which are defined for Only Pricing.</p>	Yes
Pricing Eligibility	<p>Used to select pricing eligibility criteria for price item pricing.</p> <p>Note: This field will be in enabled for selection if the checkbox is not selected. If the checkbox appears selected then this field will be in read-only mode.</p>	No
Pricing Status	Used to indicate the status of the price assignment. The valid values are:	Yes

Field Name	Field Description	Mandatory (Yes or No)
	<ul style="list-style-type: none"> Draft – Indicates that the price assignment is created as a draft. Proposed – Indicates that the price assignment is used for quotations. <p>Note: If a price assignment is in Draft status, you cannot change its status to Proposed.</p>	
Pricing Currency	Used to indicate the currency in which you want to override the price item pricing.	Yes
Rate Schedule	Used to specify the rate schedule that you want to use while defining price item pricing.	Yes
	<p>Note: Rate schedules control how the bills for the price item will be calculated.</p> <p>The Search (🔍) icon appears corresponding to this field. On clicking the Search icon, the Rate Schedule Search screen appears.</p>	
Pricing Rule Type	Used to indicate the pricing rule type. The valid value is: <ul style="list-style-type: none"> Two-Dimensional 	Yes (Conditional)
		Note: This field is required when you are overriding a two-dimensional pricing rule.
Print Zero	Used to indicate whether zero pricing should be displayed in the bill. The valid values are: <ul style="list-style-type: none"> Yes No <p>Note: By default, Yes is selected.</p>	Yes
Pricing Frequency	Used to indicate pricing frequency for the price item.	Yes
	Note: This field appears when Price Item is defined as Only Pricing and Price Item Type is defined as Fees .	

6. Modify the details in the **Main** section, if required.
7. Modify the TFM Information in a price item pricing, if required.
8. Modify the characteristics for a price item pricing, if required.
9. Modify the parameters for a price item pricing, if required.

Note: If you change the effective end date while overriding a price item pricing, you need to specify the parameters which are effective during the date range of start and end date.

10. Click **Save**.

The price item pricing is overridden.

Related Topics

For more information on...	See...
How to search for an account	Searching for an Account on page 204
Pricing (Account) screen	Pricing (Account) on page 550
Effective Price Assignments for Account zone	Effective Price Assignments for Account on page 550
How to define a price item pricing.	Defining a Price Item Pricing on page 626
How to define a characteristic for a price item pricing.	Defining a Characteristic for a Price Item Pricing on page 492
How to define parameters for a price item pricing.	Defining a Parameter for a Price Item Pricing on page 579
How to define TFM Information in a price item pricing.	Defining TFM Information in a Price Item Pricing on page 491

Assigning a Price Item to an Account

Note: This topic is not applicable for the health insurance business.



Prerequisites

To assign a price item to an account, you should have:

- Transactions mapped to the price item defined in the application
- Rate schedules, rate versions, and rate components defined in the application
- Parameters associated with the price item (in case you want to define price item pricing based on multiple parameters)

Procedure

To assign a price item to an account:

1. Search for the account in the **Customer 360° View** screen.
2. In the **Search Results** section, click the **Show Context Menu** () icon corresponding to the account whose details you want to view.
A menu appears.
3. Click the **Go To Effective Pricing** menu option.
The **Pricing (Account)** screen appears.
4. Search for the price item that you want to assign to the account in the **Search Price Item or Price Item Pricing** zone.
5. In the **Search Results** section, click the **Assign** () icon in the **Assign** column corresponding to the price item that you want to assign to the account.

The **Price Item Pricing** screen appears. It contains the following sections:

- **Main** – Used to specify basic details about the price item pricing.
- **TFM Information** – Used to specify the transaction feed management information about the price item pricing.

Note: This section appears in the **Price Item Pricing** screen when the value for the **Show Default Values in Price Item Pricing** option type for **C1_FM** feature configuration is set to **Y** and **Price Item Available For** is **Pricing and Billing**.

- **Characteristics** – Used to define the characteristics for the price item pricing.
- **Price Item and Parameter Information** – Used to define the parameter details segment for the price item pricing.

Note: This section appears when **Price Assignment Type** is **Processing**.

The **Main** section contains the following fields:

Field Name	Field Description	Mandatory (Yes or No)
Start Date	Used to specify the date from when the price item pricing is effective.	Yes
	<p>Note:</p> <p>By default, the current system date appears in this field.</p> <p>The effective start date cannot be later than the effective end date.</p>	
End Date	Used to specify the date till when the price item pricing is effective.	No
	<p>Note: The effective end date cannot be earlier than the effective start date.</p>	
Price Assignment Type	<p>Used to indicate the type of price assignment. The valid values are:</p> <ul style="list-style-type: none"> • Regular – Used to indicate that the pricing must be used to generate regular bill segment. • Post Processing – Used to indicate that the pricing must be used to generate post processing bill segment. This type of price assignment can be done on usage accounts. The post processing bill segment is generated when you generate the bill for the usage account and not when you bill the usage account through an invoice account. <p>Note:</p> <p>The post processing bill segment is generated when the Post Processing Sequence (PPSEQ) characteristic is defined for the price item and when the price item is associated with another price item using the Price Item relationship type.</p> <ul style="list-style-type: none"> • Post Processing – Invoice Based – Used to indicate that the pricing must be used to generate post processing bill segment. This type of price assignment can be done on an invoice account, and, as a result, the post processing bill segment is generated on the invoice account. 	Yes

Field Name	Field Description	Mandatory (Yes or No)
	<p>Note: This will not be applicable for price item which are defined for Only Pricing.</p> <ul style="list-style-type: none"> • Post Processing – Price Item Based – Used to indicate that the pricing must be used to generate post processing bill segment. This type of price assignment can be done on both invoice and usage accounts, but the post processing bill segment is generated only on the invoice account. <p>Note: This will not be applicable for price item which are defined for Only Pricing.</p>	
Pricing Eligibility	Used to select pricing eligibility criteria for price item pricing.	No
Pricing Status	Used to indicate the status of the price assignment. The valid values are: <ul style="list-style-type: none"> • Draft – Indicates that the price assignment is created as a draft. • Proposed – Indicates that the price assignment is used for quotations. 	Yes
Pricing Currency	Used to indicate the currency in which you want to define the price item pricing.	Yes
Rate Schedule	Used to specify the rate schedule that you want to use while defining price item pricing. <p>Note: Rate schedules control how the bills for the price item will be calculated.</p> <p>The Search (🔍) icon appears corresponding to this field. On clicking the Search icon, the Rate Schedule Search screen appears.</p>	Yes
Pricing Rule Type	Used to indicate the pricing rule type. The valid value is: <ul style="list-style-type: none"> • Two-Dimensional 	Yes (Conditional) <p>Note: This field is required when you are defining a two-dimensional pricing rule.</p>
Print Zero	Used to indicate whether zero pricing should be displayed in the bill. The valid values are: <ul style="list-style-type: none"> • Yes • No <p>Note: By default, Yes is selected.</p>	Yes

Field Name	Field Description	Mandatory (Yes or No)
Pricing Frequency	Used to indicate pricing frequency for the price item.	Yes
	Note: This field appears when Price Item is defined as Only Pricing and Price Item Type is defined as Fees .	

6. Enter the required details in the **Main** section.
7. Define TFM Information in a price item pricing, if required.
8. Define characteristics for a price item pricing, if required.
9. Define parameters for a price item pricing, if required.
10. Click **Save**.

The pricing is defined for the price item.

Note: A bundle cannot be assigned if its child price items are already assigned to an account and vice versa, in the same date range.

Related Topics

For more information on...	See...
How to search for an account	Searching for an Account on page 204
Pricing (Account) screen	Pricing (Account) on page 550
Search Price Item or Price Item Pricing zone	Search Price Item or Price Item Pricing on page 555
How to define a characteristic for a price item pricing	Defining a Characteristic for a Price Item Pricing on page 492
How to define parameters for a price item pricing	Defining a Parameter for a Price Item Pricing on page 579
How to define TFM Information in a price item pricing	Defining TFM Information in a Price Item Pricing on page 491

Defining a Characteristic for a Price Item Pricing

Note: This topic is not applicable for the health insurance business.

Prerequisites

To define a characteristic for a price item pricing, you should have:

- Characteristic types defined in the application (where the characteristic entity is set to **Price Item**)

Procedure

To define a characteristic for a price item pricing:

1. Ensure that the **Characteristics** section is expanded when you are defining, editing, or overriding a price item pricing.

The **Characteristics** section contains the following fields in a grid:

Field Name	Field Description	Mandatory (Yes or No)
Effective Date	Used to specify the date from when the characteristic is effective for the price item pricing.	Yes (Conditional)
		Note: This field is required while defining a characteristic for the price item pricing.
Characteristic Type	Used to indicate the characteristic type. Note: The list includes only those characteristic types where the characteristic entity is set to Price Item .	Yes (Conditional)
		Note: This field is required while defining a characteristic for the price item pricing.
Characteristic Value	Used to specify the value for the characteristic type. Note: If you select a predefined characteristic type, the Search (🔍) icon appears corresponding to the Characteristic Value field. On clicking the Search icon, the Predefined Characteristic Search window appears. On specifying the value for a predefined characteristic type, the description of the characteristic value appears corresponding to the Characteristic Value field.	Yes (Conditional)
		Note: This field is required while defining a characteristic for the price item pricing.

- Enter the required details in the **Characteristics** section.
- If you want to define more than one characteristic for the price item pricing, click the **Add** (+) icon and then repeat step 2.

Note: However, if you want to remove a characteristic from the price item pricing, click the **Delete** (🗑️) icon corresponding to the characteristic.

- Click **Save**.

The characteristic is defined for the price item pricing.

Related Topics

For more information on...	See...
How to define a price item pricing	Defining a Price Item Pricing on page 626
How to edit a price item pricing	Editing a Price Item Pricing on page 678
How to override a price item pricing	Overriding a Price Item Pricing on page 691

Defining a Parameter for a Price Item Pricing

Prerequisites

To define parameters for a price item pricing, you should have:

- Parameters associated with the price item, in case, you want to define price item pricing based on multiple parameters

Procedure

To define parameter details segment for a price item pricing that is assigned to an account:

1. Ensure that the **Price Item and Parameter Information** section is expanded when you are defining a price item pricing.

The **Price Item and Parameter Information** section contains the following field:

Field Name	Field Description
Price Item	Indicates the price item or price item bundle whose pricing details are listed in this section.

In addition, this section contains a grid which has the following columns:

Column Name	Column Description	Mandatory (Yes or No)
Parameter	Used to indicate the parameter that you want to associate with the price item pricing. Note: The Search (🔍) icon appears corresponding to this field. On clicking the Search icon, the Price Item Parameter Search window appears. The parameter search results displays only those parameters where the Price Item check box is selected.	Yes
Parameter Information	Displays a comma-separated string which contains of the following: <ul style="list-style-type: none"> Parameter Description Mandatory (Yes or No) Priority 	Not applicable
Parameter Value	Used to specify the value of the parameter.	Yes

2. Enter the required details in the **Price Item and Parameter Information** section.
3. If you want to define more than one parameter information for the price item pricing, click the **Add** (+) icon and then repeat step 2.

Note: However, if you want to remove a parameter information from the price item pricing, click the **Delete** (🗑️) icon corresponding to the parameter.

4. Click **Save**.

The parameters are defined for the price item pricing.

Related Topics

For more information on...	See...
How to define a price item pricing	Defining a Price Item Pricing on page 626
How to edit a price item pricing	Editing a Price Item Pricing on page 678
How to override a price item pricing	Overriding a Price Item Pricing on page 691

Defining TFM Information in a Price Item Pricing

Note: This topic is not applicable for the health insurance business.

Prerequisites

To define the TFM information in a price item pricing, you should have:

- Transactions mapped to the price item defined in the application
- Aggregation or rating criteria to be defined for the price item pricing

Procedure

To define the TFM information in a price item pricing:

1. Ensure that the **TFM Information** section is expanded when you are defining, editing, or overriding a price item pricing.

The **TFM Information** section contains the following fields:

Field Name	Field Description	Mandatory (Yes or No)
Ignore Transaction	Used to indicate whether the transactions mapped to the price item are considered for billing or not. The valid values are: <ul style="list-style-type: none"> • Yes • No 	Yes (Conditional)
	Note: By default, the No option is selected.	Note: This field is required while defining the TFM information in a price item pricing.
Aggregate Transactions	Used to indicate whether aggregation is required while rating the transactions mapped to the price item pricing before billing. The valid values are: <ul style="list-style-type: none"> • Yes - Indicates that aggregation is required while rating the transactions mapped to the price item pricing before billing. • No - Indicates that aggregation is not required while rating the transactions mapped to the price item pricing before billing. 	Yes (Conditional)
	Note: By default, the Yes option is selected.	Note: This field is required while defining the TFM information in a price item pricing.
Aggregation Schedule	Used to indicate the transaction aggregation cycle. The valid values are: <ul style="list-style-type: none"> • Daily • Weekly • Monthly • Quarterly • Yearly 	Yes (Conditional)
		Note: This field is required while defining the TFM information in a price item pricing.

Field Name	Field Description	Mandatory (Yes or No)
Transaction Rating Criteria	Used to indicate how and when the transaction legs mapped to the price item are rated. The valid values are: <ul style="list-style-type: none"> Aggregate Transactions and Then Rate Aggregated SQs Do Not Rate Transactions Rate Transaction and Aggregate Calc Lines 	Yes (Conditional)
	Note: By default, the Do Not Rate Transactions option is selected.	Note: This field is required while defining the TFM information in a price item pricing.

- Enter the required details in the **TFM Information** section.

Note: **TFM Information** section appears when the value for **Show Default Values in Price Item Pricing** option type of **C1_FM feature configuration** is set to **Y** and **Price Item Available For** is **Pricing and Billing**.

- Click **Save**.

The TFM information is defined in the price item pricing.

Related Topics

For more information on...	See...
How to define a price item pricing	Defining a Price Item Pricing on page 626
How to edit a price item pricing	Editing a Price Item Pricing on page 678
How to override a price item pricing	Overriding a Price Item Pricing on page 691

Pricing (Person)

Note: This topic is not applicable for the health insurance business.

The **Pricing (Person)** screen allows you to:

- View effective price assignments of a person
- View the details of an assigned or inherited price item pricing
- Search and assign price items or price item bundles to a person
- Edit or override a price item pricing
- Copy a price item pricing and assign it to a person

You can also view effective price assignments of a global person (i.e. a person who is not associated to any division) in this screen. The pricing for all price items or price item bundles assigned to the global person either directly or through a price list appears in this screen. However, you will be able to view pricing for only those price items or price item bundles that are associated to the division to which you have access.

Since a global person is not associated to any division, the system cannot determine the price assignment search order for a global person. Hence, the default search order is defined for global persons through the **C1_PRASNORDR** feature configuration. This feature configuration contains the **Price Assignment Algorithm** option type where you need to specify the algorithm which contains default search order for global persons. You can change this default search order,

if required. The valid search order values are — **AGREED_PRICELIST** and **AGREED_FIRST**. You can also create a custom search order, if required.

This screen consists of the following zones:

- [Effective Price Assignments for Person](#) on page 583
- [Search Price Item or Price Item Pricing](#) on page 587

Effective Price Assignments for Person

Note: This topic is not applicable for the health insurance business.

The **Effective Price Assignments for Person** zone lists the price item pricing (i.e. price assignments) which are effective on the current date. In other words, it lists effective pricing for price items or price item bundles assigned to the person either directly or through the customer hierarchy. The order in which the price assignments are listed is controlled by the **Price Assignment Search** algorithm defined for the division to which the person belongs. If required, you can filter effective price assignments using various search criteria.

Note: If the effective pricing is available for the price item, regular bundle (to which the price item belongs), and parent (regular) bundle (i.e. to which the regular bundle belongs) at the same level, the system lists the pricing depending on the value defined for the **Prefer Price Item Over Bundle** parameter in the price assignment search algorithm. If the value of the **Prefer Price Item Over Bundle** parameter is set to **Y**, the system lists effective pricing which is available for the price item. If the effective pricing is not available for the price item, then the system lists effective pricing which is available for the regular bundle at the same level. If the effective pricing is not available for the regular bundle, then the system lists effective pricing which is available for the parent bundle at the same level. However, if the value of the **Prefer Price Item Over Bundle** parameter is set to **N**, the system lists effective pricing which is available for the parent bundle. If the effective pricing is not available for the parent bundle, then the system lists effective pricing which is available for the regular bundle at the same level. If the effective pricing is not available for the regular bundle, then the system lists effective pricing which is available for the price item at the same level.

This zone contains the following two sections:

- **Search Criteria** — The **Search Criteria** section contains the following fields:

Field Name	Field Description	Mandatory (Yes or No)
Person ID	Indicates the person whose effective price assignments are listed in this zone.	Not applicable
Effective Pricing Date	Used to search price assignments which are effective on a particular date.	No
	Note: By default, this field is set to the current date.	
Assignment Level	Used to search price assignments at a particular level in the customer hierarchy. The valid values are: <ul style="list-style-type: none"> • Customer Agreed – Means price item pricing is agreed for the main customer in the customer hierarchy. • Customer Price List – Means price item pricing is defined in the price list which is assigned to the main customer. • Customer Inherited Price List – Means price item pricing is inherited from the parent price list hierarchy defined for the price list which is assigned to the main customer. 	No

Field Name	Field Description	Mandatory (Yes or No)
	<ul style="list-style-type: none"> • Default Price List – Means price item pricing defined in the price list is available in the default price list. • Global Price List – Means price item pricing defined in the price list is available in the global price list. • Parent Customer Agreed – Means price item pricing is agreed for the parent customer in the customer hierarchy. • Parent Customer Price List – Means price item pricing is defined in the price list which is assigned to the parent customer. • Parent Customer Inherited Price List – Means price item pricing is inherited from the parent price list hierarchy defined for the price list which is assigned to the parent customer. 	
Parent Person	Used to search price assignments which are inherited from a particular parent customer.	No
Pricing Status	Used to search price assignments with a particular status. The valid values are: <ul style="list-style-type: none"> • Active • Proposed 	No
	Note: By default, the Active option is selected.	
Show Default and Global Pricing	Used to indicate whether you want to search price assignments inherited from the default or global price list. The valid values are: <ul style="list-style-type: none"> • Yes – Used when you want to search price assignments inherited from either of the following: <ul style="list-style-type: none"> • Default price list defined for the division • Global price list • No – Used when you do not want to search price assignments inherited from either of the following: <ul style="list-style-type: none"> • Default price list defined for the division • Global price list 	No
	Note: By default, the No option is selected.	
Price Item	Used to search price assignments of a particular price item or price item bundle.	No
Description	Used to search price assignments of a price item or price item bundle having a particular description.	No

Field Name	Field Description	Mandatory (Yes or No)
Search Type	Used to search the price list using the following values: <ul style="list-style-type: none"> • Best Fit • Exact Match 	No
	Note: By default, the Exact Match option is selected.	

Note: The **Search** (🔍) icon appears corresponding to the **Price Item** field. On clicking the **Search** icon, you can search for a price item.

- **Price Item Parameters** – The **Price Item Parameters** section contains the following fields:

Field Name	Field Description	Mandatory (Yes or No)
Parameter	Used to search price assignments which are defined using a particular parameter.	No
	Note: This field appears when the Multi Price Parameter option type of the Multi Parameter Based Pricing (C1_PPARM_FLG) feature configuration is set to True .	
Parameter Value	Used to search price assignments which are defined using a particular parameter value.	No
	Note: This field appears when the Multi Price Parameter option type of the Multi Parameter Based Pricing (C1_PPARM_FLG) feature configuration is set to True .	

Note:



The **Search** (🔍) icon appears corresponding to the **Parameter** field. On clicking the **Search** icon, you can search for a parameter.

You can only use those parameters where the source entity is set to **Transaction**.

The **Search** (🔍) icon appears corresponding to the **Parameter Value** field when the value type of the parameter is **Predefined** or **Reference**. If the value type of the parameter is **Predefined** then on clicking the **Search** icon, you can search for a predefined parameter value. However, if the value type of the parameter is **Reference** then on clicking the **Search** icon, you can search for a reference parameter value.

- **Search Results** – On clicking the **Search** button, the search results are filtered based on the specified search criteria. The **Search Results** section contains the following columns:

Column Name	Column Description
Pricing Information	Displays the concatenated string consisting of pricing information and pricing ID for the person.
	Note: It has a link. On clicking the link, the View Price Item Pricing screen appears with the details of the respective price item pricing.
Price Item	Displays the price item or price item bundle code.
Pricing Parameters	Used to specify multiple parameters based on which you want to determine the pricing utilization.
	Note: This column appears only when the Multi Price Parameter option type of the Multi Parameter Based Pricing (C1_PPARM_FLG) feature configuration is set to True .
Price Assignment Type	Indicates the type of price assignment. The valid values are: <ul style="list-style-type: none"> • Regular • Post Processing • Post Processing – Invoice Based • Post Processing – Price Item Based
Assignment Level	Indicates the level at which the price item pricing is defined in the customer hierarchy. The valid values are: <ul style="list-style-type: none"> • Customer Agreed • Customer Price List • Customer Inherited Price List • Default Price List • Global Price List • Parent Customer Agreed • Parent Customer Price List • Parent Customer Inherited Price List
Rate Info	Displays the rate of the price item.
	Note: If the price assignment has only one price component, you can view the rate defined in the pricing directly through the Rate Info column. However, if the price assignment has more than one price components, then the Rate Info column contains a string indicating the tiering type and pricing currency. It also contains “...” which indicates that for more information about the pricing you should navigate to the Price Item Pricing screen.
Price List Information	Displays the information about the price list which is assigned to the account.
Rate Schedule	Indicates the rate schedule which is used for defining the price item pricing.

Column Name	Column Description
Edit	<p>On clicking the Edit () icon, the Price Item Pricing screen appears where you can edit the details of the price item pricing.</p> <p>Note: The Edit icon appears when the assignment level is Customer Agreed.</p>
Override	<p>On clicking the Override () icon, the Price Item Pricing screen appears where you can override the price item pricing.</p> <p>Note:</p> <p>You can override a price item pricing assigned at any level in the customer hierarchy. On overriding a price item pricing, a new price item pricing which is specific to the account is defined at the account level and is then called account agreed pricing.</p> <p>A customer agreed or account agreed price assignments are effective for a particular duration and do not expire until you specify the end date manually. However, if you set the Expire Override Switch option type of the C1_EXP_OVRD feature configuration to Y, the system will automatically expire an agreed pricing when the agreed pricing of a customer or an account without end date is overridden. If you do not want an agreed pricing to automatically expire when it is overridden, you must set the Expire Override Switch option type of the C1_EXP_OVRD feature configuration to N.</p>
Effective Start Date	Displays the date from when the price item pricing is effective.
Effective End Date	Displays the date till when the price item pricing is effective.
Pricing Currency	Indicates the currency in which the price item pricing is defined.
Parent Person	Displays the name of the parent or grandparent customer from whom the price item pricing is inherited.

Note: The number of records that can be displayed in the **Search Results** section is controlled via the **C1_PR_REC** feature configuration. You can change the number of records that can be displayed using the **Effective Pricing RecordSet Limit** option type of the **C1_PR_REC** feature configuration. For more information, refer to [Setting the C1_PR_REC Feature Configuration](#) on page 4341.

Related Topics

For more information on...	See...
How to view effective price assignments of a person	Viewing Effective Price Assignments of a Person on page 592
How to override a price item pricing	Override Price Item Pricing
How to edit a price item pricing	Editing a Price Item Pricing
How to filter effective price assignments of a person	Filtering Effective Price Assignments of a Person on page 593

Search Price Item or Price Item Pricing

Note: This topic is not applicable for the health insurance business.

You can either assign a price item to a price list and then define pricing for the price item, or you can copy an existing price item pricing and assign it to a price list. The **Search Price Item** zone allows you to search for a price item pricing which is assigned to an account, person, or a price list. You can then create a new price item pricing using an existing price item pricing through copying the price item pricing. Once you create a copy of an existing price item pricing, the new price item pricing is assigned to the price list. On copying a price item pricing, the pricing details including the price components, eligibility and tiering criteria for each price component, and characteristics are copied to the new price item pricing. You can then edit the details, if required.

The system allows you to create a copy of active, proposed, inactive, rejected, and template price item pricing. Once you create the copy of a template price item pricing, you can save the new price item pricing in either **Active** or **Proposed** status.

The **Search Price Item** zone contains the following two sections:

- **Search Criteria** – The **Search Criteria** section contains the following fields:

Field Name	Field Description	Mandatory (Yes or No)
Search By	Used to search whether you want to search price item pricing for a price item, account, person, or a price list. The valid values are: <ul style="list-style-type: none"> • Price Item • Price List Pricing • Account Override Pricing • Person Override Pricing 	Yes
Price Item	Used to search pricing for a particular price item or price item bundle.	No
Description	Used to search price items or price item bundles with a particular description. Note: This field appears when you select the Price Item option from the Search By list.	No
Global Price List	Used to search price items or price item bundles which can be assigned to a global price list. The valid values are: <ul style="list-style-type: none"> • Yes • No Note: This field appears when you select the Price Item option from the Search By list.	No
Bundle	Used to search whether the price item is a bundle or not. The valid values are: <ul style="list-style-type: none"> • Yes • No Note: This field appears when you select the Price Item option from the Search By list.	No
Price List ID	Used to search the price list to which the price item pricing is assigned.	No

Field Name	Field Description	Mandatory (Yes or No)
	Note: This field appears when you select the Price List Pricing option from the Search By list.	
Effective Start Date	Used to search price item pricing on price lists which are effective from a particular date onwards. Note: This field appears when you select the Price List Pricing, Account Override Pricing, or Person Override Pricing option from the Search By list.	No
Effective End Date	Used to search price item pricing on price lists which are effective till a particular date. Note: This field appears when you select the Price List Pricing, Account Override Pricing, or Person Override Pricing option from the Search By list.	No
Pricing Status	Used to search price item pricing with a particular status. The valid values are: <ul style="list-style-type: none"> • Active • Inactive • Proposed • Rejected • Template Note: This field appears when you select the Price List Pricing, Account Override Pricing, or Person Override Pricing option from the Search By list.	No
Price Assignment Type	Used to search a particular type of the price item pricing. The valid values are: <ul style="list-style-type: none"> • Regular • Post Processing • Post Processing – Invoice Based • Post Processing – Price Item Based Note: This field appears when you select the Price List Pricing, Account Override Pricing, or Person Override Pricing option from the Search By list.	No
Account ID	Used to search pricing of price items which are assigned to a particular account. Note: This field appears when you select the Account Override Pricing option from the Search By list.	No
Person ID	Used to search pricing of price items which are assigned to a particular person.	No

Field Name	Field Description	Mandatory (Yes or No)
	Note: This field appears when you select the Person Override Pricing option from the Search By list.	

Note:

You must specify at least one search criterion while searching for a price item or price item bundle.

The **Search** (🔍) icon appears corresponding to the **Price List ID**, **Price Item**, **Account ID**, and **Person ID** fields. On clicking the **Search** icon, you can search for a price list, price item, an account, and person.

- **Search Results** — On clicking the **Search** button, the search results appear based on the specified search criteria. The search results include only those price items or price item bundles that are associated with the division to which the person belongs. However, if the person does not belong to any division, the search will be performed against all price items or price item bundles defined in the system. It may also include price items or price item bundles that are already assigned to the person in case those price items or price item bundles match the search criteria.

The **Search Results** section contains the following columns:

Column Name	Column Description
Assign	On clicking the Assign (📌) icon, the Price Item Pricing screen appears where you can define a new price item pricing. Note: This column appears when you select the Price Item option from the Search By list.
Price Item Information	Displays details of the price item or price item bundle. Note: It has a link. On clicking the link, the Price Item screen appears where you can view the details of the respective price item or price item bundle. This column appears when you select the Price Item option from the Search By list.
Copy	On clicking the Copy (📄) icon, the Price Item Pricing screen appears where you can define a new price item pricing using an existing price item pricing.
Pricing Information	Displays details of the price item pricing. Note: This column appears when you select the Price List Pricing , Account Override Pricing , or Person Override Pricing option from the Search By list.
Account Information	Indicates the account to which the price item pricing is assigned. In addition, this column has a context menu which helps in navigating to other screens in the application.

Column Name	Column Description
	<p>Note:</p> <p>This column appears when you select the Account Override Pricing option from the Search By list.</p> <p>It has a link. On clicking the link, the Account screen appears where you can view the details of the respective account.</p> <p>The account information string appears when an algorithm defined using the C1-AC-INFO algorithm type is attached to the Account Information system event in the Algorithms tab of the Installation Options – Framework screen.</p>
Person Information	<p>Indicates the person to which the price item pricing is assigned. In addition, this column has a context menu which helps in navigating to other screens in the application.</p> <p>Note:</p> <p>This column appears only when you select the Person Override Pricing option from the Search By list.</p> <p>It has a link. On clicking the link, the Person screen appears where you can view the details of the respective person.</p> <p>The person information string appears when an algorithm defined using the PERS-INFO algorithm type is attached to the Person Information system event in the Algorithms tab of the Installation Options – Framework screen.</p>
Price List Information	<p>Indicates the price list to which the price item pricing is assigned. In addition, this column has a context menu which helps in navigating to other screens in the application.</p> <p>Note:</p> <p>This column appears when you select the Price List Pricing option from the Search By list.</p> <p>It has a link. On clicking the link, the Price List screen appears where you can view the details of the respective price list.</p>
Pricing Parameters	<p>Displays a comma-separated list of parameter values. The order in which parameter values appear in this column is controlled by the display order (which is defined while associating a parameter with a price item or price item bundle).</p> <p>Note: This column appears when the Multi Price Parameter option type of the Multi Parameter Based Pricing (C1_PPARM_FLG) feature configuration is set to False.</p>
Effective Start Date	<p>Displays the date from when the price item pricing is effective.</p> <p>Note: This column appears when you select the Price List Pricing, Account Override Pricing, or Person Override Pricing option from the Search By list.</p>
Effective End Date	<p>Displays the date till when the price item pricing is effective.</p>

Column Name	Column Description
	Note: This column appears when you select the Price List Pricing, Account Override Pricing, or Person Override Pricing option from the Search By list.
Pricing Currency	Indicates the currency in which the price item pricing is defined. Note: This column appears when you select the Price List Pricing, Account Override Pricing, or Person Override Pricing option from the Search By list.
Rate Schedule	Indicates the rate schedule which is used for defining the price item pricing. Note: It has a link. On clicking the link Rate Schedule screen appears. This column appears when you select the Price List Pricing, Account Override Pricing, or Person Override Pricing option from the Search By list.
Price Assignment Usage	Indicates whether the price item pricing is applicable to all customers or only to new customers. The valid values are: <ul style="list-style-type: none"> • All Customers • New Customers Note: This column appears when you select the Price List Pricing, Account Override Pricing, or Person Override Pricing option from the Search By list.
Price Assignment Type	Indicates the type of the price item pricing. The valid values are: <ul style="list-style-type: none"> • Regular • Post Processing • Post Processing – Invoice Based • Post Processing – Price Item Based Note: This column appears when the Multi Price Parameter option type of the Multi Parameter Based Pricing (C1_PPARM_FLG) feature configuration is set to False .

Related Topics

For more information on...	See...
How to copy a price item pricing	Copying a Price Item Pricing on page 597
How to assign a price item or price item bundle to a person	Assigning a Price Item to a Person on page 607

Viewing Effective Price Assignments of a Person

Note: This topic is not applicable for the health insurance business.

Prerequisites

To view effective price assignments of a person, you should have:

- Price items or price item bundles assigned to the person either directly or through the customer hierarchy

Procedure

To view effective price assignments of a person:

1. Search for the person in the **Customer 360° View** screen.
2. In the **Search Results** section, click the **Show Context Menu** (▼) icon corresponding to the person whose details you want to view.
A menu appears.
3. Click the **Go To Effective Pricing** menu option.
The **Pricing (Person)** screen appears.
4. View the pricing for price items or price item bundles assigned to the person (either directly or through the customer hierarchy) in the **Effective Price Assignments for Person** zone.
5. Filter the effective price assignments of the person, if required.

Related Topics

For more information on...	See...
How to search for a person	Searching for a Person on page 203
Pricing (Person) screen	Pricing (Person) on page 582
Effective Price Assignments for Person zone	Effective Price Assignments for Person on page 583
How to filter effective price assignments of a person	Filtering Effective Price Assignments of a Person on page 593

Filtering Effective Price Assignments of a Person

Note: This topic is not applicable for the health insurance business.

Prerequisites

To filter effective price assignments of a person, you should have:

- Price items or price item bundles defined in the application
- Parameters defined in the application (where the source entity is set to **Transaction**)
- Price items or price item bundles assigned to the person either directly or through the customer hierarchy

Procedure

To filter effective price assignments of a person:

1. Search for the person in the **Customer 360° View** screen.
2. In the **Search Results** section, click the **Show Context Menu** (▼) icon corresponding to the person whose details you want to view.
A menu appears.
3. Click the **Go To Effective Pricing** menu option.
The **Pricing (Person)** screen appears.
4. Enter the search criteria in the **Effective Price Assignments for Person** zone.

Note:

You can search for a price item, parameter, or parameter value by clicking the **Search** (🔍) icon corresponding to the respective field.

If you want to add more than one parameter in the search criteria, click the **Add** (+) icon and then enter the parameter name and its value. However, if you want to remove a parameter from the search criteria, click the **Delete** (🗑️) icon corresponding to the parameter.

You can only use those parameters where the source entity is set to **Transaction**.

ORMB search engine supports wildcard search, where you can substitute the percentage (%) symbol as a stand in for any word or letter in a search criteria. You can use the ‘%’ wildcard character in all input fields except the date and ID fields. The ‘%’ wildcard character is suffixed automatically at the end of the partial search criteria. Therefore, you may or may not specify the wildcard character at the end of the partial search criteria. However, you have to prefix the wildcard character manually wherever required.

5. Click Search.

A list of price assignments which are effective on the specified date and that meet the search criteria are listed in the **Effective Price Assignments for Person** zone.

Related Topics

For more information on...	See...
How to search for a person	Searching for a Person on page 203
Pricing (Person) screen	Pricing (Person) on page 582
Effective Price Assignments for Person zone	Effective Price Assignments for Person on page 583

Exporting Effective Price Assignments of a Person

Note: This topic is not applicable for the health insurance business.

Prerequisites

To export effective price assignments of a person in the CSV format, you should have:

- Price items or price item bundles assigned to the person either directly or through the customer hierarchy

Procedure

To export effective price assignments of a person in the CSV format:

1. Search for the person in the **Customer 360° View** screen.
2. In the **Search Results** section, click the **Show Context Menu** (▼) icon corresponding to the person whose details you want to view.
A menu appears.
3. Click the **Go To Effective Pricing** menu option.
The **Pricing (Person)** screen appears.
4. Filter the effective price assignments of the person, if required.
5. Click the **Export to Excel** link in the **Effective Price Assignment** zone.
A message appears confirming whether you want to open or save the EffectivePricing.csv file.
6. Select the **Save As** option from the **Save** list.

The **Save As** dialog box appears.

7. Browse to the location where you want to save the file.
8. Enter the file name in the respective field, and click **Save**.

The search results are exported in the CSV format.

9. Open the CSV file in Microsoft Excel.

The sheet contains the following columns:

Column Name	Column Description
Price Item	Displays the price item or price item bundle code.
Description	Displays the description of the price item or price item bundle.
Variance	Indicates the variance parameter which is used for defining the price item pricing. Note: This column appears when the Multi Price Parameter option type of the Multi Parameter Based Pricing (C1_PPARM_FLG) feature configuration is set to False .
Price Item Parameters	Displays a comma-separated list of parameter values. The order in which parameter values appear in this column is controlled by the display order (which is defined while associating a parameter with a price item). A tool tip appears when you hover over this column corresponding to the price item. It indicates the price item parameters and their values which are used for defining the price item pricing. Note: This column appears when the Multi Price Parameter option type of the Multi Parameter Based Pricing (C1_PPARM_FLG) feature configuration is set to True .
Price Assignment Type	Indicates the type of price assignment. The valid values are: <ul style="list-style-type: none"> • Regular • Post Processing • Post Processing – Invoice Based • Post Processing – Price Item Based
Assignment Level	Indicates the level at which the price item pricing is defined in the customer hierarchy. The valid values are: <ul style="list-style-type: none"> • Customer Agreed • Customer Price List • Customer Inherited Price List • Parent Customer Agreed • Parent Customer Price List • Parent Customer Inherited Price List
Price List Description	Displays the description of the price list. Note: The description appears when the assignment level is Customer Price List, Customer Inherited Price List, Parent Customer Price List, or Parent Customer Inherited Price List .

Column Name	Column Description
Rate Description	Displays the description of the rate schedule which is used for defining the price item pricing.
Rate Component Information	Displays a comma-separated string which consists of the following: <ul style="list-style-type: none"> • Rate Component Sequence • Tiering Setup of the Rate Component
Price Component Sequence	Indicates the sequence number of the price component.
Price Component Description	Displays the description of the price component.
Rate	Indicates the rate defined for the price component.
Effective Start Date	Displays the date from when the price item pricing is effective.
Effective End Date	Displays the date till when the price item pricing is effective.
Pricing Currency	Indicates the currency in which the price item pricing is defined.
From	Displays the lower limit of the tiering range.
To	Displays the upper limit of the tiering range.
Price Assignment Usage	Indicates whether the price item pricing is applicable to all customers or only to the new customers. The valid values are: <ul style="list-style-type: none"> • AC • NC
Price Assignment ID	Displays the price assignment ID.
Parent Level	Indicates the numerical level of the parent in the customer hierarchy from whom the price item pricing is inherited.
Price List ID	Indicates the price list from where the price item pricing is inherited.
Price List Start Date	Displays the date from when the price list is effective.
Parent Person	Displays the name of the parent or grandparent customer from whom the price item pricing is inherited.
Parent Pricelist Level	Indicates the parent level when price item pricing is inherited from the price list hierarchy. If the pricing is inherited from the assigned price list, the parent price list level will be 0. However, if the pricing is inherited from the parent price list in the hierarchy, the parent price list level will be 1. And, if the pricing is inherited from the grandparent price list in the hierarchy, the parent price list level will be 2, and so on.
Ignore Transaction	Indicates whether the transactions mapped to the price item is considered for billing. The valid values are: <ul style="list-style-type: none"> • Y • N
Aggregate Transaction	Indicates whether the transactions mapped to the price item is aggregated for billing. The valid values are: <ul style="list-style-type: none"> • Y

Column Name	Column Description
	<ul style="list-style-type: none"> N
Aggregation Schedule	Indicates the transaction aggregation cycle. The valid values are: <ul style="list-style-type: none"> Daily Weekly Monthly Quarterly Yearly
Tiering Criterion	Indicates the tiering criterion which is used in the tiering range.
Tiering Price Item	Indicates whether the price item or price item bundle's total usage is considered for determining the rate.

Related Topics

For more information on...	See...
How to search for a person	Searching for a Person on page 203
Pricing (Person) screen	Pricing (Person) on page 582
Effective Price Assignment zone	Effective Price Assignments for Person on page 583

Copying a Price Item Pricing

Note: This topic is not applicable for the health insurance business.

Prerequisites

To copy a price item pricing and assign it to a person, you should have:

- Person (to which you want to assign the price item pricing) defined in the application
- Person associated with the division to which the user belongs
- Price item pricing (whose copy you want to create) defined in the application

Procedure

To copy a price item pricing and assign it to a person:

- Search for the person in the **Customer 360° View** screen.
- In the **Search Results** section, click the **Show Context Menu** () icon corresponding to the person whose details you want to view.
A menu appears.
- Click the **Go To Effective Pricing** menu option.
The **Pricing (Person)** screen appears.
- In the **Search Price Item** zone, select the required option from the **Search By** list to indicate whether you want to search price item pricing assigned to an account, person, or a price list.
The fields in the **Search Criteria** section change depending on the option that you select from the **Search By** list.
- Enter the search criteria in the **Search Price Item** zone to search for the price item pricing whose copy you want to create and assign it to the person.

6. Click Search.

A list of price assignments that meet the search criteria appears in the **Search Results** section.

7. In the Search Results section, click the Copy (📄) icon in the Copy column corresponding to the price item pricing whose copy you want to create.

The **Price Item Pricing** screen appears.

8. Modify the required pricing details.**Note:**

If you change the effective start and end dates while copying a price item pricing, you need to specify the parameters which are effective during that date range.

While copying a price item pricing, you can not only edit the existing tiering combination details, but can also add additional tiering combinations until the maximum tiering combinations limit is met.

If you are creating a copy of active, proposed, inactive, rejected, or template price item pricing, you can save the new price item pricing in the **Active** or **Proposed** status.

9. Edit the characteristics of the price item pricing, if required.**10. Click Save.**

A new price item pricing is defined and assigned to the person.

Related Topics

For more information on...	See...
How to search for a person	Searching for a Person on page 203
Pricing (Person) screen	Pricing (Person) on page 582
Search Price Item zone	Search Price Item or Price Item Pricing on page 587
How to edit a price item pricing of a person	Editing a Price Item Pricing of a Person on page 599
How to define a characteristic for a price item pricing	Defining a Characteristic for a Price Item Pricing on page 492

Viewing a Price Item Pricing

Note: This topic is not applicable for the health insurance business.

Procedure

To view a price item pricing and assignment details:

1. Search for the person in the **Customer 360° View** screen.
2. In the **Search Results** section, click the **Show Context Menu** (▼) icon corresponding to the person whose details you want to view.
A menu appears.
3. Click the **Go To Effective Pricing** menu option.
The **Pricing (Person)** screen appears.
4. Price assignments effective for the person appears in the **Effective Price Assignments for Person** zone.
5. In the **Search Results** section, click the link in the **Pricing Information** column corresponding to the price item whose pricing details you want to view.

The **Price Item Pricing** screen appears. It contains the following zones:

- **Price Item Pricing** – Displays the price item pricing details. It contains the following sections:
 - **Pricing Information** – Displays the pricing information of the price item.
 - **TFM Information** – Displays the transaction feed management information of the price item.
 - **Characteristics** – Displays the details of price item pricing characteristics.
 - **Price Item and Parameter Information** – Displays the price item parameter details.
 - **Record Actions** – Displays the record actions of the price item pricing.
 - **Record Information** – Displays the record information of the price item pricing.
- **Rate and Price Component Summary** – Displays the rate and price component summary of the price item.
- **Rate Components** – Displays the rate components of the price item.
- **Price Components** – Displays the details of price components of the price item.
- **Tiering Criteria** – Displays the tiering criteria of the price item pricing.

Note: This zone appears only when **Tiering Type** for the rate component is **STEP** or **Threshold**

- **Pricing Eligibility Criteria** – Displays the pricing eligibility criteria of the price item pricing.

Note: This zone appears when eligibility checkbox is selected in the **Price Item Pricing** screen and details for pricing eligibility criteria is added in the **Price Component** screen.

6. View the basic details of price item pricing in the **Price Item Pricing** zone.
7. View the rate and price component summary of price item in the **Rate and Price Component Summary** zone.
8. View the rate components of price item in the **Rate Components** zone.
9. View the details of price components of price item in the **Price Components** zone.
10. View the tiering criteria of price item pricing in the **Tiering Criteria** zone.
11. View the pricing eligibility criteria of price item pricing in the **Pricing Eligibility Criteria** zone.

Related Topics

For more information on...	See...
How to search for a person	Searching for a Person on page 203
Pricing (Person) screen	Pricing (Person) on page 582
Effective Price Assignments for Account zone	Effective Price Assignments for Person on page 583
Price Item Pricing screen	Price Item Pricing (Used for Viewing) on page 614
Price Item Pricing zone	Price Item Pricing on page 616
Price Assignment Tree zone	Price Assignment Tree on page 448
Price Components zone	Price Component on page 622

Editing a Price Item Pricing of a Person

Note: This topic is not applicable for the health insurance business.

Prerequisites

To edit a price item pricing of a person, you should have:

- Transactions mapped to the price item defined in the application
- Rate schedules, rate versions, rate components defined in the application
- Parameters associated with the price item (in case you want to define price item pricing based on those parameters)

Procedure

To edit a price item pricing of a person:

1. Search for the person in the **Customer 360° View** screen.
2. In the **Search Results** section, click the **Show Context Menu** (▼) icon corresponding to the person whose details you want to view.

A menu appears.

3. Click the **Go To Effective Pricing** menu option.

The **Pricing (Person)** screen appears.

4. Price assignments effective for the person appears in the **Effective Price Assignments for Person** zone.

5. In the **Search Results** section, click the **Edit** (✎) icon in the **Edit** column corresponding to the price item pricing whose details you want to edit.

The **Price Item Pricing** screen appears. It contains the following sections:

- **Main** – Used to specify basic details about the price item pricing.
- **TFM Information** – Used to specify the transaction feed management information about the price item pricing.

Note: This section appears in the **Price Item Pricing** screen when the value for the **Show Default Values in Price Item Pricing** option type for **C1_FM** feature configuration is set to **Y** and **Price Item Available For** is **Pricing and Billing**.

- **Characteristics** – Used to define the characteristics for the price item pricing.
- **Price Item and Parameter Information** – Used to define the parameter details segment for the price item pricing.

Note: This section appears when **Price Assignment Type** is **Regular**.

The **Main** section contains the following fields:

Field Name	Field Description	Mandatory (Yes or No)
Start Date	Used to specify the date from when the price item pricing is effective. Note: The effective start date cannot be later than the effective end date. If you change the effective start and end dates while editing a price item pricing, you need to specify the parameters which are effective during that date range. This field will be in read-only mode when the price assignment has been used.	Yes

Field Name	Field Description	Mandatory (Yes or No)
End Date	<p>Used to specify the date till when the price item pricing is effective.</p> <p>Note: The effective end date cannot be earlier than the effective start date.</p>	No
Price Assignment Type	<p>Used to indicate the type of price assignment. The valid values are:</p> <ul style="list-style-type: none"> • Regular – Used to indicate that the pricing must be used to generate regular bill segment. • Post Processing – Used to indicate that the pricing must be used to generate post processing bill segment. This type of price assignment can be done on usage accounts. The post processing bill segment is generated when you generate the bill for the usage account and not when you bill the usage account through an invoice account. <p>Note:</p> <p>The post processing bill segment is generated when the Post Processing Sequence (PPSEQ) characteristic is defined for the price item and when the price item is associated with another price item using the Price Item relationship type.</p> <ul style="list-style-type: none"> • Post Processing – Invoice Based – Used to indicate that the pricing must be used to generate post processing bill segment. This type of price assignment can be done on an invoice account, and, as a result, the post processing bill segment is generated on the invoice account. <p>Note: This will not be applicable for price item which are defined for Only Pricing.</p> <ul style="list-style-type: none"> • Post Processing – Price Item Based – Used to indicate that the pricing must be used to generate post processing bill segment. This type of price assignment can be done on both invoice and usage accounts, but the post processing bill segment is generated only on the invoice account. <p>Note: This will not be applicable for price item which are defined for Only Pricing.</p>	Yes
Pricing Eligibility	Used to select pricing eligibility criteria for price item pricing.	No

Field Name	Field Description	Mandatory (Yes or No)
	<p>Note: This field will be enabled for selection if the checkbox is not selected. If the checkbox appears selected then this field will be in read-only mode.</p>	
Pricing Status	<p>Used to indicate the status of the price assignment. The valid values are:</p> <ul style="list-style-type: none"> • Draft – Indicates that the price assignment is created as a draft. • Active – Indicates that the price assignment is used for billing. • Inactive – Indicates that the price assignment is no longer used for billing. • Proposed – Indicates that the price assignment is used for quotations. <p>Note: If a price assignment is in Active status, you can change its status to Inactive. If a price assignment is in Draft status, you cannot change its status to Proposed.</p>	Yes
Pricing Currency	Used to indicate the currency in which you want to define the price item pricing.	Yes
Rate Schedule	<p>Used to specify the rate schedule that you want to use while defining price item pricing.</p> <p>Note: Rate schedules control how the bills for the price item will be calculated.</p> <p>The Search (🔍) icon appears corresponding to this field. On clicking the Search icon, the Rate Schedule Search screen appears.</p>	Yes
Pricing Rule Type	<p>Used to indicate the pricing rule type. The valid value is:</p> <ul style="list-style-type: none"> • Two-Dimensional 	<p>Yes (Conditional)</p> <p>Note: This field is required when you are editing a two-dimensional pricing rule.</p>
Print Zero	<p>Used to indicate whether zero pricing should be displayed in the bill. The valid values are:</p> <ul style="list-style-type: none"> • Yes • No <p>Note: By default, Yes is selected.</p>	Yes

Field Name	Field Description	Mandatory (Yes or No)
Pricing Frequency	Used to indicate pricing frequency for the price item.	Yes
	Note: This field appears when Price Item is defined as Only Pricing and Price Item Type is defined as Fees .	

6. Modify the details in the **Main** section, if required.
7. Edit the TFM Information in a price item pricing, if required.
8. Edit the characteristics for a price item pricing, if required.
9. Edit the parameters for a price item pricing, if required.
10. Click **Save**.

The changes made to the price item pricing are saved.

Related Topics

For more information on...	See...
How to search for a person	Searching for a Person on page 203
Pricing (Person) screen	Pricing (Person) on page 582
Effective Price Assignments for Person zone	Effective Price Assignments for Person on page 583
How to define a price item pricing.	Defining a Price Item Pricing on page 626
How to define a characteristic for a price item pricing.	Defining a Characteristic for a Price Item Pricing on page 492
How to define parameters for a price item pricing.	Defining a Parameter for a Price Item Pricing on page 579
How to define TFM Information in a price item pricing.	Defining TFM Information in a Price Item Pricing on page 491

Overriding a Price Item Pricing of a Person

Note: This topic is not applicable for the health insurance business.

Prerequisites

To override a price item pricing of a person, you should have:

- Transactions mapped to the price item defined in the application
- Rate schedules, rate versions, rate components defined in the application
- Parameters associated with the price item (in case you want to define price item pricing based on multiple parameters)

Procedure

To override a price item pricing of a person:

1. Search for the person in the **Customer 360° View** screen.
2. In the **Search Results** section, click the **Show Context Menu** () icon corresponding to the person whose details you want to view.

A menu appears.

- Click the **Go To Effective Pricing** menu option.

The **Pricing (Person)** screen appears.

- Price assignments effective for the person appears in the **Effective Price Assignments for Person** zone.
- In the **Search Results** section, click the **Override** () icon in the **Override** column corresponding to the price item pricing whose details you want to override.

The **Price Item Pricing** screen appears. It contains the following sections:

- Main** – Used to specify basic details about the price item pricing.
- TFM Information** – Used to specify the transaction feed management information about the price item pricing.

Note: This section appears in the **Price Item Pricing** screen when the value for the **Show Default Values in Price Item Pricing** option type for **C1_FM** feature configuration is set to **Y** and **Price Item Available For** is **Pricing and Billing**.

- Characteristics** – Used to define the characteristics for the price item pricing.
- Price Item and Parameter Information** – Used to define the parameter details segment for the price item pricing.

Note: This section appears when **Price Assignment Type** is **Regular**.

The **Main** section contains the following fields:

Field Name	Field Description	Mandatory (Yes or No)
Start Date	Used to specify the date from when the price item pricing is effective. Note: The effective start date cannot be later than the effective end date. If you change the effective start and end dates while overriding a price item pricing, you need to specify the parameters which are effective during that date range. This field will be in read-only mode when the price assignment has been used.	Yes
End Date	Used to specify the date till when the price item pricing is effective. Note: The effective end date cannot be earlier than the effective start date.	No
Price Assignment Type	Used to indicate the type of price assignment. The valid values are: <ul style="list-style-type: none"> Regular – Used to indicate that the pricing must be used to generate regular bill segment. Post Processing – Used to indicate that the pricing must be used to generate post processing bill segment. This type of price 	Yes

Field Name	Field Description	Mandatory (Yes or No)
	<p>assignment can be done on usage accounts. The post processing bill segment is generated when you generate the bill for the usage account and not when you bill the usage account through an invoice account.</p> <div data-bbox="607 380 1117 653" style="border: 1px solid black; padding: 5px;"> <p>Note: The post processing bill segment is generated when the Post Processing Sequence (PPSEQ) characteristic is defined for the price item and when the price item is associated with another price item using the Price Item relationship type.</p> </div> <ul style="list-style-type: none"> <li data-bbox="578 667 1117 905">• Post Processing – Invoice Based – Used to indicate that the pricing must be used to generate post processing bill segment. This type of price assignment can be done on an invoice account, and, as a result, the post processing bill segment is generated on the invoice account. <div data-bbox="607 911 1117 989" style="border: 1px solid black; padding: 5px;"> <p>Note: This will not be applicable for price item which are defined for Only Pricing.</p> </div> <ul style="list-style-type: none"> <li data-bbox="578 1003 1117 1241">• Post Processing – Price Item Based – Used to indicate that the pricing must be used to generate post processing bill segment. This type of price assignment can be done on both invoice and usage accounts, but the post processing bill segment is generated only on the invoice account. <div data-bbox="607 1247 1117 1325" style="border: 1px solid black; padding: 5px;"> <p>Note: This will not be applicable for price item which are defined for Only Pricing.</p> </div>	
Pricing Eligibility	<p>Used to select pricing eligibility criteria for price item pricing.</p> <div data-bbox="545 1444 1117 1549" style="border: 1px solid black; padding: 5px;"> <p>Note: This field will be in enabled for selection if the checkbox is not selected. If the checkbox appears selected then this field will be in read-only mode.</p> </div>	No
Pricing Status	<p>Used to indicate the status of the price assignment. The valid values are:</p> <ul style="list-style-type: none"> <li data-bbox="578 1661 1117 1724">• Draft – Indicates that the price assignment is created as a draft. <li data-bbox="578 1738 1117 1801">• Proposed – Indicates that the price assignment is used for quotations. <div data-bbox="545 1822 1117 1892" style="border: 1px solid black; padding: 5px;"> <p>Note: If a price assignment is in Draft status, you cannot change its status to Proposed.</p> </div>	Yes

Field Name	Field Description	Mandatory (Yes or No)
Pricing Currency	Used to indicate the currency in which you want to override the price item pricing.	Yes
Rate Schedule	Used to specify the rate schedule that you want to use while defining price item pricing.	Yes
	Note: Rate schedules control how the bills for the price item will be calculated. The Search (🔍) icon appears corresponding to this field. On clicking the Search icon, the Rate Schedule Search screen appears.	
Pricing Rule Type	Used to indicate the pricing rule type. The valid value is: <ul style="list-style-type: none"> • Two-Dimensional 	Yes (Conditional)
		Note: This field is required when you are overriding a two-dimensional pricing rule.
Print Zero	Used to indicate whether zero pricing should be displayed in the bill. The valid values are: <ul style="list-style-type: none"> • Yes • No 	Yes
	Note: By default, Yes is selected.	
Pricing Frequency	Used to indicate pricing frequency for the price item.	Yes
	Note: This field appears when Price Item is defined as Only Pricing and Price Item Type is defined as Fees .	

6. Modify the details in the **Main** section, if required.
7. Modify the TFM Information in a price item pricing, if required.
8. Modify the characteristics for a price item pricing, if required.
9. Modify the parameters for a price item pricing, if required.

Note: If you change the effective end date while overriding a price item pricing, you need to specify the parameters which are effective during the date range of start and end date.

10. Click **Save**.

The price item pricing is overridden.

Related Topics

For more information on...	See...
How to search for a person	Searching for a Person on page 203
Pricing (Person) screen	Pricing (Person) on page 582

For more information on...	See...
Effective Price Assignments for Person zone	Effective Price Assignments for Person on page 583
How to define a price item pricing	Defining a Price Item Pricing on page 626
How to define a characteristic for a price item pricing	Defining a Characteristic for a Price Item Pricing on page 492
How to define parameters for a price item pricing	Defining a Parameter for a Price Item Pricing on page 579
How to define TFM Information in a price item pricing	Defining TFM Information in a Price Item Pricing on page 491

Assigning a Price Item to a Person

Note: This topic is not applicable for the health insurance business.



Prerequisites

To assign a price item to a person, you should have:

- Transactions mapped to the price item defined in the application
- Rate schedules, rate versions, and rate components defined in the application
- Parameters associated with the price item (in case you want to define price item pricing based on multiple parameters)

Procedure

To assign a price item to a person:

1. Search for the person in the **Customer 360° View** screen.
2. In the **Search Results** section, click the **Show Context Menu** () icon corresponding to the person whose details you want to view.
A menu appears.
3. Click the **Go To Effective Pricing** menu option.
The **Pricing (Person)** screen appears.
4. Search for the price item that you want to assign to the person in the **Search Price Item or Price Item Pricing** zone.
5. In the **Search Results** section, click the **Assign** () icon in the **Assign** column corresponding to the price item that you want to assign to the person.

The **Price Item Pricing** screen appears. It contains the following sections:

- **Main** – Used to specify basic details about the price item pricing.
- **TFM Information** – Used to specify the transaction feed management information about the price item pricing.

Note: This section appears in the **Price Item Pricing** screen when the value for the **Show Default Values in Price Item Pricing** option type for **C1_FM** feature configuration is set to **Y** and **Price Item Available For** is **Pricing and Billing**.

- **Characteristics** – Used to define the characteristics for the price item pricing.

- **Price Item and Parameter Information** – Used to define the parameter details segment for the price item pricing.

Note: This section appears when **Price Assignment Type** is **Processing**.

The **Main** section contains the following fields:

Field Name	Field Description	Mandatory (Yes or No)
Start Date	Used to specify the date from when the price item pricing is effective.	Yes
	<p>Note:</p> <p>By default, the current system date appears in this field.</p> <p>The effective start date cannot be later than the effective end date.</p>	
End Date	Used to specify the date till when the price item pricing is effective.	No
	<p>Note: The effective end date cannot be earlier than the effective start date.</p>	
Price Assignment Type	<p>Used to indicate the type of price assignment. The valid values are:</p> <ul style="list-style-type: none"> • Regular – Used to indicate that the pricing must be used to generate regular bill segment. • Post Processing – Used to indicate that the pricing must be used to generate post processing bill segment. This type of price assignment can be done on usage accounts. The post processing bill segment is generated when you generate the bill for the usage account and not when you bill the usage account through an invoice account. <p>Note:</p> <p>The post processing bill segment is generated when the Post Processing Sequence (PPSEQ) characteristic is defined for the price item and when the price item is associated with another price item using the Price Item relationship type.</p> <ul style="list-style-type: none"> • Post Processing – Invoice Based – Used to indicate that the pricing must be used to generate post processing bill segment. This type of price assignment can be done on an invoice account, and, as a result, the post processing bill segment is generated on the invoice account. <p>Note: This will not be applicable for price item which are defined for Only Pricing.</p> <ul style="list-style-type: none"> • Post Processing – Price Item Based – Used to indicate that the pricing must be used to generate 	Yes

Field Name	Field Description	Mandatory (Yes or No)
	<p>post processing bill segment. This type of price assignment can be done on both invoice and usage accounts, but the post processing bill segment is generated only on the invoice account.</p> <p>Note: This will not be applicable for price item which are defined for Only Pricing.</p>	
Pricing Eligibility	Used to select pricing eligibility criteria for price item pricing.	No
Pricing Status	<p>Used to indicate the status of the price assignment. The valid values are:</p> <ul style="list-style-type: none"> • Draft – Indicates that the price assignment is created as a draft. • Proposed – Indicates that the price assignment is used for quotations. 	Yes
Pricing Currency	Used to indicate the currency in which you want to define the price item pricing.	Yes
Rate Schedule	<p>Used to specify the rate schedule that you want to use while defining price item pricing.</p> <p>Note: Rate schedules control how the bills for the price item will be calculated.</p> <p>The Search (🔍) icon appears corresponding to this field. On clicking the Search icon, the Rate Schedule Search screen appears.</p>	Yes
Pricing Rule Type	<p>Used to indicate the pricing rule type. The valid value is:</p> <ul style="list-style-type: none"> • Two-Dimensional 	<p>Yes (Conditional)</p> <p>Note: This field is required when you are defining a two-dimensional pricing rule.</p>
Print Zero	<p>Used to indicate whether zero pricing should be displayed in the bill. The valid values are:</p> <ul style="list-style-type: none"> • Yes • No <p>Note: By default, Yes is selected.</p>	Yes
Pricing Frequency	<p>Used to indicate pricing frequency for the price item.</p> <p>Note: This field appears when Price Item is defined as Only Pricing and Price Item Type is defined as Fees.</p>	Yes

6. Enter the required details in the **Main** section.

7. Define TFM Information in a price item pricing, if required.
8. Define characteristics for a price item pricing, if required.
9. Define parameters for a price item pricing, if required.
10. Click **Save**.

The pricing is defined for the price item.

Note: A bundle cannot be assigned if its child price items are already assigned to a person and vice versa, in the same date range.

Related Topics

For more information on...	See...
How to search for a person	Searching for a Person on page 203
Pricing (Person) screen	Pricing (Person) on page 582
Search Price Item or Price Item Pricing zone	Search Price Item or Price Item Pricing on page 587
How to define a characteristic for a price item pricing.	Defining a Characteristic for a Price Item Pricing on page 492
How to define parameters for a price item pricing.	Defining a Parameter for a Price Item Pricing on page 579
How to define TFM Information in a price item pricing.	Defining TFM Information in a Price Item Pricing on page 491

Defining a Characteristic for a Price Item Pricing

Note: This topic is not applicable for the health insurance business.

Prerequisites

To define a characteristic for a price item pricing, you should have:

- Characteristic types defined in the application (where the characteristic entity is set to **Price Item**)

Procedure

To define a characteristic for a price item pricing:

1. Ensure that the **Characteristics** section is expanded when you are defining, editing, or overriding a price item pricing.

The **Characteristics** section contains the following fields in a grid:

Field Name	Field Description	Mandatory (Yes or No)
Effective Date	Used to specify the date from when the characteristic is effective for the price item pricing.	Yes (Conditional)
		Note: This field is required while defining a characteristic for the price item pricing.
Characteristic Type	Used to indicate the characteristic type.	Yes (Conditional)

Field Name	Field Description	Mandatory (Yes or No)
	Note: The list includes only those characteristic types where the characteristic entity is set to Price Item .	Note: This field is required while defining a characteristic for the price item pricing.
Characteristic Value	Used to specify the value for the characteristic type.	Yes (Conditional)
	Note: If you select a predefined characteristic type, the Search (🔍) icon appears corresponding to the Characteristic Value field. On clicking the Search icon, the Predefined Characteristic Search window appears. On specifying the value for a predefined characteristic type, the description of the characteristic value appears corresponding to the Characteristic Value field.	Note: This field is required while defining a characteristic for the price item pricing.

- Enter the required details in the **Characteristics** section.
- If you want to define more than one characteristic for the price item pricing, click the **Add** (+) icon and then repeat step 2.

Note: However, if you want to remove a characteristic from the price item pricing, click the **Delete** (🗑️) icon corresponding to the characteristic.

- Click **Save**.

The characteristic is defined for the price item pricing.

Related Topics

For more information on...	See...
How to define a price item pricing	Defining a Price Item Pricing on page 626
How to edit a price item pricing	Editing a Price Item Pricing on page 678
How to override a price item pricing	Overriding a Price Item Pricing on page 691

Defining a Parameter for a Price Item Pricing

Prerequisites

To define parameters for a price item pricing, you should have:

- Parameters associated with the price item, in case, you want to define price item pricing based on multiple parameters

Procedure

To define parameter details segment for a price item pricing that is assigned to an account:

- Ensure that the **Price Item and Parameter Information** section is expanded when you are defining a price item pricing.

The **Price Item and Parameter Information** section contains the following field:

Field Name	Field Description
Price Item	Indicates the price item or price item bundle whose pricing details are listed in this section.

In addition, this section contains a grid which has the following columns:

Column Name	Column Description	Mandatory (Yes or No)
Parameter	Used to indicate the parameter that you want to associate with the price item pricing.	Yes
	Note: The Search (🔍) icon appears corresponding to this field. On clicking the Search icon, the Price Item Parameter Search window appears. The parameter search results displays only those parameters where the Price Item check box is selected.	
Parameter Information	Displays a comma-separated string which contains of the following: <ul style="list-style-type: none"> Parameter Description Mandatory (Yes or No) Priority 	Not applicable
Parameter Value	Used to specify the value of the parameter.	Yes

- Enter the required details in the **Price Item and Parameter Information** section.
- If you want to define more than one parameter information for the price item pricing, click the **Add** (+) icon and then repeat step 2.

Note: However, if you want to remove a parameter information from the price item pricing, click the **Delete** (🗑️) icon corresponding to the parameter.

- Click **Save**.

The parameters are defined for the price item pricing.

Related Topics

For more information on...	See...
How to define a price item pricing	Defining a Price Item Pricing on page 626
How to edit a price item pricing	Editing a Price Item Pricing on page 678
How to override a price item pricing	Overriding a Price Item Pricing on page 691

Defining TFM Information in a Price Item Pricing

Note: This topic is not applicable for the health insurance business.

Prerequisites

To define the TFM information in a price item pricing, you should have:

- Transactions mapped to the price item defined in the application

- Aggregation or rating criteria to be defined for the price item pricing

Procedure

To define the TFM information in a price item pricing:

1. Ensure that the **TFM Information** section is expanded when you are defining, editing, or overriding a price item pricing.

The **TFM Information** section contains the following fields:

Field Name	Field Description	Mandatory (Yes or No)
Ignore Transaction	Used to indicate whether the transactions mapped to the price item are considered for billing or not. The valid values are: <ul style="list-style-type: none"> • Yes • No 	Yes (Conditional)
		Note: This field is required while defining the TFM information in a price item pricing.
	Note: By default, the No option is selected.	
Aggregate Transactions	Used to indicate whether aggregation is required while rating the transactions mapped to the price item pricing before billing. The valid values are: <ul style="list-style-type: none"> • Yes - Indicates that aggregation is required while rating the transactions mapped to the price item pricing before billing. • No - Indicates that aggregation is not required while rating the transactions mapped to the price item pricing before billing. 	Yes (Conditional)
		Note: This field is required while defining the TFM information in a price item pricing.
	Note: By default, the Yes option is selected.	
Aggregation Schedule	Used to indicate the transaction aggregation cycle. The valid values are: <ul style="list-style-type: none"> • Daily • Weekly • Monthly • Quarterly • Yearly 	Yes (Conditional)
		Note: This field is required while defining the TFM information in a price item pricing.
Transaction Rating Criteria	Used to indicate how and when the transaction legs mapped to the price item are rated. The valid values are: <ul style="list-style-type: none"> • Aggregate Transactions and Then Rate Aggregated SQs • Do Not Rate Transactions • Rate Transaction and Aggregate Calc Lines 	Yes (Conditional)
		Note: This field is required while defining the TFM information in a price item pricing.

Field Name	Field Description	Mandatory (Yes or No)
	Note: By default, the Do Not Rate Transactions option is selected.	

- Enter the required details in the **TFM Information** section.

Note: **TFM Information** section appears when the value for **Show Default Values in Price Item Pricing** option type of **C1_FM feature configuration** is set to **Y** and **Price Item Available For** is **Pricing and Billing**.

- Click **Save**.

The TFM information is defined in the price item pricing.

Related Topics

For more information on...	See...
How to define a price item pricing	Defining a Price Item Pricing on page 626
How to edit a price item pricing	Editing a Price Item Pricing on page 678
How to override a price item pricing	Overriding a Price Item Pricing on page 691

Price Item Pricing (Used for Viewing)

Note: This topic is not applicable for the health insurance business.

Once the pricing is defined for a price item pricing which is assigned to an account, person, or price list, the **Price Item Pricing** screen allows you to:

- Edit the details of a price item pricing
- Delete a price item pricing
- Submit a price item pricing for processing
- View the details of price components of the rate component
- View the details of tiering criteria, pricing eligibility criteria of a price component
- Add price components of the rate components
- Add tiering components, pricing eligibility criteria of the price components
- Edit price components, tiering criteria, pricing eligibility criteria
- Delete price components, tiering criteria, pricing eligibility criteria

Note:

When the price assignment is in **Draft** status and when:

- Approval Workflow is off then status is changed from **Draft** to **Active**.
- Approval Workflow is on then status is changed from **Draft** to **Pending in Approval**.

The **Price Item Pricing** screen contains the following zones:

- [Price Item Pricing](#) on page 615
- [Price Item Pricing](#) on page 616
- [Price Assignment Tree](#) on page 448

- [Price Component](#) on page 622

Note: By default, the **Price Component** zone does not appear in the **Price Item Pricing** screen. It appears only when you click the **Add (+)** icon corresponding to the rate component in the **Price Assignment Tree** zone and when the status of the price item pricing is **Draft, Proposed, or Template**.

- [Two-Dimensional Pricing](#) on page 625

Note: The **Two-Dimensional Pricing** zone appears in the **Price Item Pricing** screen only when the **Two-Dimensional** option is selected from the **Pricing Rule Type** field while defining the price item pricing.

Price Item Pricing

Note: This topic is not applicable for the health insurance business.

The **Price Item Pricing** zone displays the basic information about the price item pricing. It contains the following sections:

- **Pricing Information** - Displays information about the price item pricing. It contains the following fields:

Field Name	Field Description
Pricing Status	Indicates the current status of the price item pricing. The valid values are: <ul style="list-style-type: none"> • Draft – Indicates that the price assignment is created as a draft. • Active – Indicates that the price assignment is used for billing. • Inactive – Indicates that the price assignment is no longer used for billing. • Proposed – Indicates that the price assignment is to be used for quotations. • Rejected – Indicates that the price assignment is rejected in the system. • Template – Indicates that the price assignment is a template price list.
Pricing Currency	Indicates the currency in which the price item pricing is defined. <p>Note: It has a link. On clicking the link, the Currency screen appears where you can view the details of the currency.</p>

- **Record Actions** – The **Record Actions** section contains the following buttons:

Button Name	Button Description
Edit	Used to edit the details of the price item pricing. <p>Note: The Edit button appears only when the price item pricing is in the Draft status.</p>
Delete	Used to delete the price item pricing. <p>Note: The Delete button appears only when the price item pricing is in the Draft status.</p>
Submit	Used to submit the price item pricing for validation and processing.

Button Name	Button Description
	Note: The Submit button appears only when the price item pricing is in the Draft status.

Price Item Pricing

Note: This topic is not applicable for the health insurance business.

The **Price Item Pricing** zone displays the details of the price item pricing. It contains the following sections:

- **Pricing Information** - Displays basic information about the pricing of the price item. It contains the following fields:

Field Name	Field Description
Start Date	Displays the date from when the pricing of the price item is effective.
End Date	Displays the date till when the pricing of the price item is effective.
Price Assignment Type	<p>Indicates the type of price assignment. The valid values are:</p> <ul style="list-style-type: none"> • Post Processing – Indicates that the pricing is used to generate post processing bill segment. This type of price assignment can be done on usage accounts. The post processing bill segment is generated when you generate the bill for the usage account and not when you bill the usage account through an invoice account. • Post Processing – Invoice Based – Indicates that the pricing is used to generate post processing bill segment. This type of price assignment is done on an invoice account, and, as a result, the post processing bill segment is generated on the invoice account. <p>Note: This is not applicable for price items which are defined for Pricing and where the Price Item Type field is set to Fees.</p> <ul style="list-style-type: none"> • Post Processing – Price Item Based – Indicates that the pricing is used to generate post processing bill segment. This type of price assignment is done on both invoice and usage accounts, but the post processing bill segment is generated only on the invoice account. • Regular – Indicates that the pricing is used to generate regular bill segment. <p>Note:</p> <p>This field is not applicable for price items which are defined for Pricing and where the Price Item Type field is set to Fees.</p> <p>By default, the Regular option is selected in the Price Assignment Type field for price item which are applicable for Pricing and cannot be edited.</p> <p>The post processing bill segment is generated when the Post Processing Sequence (PPSEQ) characteristic is defined for the price item and when the price item is associated with another price item using the Price Item relationship type.</p>
Pricing Eligibility	Indicates whether the pricing eligibility criteria is defined for the price item or not.

Field Name	Field Description
Pricing Status	<p>Indicates the pricing assignment status of the price item pricing. The valid values are:</p> <ul style="list-style-type: none"> • Draft – Indicates that the price assignment is created as a draft. • Active – Indicates that the price assignment is used for billing. • Inactive – Indicates that the price assignment is no longer used for billing. • Proposed – Indicates that the price assignment is to be used for quotations. • Rejected – Indicates that the price assignment is rejected. • Template – Indicates that the price assignment is a template price list.
Pricing Currency	<p>Indicates the currency in which the price item pricing is defined.</p> <p>Note: It has a link. On clicking the link, the Currency screen appears where you can view the details of the currency.</p>
Rate Schedule	<p>Indicates the rate schedule that is used to define the price item pricing.</p> <p>Note: It has a link. On clicking the link, the Rate Schedule screen appears where you can view the details of the rate schedule.</p>
Pricing Rule Type	<p>Indicates the pricing rule type. The valid value is:</p> <ul style="list-style-type: none"> • Two-Dimensional <p>Note:</p> <p>If you select the Two-Dimensional option from the Pricing Rule Type list, you can define two-dimensional pricing for the price item.</p> <p>However, if you do not select the Two-Dimensional option from the Pricing Rule Type list, you can define traditional flat, step, or tiered pricing for the price item.</p> <p>Also, you need to select the Pricing Eligibility option while defining a two-dimensional pricing for the price item.</p>
Print Zero	<p>Indicates the zero pricing displayed in the bill. The valid values are:</p> <ul style="list-style-type: none"> • Yes • No
Price Assignment Usage	<p>Indicates whether the price item pricing is applicable to all customers or only to new customers. The valid values are:</p> <ul style="list-style-type: none"> • All Customers • New Customers <p>Note: This field appears when you are viewing the details of a price item pricing assigned to a price list.</p>
Pricing Frequency	Indicates the pricing frequency for the price item.

Field Name	Field Description
	Note: This field appears when you select the Price Item Usage as Pricing and Price Item Type as Fees while defining the price item.

- **TFM Information** – Displays the transaction feed management information mapped to the price item pricing. It contains the following fields:

Field Name	Field Description
Ignore Transaction	Indicates whether the transactions mapped to the price item pricing are considered for billing or not. The valid values are: <ul style="list-style-type: none"> • Yes • No
Do Not Aggregate Switch	Indicates whether aggregation is required while rating the transactions mapped to the price item pricing before billing. The valid values are: <ul style="list-style-type: none"> • Yes - Indicates that aggregation is not required while rating the transactions mapped to the price item pricing before billing. • No - Indicates that aggregation is required while rating the transactions mapped to the price item pricing before billing.
Aggregation Schedule	Indicates the transaction aggregation cycle. The valid values are: <ul style="list-style-type: none"> • Daily • Weekly • Monthly • Quarterly • Yearly
Transaction Rating Criteria	Indicates how and when the transaction legs mapped to the price item pricing are rated. The valid values are: <ul style="list-style-type: none"> • Aggregate Transactions and Then Rate Aggregated SQs • Do Not Rate Transactions • Rate Transaction and Aggregate Calc Lines

Note:

TFM Information section appears when the value for **Show Default Values in Price Item Pricing** option type of **C1_FM feature configuration** is set to **Y** and **Price Item Usage** field is set to **Pricing and Billing**.

TFM Information section does not appear when the **Price Item Usage** field is set to **Only Pricing** and the **Price Item Type** field is set to **Fees**, then, only the **Pricing Frequency** field appears.

- **Characteristics** – Lists the characteristics defined for the price item pricing. It contains the following columns:

Column Name	Column Description
Effective Date	Displays the date from when the characteristic is effective for the price item pricing.
Characteristic Type	Indicates the characteristic type.

Column Name	Column Description
Characteristic Value	Displays the value of the characteristic type.

- **Deal Information** – Displays information about how the average price floor and ceil limits of the price item pricing is mapped to a deal. It contains the following field:

Field Name	Field Description
Average Price Floor and Ceil Type	<p>Indicates the manner in which the average price floor and ceil limits of the price item pricing is defined for the deal. The valid values are:</p> <ul style="list-style-type: none"> • Absolute Value Range - Indicates that the average price floor and ceil limits for the price item pricing is defined using absolute values. • Spread Amount - Indicates that the average price floor and ceil limits for the price item pricing is defined based on the spread amount. • Spread Percentage - Indicates that the average price floor and ceil limits for the price item pricing is defined based on the spread percentage. <p>Note: In case of Spread Amount and Spread Percentage options, the system calculates the average price of a price item and based on the average price and the spread amount or spread percentage the average floor and ceil limits are derived.</p>

- **Price Item and Parameter Information** – Lists the parameters based on which the price item pricing is defined. It contains the following field:

Field Name	Field Description
Price Item	<p>Displays the concatenated string of information about the price item or price item bundle for which the pricing is defined separated by a comma (.).</p> <p>Note: It has a link. On clicking the link, the Price Item screen appears where you can view the details of the price item.</p>

In addition, this section contains the following columns:

Column Name	Column Description
Parameter	Indicates the parameter that is associated with the price item pricing.
Parameter Value	Displays the value of the parameter.

- **Division-Specific SQIs for Price Item** - Lists the SQIs associated with the price item pricing for a particular division. It contains the following columns:

Column Name	Column Description
SQI	<p>Displays the SQI associated with the price item for pricing.</p> <p>Note: It has a link. On clicking the link, the Service Quantity Identifier screen appears where you can view the details of the respective SQI.</p>
Daily Service Quantity	Displays the SQI usage for a single day.

Column Name	Column Description
Usage Period	Displays the duration for which the SQI is associated with the price item for pricing.
Division	Indicates the division for which the SQI is associated with the price item for pricing.

- **Division-Specific Floor and Ceil Values for Price Item** - Lists the average price floor and ceil limits of the price item pricing defined for a particular division. It contains the following columns:

Column Name	Column Description
To Do Role	Indicates the users with the specified To Do role who can approve the average price of the price item in the price item pricing when it is within the specified floor and ceil limits. Note: It has a link. On clicking the link, the To Do Role screen appears where you can view the details of the respective To Do role.
Ceil Value	Displays the ceil (i.e. upper) limit of the To Do role for approving the average price of the price item in the price item pricing. Note: This column appears when the Absolute Value Range option is selected from the Average Price Floor and Ceil Type list while defining the deal information in the price item pricing.
Floor Value	Displays the floor (i.e. lower) limit of the To Do role for approving the average price of the price item in the price item pricing. Note: This column appears when the Absolute Value Range option is selected from the Average Price Floor and Ceil Type list while defining the deal information in the price item pricing.
Currency Code	Indicates the currency in which the average price floor and ceil limits are defined for the price item pricing. Note: It has a link. On clicking the link, the Currency screen appears where you can view the details of the respective currency.
Spread Amount	Displays the spread amount of the To Do role for approving the average price of the price item in the price item pricing. Note: This column appears when the Spread Amount option is selected from the Average Price Floor and Ceil Type list while defining the deal information in the price item pricing.
Spread Percentage	Displays the spread percentage of the To Do role for approving the average price of the price item in the price item pricing. Note: This column appears when the Spread Percentage option is selected from the Average Price Floor and Ceil Type list while defining the deal information in the price item pricing.
Division	Indicates the division for which the average price floor and ceil values of the price item in the price item pricing is defined.

- **Division-Specific Cost for Price Item** - Lists the costs of the price item pricing defined for a particular division. It contains the following columns:

Column Name	Column Description
Cost Type	Indicates the type of cost incurred in the division for the price item pricing. The valid values are: <ul style="list-style-type: none"> • Additional Fixed Cost • Additional Variable Cost • Fixed Third Party Cost • Fixed Internal Cost • Variable Internal Cost • Variable Third Party Cost
Cost Value	Displays the cost amount.

Note: By default, the **Pricing Currency** is considered as the currency code in which the cost is specified.

- **Division-Specific Negotiability Floor and Ceil Values for Price Item** - Lists the negotiability floor and ceil limits of the price item pricing defined for a particular division. It contains the following columns:

Column Name	Column Description
Division	Indicates the division for which the negotiability floor and ceil limits of the price item pricing is defined.
Floor Value	Displays the floor (i.e. lower) limit for the rate negotiation.
Ceil Value	Displays the ceil (i.e. upper) limit for the rate negotiation.

Note: By default, the **Pricing Currency** is considered as the currency code in which the negotiability floor and ceil limits of the price item pricing is defined.

- **Record Information** – The **Record Information** section contains the following field:

Field Name	Field Description
Business Object	Indicates the business object using which the price item pricing is defined in the system. In addition, a context menu appears corresponding to this field which helps in navigating to other screens in the application.
	Note: It has a link. On clicking the link, the Business Object screen appears where you can view the details of the respective business object.

Price Assignment Tree

Note: This topic is not applicable for the health insurance business.

The **Price Assignment Tree** zone displays the details about the rate components and its price components for the price item along with the tiering criteria and pricing eligibility details.

It also allows you to do the following:

- Define, edit, copy, or delete the price component of the rate component

Note: You can define, edit, copy, or delete the price component of the rate component when the price item pricing is in **Draft, Proposed, or Template** status.

- Define, edit, copy, or delete the tiering criteria of the price component

Note: You can define, edit, copy, or delete the tiering criteria of the price component when the price item pricing is in **Draft, Proposed, or Template** status.

- Define, edit, copy, or delete the pricing eligibility criteria of the price component

Note: You can define, edit, copy, or delete the eligibility criteria of the price component when the price item pricing is in **Draft, Proposed, or Template** status.

Note: You cannot define, edit, copy, or delete a price component when you are accessing the **Price Assignment Tree** zone from the **Price List** screen.

Related Topics:

For more information on...	See...
How to view a price component of a rate component in a price item pricing	Viewing the Price Components of a Rate Component on page 641
How to view a tiering criteria of a price component	Viewing the Tiering Criteria of a Price Component on page 643
How to view a pricing eligibility criteria of a price component	Viewing the Pricing Eligibility Criteria of a Price Component on page 645
How to define price component of a rate component in a price item pricing	Defining a Price Component for a Rate Component on page 647
How to edit a price component of a rate component in a price item pricing	Editing a Price Component on page 658
How to copy a price component of a rate component in a price item pricing	Copying a Price Component on page 662
How to delete a price component of a rate component in a price item pricing	Deleting a Price Component on page 666
How to define tiering criteria of a price component in a price item pricing	Defining a Tiering Criteria for a Price Component on page 652
How to define pricing eligibility criteria of a price component in a price item pricing	Defining a Pricing Eligibility Criteria for a Price Component on page 654

Price Component

Note: This topic is not applicable for the health insurance business.

The **Price Component** zone displays information about the price component of the rate component for the price item pricing that is assigned to an account, person, or price list. It contains the following fields:

Field Name	Field Description
Rate Component Information	Displays a comma-separated string which consists of the following: <ul style="list-style-type: none"> • Rate Component Sequence

Field Name	Field Description
	<ul style="list-style-type: none"> Tiering Type of the Rate Component
Display Sequence	Displays the sequence of price component whose rate is used for calculating the pricing of the price item
Show Price Component	Indicates whether the price component is displayed in the bill.
Description	Displays the description of the price component.
Rate	Indicates the rate defined for the price component.
Save	On clicking the Save button, the Price Component zone saves the changes you made for the price component.
Clear	On clicking the Clear button, the changes you made to the price component are discarded.
Close	On clicking the Close button, the Price Component zone is closed.

In addition, the **Price Component** zone contains the following buttons:

Button Name	Button Description
Save	Used to save the changes made to the price component.
Clear	Used to discard the changes made to the price component.
Close	Used to close the Price Component zone.

By default, the **Price Component** zone does not appear in the **Price Item Pricing** screen. It appears when you click the **Add (+)** icon corresponding to a rate component in the **Price Assignment Tree** zone.

On clicking the **Show Price Component Tier** link, the **Tiering Criteria** section appears in the **Price Component** zone with the details of the respective tiering criteria of the price component.

The **Tiering Criteria** section contains the following fields in a grid:

Field Name	Field Description
Display Sequence	Displays the sequence number of the tiering criteria.
Tiering Criterion	Indicates the tiering criterion which is used in the tiering range.
Lower Limit	Displays the lower limit of the tiering range.
Upper Limit	Displays the upper limit of the tiering range.
Price Item	Displays the price item.
Price Item Parameters	Displays information about the parameter associated with the price item for the tier.
	<p>Note: The Edit (✎) icon appears corresponding to the Price Item Parameters field. On clicking the Edit icon, the Tier Parameters section appears where you can add, edit, or delete the price item parameters for the tier.</p>

Note: The **Tiering Criteria** section appears in the **Price Component** zone only when the **Tiering Type** of the rate component is **STEP** or **Threshold**.

On clicking the **Show Price Component Eligibility** link, the **Pricing Eligibility Criteria** section appears in the **Price Component** zone with the details of the respective pricing eligibility criteria of the price component.

The **Pricing Eligibility Criteria** section contains the following fields in a grid:

Field Name	Field Description
Display Sequence	Indicates the sequence number in which the pricing eligibility criteria is executed in the rule.
Parameter	Displays the left hand side parameter which is used along with the price item for price determination.
Operator	Indicates the relational operator used to define the relation between the parameter name and the parameter value. The valid values are: <ul style="list-style-type: none"> • < • <= • <> • = • > • >= • Between • In • Like • Not In
Parameter Value Type	Indicates whether the parameter (on the left hand side) is compared against another parameter (on the right hand side) or directly against a parameter value. The valid values are: <ul style="list-style-type: none"> • Parameter - Indicates that the parameter (on the left hand side) is compared against another parameter (on the right hand side). • Value - Indicates that the parameter (on the left hand side) is compared against a parameter value.
Parameter	Indicates the parameter (on the right hand side) against which you want to compare the parameter (on the left hand side).
Parameter Value	Indicates the parameter value against which you want to compare the parameter (on the left hand side).
Is True	Indicates what happens when the condition is true (satisfied). The valid values are: <ul style="list-style-type: none"> • Check Next Condition – Indicates that the condition with consecutive sequence number is executed. • Rule Is False – Indicates that the action specified in the Rule False Action field is executed. • Rule Is True – Indicates that the action specified in the Rule True Action field is executed.
Is False	Indicates what happens when the condition is false (not satisfied). The valid values are: <ul style="list-style-type: none"> • Check Next Condition – Indicates that the condition with consecutive sequence number is executed.

Field Name	Field Description
	<ul style="list-style-type: none"> • Rule Is False – Indicates that the action specified in the Rule False Action field is executed • Rule Is True – Indicates that the action specified in the Rule True Action field is executed.
Is Insufficient	<p>Indicates what happens when the data is insufficient. The valid values are:</p> <ul style="list-style-type: none"> • Check Next Condition – Indicates that the condition with consecutive sequence number is executed. • Rule Is False – Indicates that the action specified in the Rule False Action field is executed • Rule Is True – Indicates that the action specified in the Rule True Action field is executed.

Note: The **Pricing Eligibility Criteria** section appears in the **Price Component** zone only when the **Pricing Eligibility** check box is selected in the **Price Item Pricing** screen.

Related Topics

For more information on...	See...
Price Item Pricing screen	Price Item Pricing (Used for Viewing) on page 614
Price Assignment Tree zone	Price Assignment Tree on page 448
Price Component zone	Price Component on page 622
How to define a price component for a rate component	Defining a Price Component for a Rate Component on page 647
How to define a tiering criteria for a price component	Defining a Tiering Criteria for a Price Component on page 652
How to view the tiering criteria of a price component	Viewing the Tiering Criteria of a Price Component on page 643
How to define a pricing eligibility criteria for a price component	Defining a Pricing Eligibility Criteria for a Price Component on page 654
How to view the pricing eligibility criteria of a price component	Viewing the Pricing Eligibility Criteria of a Price Component on page 645

Two-Dimensional Pricing

Note: This topic is not applicable for the health insurance business.

The **Two-Dimensional Pricing** zone displays the details of the two-dimensional pricing. It contains the following field:

Field Name	Field Description
Pricing Information	Displays the concatenated string of information about the price item pricing for an account, person, or price list separated by a comma (,).

In addition, this zone contains the following fields in a grid:

Field Name	Field Description
Step Criterion	Displays the Price Criteria of the price component
Threshold Parameter	Displays the parameter of the price component eligibility
Tiering Range	Displays the tiering range of the pricing.

Note: The **Two-Dimensional Pricing** zone appears in the **Price Item Pricing** screen only when the **Two-Dimensional** option is selected from the **Pricing Rule Type** field while defining the price item pricing.

Defining a Price Item Pricing

Note: This topic is not applicable for the health insurance business.

Prerequisites

To define pricing for a price item, you should have:



- Transactions mapped to the price item defined in the application
- Rate schedules, rate versions, and rate components defined in the application
- Tiering criteria defined in the application
- Tiering setup for the rate components defined in the application
- Pricing eligibility defined in the application
- Parameters associated with the price item (in case you want to define price item pricing based on multiple parameters)
- Currencies defined in the application

Procedure

To define a price item pricing:

1. Do either of the following:

If you want to...	Then...
Define pricing for a price item that you want assign to a customer	<ol style="list-style-type: none"> 1. Ensure that the Search Price Item or Price Item Pricing zone is expanded in the Pricing (Person) screen when you are defining the price item pricing for a customer. 2. Search for the price item in the Search Price Item or Price Item Pricing zone. 3. In the Search Results section, click the Assign  icon in the Assign column corresponding to the price item that you want to assign to the customer.
Define pricing for a price item that you want assign to an account	<ol style="list-style-type: none"> 1. Ensure that the Search Price Item or Price Item Pricing zone is expanded in the Pricing (Account) screen when you are defining the price item pricing for an account.

If you want to...	Then...
	<ol style="list-style-type: none"> 2. Search for the price item in the Search Price Item or Price Item Pricing zone. 3. In the Search Results section, click the Assign  icon in the Assign column corresponding to the price item that you want to assign to the account.
Define pricing for a price item that you want assign to a price list	<ol style="list-style-type: none"> 1. Ensure that the Search Price Item or Price Item Pricing zone is expanded in the Price List Price Item Pricing screen when you are defining the price item pricing for a price list. 2. Search for the price item in the Search Price Item or Price Item Pricing zone. 3. In the Search Results section, click the Assign  icon in the Assign column corresponding to the price item that you want to assign to the price list.

The **Price Item Pricing** screen appears. It contains the following sections:

- **Main** - Used to specify basic details about the price item pricing.
- **Deal Information** - Used to specify how the average price floor and ceil limits of the price item pricing is mapped to a deal.
- **TFM Information** - Used to specify the transaction feed management information mapped to the price item pricing..

Note: This section appears in the **Price Item Pricing** screen when the value for the **Show Default Values in Price Item Pricing** option type for **C1_FM** feature configuration is set to **Y** and **Price Item Available For** is **Pricing and Billing**.

- **Characteristics** - Used to define a list of characteristics for the price item pricing.
- **Price Item and Parameter Information** - Used to specify the parameters based on which the price item pricing is defined.

Note: This section appears when **Price Assignment Type** is **Regular**.

- **Commitments** - Used to specify the following details about the pricing and commitments for the price item pricing:
 - Division-specific cost for the price item
 - Division-specific floor and ceil values for the price item
 - Division-specific negotiability floor and ceil values for the price item

The **Main** section contains the following fields:

Field Name	Field Description	Mandatory (Yes or No)
Start Date	Used to specify the date from when the pricing of the price item is effective.	Yes

Field Name	Field Description	Mandatory (Yes or No)
	<p>Note:</p> <p>The Start Date cannot be later than the End Date.</p> <p>If you change the start date and the end date while editing a price item pricing, you need to specify the parameters which are effective during that date range.</p> <p>This field will be in read-only mode when the price assignment has been used.</p>	
End Date	<p>Used to specify the date till when the pricing of the price item is effective.</p> <p>Note: The End Date cannot be earlier than the Start Date.</p>	No
Price Assignment Type	<p>Used to indicate the type of price assignment. The valid values are:</p> <ul style="list-style-type: none"> • Post Processing – Used to indicate that the pricing must be used to generate post processing bill segment. This type of price assignment can be done on usage accounts. The post processing bill segment is generated when you generate the bill for the usage account and not when you bill the usage account through an invoice account. <p>Note:</p> <p>The post processing bill segment is generated when the Post Processing Sequence (PPSEQ) characteristic is defined for the price item and when the price item is associated with another price item using the Price Item relationship type.</p> <ul style="list-style-type: none"> • Post Processing – Invoice Based – Used to indicate that the pricing must be used to generate post processing bill segment. This type of price assignment can be done on an invoice account, and, as a result, the post processing bill segment is generated on the invoice account. <p>Note: This will not be applicable for price item which are defined for Only Pricing.</p> <ul style="list-style-type: none"> • Post Processing – Price Item Based – Used to indicate that the pricing must be used to generate post processing bill segment. This type of price assignment can be done on both invoice and usage accounts, but the post 	Yes

Field Name	Field Description	Mandatory (Yes or No)
	<p>processing bill segment is generated only on the invoice account.</p> <div style="border: 1px solid black; padding: 2px;"> <p>Note: This will not be applicable for price item which are defined for Only Pricing.</p> </div> <ul style="list-style-type: none"> • Used to define the pricing eligibility criteria for the price item pricing. <p>Used to define the pricing eligibility criteria for the price item pricing.</p> <p>Regular – Used to indicate that the pricing must be used to generate regular bill segment.</p> <div style="border: 1px solid black; padding: 2px;"> <p>Note: By default, the Regular option is selected in the Price Assignment Type field. This field is not applicable for price items which are defined for Pricing and where the Price Item Type field is set to Fees.</p> </div>	
Pricing Eligibility	<p>Used to define the pricing eligibility criteria for the price item.</p> <div style="border: 1px solid black; padding: 2px;"> <p>Note: If you select the check box you can define the pricing eligibility criteria of the price item in the Price Component zone.</p> </div>	<p>Yes (Conditional)</p> <div style="border: 1px solid black; padding: 2px;"> <p>Note: This field is required while defining the pricing eligibility criteria of the price item.</p> </div>
Pricing Status	<p>Used to indicate the status of the price assignment. The valid values are:</p> <ul style="list-style-type: none"> • Draft – Used to indicate that the price assignment is created as a draft. • Active – Used to indicate that the price assignment is used for billing. • Inactive – Used to indicate that the price assignment is no longer used for billing. • Proposed – Used to indicate that the price assignment is to be used for quotations. • Template – Used to indicate that the price assignment is a template price list. <div style="border: 1px solid black; padding: 2px;"> <p>Note: If a price assignment is in Active status, you can change its status to Inactive. If a price assignment is in Draft status, you cannot change its status to Proposed.</p> </div>	Yes

Field Name	Field Description	Mandatory (Yes or No)
Pricing Currency	Used to indicate the currency in which you want to define the price item pricing.	Yes
Rate Schedule	Used to specify the rate schedule that you want to use while defining price item pricing. Note: Rate schedules controls how the bills for the price item will be calculated. The Search (🔍) icon appears corresponding to the Rate Schedule field. On clicking the Search icon, the Rate Schedule Search screen appears.	Yes
Pricing Rule Type	Used to indicate the pricing rule type. The valid value is: <ul style="list-style-type: none">Two-Dimensional Note: If you select the Two-Dimensional option from the Pricing Rule Type list, you can define two-dimensional pricing for the price item. However, if you do not select the Two-Dimensional option from the Pricing Rule Type list, you can define traditional flat, step, or tiered pricing for the price item. Also, you need to select the Pricing Eligibility option check box while defining a two-dimensional pricing for the price item.	Yes (Conditional) Note: This field is required for defining a two-dimensional pricing rule.
Print Zero	Used to indicate whether zero pricing should be displayed in the bill. The valid values are: <ul style="list-style-type: none">YesNo Note: By default, Yes is selected.	Yes
Price Assignment Usage	Used to indicate whether the price item pricing is applicable to all customers or only to new customers. The valid values are: <ul style="list-style-type: none">All CustomersNew Customers Note: By default, the All Customers option is selected. This field appears when you are defining a price item pricing which you want to assign to a price list.	Yes

Field Name	Field Description	Mandatory (Yes or No)
Pricing Frequency	Used to indicate pricing frequency for the price item.	Yes
	Note: This field appears when you select the Price Item Usage as Pricing and Price Item Type as Fees while defining the price item.	

2. Enter the required details in the **Main** section.
3. Define the deal information for the price item pricing in the **Deal Information** section.
4. Define the transaction feed management information for the price item pricing in the **TFM Information** section.
5. Define the characteristics for the price item pricing in the **Characteristics** section.
6. Define parameters for the price item pricing in the **Price Item and Parameter Information** section.
7. Define the division-specific cost of the price item in the **Commitments** section, if required.
8. Define the division-specific average price floor and ceil limits of the price item in the **Commitments** section, if required.
9. Define the division-specific rate negotiability floor and ceil limits of the price item in the **Commitments** section, if required.
10. Click **Save**

The pricing item pricing is defined.

Related Topics

For more information on...	See...
Pricing (Person) screen	Pricing (Person) on page 582
Search Price Item or Price Item Pricing zone	Search Price Item or Price Item Pricing on page 587
Pricing (Account) screen	Pricing (Account) on page 550
Search Price Item or Price Item Pricing zone	Search Price Item or Price Item Pricing on page 555
Price List Price Item Pricing screen	Price List Price Item Pricing on page 468
Search Price Item or Price Item Pricing zone	Search Price Item or Price Item Pricing on page 470
Price Item Pricing screen	Price Item Pricing (Used for Viewing) on page 614
How to define the deal Information in a price item pricing.	Defining the Deal Information in a Price Item Pricing on page 490
How to define the TFM Information in a price item pricing.	Defining TFM Information in a Price Item Pricing on page 491
How to define a characteristic for a price item pricing.	Defining a Characteristic for a Price Item Pricing on page 492
How to define a parameter for a price item pricing.	Defining a Parameter for a Price Item Pricing on page 579
How to define a division-specific cost of a price item in the price item pricing	Defining the Division-Specific Cost of a Price item in the Price Item Pricing on page 495

For more information on...	See...
How to define a division-specific average price limit of a price item in the price item pricing	Defining the Division-Specific Average Price Limits of a Price item in the Price Item Pricing on page 496
How to define a division-specific rate negotiability limit of a price item in the price item pricing	Defining the Division-Specific Rate Negotiability Limits of a Price item in the Price Item Pricing on page 498

Defining the Deal Information in a Price Item Pricing

Note: This topic is not applicable for the health insurance business.

Procedure

To define the deal information in a price item pricing:

1. Ensure that the **Deal Information** section is expanded when you are defining, editing, or overriding a price item pricing.

The **Deal Information** section contains the following field:

Field Name	Field Description	Mandatory (Yes or No)
Average Price Floor and Ceil Type	Used to indicate the manner in which the average price floor and ceil limits of the price item pricing is defined for the deal. The valid values are: <ul style="list-style-type: none"> • Absolute Value Range - Used to indicate that the average price floor and ceil limits for the price item pricing is defined using absolute values. • Spread Amount - Used to indicate that the average price floor and ceil limits for the price item pricing is defined based on the spread amount. • Spread Percentage - Used to indicate that the average price floor and ceil limits for the price item pricing is defined based on the spread percentage. 	Yes (Conditional)
	Note: Incase of Spread Amount and Spread Percentage options, the system calculates the average price of a price item and based on the average price and the spread amount or spread percentage the average floor and ceil limits of the price item are derived for the deal.	Note: This field is required while defining the average price floor and ceil limits of the price item for the deal.

2. Enter the required details in the **Deal Information** section.
3. Click **Save**.

The deal information is defined for the price item pricing.

Related Topics

For more information on...	See...
How to define a price item pricing	Defining a Price Item Pricing on page 626

For more information on...	See...
How to edit a price item pricing	Editing a Price Item Pricing on page 678
How to override a price item pricing	Overriding a Price Item Pricing on page 691

Defining TFM Information in a Price Item Pricing

Note: This topic is not applicable for the health insurance business.

Prerequisites

To define the TFM information in a price item pricing, you should have:

- Transactions mapped to the price item defined in the application
- Aggregation or rating criteria to be defined for the price item pricing

Procedure

To define the TFM information in a price item pricing:

1. Ensure that the **TFM Information** section is expanded when you are defining, editing, or overriding a price item pricing.

The **TFM Information** section contains the following fields:

Field Name	Field Description	Mandatory (Yes or No)
Ignore Transaction	Used to indicate whether the transactions mapped to the price item are considered for billing or not. The valid values are: <ul style="list-style-type: none"> • Yes • No 	Yes (Conditional)
	Note: By default, the No option is selected.	Note: This field is required while defining the TFM information in a price item pricing.
Aggregate Transactions	Used to indicate whether aggregation is required while rating the transactions mapped to the price item pricing before billing. The valid values are: <ul style="list-style-type: none"> • Yes - Indicates that aggregation is required while rating the transactions mapped to the price item pricing before billing. • No - Indicates that aggregation is not required while rating the transactions mapped to the price item pricing before billing. 	Yes (Conditional)
	Note: By default, the Yes option is selected.	Note: This field is required while defining the TFM information in a price item pricing.
Aggregation Schedule	Used to indicate the transaction aggregation cycle. The valid values are: <ul style="list-style-type: none"> • Daily • Weekly • Monthly 	Yes (Conditional)
		Note: This field is required while defining the TFM information in a price item pricing.

Field Name	Field Description	Mandatory (Yes or No)
	<ul style="list-style-type: none"> Quarterly Yearly 	
Transaction Rating Criteria	<p>Used to indicate how and when the transaction legs mapped to the price item are rated. The valid values are:</p> <ul style="list-style-type: none"> Aggregate Transactions and Then Rate Aggregated SQs Do Not Rate Transactions Rate Transaction and Aggregate Calc Lines <p>Note: By default, the Do Not Rate Transactions option is selected.</p>	<p>Yes (Conditional)</p> <p>Note: This field is required while defining the TFM information in a price item pricing.</p>

- Enter the required details in the **TFM Information** section.

Note: **TFM Information** section appears when the value for **Show Default Values in Price Item Pricing** option type of **C1_FM feature configuration** is set to **Y** and **Price Item Available For** is **Pricing and Billing**.

- Click **Save**.

The TFM information is defined in the price item pricing.

Related Topics

For more information on...	See...
How to define a price item pricing	Defining a Price Item Pricing on page 626
How to edit a price item pricing	Editing a Price Item Pricing on page 678
How to override a price item pricing	Overriding a Price Item Pricing on page 691

Defining a Characteristic for a Price Item Pricing

Note: This topic is not applicable for the health insurance business.

Prerequisites

To define a characteristic for a price item pricing, you should have:

- Characteristic types defined in the application (where the characteristic entity is set to **Price Item**)

Procedure

To define a characteristic for a price item pricing:

- Ensure that the **Characteristics** section is expanded when you are defining, editing, or overriding a price item pricing.

The **Characteristics** section contains the following fields in a grid:

Field Name	Field Description	Mandatory (Yes or No)
Effective Date	Used to specify the date from when the characteristic is effective for the price item pricing.	Yes (Conditional)

Field Name	Field Description	Mandatory (Yes or No)
		Note: This field is required while defining a characteristic for the price item pricing.
Characteristic Type	Used to indicate the characteristic type.	Yes (Conditional)
	Note: The list includes only those characteristic types where the characteristic entity is set to Price Item .	Note: This field is required while defining a characteristic for the price item pricing.
Characteristic Value	Used to specify the value for the characteristic type.	Yes (Conditional)
	Note: If you select a predefined characteristic type, the Search (🔍) icon appears corresponding to the Characteristic Value field. On clicking the Search icon, the Predefined Characteristic Search window appears. On specifying the value for a predefined characteristic type, the description of the characteristic value appears corresponding to the Characteristic Value field.	Note: This field is required while defining a characteristic for the price item pricing.

- Enter the required details in the **Characteristics** section.
- If you want to define more than one characteristic for the price item pricing, click the **Add** (+) icon and then repeat step 2.

Note: However, if you want to remove a characteristic from the price item pricing, click the **Delete** (🗑️) icon corresponding to the characteristic.

- Click **Save**.

The characteristic is defined for the price item pricing.

Related Topics

For more information on...	See...
How to define a price item pricing	Defining a Price Item Pricing on page 626
How to edit a price item pricing	Editing a Price Item Pricing on page 678
How to override a price item pricing	Overriding a Price Item Pricing on page 691

Defining a Parameter for a Price Item Pricing

Note: This topic is not applicable for the health insurance business.

Prerequisites

To define a parameter for a price item pricing, you should have:

- Parameters associated with the price item, in case, you want to define price item pricing based on multiple parameters

Procedure

To define a parameter for a price item pricing:

- Ensure that the **Price Item and Parameter Information** section is expanded when you are defining, editing, or overriding a price item pricing.

The **Price Item and Parameter Information** section contains the following field:

Field Name	Field Description
Price Item	Indicates the price item or price item bundle for whom you want to define a parameter.

In addition, this section contains the following fields in a grid:

Field Name	Field Description	Mandatory (Yes or No)
Parameter	Used to indicate the parameter that you want to associate with the price item pricing. Note: The Search (🔍) icon appears corresponding to the Parameter field. On clicking the Search icon, the Price Item Parameter Search window appears where you can search for the required parameter. The search results displays only those parameters where the Price Item check box is selected.	Yes
Parameter Information	Displays the concatenated string of information about the parameter separated by a comma (,).	Not applicable
Parameter Value	Used to specify the value of the parameter.	Yes

- Enter the required details in the **Price Item and Parameter Information** section.
- If you want to define more than one parameter for the price item pricing, click the **Add** (+) icon and then repeat step 2.

Note: However, if you want to remove a parameter from the price item pricing, click the **Delete** (🗑️) icon corresponding to the parameter.

- Click **Save**.

The parameter is defined for the price item pricing.

Related Topics

For more information on...	See...
How to define a price item pricing	Defining a Price Item Pricing on page 626
How to edit a price item pricing	Editing a Price Item Pricing on page 678

For more information on...	See...
How to override a price item pricing	Overriding a Price Item Pricing on page 691

Defining the Division-Specific Cost of a Price item in the Price Item Pricing

Note: This topic is not applicable for the health insurance business.

Prerequisites

To define the division-specific cost of a price item in the price item pricing you should have:

- Price items or price item bundles associated with the division to which the user belongs

Procedure

To define the division-specific cost of a price item in the price item pricing:

1. Ensure that the **Commitments** section is expanded when you are defining, editing, or overriding a price item pricing.
2. Click the **Add** (⊕) icon in the **Costs** column corresponding to the division for which you want to define the cost of the price item in the price item pricing.

The following fields appear in a grid:

Field Name	Field Description	Mandatory (Yes or No)
Cost Type	Used to indicate the type of cost incurred in the division for the price item pricing. The valid values are: <ul style="list-style-type: none"> • Additional Cost-Fixed • Additional Cost-Variable • Fixed Internal • Fixed Third Party • Variable Internal • Variable Third Party 	Yes (Conditional) Note: This field is required while defining the division-specific cost of the price item in the price item pricing.
Cost Value	Used to specify the cost amount.	Yes (Conditional) Note: This field is required while defining the division-specific cost of the price item in the price item pricing.

Note: By default, the **Pricing Currency** is considered as the currency for defining the division-specific cost of the price item in the price item pricing.

3. Enter the required details in the **Costs** grid.
4. If you want to define more than one division-specific cost of the price item in the price item pricing, click the **Add** (⊕) icon and then repeat step 3.

Note: However, if you want to remove the division-specific cost of the price item from the price item pricing, click the **Delete** (⊗) icon corresponding to the cost.

5. Click **Save**.

The division-specific cost of the price item in the price item pricing is defined.

Related Topics

For more information on...	See...
How to define a price item pricing	Defining a Price Item Pricing on page 626
How to edit a price item pricing	Editing a Price Item Pricing on page 678
How to override a price item pricing	Overriding a Price Item Pricing on page 691

Defining the Division-Specific Average Price Limits of a Price item in the Price Item Pricing

Note: This topic is not applicable for the health insurance business.

Prerequisites

To define the division-specific average price limits of a price item in the price item pricing, you should have:

- To Do roles and currencies defined in the application
- Price items or price item bundles associated with the division to which the user belongs

Procedure

To define the division-specific average price limits of the price item in the price item pricing:

1. Ensure that the **Commitments** section is expanded when you are defining, editing, or overriding a price item pricing.
2. Click the **Add**  icon in the **Floor and Ceiling Type** column corresponding to the division for which you want to define the division-specific average price

The following fields appear in a grid:

Field Name	Field Description	Mandatory (Yes or No)
To Do Role	Used to indicate that users with the specified To Do role can approve the average price of the price item in the price item pricing when it is within the specified floor and ceil limits.	Yes (Conditional) Note: This field is required while defining the division-specific average price floor and ceil limits of the price item in the price item pricing.
	Note: The Search  icon appears corresponding to the To Do Role field. On clicking the Search icon, the To Do Role Search window appears. On specifying the To Do role, the description of the To Do role appears corresponding to the To Do Role field.	
Floor Value	Used to specify the floor (i.e. lower) limit of the To Do role for approving the average price of the price item in the price item pricing.	Yes (Conditional)

Field Name	Field Description	Mandatory (Yes or No)
	<p>Note: The floor value cannot be greater than the ceil value.</p> <p>This field appears only when you select Absolute Value Range option from the Average Price Floor and Ceil Type list while defining the deal information in the price item pricing.</p>	<p>Note: This field is required while defining the division-specific average price floor and ceil limits of the price item in the price item pricing.</p>
Ceil Value	<p>Used to specify the ceil (i.e. upper) limit of the To Do role for approving the average price of the price item in the price item pricing.</p> <p>Note: The ceil value cannot be lower than the floor value.</p> <p>This field appears only when you select Absolute Value Range option from the Average Price Floor and Ceil Type list while defining the deal information in the price item pricing.</p>	<p>Yes (Conditional)</p> <p>Note: This field is required while defining the division-specific average price floor and ceil limits of the price item in the price item pricing.</p>
Spread Amount	<p>Used to specify the spread amount of the To Do role for approving the average price of the price item in the price item pricing.</p> <p>Note: This field appears only when you select the Spread Amount option from the Average Price Floor and Ceil Type list while defining the deal information in the price item pricing.</p>	<p>Yes (Conditional)</p> <p>Note: This field is required while defining the division-specific average price floor and ceil limits of the price item in the price item pricing.</p>
Spread Percentage	<p>Used to specify the spread percentage of the To Do role for approving the average price of the price item in the price item pricing.</p> <p>Note: This field appears only when you select the Spread Percentage option from the Average Price Floor and Ceil Type list while defining the deal information in the price item pricing.</p>	<p>Yes (Conditional)</p> <p>Note: This field is required while defining the division-specific average price floor and ceil limits of the price item in the price item pricing.</p>
Floor and Ceil Currency	<p>Used to indicate the currency in which you want to define the average price floor and ceil limits of the price item in the price item pricing.</p>	<p>Yes (Conditional)</p> <p>Note: This field is required while defining the division-specific average price floor and ceil limits of the price item in the price item pricing.</p>

Field Name	Field Description	Mandatory (Yes or No)
	<p>Note:</p> <p>The list includes only those currencies which are already defined in the system.</p> <p>The system does the currency conversion when the pricing currency is different from the floor and ceil currency.</p>	

- Enter the required details in the **Floor and Ceiling Type** grid.

Note: The **Floor and Ceiling Type** grid appears only when you select an option from the **Average Price Floor and Ceil Type** field in the **Deal Information** section.

- If you want to define the average price limits for more than one To Do role in the division, click the **Add (+)** icon and then repeat step 3.

Note: However, if you want to remove the average price limits of a To Do role from the division, click the **Delete (🗑)** icon corresponding to the To Do role.

- Click **Save**.

The division-specific average price limits of the price item in the price item pricing is defined.

Related Topics

For more information on...	See...
How to define a price item pricing	Defining a Price Item Pricing on page 626
How to edit a price item pricing	Editing a Price Item Pricing on page 678
How to override a price item pricing	Overriding a Price Item Pricing on page 691

Defining the Division-Specific Rate Negotiability Limits of a Price item in the Price Item Pricing

Note: This topic is not applicable for the health insurance business.

Prerequisites

To define the division-specific rate negotiability limits of a price item in the price item pricing, you should have:

- Currencies defined in the application
- Price items associated with the division to which the user belongs

Procedure

To define the division-specific rate negotiability limits of a price item in the price item pricing:

- Ensure that the **Commitments** section is expanded when you are defining, editing, or overriding a price item pricing.
- Click the **Add (+)** icon in the **Negotiability** column corresponding to the division for which you want to define the division-specific rate negotiability limits
The following fields appear in a grid:

Field Name	Field Description	Mandatory (Yes or No)
Negotiability Floor Value	Used to specify the floor (i.e. lower) limit for the rate negotiation.	Yes (Conditional)
	Note: The floor value cannot be greater than the ceil value.	Note: This field is required while defining the division-specific rate negotiability limits of the price item in the price item pricing.
Negotiability Ceil Value	Used to specify the ceil (i.e. upper) limit for the rate negotiation.	Yes (Conditional)
	Note: The ceil value cannot be lower than the floor value.	Note: This field is required while defining the division-specific rate negotiability limits of the price item in the price item pricing.

Note: By default, the **Pricing Currency** is considered as the currency for defining the division-specific rate negotiability limits of the price item in the price item pricing.

- Enter the required details in the **Negotiability** grid.
- Click **Save**.

The division-specific rate negotiability limits of the price item in the price item pricing is defined.

Related Topics

For more information on...	See...
How to define a price item pricing	Defining a Price Item Pricing on page 626
How to edit a price item pricing	Editing a Price Item Pricing on page 678
How to override a price item pricing	Overriding a Price Item Pricing on page 691

Viewing the Price Components of a Rate Component

Note: This topic is not applicable for the health insurance business.

Procedure

To view the details of the price components of a rate component:

- Do either of the following:

If you want to view...	Then...
Price components of the Price Item Pricing assigned to an account	<ol style="list-style-type: none"> Search for the account in the Customer 360° View screen. In the Search Results section, click the Show Context Menu () icon corresponding to the account whose price item pricing details you want to view. A menu appears. Click the Go To Effective Pricing menu option.

If you want to view...	Then...
	<p>The Pricing (Account) screen appears.</p> <ol style="list-style-type: none"> Price assignments effective for the account appears in the Effective Price Assignments for Account zone. In the Search Results section, click the link in the Pricing Information column corresponding to the price item whose pricing details you want to view.
<p>Price components of the Price Item Pricing assigned to a person</p>	<ol style="list-style-type: none"> Search for the person in the Customer 360° View screen. In the Search Results section, click the Show Context Menu (▼) icon corresponding to the person whose price item pricing details you want to view. A menu appears. Click the Go To Effective Pricing menu option. The Pricing (Person) screen appears. Price assignments effective for the person appears in the Effective Price Assignments for Person zone. In the Search Results section, click the link in the Pricing Information column corresponding to the price item whose pricing details you want to view.
<p>Price components of Price Item Pricing assigned to a price list</p>	<ol style="list-style-type: none"> Search for the price list in the Price List screen. In the Search Results section, click the View (🔗) icon corresponding to the price list whose price item pricing details you want to view. The Price List Price Item Pricing screen appears. Price items assigned to the price list appears in the Price List Price Items zone. In the Search Results section, click the link in the Pricing Information column corresponding to the price item whose pricing details you want to view.

- The **Price Item Pricing** screen appears.
- Ensure that the **Price Assignment Tree** zone is expanded.
- Click the **Expand All** button to expand all the rate components to which the price components are associated.
View the details of the price component of a rate component in the **Price Assignment Tree** zone.

Related Topics

For more information on...	See...
How to search for an account	Searching for an Account on page 204
How to search for a person	Searching for a Person on page 203
How to search for a price list	Searching for a Price List on page 449
Customer 360° View screen	Customer 360° View on page 198
Pricing (Account) screen	Pricing (Account) on page 550
Effective Price Assignments for Account zone	Effective Price Assignments for Account on page 550
Pricing (Person) screen	Pricing (Person) on page 582
Effective Price Assignments for Person zone	Effective Price Assignments for Person on page 583
Price List screen	Price List (Used for Searching) on page 438
Price List Price Item Pricing screen	Price List Price Item Pricing on page 468
Price List Price Items zone	Price List Price Items on page 503
Price Item Pricing screen	Price Item Pricing (Used for Viewing) on page 614
Price Assignment Tree zone	Price Assignment Tree on page 448

Viewing the Tiering Criteria of a Price Component



Note: This topic is not applicable for the health insurance business.

Procedure

To view the tiering criteria of a price component:

1. Do either of the following:

If you want to view...	Then...
Tiering criteria of the Price Item Pricing assigned to an account	<ol style="list-style-type: none"> 1. Search for the account in the Customer 360° View screen. 2. In the Search Results section, click the Show Context Menu (▼) icon corresponding to the account whose price item pricing details you want to view. A menu appears. 3. Click the Go To Effective Pricing menu option. The Pricing (Account) screen appears. 4. Price assignments effective for the account appears in the Effective Price Assignments for Account zone. 5. In the Search Results section, click the link in the Pricing Information column corresponding to the price item whose pricing details you want to view.
Tiering criteria of the Price Item Pricing assigned to a person	<ol style="list-style-type: none"> 1. Search for the person in the Customer 360° View screen.

If you want to view...	Then...
	<ol style="list-style-type: none"> 2. In the Search Results section, click the Show Context Menu () icon corresponding to the person whose price item pricing details you want to view. A menu appears. 3. Click the Go To Effective Pricing menu option. The Pricing (Person) screen appears. 4. Price assignments effective for the person appears in the Effective Price Assignments for Person zone. 5. In the Search Results section, click the link in the Pricing Information column corresponding to the price item whose pricing details you want to view.
Tiering criteria of Price Item Pricing assigned to a price list	<ol style="list-style-type: none"> 1. Search for the price list in the Price List screen. 2. In the Search Results section, click the View () icon corresponding to the price list whose price item pricing details you want to view. The Price List Price Item Pricing screen appears. 3. Price items assigned to the price list appears in the Price List Price Items zone. 4. In the Search Results section, click the link in the Pricing Information column corresponding to the price item whose pricing details you want to view.

2. The **Price Item Pricing** screen appears.
3. Ensure that the **Price Assignment Tree** zone is expanded.
4. Click the **Expand All** button to expand all the price components for which the tiering criteria is defined.
View the details of the tiering criteria of a price component in the **Price Assignment Tree** zone.

Note:

You can view the details of the tiering criteria of a price component only when the **Tiering Type** for the rate component is **STEP** or **Threshold**.

Related Topics

For more information on...	See...
How to search for an account	Searching for an Account on page 204
How to search for a person	Searching for a Person on page 203
How to search for a price list	Searching for a Price List on page 449
Customer 360° View screen	Customer 360° View on page 198
Pricing (Account) screen	Pricing (Account) on page 550

For more information on...	See...
Effective Price Assignments for Account zone	Effective Price Assignments for Account on page 550
Pricing (Person) screen	Pricing (Person) on page 582
Effective Price Assignments for Person zone	Effective Price Assignments for Person on page 583
Price List screen	Price List (Used for Searching) on page 438
Price List Price Item Pricing screen	Price List Price Item Pricing on page 468
Price List Price Items zone	Price List Price Items on page 503
Price Item Pricing screen	Price Item Pricing (Used for Viewing) on page 614
Price Assignment Tree zone	Price Assignment Tree on page 448

Viewing the Pricing Eligibility Criteria of a Price Component

Note: This topic is not applicable for the health insurance business.

Procedure

To view the pricing eligibility criteria of a price component:

1. Do either of the following:

If you want to view...	Then...
Pricing eligibility criteria of Price Item Pricing assigned to an account	<ol style="list-style-type: none"> 1. Search for the account in the Customer 360° View screen. 2. In the Search Results section, click the Show Context Menu (▼) icon corresponding to the account whose price item pricing details you want to view. A menu appears. 3. Click the Go To Effective Pricing menu option. The Pricing (Account) screen appears. 4. Price assignments effective for the account appears in the Effective Price Assignments for Account zone. 5. In the Search Results section, click the link in the Pricing Information column corresponding to the price item whose pricing details you want to view.
Pricing eligibility criteria of Price Item Pricing assigned to a person	<ol style="list-style-type: none"> 1. Search for the person in the Customer 360° View screen. 2. In the Search Results section, click the Show Context Menu (▼) icon corresponding to the person whose price item pricing details you want to view. A menu appears. 3. Click the Go To Effective Pricing menu option. The Pricing (Person) screen appears.

If you want to view...	Then...
	<ol style="list-style-type: none"> 4. Price assignments effective for the person appears in the Effective Price Assignments for Person zone. 5. In the Search Results section, click the link in the Pricing Information column corresponding to the price item whose pricing details you want to view.
Pricing eligibility criteria of Price Item Pricing assigned to a price list	<ol style="list-style-type: none"> 1. Search for the price list in the Price List screen. 2. In the Search Results section, click the View () icon corresponding to the price list whose price item pricing details you want to view. The Price List Price Item Pricing screen appears. 3. Price items assigned to the price list appears in the Price List Price Items zone. 4. In the Search Results section, click the link in the Pricing Information column corresponding to the price item whose pricing details you want to view.

2. The **Price Item Pricing** screen appears.
3. Ensure that the **Price Assignment Tree** zone is expanded.
4. Click the **Expand All** button to expand all the price components for which the pricing eligibility criteria is defined.
View the details of the pricing eligibility criteria of a price component in the **Price Assignment Tree** zone.

Note:

You can view the details of the pricing eligibility criteria of a price component only when the **Pricing Eligibility** check box is selected in the **Price Item Pricing** screen and the details of the pricing eligibility criteria is added in the **Price Assignment Tree** section.

Related Topics

For more information on...	See...
How to search for an account	Searching for an Account on page 204
How to search for a person	Searching for a Person on page 203
How to search for a price list	Searching for a Price List on page 449
Customer 360° View screen	Customer 360° View on page 198
Pricing (Account) screen	Pricing (Account) on page 550
Effective Price Assignments for Account zone	Effective Price Assignments for Account on page 550
Pricing (Person) screen	Pricing (Person) on page 582
Effective Price Assignments for Person zone	Effective Price Assignments for Person on page 583
Price List screen	Price List (Used for Searching) on page 438

For more information on...	See...
Price List Price Item Pricing screen	<i>Price List Price Item Pricing</i> on page 468
Price List Price Items zone	<i>Price List Price Items</i> on page 503
Price Item Pricing screen	<i>Price Item Pricing (Used for Viewing)</i> on page 614
Price Assignment Tree zone	<i>Price Assignment Tree</i> on page 448

Defining a Price Component for a Rate Component

Note: This topic is not applicable for the health insurance business.

Prerequisites

To define a price component for a rate component, you should have:



- Rate component defined for the price item in the application



Procedure

To define a price component for a rate component:

1. Do either of the following:

If you want to define...	Then...
Price component of a price item pricing assigned to an account	<ol style="list-style-type: none"> 1. Search for the account in the Customer 360° View screen. 2. In the Search Results section, click the Context Menu () icon corresponding to the account whose details you want to view. A menu appears. 3. Click the Go To Effective Pricing menu option. The Pricing (Account) screen appears. 4. Price assignments effective for the account appears in the Effective Price Assignments for Account zone. 5. In the Search Results section, click the link in the Pricing Information column corresponding to the price item whose pricing details you want to define. The Price Item Pricing screen appears.

If you want to define...	Then...
	<p>Tip: Alternatively, you can define the price component of a price item pricing assigned to an account by:</p> <ol style="list-style-type: none"> 1. Searching for the price item in the Search Price Item or Price Item Pricing zone of the Pricing (Account) screen. 2. In the Search Results section, click the Assign () icon in the Assign column corresponding to the price item. The Price Item Pricing screen appears 3. Enter the required details in the Price Item Pricing screen and click Save. 4. The Price Item Pricing screen appears.
Price component of a price item pricing assigned to a person	<ol style="list-style-type: none"> 1. Search for the person in the Customer 360° View screen. 2. In the Search Results section, click the Context Menu () icon corresponding to the person whose details you want to view. A menu appears. 3. Click the Go To Effective Pricing menu option. The Pricing (Person) screen appears. 4. Price assignments effective for the person appears in the Effective Price Assignments for Person zone. 5. In the Search Results section, click the link in the Pricing Information column corresponding to the price item whose pricing details you want to define. The Price Item Pricing screen appears.

If you want to define...	Then...
	<p>Tip: Alternatively, you can define the price component of a price item pricing assigned to a person by:</p> <ol style="list-style-type: none"> 1. Searching for the price item in the Search Price Item or Price Item Pricing zone of the Pricing (Person) screen. 2. In the Search Results section, click the Assign  icon in the Assign column corresponding to the price item. The Price Item Pricing screen appears 3. Enter the required details in the Price Item Pricing screen and click Save. 4. The Price Item Pricing screen appears.
Price component of a price item pricing assigned to a price list	<ol style="list-style-type: none"> 1. Search for the price list in the Price List screen. 2. In the Search Results section, click the View  icon in the Price List Pricing column corresponding to the price list whose details you want to view. The Price List Price Item Pricing screen appears. 3. Price items assigned to the price list appear in the Price List Price Items zone. 4. In the Search Results section, click the link in the Pricing Information column corresponding to the price item whose pricing details you want to define. The Price Item Pricing screen appears. <p>Tip: Alternatively, you can define the price component of a price item pricing assigned to a price list by:</p> <ol style="list-style-type: none"> 1. Searching for the price item in the Search Price Item or Price Item Pricing zone of the Price List Price Item Pricing screen. 2. In the Search Results section, click the Assign  icon in the Assign column corresponding to the price item. The Price Item Pricing screen appears 3. Enter the required details in the Price Item Pricing screen and click Save. 4. The Price Item Pricing screen appears.

If you want to define...	Then...
Price component of a price item pricing assigned to a price list	<ol style="list-style-type: none"> 1. . Search for the price list in the Price List screen. 2. In the Search Results section, click the Broadcast (📡) icon corresponding to the price list whose price item pricing details you want to view. The Price List Price Items zone appears. 3. Click the link in the Pricing Information column corresponding to the price item whose price item pricing details you want to define. 4. The Price Item Pricing screen appears. <p>Tip: Alternatively, you can click on the Broadcast (📡) icon corresponding to the price item whose pricing details you want to view. The Price Assignment Tree zone appears in the Price List screen.</p>

2. Ensure that the **Price Assignment Tree** zone is expanded when you are defining a price component for the rate component.
3. Click the **Add** (+) icon corresponding to the rate component whose price component you want to define.

Note: You can define a price component of a rate component only when the price item pricing is in the **Draft**, **Proposed**, or **Template** status.

The **Price Component** zone appears. It contains the following fields:

Field Name	Field Description	Mandatory (Yes or No)
Rate Component Information	Displays the concatenated string of information about the rate component for which you want to define the price component.	Not applicable
Display Sequence	Used to specify the sequence of the price component whose rate is used for calculating the pricing of the price item.	Yes (Conditional) Note: This field is required while defining the price component of a rate component.
Show Price Component	Used to indicate whether the price component is displayed in the bill. Note: If you select the check box, the price component will be displayed in the bill.	No
Description	Used to specify the description of the price component.	Yes (Conditional)

Field Name	Field Description	Mandatory (Yes or No)
		Note: This field is required while defining the price component of a rate component.
Rate	Used to specify the rate for the price component.	Yes (Conditional) Note: This field is required while defining the price component of a rate component.

In addition, this zone contains the following buttons:

Button Name	Button Description
Show Price Component Tier	Used to define, edit, or delete the tiering criteria of the price component. Note: The Show Price Component Tier button appears only when Tiering Type of the rate component is STEP or Threshold .
Show Price Component Eligibility	Used to define, edit, or delete the pricing eligibility criteria of the price component. Note: The Show Price Component Eligibility button appears only when the Pricing Eligibility check box is selected in the Price Item Pricing screen.

4. Enter the required details in the **Price Component** zone.
5. Define the tiering criteria for the price component, if required.
6. Define the pricing eligibility criteria for the price component, if required.
7. Click **Save**.

The price component is defined for the rate component.

Related Topics

For more information on...	See...
How to search for an account	Searching for an Account on page 204
How to search for a person	Searching for a Person on page 203
How to search for a price list	Searching for a Price List on page 449
Customer 360° View screen	Customer 360° View on page 198
Pricing (Account) screen	Pricing (Account) on page 550
Effective Price Assignments for Account zone	Effective Price Assignments for Account on page 550
Pricing (Person) screen	Pricing (Person) on page 582
Effective Price Assignments for Person zone	Effective Price Assignments for Person on page 583
Price List screen	Price List (Used for Searching) on page 438

For more information on...	See...
Price List Price Item Pricing screen	Price List Price Item Pricing on page 468
Price List Price Items zone	Price List Price Items on page 503
Price Item Pricing screen	Price Item Pricing (Used for Viewing) on page 614
Price Assignment Tree zone	Price Assignment Tree on page 448
How to define a tiering criteria for a price component	Defining a Tiering Criteria for a Price Component on page 652
How to define a pricing eligibility criteria for a price component	Defining a Pricing Eligibility Criteria for a Price Component on page 654
How to edit a tiering criteria of a price component	Editing a Tiering Criteria of a Price Component on page 669
How to edit a pricing eligibility criteria of a price component	Editing a Pricing Eligibility Criteria of a Price Component on page 673

Defining a Tiering Criteria for a Price Component

Note: This topic is not applicable for the health insurance business.

Prerequisites

To define a tiering criteria for a price component, you should have:

- Tiering criterion defined in the application
- Tiering setup for the rate components defined in the application.

Procedure

To define a tiering criteria for a price component:

1. Ensure that the **Price Assignment Tree** zone is expanded in the **Price Item Pricing** screen.
2. Click the **Add (+)** icon corresponding to the rate component whose price component you want to define.
The **Price Component** zone appears.
3. Click the **Show Price Component Tier** button.

Note:

The **Show Price Component Tier** button appears only when **Tiering Type** of the rate component is **STEP** or **Threshold**.

The **Tiering Criteria** section appears. It contains the following fields in a grid:

Field Name	Field Description	Mandatory (Yes or No)
Display Sequence	Used to specify the sequence in which the tiering criteria of the price component should be considered for the price item pricing.	Yes (Conditional)
		Note: This field is required while defining the tiering criteria of a price component.

Field Name	Field Description	Mandatory (Yes or No)
Tiering Criterion	Used to indicate the tiering criterion which is used in the tiering range.	Yes (Conditional)
		Note: This field is required while defining the tiering criteria of a price component.
Lower Limit	Used to specify the lower limit of the pricing range.	Yes (Conditional)
	Note: The system provides you with the facility to specify the lower limit value with a precision of up to 18 places before decimal and 18 places after decimal. This gives you the flexibility to specify very large and very low values in the tiering range.	Note: This field is required while defining the tiering criteria of a price component.
Upper Limit	Used to specify the upper limit of the pricing range.	Yes (Conditional)
	Note: The system provides you with the facility to specify the upper limit value with a precision of up to 18 places before decimal and 18 places after decimal. This gives you the flexibility to specify very large and very low values in the tiering range. When you define single tier with the maximum value as blank (for example, 0 to BLANK), the system will automatically replace the blank space with 9999999999999999.99.	Note: This field is required while defining the tiering criteria of a price component.
Price Item	Used to indicate whether the price item or price item bundle's total usage is considered for determining the rate. By default, the price item code for which you are defining the pricing appears in this field. You can specify any other price item or bundle code, if required.	Yes (Conditional)
	Note: The Search  icon appears corresponding to the Price Item field. On clicking the Search icon, the Price Item Search screen appears where you can search for the required price item.	Note: This field is required while defining the tiering criteria of a price component.
Price Item Parameters	Used to specify the parameters based on which the price item or price item bundle's total usage should be considered for determining the rate. By default, the parameters based on which you are defining the pricing appear in this field. You can specify any other	No

Field Name	Field Description	Mandatory (Yes or No)
	<p>parameter (where the Pricing flag is set to Yes, if required. However, you can only select parameter associated with the price item or price item bundle which is used for defining the tiering criteria.</p> <p>Note:</p> <p>This field appears when the Multi Price Parameter option type of the Multi Parameter Based Pricing (C1_PPARM_FLG) feature configuration is set to True.</p> <p>The Edit (✎) appears corresponding to this field. On clicking the Edit icon, the Tier Parameters section appears where you can screen appears where you can specify the required parameters.</p>	

- Enter the required details in the **Tiering Criteria** section.
- If you want to define more than one tiering criteria for the price component, click the **Add (+)** icon and then repeat step 2.

Note: However, if you want to remove a tiering criteria from the price component, click the **Delete** (🗑️) icon corresponding to the tiering criterion.

- Click **Save**.

The tiering criteria is defined for the price component.

Note: You can define a tiering criteria for a price component only when the price item pricing is in the **Draft**, **Proposed**, or **Template** status.

Related Topics

For more information on...	See...
Price Assignment Tree zone	Price Assignment Tree on page 448
Price Item Pricing screen	Price Item Pricing (Used for Viewing) on page 614
How to edit a tiering criteria of a price component	Editing a Tiering Criteria of a Price Component on page 669

Defining a Pricing Eligibility Criteria for a Price Component

Note: This topic is not applicable for the health insurance business.

Procedure

To define a pricing eligibility criteria for a price component:

- Ensure that the **Price Assignment Tree** zone is expanded in the **Price Item Pricing** screen..
- Click the **Add (+)** icon corresponding to the rate component whose price component you want to define.

The **Price Component** zone appears.

3. Click the **Show Price Component Eligibility** button.

Note:

The **Show Pricing Component Eligibility** button appears only when **Pricing Eligibility** check box is selected in the **Price Item Pricing** screen.

The **Pricing Eligibility Criteria** section appears. It contains the following fields in a grid:

Field Name	Field Description	Mandatory (Yes or No)
Display Sequence	Used to specify the order in which the pricing eligibility criteria is executed in the rule.	Yes (Conditional) Note: This field is required while defining the pricing eligibility criteria of a price component.
Parameter	Used to specify the left hand side parameter which you want to use along with the price item for price determination. Note: The Search (🔍) icon appears corresponding to the Parameter field. On clicking the Search icon, the Parameter Search window appears where you can search for the required parameter. You must not specify any special character except underscore (_) in the parameter code. Otherwise, the status of the transaction is changed to Error (ERROR) . This field appears when the Multi Price Parameter option type of the Multi Parameter Based Pricing (C1_PPARAM_FLG) feature configuration is set to True .	Yes (Conditional) Note: This field is required while defining the pricing eligibility criteria of a price component.
Operator	Used to indicate the relational operator to define the relation between the parameter name and the parameter value. The valid values are: <ul style="list-style-type: none">• <• <=• <>• =• >• >=• Between	Yes (Conditional) Note: This field is required while defining the pricing eligibility criteria of a price component.

Field Name	Field Description	Mandatory (Yes or No)
	<ul style="list-style-type: none"> • In • Like • Not In 	
Parameter Value Type	<p>Used to indicate whether the parameter (on the left hand side) is compared against another parameter (on the right hand side) or directly against a parameter value. The valid values are:</p> <ul style="list-style-type: none"> • Parameter - Used to indicate that the parameter (on the left hand side) is compared against another parameter (on the right hand side). • Value - Used to indicate that the parameter (on the left hand side) is compared against a parameter value. 	<p>Yes (Conditional)</p> <p>Note: This field is required while defining the pricing eligibility criteria of a price component.</p>
Parameter Value	<p>Used to specify the parameter value against which you want to compare the parameter (on the left hand side). The valid values are:</p> <p>Note:</p> <p>This field is enabled only when you specify the parameter in the Parameter field.</p> <p>The Search (🔍) icon appears corresponding to the Parameter Value field when the Parameter option is selected from Parameter Value Type field. On clicking the Search icon, the Parameter Search window appears.</p> <p>When the Parameter option is selected from the Parameter Value Type field then you must not specify any special character except underscore (_) in the parameter code. Otherwise, the status of the transaction is changed to Error (ERROR).</p> <p>When the Value option is selected for the Parameter Value Type field then you can specify any special characters except ampersand (&), comma (,), underscore (_), equal to (=), tilde (~), and semi-colon (;) in the parameter value.</p> <p>This field appears when the Multi Price Parameter option type of the Multi Parameter Based Pricing (C1_PPARAM_FLG) feature configuration is set to True.</p>	<p>Yes (Conditional)</p> <p>Note: This field is required while defining the pricing eligibility criteria of a price component.</p>

Field Name	Field Description	Mandatory (Yes or No)
Is True	Used to indicate what should happen when the condition is true (satisfied). The valid values are: <ul style="list-style-type: none"> • Check Next Condition – Used to indicate that the condition with consecutive sequence number is executed. • Rule Is False – Used to indicate that the action specified in the Rule False Action field is executed. • Rule Is True – Used to indicate that the action specified in the Rule True Action field is executed. 	Yes (Conditional) Note: This field is required while defining the pricing eligibility criteria of a price component.
Is False	Used to indicate what should happen when the condition is false (not satisfied). The valid values are: <ul style="list-style-type: none"> • Check Next Condition – Used to indicate that the condition with consecutive sequence number is executed. • Rule Is False – Used to indicate that the action specified in the Rule False Action field is executed. • Rule Is True – Used to indicate that the action specified in the Rule True Action field is executed. 	Yes (Conditional) Note: This field is required while defining the pricing eligibility criteria of a price component.
Is Insufficient	Used to indicate what should happen when the data is insufficient. The valid values are: <ul style="list-style-type: none"> • Check Next Condition – Used to indicate that the condition with consecutive sequence number is executed. • Rule Is False – Used to indicate that the action specified in the Rule False Action field is executed. • Rule Is True – Used to indicate that the action specified in the Rule True Action field is executed. 	Yes (Conditional) Note: This field is required while defining the pricing eligibility criteria of a price component.

4. Enter the required details in the **Pricing Eligibility Criteria** section.
5. If you want to define more than one pricing eligibility criteria for the price component, click the **Add (+)** icon and then repeat step 2.

Note: However, if you want to remove a pricing eligibility criteria from the price component, click the **Delete** (🗑️) icon corresponding to the parameter.

6. Click **Save**.

The pricing eligibility criteria is defined for the price component.

Note: You can define a pricing eligibility criteria for a price component only when the price item pricing is in the **Draft**, **Proposed**, or **Template** status.

Related Topics

For more information on...	See...
Price Assignment Tree zone	<i>Price Assignment Tree</i> on page 448
Price Item Pricing screen	<i>Price Item Pricing (Used for Viewing)</i> on page 614
How to edit a pricing eligibility criteria of a price component	<i>Editing a Pricing Eligibility Criteria of a Price Component</i> on page 673

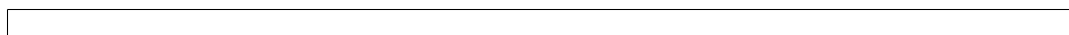

Editing a Price Component

Note: This topic is not applicable for the health insurance business.

Prerequisites

To edit a price component of a rate component, you should have:





- Rate component defined for the price item in the application

Procedure

To edit a price component of a rate component:

1. Do either of the following:

If you want to edit...	Then...
Price component of a price item pricing assigned to an account	<ol style="list-style-type: none"> 1. Search for the account in the Customer 360° View screen. 2. In the Search Results section, click the Context Menu () icon corresponding to the account whose details you want to view. A menu appears. 3. Click the Go To Effective Pricing menu option. The Pricing (Account) screen appears. 4. Price assignments effective for the account appears in the Effective Price Assignments for Account zone. 5. In the Search Results section, click the link in the Pricing Information column corresponding to the price item whose pricing details you want to view. The Price Item Pricing screen appears.

If you want to edit...	Then...
	<p>Tip: Alternatively, you can edit the price component of a price item pricing assigned to an account by:</p> <ol style="list-style-type: none"> 1. Clicking the Broadcast () icon corresponding to the price assignment in the Effective Price Assignments for Account zone of the Pricing (Account) screen. The Price Assignment Tree zone appears.
Price component of a price item pricing assigned to a person	<ol style="list-style-type: none"> 1. Search for the person in the Customer 360° View screen. 2. In the Search Results section, click the Context Menu () icon corresponding to the person whose details you want to view. A menu appears. 3. Click the Go To Effective Pricing menu option. The Pricing (Person) screen appears. 4. Price assignments effective for the person appears in the Effective Price Assignments for Person zone. 5. In the Search Results section, click the link in the Pricing Information column corresponding to the price item whose pricing details you want to view. The Price Item Pricing screen appears. <p>Tip: Alternatively, you can edit the price component of a price item pricing assigned to a person by:</p> <ol style="list-style-type: none"> 1. Clicking the Broadcast () icon corresponding to the price assignment in the Effective Price Assignments for Person zone of the Pricing (Account) screen. The Price Assignment Tree zone appears.
Price component of a price item pricing assigned to a price list	<ol style="list-style-type: none"> 1. Search for the price list in the Price List screen. 2. In the Search Results section, click the View () icon corresponding to the price list whose details you want to view. The Price List Price Item Pricing screen appears. 3. Price items assigned to the price list appears in the Price List Price Items zone. 4. In the Search Results section, click the link in the Pricing Information column corresponding to the price item whose pricing details you want to view.

If you want to edit...	Then...
	<p data-bbox="792 201 1219 233">The Price Item Pricing screen appears.</p> <p data-bbox="727 268 1401 331">Tip: Alternatively, you can edit the price component of a price item pricing assigned to a price list by:</p> <ol data-bbox="756 363 1401 800" style="list-style-type: none"> <li data-bbox="756 363 1401 443">1. . Searching for the price list in the Price List screen. <li data-bbox="756 468 1401 621">2. In the Search Results section, click the Broadcast () icon corresponding to the price list whose price item pricing you want to view. The Price List Price Items zone appears. <li data-bbox="756 646 1401 741">3. Click the link in the Pricing Information column corresponding to the price item whose pricing details you want to view. <li data-bbox="756 766 1219 800">4. The Price Item Pricing screen appears.

2. Ensure that the **Price Assignment Tree** zone is expanded when you are editing a price component.
3. Click the **Expand All** button to expand all the rate components to which the price components are associated.
4. Click the **Edit** () icon corresponding to the price component of the rate component whose details you want to edit.

Note: You can edit a price component of a price item pricing assigned to an account, person, or price list only when the price item pricing is in the **Draft**, **Proposed**, or **Template** status.

The **Price Component** zone appears. It contains the following fields:

Field Name	Field Description	Mandatory (Yes or No)
Rate Component Information	Displays the concatenated string of information about the rate component for which you want to define the price component.	Not applicable
Display Sequence	Used to specify the sequence of the price component whose rate is used for calculating the pricing of the price item.	Yes (Conditional) Note: This field is required while defining the price component of a rate component.
Show Price Component	Used to indicate whether the price component is displayed in the bill. Note: If you select the check box, the price component will be displayed in the bill.	No
Description	Used to specify the description of the price component.	Yes (Conditional)

Field Name	Field Description	Mandatory (Yes or No)
		Note: This field is required while defining the price component of a rate component.
Rate	Used to specify the rate for the price component.	Yes (Conditional) Note: This field is required while defining the price component of a rate component.

In addition, this zone contains the following buttons:

Button Name	Button Description
Show Price Component Tier	Used to define, edit, or delete the tiering criteria of the price component. Note: The Show Price Component Tier button appears only when Tiering Type of the rate component is STEP or Threshold .
Show Price Component Eligibility	Used to define, edit, or delete the pricing eligibility criteria of the price component. Note: The Show Price Component Eligibility button appears only when the Pricing Eligibility check box is selected in the Price Item Pricing screen.

5. Modify the required details in the **Price Component** section.
6. Add, edit, or remove the tiering criteria of the price component, if required.
7. Add, edit, or remove the pricing eligibility criteria of the price component, if required.
8. Click **Save**.

The changes made to the price component are saved.

Related Topics

For more information on...	See...
How to search for an account	Searching for an Account on page 204
How to search for a person	Searching for a Person on page 203
How to search for a price list	Searching for a Price List on page 449
Customer 360° View screen	Customer 360° View on page 198
Pricing (Account) screen	Pricing (Account) on page 550
Effective Price Assignments for Account zone	Effective Price Assignments for Account on page 550
Pricing (Person) screen	Pricing (Person) on page 582
Effective Price Assignments for Person zone	Effective Price Assignments for Person on page 583
Price List screen	Price List (Used for Searching) on page 438

For more information on...	See...
Price List Price Item Pricing screen	Price List Price Item Pricing on page 468
Price List Price Items zone	Price List Price Items on page 503
Price Item Pricing screen	Price Item Pricing (Used for Viewing) on page 614
Price Assignment Tree zone	Price Assignment Tree on page 448
How to define a tiering criteria for a price component	Defining a Tiering Criteria for a Price Component on page 652
How to define a pricing eligibility criteria for a price component	Defining a Pricing Eligibility Criteria for a Price Component on page 654
How to edit a tiering criteria of a price component	Editing a Tiering Criteria of a Price Component on page 669
How to edit a pricing eligibility criteria of a price component	Editing a Pricing Eligibility Criteria of a Price Component on page 673

Copying a Price Component

Note: This topic is not applicable for the health insurance business.

Prerequisites

To copy a price component for a rate component, you should have:





- Rate component defined for the price item in the application

Procedure

To copy a price component for a rate component:

1. Do either of the following:

If you want to copy...	Then...
Price component of a price item pricing assigned to an account	<ol style="list-style-type: none"> 1. Search for the account in the Customer 360° View screen. 2. In the Search Results section, click the Context Menu () icon corresponding to the account whose details you want to view. A menu appears. 3. Click the Go To Effective Pricing menu option. The Pricing (Account) screen appears. 4. Price assignments effective for the account appears in the Effective Price Assignments for Account zone. 5. In the Search Results section, click the link in the Pricing Information column corresponding to the price item whose pricing details you want to view. The Price Item Pricing screen appears.

If you want to copy...	Then...
	<p>Tip: Alternatively, you can edit the price component of a price item pricing assigned to an account by:</p> <ol style="list-style-type: none"> 1. Clicking the Broadcast () icon corresponding to the price assignment in the Effective Price Assignments for Account zone of the Pricing (Account) screen. The Price Assignment Tree zone appears.
Price component of a price item pricing assigned to a person	<ol style="list-style-type: none"> 1. Search for the person in the Customer 360° View screen. 2. In the Search Results section, click the Context Menu () icon corresponding to the person whose details you want to view. A menu appears. 3. Click the Go To Effective Pricing menu option. The Pricing (Person) screen appears. 4. Price assignments effective for the person appears in the Effective Price Assignments for Person zone. 5. In the Search Results section, click the link in the Pricing Information column corresponding to the price item whose pricing details you want to view. The Price Item Pricing screen appears. <p>Tip: Alternatively, you can edit the price component of a price item pricing assigned to a person by:</p> <ol style="list-style-type: none"> 1. Clicking the Broadcast () icon corresponding to the price assignment in the Effective Price Assignments for Person zone of the Pricing (Account) screen. The Price Assignment Tree zone appears.
Price component of a price item pricing assigned to a price list	<ol style="list-style-type: none"> 1. Search for the price list in the Price List screen. 2. In the Search Results section, click the View () icon corresponding to the price list whose details you want to view. The Price List Price Item Pricing screen appears. 3. Price items assigned to the price list appears in the Price List Price Items zone. 4. In the Search Results section, click the link in the Pricing Information column corresponding to the price item whose pricing details you want to view.

If you want to copy...	Then...
	<p data-bbox="792 201 1219 233">The Price Item Pricing screen appears.</p> <p data-bbox="727 268 1398 331">Tip: Alternatively, you can edit the price component of a price item pricing assigned to a price list by:</p> <ol data-bbox="756 363 1398 800" style="list-style-type: none"> <li data-bbox="756 363 1341 436">1. . Searching for the price list in the Price List screen. <li data-bbox="756 468 1398 621">2. In the Search Results section, click the Broadcast  icon corresponding to the price list whose price item pricing you want to view. The Price List Price Items zone appears. <li data-bbox="756 653 1398 737">3. Click the link in the Pricing Information column corresponding to the price item whose pricing details you want to view. <li data-bbox="756 768 1219 800">4. The Price Item Pricing screen appears.

2. Ensure that the **Price Assignment Tree** zone is expanded when you are copying a price component.
3. Click the **Expand All** button to expand all the rate components to which the price components are associated.
4. Click the **Duplicate**  icon corresponding to the price component whose details you want to copy for the rate component.

Note: You can copy a price component of a rate component only when the price item pricing is in the **Draft**, **Proposed**, or **Template** status.

The **Price Component** zone appears. It contains the following fields:

Field Name	Field Description	Mandatory (Yes or No)
Rate Component Information	Displays the concatenated string of information about the rate component for which you want to define the price component.	Not applicable
Display Sequence	Used to specify the sequence of the price component whose rate is used for calculating the pricing of the price item.	Yes (Conditional) Note: This field is required while defining the price component of a rate component.
Show Price Component	Used to indicate whether the price component is displayed in the bill. Note: If you select the check box, the price component will be displayed in the bill.	No
Description	Used to specify the description of the price component.	Yes (Conditional)

Field Name	Field Description	Mandatory (Yes or No)
		Note: This field is required while defining the price component of a rate component.
Rate	Used to specify the rate for the price component.	Yes (Conditional) Note: This field is required while defining the price component of a rate component.

In addition, this zone contains the following buttons:

Button Name	Button Description
Show Price Component Tier	Used to define, edit, or delete the tiering criteria of the price component. Note: The Show Price Component Tier button appears only when Tiering Type of the rate component is STEP or Threshold .
Show Price Component Eligibility	Used to define, edit, or delete the pricing eligibility criteria of the price component. Note: The Show Price Component Eligibility button appears only when the Pricing Eligibility check box is selected in the Price Item Pricing screen.

5. Add, edit, or remove the required details in the **Price Component** section.
6. Add, edit, or remove the tiering criteria of the price component, if required.
7. Add, edit, or remove the pricing eligibility criteria of the price component, if required.
8. Click **Save**.

The new price component is defined for the rate component.

Related Topics

For more information on...	See...
How to search for an account	Searching for an Account on page 204
How to search for a person	Searching for a Person on page 203
How to search for a price list	Searching for a Price List on page 449
Customer 360° View screen	Customer 360° View on page 198
Pricing (Account) screen	Pricing (Account) on page 550
Effective Price Assignments for Account zone	Effective Price Assignments for Account on page 550
Pricing (Person) screen	Pricing (Person) on page 582
Effective Price Assignments for Person zone	Effective Price Assignments for Person on page 583
Price List screen	Price List (Used for Searching) on page 438

For more information on...	See...
Price List Price Item Pricing screen	Price List Price Item Pricing on page 468
Price List Price Items zone	Price List Price Items on page 503
Price Item Pricing screen	Price Item Pricing (Used for Viewing) on page 614
Price Assignment Tree zone	Price Assignment Tree on page 448
How to define a tiering criteria for a price component	Defining a Tiering Criteria for a Price Component on page 652
How to define a pricing eligibility criteria for a price component	Defining a Pricing Eligibility Criteria for a Price Component on page 654
How to edit a tiering criteria of a price component	Editing a Tiering Criteria of a Price Component on page 669
How to edit a pricing eligibility criteria of a price component	Editing a Pricing Eligibility Criteria of a Price Component on page 673

Deleting a Price Component





Note: This topic is not applicable for the health insurance business.



Procedure

To delete a price component:

1. Do either of the following:

If you want to delete...	Then...
Price components of Price Item Pricing assigned to an account	<ol style="list-style-type: none"> 1. Search for the account in the Customer 360° View screen. 2. In the Search Results section, click the Show Context Menu (▼) icon corresponding to the account whose details you want to view. A menu appears. 3. Click the Go To Effective Pricing menu option. The Pricing (Account) screen appears. 4. Price assignments effective for the account appears in the Effective Price Assignments for Account zone. 5. In the Search Results section, click the link in the Pricing Information column corresponding to the price item whose pricing details you want to view. The Price Item Pricing screen appears.

If you want to delete...	Then...
	<p>Tip: Alternatively, you can access the Price Item Pricing screen by:</p> <ol style="list-style-type: none"> 1. Search for a price item in the Search Price Item or Price Item Pricing zone. 2. In the Search Results section, click the Assign () icon corresponding to the price item. 3. Enter the required details in the Price Item Pricing screen and click Save. 4. The Price Item Pricing screen appears.
Price components of Price Item Pricing assigned to a person	<ol style="list-style-type: none"> 1. Search for the person in the Customer 360° View screen. 2. In the Search Results section, click the Show Context Menu () icon corresponding to the person whose details you want to view. A menu appears. 3. Click the Go To Effective Pricing menu option. The Pricing (Person) screen appears. 4. Price assignments effective for the person appears in the Effective Price Assignments for Person zone. 5. In the Search Results section, click the link in the Pricing Information column corresponding to the price item whose pricing details you want to view. The Price Item Pricing screen appears. <p>Tip: Alternatively, you can access the Price Item Pricing screen by:</p> <ol style="list-style-type: none"> 1. Search for a price item in the Search Price Item or Price Item Pricing zone. 2. In the Search Results section, click the Assign () icon corresponding to the price item. 3. Enter the required details in the Price Item Pricing screen and click Save. 4. The Price Item Pricing screen appears.
Price components of Price Item Pricing assigned to a price list	<ol style="list-style-type: none"> 1. Search for the price list in the Price List screen. 2. In the Search Results section, click the Price List Pricing () icon corresponding to the price list whose details you want to view.

If you want to delete...	Then...
	<p>The Price List Price Item Pricing screen appears.</p> <ol style="list-style-type: none"> Price items assigned to the price list appears in the Price List Price Items zone. In the Search Results section, click the link in the Pricing Information column corresponding to the price item whose pricing details you want to view. <p>The Price Item Pricing screen appears.</p> <p>Tip: Alternatively, you can access the Price Item Pricing screen by:</p> <ol style="list-style-type: none"> Search for a price item in the Search Price Item or Price Item Pricing zone. In the Search Results section, click the Assign  icon corresponding to the price item. Enter the required details in the Price Item Pricing screen and click Save. The Price Item Pricing screen appears.
Price components of Price Item Pricing assigned to a price list	<ol style="list-style-type: none"> Search for the price list in the Price List screen. In the Search Results section, click the Broadcast  icon corresponding to the price list whose price item pricing you want to view. <p>The Price List Price Item zone appears.</p> <ol style="list-style-type: none"> Click the link in the Pricing Information column corresponding to the price item whose price item pricing you want to view. The Price Item Pricing screen appears. <p>Tip: Alternatively, you can click on the Broadcast  icon corresponding to the price list whose price item pricing you want to view. The Price Item Pricing zone appears in the Price List screen.</p>

- Ensure that the **Pricing Structure** zone is expanded when you are defining a price component.
- Click the **Delete**  icon corresponding to the price component you want to remove for the rate component.

Note: The **Delete** icon appears when the price assignment is in **Draft, Proposed** or **Template** status.

A message appears confirming whether you want to remove the price component for the rate component.

- Click **OK**.

The price component is removed for the rate component.

Related Topics

For more information on...	See...
How to search for an account	Searching for an Account on page 204
How to search for a person	Searching for a Person on page 203
How to search for a price list	Searching for a Price List on page 449
Customer 360° View screen	Customer 360° View on page 198
Pricing (Account) screen	Pricing (Account) on page 550
Effective Price Assignments for Account zone	Effective Price Assignments for Account on page 550
Pricing (Person) screen	Pricing (Person) on page 582
Effective Price Assignments for Person zone	Effective Price Assignments for Person on page 583
Price List screen	Price List (Used for Searching) on page 438
Price List Price Item Pricing screen	Price List Price Item Pricing on page 468
Price List Price Items zone	Price List Price Items on page 503
Price Item Pricing screen	Price Item Pricing (Used for Viewing) on page 614
Price Assignment Tree zone	Price Assignment Tree on page 448
How to define a price component for a rate component	Defining a Price Component for a Rate Component on page 647
How to edit a price component	Editing a Price Component on page 658
How to copy a price component	Copying a Price Component on page 662

Editing a Tiering Criteria of a Price Component

Note: This topic is not applicable for the health insurance business.

Prerequisites

To edit a tiering criteria for a price component, you should have:



- Tiering criteria defined in the application
- Tiering setup for the rate components defined in the application.



Procedure

To edit a tiering criteria of a price component:

1. Do either of the following:

If you want to edit the tiering criteria of.....	Then...
Price components of Price Item Pricing assigned to an account	<ol style="list-style-type: none"> 1. Search for the account in the Customer 360° View screen. 2. In the Search Results section, click the Show Context Menu () icon corresponding to the account whose details you want to view.

If you want to edit the tiering criteria of.....	Then...
	<p>A menu appears.</p> <ol style="list-style-type: none"> Click the Go To Effective Pricing menu option. The Pricing (Account) screen appears. Price assignments effective for the account appears in the Effective Price Assignments for Account zone. In the Search Results section, click the link in the Pricing Information column corresponding to the price item whose pricing details you want to view. The Price Item Pricing screen appears. <p>Tip: Alternatively, you can access the Price Item Pricing screen by:</p> <ol style="list-style-type: none"> Search for a price item in the Search Price Item or Price Item Pricing zone. In the Search Results section, click the Assign () icon corresponding to the price item. Enter the required details in the Price Item Pricing screen and click Save. The Price Item Pricing screen appears.
Price components of Price Item Pricing assigned to a person	<ol style="list-style-type: none"> Search for the person in the Customer 360° View screen. In the Search Results section, click the Show Context Menu () icon corresponding to the person whose details you want to view. A menu appears. Click the Go To Effective Pricing menu option. The Pricing (Person) screen appears. Price assignments effective for the person appears in the Effective Price Assignments for Person zone. In the Search Results section, click the link in the Pricing Information column corresponding to the price item whose pricing details you want to view. The Price Item Pricing screen appears.

If you want to edit the tiering criteria of.....	Then...
	<p>Tip: Alternatively, you can access the Price Item Pricing screen by:</p> <ol style="list-style-type: none"> 1. Search for a price item in the Search Price Item or Price Item Pricing zone. 2. In the Search Results section, click the Assign  icon corresponding to the price item. 3. Enter the required details in the Price Item Pricing screen and click Save. 4. The Price Item Pricing screen appears.
Price components of Price Item Pricing assigned to a price list	<ol style="list-style-type: none"> 1. Search for the price list in the Price List screen. 2. In the Search Results section, click the Price List Pricing  icon corresponding to the price list whose <i>details</i> you want to view. The Price List Price Item Pricing screen appears. 3. Price items assigned to the price list appears in the Price List Price Items zone. 4. In the Search Results section, click the link in the Pricing Information column corresponding to the price item whose pricing details you want to view. The Price Item Pricing screen appears. <p>Tip: Alternatively, you can access the Price Item Pricing screen by:</p> <ol style="list-style-type: none"> 1. Search for a price item in the Search Price Item or Price Item Pricing zone. 2. In the Search Results section, click the Assign  icon corresponding to the price item. 3. Enter the required details in the Price Item Pricing screen and click Save. 4. The Price Item Pricing screen appears.

2. Ensure that the **Pricing Structure** zone is expanded while defining or editing the tiering criteria of a price component.
3. Click the **Add** (+) icon corresponding to the price component whose tiering criteria you want to edit.
The **Price Component** zone appears.
4. In the **Price Components** zone, click the **Show Price Component Tier** section.

Note:

The **Tiering Criteria** zone appears when **Tiering Type** for the rate component is **STEP** or **Threshold**.

The **Tiering Criteria** section appears. This section contains the following fields:

Field Name	Field Description	Mandatory (Yes or No)
Sequence	Used to indicate the sequence in which tiering criteria is to be considered.	Yes
Tiering Criterion	Used to select the tiering criterion which is used in the tiering range.	Yes
Lower Limit	Used to specify the lower limit of the pricing range. Note: The system provides you with the facility to specify the lower limit value with a precision of up to 18 places before decimal and 18 places after decimal. This gives you the flexibility to specify very large and very low values in the tiering range.	Yes
Upper Limit	Used to specify the upper limit of the pricing range. Note: The system provides you with the facility to specify the upper limit value with a precision of up to 18 places before decimal and 18 places after decimal. This gives you the flexibility to specify very large and very low values in the tiering range. When you define single tier with the maximum value as blank (for example, 0 to BLANK), the system will automatically replace the blank space with 9999999999999999.99.	Yes
Price Item	Used to Indicate whether the price item or price item bundle's total usage is considered for determining the rate. By default, the price item code for which you defined the pricing appears in this field. You can specify any other price item or bundle code, if required. Note: The Search (🔍) icon appears corresponding to this field. On clicking the Search icon, the Price Item Search screen appears.	Yes
Price Parameters	Item Used to specify the parameters based on which price item or bundle's total usage should be considered for determining the rate. By default, the parameters based on which you are defining the pricing appear in this field. You can specify any other parameters (where the Pricing flag is set to Yes), if required. However, note that you can only select parameters associated with the price item or bundle which is used for defining the tiering criteria.	No

Field Name	Field Description	Mandatory (Yes or No)
	<p>Note:</p> <p>This field appears when the Multi Price Parameter option type of the Multi Parameter Based Pricing (C1_PPARM_FLG) feature configuration is set to True.</p> <p>The Edit (✎) appears corresponding to this field. On clicking the Edit icon, the Parameters Search screen appears.</p>	

5. Modify the tiering criteria for a price component.

6. Click **Save**.

The tiering criteria is edited for a price component.

Related Topics

For more information on...	See...
360° Search zone	360° Search on page 198
How to search for a person.	Searching for a Person on page 203
How to search for an account.	Searching for an Account on page 204
Search Price List zone	Search Price List on page 439
How to search for a price list.	Searching for a Price List on page 449
Price Components zone	Price Component on page 622
How to define a price component for a rate component	Defining a Price Component for a Rate Component on page 647
How to define a tiering criteria for a price component.	Defining a Tiering Criteria for a Price Component on page 652

Editing a Pricing Eligibility Criteria of a Price Component

Note: This topic is not applicable for the health insurance business.

Prerequisites



To edit a pricing eligibility criteria for a price component, you should have:



- Pricing eligibility defined in the application

Procedure

To edit a pricing eligibility criteria of a price component:

1. Do either of the following:

If you want to edit the pricing eligibility criteria of.....	Then...
Price components of Price Item Pricing assigned to an account	<ol style="list-style-type: none"> 1. Search for the account in the Customer 360° View screen. 2. In the Search Results section, click the Show Context Menu () icon corresponding to the account whose <i>details</i> you want to view. A menu appears. 3. Click the Go To Effective Pricing menu option. The Pricing (Account) screen appears. 4. Price assignments effective for the account appears in the Effective Price Assignments for Account zone. 5. In the Search Results section, click the link in the Pricing Information column corresponding to the price item whose pricing details you want to view. The Price Item Pricing screen appears. <p>Tip: Alternatively, you can access the Price Item Pricing screen by:</p> <ol style="list-style-type: none"> 1. Search for a price item in the Search Price Item or Price Item Pricing zone. 2. In the Search Results section, click the Assign () icon corresponding to the price item. 3. Enter the required details in the Price Item Pricing screen and click Save. 4. The Price Item Pricing screen appears.
Price components of Price Item Pricing assigned to a person	<ol style="list-style-type: none"> 1. Search for the person in the Customer 360° View screen. 2. In the Search Results section, click the Show Context Menu () icon corresponding to the person whose <i>details</i> you want to view. A menu appears. 3. Click the Go To Effective Pricing menu option. The Pricing (Person) screen appears. 4. Price assignments effective for the person appears in the Effective Price Assignments for Person zone. 5. In the Search Results section, click the link in the Pricing Information column corresponding to the price item whose pricing details you want to view. The Price Item Pricing screen appears.

If you want to edit the pricing eligibility criteria of.....	Then...
	<p>Tip: Alternatively, you can access the Price Item Pricing screen by:</p> <ol style="list-style-type: none"> 1. Search for a price item in the Search Price Item or Price Item Pricing zone. 2. In the Search Results section, click the Assign  icon corresponding to the price item. 3. Enter the required details in the Price Item Pricing screen and click Save. 4. The Price Item Pricing screen appears.
Price components of Price Item Pricing assigned to a price list	<ol style="list-style-type: none"> 1. Search for the price list in the Price List screen. 2. In the Search Results section, click the Price List Pricing  icon corresponding to the price list whose details you want to view. The Price List Price Item Pricing screen appears. 3. Price items assigned to the price list appears in the Price List Price Items zone. 4. In the Search Results section, click the link in the Pricing Information column corresponding to the price item whose pricing details you want to view. The Price Item Pricing screen appears. <p>Tip: Alternatively, you can access the Price Item Pricing screen by:</p> <ol style="list-style-type: none"> 1. Search for a price item in the Search Price Item or Price Item Pricing zone. 2. In the Search Results section, click the Assign  icon corresponding to the price item. 3. Enter the required details in the Price Item Pricing screen and click Save. 4. The Price Item Pricing screen appears.

2. Ensure that the **Pricing Structure** zone is expanded while defining or editing the tiering criteria of a price component.
3. Click the **Add** (+) icon corresponding to the price component whose tiering criteria you want to edit.
The **Price Component** zone appears.
4. In the **Price Components** zone, click the **Show Price Component Eligibility** section.

Note:

The **Pricing Eligibility Criteria** zone appears when eligibility checkbox is selected in the **Price Item Pricing** screen and details for pricing eligibility criteria is added in the **Price Component** screen.

The **Pricing Eligibility Criteria** section appears.. It contains the following fields:

Column Name	Column Description	Mandatory (Yes or No)
Sequence	Used to indicate the order in which the criteria to be executed in the rule.	Yes
Parameter	<p>Used to indicate the left hand side parameter which you want to use along with the price item for price determination.</p> <p>Note: This field appears when the Multi Price Parameter option type of the Multi Parameter Based Pricing (C1_PPARAM_FLG) feature configuration is set to True.</p> <p>The Search (🔍) icon appears corresponding to this field. On clicking the Search icon, the Price Item Search screen appears.</p> <p>You must not specify any special character except underscore (_) in the parameter code. Otherwise, the status of the transaction is changed to Error (ERROR).</p>	Yes
Operator	<p>Used to specify the relational operator to define the relation between the left hand side and right hand side parameters code. The valid values are:</p> <ul style="list-style-type: none"> • < • <= • <> • = • > • >= • Algorithm • Between • In • Like 	Yes
Parameter Value Type	<p>Used to indicate the type of pricing eligibility. The valid values are:</p> <ul style="list-style-type: none"> • Parameter – Used to indicate the type of parameter. • Value – Used to indicate the type of value. 	Yes

Column Name	Column Description	Mandatory (Yes or No)
Parameter Value	<p>When the Parameter option is selected for the Parameter Value Type field then it is used to specify the right hand side parameter which you want to use along with the price item for price determination. When the Value option is selected for the Parameter Value Type field then it is used to specify the parameter value.</p> <p>Note:</p> <p>This field appears when the Multi Price Parameter option type of the Multi Parameter Based Pricing (C1_PPARAM_FLG) feature configuration is set to True.</p> <p>The Search (🔍) icon appears corresponding to this field when the Parameter option is selected for Parameter Value Type field. On clicking the Search icon, the Price Item Search screen appears.</p> <p>When the Parameter option is selected for the Parameter Value Type field then you must not specify any special character except underscore (_) in the parameter code. Otherwise, the status of the transaction is changed to Error (ERROR).</p> <p>When the Value option is selected for the Parameter Value Type field then you can specify any special characters except ampersand (&), comma (,), underscore (_), equal to (=), tilde (~), and semi-colon (;) in the parameter value.</p>	Yes
Is True	<p>Used to indicate what should happen when the condition is true (satisfied). The valid values are:</p> <ul style="list-style-type: none"> • Check Next Condition – Used to indicate that the condition with consecutive sequence number should be executed. • Rule Is False – Used to indicate that the action specified in the Rule False Action field should be executed. • Rule Is True – Used to indicate that the action specified in the Rule True Action field should be executed. 	Yes
Is False	<p>Used to indicate what should happen when the condition is false (not satisfied). The valid values are:</p> <ul style="list-style-type: none"> • Check Next Condition – Used to indicate that the condition with consecutive sequence number should be executed. • Rule Is False – Used to indicate that the action specified in the Rule False Action field should be executed. 	Yes

Column Name	Column Description	Mandatory (Yes or No)
	<ul style="list-style-type: none"> Rule Is True – Used to indicate that the action specified in the Rule True Action field should be executed. 	
Is Insufficient	<p>Used to indicate what should happen when the data is insufficient. The valid values are:</p> <ul style="list-style-type: none"> Check Next Condition – Used to indicate that the condition with consecutive sequence number should be executed. Rule Is False – Used to indicate that the action specified in the Rule False Action field should be executed. Rule Is True – Used to indicate that the action specified in the Rule True Action field should be executed. 	Yes

5. Modify the pricing eligibility criteria for a price component.

6. Click **Save**.

The pricing eligibility criteria is edited for a price component.

Related Topics

For more information on...	See...
360° Search zone	360° Search on page 198
How to search for a person.	Searching for a Person on page 203
How to search for an account.	Searching for an Account on page 204
Search Price List zone	Search Price List on page 439
How to search for a price list.	Searching for a Price List on page 449
Price Components zone	Price Component on page 622
How to define a price component for a rate component	Defining a Price Component for a Rate Component on page 647
How to define a pricing eligibility criteria for a price component	Defining a Pricing Eligibility Criteria for a Price Component on page 654

Editing a Price Item Pricing

Note: This topic is not applicable for the health insurance business.

Prerequisites

To edit a price item pricing, you should have:



- Transactions mapped to the price item defined in the application
- Rate schedules, rate versions, rate components defined in the application
- Tiering criteria defined in the application



- Tiering setup for the rate components defined in the application
- Pricing eligibility defined in the application
- Parameters associated with the price item (in case you want to define price item pricing based on those parameters)



Procedure



To edit a price item pricing:

1. Do either of the following:

If you want to...	Then...
<p>Edit pricing of a price item that is assigned to a person from Customer 360° View screen</p>	<ol style="list-style-type: none"> 1. Search for the person in the Customer 360° View screen. 2. In the Search Results section, click the Show Context Menu () icon corresponding to the person whose <i>details</i> you want to view. A menu appears. 3. Click the Go To Effective Pricing menu option. The Pricing (Person) screen appears. 4. Price assignments effective for the person appears in the Effective Price Assignments for Person zone. 5. You can edit the pricing item pricing through the following alternatives: <ol style="list-style-type: none"> a. First alternative, <ul style="list-style-type: none"> • In the Search Results section of Effective Price Assignments for Person zone, click the Edit () icon in the Edit column corresponding to the price item pricing whose details you want to edit. The Price Item Pricing screen appears to edit the pricing details of a price item. b. Second alternative, <ul style="list-style-type: none"> • In the Search Results section of Effective Price Assignments for Person zone, click the link in the Pricing Information column corresponding to the price item whose pricing details you want to view. The Price Item Pricing screen appears.

If you want to...	Then...
	<ul style="list-style-type: none"> • Click the Edit button in the Record Actions section. The Price Item Pricing screen appears to edit the pricing details of a price item. <div style="border: 1px solid black; padding: 5px; margin: 5px 0;"> <p>Note: The Edit button appears when the price item pricing is in the Draft status.</p> </div> <p>c. Third alternative,</p> <ul style="list-style-type: none"> • Search for a price item in the Search Price Item or Price Item Pricing zone. In the Search Results section, click the Assign  icon corresponding to the price item. • Enter the required details in the Price Item Pricing screen and click Save. The Price Item Pricing screen appears. • Click the Edit button in the Record Actions section. The Price Item Pricing screen appears to edit the pricing details of a price item. <div style="border: 1px solid black; padding: 5px; margin: 5px 0;"> <p>Note: The Edit button appears when the price item pricing is in the Draft status.</p> </div>
<p>Edit pricing of a price item that is assigned to an account from Customer 360° View screen</p>	<ol style="list-style-type: none"> 1. Search for the person in the Customer 360° View screen. 2. In the Search Results section, click the Show Context Menu () icon corresponding to the account whose <i>details</i> you want to view. A menu appears. 3. Click the Go To Effective Pricing menu option. The Pricing (Account) screen appears. 4. Price assignments effective for the account appears in the Effective Price Assignments for Account zone.

If you want to...	Then...
	<p data-bbox="846 201 1399 264">5. You can edit the pricing item pricing through the following alternatives:</p> <p data-bbox="911 296 1122 321">a. First alternative,</p> <ul data-bbox="976 342 1399 569" style="list-style-type: none"> <li data-bbox="976 342 1399 569">• In the Search Results section of Effective Price Assignments for Account zone, click the Edit  icon in the Edit column corresponding to the price item pricing whose details you want to edit. <p data-bbox="1013 590 1399 678">The Price Item Pricing screen appears to edit the pricing details of a price item.</p> <p data-bbox="911 709 1154 735">b. Second alternative,</p> <ul data-bbox="976 756 1399 982" style="list-style-type: none"> <li data-bbox="976 756 1399 982">• In the Search Results section of Effective Price Assignments for Account zone, click the link in the Pricing Information column corresponding to the price item whose pricing details you want to view. <p data-bbox="1013 1003 1399 1066">The Price Item Pricing screen appears.</p> <ul data-bbox="976 1077 1399 1140" style="list-style-type: none"> <li data-bbox="976 1077 1399 1140">• Click the Edit button in the Record Actions section. <p data-bbox="1013 1161 1399 1249">The Price Item Pricing screen appears to edit the pricing details of a price item.</p> <div data-bbox="1003 1270 1399 1381" style="border: 1px solid black; padding: 5px;"> <p data-bbox="1013 1276 1399 1367">Note: The Edit button appears when the price item pricing is in the Draft status.</p> </div> <p data-bbox="911 1413 1138 1438">c. Third alternative,</p> <ul data-bbox="976 1459 1399 1547" style="list-style-type: none"> <li data-bbox="976 1459 1399 1547">• Search for a price item in the Search Price Item or Price Item Pricing zone. <p data-bbox="1013 1568 1399 1682">In the Search Results section, click the Assign  icon corresponding to the price item.</p> <ul data-bbox="976 1703 1399 1791" style="list-style-type: none"> <li data-bbox="976 1703 1399 1791">• Enter the required details in the Price Item Pricing screen and click Save. <p data-bbox="1013 1812 1399 1875">The Price Item Pricing screen appears.</p>

If you want to...	Then...
	<ul style="list-style-type: none"> Click the Edit button in the Record Actions section. <p>The Price Item Pricing screen appears to edit the pricing details of a price item.</p> <div style="border: 1px solid black; padding: 5px;"> <p>Note: The Edit button appears when the price item pricing is in the Draft status.</p> </div>
<p>Edit pricing of a price item that is assigned to a price list from Price List screen</p>	<ol style="list-style-type: none"> Search for the price list in the Price List screen. In the Search Results section of Price List Price Items zone, click the link in the Pricing Information column corresponding to the price item whose pricing details you want to view. <p>The Price Item Pricing screen appears.</p> <ol style="list-style-type: none"> Click the Edit button in the Record Actions section. <p>The Price Item Pricing screen appears to edit the pricing details of a price item.</p> <div style="border: 1px solid black; padding: 5px;"> <p>Note: The Edit button appears when the price item pricing is in the Draft status.</p> </div>
<p>Edit pricing of a price item that is assigned to a price list from Price List Price Item Pricing screen</p>	<ol style="list-style-type: none"> Search for the price list in the Price List screen. <p>In the Search Results section, click the Price List Pricing () icon corresponding to the price list whose <i>details</i> you want to view.</p> <p>The Price List Price Item Pricing screen appears.</p> <ol style="list-style-type: none"> Price items assigned to the price list appears in the Price List Price Items zone. You can edit the pricing item pricing through the following alternatives: <ol style="list-style-type: none"> First alternative, <ul style="list-style-type: none"> In the Search Results section of Price List Price Items zone, click the Edit () icon in the Edit column corresponding to the price item pricing whose details you want to edit. <p>The Price Item Pricing screen appears to edit the pricing details of a price item.</p>

If you want to...	Then...
	<p>b. Second alternative,</p> <ul style="list-style-type: none"> • Search for a price item in the Search Price Item or Price Item Pricing zone. <p>In the Search Results section, click the Assign  icon corresponding to the price item.</p> <ul style="list-style-type: none"> • Enter the required details in the Price Item Pricing screen and click Save. <p>The Price Item Pricing screen appears.</p> <ul style="list-style-type: none"> • Click the Edit button in the Record Actions section. <p>The Price Item Pricing screen appears to edit the pricing details of a price item.</p> <div style="border: 1px solid black; padding: 5px; margin-top: 10px;"> <p>Note: The Edit button appears when the price item pricing is in the Draft status.</p> </div>

The **Price Item Pricing** screen appears.

2. Modify the required pricing details.

Note:

If you change the effective start and end dates while editing a price item pricing, you need to specify the parameters which are effective during that date range.

You can search for parameter, rate schedule by clicking the **Search**  icon corresponding to the respective fields.

3. Edit the deal information in a price item pricing, if required.
4. Edit the TFM information in a price item pricing, if required.
5. Edit the characteristics for a price item pricing, if required.
6. Edit the parameters for a price item pricing, if required.
7. Edit the price assignment, if required.
8. Edit the pricing commitments, if required.
9. Click **Save**.

Note:

If any value other than **Status** and **End Date** is updated then the price item pricing for the price item is end with **End Date** updated as (today's date -1) and a new price item pricing is generated for the price item with new price item pricing ID and start date as today's date.

The **Edit Price Components** button appears when you are editing a price assignment which is in the **Active**, **Proposed**, or **Template** status and which is not past dated; If the approval workflow is on, then the **Edit Price Components** button appears when you are editing a proposed and template price assignment which is already approved.

When the price assignment is in **Draft** status and,

- When the approval workflow is on and is in **Draft** status then it is changed to **Pending in Approval**.

When the price assignment is in **Draft** status and,

- When the approval workflow is off and is in **Draft** status then it is changed to **Active**.

The changes made to the price item pricing are saved.

Related Topics

For more information on...	See...
360° Search zone	360° Search on page 198
How to search for a person.	Searching for a Person on page 203
Pricing (Person) screen	Pricing (Person) on page 582
Effective Price Assignments for Person zone	Effective Price Assignments for Person on page 583
How to search for an account.	Searching for an Account on page 204
Pricing (Account) screen	Pricing (Account) on page 550
Effective Price Assignments for Account zone	Effective Price Assignments for Account on page 550
Search Price List zone	Search Price List on page 439
How to search for a price list.	Searching for a Price List on page 449
Price List Price Item Pricing screen	Price List Price Item Pricing on page 468
Price List Price Items zone	Price List Price Items on page 469
Price Item Pricing screen	Price Item Pricing (Used for Viewing) on page 614
How to define a price item pricing for an account.	Assigning a Price Item to an Account on page 575
How to define a price item pricing for a person.	Assigning a Price Item to a Person on page 607
How to define a price item pricing for a price list.	Assigning a Price Item to a Price List on page 484
How to define a characteristic for a price item pricing.	Defining a Characteristic for a Price Item Pricing on page 492
How to define parameters for a price item pricing.	Defining a Parameter for a Price Item Pricing on page 579
How to define TFM Information in a price item pricing.	Defining TFM Information in a Price Item Pricing on page 491
How to define deal information in a price item pricing	Defining the Deal Information in a Price Item Pricing on page 490

For more information on...	See...
How to define average price floor and ceil limits for a division in a price item pricing	Defining the Average Price Floor and Ceil Values of a Price Item or Price Item Bundle for a Division on page 387
How to define negotiability floor and ceil limits for a division in a price item pricing	Defining the Rate Negotiability Floor and Ceil Values of a Price Item or Price Item Bundle for a Division on page 390
How to define cost of a price item for a division in a price item pricing	Defining the Cost of a Price Item or Price Item Bundle for a Division on page 384

Deleting a Price Item Pricing



Note: This topic is not applicable for the health insurance business.

Procedure

To delete a price item pricing:

1. Do either of the following:

If you want to delete...	Then...
Price Item Pricing assigned to an account	<ol style="list-style-type: none"> 1. Search for the account in the Customer 360° View screen. 2. In the Search Results section, click the Show Context Menu (▼) icon corresponding to the account whose <i>details</i> you want to view. A menu appears. 3. Click the Go To Effective Pricing menu option. The Pricing (Account) screen appears. 4. Price assignments effective for the account appears in the Effective Price Assignments for Account zone. 5. In the Search Results section, click the link in the Pricing Information column corresponding to the price item whose pricing details you want to view. The Price Item Pricing screen appears. <p>Tip: Alternatively, you can access the Price Item Pricing screen by:</p> <ol style="list-style-type: none"> 1. Search for a price item in the Search Price Item or Price Item Pricing zone. 2. In the Search Results section, click the Assign (📄) icon corresponding to the price item. 3. Enter the required details in the Price Item Pricing screen and click Save. 4. The Price Item Pricing screen appears.

If you want to delete...	Then...
Price Item Pricing assigned to a person	<ol style="list-style-type: none"> 1. Search for the person in the Customer 360° View screen. 2. In the Search Results section, click the Show Context Menu () icon corresponding to the person whose <i>details</i> you want to view. A menu appears. 3. Click the Go To Effective Pricing menu option. The Pricing (Person) screen appears. 4. Price assignments effective for the person appears in the Effective Price Assignments for Person zone. 5. In the Search Results section, click the link in the Pricing Information column corresponding to the price item whose pricing details you want to view. The Price Item Pricing screen appears. <p>Tip: Alternatively, you can access the Price Item Pricing screen by:</p> <ol style="list-style-type: none"> 1. Search for a price item in the Search Price Item or Price Item Pricing zone. 2. In the Search Results section, click the Assign () icon corresponding to the price item. 3. Enter the required details in the Price Item Pricing screen and click Save. 4. The Price Item Pricing screen appears.
Price Item Pricing assigned to a price list	<ol style="list-style-type: none"> 1. Search for the price list in the Price List screen. 2. In the Search Results section, click the Price List Pricing () icon corresponding to the price list whose <i>details</i> you want to view. The Price List Price Item Pricing screen appears. 3. Price items assigned to the price list appears in the Price List Price Items zone. 4. In the Search Results section, click the link in the Pricing Information column corresponding to the price item whose pricing details you want to view. The Price Item Pricing screen appears.

If you want to delete...	Then...
	<p>Tip: Alternatively, you can access the Price Item Pricing screen by:</p> <ol style="list-style-type: none"> 1. Search for a price item in the Search Price Item or Price Item Pricing zone. 2. In the Search Results section, click the Assign  icon corresponding to the price item. 3. Enter the required details in the Price Item Pricing screen and click Save. 4. The Price Item Pricing screen appears.

2. Click the **Delete** button in the **Record Actions** zone.

<p>Note:</p> <p>When the price assignment is in Draft status then the Delete button appears.</p> <p>When the price assignment is in Draft status and when the approval workflow is on and:</p> <ul style="list-style-type: none"> • If the approval workflow is in Draft status then it is changed to Pending in Approval. • If the approval workflow is in Proposed status and, <ul style="list-style-type: none"> • If the price assignment is not approved for the first time then Delete button appears. • If the price assignment is approved then Delete button does not appear. • When the approval workflow is in Template status and, <ul style="list-style-type: none"> • If the price assignment is not approved for the first time then Delete button appears. • If the price assignment is approved then Delete button does not appear. <p>When the price assignment is in Draft status, and when the approval workflow is off and is in Draft status then it is changed to Active.</p>
--

A message appears confirming whether you want to delete the price item pricing.

3. Click **OK**.

The price item pricing is deleted.

Related Topics

For more information on...	See...
360–Degree Search zone	360° Search on page 198
How to search for a person.	Searching for a Person on page 203
How to search for an account.	Searching for an Account on page 204
Search Price List zone	Search Price List on page 439
How to search for a price list.	Searching for a Price List on page 449
How to view a price item pricing	Price Item Pricing (Used for Viewing) on page 614
Price Item Pricing zone	Price Item Pricing on page 616



Submitting a Price Item Pricing



Note: This topic is not applicable for the health insurance business.

Procedure

To submit pricing for a price item:

1. Do either of the following:

If you want to...	Then...
Submit pricing of a price item that is assigned to a person	<ol style="list-style-type: none"> 1. Search for the person in the Customer 360° View screen. 2. In the Search Results section, click the Show Context Menu () icon corresponding to the person whose <i>details</i> you want to view. A menu appears. 3. Click the Go To Effective Pricing menu option. The Pricing (Person) screen appears. 4. Price assignments effective for the person appears in the Effective Price Assignments for Person zone. 5. In the Search Results section, click the link in the Pricing Information column corresponding to the price item whose pricing details you want to view. The Price Item Pricing screen appears. <p>Tip: Alternatively, you can access the Price Item Pricing screen by:</p> <ol style="list-style-type: none"> 1. Search for a price item in the Search Price Item or Price Item Pricing zone. 2. In the Search Results section, click the Assign () icon corresponding to the price item. 3. Enter the required details in the Price Item Pricing screen and click Save. 4. The Price Item Pricing screen appears.
Submit pricing of a price item that is assigned to an account	<ol style="list-style-type: none"> 1. Search for the person in the Customer 360° View screen.

If you want to...	Then...
	<p data-bbox="846 201 1399 310">2. In the Search Results section, click the Show Context Menu () icon corresponding to the person whose <i>details</i> you want to view.</p> <p data-bbox="883 327 1065 359">A menu appears.</p> <p data-bbox="846 386 1399 464">3. Click the Go To Effective Pricing menu option.</p> <p data-bbox="883 434 1305 466">The Pricing (Account) screen appears.</p> <p data-bbox="846 493 1399 583">4. Price assignments effective for the person appears in the Effective Price Assignments for Account zone.</p> <p data-bbox="846 611 1399 737">5. In the Search Results section, click the link in the Pricing Information column corresponding to the price item whose pricing details you want to view.</p> <p data-bbox="883 758 1312 789">The Price Item Pricing screen appears.</p> <p data-bbox="818 827 1399 890">Tip: Alternatively, you can access the Price Item Pricing screen by:</p> <p data-bbox="846 917 1399 980">1. Search for a price item in the Search Price Item or Price Item Pricing zone.</p> <p data-bbox="846 1008 1399 1085">2. In the Search Results section, click the Assign () icon corresponding to the price item.</p> <p data-bbox="846 1113 1399 1176">3. Enter the required details in the Price Item Pricing screen and click Save.</p> <p data-bbox="846 1203 1312 1234">4. The Price Item Pricing screen appears.</p>
Submit pricing of a price item that is assigned to a pricelist	<p data-bbox="846 1316 1399 1348">1. Search for the price list in the Price List screen.</p> <p data-bbox="846 1375 1399 1484">2. In the Search Results section, click the Price List Pricing () icon corresponding to the price list whose <i>details</i> you want to view.</p> <p data-bbox="883 1499 1399 1562">The Price List Price Item Pricing screen appears.</p> <p data-bbox="846 1589 1399 1652">3. Price items assigned to the price list appears in the Price List Price Items zone.</p> <p data-bbox="846 1680 1399 1806">4. In the Search Results section of Price List Price Items zone, click the link in the Pricing Information column corresponding to the price item whose pricing details you want to view.</p> <p data-bbox="883 1827 1312 1858">The Price Item Pricing screen appears.</p>

If you want to...	Then...
	<p>Tip: Alternatively, you can access the Price Item Pricing screen by:</p> <ol style="list-style-type: none"> 1. Search for a price item in the Search Price Item or Price Item Pricing zone. 2. In the Search Results section, click the Assign  icon corresponding to the price item. 3. Enter the required details in the Price Item Pricing screen and click Save. 4. The Price Item Pricing screen appears.

2. Click the **Submit** button in the **Record Actions** section.

Note:
<p>When the price assignment is in Draft status and when the approval workflow is on and:</p> <ul style="list-style-type: none"> • When the approval workflow is in Draft status then it is changed to Pending in Approval. • When the approval workflow is in Proposed status and on clicking the Submit button, the status does not change and remains the same. • When the approval workflow is in Template status and on clicking the Submit button, the status does not change and remains the same. <p>When the price assignment is in Draft status and when the approval workflow is off and:</p> <ul style="list-style-type: none"> • When the approval workflow is in Draft status then it is changed to Active. • When the approval workflow is in Proposed status then on clicking the Submit button, the status does not change and remains the same. • When the approval workflow is in Template status then on clicking the Submit button, the status does not change and remains the same.

Related Topics

For more information on...	See...
360° Search zone	360° Search on page 198
How to search for a person.	Searching for a Person on page 203
Pricing (Person) screen	Pricing (Person) on page 582
Effective Price Assignments for Person zone	Effective Price Assignments for Person on page 583
How to search for an account.	Searching for an Account on page 204
Pricing (Account) screen	Pricing (Account) on page 550
Effective Price Assignments for Account zone	Effective Price Assignments for Account on page 550
Search Price List zone	Search Price List on page 439
How to search for a price list.	Searching for a Price List on page 449

For more information on...	See...
Price List Price Item Pricing screen	<i>Price List Price Item Pricing</i> on page 468
Price List Price Items zone	<i>Price List Price Items</i> on page 469
Price Item Pricing screen	<i>Price Item Pricing (Used for Viewing)</i> on page 614

Overriding a Price Item Pricing

Note: This topic is not applicable for the health insurance business.

Prerequisites



To override a price item pricing, you should have:

- Transactions mapped to the price item defined in the application
- Rate schedules, rate versions, rate components defined in the application
- Tiering criteria defined in the application
- Tiering setup for the rate components defined in the application
- Pricing eligibility defined in the application
- Parameters associated with the price item (in case you want to define price item pricing based on multiple parameters)

Procedure

To override a price item pricing:

1. Do either of the following:

If you want to...	Then...
Override price item pricing assigned to the customer either directly or through the customer hierarchy or price list	<ol style="list-style-type: none"> 1. Access the Pricing (Person) screen. 2. In the Effective Price Assignment zone, click the Override  icon in the Override column corresponding to the price item pricing that you want to override.
Override price item pricing assigned to the account either directly or through the customer hierarchy or price list	<ol style="list-style-type: none"> 1. Access the Pricing (Account) screen. 2. In the Effective Price Assignment zone, click the Override  icon in the Override column corresponding to the price item pricing that you want to override.

The **Price Item Pricing** screen appears.

2. Modify the required pricing details.

Note:

If you change the effective start and end dates while overriding a price item pricing, you need to specify the parameters which are effective during that date range.

While overriding a price item pricing, you can not only edit the existing tiering combination details, but also add additional tiering combinations until the maximum tiering combinations limit is met.

3. Modify the price assignment characteristics, if required.
4. Click **Save**.

The price item pricing is overridden.

Related Topics

For more information on...	See...
Pricing (Person) screen	Pricing (Person) on page 582
Search Price Item or Price Item Pricing zone	Search Price Item or Price Item Pricing on page 587
Pricing (Account) screen	Pricing (Account) on page 550
Search Price Item or Price Item Pricing zone	Search Price Item or Price Item Pricing on page 555
Price List Price Item Pricing screen	Price List Price Item Pricing on page 468
Search Price Item or Price Item Pricing zone	Search Price Item or Price Item Pricing on page 470
Price Item Pricing screen	Price Item Pricing (Used for Viewing) on page 614
How to define the deal Information in a price item pricing.	Defining the Deal Information in a Price Item Pricing on page 490
How to define the TFM Information in a price item pricing.	Defining TFM Information in a Price Item Pricing on page 491
How to define a characteristic for a price item pricing.	Defining a Characteristic for a Price Item Pricing on page 492
How to define a parameter for a price item pricing.	Defining a Parameter for a Price Item Pricing on page 579
How to define a division-specific cost of a price item in the price item pricing	Defining the Division-Specific Cost of a Price item in the Price Item Pricing on page 495
How to define a division-specific average price limit of a price item in the price item pricing	Defining the Division-Specific Average Price Limits of a Price item in the Price Item Pricing on page 496
How to define a division-specific rate negotiability limit of a price item in the price item pricing	Defining the Division-Specific Rate Negotiability Limits of a Price item in the Price Item Pricing on page 498

Editing the Two-Dimensional Pricing

Note: This topic is not applicable for the health insurance business.

Procedure

To edit a two-dimensional pricing:

1. Search for the account in the **Customer 360° View** screen.

- In the **Search Results** section, click the **Show Context Menu** () icon corresponding to the account whose details you want to view.

A menu appears.

- Click the **Go To Effective Pricing** menu option.

The **Pricing (Person)** screen appears.

- Search for the price item pricing in the **Search Price Item or Price Item Pricing** screen.

- Click the **Assign** icon () corresponding to the **Price Item Information**.

The **Price Item Pricing** screen appears. It contains the following fields:

Field Name	Field Description	Mandatory (Yes or No)
Start Date	Displays the date from when the price item pricing is effective.	Yes
End Date	Displays the date till when the price item pricing is effective.	No
Rate Schedule	Indicates the rate schedule used while defining price item pricing. Note: It has a link. On clicking the link, the Rate Schedule screen appears where you can view the details of the rate schedule.	Yes
Print Zero	Indicates the zero pricing displayed in the bill. The valid values are: <ul style="list-style-type: none"> • Yes • No 	Yes
Pricing Currency	Indicates the currency in which the price item pricing is defined. Note: It has a link. On clicking the link, the Currency screen appears where you can view the details of the currency.	Yes
Pricing Status	Indicates the status of the price assignment. The valid values are: <ul style="list-style-type: none"> • Draft • Active • Inactive • Proposed • Rejected • Template 	Yes
Price Assignment Type	Indicates the type of price assignment. The valid values are: <ul style="list-style-type: none"> • Regular • Post Processing 	Yes

Field Name	Field Description	Mandatory (Yes or No)
	<ul style="list-style-type: none"> Post Processing – Invoice Based Post Processing – Price Item Based 	
Pricing Eligibility	Displays the pricing eligibility criteria for price item pricing.	Yes
Pricing Rule Type	Indicates the pricing rule type. The valid value is: <ul style="list-style-type: none"> Two-Dimensional 	Yes

6. Click **Save**.

The **Price Item Pricing** screen appears.

7. Click the **Edit** link in the top-right of the **Two-Dimensional Pricing** zone.

The **Two-Dimensional Pricing** screen appears. It contains the following fields in a grid:

Field Name	Field Description
Step Criterion	Used to search by the various criterion.
Threshold Parameter	Used to search by the threshold parameter.
Tiering Range	Displays the tiering range of the pricing.

8. Modify the details in the **Two-Dimensional Pricing** screen, if required.

9. If you want to add more than one threshold parameter, click the **Add (+)** icon and then enter the threshold parameter name and its value.

However, if you want to remove a threshold parameter, click the **Delete (🗑)** icon corresponding to the parameter.

10. If you want to add more than one tiering range, click the **Add (+)** icon and then enter the specific range.

However, if you want to remove a tiering range, click the **Delete (🗑)** icon corresponding to the range that you want to remove.

11. Click **Save**.

The changes made to the two-dimensional pricing are saved.

Related Topics

For more information on...	See...
How to search for a price list	Searching for a Price List on page 449

Pricing Simulation

Note: This topic is not applicable for the health insurance business.

The **Pricing Simulation** screen allows you to:

- View pricing simulation details for account or price list
- View effective pricing information
- Search simulation details of account or price list

This screen consists of the following zones:

- [Search Pricing](#) on page 695

Through the **Pricing Simulation** screen, you can navigate to the following screens:

- [Price Item \(Used for Viewing\)](#) on page 402
- [Simulation - Effective Pricing Information](#) on page 699

Search Pricing

Note: This topic is not applicable for the health insurance business.

The **Search Pricing** zone allows you to search pricing for an account.

In case of bundles, the order in which the price item pricing is listed in this zone is based on the following condition:

- If the system finds pricing for price items that belong to a bundle before finding pricing for the bundle, then the system lists the pricing for price items that belong to the bundle, and not the pricing for the bundle. For example, let say, B0001 is a bundle, and contains C0001 and C0002 price items. If the system finds pricing for B0001, it validates whether the pricing for C0001 and C0002 has already been found. If yes, then the system lists the pricing for C0001 and C0002. If the system does not find pricing for C0001 and C0002 before finding pricing for B0001, it lists the pricing for B0001.

Note: If the effective pricing is available for the price item, regular bundle (to which the price item belongs), and parent (regular) bundle (i.e. to which the regular bundle belongs) at the same level, the system lists the pricing depending on the value defined for the **Prefer Price Item Over Bundle** parameter in the price assignment search algorithm. If the value of the **Prefer Price Item Over Bundle** parameter is set to **Y**, the system lists effective pricing which is available for the price item. If the effective pricing is not available for the price item, then the system lists effective pricing which is available for the regular bundle at the same level. If the effective pricing is not available for the regular bundle, then the system lists effective pricing which is available for the parent bundle at the same level. However, if the value of the **Prefer Price Item Over Bundle** parameter is set to **N**, the system lists effective pricing which is available for the parent bundle. If the effective pricing is not available for the parent bundle, then the system lists effective pricing which is available for the regular bundle at the same level. If the effective pricing is not available for the regular bundle, then the system lists effective pricing which is available for the price item at the same level.

This zone contains the following two sections:

- **Search Criteria** — The **Search Criteria** section contains the following two options:

Field Name	Field Description	Mandatory (Yes or No)
Search By	Used to indicate whether you want to search for pricing using price list or account or person details. The valid values are: <ul style="list-style-type: none"> • Price List • Account /Person <p>Note: By default, Price List option is selected.</p>	Yes
Price List ID	Used to indicate Price List ID for which simulation must be created.	Yes

Field Name	Field Description	Mandatory (Yes or No)
	<p>Note:</p> <p>This field appears when the Price List ID option is selected for the Search By field.</p> <p>The Search (🔍) icon appears corresponding to this field. On clicking the Search icon, the Price List Search screen appears.</p>	
Account ID	<p>Used to specify the account for which simulation must be created.</p> <p>Note:</p> <p>This field appears when the Account option is selected for the Search By field.</p> <p>The Search (🔍) icon appears corresponding to this field. On clicking the Search icon, the Account Search screen appears.</p>	Yes
Person ID	<p>Used to specify the person for which simulation must be created. This field gets auto populated once the Account ID value is defined.</p> <p>Note: The Search (🔍) icon appears corresponding to this field. On clicking the Search icon, the Person Search screen appears.</p>	Yes
Simulation Date	Used to search price simulations which are effective from a particular date onwards.	Yes
Pricing Status	<p>Used to search price assignments with a particular status. The valid values are:</p> <ul style="list-style-type: none"> • Active • Proposed 	No
Search Type	<p>Used to indicate whether you want to search the price list using the following values:</p> <ul style="list-style-type: none"> • Best Fit • Exact Match <p>Note: By default, Exact Match option is selected.</p>	No
Show Default and Global Pricing	<p>Used to indicate whether the product is assigned to a default and global price list. The valid values are:</p> <ul style="list-style-type: none"> • Yes • No 	No
Price Item	Used to specify the price items for pricing simulation.	No

Field Name	Field Description	Mandatory (Yes or No)
	<p>Note:</p> <p>The Search (🔍) icon appears corresponding to this field. On clicking the Search icon, the Price Item Search screen appears.</p>	
Description	Used to search price assignments of a price item having a particular description.	No
View Type	<p>Used to indicate whether you want to view summary or tiering details of price components. The valid values are:</p> <ul style="list-style-type: none"> • Detail — Used when you want to view the details of price component with pricing eligibility and tiering criteria. • Summary — Used when you want to view the summary of effective price component. 	No
Parameter	<p>Used to specify multiple parameter codes based on which you want to define the pricing.</p> <p>Note:</p> <p>This field appears when the Multi Price Parameter option type of the Multi Parameter Based Pricing (C1_PPARM_FLG) feature configuration is set to True.</p> <p>The Search (🔍) icon appears corresponding to this field. On clicking the Search icon, the Parameter Search screen appears.</p>	No
Parameter Value	<p>Displays the value of the parameter or used to specify multiple parameter value.</p> <p>Note:</p> <p>The Search (🔍) icon appears corresponding to this field when the value type for the Parameter is Reference or Predefined.</p> <p>If the value type of the Parameter is Reference then on clicking the Search icon, the Reference Parameter Value Search screen appears.</p> <p>If the value type of the Parameter is Predefined then on clicking the Search icon, the Predefined Parameter Value Search screen appears.</p>	No

To add more than one **Parameter**, click the **Add** (+) icon and to delete the parameters click the **Delete** (🗑️) icon corresponding to the **Parameter** field.

- **Search Results** — On clicking the **Search** button, the search results appear based on the specified search criteria. The **Search Results** section contains the following columns:

Note: If default Price List ID is added to the Price List Value and if **Yes** is selected for **Show Default and Global Pricing**, also if Price List is added to the product for selected account then **Search Results** section will display price list assignments for the value and product will be displayed along with the default price list assignments.

Column Name	Column Description
Price Item	Displays the price item code.
	Note: It has a link. On clicking the link, the View Price Item screen appears with the details of the respective price item.
Description	Displays the description of the price item.
Variance Parameters	Indicates the variance parameter which is used for defining the price item pricing.
	Note: This column appears when the Multi Price Parameter option type of the Multi Parameter Based Pricing (C1_PPARM_FLG) feature configuration is set to False .
Price Item Parameters	Displays a comma-separated list of parameter values. The order in which parameter values appear in this field is controlled by the display order (which is defined while associating a parameter with a price item). A tool tip appears when you hover over this column corresponding to the price item. It indicates the price item parameters and their values used for defining the price item pricing.
	Note: This column appears when the Multi Price Parameter option type of the Multi Parameter Based Pricing (C1_PPARM_FLG) feature configuration is set to True .
Price Assignment Type	Indicates the type of price assignment. The valid values are: <ul style="list-style-type: none"> • Regular • Post Processing • Post Processing — Invoice Based • Post Processing — Price Item Based
Assignment Level	Indicates the level at which the price item pricing is defined in the customer hierarchy.
Price List Description	Displays the description of the price list.
	Note: The description appears when the pricing assignment type is Account Price List, or Account Inherited Price List.
Rate Description	Displays the description of the tiering setup of the rate component.
Simulate	On clicking the Simulate () icon, the Simulation — Effective Pricing Information screen appears where you can add the Price Item SQIs and Pricing Eligibility Parameters details that can be passed for pricing simulation.
	Note: This column appears when the price item is Rate and Fees .
Effective Start Date	Displays the date from when the pricing is effective.
Effective End Date	Displays the date till when the pricing is effective.
Pricing Currency	Indicates the currency in which the price item pricing is defined.

Column Name	Column Description
Parent Person	Displays the name of the parent or grandparent customer from whom the pricing is inherited.

Note:

The number of records that can be displayed in the **Search Results** section of the **Search Pricing** zone is controlled via the **C1_PR_REC** feature configuration. You can change the number of records that can be displayed using the **Effective Pricing RecordSet Limit** option type of the **C1_PR_REC** feature configuration. For more information, refer to [Setting the C1_PR_REC Feature Configuration](#) on page 4341.

Related Topics

For more information on...	See...
How to view effective pricing of a simulation	Simulation - Effective Pricing Information on page 699

Simulation - Effective Pricing Information

Note: This topic is not applicable for the health insurance business.

The **Simulation — Effective Pricing Information** screen contains the following sections:

- **SQIs** — This section contains the following fields:

Field Name	Field Description
SQI	Used to indicate the SQI that you want to associate with the price item. Note: If you want to define more than one price item SQI, click the Add (+) icon corresponding to this field. If you want to remove a price item SQI, click the Delete (🗑) icon corresponding to this field. The Search (🔍) icon appears corresponding to this field. On clicking the search icon, the Search for Service Quantity Identifier screen appears. This field is required when you want to view the effective pricing simulation.
Value	Used to indicate the SQI value that you want to associate with the price item. Note: If you want to define more than one value, click the Add (+) icon corresponding to this field. If you want to remove a price item SQI value, click the Delete (🗑) icon corresponding to this field.

- **Pricing Eligibility Parameters** — This section contains the following fields:

Field Name	Field Description
Parameter	Used to specify multiple parameter codes based on which you want to define the pricing

Field Name	Field Description
	<p>Note:</p> <p>This field appears only when the Multi Price Parameter option type of the Multi Parameter Based Pricing (C1_PPARM_FLG) feature configuration is set to true.</p> <p>The Search (🔍) icon appears corresponding to this field. On clicking the search icon, the Parameter Search screen appears.</p> <p>If you want to define more than one parameter, click the Add (+) icon corresponding to this field.</p> <p>If you want to remove a parameter, click the Delete (🗑️) icon corresponding to this field.</p>
Parameter Value	<p>Displays the value of the parameter or used to specify multiple parameter value.</p> <p>Note:</p> <p>The Search (🔍) icon appears corresponding to this field appears when the value type for the Parameter is defined as Reference or Predefined. If the value type of the Parameter is Reference, then the Reference Parameter Value Search screen appears and if the value type of the Parameter is Predefined, then the Predefined Parameter Value Search screen appears.</p> <p>If you want to define more than one value, click the Add (+) icon corresponding to this field.</p> <p>If you want to remove a parameter value, click the Delete (🗑️) icon corresponding to this field.</p>

After providing the required information, when you click on **Simulate** button, the **Effective Pricing Information** zone appears where you can view the effective pricing simulation. This zone contains the following sections:

- **Rate Information** — This section contains the following fields:

Field Name	Field Description
Applicable Rate	Displays the rate applicable for which pricing is defined.
Contributing Price Components are	Displays how the price components are contributed.

Note: This section appears when **Price Item Type** is **Rate** .

- **Fee Information** — This section contains the following fields:

Field Name	Field Description
Applicable Fee	Displays the fee applicable for which pricing is defined.
Contributing Price Components are	Displays how the price components are contributed.

Note: This section appears when **Price Item Type** is **Fees** .

- **Price Item and Parameter Information** — This section contains the following fields:

Field Name	Field Description
Price Item	Displays the price item for which pricing is defined.
Description	Displays the description of the price item

The Parameter Information appears when the **Multi Price Parameter** option type of the **Multi Parameter Based Pricing (C1_PPARM_FLG)** feature configuration is set to **True**.

This segment contains the following fields:

Field Name	Field Description
Parameter	Specifies multiple parameter codes associated with the price items based on which pricing is defined.
Parameter Information	Displays the parameter information with concatenated comma separated values.
Parameter Value	Displays the value of the parameter.

- **TFM Information** — This section contains the following fields:

Field Name	Field Description
Ignore Transaction	Displays whether the transactions mapped to the price item is considered for billing.
Aggregation Schedule	Displays the aggregation cycle.
Aggregation Transaction	Specifies whether the transactions mapped to the price item are aggregated for billing.
Rating Criteria	Specifies how and when you rate the transaction legs mapped to the price item.

Note: This section appears when the **Price Item** is available for **Pricing and Billing**.

- **Pricing Information** — This section contains the following fields.

Field Name	Field Description
Effective Start Date	Displays the date from when the price item pricing is effective.
Pricing Currency	Specifies the currency in which you define the price item pricing.
Effective End Date	Displays the date till when the price item pricing is effective.
Pricing Status	Displays the status of price assignment.
Variance Parameter	Specifies the variance based on which price item pricing is defined. Note: This field appears when the Multi Price Parameter option type of the Multi Parameter Based Pricing (C1_PPARM_FLG) feature configuration is set to False .
Rate Schedule	Specifies the rate schedule used for defining price item pricing.
Price Assignment Type	Displays the type of price assignment.
Print Zero	Specifies whether zero pricing should be displayed in the bill.

Field Name	Field Description
Apply To	Displays whether the price item pricing is applied to all customers or only to the new customers.
Pricing Frequency	Displays the frequency for pricing where Price Item Type is fees.
Advance Pricing	Displays only if Price Item is defined as Pricing Only , Price Item Type is defined as Fees and Price Assignment Type is defined as Post Processing . The valid values are: <ul style="list-style-type: none"> • Yes • No

Pricing Eligibility Criteria and **Tiering Criteria** for each eligibility or tier range are displayed in following fields:

Field Name	Field Description
Rate Component Sequence	Displays the sequence number of the rate component.
Tiering Type	Displays the tiering type of the rate component.
Price Component Sequence	Specifies the sequence of price component whose rate is used for calculation.
Price Component Description	Displays the description of the rate component.
Rate	Specifies the price for the price item.
Contributing Factor	Displays the availability of contributing factor.
Eligibility/Tier Details	On clicking the Add (+) icon, expandable details of Tiering Criteria and Pricing Eligibility Criteria are displayed.

When you click the **Add (+)** icon, if the price component is scheduled for Flat Rate then, only **Pricing Eligibility Criteria** segment appears. If the price component is scheduled for Step or Threshold then both the segments, **Tiering Criteria** and **Pricing Eligibility Criteria** appears.

Tiering Criteria segment contains the following fields:

Field Name	Field Description
Tiering Criteria	Displays the tiering criteria.
Price Item	Specifies whether the price item or bundle's total usage is considered for determining the rate.
Variance Parameter	Specifies the variance based on which price item or bundle's total usage is considered for determining the rate. Note: This field appears when the Multi Price Parameter option type of the Multi Parameter Based Pricing (C1_PPARM_FLG) feature configuration is set to False .
Price Item Parameters	Specifies the parameters based on which price item or bundle's total usage is considered for determining the rate.

Field Name	Field Description
	Note: This field appears when the Multi Price Parameter option type of the Multi Parameter Based Pricing (C1_PPARM_FLG) feature configuration is set to True .
From	Specifies the lower limit of the tiering range.
To	Specify the upper limit of the tiering range.

Pricing Eligibility Criteria segment contains the following fields:

Field Name	Field Description
Sequence Number	Specifies the order in which the criteria should be executed in the rule.
Parameter	Specifies the left hand side parameter which you want to use along with the price item for price determination. Note: This field appears when the Multi Price Parameter option type of the Multi Parameter Based Pricing (C1_PPARM_FLG) feature configuration is set to True .
Operator	Specifies the relational operator to define the relation between the left hand side and right hand side parameters.
Parameter Value Type	Displays the type of pricing eligibility.
Parameter	Specifies the right hand side parameter which you want to use along with the price item for price determination. Note: This field appears when the Multi Price Parameter option type of the Multi Parameter Based Pricing (C1_PPARM_FLG) feature configuration is set to True .
Parameter Value	Specifies the parameter value.
Is True	Displays what should happen when the condition is true (satisfied).
Is False	Displays what should happen when the condition is false (not satisfied).
Is Sufficient	Displays what should happen when the data is insufficient.

This section contains the following links:

Link Name	Link Description
Expand All	Used to define all the Tiering Criteria and Pricing Eligibility Criteria segments.
Collapse All	Used to un-define the displayed Tiering Criteria and Pricing Eligibility Criteria segments.
Expand Only Contributing Factors	Used to define only those Tiering Criteria and Pricing Eligibility Criteria segments with contributing factors.

Related Topics

For more information on...	See...
How to search for effective price assignments for an account.	Effective Price Assignments for Account on page 550

For more information on...	See...
How to view effective pricing of an account	Viewing Effective Price Assignments of an Account on page 560
How to export effective price assignments of an account	Exporting Effective Price Assignments of an Account on page 562
Price Item Pricing screen	Price Item Pricing (Used for Viewing) on page 614

Searching Pricing Simulation for Account or Price List

Note: This topic is not applicable for the health insurance business.

Prerequisites

To search pricing simulation for an account or price list, you should have:

- Price Item, Account or Person details defined in the application

Procedure

To search pricing simulation for an account or price list:

1. Click the **Menu** link in the **Application** toolbar.
A list appears.
2. From the **Main** menu, select **Pricing Management** and then click **Pricing Simulation**.
The **Pricing Simulation** screen appears.
3. In the **Search Pricing** zone, select **Account** or **Price List** depending on what you want search pricing simulation.
4. Enter the additional search criteria, if required.

Note: ORMB search engine supports wildcard search, where you can substitute the percentage (%) symbol as a stand in for any word or letter in a search criteria. You can use the ‘%’ wildcard character in all input fields except the date and ID fields. The ‘%’ wildcard character is suffixed automatically at the end of the partial search criteria. Therefore, you may or may not specify the wildcard character at the end of the partial search criteria. However, you have to prefix the wildcard character manually wherever required.

5. Click **Search**.

A list of pricing details that meet the search criteria appears in the **Search Results** section.

Related Topics

For more information on...	See...
Pricing Simulation screen	Pricing Simulation on page 694
Search Pricing zone	Search Pricing on page 695

Viewing Pricing Simulation

Note: This topic is not applicable for the health insurance business.

Prerequisites

To view pricing simulation details of an account, you should have:

- Price items assigned to the account

Procedure

To view pricing simulation of an account:

1. Click the **Menu** link in the **Application** toolbar.
A list appears.
2. From the **Main** menu, select **Pricing Management** and then click **Pricing Simulation**.
The **Pricing Simulation** screen appears.
3. You can search for an account by entering the search criteria in the **Search Pricing** zone.

Note: ORMB search engine supports wildcard search, where you can substitute the percentage (%) symbol as a stand in for any word or letter in a search criteria. You can use the ‘%’ wildcard character in all input fields except the date and ID fields. The ‘%’ wildcard character is suffixed automatically at the end of the partial search criteria. Therefore, you may or may not specify the wildcard character at the end of the partial search criteria. However, you have to prefix the wildcard character manually wherever required.

Related Topics

For more information on...	See...
How to search pricing details	Search Pricing on page 695
Pricing Simulation screen	Pricing Simulation on page 694
Effective Pricing Information screen	Simulation - Effective Pricing Information on page 699

Exporting Effective Price Simulation

Note: This topic is not applicable for the health insurance business.

Procedure

To export effective price simulation for an account in the CSV format:

1. Click the **Menu** link in the **Application** toolbar.
A list appears.
2. From the **Main** menu, select **Pricing Management** and then click **Pricing Simulation**.
The **Pricing Simulation** screen appears.
3. You can search for an account by entering the search criteria in the **Search Pricing** zone.

Note: ORMB search engine supports wildcard search, where you can substitute the percentage (%) symbol as a stand in for any word or letter in a search criteria. You can use the ‘%’ wildcard character in all input fields except the date and ID fields. The ‘%’ wildcard character is suffixed automatically at the end of the partial search criteria. Therefore, you may or may not specify the wildcard character at the end of the partial search criteria. However, you have to prefix the wildcard character manually wherever required.

4. Click the **Export to Excel** link in the **Search Pricing** zone.
The **File Download** dialog box appears.
5. Click **Save**.
The **Save As** dialog box appears.
6. Browse to the location where you want to save the file.
7. Enter the file name in the respective field, and click **Save**.

The search results are exported in CSV format.

8. Open the CSV file in Microsoft Excel.

It contains the following columns:

Column Name	Column Description
Price Item	Displays the price item code.
Description	Displays the description of the price item.
Variance	Indicates the variance parameter which is used for defining the price item pricing. Note: This column appears when the Multi Price Parameter option type of the Multi Parameter Based Pricing (C1_PPARM_FLG) feature configuration is set to False .
Price Item Parameters	Indicates the parameters which are used for defining the price item pricing. Note: This column appears when the Multi Price Parameter option type of the Multi Parameter Based Pricing (C1_PPARM_FLG) feature configuration is set to True .
Price Assignment Type	Indicates the type of price assignment. The valid values are: <ul style="list-style-type: none"> • Regular • Post Processing • Post Processing — Invoice Based • Post Processing — Price Item Based
Assignment Level	Indicates the level at which the price item pricing is defined in the customer hierarchy.
Price List Description	Displays the description of the price list. Note: The description appears when the pricing assignment type is Account Price List, Customer Price List, or Parent Customer Price List.
Rate	Displays the price of the price item. It also indicates whether the price is a Flat, Threshold, or Step price. The price can be agreed pricing, price list pricing, or pricing inherited from the price list hierarchy. If the price is applicable only to new customers, an asterisk (*) symbol appears corresponding to the price.
Price Component Description	Displays the description of the price component whose rate is used for calculation. Note: The data appears in this column only when the rate corresponding to the price component in the price item pricing is used for calculation.
Effective Start Date	Displays the date from when the pricing assignment is effective.
Effective End Date	Displays the date till when the pricing assignment is effective.
Pricing Currency	Indicates the currency in which the price item pricing is defined.
From	Displays the lower limit of the tiering range.
To	Displays the upper limit of the tiering range.
Price Assignment Usage	Indicates whether the price assignment is applicable to all customers or only to the new customers.

Column Name	Column Description
Price Assignment ID	Displays the ID that is generated automatically when the price assignment is done.
Parent Level	Displays the numerical level of the parent in the hierarchy from whom the pricing is inherited.
Price List ID	Displays the price list ID from where the pricing is inherited.
Price List Start Date	Displays the date from when the price list is effective.
Parent Person	Displays the name of the parent or grandparent customer from whom the pricing is inherited.
Parent Pricelist Level	Indicates the parent level when pricing is inherited from the price list hierarchy. If the pricing is inherited from the assigned price list, the parent price list level will be 0. However, if the pricing is inherited from the parent price list in the hierarchy, the parent price list level will be 1. And, if the pricing is inherited from the grandparent price list in the hierarchy, the parent price list level will be 2, and so on.
Ignore Transaction	Indicates whether the transactions mapped to the price item should be considered for billing. The valid values are: <ul style="list-style-type: none"> • Y • N
Aggregate Transaction	Indicates whether the transactions mapped to the price item should be aggregated for billing. The valid values are: <ul style="list-style-type: none"> • Y • N
Aggregation Schedule	Indicates the aggregation cycle.
Tiering Criterion	Indicates the tiering criterion.
Tiering Price Item	Indicates whether the price item is billed individually or at the bundle level.

Related Topics

For more information on...	See...
Pricing Simulation screen	Pricing Simulation on page 694
Search Pricing zone	Search Pricing on page 695

Eligible Price List

Note: This topic is not applicable for the health insurance business.

The **Eligible Price List** screen allows you to:

- View eligible price list details for account or person
- View pricing simulation details of account or person

This screen consists of the following zones:

- [Search Eligible Price Lists](#) on page 708

- [Pricing Simulation](#) on page 694

Search Eligible Price Lists

Note: This topic is not applicable for the health insurance business.

The **Search Eligible Price List** zone allows you to search eligible price list for account and person. This zone contains the following two sections:

- **Search Criteria** — The **Search Criteria** section contains the following fields:

Field Name	Field Description	Mandatory (Yes or No)
Eligible Date	Used to specify the date on which the eligibility check need to be searched.	Yes
Person ID	Used to specify the person for which eligible price list to be searched. Note: The Search (🔍) icon appears corresponding to this field. On clicking the icon, the Person Search screen appears.	No
Account ID	Used to specify the account for which eligible price list to be searched. Note: The Search (🔍) icon appears corresponding to this field. On clicking the icon, the Account Search screen appears.	No
Status	Used to search eligible price list based on status.	Yes
Division	Used to search eligible price list based on division.	Yes
Parameter	Used to specify multiple parameter codes based on which you want to define the pricing. Note: This field appears only when the MultiPrice Parameter option type of the MultiParameter Based Pricing (C1_PPARM_FLG) feature configuration is set to True. The Search (🔍) icon appears corresponding to this field. On clicking the icon, the Parameter Search screen appears.	No
Parameter Value	Displays the value of the parameter or used to specify multiple parameter value.	No

Field Name	Field Description	Mandatory (Yes or No)
	<p>Note: The Search (🔍) icon appears corresponding to this field when the value type for the Parameter is defined as Reference or Predefined. If the value type of the Parameter is Reference then on clicking the search icon, the Reference Parameter Value Search screen appears else if the value type of the Parameter is Predefined then on clicking the search icon, the Predefined Parameter Value Search screen appears.</p>	

Note: To add more than one **Parameter**, click the add (+) icon and to delete the parameters click the delete (🗑️) icon corresponding to this field.

- **Search Results** — On clicking the **Search** button, the search results appear based on the specified search criteria. The **Search Results** section contains the following columns:

Column Name	Column Description
Price List ID	<p>Displays the price list ID.</p> <p>Note: It has a link. On clicking the link, the Price List Price Item Assignments screen appears where you can view the details of the respective price list.</p>
Price List Description	<p>Displays the price list description.</p> <p>Note: It has a link. On clicking the link, the Price List Price Item Assignments screen appears where you can view the details of the respective price list.</p>
Status	<p>Indicates the status of the price list. The valid values are:</p> <ul style="list-style-type: none"> • Active • Proposed
Availability Start Date	Used to search price lists which are available for assignment from a particular date.
Availability End Date	Used to search price lists which are available for assignment till a particular date.
Effective Start Date	Used to search price lists which are effective from a particular date.
Effective End Date	Used to search price lists which are effective till a particular date.
Simulate	On clicking the Simulate (🔄) icon, the Pricing Simulation Screen appears with the price list ID, account and person fields prepopulated.

Related Topics

For more information on...	See...
How to search for a price list	Searching for a Price List on page 449
How to view price items assigned to a price list	Viewing Price Items Assigned to a Price List on page 450
How to view the details of a price list	Viewing the Price List Details on page 461
How to create a price list	Defining a Price List on page 450

For more information on...	See...
How to edit a price list	Editing a Price List on page 466
How to copy a price list	Copying a Price List on page 459

Rate Definition

Rate schedules, rate versions, and rate components are used to define the formulas to calculate the total amount charged to a customer for a product. Some examples of formulas are: price times the number of transactions used and a flat monthly charge plus a percentage of the average daily balance.

The rate is a formula with variables whose values are supplied by a user by setting up a price list or override price. For example, a rate might add a flat monthly charge and a percentage of the average daily balance to arrive at the amount charged to the customer. This rate might be used to calculate the charge for multiple products, each product with its own flat amount and percentage. So, these two factors are defined as variables whose values must be entered by users when they setup price list or override price. In Oracle Revenue Management and Billing (ORMB), these variables are defined as rate components.

The system provides you with the ability to create tiered pricing in case standard flat pricing is not sufficient to meet the business needs. The **Rate Definition** screen allows you to indicate whether the rate component supports standard flat pricing or tiered pricing. It allows you to define, edit, and delete the tiering setup of a rate component. This screen consists of the following zones:

- [Rate Schedule Components](#) on page 710
- [Create/Edit Rate Definition](#) on page 711

Rate Schedule Components

The **Rate Schedule Components** zone allows you to select the rate schedule whose rate components' tiering setup you want to define or edit. This zone contains the following two sections:

- **Search Criteria** — The **Search Criteria** section contains the following field:

Field Name	Field Description	Mandatory (Yes or No)
Rate Schedule	Used to select the rate schedule.	Yes

- **Search Results** — On clicking the **Search** button, the rate components of the rate schedule appear in the search results. The **Search Results** section contains the following columns:

Column Name	Column Description
Rate Schedule	Displays the rate schedule.
Rate Component Sequence	Displays the sequence number of the rate component.
Rate Component Description	Displays the description of the rate component.
Effective Start Date	Displays the date from when the rate version to which the rate component belongs is effective.
Tiering Type	Displays the tiering type.
Maximum Tiering Combinations	Displays the maximum number of tiering ranges supported by the rate component.

Column Name	Column Description
	Note: Each tiering range supports more than one tiering criteria. For example, a rate component supports tiering based on two different criteria such as transaction volumes from a bundle and balances of the priced product. In such case, for a single rate, it is possible to enter separate tiering range information for each criterion and vary this information by product.
Rate Component Map Description	Displays the description of the tiering setup of the rate component.
Action	Indicates the action that can be performed on the rate component. The valid values are: <ul style="list-style-type: none"> • Add — Allows you to define the tiering setup of the rate component • Edit — Allows you to edit the tiering setup of the rate component
Rate Component Map ID	Displays the rate component map ID. Note: This ID is generated automatically when you define the tiering setup of the rate component.

On clicking the **Broadcast** () icon corresponding to the rate component, the **Create/Edit Rate Definition** zone appears with the details of the respective rate component.

Related Topics

For more information on...	See...
How to define tiering setup of a rate component	Defining Tiering Setup of a Rate Component on page 712
How to edit tiering setup of a rate component	Editing Tiering Setup of a Rate Component on page 713
How to delete tiering setup of a rate component	Deleting Tiering Setup of a Rate Component on page 714

Create/Edit Rate Definition

The **Create/Edit Rate Definition** zone allows you to define and edit tiering setup of the rate component. This zone contains the following fields:

Field Name	Field Description	Mandatory (Yes or No)
Rate Schedule	Displays the code of the rate schedule.	Not applicable
Rate Component Description	Displays the description of the rate component.	Not applicable
Effective Start Date	Displays the date from when the rate version to which the rate component belongs is effective.	Not applicable
Rate Component Sequence	Displays the sequence number of the rate component.	Not applicable
Tiering Type	Used to specify the tiering type. The valid values are: <ul style="list-style-type: none"> • FLAT • STEP • THRESHOLD 	Yes

Field Name	Field Description	Mandatory (Yes or No)
	Note: This field is non-editable when you edit the tiering setup of the rate component.	
Maximum Tiering Combinations	Used to specify the maximum number of tiering ranges supported by the rate component. Note: This field is non-editable when you: <ul style="list-style-type: none"> Select the tiering type as FLAT or STEP Edit the tiering setup of the rate component By default, 0 appears in this field when you select the tiering type as FLAT , and 1 appears when you select the tiering type as STEP .	Yes
Rate Component Map Description	Used to specify the description for the tiering setup of the rate component. For example, if you want the user to enter price per transaction for a tiering range, enter Price Per Transaction in the Rate Component Map Description field.	Yes

This zone contains the following buttons:

Button Name	Button Description (When the Action is Add)	Button Description (When the Action is Edit)
Save	Used to create the tiering setup.	Used to save the changes made in this zone.
Delete	Note: This button is disabled when you define the tiering setup of the rate component.	Used to delete the tiering setup of the rate component.
		Note: You can delete the tiering setup when the rate component is not yet used for any product pricing.
Cancel	Used to clear the fields in this zone.	Used to reset the changes made in this zone.

Related Topics

For more information on...	See...
How to define tiering setup of a rate component	Defining Tiering Setup of a Rate Component on page 712
How to edit tiering setup of a rate component	Editing Tiering Setup of a Rate Component on page 713
How to delete tiering setup of a rate component	Deleting Tiering Setup of a Rate Component on page 714

Defining Tiering Setup of a Rate Component

Prerequisites

To define tiering setup of a rate component, you should have:

- Rate schedules defined in the application
- Rate components of the rate schedule defined in the application

Procedure

To define tiering setup of a rate component:

1. Click the **Menu** link in the **Application** toolbar.
A list appears.
2. From the **Main** menu, select **Rates** and then click **Rate Definition**.
The **Rate Definition** screen appears.
3. Select the rate schedule in the **Rate Schedule Components** zone.
4. Click **Search**.
The rate components of the rate schedule appear as the search results.
5. Click the **Broadcast** (📡) icon corresponding to the rate component whose tiering setup you want to define.
The **Create/Edit Rate Definition** zone appears.
6. Select the tiering type from the list.
7. Enter the maximum number of tiering ranges supported by the rate component.

Note:

The **Maximum Tiering Combinations** field is non-editable when you select the tiering type as **FLAT** or **STEP**.
By default, **0** appears in the **Maximum Tiering Combinations** field when you select the tiering type as **FLAT**, and **1** appears when you select the tiering type as **STEP**.

8. Enter the description for the tiering setup of the rate component.
For example, if you want the user to enter price per transaction for a tiering range, enter `Price Per Transaction` in the **Rate Component Map Description** field.
9. Click **Save**.
The rate component map ID is generated automatically when you define the tiering setup of the rate component.

Related Topics

For more information on...	See...
Rate Definition screen	Rate Definition on page 710
Rate Schedule Components zone	Rate Schedule Components on page 710
Create/Edit Rate Definition zone	Create/Edit Rate Definition on page 711

Editing Tiering Setup of a Rate Component

Procedure

To edit tiering setup of a rate component:

1. Click the **Menu** link in the **Application** toolbar.
A list appears.
2. From the **Main** menu, select **Rates** and then click **Rate Definition**.
The **Rate Definition** screen appears.
3. Select the rate schedule in the **Rate Schedule Components** zone.

4. Click **Search**.

The rate components of the rate schedule appear as the search results.

5. Click the **Broadcast** (📡) icon corresponding to the rate component whose tiering setup you want to edit.

The **Create/Edit Rate Definition** zone appears.

6. Modify the details of the tiering setup.

Note: You can only modify the rate component map description.

7. Click **Save**.

The changes made to the tiering setup are saved.

Related Topics

For more information on...	See...
Rate Definition screen	Rate Definition on page 710
Rate Schedule Components zone	Rate Schedule Components on page 710
Create/Edit Rate Definition zone	Create/Edit Rate Definition on page 711

Deleting Tiering Setup of a Rate Component

Procedure

To delete tiering setup of a rate component:

1. Click the **Menu** link in the **Application** toolbar.

A list appears.

2. From the **Main** menu, select **Rates** and then click **Rate Definition**.

The **Rate Definition** screen appears.

3. Select the rate schedule in the **Rate Schedule Components** zone.

4. Click **Search**.

The rate components of the rate schedule appear as the search results.

5. Click the **Broadcast** (📡) icon corresponding to the rate component whose tiering setup you want to delete.

The **Create/Edit Rate Definition** zone appears.

6. Click **Delete**.

The tiering setup of the rate component is deleted, and the action that can be performed on the rate component changes from **Edit** to **Add** in the **Rate Schedule Components** zone.

Note:

The **Delete** button is disabled when you define the tiering setup of the rate component.

You can delete the tiering setup when the rate component is not yet used for any product pricing.

Related Topics

For more information on...	See...
Rate Definition screen	Rate Definition on page 710
Rate Schedule Components zone	Rate Schedule Components on page 710
Create/Edit Rate Definition zone	Create/Edit Rate Definition on page 711

Tiering Criterion

Oracle Revenue Management and Billing (ORMB) provides you with the ability to create tiered pricing in case standard flat pricing is not sufficient to meet the business needs. Through tiered pricing, you can offer more favorable pricing to the customers based on service quantity utilization.

Let us understand this with the help of an example. ABC company uses wire transfer services provided by a large bank. If ABC company initiates up to 1,000 wire transfers, the fee charged by the bank will be \$5 per transfer. If ABC company initiates more than 1,000 wire transfers, the fee will be \$3 per transfer. To introduce this flexibility in the pricing model, you will have to define tiered pricing with the following tiering ranges:

- If the number of wire transfers is greater than 0 and less than or equal to 1000, then charge \$5 per transfer to ABC company.
- If the number of wire transfers is greater than 1000, then charge \$3 per transfer to ABC company.

In the above example, number of wire transfers is the tiering criterion, 0 – 1000 and 1000 – BLANK are tiering ranges, and \$5 and \$3 are rates per transfer.

The **Tiering Criteria** screen allows you to create and edit a tiering criterion. This screen consists of the following zones:

- [Tiering Criterion List](#) on page 715
- [Edit Tiering Criterion](#) on page 715
- [Create Tiering Criterion](#) on page 716

Tiering Criterion List

The **Tiering Criterion List** zone displays tiering criterion that are already defined in the system. This zone contains the following columns:

Column Name	Column Description
Tiering Criterion	Displays the code of the tiering criterion.
Description	Displays the description of the tiering criterion.
Service Quantity Identifier	Displays the Service Quantity Identifier (SQI) of the tiering criterion.

You can change the layout of this zone. For more information on how to change the layout, see [Changing the Layout](#) on page 4300.

On clicking the **Broadcast** (🔊) icon corresponding to the tiering criterion, the **Edit Tiering Criterion** zone appears with the details of the respective tiering criterion.

Edit Tiering Criterion

The **Edit Tiering Criterion** zone allows you to edit the tiering criterion. This zone contains the following fields:

Field Name	Field Description	Mandatory (Yes or No)
Tiering Criterion	Displays the code of the tiering criterion.	Not applicable
Description	Used to modify the description of the tiering criterion.	Yes
Service Quantity Identifier	Displays the Service Quantity Identifier (SQI) of the tiering criterion.	Not applicable

This zone contains the following two buttons:

Button Name	Button Description
Save	Used to save the changes made in this zone.
Cancel	Used to clear the changes made in this zone.

By default, the **Edit Tiering Criterion** zone does not appear in the **Tiering Criteria** screen. It appears when you click the **Broadcast** (📡) icon corresponding to the tiering criterion in the **Tiering Criteria List** zone.

Related Topics

For more information on...	See...
How to edit a tiering criterion	Editing a Tiering Criterion on page 717

Create Tiering Criterion

The **Create Tiering Criterion** zone allows you to create tiering criterion. This zone contains the following fields:

Field Name	Field Description	Mandatory (Yes or No)
Tiering Criterion	Used to specify the code that uniquely identifies the tiering criterion.	Yes
Description	Used to specify the description for the tiering criterion.	Yes
Service Quantity Identifier	Used to specify the Service Quantity Identifier (SQI) for the tiering criterion. Note: During billing, the rating engine uses the SQI to determine which service quantities are applied to tiers.	Yes

This zone contains the following two buttons:

Button Name	Button Description
Save	Used to create the tiering criterion.
Cancel	Used to clear the fields in this zone.

Related Topics

For more information on...	See...
How to create a tiering criterion	Creating a Tiering Criterion on page 716

Creating a Tiering Criterion

Prerequisites

To create a tiering criterion, you should have:

- Service Quantity Identifiers (SQIs) defined in the application

Procedure

To create a tiering criterion:

1. Click the **Menu** link in the **Application** toolbar.
A list appears.
2. From the **Main** menu, select **Pricing Management** and then click **Tiering Criterion**.
The **Tiering Criterion** screen appears.
3. In the **Create Tiering Criterion** zone, enter the code that uniquely identifies the tiering criterion.
4. Enter the description for the tiering criterion.
5. Select the Service Quantity Identifier (SQI) that you want to associate with the tiering criterion.
6. Click **Save**.

The tiering criterion is created.

Related Topics

For more information on...	See...
Tiering Criterion screen	Tiering Criterion on page 715
Create Tiering Criterion zone	Create Tiering Criterion on page 716

Editing a Tiering Criterion

Procedure

To edit a tiering criterion:

1. Click the **Menu** link in the **Application** toolbar.
A list appears.
2. From the **Main** menu, select **Pricing Management** and then click **Tiering Criterion**.
The **Tiering Criterion** screen appears.
3. In the **Tiering Criterion** zone, click the **Broadcast** () icon corresponding to the tiering criterion whose details you want to edit.
The **Edit Tiering Criterion** zone appears.
4. Modify the description of the tiering criterion, if required.
5. Click **Save**.

The changes made to the tiering criterion are saved.

Related Topics

For more information on...	See...
Tiering Criterion screen	Tiering Criterion on page 715
Edit Tiering Criterion zone	Edit Tiering Criterion on page 715

--

Variance Parameter

Note: This topic is not applicable for the health insurance business.

Oracle Revenue Management and Billing allows you to define pricing for a product based on the variance parameter. This helps you to maintain variance based pricing for a product. For example, you can define different product pricing for each country or currency, if required. Before you define product pricing based on a variance parameter, you need to define the variance parameter. The **Variance Parameter** screen allows you to define, edit, and delete a variance parameter. It also allows you to filter the variance parameters using a search criteria.

Filtering the Variance Parameters

Note: This topic is not applicable for the health insurance business.

Procedure

To filter the variance parameters:

1. Click the **Admin** link in the **Application** toolbar.

A list appears.

2. From the **Admin** menu, select **V** and then click **Variance Parameter**.

The **Variance Parameter** screen appears. It contains the following two sections:

- **Search Criteria** - The **Search Criteria** section contains the following fields:

Field Name	Field Description	Mandatory (Yes or No)
Variance Parameter	Used to specify the variance parameter.	No

- **Search Results** — On clicking the **Search** button corresponding to the **Variance Parameter** field, the search results are filtered based on the specified criteria. The **Search Results** section contains the following columns:

Column Name	Column Description
Variance Parameter	Displays the variance parameter.
Description	Displays the description of the variance parameter.

3. Enter the search criteria in the **Variance Parameter** field.

Note: ORMB search engine supports wildcard search, where you can substitute the percentage (%) symbol as a stand in for any word or letter in a search criteria. You can use the '%' wildcard character in all input fields except the date and ID fields. The '%' wildcard character is suffixed automatically at the end of the partial search criteria. Therefore, you may or may not specify the wildcard character at the end of the partial search criteria. However, you have to prefix the wildcard character manually wherever required.

4. Click the **Search** button corresponding to the **Variance Parameter** field.

The search results are filtered based on the specified criteria.

Related Topics

For more information on...	See...
Variance Parameter screen	Variance Parameter on page 718

Defining a Variance Parameter

Note: This topic is not applicable for the health insurance business.

Procedure

To define a variance parameter:

1. Click the **Admin** link in the **Application** toolbar.
A list appears.
2. From the **Admin** menu, select **V** and then click **Variance Parameter**.

The **Variance Parameter** screen appears. It contains the following columns:

Column Name	Column Description	Mandatory (Yes or No)
Variance Parameter	Used to specify the variance parameter.	Yes
Description	Used to specify the description for the variance parameter.	Yes

3. Enter the required details.
4. If you want to define more than one variance parameter, click the **Add (+)** icon and then repeat step 4.

Note: However, if you want to remove a variance parameter, click the **Delete (🗑)** icon corresponding to the variance parameter that you want to delete.

5. Click **Save**.

The variance parameter is defined.

Related Topics

For more information on...	See...
Variance Parameter screen	Variance Parameter on page 718

Editing a Variance Parameter

Note: This topic is not applicable for the health insurance business.

Procedure

To edit a variance parameter:

1. Click the **Admin** link in the **Application** toolbar.
A list appears.
2. From the **Admin** menu, select **V** and then click **Variance Parameter**.

The **Variance Parameter** screen appears.

- If required, you can filter the variance parameters in the **Variance Parameter** screen.

A list of variance parameters that meet the search criteria appears in the search results. The **Search Results** section contains the following columns:

Column Name	Column Description	Mandatory (Yes or No)
Variance Parameter	Displays the variance parameter.	Not applicable
Description	Used to specify the description for the variance parameter.	Yes

- Modify the required details.
- Click **Save**.

The changes made to the variance parameter are saved.

Related Topics

For more information on...	See...
Variance Parameter screen	Variance Parameter on page 718
How to filter the variance parameters	Filtering the Variance Parameters on page 718

Deleting a Variance Parameter

Note: This topic is not applicable for the health insurance business.

Procedure

To delete a variance parameter:

- Click the **Admin** link in the **Application** toolbar.
A list appears.
- From the **Admin** menu, select **V** and then click **Variance Parameter**.
The **Variance Parameter** screen appears.
- If required, you can filter the variance parameters in the **Variance Parameter** screen.
A list of variance parameters that meet the search criteria appears in the **Search Results** section.
- Click the **Delete** (🗑️) icon corresponding to the variance parameter that you want to delete.
- Click **Save**.

The variance parameter is deleted.

Note: You can only delete a variance parameter which is not yet used.

Related Topics

For more information on...	See...
Variance Parameter screen	Variance Parameter on page 718
How to filter the variance parameters	Filtering the Variance Parameters on page 718

Person to Person Relationship Type Sequence

Note: This topic is not applicable for the health insurance business.

Oracle Revenue Management and Billing provides you the flexibility to define person to person relationship type sequence:

- For each division, price item, and price item parameters combination
- For each division
- In the C1_PER_REL feature configuration

The system will first check whether the person to person relationship type sequence is defined for the division, price item, and price item parameters combination. If the person to person relationship type sequence is defined for the division, price item, and price item parameters combination, the system will search effective price item pricing at the parent customer level based on the sequence defined for the combination. However, if the person to person relationship type sequence is not defined for the division, price item, and price item parameters combination, the system will check whether the person to person relationship type sequence is defined for the division. If the person to person relationship type sequence is defined for the division, the system will search effective price item pricing at the parent customer level based on the sequence defined for the division. However, if the person to person relationship type sequence is not defined for the division, the system will consider the person to person relationship type sequence defined in the C1_PER_REL feature configuration and accordingly search effective price item pricing at the parent customer level.

The **Person to Person Relationship Type Sequence** screen allows you to define, edit, and delete person to person relationship type sequence of:

- a division
- a division, price item, and price item parameters combination

This screen consists of the following zones:

- [Search Person Relationship Type Sequence for Price Item](#) on page 721
- [Search Person Relationship Type Sequence for Division](#) on page 723

Search Person Relationship Type Sequence for Price Item

Note: This topic is not applicable for the health insurance business.

The **Search Person Relationship Type Sequence for Price Item** zone allows you to search person to person relationship type sequence defined for a division, price item, and price item parameters combination. You can also define, edit, and delete person to person relationship type sequence of a division, price item, and price item parameters combination.

This zone contains the following two sections:



- **Search Criteria** — The **Search Criteria** section contains the following fields:

Field Name	Field Description	Mandatory (Yes or No)
Price Item	Used to specify the price item code.	No
Price Item Description	Used to specify the description of the price item.	No
Division	Used to specify the division.	No

Field Name	Field Description	Mandatory (Yes or No)
	Note: You can only view those divisions to which you have access in the Division list.	

Note: You must specify at least one search criterion while searching person to person relationship type sequence defined for a division, price item, and price item parameters combination.

- **Search Results** — On clicking the **Search** button, the search results appear based on the specified search criteria. The **Search Results** section contains the following columns:

Column Name	Column Description
Price Item	Displays the price item code. Note: It has a link. On clicking the link, the View Price Item screen appears with the details of the respective price item.
Description	Displays the description of the price item.
Price Item Parameters	Displays a comma-separated list of parameter values. The order in which parameter values appear in this field is controlled by the display order (which is defined while associating a parameter with a price item).
Division	Indicates the division for which price item and price item parameters specific person to person relationship type sequence is defined.
View	On clicking the View () icon, the Person Relationship Type Sequence for Division and Price Item screen appears where you can view person to person relationship type sequence defined for the division, price item, and price item parameters combination.
Edit	On clicking the Edit () icon, the Person Relationship Type Sequence for Division and Price Item screen appears where you can edit person to person relationship type sequence defined for the division, price item, and price item parameters combination.
Delete	On clicking the Delete () icon, you can delete person to person relationship type sequence defined for the division, price item, and price item parameters combination.

You can define person to person relationship type sequence for a division, price item, and price item parameters combination by clicking the **Add** link in the upper right corner of this zone.

Related Topics

For more information on...	See...
How to search person to person relationship type sequence for a division, price item, and price item parameters combination	Searching Relationship Type Sequence for a Division, Price Item, and Price Item Parameters on page 724
How to view person to person relationship type sequence of a division, price item, and price item parameters combination	Viewing Relationship Type Sequence of a Division, Price Item, and Price Item Parameters on page 728
How to define person to person relationship type sequence for a division, price item, and price item parameters combination	Defining Relationship Type Sequence for a Division, Price Item, and Price Item Parameters on page 725

For more information on...	See...
How to edit person to person relationship type sequence of a division, price item, and price item parameters combination	Editing Relationship Type Sequence of a Division, Price Item, and Price Item Parameters on page 726
How to delete person to person relationship type sequence of a division, price item, and price item parameters combination	Deleting Relationship Type Sequence of a Division, Price Item, and Price Item Parameters on page 727

Search Person Relationship Type Sequence for Division

Note: This topic is not applicable for the health insurance business.



The **Search Person Relationship Type Sequence for Division** zone allows you to search person to person relationship type sequence defined for a division. You can also define, edit, and delete person to person relationship type sequence of a division.

This zone contains the following two sections:

- **Search Criteria** — The **Search Criteria** section contains the following fields:

Field Name	Field Description	Mandatory (Yes or No)
Division	Used to specify the division. Note: You can only view those divisions to which you have access in the Division list.	No

- **Search Results** — On clicking the **Search** button, the search results appear based on the specified search criteria. The **Search Results** section contains the following columns:

Column Name	Column Description
Division	Indicates the division for which person to person relationship type sequence is defined.
Description	Displays the description of the division.
View	On clicking the View () icon, the Person Relationship Type Sequence for Division screen appears where you can view person to person relationship type sequence of the division.
Edit	On clicking the Edit () icon, the Person Relationship Type Sequence for Division screen appears where you can edit person to person relationship type sequence of the division.
Delete	On clicking the Delete () icon, you can delete the person to person relationship type sequence of the division.

You can define person to person relationship type sequence for a division by clicking the **Add** link in the upper right corner of this zone.

Related Topics

For more information on...	See...
How to search person to person relationship type sequence for a division	Searching Relationship Type Sequence for a Division on page 729

For more information on...	See...
How to view person to person relationship type sequence of a division	Viewing Relationship Type Sequence of a Division on page 732
How to define person to person relationship type sequence for a division	Defining Relationship Type Sequence for a Division on page 730
How to edit person to person relationship type sequence of a division	Editing Relationship Type Sequence of a Division on page 731
How to delete person to person relationship type sequence of a division	Deleting Relationship Type Sequence of a Division on page 732

Searching Relationship Type Sequence for a Division, Price Item, and Price Item Parameters

Note: This topic is not applicable for the health insurance business.

Prerequisites

To search person to person relationship type sequence for a division, price item, and price item parameters combination, you should have:

- Divisions defined in the application

Procedure

To search person to person relationship type sequence for a division, price item, and price item parameters combination:

1. Click the **Menu** link in the **Application** toolbar.
A list appears.
2. From the **Main** menu, select **Pricing Management** and then click **Person to Person Relationship Type Sequence**.
The **Person to Person Relationship Type Sequence** screen appears.
3. Enter the search criteria in the **Search Person Relationship Type Sequence for Price Item** zone.

Note: ORMB search engine supports wildcard search, where you can substitute the percentage (%) symbol as a stand in for any word or letter in a search criteria. You can use the ‘%’ wildcard character in all input fields except the date and ID fields. The ‘%’ wildcard character is suffixed automatically at the end of the partial search criteria. Therefore, you may or may not specify the wildcard character at the end of the partial search criteria. However, you have to prefix the wildcard character manually whenever required.

4. Click **Search**.

A list of division, price item, and price item parameters combinations that meet the search criteria and for which person to person relationship type sequence is defined appears in the **Search Results** section.

Related Topics

For more information on...	See...
Person to Person Relationship Type Sequence screen	Person to Person Relationship Type Sequence on page 721
Search Person Relationship Type Sequence for Price Item zone	Search Person Relationship Type Sequence for Price Item on page 721

Defining Relationship Type Sequence for a Division, Price Item, and Price Item Parameters

Note: This topic is not applicable for the health insurance business.

Prerequisites

To define person to person relationship type sequence for a division, price item, and price item parameters combination, you should have:

- Divisions defined in the application
- Price items associated with the division to which the user belongs
- Parameters associated with the price item
- Person relationship types defined in the application

Procedure

To define person to person relationship type sequence for a division, price item, and price item parameters combination:

1. Click the **Menu** link in the **Application** toolbar.

A list appears.

2. From the **Main** menu, select **Pricing Management** and then click **Person to Person Relationship Type Sequence**.

The **Person to Person Relationship Type Sequence** screen appears.

3. Click the **Add** link in the upper right corner of the **Search Person Relationship Type Sequence for Price Item** zone.

The **Person Relationship Type Sequence for Division and Price Item** screen appears. It contains the following fields:

Field Name	Field Description	Mandatory (Yes or No)
Division	Used to indicate the division for which you want to define price item and price item parameters specific person to person relationship type sequence.	Yes
Price Item	Used to specify the price item code. Note: The Search (🔍) icon appears corresponding to this field. On clicking the Search icon, the Price Item Search screen appears.	Yes
Price Item Parameters	Used to specify the price item parameters. Note: The Search (🔍) icon appears corresponding to this field. On clicking the Search icon, the Price Item Parameters Search screen appears.	No

In addition, this screen contains the following section:

- **Person Relationship Type Sequence** — This section allows you to define person to person relationship type sequence for the division, price item, and price item parameters combination. It contains the following columns:

Column Name	Column Description	Mandatory (Yes or No)
Sequence Number	Used to indicate the sequence in which relationship type should be considered while searching for effective price item pricing at the parent customer level.	Yes
Relationship Type	Used to indicate the person to person relationship type.	Yes

4. Enter the required details.

Note: You can search for a price item and price item parameters by clicking the **Search** (🔍) icon corresponding to the respective field.

5. If you want to define more than one relationship type in the person to person relationship type sequence, click the **Add** (+) icon and then enter the details in the **Person Relationship Type Sequence** section.

Note: However, if you want to remove a relationship type from the person to person relationship type sequence, click the **Delete** (🗑️) icon corresponding to the relationship type.

6. Click **Save**.

The person to person relationship type sequence is defined for the division, price item, and price item parameters combination.

Related Topics

For more information on...	See...
Person to Person Relationship Type Sequence screen	Person to Person Relationship Type Sequence on page 721
Search Person Relationship Type Sequence for Price Item zone	Search Person Relationship Type Sequence for Price Item on page 721
How to search for a price item	Searching for a Price Item or Price Item Bundle on page 361
How to set price item parameters	Defining a Parameter for a Price Item Pricing on page 579

Editing Relationship Type Sequence of a Division, Price Item, and Price Item Parameters

Note: This topic is not applicable for the health insurance business.

Prerequisites

To edit person to person relationship type sequence of a division, price item, and price item parameters combination, you should have:

- Person relationship types defined in the application

Procedure

To edit person to person relationship type sequence of a division, price item, and price item parameters combination:

1. Search person to person relationship type sequence for the division, price item, and price item parameters combination in the **Person to Person Relationship Type Sequence** screen.

- In the **Search Results** section, click the **Edit** (✎) icon in the **Edit** column corresponding to the division, price item, and price item parameters combination whose person to person relationship type sequence you want to edit.

The **Person Relationship Type Sequence for Division and Price Item** screen appears. It contains the following fields:

Field Name	Field Description	Mandatory (Yes or No)
Division	Indicates the division for which price item and price item parameters specific person to person relationship type sequence is defined.	Not applicable
Price Item	Displays the price item code.	Not applicable
Price Item Parameters	Displays a comma-separated list of parameter values. The order in which parameter values appear in this field is controlled by the display order (which is defined while associating a parameter with a price item).	Not applicable

In addition, this screen contains the following section:

- Person Relationship Type Sequence** — This section allows you to define person to person relationship type sequence for the division, price item, and price item parameters combination. It contains the following columns:

Column Name	Column Description	Mandatory (Yes or No)
Sequence Number	Used to indicate the sequence in which relationship type should be considered while searching for effective price item pricing at the parent customer level.	Yes
Relationship Type	Used to indicate the person to person relationship type.	Yes

- If you want to define more than one relationship type in the person to person relationship type sequence, click the **Add** (+) icon and then enter the details in the **Person Relationship Type Sequence** section.

Note: However, if you want to remove a relationship type from the person to person relationship type sequence, click the **Delete** (🗑) icon corresponding to the relationship type.

- Click **Save**.

The changes made to the person to person relationship type sequence are saved.

Related Topics

For more information on...	See...
How to search person to person relationship type sequence for a division, price item, and price item parameters combination	Searching Relationship Type Sequence for a Division, Price Item, and Price Item Parameters on page 724

Deleting Relationship Type Sequence of a Division, Price Item, and Price Item Parameters

Note: This topic is not applicable for the health insurance business.

Procedure

To delete person to person relationship type sequence of a division, price item, and price item parameters combination:

1. Search person to person relationship type sequence for the division, price item, and price item parameters combination in the **Person to Person Relationship Type Sequence** screen.
2. In the **Search Results** section, click the **Delete** (🗑️) icon in the **Delete** column corresponding to the division, price item, and price item parameters combination whose person to person relationship type sequence you want to delete.

A message appears confirming whether you want to delete the person to person relationship type sequence.

3. Click **OK**.

The person to person relationship type sequence of the division, price item, and price item parameters combination is deleted.

Related Topics

For more information on...	See...
How to search person to person relationship type sequence for a division, price item, and price item parameters combination	Searching Relationship Type Sequence for a Division, Price Item, and Price Item Parameters on page 724

Viewing Relationship Type Sequence of a Division, Price Item, and Price Item Parameters

Note: This topic is not applicable for the health insurance business.

Procedure

To view person to person relationship type sequence of a division, price item, and price item parameters combination:

1. Search person to person relationship type sequence for the division, price item, and price item parameters combination in the **Person to Person Relationship Type Sequence** screen.
2. In the **Search Results** section, click the **View** (🔗) icon in the **View** column corresponding to the division, price item, and price item parameters combination whose person to person relationship type sequence you want to view.

The **Person Relationship Type Sequence for Division and Price Item** screen appears. It contains the following fields:

Field Name	Field Description
Division	Indicates the division for which price item and price item parameters specific person to person relationship type sequence is defined.
Price Item	Displays the price item code.
Price Item Parameters	Displays a comma-separated list of parameter values. The order in which parameter values appear in this field is controlled by the display order (which is defined while associating a parameter with a price item).

In addition, this screen contains the following section:

- **Person Relationship Type Sequence** — This section allows you to view person to person relationship type sequence defined for the division, price item, and price item parameters combination. It contains the following columns:

Column Name	Column Description
Sequence Number	Indicates the sequence in which relationship type will be considered while searching for effective price item pricing at the parent customer level.
Relationship Type	Indicates the person to person relationship type.

3. View the person to person relationship type sequence defined for the division, price item, and price item parameters combination in the **Person Relationship Type Sequence for Division and Price Item** screen.

Related Topics

For more information on...	See...
How to search person to person relationship type sequence for a division, price item, and price item parameters combination	Searching Relationship Type Sequence for a Division, Price Item, and Price Item Parameters on page 724

Searching Relationship Type Sequence for a Division

Note: This topic is not applicable for the health insurance business.

Prerequisites

To search person to person relationship type sequence for a division, you should have:

- Divisions defined in the application

Procedure

To search person to person relationship type sequence for a division:

1. Click the **Menu** link in the **Application** toolbar.
A list appears.
2. From the **Main** menu, select **Pricing Management** and then click **Person to Person Relationship Type Sequence**.
The **Person to Person Relationship Type Sequence** screen appears.
3. Enter the search criteria in the **Search Person Relationship Type Sequence for Division** zone.

Note: ORMB search engine supports wildcard search, where you can substitute the percentage (%) symbol as a stand in for any word or letter in a search criteria. You can use the ‘%’ wildcard character in all input fields except the date and ID fields. The ‘%’ wildcard character is suffixed automatically at the end of the partial search criteria. Therefore, you may or may not specify the wildcard character at the end of the partial search criteria. However, you have to prefix the wildcard character manually whenever required.

4. Click **Search**.

A list of divisions that meet the search criteria and for which person to person relationship type sequence is defined appears in the **Search Results** section.

Related Topics

For more information on...	See...
Person to Person Relationship Type Sequence screen	<i>Person to Person Relationship Type Sequence</i> on page 721
Search Person Relationship Type Sequence for Division zone	<i>Search Person Relationship Type Sequence for Division</i> on page 723

Defining Relationship Type Sequence for a Division

Note: This topic is not applicable for the health insurance business.

Prerequisites

To define person to person relationship type sequence for a division, you should have:

- Divisions defined in the application

Procedure

To define person to person relationship type sequence for a division:

1. Click the **Menu** link in the **Application** toolbar.

A list appears.

2. From the **Main** menu, select **Pricing Management** and then click **Person to Person Relationship Type Sequence**.

The **Person to Person Relationship Type Sequence** screen appears.

3. Click the **Add** link in the upper right corner of the **Search Person Relationship Type Sequence for Division** zone.

The **Person Relationship Type Sequence for Division** screen appears. It contains the following fields:

Field Name	Field Description	Mandatory (Yes or No)
Division	Used to indicate the division for which you want to define person to person relationship type sequence.	Yes

In addition, this screen contains the following section:

- **Person Relationship Type Sequence** — This section allows you to define person to person relationship type sequence for the division. It contains the following columns:

Column Name	Column Description	Mandatory (Yes or No)
Sequence Number	Used to indicate the sequence in which relationship type should be considered while searching for effective price item pricing at the parent customer level.	Yes
Relationship Type	Used to indicate the person to person relationship type.	Yes

4. Enter the required details.
5. If you want to define more than one relationship type in the person to person relationship type sequence, click the **Add (+)** icon and then enter the details in the **Person Relationship Type Sequence** section.

Note: However, if you want to remove a relationship type from the person to person relationship type sequence, click the **Delete** (🗑️) icon corresponding to the relationship type.

6. Click **Save**.

The person to person relationship type sequence is defined for the division.

Related Topics

For more information on...	See...
Person to Person Relationship Type Sequence screen	Person Relationship Type Sequence on page 278
Search Person Relationship Type Sequence for Division zone	Search Person Relationship Type Sequence for Division on page 723

Editing Relationship Type Sequence of a Division

Note: This topic is not applicable for the health insurance business.

Procedure

To edit person to person relationship type sequence of a division:

1. Search person to person relationship type sequence for the division in the **Person to Person Relationship Type Sequence** screen.
2. In the **Search Results** section, click the **Edit** (✎) icon in the **Edit** column corresponding to the division whose person to person relationship type sequence you want to edit.

The **Person Relationship Type Sequence for Division** screen appears. It contains the following fields:

Field Name	Field Description	Mandatory (Yes or No)
Division	Indicates the division for which person to person relationship type sequence is defined.	Not applicable

In addition, this screen contains the following section:

- **Person Relationship Type Sequence** — This section allows you to define person to person relationship type sequence for the division. It contains the following columns:

Column Name	Column Description	Mandatory (Yes or No)
Sequence Number	Used to indicate the sequence in which relationship type should be considered while searching for effective price item pricing at the parent customer level.	Yes
Relationship Type	Used to indicate the person to person relationship type.	Yes

3. If you want to define more than one relationship type in the person to person relationship type sequence, click the **Add** (+) icon and then enter the details in the **Person Relationship Type Sequence** section.

Note: However, if you want to remove a relationship type from the person to person relationship type sequence, click the **Delete** (🗑️) icon corresponding to the relationship type.

4. Click **Save**.

The changes made to the person to person relationship type sequence are saved.

Related Topics

For more information on...	See...
How to search person to person relationship type sequence for a division	Searching Relationship Type Sequence for a Division on page 729

Deleting Relationship Type Sequence of a Division

Note: This topic is not applicable for the health insurance business.

Procedure

To delete person to person relationship type sequence of a division:

1. Search person to person relationship type sequence for the division in the **Person to Person Relationship Type Sequence** screen.
2. In the **Search Results** section, click the **Delete** (🗑️) icon in the **Delete** column corresponding to the division whose person to person relationship type sequence you want to delete.
A message appears confirming whether you want to delete the person to person relationship type sequence.
3. Click **OK**.

The person to person relationship type sequence of the division is deleted.

Related Topics

For more information on...	See...
How to search person to person relationship type sequence for a division	Search Person Relationship Type Sequence for Division on page 723

Viewing Relationship Type Sequence of a Division

Note: This topic is not applicable for the health insurance business.

Procedure

To view person to person relationship type sequence of a division:

1. Search person to person relationship type sequence for the division in the **Person to Person Relationship Type Sequence** screen.
2. In the **Search Results** section, click the **View** (🔗) icon in the **View** column corresponding to the division whose person to person relationship type sequence you want to view.

The **Person Relationship Type Sequence for Division** screen appears. It contains the following fields:

Field Name	Field Description
Division	Indicates the division for which person to person relationship type sequence is defined.

In addition, this screen contains the following section:

- **Person Relationship Type Sequence** — This section allows you to view person to person relationship type sequence defined for the division. It contains the following columns:

Column Name	Column Description
Sequence Number	Indicates the sequence in which relationship type will be considered while searching for effective price item pricing at the parent customer level.
Relationship Type	Indicates the person to person relationship type.

3. View the person to person relationship type sequence defined for the division in the **Person Relationship Type Sequence for Division** screen.

Related Topics

For more information on...	See...
How to search person to person relationship type sequence for a division	Search Person Relationship Type Sequence for Division on page 723

Chapter

5

Division

Topics:

- [Division](#)

The following two types of divisions are used while defining a contract type:

- **General Ledger (GL) Division** — GL divisions typically comprise of individual entities (for example, companies) in the general ledger. You must set up a GL division for each such entity. The GL division is used to define the accounting period for financial transactions linked to contracts. Contracts are associated with GL divisions through their contract type. The system uses accounting periods to prevent a user from creating financial transactions in the closed periods. It also uses accounting periods when it generates the flat file that contains the consolidated journal entry that is interfaced to the general ledger.
- **Division** — A division is associated with a jurisdiction. A jurisdiction is a geographic-oriented entity with unique business rules. For example, if you conduct business in California and Japan, each jurisdiction has different set of rules, and therefore you need to have a separate jurisdiction for each division. You must set up a division for each jurisdiction in which you conduct the business. For the Pricing Management functionality, setting up a division is mandatory, and the system must contain information about at least one division.

A division is associated with the following:

- **Person** — You may or may not associate person to a division. It is optional. But, when you are using division specific functionality, you have to associate person to a division while creating a local person.
- **Contract** — Contract is associated to a division through its contract type. The contract type controls multiple business rules which are defined for a given jurisdiction and contract type combination. In addition to controlling the business rules defined on the contract's contract type, the contract's division also controls the type of collection criteria used to determine if and how to collect overdue debt.
- **Account** — The division on account when combined with the account's customer class defines the jurisdiction that governs financial business rules (for example, the bill's due date, when and how late payment charges are calculated, etc.). It also allows you to assign To Do entries associated with the account to a given To Do role based on the account's division.

Division

The **Division** screen allows you to define, edit, and delete a division. It consists of the following tabs:

Tab Name	Tab Description	Mandatory (Yes or No)
Main	Used to define basic details of a division.	Yes
Access Groups	Used to define the users who have right to associate objects (such as persons, accounts, price items, price lists, etc.) with this division. The users can only view those divisions to which they have access in the Division list used across the application.	No
Price Items	Used to define which price items are available to persons or accounts in a division.	No
	Note: Once the price item is created, you need to associate it with a division.	
Price Lists	Used to define which price lists are available to persons or accounts in a division.	No
	Note: Once the price list is created, you need to associate it with a division. You can associate a price list with a division when all price items in the price list are already associated with the division.	
Languages	Used to limit the languages that you can select for a person's bills and correspondence in a division.	No
Invoice Currencies	Used to limit the invoice currencies that you can select for accounts in a division.	No
	Note: Invoice currency is a currency in which the accounts in the division can be billed.	
Person Identifier Types	Used to limit the person identifier types that you can select for persons in a division.	No
Algorithms	Used to associate algorithms with the division. Once a division is created, you must associate the Price Assignment Search algorithm to it. For the Banking functionality, this is required to ensure that the price item pricing is displayed in the correct order as defined by the algorithm. Each division can have unique hierarchy order or more than one division can have the same hierarchy order. The hierarchy order is also used in billing when the price determination is controlled by the sort order definition of the algorithm.	No

Tab Name	Tab Description	Mandatory (Yes or No)
	<p>You can define algorithms in the Algorithm screen. The search order is governed by the second parameter of the algorithm, and the valid values for the same are:</p> <ul style="list-style-type: none"> • AGREED_PRICELIST - If you use this search order, the price item pricing is searched in the following order: Account Agreed, Account Price List, Account Inherited Price List, Customer Agreed, Customer Price List, Customer Inherited Price List, Parent Customer Agreed, Parent Customer Price List, and Parent Customer Inherited Price List. <div data-bbox="602 583 1112 730" style="border: 1px solid black; padding: 5px;"> <p>Note: In this search order, the account agreed level has highest precedence and parent customer inherited price list level has lowest precedence.</p> </div> <ul style="list-style-type: none"> • AGREED_FIRST - If you use this search order, the price item pricing is searched in the following order: Account Agreed, Customer Agreed, Parent Customer Agreed, Account Price List, Account Inherited Price List, Customer Price List, Customer Inherited Price List, Parent Customer Price List, and Parent Customer Inherited Price List. <div data-bbox="602 1020 1112 1167" style="border: 1px solid black; padding: 5px;"> <p>Note: In this search order, the account agreed level has highest precedence and parent customer inherited price list level has lowest precedence.</p> </div>	
Characteristics	Used to define the characteristics for a division.	No
Bill Messages	Used to specify the bill messages that are valid for accounts in a division.	No
Party Char Types	Used to limit the characteristic types that you can select for persons and accounts in a division.	No
Bill Cycles	Used to limit the bill cycles that you can select for accounts in a division.	No
Account Identifier Types	Used to limit the account identifier types that you can select for accounts in a division.	No
Price Item Characteristics	Used to define division-specific characteristics for price items associated with the division.	No

Related Topics

For more information on...	See...
How to define a division	Defining a Division on page 746
How to associate access groups with a division	Associating an Access Group with a Division on page 749

For more information on...	See...
How to associate price items with a division	Associating a Price Item or Price Item Bundle with a Division on page 750
How to associate price lists with a division	Associating a Price List with a Division on page 752
How to associate languages with a division	Associating a Language with a Division on page 753
How to associate invoice currencies with a division	Associating an Invoice Currency with a Division on page 754
How to associate person identifier types with a division	Associating a Person Identifier Type with a Division on page 755
How to associate algorithms with a division	Associating an Algorithm with a Division on page 756
How to define a characteristic for a division	Defining a Characteristic for a Division on page 763
How to associate bill messages with a division	Associating a Bill Message with a Division on page 764
How to associate party characteristic types with a division	Associating a Party Characteristic Type with a Division on page 766
How to associate bill cycles with a division	Associating a Bill Cycle with a Division on page 767
How to associate account identifier types with a division	Associating an Account Identifier Type with a Division on page 768
How to define division-specific characteristics for a price item	Defining a Division-Specific Characteristic for a Price Item on page 769

Division - Main

The **Main** tab displays the basic information about the division. It contains the following fields:

Field Name	Field Description
Division	<p>Indicates the division.</p> <p>Note: The Search (🔍) icon appears corresponding to the Division field. On clicking the Search icon, the Division Search window appears where you can search for a division.</p>
Description	Displays the description of the division.
Work Calendar	Indicates the work calendar which is associated with the division.
Status	<p>Indicates the status of the division. The valid values are:</p> <ul style="list-style-type: none"> • Active • Pending • Retired
Bill Format	<p>Indicates the format in which the bills should be printed for the accounts which belong to the division. The valid values are:</p> <ul style="list-style-type: none"> • Detailed • Summary

Field Name	Field Description
Bill Route Type	Indicates how the bills must be sent to the main customer of the accounts which belong to the division.
Base Currency	Indicates the currency in which the GL entries should be created for the accounts which belong to the division.
Time Zone	Indicates the time zones in which the division is operational.
Eligible for Accrual	Indicates whether accrual should be calculated for the accounts which belong to the division.
Accrual Cycle	Indicates the accrual cycle of the accounts which belong to the division.
Direct Credit Refund	Used to indicate whether you want to process immediate refund for the accounts belonging to the division through the direct credit mode.
A/P Request Fund	Used to indicate whether you want to process immediate refund for the accounts belonging to the division through the A/P request mode.
Immediate Refund	Used to indicate whether you want to process immediate refund for the accounts belonging to the division.
	Note: This field is enabled when the Direct Credit Refund or A/P Request Refund option is selected.
Comments	Displays additional details about the division.
Business Object	Indicates the business object using which the division is created in the system.

In addition, the **Main** tab contains the following fields in a grid:

Field Name	Field Description
To Do Type	Indicates the To Do type for which division-specific To Do role is defined.
To Do Role	Indicates the To Do role whose users must receive the To Do entries of the specified To Do type for the accounts which belong to the division.

Related Topics

For more information on...	See...
How to define a division	Defining a Division on page 746

Division - Access Groups

The **Access Groups** tab lists the access groups which are associated with the division. It contains the following field:

Field Name	Field Description
Division	Indicates the division.

In addition, the following fields appear in a grid:

Field Name	Field Description
Access Group	Indicates the access group which is associated with the division.
Description	Displays the description of the access group.

Related Topics

For more information on...	See...
How to associate an access group with a division	Associating an Access Group with a Division on page 749

Division - Price Items

The **Price Items** tab lists the price items which are associated with the division. It contains the following field:

Field Name	Field Description
Division	Indicates the division.

In addition, the following fields appear in a grid:

Field Name	Field Description
Price Item	Indicates the price item which is associated with the division.
Description	Displays the description of the price item.
Accrual Type Criteria	Indicates whether the billable charges of the price item should be considered for accrual depending on the accrual criteria specified in the accrual type. The valid values are: <ul style="list-style-type: none"> • Actual • Historical • Not Applicable

Related Topics

For more information on...	See...
How to associate a price item with a division	Associating a Price Item or Price Item Bundle with a Division on page 750

Division - Price Lists

The **Price Lists** tab lists the price lists which are associated with the division. It contains the following field:

Field Name	Field Description
Division	Indicates the division.

In addition, the following fields appear in a grid:

Field Name	Field Description
Price List ID	Indicates the price list.
Description	Displays the description of the price list.

Related Topics

For more information on...	See...
How to associate a price list with a division	Associating a Price List with a Division on page 752

Division - Languages

The **Languages** tab lists the languages which you can select for generating invoice and correspondence for the accounts in the division. It contains the following field:

Field Name	Field Description
Division	Indicates the division.

In addition, the following field appears in a grid:

Field Name	Field Description
Language	Indicates the language associated with the division.

Related Topics

For more information on...	See...
How to associate a language with a division	Associating a Language with a Division on page 753

Division - Invoice Currencies

The **Invoice Currencies** tab lists the currencies which you can use for generating the invoice of the accounts in the division. It contains the following field:

Field Name	Field Description
Division	Indicates the division.

In addition, the following fields appear in a grid:

Field Name	Field Description
Currency	Indicates the currency.
Rounding Type	Indicates the rounding type for the currency. The valid values are: <ul style="list-style-type: none"> • Down • Nearest • Up

Related Topics

For more information on...	See...
How to associate an invoice currency with a division	Associating an Invoice Currency with a Division on page 754

Division - Person Identifier Types

The **Person Identifier Types** tab lists the identifier types which are valid for the persons associated with the division. It contains the following field:

Field Name	Field Description
Division	Indicates the division.

In addition, the following field appears in a grid:

Field Name	Field Description
Person Identifier Type	Indicates the person identifier type.

Related Topics

For more information on...	See...
How to associate a person identifier type with a division	Associating a Person Identifier Type with a Division on page 755

Division - Algorithms

The **Algorithms** tab lists the algorithms which are associated with the division. It contains the following field:

Field Name	Field Description
Division	Indicates the division.

In addition, the following fields appear in a grid:

Field Name	Field Description
Division Algorithm Entity	Indicates the algorithm entity to which you want to attach the algorithm.
Sequence Number	Displays the order in which the algorithms with the same entity should be executed.
Algorithm	Indicates the algorithm.
Description	Displays the description of the algorithm.

Related Topics

For more information on...	See...
How to associate an algorithm with a division	Associating an Algorithm with a Division on page 756

Division - Characteristics

The **Characteristics** tab lists the characteristics which are defined for the division. It contains the following field:

Field Name	Field Description
Division	Indicates the division.

In addition, the following fields appear in a grid:

Field Name	Field Description
Effective Date	Indicates the date from when the characteristic is effective for the division.
Characteristic Type	Indicates the characteristic type.
Characteristic Value	Indicates the value for the characteristic type.

Related Topics

For more information on...	See...
How to define a characteristic for a division	Defining a Characteristic for a Division on page 763

Division - Bill Messages

The **Bill Messages** tab lists the bill messages which are valid for the accounts in the division for a specified duration. It contains the following field:

Field Name	Field Description
Division	Indicates the division.

In addition, the following fields appear in a grid:

Field Name	Field Description
Start Date	Indicates the date from when you want the bill message to appear on the bill.
End Date	Indicates the date till when you want the bill message to appear on the bill.
Bill Message	Indicates the bill message that is valid for the accounts in the division.
Description	Displays the description of the bill message.

Related Topics

For more information on...	See...
How to associate a bill message with a division	Associating a Bill Message with a Division on page 764

Division - Party Char Types

The **Party Char Types** tab lists the characteristic types which are valid for the persons and accounts associated with the division. It contains the following field:

Field Name	Field Description
Division	Indicates the division.

In addition, the following fields appear in a grid:

Field Name	Field Description
Characteristic Entity	Indicates whether the characteristic type is valid for a person or an account in this division.
Characteristic Type	Indicates the characteristic type.

Related Topics

For more information on...	See...
How to associate a party char type with a division	Associating a Party Characteristic Type with a Division on page 766

Division - Bill Cycles

The **Bill Cycles** tab lists the bill cycles which are valid for the accounts associated with the division. It contains the following field:

Field Name	Field Description
Division	Indicates the division.

In addition, the following field appears in a grid:

Field Name	Field Description
Bill Cycle	Indicates the bill cycle.

Related Topics

For more information on...	See...
How to associate a bill cycle with a division	Associating a Bill Cycle with a Division on page 767

Division - Account Identifier Types

The **Account Identifier Types** tab lists the identifier types which are valid for the accounts associated with the division. It contains the following field:

Field Name	Field Description
Division	Indicates the division.

In addition, the following field appears in a grid:

Field Name	Field Description
Account Identifier Type	Indicates the account identifier type.

Related Topics

For more information on...	See...
How to associate an account identifier type with a division	Associating an Account Identifier Type with a Division on page 768

Division - Price Item Characteristics

The **Price Item Characteristics** tab lists division-specific characteristics of price items which are associated with the division. It contains the following field:

Field Name	Field Description
Division	Indicates the division.

In addition, the following fields appear in a grid:

Field Name	Field Description
Price Item	Displays the price item count associated with the selected division to which the user belongs.
Price Item	Displays the price item associated with the division to which the user belongs.
Effective Date	Indicates the date from when the price item characteristic is effective for the division.

Field Name	Field Description
Characteristic Type	Indicates the characteristic type.
Characteristic Value	Displays the value for the characteristic type.

Related Topics

For more information on...	See...
How to define a division-specific characteristic for a price item	Defining a Division-Specific Characteristic for a Price Item on page 769

Searching for a Division

Procedure

To search for a division:

1. Click the **Admin** link in the **Application** toolbar.
A list appears.
2. From the **Admin** menu, select **D** and then click **Division**.
A sub-menu appears.
3. Click the **Search** option from the **Division** sub-menu.

The **Division Search** window appears. It contains the following two sections:

- **Search Criteria** - The **Search Criteria** section contains the following fields:

Field Name	Field Description	Mandatory (Yes or No)
Division	Used to search for a particular division.	No
Description	Used to search division with a particular name.	No

Note: You must specify at least one search criterion while searching for a division.

- **Search Results** - On clicking the **Search** button corresponding to the respective field, the search results appear based on the specified search criteria. The **Search Results** section contains the following columns:

Column Name	Column Description
Division	Displays the division.
Description	Displays the description of the division.

Note: ORMB search engine supports wildcard search, where you can substitute the percentage (%) symbol as a stand in for any word or letter in a search criteria. You can use the '%' wildcard character in all input fields except the date and ID fields. The '%' wildcard character is suffixed automatically at the end of the partial search criteria. Therefore, you may or may not specify the wildcard character at the end of the partial search criteria. However, you have to prefix the wildcard character manually wherever required.

4. In the **Search Results** section, click the division whose details you want to view or edit.

The **Division** screen appears.

Related Topics

For more information on...	See...
Division screen	Division on page 736

Defining a Division

Prerequisites

To define a division, you should have:

- Required division business object defined in the application
- Work calendars, bill route types, currencies, time zones, accrual cycles, To Do types, and To Do roles defined in the application
- Values defined for the **BILL_FORMAT_FLG** lookup field

Procedure

To define a division:

1. Click the **Admin** link in the **Application** toolbar.
A list appears.
2. From the **Admin** menu, select **D** and then click **Division**.
A sub-menu appears.
3. Click the **Add** option from the **Division** sub-menu.
The **Division** screen appears.
4. Ensure that the **Main** tab is selected.

The **Main** tab contains the following fields:

Field Name	Field Description	Mandatory (Yes or No)
Division	Used to specify the division.	Yes
Description	Used to specify the description for the division.	Yes
Work Calendar	Used to indicate the work calendar that you want to associate with the division. The work calendar indicates the days when the division is operational. It is used to ensure that the system calculated dates (for example, bill due date, credit and collection event dates, etc.) fall on a working day. Note: The list includes only those work calendars which are already defined in the system.	Yes
Status	Used to indicate the status of the division. The valid values are: <ul style="list-style-type: none"> • Active - Indicates that you can use the division in the system. • Pending - Indicates that the division is not yet available for use. • Retired - Indicates that the division is no longer available for use. 	No

Field Name	Field Description	Mandatory (Yes or No)
	Note: The list includes only those statuses which are defined in the DIVISION_STATUS_FLG lookup field.	
Bill Format	Used to specify the format in which the bills should be printed for the accounts which belong to the division. The valid values are: <ul style="list-style-type: none"> Detailed Summary Note: The list includes only those bill formats which are defined in the BILL_FORMAT_FLG lookup field.	No
Bill Route Type	Used to indicate how the bills must be sent to the main customer of the accounts which belong to the division. Note: The list includes only those bill route types which are already defined in the system.	No
Base Currency	Used to specify the currency in which the GL entries should be created for the accounts which belong to the division. If the account's invoice currency and division's base currency are different, the system converts the GL amount from the account's invoice currency to the division's base currency. In such cases, the system creates the financial transactions for the accounts in both the currencies (i.e. account's invoice currency and division's base currency). Note: The list includes only those currencies which are already defined in the system.	Yes
Time Zone	Used to indicate the time zone in which the division is operational. Note: The list includes only those time zones which are already defined in the system.	No
Eligible for Accrual	Used to indicate whether you can calculate accrual for the accounts which belong to the division.	No
Accrual Cycle	Used to indicate the accrual cycle for the accounts which belong to the division.	Yes (Conditional) Note: The field is required when the Eligible for Accrual option is selected.

Field Name	Field Description	Mandatory (Yes or No)
	<p>Note:</p> <p>This field is enabled when the Eligible for Accrual option is selected.</p> <p>The Search (🔍) icon appears corresponding to the Accrual Cycle field. On clicking the Search icon, the Accrual Cycle Search window appears.</p>	
Comments	Used to specify additional details about the division.	No
Business Object	<p>Used to indicate the business object using which you want to create the division.</p> <p>Note: The Search (🔍) icon appears corresponding to the Business Object field. On clicking the Search icon, the Business Object Search window appears.</p>	Yes

In addition, the **Main** tab contains the following fields in a grid:

Field Name	Field Description	Mandatory (Yes or No)
To Do Type	Used to indicate the To Do type for which you want to define division-specific To Do role.	Yes (Conditional)
	<p>Note: The Search (🔍) icon appears corresponding to the To Do Type field. On clicking the Search icon, the To Do Type Search window appears.</p>	<p>Note: This field is required when you are defining the division-specific To Do role for a To Do type.</p>
To Do Role	Used to indicate the To Do role whose users must receive the To Do entries of the specified To Do type for the accounts which belong to the division.	Yes (Conditional)
	<p>Note: The Search (🔍) icon appears corresponding to the To Do Role field. On clicking the Search icon, the Role for To Do Type window appears.</p>	<p>Note: This field is required when you are defining the division-specific To Do role for a To Do type.</p>

- Enter the required details in the **Main** tab.
- Associate access groups, price items, price lists, languages, invoice currencies, person identifier types, algorithms, bill messages, party characteristic types, bill cycles, and account identifier types with the division, if required.
- Define characteristics for the division, if required.
- Define division-specific characteristics for the price items, if required.
- Click the **Save** button in the **Page Title** area.

The division is defined. The status of the division is set to **Pending**.

Related Topics

For more information on...	See...
Division screen	Division on page 736
Main tab	Division - Main on page 738
How to associate an access group with a division	Associating an Access Group with a Division on page 749
How to associate a price item with a division	Associating a Price Item or Price Item Bundle with a Division on page 750
How to associate a price list with a division	Associating a Price List with a Division on page 752
How to associate a language with a division	Associating a Language with a Division on page 753
How to associate an invoice currency with a division	Associating an Invoice Currency with a Division on page 754
How to associate a person identifier type with a division	Associating a Person Identifier Type with a Division on page 755
How to associate an algorithm with a division	Associating an Algorithm with a Division on page 756
How to define a characteristic for a division	Defining a Characteristic for a Division on page 763
How to associate a bill message with a division	Associating a Bill Message with a Division on page 764
How to associate a party characteristic type with a division	Associating a Party Characteristic Type with a Division on page 766
How to associate a bill cycle with a division	Associating a Bill Cycle with a Division on page 767
How to associate an account identifier type with a division	Associating an Account Identifier Type with a Division on page 768
How to define a division-specific characteristic for a price item	Defining a Division-Specific Characteristic for a Price Item on page 769

Associating an Access Group with a Division

On associating an access group with a division, the users which belong to the access group can view the division in the respective list across the system. These users can then create and edit the accounts of the division.

Prerequisites

To associate an access group with a division, you should have:

- Access groups defined in the application

Procedure

To associate an access group with a division:

1. Search for the division to which you want to associate an access group.
2. Click the **Access Groups** tab in the **Division** screen.

The **Access Groups** tab appears. It contains the following field:

Field Name	Field Description
Division	Indicates the division.
	Note: The Search (🔍) icon appears corresponding to the Division field. On clicking the Search icon, the Division Search window appears where you can search for a division.

In addition, it contains the following fields in a grid:

Field Name	Field Description	Mandatory (Yes or No)
Access Group	Used to indicate the access group which you want to associate with the division.	Yes (Conditional)
	<p>Note:</p> <p>The Search (🔍) icon appears corresponding to the Access Group field. On clicking the Search icon, the Access Group Search window appears.</p> <p>On specifying an access group, the description of the access group appears in the Description field.</p>	<p>Note: This field is required when you are associating an access group with the division.</p>
Description	Displays the description of the access group.	Not applicable

- Enter the required details in the **Access Groups** tab.
- If you want to associate more than one access group with the division, click the **Add** (+) icon and then repeat step 3.

Note: However, if you want to remove an access group from the division, click the **Delete** (🗑️) icon corresponding to the access group.

- Click the **Save** button in the **Page Title** area.

The access group is associated with the division.

Related Topics

For more information on...	See...
How to search for a division	Searching for a Division on page 745
Division screen	Division on page 736
Access Groups tab	Division - Access Groups on page 739
How to define a division	Defining a Division on page 746

Associating a Price Item or Price Item Bundle with a Division

On associating a price item with a division, you can assign the price item to the persons and accounts which belong to the division. While associating a price item with a division, you can specify the accrual type criteria for the price item. The accrual type criteria is referred when the accrual is calculated for an account using an accrual type where the **Price Item Accrual Criteria Required** option is selected. The system behaves in the following manner when the **Price Item Accrual Criteria Required** option is selected in the accrual type:

If the accrual type criteria is set to...	Then...
Actual	The system considers the billable charges of the price item when the accrual is calculated for an account using the accrual type where the accrual criteria is set to Actual .
Historical	The system considers the billable charges of the price item when the accrual is calculated for an account using the accrual type where the accrual criteria is set to Historical .

Prerequisites

To associate a price item with a division, you should have:

- Price items defined in the application

Procedure

To associate a price item with a division:

1. Search for the division to which you want to associate a price item.
2. Click the **Price Items** tab in the **Division** screen.

The **Price Items** tab appears. It contains the following field:

Field Name	Field Description
Division	Indicates the division. Note: The Search (🔍) icon appears corresponding to the Division field. On clicking the Search icon, the Division Search window appears where you can search for a division.

In addition, it contains the following fields in a grid:

Field Name	Field Description	Mandatory (Yes or No)
Price Item	Used to indicate the price item which you want to associate with the division. Note: The Search (🔍) icon appears corresponding to the Price Item field. On clicking the Search icon, the Price Item Search window appears. On specifying a price item, the description of the price item appears in the Description field.	Yes (Conditional) Note: This field is required when you are associating a price item with the division.
Description	Displays the description of the price item.	Not applicable
Accrual Type Criteria	Used to indicate whether the billable charges of the price item should be considered for accrual depending on the accrual criteria specified in the accrual type. The valid values are: <ul style="list-style-type: none"> • Actual <ul style="list-style-type: none"> - Used to indicate that the billable charges of the price item should be considered for accrual when the accrual criteria in the accrual type is set to Actual. • Historical <ul style="list-style-type: none"> - Used to indicate that the billable charges of the price item should be considered for accrual when the accrual criteria in the accrual type is set to Historical. • Not Applicable 	No

Field Name	Field Description	Mandatory (Yes or No)
	- Used to indicate that the billable charges of the price item should be considered for accrual irrespective of the accrual criteria specified in the accrual type	

- Enter the required details in the **Price Items** tab.
- If you want to associate more than one price item with the division, click the **Add (+)** icon and then repeat step 3.

Note: However, if you want to remove a price item from the division, click the **Delete (🗑)** icon corresponding to the price item.

- Click the **Save** button in the **Page Title** area.
The price item is associated with the division.

Related Topics

For more information on...	See...
How to search for a division	Searching for a Division on page 745
Division screen	Division on page 736
Price Items tab	Division - Price Items on page 740
How to define a division	Defining a Division on page 746

Associating a Price List with a Division

Prerequisites

To associate a price list with a division, you should have:

- Price lists defined in the application

Procedure

To associate a price list with a division:

- Search for the division to which you want to associate a price list.
- Click the **Price Lists** tab in the **Division** screen.

The **Price Lists** tab appears. It contains the following field:

Field Name	Field Description
Division	Indicates the division. Note: The Search (🔍) icon appears corresponding to the Division field. On clicking the Search icon, the Division Search window appears where you can search for a division.

In addition, it contains the following fields in a grid:

Field Name	Field Description	Mandatory (Yes or No)
Price List ID	Used to specify the price list which you want to associate with the division.	Yes (Conditional)
	<p>Note:</p> <p>The Search (🔍) icon appears corresponding to this field. On clicking the Search icon, the Price List Search window appears.</p> <p>On specifying a price list, the description of the price list appears in the Description field.</p>	<p>Note: This field is required when you are associating a price list with a division.</p>
Description	Displays the description of the price list.	Not applicable

- Enter the required details in the **Price Lists** tab.
- If you want to associate more than one price list with the division, click the **Add** (+) icon and then repeat step 3.

Note: However, if you want to remove a price list from the division, click the **Delete** (🗑️) icon corresponding to the price list.

- Click the **Save** button in the **Page Title** area.

The price list is associated with the division.

Related Topics

For more information on...	See...
How to search for a division	Searching for a Division on page 745
Price Lists tab	Division - Price Lists on page 740
Division screen	Division on page 736
How to define a division	Defining a Division on page 746

Associating a Language with a Division

Prerequisites

To associate a language with a division, you should have:

- Languages defined in the application

Procedure

To associate a language with a division:

- Search for the division to which you want to associate a language.
- Click the **Languages** tab in the **Division** screen.

The **Languages** tab appears. It contains the following field:

Field Name	Field Description
Division	Indicates the division.

Field Name	Field Description
	Note: The Search (🔍) icon appears corresponding to the Division field. On clicking the Search icon, the Division Search window appears where you can search for a division.

In addition, it contains the following field in a grid:

Field Name	Field Description	Mandatory (Yes or No)
Language	Used to specify the language which you want to select for generating invoice and correspondence for the accounts in the division.	No

3. Select the language from the list.
4. If you want to associate more than one language with the division, click the **Add** (+) icon and then repeat step 3.

Note: However, if you want to remove a language from the division, click the **Delete** (🗑️) icon corresponding to the language.

5. Click the **Save** button in the **Page Title** area.

The language is associated with the division.

Related Topics

For more information on...	See...
How to search for a division	Searching for a Division on page 745
Languages tab	Division - Languages on page 741
Division screen	Division on page 736
How to define a division	Defining a Division on page 746

Associating an Invoice Currency with a Division

Prerequisites

To associate an invoice currency with a division, you should have:

- Currencies defined in the application

Procedure

To associate an invoice currency with a division:

1. Search for the division to which you want to associate an invoice currency.
2. Click the **Invoice Currencies** tab in the **Divisions** screen.

The **Invoice Currencies** tab appears. It contains the following field:

Field Name	Field Description
Division	Indicates the division.
	Note: The Search (🔍) icon appears corresponding to the Division field. On clicking the Search icon, the Division Search window appears where you can search for a division.

In addition, it contains the following fields in a grid:

Field Name	Field Description	Mandatory (Yes or No)
Currency	Used to indicate the currency which you want to use for generating the invoice of the accounts in the division.	Yes (Conditional) Note: This field is required when you are associating an invoice currency with the division.
Rounding Type	Used to indicate the rounding type for the currency. The valid values are: <ul style="list-style-type: none"> • Down • Nearest • Up 	Yes (Conditional) Note: This field is required when you are associating an invoice currency with the division.

3. Select the currency and its rounding type from the respective list.
4. If you want to associate more than one invoice currency with the division, click the **Add (+)** icon and then repeat step 3.

Note: However, if you want to remove an invoice currency from the division, click the **Delete (🗑)** icon corresponding to the currency.

5. Click the **Save** button in the **Page Title** area.

The invoice currency is associated with the division.

Related Topics

For more information on...	See...
How to search for a division	Searching for a Division on page 745
Invoice Currencies tab	Division - Invoice Currencies on page 741
Division screen	Division on page 736
How to define a division	Defining a Division on page 746

Associating a Person Identifier Type with a Division

Prerequisites

To associate a person identifier type with a division, you should have:

- Person identifier types defined in the application

Procedure

To associate a person identifier type with a division:

1. Search for the division to which you want to associate a person identifier type.
2. Click the **Person Identifier Types** tab in the **Division** screen.

The **Person Identifier Types** tab appears. It contains the following field:

Field Name	Field Description
Division	Indicates the division.
	Note: The Search (🔍) icon appears corresponding to the Division field. On clicking the Search icon, the Division Search window appears where you can search for a division.

In addition, it contains the following field in a grid:

Field Name	Field Description	Mandatory (Yes or No)
Person Identifier Type	Used to indicate the person identifier type.	Yes (Conditional)
		Note: This field is required when you are associating a person identifier type with a division.

3. Select the person identifier type from the list.
4. If you want to associate more than one person identifier type with the division, click the **Add** (+) icon and then repeat step 3.

Note: However, if you want to remove a person identifier type from the division, click the **Delete** (🗑️) icon corresponding to the person identifier type.

5. Click the **Save** button in the **Page Title** area.

The person identifier type is associated with the division.

Related Topics

For more information on...	See...
How to search for a division	Searching for a Division on page 745
Person Identifier Types tab	Division - Person Identifier Types on page 741
Division screen	Division on page 736
How to define a division	Defining a Division on page 746

Associating an Algorithm with a Division

Prerequisites

To associate an algorithm with a division, you should have:

- Required algorithms defined in the application

Procedure

To associate an algorithm with a division:

1. Search for the division to which you want to associate the algorithm.

The **Division** screen appears.

2. Click the **Algorithms** tab.

The **Algorithms** tab appears. It contains the following field:

Field Name	Field Description
Division	Indicates the division. Note: The Search (🔍) icon appears corresponding to the Division field. On clicking the Search icon, the Division Search window appears where you can search for a division.

In addition, it contains the following fields in a grid:

Field Name	Field Description	Mandatory (Yes or No)
Division Algorithm Entity	<p>Used to indicate the algorithm entity to which you want to attach the algorithm. The valid values are:</p> <ul style="list-style-type: none"> ASL Accumulation Post-Processing - Used to attach an algorithm which must be triggered for undertaking some post-processing activities on the aggregate stop-loss accumulation amount. This algorithm is invoked when you execute the C1-ACASL batch. <p>Note: No algorithm types for this algorithm entity are shipped with the product. The implementation team can create custom algorithm type for this algorithm entity based on the customer requirements.</p> ASL Accumulation Pre-Processing - Used to attach an algorithm which must be triggered for undertaking some pre-processing activities on the aggregate stop-loss accumulation records. This algorithm is invoked when you execute the C1-ACASL batch. <p>Note: No algorithm types for this algorithm entity are shipped with the product. The implementation team can create custom algorithm type for this algorithm entity based on the customer requirements.</p> Account - Post Processing - Used to attach an algorithm which must be triggered when you create or edit an account. <p>Note: The C1-CLSACCT and C1-UACM-IC algorithm types are shipped with the product. For more information, see the algorithm type description.</p> Accrual - Used to attach an algorithm which must be triggered to create the accruals for the account. 	<p>Yes (Conditional)</p> <p>Note: This field is required when you are associating an algorithm with the division.</p>

Field Name	Field Description	Mandatory (Yes or No)
	<ul style="list-style-type: none"> • Contract Derivation - Used to attach an algorithm which must be triggered to derive active contract for the account. This algorithm is invoked when you execute the C1-TXNVP batch. Note that this algorithm is invoked only when the account has multiple active contracts of the contract type which is associated with the price item. <div data-bbox="647 474 1122 617" style="border: 1px solid black; padding: 5px;"> <p>Note: The SA_DERV_POPC algorithm type is shipped with the product. For more information, see the algorithm type description.</p> </div>	
	<ul style="list-style-type: none"> • Currency Conversion For Adjustments - Used to attach a date or date and time based currency conversion algorithm which must be triggered while creating adjustments and FT GL entries for adjustments. <div data-bbox="647 835 1122 1010" style="border: 1px solid black; padding: 5px;"> <p>Note: The C1_CURALGAD and C1_EXCRTAD algorithm types are shipped with the product. For more information, see the algorithm type description.</p> </div> <ul style="list-style-type: none"> • Currency Conversion For Bill Segments - Used to attach a date or date and time based currency conversion algorithm which must be triggered while creating bill segments and FT GL entries for bill segments. <div data-bbox="647 1203 1122 1377" style="border: 1px solid black; padding: 5px;"> <p>Note: The C1_CURALGBS and C1_EXCRTBS algorithm types are shipped with the product. For more information, see the algorithm type description.</p> </div> <ul style="list-style-type: none"> • Currency Conversion For Payments - Used to attach a date or date and time based currency conversion algorithm which must be triggered while creating payments, payment tenders, and FT GL entries for payments. <div data-bbox="647 1604 1122 1778" style="border: 1px solid black; padding: 5px;"> <p>Note: The C1_CURALGPY and C1_EXCRTPY algorithm types are shipped with the product. For more information, see the algorithm type description.</p> </div> <ul style="list-style-type: none"> • GL Account Validation - Used to attach an algorithm which must be triggered during dynamic GL account validation. 	

Field Name	Field Description	Mandatory (Yes or No)
	<p data-bbox="654 212 1122 344">Note: The C1-GLVAL and C1-GLVAL-COB algorithm types are shipped with the product. For more information, see the algorithm type description.</p> <ul data-bbox="618 369 1122 653" style="list-style-type: none"> • GL Assign - • Generate Conditional GL Entries - • Price Assignment Eligibility - Used to attach an algorithm which must be triggered to determine whether the post-processing pricing is eligible for the account. This algorithm is invoked when you execute the C1-BLPPR and POSTPROC batches. <p data-bbox="654 678 1122 1087">Note: This algorithm is invoked while executing these batches when an algorithm created using the C1-GENBSICPA algorithm type is attached to the Post-Processing (Billing) algorithm spot of the respective contract type. The C1-ELIGPROR algorithm type is shipped with the product. For more information, see the algorithm type description.</p>	
	<ul data-bbox="618 1144 1122 1360" style="list-style-type: none"> • Price Assignment Search - Used to attach an algorithm which indicates the order in which the price item pricing must be determined while billing. It also indicates the order in which the price item pricing must be listed in the Pricing (Account) and Pricing (Person) screens. <p data-bbox="654 1386 1122 1518">Note: The C1_PRASN_PP algorithm type is shipped with the product. For more information, see the algorithm type description.</p> <ul data-bbox="618 1543 1122 1883" style="list-style-type: none"> • Pricing Fees Calculation Post-Processing - • Pricing Fees Calculation Pre-Processing - • Pricing Rate Post-Processing - • Pricing Rate Pre-Processing - • Sequential Bill Number Generation - Used to attach an algorithm which indicates how to sequence alternate bill numbers which are unique within the division. 	

Field Name	Field Description	Mandatory (Yes or No)
	<p data-bbox="654 212 1122 373">Note: The C1_ALTBLLDIV and C1_ALTBLDIV1 algorithm types are shipped with the product. For more information, see the algorithm type description.</p> <ul data-bbox="618 401 1122 617" style="list-style-type: none"> • SSL Accumulation Pre-Processing - Used to attach an algorithm which must be triggered for undertaking some pre-processing activities on the aggregate stop-loss accumulation records. This algorithm is invoked when you execute the C1-ACSSL batch. <p data-bbox="654 646 1122 808">Note: No algorithm types for this algorithm entity are shipped with the product. The implementation team can create custom algorithm type for this algorithm entity based on the customer requirements.</p> <ul data-bbox="618 835 1122 1083" style="list-style-type: none"> • TFM - Billable Charge Post-Processing - Used to attach an algorithm which must be triggered for undertaking some post-processing activities on the billable charges which are generated through the transaction aggregation process. This algorithm is invoked when you execute the C1-TXNSQ and C1-TXNCU batches. <p data-bbox="654 1113 1122 1245">Note: The C1_BCHG_POPC algorithm type is shipped with the product. For more information, see the algorithm type description.</p> <ul data-bbox="618 1272 1122 1455" style="list-style-type: none"> • TFM - Cancellation Pre-Processing - Used to attach an algorithm which must be triggered for undertaking some pre-processing activities while canceling the transactions. This algorithm is invoked when you execute the C1-TXCNC batch. <p data-bbox="654 1484 1122 1617">Note: The C1_CNCL_PRPC algorithm type is shipped with the product. For more information, see the algorithm type description.</p>	
	<ul data-bbox="618 1675 1122 1795" style="list-style-type: none"> • TFM - Currency Conversion - Used to attach a date or date and time based currency conversion algorithm which must be triggered while aggregating transactions. 	

Field Name	Field Description	Mandatory (Yes or No)
	<p data-bbox="654 212 1122 373">Note: The C1_CURALGTFM and C1_EXCRTTFM algorithm types are shipped with the product. For more information, see the algorithm type description.</p> <ul data-bbox="618 401 1122 583" style="list-style-type: none"> • TFM - Disaggregation Pre-Processing - Used to attach an algorithm which must be triggered for undertaking some pre-processing activities while disaggregating the transactions. This algorithm is invoked when you execute the C1-PDTXN batch. <p data-bbox="654 611 1122 747">Note: The C1_DSAG_PRPC algorithm type is shipped with the product. For more information, see the algorithm type description.</p> <ul data-bbox="618 768 1122 1035" style="list-style-type: none"> • TFM - Disaggregation Request Post-Processing • TFM - Price Item Derivation Post-Processing - Used to attach an algorithm which must be triggered for undertaking some post-processing activities on the transaction legs. This algorithm is invoked when you execute the C1-TXNIP batch. <p data-bbox="654 1062 1122 1192">Note: The C1_PRDR_POPC and C1-VALECRTRN algorithm types are shipped with the product. For more information, see the algorithm type description.</p> <ul data-bbox="618 1220 1122 1440" style="list-style-type: none"> • TFM - Rate Post-Processing - Used to attach an algorithm which must be triggered for undertaking some post-processing activities while determining rate for transaction legs. This algorithm is invoked when you execute the C1-TXNEX and C1-TXNSQ batches. <p data-bbox="654 1467 1122 1629">Note: The C1-ASOEXPOS and C1_RTCL_POPC algorithm types are shipped with the product. For more information, see the algorithm type description.</p> <ul data-bbox="618 1656 1122 1877" style="list-style-type: none"> • TFM - Rate Pre-Processing - Used to attach an algorithm which must be triggered for undertaking some pre-processing activities while determining rate for transaction legs. This algorithm is invoked when you execute the C1-TXNEX and C1-TXNSQ batches. 	

Field Name	Field Description	Mandatory (Yes or No)
	<p>Note: The C1-RETFLAT and C1_RTCL_PRPC algorithm types are shipped with the product. For more information, see the algorithm type description.</p>	
	<ul style="list-style-type: none"> <li data-bbox="618 432 1122 621">• TFM - Rollback Pre-Processing - Used to attach an algorithm which must be triggered for undertaking some pre-processing activities while rolling back the transactions. This algorithm is invoked when you execute the C1-TXNRB batch. <p>Note: The C1_ROBK_PRPC algorithm type is shipped with the product. For more information, see the algorithm type description.</p> <ul style="list-style-type: none"> <li data-bbox="618 806 1122 1020">• TFM - SSL Accumulation Post-Processing - Used to attach an algorithm which must be triggered for undertaking some post-processing activities on the specific stop-loss accumulation amount. This algorithm is invoked when you execute the C1-ACSSL batch. <p>Note: No algorithm types for this algorithm entity are shipped with the product. The implementation team can create custom algorithm type for this algorithm entity based on the customer requirements.</p> <ul style="list-style-type: none"> <li data-bbox="618 1241 1122 1486">• TFM - Verify Pricing Post-Processing - Used to attach an algorithm which must be triggered for undertaking some post-processing activities on a summary record in the CI_TXN_DTL_PRITM_SUMMARY table. This algorithm is invoked when you execute the C1-TXNVP batch. <p>Note: The C1-VRPR_POPC algorithm type is shipped with the product. For more information, see the algorithm type description.</p>	
Sequence Number	Used to specify the order in which the algorithms with the same entity should be executed.	Yes (Conditional) Note: This field is required when you are associating an algorithm with the division.
Algorithm	Used to specify the algorithm code.	Yes (Conditional)

Field Name	Field Description	Mandatory (Yes or No)
	Note: The Search (🔍) icon appears corresponding to the Algorithm field. On clicking the Search icon, the Algorithm Search window appears.	Note: This field is required when you are associating an algorithm with the division.
Description	Displays the description of the algorithm. Note: The description appears automatically when you specify the algorithm code in the Algorithm field.	Not applicable

- Enter the required details in the **Algorithms** tab.
- If you want to associate more than one algorithm with the division, click the **Add** (+) icon and then repeat step 3.

Note: However, if you want to remove an algorithm from the division, click the **Delete** (🗑️) icon corresponding to the algorithm.

- Click the **Save** button in the **Page Title** area.
The algorithm is associated with the division.

Related Topics

For more information on...	See...
How to search for a division	Searching for a Division on page 745
Algorithms tab	Division - Algorithms on page 742
Division screen	Division on page 736
How to define a division	Defining a Division on page 746

Defining a Characteristic for a Division

Prerequisites

To define a characteristic for a division, you should have:

- Characteristic types defined in the application (where the characteristic entity is set to Division)

Procedure

To define a characteristic for a division:

- Search for the division for which you want to define a characteristic.
- Click the **Characteristics** tab in the **Division** screen.

The **Characteristics** tab appears. It contains the following field:

Field Name	Field Description
Division	Indicates the division. Note: The Search (🔍) icon appears corresponding to the Division field. On clicking the Search icon, the Division Search window appears where you can search for a division.

In addition, it contains the following fields in a grid:

Field Name	Field Description	Mandatory (Yes or No)
Effective Date	Used to specify the date from when the characteristic is effective for the division.	Yes (Conditional) Note: This field is required when you are defining a characteristic for the division.
Characteristic Type	Used to indicate the characteristic type. Note: The list includes only those characteristic types where the characteristic entity is set to Division.	Yes (Conditional) Note: This field is required when you are defining a characteristic for the division.
Characteristic Value	Used to specify the value for the characteristic type. Note: The Search (🔍) icon appears corresponding to the Characteristic Value field. On clicking the Search icon, the Characteristic Value Search window appears. On specifying the value for a predefined characteristic type, the description of the characteristic value appears corresponding to the Characteristic Value field.	Yes (Conditional) Note: This field is required when you are defining a characteristic for the division.

- Enter the required details in the **Characteristics** tab.
- If you want to define more than one characteristic for the division, click the **Add** (+) icon and then repeat step 3.

Note: However, if you want to remove a characteristic from the division, click the **Delete** (🗑️) icon corresponding to the characteristic.

- Click the **Save** button in the **Page Title** area.

The characteristic is defined for the division.

Related Topics

For more information on...	See...
How to search for a division	Searching for a Division on page 745
Characteristics tab	Division - Characteristics on page 742
Division screen	Division on page 736
How to define a division	Defining a Division on page 746

Associating a Bill Message with a Division

Prerequisites

To associate a bill message with a division, you should have:

- Bill messages defined in the application

Procedure

To associate a bill message with a division:

1. Search for the division to which you want to associate a bill message.
2. Click the **Bill Messages** tab in the **Division** screen.

The **Bill Messages** tab appears. It contains the following field:

Field Name	Field Description
Division	Indicates the division. Note: The Search (🔍) icon appears corresponding to the Division field. On clicking the Search icon, the Division Search window appears where you can search for a division.

In addition, it contains the following fields in a grid:

Field Name	Field Description	Mandatory (Yes or No)
Start Date	Used to specify the date from when you want the bill message to appear on the bill for the accounts in the division.	Yes (Conditional) Note: This field is required when you are associating a bill message with the division.
End Date	Used to specify the date till when you want the bill message to appear on the bill for the accounts in the division.	No
Bill Message	Used to specify the bill message which is valid for the accounts in the division. Note: The Search (🔍) icon appears corresponding to this field. On clicking the Search icon, the Bill Message Search window appears. On specifying a bill message, the description of the bill message appears in the Description field.	Yes (Conditional) Note: This field is required when you are associating a bill message with the division.
Description	Displays the description of the bill message.	Not applicable

3. Enter the required details in the **Bill Messages** tab.
4. If you want to associate more than one bill message with the division, click the **Add** (+) icon and then repeat step 3.

Note: However, if you want to remove a bill message from the division, click the **Delete** (🗑️) icon corresponding to the bill message.

5. Click the **Save** button in the **Page Title** area.

The bill message is associated with the division.

Related Topics

For more information on...	See...
How to search for a division	Searching for a Division on page 745
Bill Messages tab	Division - Bill Messages on page 743
Division screen	Division on page 736
How to define a division	Defining a Division on page 746

Associating a Party Characteristic Type with a Division

Prerequisites

To associate a party char type with a division, you should have:

- Characteristic types defined in the application (where the characteristic entity is set to Division)

Procedure

To associate a party char type with a division:

1. Search for the division to which you want to associate a party char type.
2. Click the **Party Char Types** tab in the **Division** screen.

The **Party Char Types** tab appears. It contains the following field:

Field Name	Field Description
Division	Indicates the division. Note: The Search (🔍) icon appears corresponding to the Division field. On clicking the Search icon, the Division Search window appears where you can search for a division.

In addition, it contains the following fields in a grid:

Field Name	Field Description	Mandatory (Yes or No)
Characteristic Entity	Used to indicate whether the characteristic type is valid for a person or an account in the division.	Yes (Conditional) Note: This field is required when you are associating a party char type with the division.
Characteristic Type	Used to indicate the characteristic type. Note: The list includes only those characteristic types where the characteristic entity is set to Division.	Yes (Conditional) Note: This field is required when you are associating a party char type with the division.

3. Enter the required details in the **Party Char Types** tab.
4. If you want to associate more than one party char type with the division, click the **Add** (+) icon and then repeat step 3.

Note: However, if you want to remove a party char type from the division, click the **Delete** (🗑️) icon corresponding to the characteristic type.

- Click the **Save** button in the **Page Title** area.

The party char type is associated with the division.

Related Topics

For more information on...	See...
How to search for a division	Searching for a Division on page 745
Party Char Types tab	Division - Party Char Types on page 743
Division screen	Division on page 736
How to define a division	Defining a Division on page 746

Associating a Bill Cycle with a Division

Prerequisites

To associate a bill cycle with a division, you should have:

- Bill cycles defined in the application

Procedure

To associate a bill cycle with a division:

- Search for the division to which you want to associate a bill cycle.
- Click the **Bill Cycles** tab in the **Division** screen.

The **Bill Cycles** tab appears. It contains the following field:

Field Name	Field Description
Division	Indicates the division. Note: The Search (🔍) icon appears corresponding to the Division field. On clicking the Search icon, the Division Search window appears where you can search for a division.

In addition, it contains the following field in a grid:

Field Name	Field Description	Mandatory (Yes or No)
Bill Cycle	Used to specify the bill cycle that is valid for the accounts associated with the division.	Yes (Conditional) Note: This field is required when you are associating a bill cycle with the division.

- Select the bill cycle from the list.
- If you want to associate more than one bill cycle with the division, click the **Add** (+) icon and then repeat step 3.

Note: However, if you want to remove a bill cycle from the division, click the **Delete** (🗑️) icon corresponding to the bill cycle.

- Click the **Save** button in the **Page Title** area.

The bill cycle is associated with the division.

Related Topics

For more information on...	See...
How to search for a division	Searching for a Division on page 745
Bill Cycles tab	Division - Bill Cycles on page 743
Division screen	Division on page 736
How to define a division	Defining a Division on page 746

Associating an Account Identifier Type with a Division

Prerequisites

To associate an account identifier type with a division, you should have:

- Account identifier types defined in the application

Procedure

To associate an account identifier type with a division:

- Search for the division to which you want to associate an account identifier type.
- Click the **Account Identifier Types** tab in the **Division** screen.

The **Account Identifier Types** tab appears. It contains the following field:

Field Name	Field Description
Division	Indicates the division. Note: The Search (🔍) icon appears corresponding to the Division field. On clicking the Search icon, the Division Search window appears where you can search for a division.

In addition, it contains the following field in a grid:

Field Name	Field Description	Mandatory (Yes or No)
Account Identifier Type	Used to specify the account identifier type valid for the accounts associated with the division.	Yes (Conditional) Note: This field is required when you are associating an account identifier type with the division.

- Select the account identifier type from the list.
- If you want to associate more than one account identifier type with the division, click the **Add** (+) icon and then repeat step 3.

Note: However, if you want to remove an account identifier type from the division, click the **Delete** (🗑️) icon corresponding to the account identifier type.

- Click the **Save** button in the **Page Title** area.

The account identifier type is associated with the division.

Related Topics

For more information on...	See...
How to search for a division	Searching for a Division on page 745
Account Identifier Types tab	Division - Account Identifier Types on page 744
Division screen	Division on page 736
How to define a division	Defining a Division on page 746

Defining a Division-Specific Characteristic for a Price Item**Prerequisites**

To define a division-specific characteristics for a price item, you should have:

- Characteristic types defined in the application (where the characteristic entity is set to Division/Price Item Combination)
- Price item associated with the division to which the user belongs

Procedure

To define a division-specific characteristic for a price item:

1. Search for the division for which you want to define a price item characteristic.
2. Click the **Price Item Characteristics** tab in the **Division** screen.

The **Price Item Characteristics** tab appears. It contains the following field:

Field Name	Field Description
Division	Indicates the division. Note: The Search (🔍) icon appears corresponding to the Division field. On clicking the Search icon, the Division Search window appears where you can search for a division.

In addition, it contains the following fields in a grid:

Field Name	Field Description	Mandatory (Yes or No)
Price Item	Indicates the price item count associated with the selected division.	No
Price Item	Indicates the price item code associated with the division to which the user belongs.	Not applicable
Effective Date	Used to specify the date from when the price item characteristic is effective for the division.	Yes (Conditional) Note: This field is required when you are defining a division-specific characteristic for the price item.
Characteristic Type	Used to indicate the characteristic type.	Yes (Conditional)

Field Name	Field Description	Mandatory (Yes or No)
	Note: The list includes only those characteristic types where the characteristic entity is set to Division/Price Item Combination.	Note: This field is required when you are defining a division-specific characteristic for the price item.
Characteristic Value	Used to specify the value for the characteristic type. Note: If you select a predefined characteristic type, the Search (🔍) icon appears corresponding to the Characteristic Value field. On clicking the Search icon, the Characteristic Value Search window appears. On specifying the value for a predefined characteristic type, the description of the characteristic value appears corresponding to the Characteristic Value field.	Yes (Conditional) Note: This field is required when you are defining a division-specific characteristic for the price item.

- If the division has multiple price items associated with it, navigate to define a characteristic for the required price item.

Note: You can use the **Previous** (⬅️) and **Next** (➡️) buttons to navigate through the price items while defining their characteristics.

- Enter the required details in the **Price Item Characteristics** tab.
- If you want to define more than one division-specific characteristic for the price item, click the **Add** (+) icon and then repeat step 4.

Note: However, if you want to remove a division-specific characteristic from the price item, click the **Delete** (🗑️) icon corresponding to the characteristic.

- Click the **Save** button in the **Page Title** area.

The division-specific characteristic is defined for the price item.

Related Topics

For more information on...	See...
How to search for a division	Searching for a Division on page 745
Price Item Characteristics tab	Division - Price Item Characteristics on page 744
Division screen	Division on page 736
How to define a division	Defining a Division on page 746

Associating a To Do Type and To Do Role with a Division

Prerequisites

To associate a To Do type and To Do role with a division, you should have:

- To Do types and to do roles defined in the application
- To Do roles associated to the respective to do types

Procedure

To associate a To Do type and To Do role with a division:

1. Search for the division to which you want to associate a To Do type and To Do role.
2. Click the **Main** tab in the **Divisions** screen.
The **Main** tab appears.
3. The **To Do** section contains the following fields in a grid:

Field Name	Field Description	Mandatory (Yes or No)
To Do Type	Used to indicate the To Do type for which you want to define division-specific To Do role.	Yes (Conditional)
	Note: The Search (🔍) icon appears corresponding to the To Do Type field. On clicking the Search icon, the To Do Type Search window appears.	Note: This field is required when you are defining a To Do type for the division
To Do Role	Used to indicate the To Do role whose users must receive the To Do entries of the specified To Do type for the accounts which belong to the division.	Yes (Conditional)
	Note: The Search (🔍) icon appears corresponding to the To Do Role field. On clicking the Search icon, the Role for To Do Type window appears.	Note: This field is required when you are defining a division-specific To Do role for a To Do type

4. If you want to associate more than one To Do type and To Do role with the division, click the **Add** (+) icon and then repeat step 3.

Note: However, if you want to remove a To Do type and To Do role from the division, click the **Delete** (🗑️) icon corresponding to the To Do type.

5. Click the **Save** button in the **Page Title** area.

The To Do type and To Do role is associated with the division.

Related Topics

For more information on...	See...
How to search for a division	Searching for a Division on page 745
Main tab	Division - Main on page 738
Division screen	Division on page 736
How to define a division	Defining a Division on page 746

Chapter

6

Approval Workflow

Topics:

- [Most Commonly Used Terms](#)
- [Approval Workflow Process](#)
- [Prerequisites](#)
- [Approval Transaction](#)
- [Comparison: New versus Existing](#)
- [Approve Price Assignment](#)
- [Modify Price Assignment](#)
- [Resolve Price Assignment](#)
- [Approval Workflow Group \(Used for Searching\)](#)
- [Approval Workflow Group \(Used for Viewing\)](#)
- [Approval Workflow Chain \(Used for Searching\)](#)
- [Approval Workflow Chain \(Used for Viewing\)](#)
- [Approval Workflow Criterion Type \(Used for Searching\)](#)
- [Approval Workflow Criterion Type \(Used for Viewing\)](#)
- [Approval Workflow Group Chain Linkage \(Used for Searching\)](#)
- [Approval Workflow Group Chain Linkage \(Used for Viewing\)](#)
- [Approval Workflow Setting \(Used for Searching\)](#)
- [Approval Workflow Setting \(Used for Viewing\)](#)
- [Approval Workflow Reason \(Used for Searching\)](#)

Oracle Revenue Management and Billing may optionally be configured to use the approval workflow process whenever any addition, modification, or deletion is done manually by a user. The approval workflow process routes any changes made to the business objects (such as person, account, contract, division, and so on) to a group of people for approval. The approval workflow process allows you to manage and track all tasks involved in the approval process.

Approval workflow allows you to define the rules for requiring an approval step before the data changes are committed to the database. Once you establish the approval workflow rules, the application manages the business process flow for having data changes approved before they are reflected in the database.

The system provides you with a flexible set of options used to determine when approvals are required, and how the approval process is to be managed including:

- Turning approval on or off for individual business objects within the application
- Grouping business objects so that approval is required for the group rather than the individual business objects within the group
- Who should approve
- How many levels of approvals are required
- Different approval workflow chains based on different criteria

Once you have turned approval workflow on for an object, or a group of objects, the system will use the approval workflow configuration to manage the entire approval process including:

- Determining whether approval is required based on data changes submitted by a user
- Routing approval workflow requests to one or more qualified approvers
- Managing rejected data changes and sending these back to the submitter for resolution
- Committing the changes once all required approvals are received

- *Approval Workflow Reason
(Used for Viewing)*

Most Commonly Used Terms

Before you understand the approval workflow process, you must familiarize yourself with the following terms:

Term	Description
Submitter	A person who adds, modifies or deletes a business object, such as person, account, contract, and division is called a submitter.
Approver	A person who approves any changes made to a business object is called an approver.
Approval Workflow Group	A group of one or more business objects for which approval is required, under some or all conditions, when data changes are made.
Approval Workflow Chain	The approval workflow chain indicates how many levels of approvals are required to approve the changes made by the submitter.

Approval Workflow Process

When a submitter adds, edits or deletes a business object (for example, an account) that belongs to an approval workflow group, the system checks whether approval workflow is activated for the approval workflow group. If the approval workflow is activated for the group, the system creates an approval workflow request. Every approval workflow request is uniquely identified in the system through the Approval Transaction ID.

The system identifies the approval workflow chain that must be used for approval depending on the pre-configured conditions or criteria. Based on the number of levels defined in the approval workflow chain, the request is sent to the approver at each level in the chain or hierarchy for approval. When the approver at the first level approves the request, a notification is sent to the approver at the second level for approval. This process continues till the approval is received from all levels in the hierarchy. Once the approvers at all levels approve the request, the changes are committed to the database.

However, if an approver at any level in the hierarchy rejects the request, a notification is sent to the submitter who has made the changes. The submitter then makes the required corrections based on the approver's comments and resubmits the changes for approval. In this case, the approval process starts once again from the beginning and not from the level at which the request was rejected.

The submitter also has the facility to modify the request before the approver at the first level in the hierarchy approves or rejects the request. Once the changes are made, the submitter submits the request for approval. The submitter also has the facility to cancel the request.

The following figure indicates the flow of the approval workflow process:

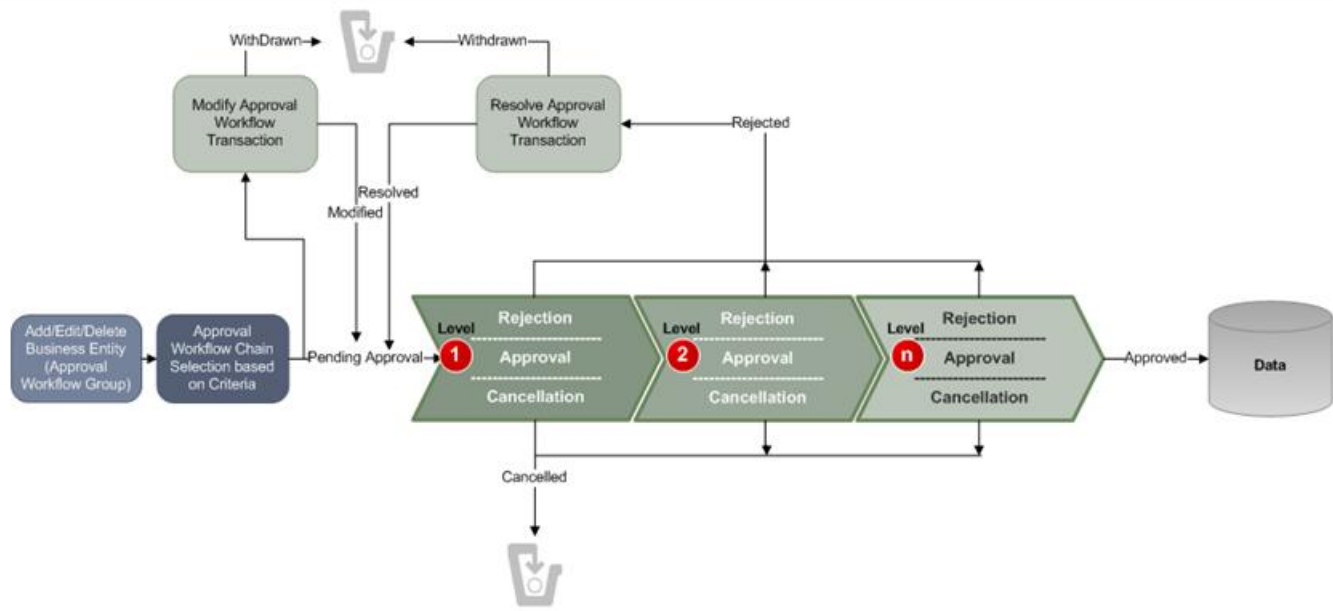

To implement the approval workflow process, you need to define the following:

- [Approval Workflow Group \(Used for Searching\)](#) on page 830
- [Approval Workflow Chain \(Used for Searching\)](#) on page 847
- [Approval Workflow Criterion Type \(Used for Searching\)](#) on page 853
- [Approval Workflow Group Chain Linkage \(Used for Searching\)](#) on page 859
- [Approval Workflow Reason \(Used for Searching\)](#) on page 876
- [Approval Workflow Setting \(Used for Searching\)](#) on page 869

For price list, price item and price assignment, the approval workflow configuration is shipped with ORMB. The following groups are available in the system:

- **C1PRODUCT** – Contains the C1_PRICEITEM_BO business object
- **C1PRICELST** – Contains the C1_F_ADDPLBO business object
- **C1PRICEASG** – Contains the C1_PRICECOMP and C1_PRICEASGN_BO business objects

After creating the approval workflow chains, you need to link these groups to the corresponding approval workflow chains. To setup the approval workflow process for price assignment, you need to do the following:

For Price Item	<ol style="list-style-type: none"> 1. If a Determine BO algorithm is not specified for the C1_PRICEITEM maintenance object, create a Determine BO algorithm using the F1-MOBO algorithm type and specify C1_PRICEITEM_BO as the business object on this algorithm. 2. Attach this algorithm on the Determine BO algorithm spot of the C1_PRICEITEM MO. 3. Link the C1PRODUCT group to the appropriate approval workflow chain. 4. Activate the approval workflow for the C1PRODUCT group by setting the Active flag corresponding to the group in the Approval Workflow Settings screen to Y.
----------------	---

For Price List	<ol style="list-style-type: none"> 1. If a Determine BO algorithm is not specified for the C1_PRICELIST maintenance object, create a Determine BO algorithm using the F1-MOBO algorithm type and specify C1_F_ADDPLBO as the business object on this algorithm. 2. Attach this algorithm on the Determine BO algorithm spot of the C1_PRICELIST MO. 3. Link the C1PRICELST group to the appropriate approval workflow chain. 4. Activate the approval workflow for the C1PRICELST group by setting the Active flag corresponding to the group in the Approval Workflow Settings screen to Y.
For Price Assignments	<ol style="list-style-type: none"> 1. If a Determine BO algorithm is not specified for the C1_PRICECOMP maintenance object, create a Determine BO algorithm using the F1-MOBO algorithm type and specify C1_PRICECOMP as the business object on this algorithm. 2. Attach this algorithm on the Determine BO algorithm spot of the C1_PRICECOMP MO. 3. If a Determine BO algorithm is not specified for the C1_PRICEASGN maintenance object, create a Determine BO algorithm using the F1-MOBO algorithm type and specify C1_PRICEASGN_BO as the business object on this algorithm. 4. Attach this algorithm on the Determine BO algorithm spot of the C1_PRICEASGN MO. 5. Link the C1PRICEASG group to the appropriate approval workflow chain. 6. Activate the approval workflow for the C1PRICEASG group by setting the Active flag corresponding to the group in the Approval Workflow Settings screen to Y.

Similarly, for invoicing group, the approval workflow configuration is shipped with ORMB. The following groups are available in the system:

- **C1IGADD**
- **C1IGUPD**

After creating the approval workflow chains, you need to link these groups to the corresponding approval workflow chains, and activate the approval workflow for these groups by setting the following in the **Approval Workflow Settings** screen:

- Set **Active** flag to **Yes**
- Set **Prevalidation** flag to **Yes**

Note: You must set the **Active** flag to **No** for both the groups in case you do not want to activate the approval workflow for invoicing group. If you set the **Active** flag to **Yes** for either of the groups, approval workflow is triggered when you add and/or edit an invoicing group.

Prerequisites

You need to setup the following prerequisites to implement the approval workflow process:

- **Setup Feature Configuration for Approval Workflow** — If you create new Maintenance Objects (MOs) and want the access control for these MOs in the approval workflow transactions to be based on the access group and division, then you have to create a custom algorithm and attach it to the **Approval Transaction Entity Access Algorithms** option type of the **C1_AXENTITY** feature configuration. Note that you will then have two access algorithms; one default algorithm (that is, **C1-APPTXN**) and another custom algorithm. For more information about the **C1_AXENTITY** feature configuration, see [Setting the C1_AXENTITY Feature Configuration](#) on page 4308.
- **Create and Attach Determine BO Algorithm** — To use approval workflow for a business object, check the corresponding maintenance object to see if a **Determine BO** algorithm is already attached to it. If not, create a **Determine BO** algorithm using the **F1-MOBO** algorithm type, and specify the appropriate business object name on the newly created algorithm. Attach this algorithm on the **Determine BO** algorithm spot of the maintenance object.
- **Attach Audit Algorithm to Business Objects** — To use the approval workflow process for a business object, you need to attach the **C1-APPTXNBAS** algorithm on the **Audit** algorithm spot of the business object. Unless you attach the audit algorithm to a business object, the approval workflow process will not be triggered for the respective business object. This step is only required when you are using the base panels. If you have created custom UI maps to enter or modify data for a specific business object, this step is not needed.
- **Attach Validation Algorithms to Business Objects** — The following algorithms are shipped with ORMB:

Business Object	Basic Validation Algorithm	Pending Transaction Validation Algorithm
C1-AppBOChain	C1-GRPCHNALG	C1-APPGRPCHL
C1-AppGrp	C1-GRPALG	C1-APPGROUPV
C1-ApprovalChainEligible	C1-ADMALG	C1-APGBYPORT
C1-ApprovalTransactionChain	C1-APCHALGO	C1-APCHNPEND

The basic validation algorithms are attached to the respective business objects, and then shipped with ORMB. However, the pending transaction validation algorithms are not attached to the respective business objects. If you want to restrict the users from either editing or deleting the approval workflow group, approval workflow settings, approval workflow chain, or approval workflow group chain linkage when the respective approval workflow requests are in the **Pending**, **Work-in-Progress**, or **Rejected** state, then you must attach the pending transaction validation algorithm on the **Validation** algorithm spot of the respective business object.

- **Set Colors for Highlighting during Comparison** — While approving, rejecting, or cancelling approval workflow requests where the submitter action is Update (UPD), you will be able to compare the existing and new data. By default, any modifications are highlighted in the Yellow (9933FF) color and new additions are highlighted in the Purple (FFFF66) color. You can easily change these default colors. For more information on how to set the colors used for highlighting, see [Setting the C1_AXENTITY Feature Configuration](#) on page 4308.
- **Create To Do Types** — You need to create the To Do types that you want to use in the approval workflow process. Once the To Do type is created, you need to link it to the required To Do roles so that users belonging to the To Do role can view and work on the To Do type.
- **Create To Do Roles** — You need to create the To Do roles that you want to use in the approval workflow process. Once the To Do role is created, you need to add the users whom you want to assign this role.

Note: User who is withdrawing the approval workflow request must be assigned to the To Do role to which the approver at the first level in the hierarchy is assigned. Otherwise, the user will not be able to withdraw the approval workflow request.

- **Create Input UI Map for an Approval Workflow Group** — The system provides you with the ability to automatically generate an Input UI map, and associate it with the approval workflow group. Alternatively, you

can create an Input UI map manually, and attach it to the approval workflow group. For more information on how to create an Input UI map manually, see [Creating Input UI Map for an Approval Workflow Group](#) on page 4305.

- **Create Display UI Map for an Approval Workflow Group** — The system provides you with the ability to automatically generate a Display UI map, and associate it with the approval workflow group. Alternatively, you can create a Display UI map manually, and attach it to the approval workflow group. For more information on how to create a Display UI map manually, see [Creating Display UI Map for an Approval Workflow Group](#) on page 4304.

Approval Transaction

If an approver at any level in the hierarchy rejects a request, a notification is sent to the submitters having the To Do role to resolve. The submitter then makes the required corrections based on the approver's comments, and resubmits the changes for approval. In this case, the approval process starts once again from the beginning, and not from the level at which the request was rejected.

The **Approval Transaction** screen allows you to resolve or withdraw a request. It consists of the following zones:

- [Search Approval Transaction](#) on page 779
- [Approval Transaction Log](#) on page 783

Search Approval Transaction

The **Search Approval Transaction** zone allows you to search for an approval transaction using various search criteria. It contains the following two sections:

- **Search Criteria** — The **Search Criteria** section contains the following fields:

Field Name	Field Description	Mandatory (Yes or No)
Search By	Used to indicate whether you want to search for an approval transaction using the task or approval transaction details. The valid values are: <ul style="list-style-type: none"> • Task Details • Approval Transaction Details 	Yes
	Note: By default, the Task Details option is selected.	
Status	Used to search approval transactions with a particular status. The valid values are: <ul style="list-style-type: none"> • Approved • Cancelled • Rejected • Inprocess • Pending • Deleted 	No
	Note: This field appears when you select the Approval Transaction Details option from the Search By list.	
Task	Used to search approval transactions with a particular task. The valid values are:	Yes (Conditional)

Field Name	Field Description	Mandatory (Yes or No)
	<ul style="list-style-type: none"> Approve Modify Resolve <p>Note: This field appears when you select the Task Details option from the Search By list.</p>	<p>Note: This field is required when you want to search approval transactions using the task details.</p>
Approval Workflow Group	Used to search approval transactions created for the business objects that belong to a particular approval workflow group.	No
Division	Used to search approval transactions which belong to a particular division.	No
	Note: You can only view those divisions to which you have access in the Division list.	
Reference ID	Used to search approval transactions created for the business object with a particular reference ID.	No
Approval Transaction ID	Used to search for a particular approval transaction.	No
Created From	Used to search approval transactions which are created from a particular date onwards.	No
Created Until	Used to search approval transactions which are created till a particular date.	No
Action	Used to search approval transactions which are created while adding, updating, or deleting a business object.	No
Submitter ID	Used to search approval transactions which are created by a particular submitter.	No
	<p>Note:</p> <p>This field appears either when you select the Task Details from the Search By list and Approve option from the Task list or when you select the Approval Transaction Details from the Search By list and Processing, Pending, or Deleted option from the Approval Transaction Status list.</p> <p>The Search (🔍) icon appears corresponding to this field. On clicking the Search icon, the Submitter Id for Status window appears.</p>	
Approver ID	Used to search approval transactions which are rejected by a particular approver.	No

Field Name	Field Description	Mandatory (Yes or No)
	<p>Note:</p> <p>The Approver ID is displayed when the approval transaction is searched by Task Details and Task is Resolve. It is also displayed when the approval transaction is searched by Approval Transaction Details and Status is Approved, Canceled, or Rejected.</p> <p>The Search (🔍) icon appears corresponding to this field. On clicking the Search icon, the Approver ID Search window appears.</p>	

Note: You must specify at least one search criterion while searching for an approval transaction. One more search criterion is required when you are searching for an approval transaction using the **Task** field.

- **Search Results** - On clicking the **Search** button, the search results appear based on the specified search criteria. The **Search Results** section contains the following columns:

Column Name	Column Description
Approval Transaction ID	<p>Displays the approval transaction ID.</p> <p>Note: It has a link. The link appears when you select Task Details option from the Search By list. If the Approve option is selected from the Task list then on clicking the link, Comparison: New versus Existing window appears with the compared details of the new and existing approval transactions. If the Modify option is selected from the Task list then on clicking the link, Modify/Resolve Price List Assignment window appears to modify or resolve the details of price list assignment. If the Resolve option is selected from the Task list then on clicking the link, Modify/Resolve Price List Assignment window appears to modify or resolve the details of price list assignment.</p>
Approval Workflow Group	Displays the code of the approval workflow group.
Submitter Name	<p>Displays the name of submitter who submits the approval transaction details list.</p> <p>Note: This column appears either when you select the Approve or Modify option from the Task list or when you select the Processing, Pending, or Deleted option from the Approval Transaction Status list.</p>
Approver Name	<p>Displays the name of an approver who approves an approval transaction details list.</p> <p>Note: This column appears either when you select the Resolve option from the Task list or when you select the Approved, Canceled, or Rejected option from the Approval Transaction Status list.</p>
Submitted On	<p>Displays the date and time on which approval transaction is submitted for approval.</p> <p>Note: This column appears either when you select the Approve or Modify option from the Task list or when you select the Approved, Pending, or Deleted option from the Approval Transaction Details list.</p>

Column Name	Column Description
Action	Indicates the various types of action. The valid values are: <ul style="list-style-type: none"> • Add • Delete (DEL) • Update (UPD)
Division	Displays the division to which the approval transaction belongs.
Status	Displays the status of approval transaction. The valid values are: <ul style="list-style-type: none"> • Approved • Cancelled • Rejected • Processing • Pending • Deleted <p>Note: This column appears either when you select Approval Transaction Details option from the Search By list of the search criteria.</p>
To Do Type	Displays the type of To Do (notification) received for the approval transaction.
Approval Transaction Information	Displays additional information about the approval transaction.
Rejected On	Displays the date and time on which the transaction is rejected. <p>Note: This column appears either when you select the Resolve option from the Task list or when you select the Rejected, option from the Approval Transaction Details list.</p>
Reject Reason	Displays the reason for which the approval transaction is rejected by the approver. <p>Note: This column appears either when you select the Resolve option from the Task list or when you select the Rejected option from the Approval Transaction Details list.</p>
Canceled On	Displays the date and time on which the approval transaction is canceled by the user. <p>Note: This column appears when you select the Cancelled option from the Approval Transaction Details list.</p>
Cancel Reason	Displays the reason for which the approval transaction is canceled by the user. <p>Note: This column appears either when you select the Canceled option from the Approval Transaction Details list.</p>
Withdraw	Displays a link to withdraw an approval transaction.

Column Name	Column Description
	Note: This column appears either when you select the Modify or Resolve option from the Task list. It has a link and on clicking the link, a message appears to confirm the withdrawal of the respective approval transaction.

On clicking the **Broadcast** (📢) icon corresponding to the approval transaction the **Approval Transaction Log** zone appears with the approval transaction log details.

Related Topics

For more information on...	See...
Approval Transaction Log zone	Approval Transaction Log on page 783
How to search for an approval transaction	Searching for an Approval Transaction on page 784
How to view the log of an approval transaction	Viewing the Log of an Approval Transaction on page 784

Approval Transaction Log

The **Approval Transaction Log** zone displays the complete trail of submitter and approver actions performed on the approval transaction. It contains the following columns:

Column Name	Column Description
Date Time	Displays the date and time when the action was performed on the approval transaction.
User Name	Indicates the user who has performed the action on the approval transaction.
Status	Displays the status of the approval transaction. The valid values are: <ul style="list-style-type: none"> • Approved • Cancelled • Rejected • InProcess • Pending • Deleted
View	It has a link. On clicking the View link, the Comparison: New versus Existing window appears where you can view the existing and new compared transactions".
Status Reason	Displays the status reason of the approval transaction.
Comments	Displays additional information about the approval transaction.

By default, the **Banking Approval Transaction Log** zone does not appear. It appears when you click the **Broadcast** (📢) icon corresponding to the approval transaction in the **Approval Transaction** zone.

You can change the layout of this zone. For more information on how to change the layout, see [Changing the Layout](#) on page 4300.

Related Topics

For more information on...	See...
How to view the log of an approval transaction	Viewing the Log of an Approval Transaction on page 784

Searching for an Approval Transaction

Procedure

To search for an approval transaction:

1. Click the **Menu** link in the **Application** toolbar.
A list appears.
2. From the **Main** menu, select **Approval Workflow** and then click **Approval Transaction**.
The **Approval Transaction** screen appears.
3. Click the **Search** option from the **Approval Transaction** sub-menu.
The **Approval Transaction** screen appears.
4. Enter the search criteria in the **Search Approval Transaction** zone depending on whether you want to search for a task or approval transaction details.

Note: ORMB search engine supports wildcard search, where you can substitute the percentage (%) symbol as a stand in for any word or letter in a search criteria. You can use the ‘%’ wildcard character in all input fields except the date and ID fields. The ‘%’ wildcard character is suffixed automatically at the end of the partial search criteria. Therefore, you may or may not specify the wildcard character at the end of the partial search criteria. However, you have to prefix the wildcard character manually wherever required.

5. Click **Search**.
A list of task or approval transactions that meet the search criteria appears in the **Search Results** section.

Related Topics

For more information on...	See...
Approval Transaction screen	Approval Transaction on page 779
Search Approval Transaction zone	Search Approval Transaction on page 779

Viewing the Log of an Approval Transaction

Procedure

To view the log of an approval transaction:

1. Search for the task or approval transaction details in the **Approval Transaction** screen.
2. In the Search Results section, click the **Broadcast** () icon corresponding to the approval transaction whose log details you want to view.
The **Approval Transaction Log** zone appears.
3. View the log details of the approval transactions in the **Approval Transaction Log** zone.

Related Topics

For more information on...	See...
Search Approval Transaction zone	Search Approval Transaction on page 779
Approval Transaction Log zone	Approval Transaction Log on page 783

Comparison: New versus Existing

You have to define the reason codes which are used when the approval workflow request is either rejected or cancelled. The reason code helps to indicate the reason why a particular request was rejected or cancelled.

The **Comparison: New versus Existing** screen allows you to view the changes in the new approval transaction compared to the existing one. It contains the following sections:

- New
- Existing

Through this screen you can do the following:

- Approve an approval transaction
- Reject an Approval Transaction
- Cancel an approval transaction
- Modify an approval transaction
- Withdraw an Approval Transaction
- Resolve an approval transaction

Approving an Approval Transaction

You can view the number of approval transactions which are pending for approval in the **Approval Transaction** screen. The approver can review, and accordingly approve, return to the submitter, revert to the original, or cancel the approval transaction based on the observations.

Note: The system will not allow you to approve, return to the submitter, revert to the original or cancel an approval transaction submitted by you.

Procedure

To approve an approval transaction:

1. Search for approval transactions with task details and status as Approve in the **Approval Transaction** screen.
2. In the **Search Results** section, click the link in the **Approval Transaction ID** column corresponding to the approval transaction which you want to review.

The **Comparison: New versus Existing** screen appears.

3. Review the compared existing and new approval transactions.
4. Click **Approve**.

A message appears with confirmation on transaction approved successfully.

Note: ORMB search engine supports wildcard search, where you can substitute the percentage (%) symbol as a stand in for any word or letter in a search criteria. You can use the ‘%’ wildcard character in all input fields except the date and ID fields. The ‘%’ wildcard character is suffixed automatically at the end of the partial search criteria. Therefore, you may or may not specify the wildcard character at the end of the partial search criteria. However, you have to prefix the wildcard character manually wherever required.

5. Click **OK**.

The approval transaction is removed from the search results.

Note:

By default, any modifications will be highlighted in the Yellow (9933FF) color and new additions will be highlighted in the Purple (FFFF66) color. You can easily change these default colors. For more information on how to set the colors used for highlighting, see [Setting the CI_AXENTITY Feature Configuration](#) on page 4308.

- Review the changes and click **Approve** to accept the changes.

The changes in the approval transaction are approved.

Related Topics

For more information on...	See...
Search Approval Transaction zone	Search Approval Transaction on page 779
Comparison: New versus Existing screen	Comparison: New versus Existing on page 785
How to search for an approval transaction	Searching for an Approval Transaction on page 784

Rejecting an Approval Transaction**Prerequisites**

To return an approval transaction to its submitter, you should have:

- Rejection reasons defined in the application

Note:

While returning an approval transaction, you need to specify the reason why you want to return the approval transaction. You can select the appropriate rejection reason when you have defined the reasons for the **Rejected** status of the business object in the **Status Reason** screen.

The system will not allow you to approve, return or revert an approval transaction submitted by you.

Procedure

To reject an approval transaction:

- Click the **Menu** link in the **Application** toolbar.
A list appears.
- In the **Search Results** section, click the link in the **Approval Transaction ID** column corresponding to the approval transaction which you want to review.
The **Comparison: New versus Existing** screen appears.
- Review the compared existing and new approval transactions.
- Click Return to Submitter.” With stepresult, “The Rejection/Cancelation Reason window appears. It contains the following fields:

Field Name	Field Description	Mandatory (Yes or No)
Approval Workflow Reason	Used to search a particular approval workflow reason.	Yes
Comments	Used to specify additional information while rejecting the usage record.	Yes

- Enter the required details.
- Click **OK**.

The approval transaction is removed from the search results.

Related Topics

For more information on...	See...
Search Approval Transaction zone	Search Approval Transaction on page 779
Comparison: New versus Existing screen	Comparison: New versus Existing on page 785
How to approve an approval transaction	Approving an Approval Transaction on page 785
How to search for an approval transaction	Searching for an Approval Transaction on page 784

Canceling an Approval Transaction

Prerequisites

To revert an approval transaction to its initial status, you should have:

- Cancellation reasons defined in the application

Note:

While reverting an approval transaction, you need to specify the reason why you want to revert the approval transaction. You can select the appropriate cancellation reason when you have defined the reasons for the **Canceled** status of the business object in the **Status Reason** screen.

The system will not allow you to approve, return or revert an approval transaction submitted by you.

Procedure

To cancel an approval transaction:

1. Search for approval transactions with task details and status as Approve in the **Approval Transaction** screen.
2. In the **Search Results** section, click the link in the **Approval Transaction ID** column corresponding to the approval transaction which you want to review.

The **Comparison: New versus Existing** screen appears.

3. Review the compared existing and new approval transactions.
4. Click **Revert to Original**.

The **Rejection/Cancellation Reason** window appears. It contains the following fields:

Field Name	Field Description	Mandatory (Yes or No)
Approval Workflow Reason	Used to search a particular approval workflow reason.	Yes
Comments	Used to specify additional information while rejecting the usage record.	Yes

5. Enter the required details.

A **Comparison: New versus Existing** screen appears where you can view the changes in the new transaction as compared to the existing ones.

Note:

By default, any modifications will be highlighted in the Yellow (9933FF) color and new additions will be highlighted in the Purple (FFFF66) color. You can easily change these default colors. For more information on how to set the colors used for highlighting, see [Setting the CI_AXENTITY Feature Configuration](#) on page 4308.

6. Click OK.

The approval transaction is removed from the search results.

Related Topics

For more information on...	See...
Search Approval Transaction zone	Search Approval Transaction on page 779
Comparison: New versus Existing screen	Comparison: New versus Existing on page 785
How to approve an approval transaction	Approving an Approval Transaction on page 785
How to search for an approval transaction	Searching for an Approval Transaction on page 784

Modifying an Approval Transaction**Prerequisites**

To modify an approval transaction, you should have:

- Characteristic Types defined in the application.

Procedure

To Modify an approval transaction:

1. Search for approval transactions with task details and status as Modify in the **Approval Transaction** screen.

Note: ORMB search engine supports wildcard search, where you can substitute the percentage (%) symbol as a stand in for any word or letter in a search criteria. You can use the '%' wildcard character in all input fields except the date and ID fields. The '%' wildcard character is suffixed automatically at the end of the partial search criteria. Therefore, you may or may not specify the wildcard character at the end of the partial search criteria. However, you have to prefix the wildcard character manually wherever required.

2. From the **Main** menu, select **Approval Workflow** and then click **Approval Transaction**.

A screen appears where you can review the changes, and accordingly modify or resolve the request based on your observations. In case where the submitter action is **Update (UPD)**, you will be able to compare the existing and new data, and accordingly take an action.

3. Modify the required details.
4. Click **Save**.

The modifications made to the approval transaction are saved.

Related Topics

For more information on...	See...
Approval Transaction screen	Approval Transaction on page 779
Search Approval Transaction zone	Search Approval Transaction on page 779
How to search for an approval transaction	Searching for an Approval Transaction on page 784

Withdrawing an Approval Transaction

Procedure

To withdraw an approval transaction:

1. Click the **Menu** link in the **Application** toolbar.

A list appears.

2. In the **Search Results** section, click the link in the **Withdraw** column corresponding to the approval transaction which you want to withdraw.

A message appears confirming whether you want to withdraw the approval transaction.

3. Click **OK**.

A message appears confirming whether you want to delete the approval transaction.

4. Click **OK**.

The approval transaction is deleted.

Related Topics

For more information on...	See...
Approval Transaction screen	Approval Transaction on page 779
Search Approval Transaction zone	Search Approval Transaction on page 779
How to search for an approval transaction	Searching for an Approval Transaction on page 784

Resolving an Approval Transaction

Prerequisites

To resolve an approval transaction, you should have:

- Characteristic Types defined in the application.

Procedure

To resolve an approval transaction:

1. Search for approval transactions with task details and status as Resolve in the **Approval Transaction** screen.

A list appears.

2. In the **Search Results** section, click the link in the **Approval Transaction ID** column corresponding to the approval transaction which you want to resolve.

A screen appears where you can review the changes, and accordingly modify or resolve the request based on your observations. In case where the submitter action is Update (UPD), you will be able to compare the existing and new data, and accordingly take an action.

3. Make the required changes.

4. Click **Save**.

The changes resolve for the approval transaction are saved.

Related Topics

For more information on...	See...
Approval Transaction screen	Approval Transaction on page 779

For more information on...	See...
Search Approval Transaction zone	Search Approval Transaction on page 779
How to search for an approval transaction	Searching for an Approval Transaction on page 784

Approve Price Assignment

The **Approve Price Assignment** screen allows you to search for the price assignment requests that are pending in your workflow for approval. You can review the changes, and accordingly approve, reject or cancel the request based on your observations. It contains the following zones:

- [Search](#) on page 790
- [List of Price Assignments](#) on page 793
- [Approve Price Assignment - Comparison: New versus Existing](#) on page 794
- [Approval Transaction Log](#) on page 783

Search

The **Search** zone allows you to search for the price assignment requests that are pending in your workflow for approval. It contains the following two sections:

- **Search Criteria** – The **Search Criteria** section contains the following fields:

Field Name	Field Description	Mandatory (Yes or No)
Search By	Used to indicate whether you want to search for price assignments using the account, person, price list, submitter ID or transaction ID. The valid values are: <ul style="list-style-type: none"> • Person • Account • Price List • Submitter ID • Approval Transaction ID <p>Note: By default, the Person option is selected.</p>	Yes
Division	Used to search price assignments which are associated with a particular division. <p>Note: You can only view those divisions to which you have access in the Division list. This field appears when you select the Person or Account option from the Search By list.</p>	No
Person Identifier Type	Used to specify the value for the person identifier type.	Yes (Conditional)

Field Name	Field Description	Mandatory (Yes or No)
		Note: If you enter the person identifier as a search criteria, you have to select the person identifier type.
Person Identifier	Used to specify the ID linked to the person.	Yes (Conditional)
	Note: This field appears when you select the Person option from the Search By list.	Note: If you specify the person identifier type as a search criteria, you have to enter the person identifier.
Account ID	Used to search price assignments which are created for a particular account.	No
	Note: This field appears when you select the Account option from the Search By list.	
Account Identifier Type	Used to select the identifier type based on which you want to search price assignments of an account.	Yes (Conditional)
	Note: This field appears when you select the Account option from the Search By list.	Note: If you enter the account identifier as a search criteria, you have to select the account identifier type.
Account Identifier	Used to specify the account whose price assignments you want to view.	Yes (Conditional)
	Note: This field appears when you select the Account option from the Search By list.	Note: If you specify the account identifier type as a search criteria, you have to enter the account identifier.
Price List Description	Used to search price lists with a particular description.	No
	Note: This field appears when you select the Price List option from the Search By list.	
Submitter ID	Used to search for price assignment requests that are created by a particular submitter.	No
	Note: This field appears when you select the Submitter ID option from the Search By list.	
Approval Transaction ID	This field appears when you select the Approval Transaction ID option from the Search By list.	No

Field Name	Field Description	Mandatory (Yes or No)
	<p>Note:</p> <p>The approval transaction ID is generated automatically when the price assignment request is created.</p> <p>This field appears when you select the Transaction ID option from the Search By list.</p>	

Note: You must specify at least one search criterion while searching for a price assignment.

- **Search Results** – On clicking the **Search** button, the search results appear based on the specified search criteria. It contains the following columns:

Column Name	Column Description
Account ID	<p>Displays the account ID.</p> <p>Note: This column appears only when you select the Account option from the Search By list.</p>
Account Identifier Type	<p>Indicates the account identifier type of the account for the price assignments.</p> <p>Note: This column appears when you select the Account option from the Search By list.</p>
Account Identifier	<p>Displays the value of the account identifier type.</p> <p>Note: This column appears when you select the Account option from the Search By list.</p>
Price List ID	<p>Note: This column appears when you select the Price List option from the Search By list.</p>
Price List Description	<p>Displays the description for the price list.</p> <p>Note: This column appears when you select the Price List option from the Search By list.</p>
Person Identifier	<p>Note: This column appears when you select the Person option from the Search By list.</p>
Person Name	<p>Displays the name of the person.</p> <p>Note: This column appears when you select the Person option from the Search By list.</p>
Division	<p>Displays the division to which the account, person, or price list belongs.</p>
Submitter ID	<p>Displays the ID of the submitter.</p>

Column Name	Column Description
	Note: This column appears when you select the Submitter ID option from the Search By list.
Approval Transaction ID	Displays the approval transaction ID.
	Note: This column appears when you select the Approval Transaction ID option from the Search By list.

On clicking the **Broadcast** (📡) icon corresponding to the account, person, price list, or submitter ID the **List of Price Assignments** zone appears with the list of price assignments.

Related Topics

For more information on...	See...
List of Price Assignments zone	List of Price Assignments on page 812
How to approve a price assignment for an account	Approving a Price Assignment for an Account on page 796
How to approve a price assignment for a person	Approving a Price Assignment for a Person on page 798
How to approve a price assignment for a price list	Approving a Price Assignment for a Price List on page 799
How to reject a price assignment for an account	Rejecting a Price Assignment for an Account on page 800
How to reject a price assignment for a person	Rejecting a Price Assignment for a Person on page 801
How to reject a price assignment for a price list	Rejecting a Price Assignment for a Price List on page 803
How to cancel a price assignment for an account	Canceling a Price Assignment for an Account on page 804
How to cancel a price assignment for a person	Canceling a Price Assignment for a Person on page 805
How to cancel a price assignment for a price list	Canceling a Price Assignment for a Price List on page 807

List of Price Assignments

The **List of Price Assignments** zone lists price assignment requests specific to an account, a person, or a price list. It contains the following columns:

Column Name	Column Description
Approval Transaction ID	Displays the approval transaction id.
	Note: The approval transaction id is generated automatically when the price assignment request is created.
Submitter Name	Displays the name of the submitter.
Action	Indicates the type of action, such as Add , Update (UPD) , or Delete (DEL) performed by the submitter during price assignment.
Submitted On	Indicates the submitter who has created the price assignment request.
To Do Type	Displays the type of To Do (notification) received for the price assignment request.

Column Name	Column Description
Price Item	Displays the price item or price item code.
Description	Displays the description of the price item or price item code.
Pricing Currency	Indicates the currency in which the price item pricing is defined.
Start Date	Displays the date from when the price item pricing is effective.
End Date	Displays the date till when the price item pricing is effective.
Approval Transaction Information	Displays the additional information of an approval transaction.

Note:

By default, the **List of Price Assignments** zone does not appear in the **Approve Price Assignment** screen. It appears when you click the **Broadcast** () icon corresponding to the account, person, or price list in the **Search** zone.

Related Topics

For more information on...	See...
Search Approve Price Assignment zone	Search on page 790
Comparison: New versus Existing zone	Approve Price Assignment - Comparison: New versus Existing on page 794
How to approve a price assignment for an account	Approving a Price Assignment for an Account on page 796
How to approve a price assignment for a person	Approving a Price Assignment for a Person on page 798
How to approve a price assignment for a price list	Approving a Price Assignment for a Price List on page 799
How to reject a price assignment for an account	Rejecting a Price Assignment for an Account on page 800
How to reject a price assignment for a person	Rejecting a Price Assignment for a Person on page 801
How to reject a price assignment for a price list	Rejecting a Price Assignment for a Price List on page 803
How to cancel a price assignment for an account	Canceling a Price Assignment for an Account on page 804
How to cancel a price assignment for a person	Canceling a Price Assignment for a Person on page 805
How to cancel a price assignment for a price list	Canceling a Price Assignment for a Price List on page 807

Approve Price Assignment - Comparison: New versus Existing

The **Comparison: New versus Existing** zone lists the existing and the new price assignments defined in the system. You can approve, cancel, reject a price assignment through this zone. It contains the following fields:

Field Name	Field Description
Approval Transaction ID	Displays the approval transaction id.
Submitter ID	Displays the submitter id who has created the price assignment request.

Field Name	Field Description
Approval Transaction Information	Displays information about the approval transaction
Action	Indicates the action that can be performed on the price assignment. The valid values are: <ul style="list-style-type: none"> • Add – Allows you to define the tiering setup of the price assignment • DEL – Allows you to delete the tiering setup of the price assignment. • UPD – Allows you to upload the tiering setup of the price assignment.

In addition to the above fields, this zone also contains the following two sections:

- **New** – It consists of the new approved price assignments.
- **Existing** – It consists of the existing or old price assignments.

In addition, this zone also contains the following buttons:

Button Name	Button Description
Approve	Used to approve the price assignment.
Return to Submitter	Used to reject the price assignment.
Revert to Original	Used to cancel the price assignment.

Note:

By default, the **Comparison: New versus Existing** zone does not appear in the **Approve Price Assignment** screen. It appears when you click the **Broadcast** () icon corresponding to the approval transaction ID in the **List Of Price Assignments** zone.

The changes made are highlighted in both the sections for the respective fields. The fields change according to the price assignments.

You can click on **Approve** button, **Return to Submitter** button, or **Revert to Original** button to **Approve**, **Reject** or **Cancel** the price assignments, respectively.

Related Topics

For more information on...	See...
Search Approve Price Assignment zone	Search on page 790
List of Price Assignments zone	List of Price Assignments on page 812
How to approve a price assignment for an account	Approving a Price Assignment for an Account on page 796
How to approve a price assignment for a person	Approving a Price Assignment for a Person on page 798
How to approve a price assignment for a price list	Approving a Price Assignment for a Price List on page 799
How to reject a price assignment for an account	Rejecting a Price Assignment for an Account on page 800
How to reject a price assignment for a person	Rejecting a Price Assignment for a Person on page 801

For more information on...	See...
How to reject a price assignment for a price list	Rejecting a Price Assignment for a Price List on page 803
How to cancel a price assignment for an account	Canceling a Price Assignment for an Account on page 804
How to cancel a price assignment for a person	Canceling a Price Assignment for a Person on page 805
How to cancel a price assignment for a price list	Canceling a Price Assignment for a Price List on page 807

Approval Transaction Log

The **Approval Transaction Log** zone displays the complete trail of submitter and approver actions performed on the approval transaction. It contains the following columns:

Column Name	Column Description
Date Time	Displays the date and time when the action was performed on the approval transaction.
User Name	Indicates the user who has performed the action on the approval transaction.
Status	Indicates the status of the approval transaction. The valid values are: <ul style="list-style-type: none"> • Approved • Cancelled • Rejected • Inprocess • Pending • Initial • Deleted
Status Reason	Indicates the reason why the approval transaction was rejected or cancelled.
Comments	Displays the additional details entered by the approver on rejecting or cancelling the approval transaction.

Note:

By default, the **Approval Transaction Log** zone does not appear in the **Approve Price Assignment** screen. It appears when you click the **Broadcast** () icon corresponding to the approval transaction ID in the **List Of Price Assignments** zone.

You can change the layout of this zone. For more information on how to change the layout, see [Changing the Layout](#) on page 4300.

Related Topics

For more information on...	See...
List Of Price Assignments zone	List of Price Assignments on page 812

Approving a Price Assignment for an Account

You can view the number of price assignments which are pending for approval in the **Approve Price Assignment** screen. The approver can review, and accordingly approve, reject or cancel the price assignment based on the observations.

Note: The system will not allow you to approve, reject or cancel a price assignment submitted by you.

Procedure

To approve a price assignment for an account:

1. Click the **Menu** link in the **Application** toolbar.

A list appears.

2. From the **Main** menu, select **Approval Workflow** and then click **Approve Price Assignment**.

The **Approve Price Assignment** screen appears.

3. Enter the search criteria in the **Search** zone.

Note: ORMB search engine supports wildcard search, where you can substitute the percentage (%) symbol as a stand in for any word or letter in a search criteria. You can use the '%' wildcard character in all input fields except the date and ID fields. The '%' wildcard character is suffixed automatically at the end of the partial search criteria. Therefore, you may or may not specify the wildcard character at the end of the partial search criteria. However, you have to prefix the wildcard character manually wherever required.

4. Click **Search**.

A list of accounts that meet the search criteria appears in the **Search Results** section.

5. Click the **Broadcast** () icon corresponding to the account whose price assignments you want to review for approval.

The **List of Price Assignments** zone appears.

6. In the **List of Price Assignments** zone, click the

Broadcast () icon corresponding to the price assignment whose details you want to review and approve.

The **Comparison: New Versus Existing** zone appears.

Note:

By default, any modifications will be highlighted in the Yellow (9933FF) color and new additions will be highlighted in the Purple (FFFF66) color. You can easily change these default colors. For more information on how to set the colors used for highlighting, see [Setting the CI_AXENTITY Feature Configuration](#) on page 4308.

Only those users who have access to the application services for each business object within the approval workflow group will be able to view the details of the price assignment request.

7. Review the compared existing and new approval transactions.

A message appears indicating that the price assignment request is sent to the approver at the next level in the hierarchy for approval. However, if you are the last approver in the hierarchy, a message appears indicating that the price assignment request is approved successfully.

8. Click **Approve**.

A message appears with confirmation on transaction approved successfully.

Tip: Alternatively, in the **List of Price Assignments** zone, you can select the check box corresponding to the price assignment request that you want to approve and then click **Approve**.

9. Click **OK**.

The approval transaction is removed from the **List of Price Assignments** zone.

Related Topics

For more information on...	See...
Approve Price Assignment screen	Approve Price Assignment on page 790
Search zone	Search on page 790
List of Price Assignments zone	List of Price Assignments on page 793
Comparison: New versus Existing zone	Comparison: New versus Existing on page 785

Approving a Price Assignment for a Person**Procedure**

To approve a price assignment for a person:

1. Click the **Menu** link in the **Actions/Navigation** area.
A list appears.
2. From the **Main** menu, select **Approval Workflow** and then click **Approve Price Assignment**.
The **Approve Price Assignment** screen appears.
3. In the **Search** zone, enter the search criteria by selecting **Person** in the **Search By** field.

Note:

ORMB search engine supports wildcard search, where you can substitute the percentage (%) symbol as a stand in for any word or letter in a search criteria. You can use the ‘%’ wildcard character in all input fields except the date and ID fields. The ‘%’ wildcard character is suffixed automatically at the end of the partial search criteria. Therefore, you may or may not specify the wildcard character at the end of the partial search criteria. However, you have to prefix the wildcard character manually wherever required.

The **Search Results** appear when **Person Identifier Type** and **Person Identifier** fields are entered.

4. Click **Search**.
A list of persons that meet the search criteria appears in the **Search Results** section.
5. Click the **Broadcast** (📡) icon corresponding to the person whose price assignments you want to review for approval.
The **List of Price Assignments** zone appears.
6. Click the **Broadcast** (📡) icon corresponding to the **Transaction Id** in the **List of Price Assignments** zone, whose details you want to view and approve.
The **Comparison: New Versus Existing** zone appears.

Note:

By default, any modifications will be highlighted in the Yellow (9933FF) color and new additions will be highlighted in the Purple (FFFF66) color. You can easily change these default colors. For more information on how to set the colors used for highlighting, see [Setting the CI_AXENTITY Feature Configuration](#) on page 4308.

Only those users who have access to the application services for each business object within the approval workflow group will be able to view the details of the price assignment request.

7. Review the pricing details, tiering ranges, and price assignment characteristics, and if they are accurate, then click **Approve**.

A message appears indicating that the price assignment request is sent to the approver at the next level in the hierarchy for approval. However, if you are the last approver in the hierarchy, a message appears indicating that the price assignment request is approved successfully.

8. Click **OK**.

A To Do (notification) is sent to the approver at the next level in the hierarchy. You will no longer be able to view this request in your workflow for approval. In case you are the last approver in the hierarchy, the changes are committed to the database.

Tip: Alternatively, in the **List of Price Assignments** zone, you can select the check box corresponding to the price assignment request that you want to approve, and then click **Approve**.

Related Topics

For more information on...	See...
Approve Price Assignment screen	Approve Price Assignment on page 790
Search zone	Search on page 790
List of Price Assignments zone	List of Price Assignments on page 793

Approving a Price Assignment for a Price List

Procedure

To approve a price assignment for a price list:

1. Click the **Menu** link in the **Application** toolbar.
A list appears.
2. From the **Main** menu, select **Approval Workflow** and then click **Approve Price Assignment**.
The **Approve Price Assignment** screen appears.
3. In the **Search** zone, enter the search criteria by selecting either **Price List** in the **Search By** field.

Note: ORMB search engine supports wildcard search, where you can substitute the percentage (%) symbol as a stand in for any word or letter in a search criteria. You can use the ‘%’ wildcard character in all input fields except the date and ID fields. The ‘%’ wildcard character is suffixed automatically at the end of the partial search criteria. Therefore, you may or may not specify the wildcard character at the end of the partial search criteria. However, you have to prefix the wildcard character manually wherever required.

4. Click **Search**.
A list of price lists that meet the search criteria appears in the **Search Results** section.
5. Click the **Broadcast** (📡) icon corresponding to the price list whose price assignments you want to review for approval.
The **List of Price Assignments** zone appears.
6. Click the **Broadcast** (📡) icon corresponding to the **Transaction Id** in the **List of Price Assignments** zone, whose details you want to view and approve.
The **Comparison: New Versus Existing** zone appears.
7. Review the pricing details, tiering ranges, and price assignment characteristics, and if they are accurate, then click **Approve**.

A message appears indicating that the price assignment request is sent to the approver at the next level in the hierarchy for approval. However, if you are the last approver in the hierarchy, a message appears indicating that the price assignment request is approved successfully.

8. Click **OK**.

A To Do (notification) is sent to the approver at the next level in the hierarchy. You will no longer be able to view this request in your workflow for approval. In case you are the last approver in the hierarchy, the changes are committed to the database.

Tip: Alternatively, in the **List of Price Assignments** zone, you can select the check box corresponding to the price assignment request that you want to approve, and then click **Approve**.

Related Topics

For more information on...	See...
Approve Price Assignment screen	Approve Price Assignment on page 790
Search zone	Search on page 790
List of Price Assignments zone	List of Price Assignments on page 793

Rejecting a Price Assignment for an Account

Procedure

To reject a price assignment for an account:

1. Click the **Menu** link in the **Application** toolbar.

A list appears.

2. From the **Main** menu, select **Approval Workflow** and then click **Approve Price Assignment**.

The **Approve Price Assignment** screen appears.

3. In the **Search** zone, enter the search criteria by selecting either **Account** in the **Search By** field.

Note: ORMB search engine supports wildcard search, where you can substitute the percentage (%) symbol as a stand in for any word or letter in a search criteria. You can use the '%' wildcard character in all input fields except the date and ID fields. The '%' wildcard character is suffixed automatically at the end of the partial search criteria. Therefore, you may or may not specify the wildcard character at the end of the partial search criteria. However, you have to prefix the wildcard character manually wherever required.

4. Click **Search**.

A list of accounts that meet the search criteria appears in the **Search Results** section.

5. Click the **Broadcast** (📡) icon corresponding to the account whose price assignments you want to review for approval.

The **List of Price Assignments** zone appears.

6. Click the **Broadcast** (📡) icon corresponding to the **Transaction Id** in the **List of Price Assignments** zone, whose details you want to view and approve.

The **Comparison: New Versus Existing** zone appears.

Note:

By default, any modifications will be highlighted in the Yellow (9933FF) color and new additions will be highlighted in the Purple (FFFF66) color. You can easily change these default colors. For more information on how to set the colors used for highlighting, see [Setting the CI_AXENTITY Feature Configuration](#) on page 4308.

Only those users who have access to the application services for each business object within the approval workflow group will be able to view the details of the price assignment request.

- Review the pricing details, tiering ranges, and price assignment characteristics, and if they are not appropriate, then click **Return to Submitter**.

The **Rejection/Cancellation Reason** screen appears.

Tip: Alternatively, in the **List of Price Assignments** zone, you can select the check box corresponding to the price assignment request that you want to reject, and then click **Return to Submitter**.

- Select the reason for rejecting the price assignment request and enter the comments in the respective field.
- Click **OK**.

The **Approve** and **Revert to Original** buttons are disabled. You will no longer be able to view this request in your workflow for approval.

Related Topics

For more information on...	See...
Approve Price Assignment screen	Approve Price Assignment on page 790
Search zone	Search on page 790
List of Price Assignments zone	List of Price Assignments on page 793

Rejecting a Price Assignment for a Person

You can view the number of price assignments which are pending for approval in the **Approve Price Assignment** screen. You can review, and accordingly approve, reject or cancel the price assignment based on the observations.

Note: The system will not allow you to approve, reject or cancel a price assignment submitted by you.

Procedure

To reject a price assignment for a person:

- Click the **Menu** link in the **Application** toolbar.
A list appears.
- From the **Main** menu, select **Approval Workflow** and then click **Approve Price Assignment**.
The **Approve Price Assignment** screen appears.
- Enter the search criteria in the **Search** zone.

Note: ORMB search engine supports wildcard search, where you can substitute the percentage (%) symbol as a stand in for any word or letter in a search criteria. You can use the ‘%’ wildcard character in all input fields except the date and ID fields. The ‘%’ wildcard character is suffixed automatically at the end of the partial search criteria. Therefore, you may or may not specify the wildcard character at the end of the partial search criteria. However, you have to prefix the wildcard character manually wherever required.

- Click **Search**.

A list of persons that meet the search criteria appears in the **Search Results** section.

5. Click the **Broadcast** (📡) icon corresponding to the person whose price assignments you want to review.
The **List of Price Assignments** zone appears.
6. In the **List of Price Assignments** zone, click the **Broadcast** (📡) icon corresponding to the price assignment whose details you want to review.
The **Comparison: New Versus Existing** zone appears.

Note:

By default, any modifications will be highlighted in the Yellow (9933FF) color and new additions will be highlighted in the Purple (FFFF66) color. You can easily change these default colors. For more information on how to set the colors used for highlighting, see [Setting the CI_AXENTITY Feature Configuration](#) on page 4308.

Only those users who have access to the application services for each business object within the approval workflow group will be able to view the details of the price assignment request.

7. Review the compared existing and new approval transactions.

The **Rejection/Cancellation Reason** screen appears. It contains following fields:

Field Name	Field Description	Mandatory (Yes or No)
Reason Code	Used to specify the reason why the approval workflow request is rejected.	Yes
Rejection/Cancellation Comment	Used to specify additional information while rejecting/cancelling the approval workflow request.	Yes

Tip: Alternatively, in the **List of Price Assignments** zone, you can select the check box corresponding to the price assignment request that you want to reject, and then click **Return to Submitter**.

8. Click **Return to Submitter**.

The **Rejection/Cancellation Reason** screen appears. It contains the following fields:

Field Name	Field Description	Mandatory (Yes or No)
Approval Workflow Reason	Used to search a particular approval workflow reason.	Yes
Comments	Used to add additional comments.	No

9. Enter the required details.

10. Click **OK**.

The approval transaction is removed from the **List of Price Assignments** zone.

Note: Alternatively, you can cancel the price assignment by selecting the check box corresponding to the price assignment which you want to cancel and then click the **Revert to Original** button in the **List of Price Assignments** zone.

Related Topics

For more information on...	See...
Approve Price Assignment screen	Approve Price Assignment on page 790
Search zone	Search on page 790
List of Price Assignments zone	List of Price Assignments on page 793

For more information on...	See...
Comparison: New versus Existing zone	<i>Comparison: New versus Existing</i> on page 785

Rejecting a Price Assignment for a Price List

You can view the number of price assignments which are pending for approval in the **Approve Price Assignment** screen. You can review, and accordingly approve, reject or cancel the price assignment based on the observations.

Note: The system will not allow you to approve, reject or cancel a price assignment submitted by you.

Procedure

To reject a price assignment for a price list:

1. Click the **Menu** link in the **Actions/Navigation** area.

A list appears.

2. From the **Main** menu, select **Approval Workflow** and then click **Approve Price Assignment**.

The **Approve Price Assignment** screen appears.

3. Enter the search criteria in the **Search** zone.

Note: ORMB search engine supports wildcard search, where you can substitute the percentage (%) symbol as a stand in for any word or letter in a search criteria. You can use the ‘%’ wildcard character in all input fields except the date and ID fields. The ‘%’ wildcard character is suffixed automatically at the end of the partial search criteria. Therefore, you may or may not specify the wildcard character at the end of the partial search criteria. However, you have to prefix the wildcard character manually wherever required.

4. Click **Search**.

A list of price lists that meet the search criteria appears in the **Search Results** section.

5. Click the **Broadcast** (📡) icon corresponding to the price list whose price assignments you want to review.

The **List of Price Assignments** zone appears.

6. In the **List of Price Assignments** zone, click the **Broadcast** (📡) icon corresponding to the price assignment whose details you want to review.

The **Comparison: New Versus Existing** zone appears.

Note:

By default, any modifications will be highlighted in the Yellow (9933FF) color and new additions will be highlighted in the Purple (FFFF66) color. You can easily change these default colors. For more information on how to set the colors used for highlighting, see [Setting the CI_AXENTITY Feature Configuration](#) on page 4308.

Only those users who have access to the application services for each business object within the approval workflow group will be able to view the details of the price assignment request.

7. Review the compared existing and new approval transactions.

The **Rejection/Cancellation Reason** screen appears.

Tip: Alternatively, in the **List of Price Assignments** zone, you can select the check box corresponding to the price assignment request that you want to reject, and then click **Return to Submitter**.

8. Click **Return to Submitter**.

The **Rejection/Cancelation Reason** screen appears. It contains the following fields:

Field Name	Field Description	Mandatory (Yes or No)
Approval Workflow Reason	Used to search a particular approval workflow reason.	Yes
Comments	Used to add additional comments.	No

9. Enter the required details.

The **Approve** and **Revert to Original** buttons are disabled.

10. Click **OK**.

The approval transaction is removed from the **List of Price Assignments** zone.

Tip: Alternatively, you can reject the price assignment by selecting the check box corresponding to the price assignment which you want to reject and then click the **Return to Submitter** button in the **List of Price Assignments** zone.

Related Topics

For more information on...	See...
Approve Price Assignment screen	Approve Price Assignment on page 790
Search zone	Search on page 790
List of Price Assignments zone	List of Price Assignments on page 793
Comparison: New versus Existing zone	Comparison: New versus Existing on page 785

Canceling a Price Assignment for an Account

You can view the number of price assignments which are pending for approval in the **Approve Price Assignment** screen. You can review, and accordingly approve, reject or cancel the price assignment based on the observations.

Note: The system will not allow you to approve, reject or cancel a price assignment submitted by you.

Procedure

To cancel a price assignment for an account:

1. Click the **Menu** link in the **Application** toolbar.

A list appears.

2. From the **Main** menu, select **Approval Workflow** and then click **Approve Price Assignment**.

The **Approve Price Assignment** screen appears.

3. Enter the search criteria in the **Search** zone.

Note: ORMB search engine supports wildcard search, where you can substitute the percentage (%) symbol as a stand in for any word or letter in a search criteria. You can use the ‘%’ wildcard character in all input fields except the date and ID fields. The ‘%’ wildcard character is suffixed automatically at the end of the partial search criteria. Therefore, you may or may not specify the wildcard character at the end of the partial search criteria. However, you have to prefix the wildcard character manually wherever required.

4. Click **Search**.

A list of accounts that meet the search criteria appears in the **Search Results** section.

5. Click the **Broadcast** () icon corresponding to the account whose price assignments you want to review.

The **List of Price Assignments** zone appears.

- In the **List of Price Assignments** zone, click the **Broadcast** () icon corresponding to the price assignment whose details you want to review.

The **Comparison: New Versus Existing** zone appears.

Note:

By default, any modifications will be highlighted in the Yellow (9933FF) color and new additions will be highlighted in the Purple (FFFF66) color. You can easily change these default colors. For more information on how to set the colors used for highlighting, see [Setting the CI_AXENTITY Feature Configuration](#) on page 4308.

Only those users who have access to the application services for each business object within the approval workflow group will be able to view the details of the price assignment request.

- Review the compared existing and new approval transactions.

The **Rejection/Cancelation Reason** screen appears.

Tip: Alternatively, in the **List of Price Assignments** zone, you can select the check box corresponding to the price assignment request that you want to reject, and then click **Revert to Original**.

- Click **Revert to Original**.

The **Rejection/Cancelation Reason** screen appears. It contains the following fields:

Field Name	Field Description	Mandatory (Yes or No)
Approval Workflow Reason	Used to search a particular approval workflow reason.	Yes
Comments	Used to add additional comments.	No

- Enter the required details.

- Click **OK**.

The approval transaction is removed from the **List of Price Assignments** zone.

Tip: Alternatively, you can cancel the price assignment by selecting the check box corresponding to the price assignment which you want to cancel and then click the **Revert to Original** button in the **List of Price Assignments** zone.

Related Topics

For more information on...	See...
Approve Price Assignment screen	Approve Price Assignment on page 790
Search zone	Search on page 790
List of Price Assignments zone	List of Price Assignments on page 793
Comparison: New versus Existing zone	Comparison: New versus Existing on page 785

Canceling a Price Assignment for a Person

You can view the number of price assignments which are pending for approval in the **Approve Price Assignment** screen. You can review, and accordingly approve, reject or cancel the price assignment based on the observations.

Note: The system will not allow you to approve, reject or cancel a price assignment submitted by you.

Procedure

To cancel a price assignment for a person:

1. Click the **Menu** link in the **Application** toolbar.

A list appears.

2. From the **Main** menu, select **Approval Workflow** and then click **Approve Price Assignment**.

The **Approve Price Assignment** screen appears.

3. Enter the search criteria in the **Search** zone.

Note: ORMB search engine supports wildcard search, where you can substitute the percentage (%) symbol as a stand in for any word or letter in a search criteria. You can use the '%' wildcard character in all input fields except the date and ID fields. The '%' wildcard character is suffixed automatically at the end of the partial search criteria. Therefore, you may or may not specify the wildcard character at the end of the partial search criteria. However, you have to prefix the wildcard character manually wherever required.

4. Click **Search**.

A list of accounts that meet the search criteria appears in the **Search Results** section.

5. Click the **Broadcast** (📢) icon corresponding to the account whose price assignments you want to review.

The **List of Price Assignments** zone appears.

6. In the **List of Price Assignments** zone, click the

Broadcast (📢) icon corresponding to the price assignment whose details you want to review.

The **Comparison: New Versus Existing** zone appears.

Note:

By default, any modifications will be highlighted in the Yellow (9933FF) color and new additions will be highlighted in the Purple (FFFF66) color. You can easily change these default colors. For more information on how to set the colors used for highlighting, see [Setting the CI_AXENTITY Feature Configuration](#) on page 4308.

Only those users who have access to the application services for each business object within the approval workflow group will be able to view the details of the price assignment request.

7. Review the compared existing and new approval transactions.

The **Rejection/Cancelation Reason** screen appears.

Tip: Alternatively, in the **List of Price Assignments** zone, you can select the check box corresponding to the price assignment request that you want to reject, and then click **Revert to Original**.

8. Click **Revert to Original**.

The **Rejection/Cancelation Reason** screen appears. It contains the following fields:

Field Name	Field Description	Mandatory (Yes or No)
Approval Workflow Reason	Used to search a particular approval workflow reason.	Yes
Comments	Used to add additional comments.	No

9. Enter the required details.

10. Click **OK**.

The approval transaction is removed from the **List of Price Assignments** zone.

Tip: Alternatively, you can cancel the price assignment by selecting the check box corresponding to the price assignment which you want to cancel and then click the **Revert to Original** button in the **List of Price Assignments** zone.

Related Topics

For more information on...	See...
Approve Price Assignment screen	Approve Price Assignment on page 790
Search zone	Search on page 790
List of Price Assignments zone	List of Price Assignments on page 793
Comparison: New versus Existing zone	Comparison: New versus Existing on page 785

Canceling a Price Assignment for a Price List

You can view the number of price assignments which are pending for approval in the **Approve Price Assignment** screen. You can review, and accordingly approve, reject or cancel the price assignment based on the observations.

Note: The system will not allow you to approve, reject or cancel a price assignment submitted by you.

Procedure

To cancel a price assignment for a price list:

1. Click the **Menu** link in the **Application** toolbar.
A list appears.
2. From the **Main** menu, select **Approval Workflow** and then click **Approve Price Assignment**.
The **Approve Price Assignment** screen appears.
3. Enter the search criteria in the **Search** zone.

Note: ORMB search engine supports wildcard search, where you can substitute the percentage (%) symbol as a stand in for any word or letter in a search criteria. You can use the '%' wildcard character in all input fields except the date and ID fields. The '%' wildcard character is suffixed automatically at the end of the partial search criteria. Therefore, you may or may not specify the wildcard character at the end of the partial search criteria. However, you have to prefix the wildcard character manually wherever required.

4. Click **Search**.
A list of price lists that meet the search criteria appears in the **Search Results** section.
5. Click the **Broadcast** (📡) icon corresponding to the price list whose price assignments you want to review.
The **List of Price Assignments** zone appears.
6. In the **List of Price Assignments** zone, click the **Broadcast** (📡) icon corresponding to the price assignment whose details you want to review.
The **Comparison: New Versus Existing** zone appears.
7. Review the compared existing and new approval transactions.
The **Rejection/Cancellation Reason** screen appears.

Tip: Alternatively, in the **List of Price Assignments** zone, you can select the check box corresponding to the price assignment request that you want to cancel, and then click **Revert to Original**.

8. Click **Revert to Original**.

The **Rejection/Cancelation Reason** screen appears. It contains the following fields:

Field Name	Field Description	Mandatory (Yes or No)
Approval Workflow Reason	Used to search a particular approval workflow reason.	Yes
Comments	Used to add additional comments.	No

9. Enter the required details.

10. Click **OK**.

The approval transaction is removed from the **List of Price Assignments** zone.

Tip: Alternatively, you can cancel the price assignment by selecting the check box corresponding to the price assignment which you want to cancel and then click the **Revert to Original** button in the **List of Price Assignments** zone.

Related Topics

For more information on...	See...
Approve Price Assignment screen	Approve Price Assignment on page 790
Search zone	Search on page 790
List of Price Assignments zone	List of Price Assignments on page 793
Comparison: New versus Existing zone	Comparison: New versus Existing on page 785

Modify Price Assignment

The submitter has the facility to modify or withdraw a price assignment request before the approver at the first level in the hierarchy approves or rejects the request. Once the changes are made, the submitter submits the request for approval.

The **Modify Price Assignment** screen allows you to modify or withdraw a price assignment request. It contains the following zones:

- [Search](#) on page 808
- [List of Price Assignments](#) on page 822

Search

The **Search** zone allows you to search for the price assignment request using various search criteria. This zone contains the following two sections:

- **Search Criteria** – The **Search Criteria** section contains the following fields:

Field Name	Field Description	Mandatory (Yes or No)
Search By	Used to indicate whether you want to search for price assignments using the account, person, price list, submitter ID or transaction ID. The valid values are: <ul style="list-style-type: none"> • Person • Account • Price List • Submitter ID 	Yes

Field Name	Field Description	Mandatory (Yes or No)
	<ul style="list-style-type: none"> Approval Transaction ID 	
	Note: By default, the Person option is selected.	
Division	Used to search price assignments which are associated with a particular division.	No
	Note: You can only view those divisions to which you have access in the Division list. This field appears when you select the Person or Account option from the Search By list.	
Person Identifier Type	Used to select the identifier type based on which you want to search price assignments through which the person's record is created or updated in the system.	Yes (Conditional)
	Note: This field appears when you select the Person option from the Search By list.	Note: If you enter the person identifier as a search criteria, you have to select the person identifier type.
Person Identifier	Used to specify the value for the person identifier type.	Yes (Conditional)
		Note: If you specify the person identifier type as a search criteria, you have to enter the person identifier.
Account ID	Used to search price assignments which are created for a particular account.	No
	Note: This field appears when you select the Account option from the Search By list.	
Account Identifier Type	Used to select the identifier type based on which you want to search price assignments of an account.	Yes (Conditional)
	Note: This field appears when you select the Account option from the Search By list.	Note: If you enter the account identifier as a search criteria, you have to select the account identifier type.
Account Identifier	Used to specify the account whose price assignments you want to view.	Yes (Conditional)
	Note: This field appears when you select the Account option from the Search By list.	Note: If you specify the account identifier type as a search criteria, you have to enter the account identifier.

Field Name	Field Description	Mandatory (Yes or No)
Price List Description	Used to search price lists with a particular description.	No
	Note: This field appears when you select the Price List option from the Search By list.	
Submitter ID	Used to search for price assignment requests that are created by a particular submitter.	No
	Note: This field appears when you select the Submitter ID option from the Search By list.	
Approval Transaction ID	Used to search the price assignment request using the approval transaction ID.	No
	Note: The approval transaction ID is generated automatically when the price assignment request is created. This field appears when you select the Approval Transaction ID option from the Search By list.	

Note: You must specify at least one search criterion while searching for a price assignment.

- **Search Results** - On clicking the **Search** button, the search results appear based on the specified search criteria. The **Search Results** section contains the following columns:

Column Name	Column Description
Person Identifier	Indicates the person for whom the price assignment is created.
	Note: This column appears when you select the Person or Submitter ID option from the Search By list.
Person Name	Displays the name of the person.
	Note: This column appears when you select the Person or Submitter ID option from the Search By list.
Person Identifier Type	Displays the person identifier type.
	Note: This column appears when you select the Submitter ID option from the Search By list.
Division	Displays the division to which the account, person, or price list belongs.
Account Information	Displays information about the account. In addition, this column has a context menu which helps in navigating to other screens in the application.

Column Name	Column Description
	<p>Note:</p> <p>This column appears when you select the Account or Submitter ID option from the Search By list.</p> <p>It has a link. On clicking the link, the Account screen appears where you can view the details of the respective account.</p>
Account Identifier Type	<p>Indicates the account identifier type of the account for the price assignments.</p> <p>Note: This column appears when you select the Account or Submitter ID option from the Search By list.</p>
Account Identifier	<p>Displays the value of the account identifier type.</p> <p>Note: This column appears when you select the Account or Submitter ID option from the Search By list.</p>
Price List ID	<p>Displays the price list ID.</p> <p>Note: This column appears only when you select the Price List option from the Search By list.</p>
Price List Description	<p>Displays the description for the price list.</p> <p>Note: This column appears when you select the Price List option from the Search By list.</p> <p>Note: This column appears when you are searching for price assignment requests of a price list.</p>
Submitter ID	<p>Displays the ID of the submitter.</p> <p>Note: This column appears when you select the Submitter ID option from the Search By list.</p>

On clicking the **Broadcast** (📢) icon corresponding to the account, person, price list, or submitter ID the **List of Price Assignments** zone appears with the list of price assignments.

Related Topics

For more information on...	See...
List of Price Assignments zone	List of Price Assignments on page 812
How to modify a price assignment for an account	Modifying a Price Assignment for an Account on page 813
How to modify a price assignment for a person	Modifying a Price Assignment for a Person on page 814
How to modify a price assignment for a price list	Modifying a Price Assignment for a Price List on page 815
How to withdraw a price assignment for an account	Withdrawing a Price Assignment for an Account on page 815

For more information on...	See...
How to withdraw a price assignment for a person	Withdrawing a Price Assignment for a Person on page 816
How to withdraw a price assignment for a price list	Withdrawing a Price Assignment for a Price List on page 817

List of Price Assignments

The **List of Price Assignments** zone lists price assignment requests specific to an account, a person, or a price list. It contains the following columns:

Column Name	Column Description
Approval Transaction ID	Displays the approval transaction ID.
	Note: The approval transaction id is generated automatically when the price assignment request is created.
Submitter Name	Indicates the submitter who has created the price assignment request.
Action	Indicates the type of action, such as Add , Update (UPD) , or Delete (DEL) , performed by the submitter during price assignment.
Submitted On	Displays the date and time when the price assignment request was created by the submitter.
To Do Type	Displays the type of To Do (notification) received for the price assignment request.
Price Item	Displays the price item or price item code.
Description	Displays the description of the price item or price item code.
Pricing Currency	Indicates the currency in which the price item pricing is defined.
Start Date	Displays the date from when the price item pricing is effective.
End Date	Displays the date till when the price item pricing is effective.
Approval Transaction Information	Displays information about the approval transaction.
	Note: This information string is generated using the C1-APPTXNINF algorithm.
Modify	It has a link. On clicking the Modify link, the Modify/Resolve Price Assignment screen appears where you can modify the price assignment.
Withdraw	It has a link. On clicking the Withdraw link, you can withdraw and remove the approval transaction from the list of price assignments.
View	It has a link. On clicking the Log link, you can view the approval transaction log details.

By default, the **List of Price Assignments** zone does not appear in the **Modify Price Assignment** screen. It appears when you click the **Broadcast** () icon corresponding to the account, person, or price list in the **Search** zone.

Related Topics

For more information on...	See...
Modify Price Assignment Search zone	Search on page 808

For more information on...	See...
How to modify a price assignment for an account	Modifying a Price Assignment for an Account on page 813
How to modify a price assignment for a person	Modifying a Price Assignment for a Person on page 814
How to modify a price assignment for a price list	Modifying a Price Assignment for a Price List on page 815
How to withdraw a price assignment for an account	Withdrawing a Price Assignment for an Account on page 815
How to withdraw a price assignment for a person	Withdrawing a Price Assignment for a Person on page 816
How to withdraw a price assignment for a price list	Withdrawing a Price Assignment for a Price List on page 817

Modifying a Price Assignment for an Account

You can view the number of price assignments which are pending for modification in the **Modify Price Assignment** screen. The modifier can review, and accordingly modify, withdraw or view log of the price assignment based on the observations.

Procedure

To modify a price assignment for an account:

1. Click the **Menu** link in the **Application** toolbar.
A list appears.
2. From the **Main** menu, select **Approval Workflow** and then click **Modify Price Assignment**.
The **Modify Price Assignment** screen appears.
3. Enter the search criteria in the **Search** zone.

Note: ORMB search engine supports wildcard search, where you can substitute the percentage (%) symbol as a stand in for any word or letter in a search criteria. You can use the ‘%’ wildcard character in all input fields except the date and ID fields. The ‘%’ wildcard character is suffixed automatically at the end of the partial search criteria. Therefore, you may or may not specify the wildcard character at the end of the partial search criteria. However, you have to prefix the wildcard character manually wherever required.

4. Click **Search**.
A list of accounts that meet the search criteria appears in the **Search Results** section.
5. Click the **Broadcast** (📡) icon corresponding to the account whose price assignments you want to review.
The **List of Price Assignments** zone appears.
6. Click the **Modify** link in the **Modify** column corresponding to the price assignment that you want to modify.
The **Modify/Resolve Price Assignment** screen appears.

Note: Only those users who have access to the application services for each business object within the approval workflow group will be able to modify the details of the price assignment request.

7. Make the required changes.
8. Modify the required details.
The changes made to the price assignment are saved.

Related Topics

For more information on...	See...
Modify Price Assignment screen	Modify Price Assignment on page 808
Search zone	Search on page 808
List of Price Assignments zone	List of Price Assignments on page 812

Modifying a Price Assignment for a Person**Procedure**

To modify a price assignment for a person:

1. Click the **Menu** link in the **Application** toolbar.
A list appears.
2. From the **Main** menu, select **Approval Workflow** and then click **Modify Price Assignment**.
The **Modify Price Assignment** screen appears.
3. In the **Search** zone, enter the search criteria, such as the division to which the person belongs or the person identification type and value.

Note: ORMB search engine supports wildcard search, where you can substitute the percentage (%) symbol as a stand in for any word or letter in a search criteria. You can use the ‘%’ wildcard character in all input fields except the date and ID fields. The ‘%’ wildcard character is suffixed automatically at the end of the partial search criteria. Therefore, you may or may not specify the wildcard character at the end of the partial search criteria. However, you have to prefix the wildcard character manually wherever required.

4. Click **Search**.
A list of persons that meet the search criteria appears in the **Search Results** section.
5. Click the **Broadcast** (📡) icon corresponding to the person whose price assignment requests you want to modify.
The **List of Price Assignments** zone appears.
6. Click the **Modify** link in the **Modify** column corresponding to the price assignment request that you want to modify.
The **Modify/Resolve Price Assignment** screen appears where you can modify the pricing details, tiering ranges, and price assignment characteristics.

Note: Only those users who have access to the application services for each business object within the approval workflow group will be able to modify the details of the price assignment request.

7. Make the required changes.
8. Click **Save**.
The price assignment for a person is updated.

Related Topics

For more information on...	See...
Modify Price Assignment screen	Modify Price Assignment on page 808
Search zone	Search on page 808

For more information on...	See...
List of Price Assignments zone	List of Price Assignments on page 812

Modifying a Price Assignment for a Price List

Procedure

To modify a price assignment for a price list:

1. Click the **Menu** link in the **Application** toolbar.
A list appears.
2. From the **Main** menu, select **Approval Workflow** and then click **Modify Price Assignment**.

The **Modify Price Assignment** screen appears.

3. In the **Search** zone, enter the search criteria, such as the description of the price list.

Note: ORMB search engine supports wildcard search, where you can substitute the percentage (%) symbol as a stand in for any word or letter in a search criteria. You can use the ‘%’ wildcard character in all input fields except the date and ID fields. The ‘%’ wildcard character is suffixed automatically at the end of the partial search criteria. Therefore, you may or may not specify the wildcard character at the end of the partial search criteria. However, you have to prefix the wildcard character manually wherever required.

4. Click **Search**.

A list of price lists that meet the search criteria appears in the **Search Results** section.

5. Click the **Broadcast** () icon corresponding to the price list whose price assignment requests you want to modify.

The **List of Price Assignments** zone appears.

6. Click the **Modify** link in the **Modify** column corresponding to the price assignment request that you want modify.

The **Modify/Resolve Price Assignment** screen appears where you can modify the pricing details, tiering ranges, and price assignment characteristics.

Note: Only those users who have access to the application services for each business object within the approval workflow group will be able to modify the details of the price assignment request.

7. Make the required changes.

8. Click **Save**.

The price assignment for a price list is updated.

Related Topics

For more information on...	See...
Modify Price Assignment screen	Modify Price Assignment on page 808
Search zone	Search on page 808
List of Price Assignments zone	List of Price Assignments on page 812

Withdrawing a Price Assignment for an Account

Procedure

To withdraw a price assignment for an account:

1. Click the **Menu** link in the **Application** toolbar.

A list appears.

2. Do the following:

If you want to...	Then...
Withdraw a price assignment request when it is in the Pending Approval status	From the Main menu, select Approval Workflow and then click Modify Price Assignment . The Modify Price Assignment screen appears.
Withdraw a price assignment request when it has been rejected by an approver at any level in the hierarchy	From the Main menu, select Approval Workflow and then click Resolve Price Assignment . The Resolve Price Assignment screen appears.

3. In the **Search** zone, enter the search criteria, such as the division to which the account belongs, account ID, or account identifier.

Note: ORMB search engine supports wildcard search, where you can substitute the percentage (%) symbol as a stand in for any word or letter in a search criteria. You can use the '%' wildcard character in all input fields except the date and ID fields. The '%' wildcard character is suffixed automatically at the end of the partial search criteria. Therefore, you may or may not specify the wildcard character at the end of the partial search criteria. However, you have to prefix the wildcard character manually wherever required.

4. Click **Search**.

A list of accounts that meet the search criteria appears in the **Search Results** section.

5. Click the **Broadcast** () icon corresponding to the account whose price assignment requests you want to withdraw.

The **List of Price Assignments** zone appears.

Note: The system provides you with a facility to view the log of a price assignment request from the **Modify Price Assignment** and **Resolve Price Assignment** screens before withdrawing a request.

6. Click the **Withdraw** link in the **Withdraw** column corresponding to the price assignment request that you want to withdraw.

A message box appears confirming whether you want to delete the price assignment request.

7. Click **OK**.

You will no longer be able to view this request in your workflow.

Related Topics

For more information on...	See...
Modify Price Assignment screen	Modify Price Assignment on page 808
Resolve Price Assignment screen	Resolve Price Assignment on page 819

Withdrawing a Price Assignment for a Person

Procedure

To withdraw a price assignment for a person:

1. Click the **Menu** link in the **Application** toolbar.

A list appears.

2. Select the **Main** menu and do the following:

If you want to...	Then...
Withdraw a price assignment request when it is in the Pending Approval status	From the Main menu, select Approval Workflow and then click Modify Price Assignment . The Modify Price Assignment screen appears.
Withdraw a price assignment request when it has been rejected by an approver at any level in the hierarchy	From the Main menu, select Approval Workflow and then click Resolve Price Assignment . The Resolve Price Assignment screen appears.

3. In the **Search** zone, enter the search criteria, such as the division to which the person belongs or the person identification type and value.

Note: ORMB search engine supports wildcard search, where you can substitute the percentage (%) symbol as a stand in for any word or letter in a search criteria. You can use the ‘%’ wildcard character in all input fields except the date and ID fields. The ‘%’ wildcard character is suffixed automatically at the end of the partial search criteria. Therefore, you may or may not specify the wildcard character at the end of the partial search criteria. However, you have to prefix the wildcard character manually wherever required.

4. Click **Search**.

A list of persons that meet the search criteria appears in the **Search Results** section.

5. Click the **Broadcast** () icon corresponding to the person whose price assignment requests you want to withdraw.

The **List of Price Assignments** zone appears.

Note: The system provides you with a facility to view the log of a price assignment request from the **Modify Price Assignment** and **Resolve Price Assignment** screens before withdrawing a request.

6. Click the **Withdraw** link in the **Withdraw** column corresponding to the price assignment request that you want to withdraw.

A message box appears confirming whether you want to delete the price assignment request.

7. Click **OK**.

You will no longer be able to view this request in your workflow.

Related Topics

For more information on...	See...
Modify Price Assignment screen	Modify Price Assignment on page 808
Resolve Price Assignment screen	Resolve Price Assignment on page 819

Withdrawing a Price Assignment for a Price List

Procedure

To withdraw a price assignment for a price list:

1. Click the **Menu** link in the **Application** toolbar.

A list appears.

2. Do the following:

If you want to...	Then...
Withdraw a price assignment request when it is in the Pending Approval status	From the Main menu, select Approval Workflow and then click Modify Price Assignment . The Modify Price Assignment screen appears.
Withdraw a price assignment request when it has been rejected by an approver at any level in the hierarchy	From the Main menu, select Approval Workflow and then click Resolve Price Assignment . The Resolve Price Assignment screen appears.

- In the **Search** zone, enter the search criteria, such as the description of the price list.

Note: ORMB search engine supports wildcard search, where you can substitute the percentage (%) symbol as a stand in for any word or letter in a search criteria. You can use the '%' wildcard character in all input fields except the date and ID fields. The '%' wildcard character is suffixed automatically at the end of the partial search criteria. Therefore, you may or may not specify the wildcard character at the end of the partial search criteria. However, you have to prefix the wildcard character manually wherever required.

- Click **Search**.

A list of price lists that meet the search criteria appears in the **Search Results** section.

- Click the **Broadcast** (📡) icon corresponding to the price list whose price assignment requests you want to withdraw.

The **List of Price Assignments** zone appears.

Note: The system provides you with a facility to view the log of a price assignment request from the **Modify Price Assignment** and **Resolve Price Assignment** screens before withdrawing a request.

- Click the **Withdraw** link in the **Withdraw** column corresponding to the price assignment request that you want to withdraw.

A message box appears confirming whether you want to delete the price assignment request.

- Click **OK**.

You will no longer be able to view this request in your workflow.

Related Topics

For more information on...	See...
Modify Price Assignment screen	Modify Price Assignment on page 808
Resolve Price Assignment screen	Resolve Price Assignment on page 819

Viewing the Log of an Approval Transaction

Procedure

To view the log of an approval transaction:

- Click the **Menu** link in the **Application** toolbar.

A list appears.

- From the **Main** menu, select **Approval Workflow** and then click **Modify Price Assignment**.

The **Modify Price Assignment** screen appears.

- In the **Search** zone, enter the search criteria, such as the description of the price list.

Note: ORMB search engine supports wildcard search, where you can substitute the percentage (%) symbol as a stand in for any word or letter in a search criteria. You can use the ‘%’ wildcard character in all input fields except the date and ID fields. The ‘%’ wildcard character is suffixed automatically at the end of the partial search criteria. Therefore, you may or may not specify the wildcard character at the end of the partial search criteria. However, you have to prefix the wildcard character manually wherever required.

4. Click **Search**.

A list of price lists that meet the search criteria appears in the **Search Results** section.

5. Click the **Broadcast** () icon corresponding to the price list whose price assignment requests you want to modify.

The **List of Price Assignments** zone appears.

6. Click on **Log** link in the **View** column.

The **Approval Transaction Log** screen appears.

7. View the log of an approval transaction, as required.

Related Topics

For more information on...	See...
Modify Price Assignment screen	Modify Price Assignment on page 808
Search zone	Search on page 808
Approval Transaction Log zone	Approval Transaction Log on page 783

Resolve Price Assignment

If an approver at any level in the hierarchy rejects a price assignment request, a notification is sent to the submitter who has made the changes. The submitter then makes the required corrections based on the approver’s comments, and resubmits the changes for approval. In this case, the approval process starts once again from the beginning, and not from the level at which the request was rejected.

The **Resolve Price Assignment** screen allows you to resolve or withdraw a price assignment request. It consists of the following zones:

- [Search](#) on page 819
- [List of Price Assignments](#) on page 822

Search

The **Search** zone allows you to search for the price assignment requests rejected by approvers and pending for you to resolve. It contains the following two sections:

- **Search Criteria** — The **Search Criteria** section contains the following fields:

Field Name	Field Description	Mandatory (Yes or No)
Search By	Used to indicate whether you want to search price assignments using various details. The valid values are: <ul style="list-style-type: none"> • Person • Account 	Yes

Field Name	Field Description	Mandatory (Yes or No)
	<ul style="list-style-type: none"> Price List Submitter ID Approver Transaction ID <p>Note: By default, the Person option is selected.</p>	
Division	<p>Used to search price assignments which belong to a particular division.</p> <p>Note: You can only view those divisions to which you have access in the Division list.</p>	No
Person Identifier Type	<p>Used to specify the identifier type based on which you want to search for price assignment requests of a person.</p> <p>Note: This field appears when you select the Person option from the Search By list.</p>	<p>Yes (Conditional)</p> <p>Note: If you enter the person identifier as a search criteria, you have to select the person identifier type.</p>
Person Identifier	<p>Used to specify the ID linked to the person.</p> <p>Note: This field appears when you select the Person option from the Search By list.</p>	<p>Yes (Conditional)</p> <p>Note: If you specify the person identifier type as a search criteria, you have to enter the person identifier.</p>
Account ID	<p>Used to search for price assignment requests created for an account.</p> <p>Note: This field appears when you select the Account option from the Search By list.</p>	No
Account Identifier Type	<p>Used to specify the account identifier type of the account whose price assignment requests you want to search.</p> <p>Note: This field appears when you select the Account option from the Search By list.</p>	<p>Yes (Conditional)</p> <p>Note: If you enter the account identifier as a search criteria, you have to select the account identifier type.</p>
Account Identifier	<p>Used to specify the value of the account identifier type.</p> <p>Note: This field appears when you select the Account option from the Search By list.</p>	<p>Yes (Conditional)</p> <p>Note: If you specify the account identifier type as a search criteria, you have to enter the account identifier.</p>
Price List Description	<p>Used to search for price assignment requests created for a price list.</p> <p>Note: This field appears when you select the Price List option from the Search By list.</p>	No

Field Name	Field Description	Mandatory (Yes or No)
Submitter ID	Used to search for price assignment requests that are created by a particular submitter.	No
	Note: This field appears when you select the Submitter ID option from the Search By list.	
Approval Transaction ID	Used to search the price assignment request using the approval transaction ID.	No
	Note: The approval transaction ID is generated automatically when the price assignment request is created. This field appears when you select the Approval Transaction ID option from the Search By list.	

Note: You must specify at least one search criterion while searching for a price assignments.

- **Search Results** — On clicking the **Search** button, the search results appear based on the specified search criteria. The **Search Results** section contains the following columns:

Column Name	Column Description
Person Identifier	Displays the ID linked to the person.
	Note: This column appears when you are searching for price assignment requests of a person.
Person Name	Displays the name of the person.
	Note: This column appears when you are searching for price assignment requests of a person.
Division	Displays the division to which the account, person, or price list belongs.
Account Information	Displays information about the account. In addition, this column has a context menu which helps in navigating to other screens in the application.
	Note: This column appears when you are searching for price assignment requests of an account. It has a link. On clicking the link, the Account screen appears where you can view the details of the respective account.
Account Identifier Type	Displays the account identifier type.
	Note: This column appears when you are searching for price assignment requests of an account.
Account Identifier	Displays the value of the account identifier type.

Column Name	Column Description
	Note: This column appears when you are searching for price assignment requests of an account.
Price List ID	Displays the price list ID. Note: This column appears only when you are searching for price assignment requests of a price list.
Price List Description	Displays the description of the price list. Note: This column appears when you are searching for price assignment requests of a price list.
Owner ID	Displays the ID of the person for whose account the approval workflow request is created.
Approval Transaction ID	Displays the approval transaction ID. Note: The approval transaction ID is generated automatically when the price assignment request is created.
Person Identifier Type	Displays the person identifier type. Note: This column appears when you are searching for price assignment requests of a person.

On clicking the **Broadcast** (📢) icon corresponding to the account, person, or price list, the **List of Price Assignments** zone appears.

Related Topics

For more information on...	See...
How to resolve a price assignment for an account	Resolving a Price Assignment for an Account on page 824
How to resolve a price assignment for a person	Resolving a Price Assignment for a Person on page 825
How to resolve a price assignment for a price list	Resolving a Price Assignment for a Price List on page 825
How to withdraw a price assignment for an account	Withdrawing a Price Assignment for an Account on page 826
How to withdraw a price assignment for a person	Withdrawing a Price Assignment for a Person on page 827
How to withdraw a price assignment for a price list	Withdrawing a Price Assignment for a Price List on page 828

List of Price Assignments

The **List of Price Assignments** zone lists price assignment requests specific to an account, a person, or a price list. It contains the following columns:

Column Name	Column Description
Approval Transaction ID	Displays the approval transaction ID.

Column Name	Column Description
	Note: The approval transaction ID is generated automatically when the price assignment request is created.
Submitter Name	Indicates the submitter who has created the price assignment request.
Action	Indicates the type of action, such as Add , Update (UPD) , or Delete (DEL) performed by the submitter during price assignment.
Submitted On	Displays the date and time when the price assignment request was created by the submitter.
To Do Type	Displays the type of To Do (notification) received for the price assignment request.
Price Item	Displays the price item code.
Description	Displays the description of the product.
Pricing Currency	Indicates the currency in which the product pricing is defined.
Start Date	Displays the date from when the product pricing is effective.
End Date	Displays the date till when the product pricing is effective.
Approver Name	Indicates the approver who has rejected the price assignment request.
Rejected On	Displays the date and time when the price assignment request was rejected by an approver.
Reject Reason	Indicates the reason why the price assignment request was rejected.
Rejection Comments	Displays the additional details entered by an approver on rejecting the price assignment request.
Approval Transaction Information	Displays information about the approval transaction. Note: This information string is generated using the C1-APPTXNINF algorithm.
Resolve	On clicking the Resolve link, you can modify the details of the price assignment request, and resubmit it for approval. On resubmitting, the approval workflow process starts once again from the first level in the hierarchy.
Withdraw	On clicking the Withdraw link, you can withdraw the price assignment request. Once you withdraw the request, no further action will be taken on the request.
View	On clicking the Log link, you can view the log of the price assignment request from the Resolve Price Assignment screen before resolving or withdrawing a request.

By default, the **List of Price Assignments** zone does not appear in the **Resolve Price Assignment** screen. It appears when you click the **Broadcast** () icon corresponding to the account, person, or price list in the **Search** zone.

Related Topics

For more information on...	See...
How to resolve a price assignment for an account	Resolving a Price Assignment for an Account on page 824
How to resolve a price assignment for a person	Resolving a Price Assignment for a Person on page 825
How to resolve a price assignment for a price list	Resolving a Price Assignment for a Price List on page 825
How to withdraw a price assignment for an account	Withdrawing a Price Assignment for an Account on page 826

For more information on...	See...
How to withdraw a price assignment for a person	Withdrawing a Price Assignment for a Person on page 827
How to withdraw a price assignment for a price list	Withdrawing a Price Assignment for a Price List on page 828

Resolving a Price Assignment for an Account

Procedure

To resolve a price assignment for an account:

1. Click the **Menu** link in the **Application** toolbar.
A list appears.
2. From the **Main** menu, select **Approval Workflow** and then click **Resolve Price Assignment**.
The **Resolve Price Assignment** screen appears.
3. In the **Search** zone, enter the search criteria, such as the division to which the account belongs, account ID, or account identifier.

Note: ORMB search engine supports wildcard search, where you can substitute the percentage (%) symbol as a stand in for any word or letter in a search criteria. You can use the ‘%’ wildcard character in all input fields except the date and ID fields. The ‘%’ wildcard character is suffixed automatically at the end of the partial search criteria. Therefore, you may or may not specify the wildcard character at the end of the partial search criteria. However, you have to prefix the wildcard character manually wherever required.

4. Click **Search**.
A list of accounts that meet the search criteria appears in the **Search Results** section.
5. Click the **Broadcast** () icon corresponding to the account whose price assignment requests you want to resolve.
The **List of Price Assignments** zone appears.
6. Click the **Resolve** link in the **Resolve** column corresponding to the price assignment request that you want to resolve.
The **Modify/Resolve Price Assignment** screen appears where you can modify the pricing details, tiering ranges, and price assignment characteristics.

Note: Only those users who have access to the application services for each business object within the approval workflow group will be able to resolve the request and resubmit it for approval.

7. Make the required changes.
8. Click **Save**.
The price assignment is updated and resubmitted for approval.

Related Topics

For more information on...	See...
Resolve Price Assignment screen	Resolve Price Assignment on page 819
Search zone	Search on page 819
List of Price Assignments zone	List of Price Assignments on page 822

Resolving a Price Assignment for a Person

Procedure

To resolve a price assignment for a person:

1. Click the **Menu** link in the **Application** toolbar.
A list appears.
2. From the **Main** menu, select **Approval Workflow** and then click **Resolve Price Assignment**.
The **Resolve Price Assignment** screen appears.
3. In the **Search** zone, enter the search criteria, such as the division to which the person belongs or the person identification type and value.

Note: ORMB search engine supports wildcard search, where you can substitute the percentage (%) symbol as a stand in for any word or letter in a search criteria. You can use the ‘%’ wildcard character in all input fields except the date and ID fields. The ‘%’ wildcard character is suffixed automatically at the end of the partial search criteria. Therefore, you may or may not specify the wildcard character at the end of the partial search criteria. However, you have to prefix the wildcard character manually wherever required.

4. Click **Search**.
A list of persons that meet the search criteria appears in the **Search Results** section.
5. Click the **Broadcast** (📡) icon corresponding to the person whose price assignment requests you want to resolve.
The **List of Price Assignments** zone appears.
6. Click the **Resolve** link in the **Resolve** column corresponding to the price assignment request that you want to resolve.
A screen appears where you can modify the pricing details, tiering ranges, and price assignment characteristics.

Note: Only those users who have access to the application services for each business object within the approval workflow group will be able to resolve the request, and resubmit it for approval.

7. Make the required changes.
8. Click **Save**.
The price assignment is updated and resubmitted for approval.

Related Topics

For more information on...	See...
Resolve Price Assignment screen	Resolve Price Assignment on page 819
Search zone	Search on page 819
List of Price Assignments zone	List of Price Assignments on page 822

Resolving a Price Assignment for a Price List

Procedure

To resolve a price assignment for a price list:

1. Click the **Menu** link in the **Application** toolbar.

A list appears.

- From the **Main** menu, select **Approval Workflow** and then click **Resolve Price Assignment**.

The **Resolve Price Assignment** screen appears.

- In the **Search** zone, enter the search criteria, such as the description of the price list.

Note: ORMB search engine supports wildcard search, where you can substitute the percentage (%) symbol as a stand in for any word or letter in a search criteria. You can use the ‘%’ wildcard character in all input fields except the date and ID fields. The ‘%’ wildcard character is suffixed automatically at the end of the partial search criteria. Therefore, you may or may not specify the wildcard character at the end of the partial search criteria. However, you have to prefix the wildcard character manually wherever required.

- Click **Search**.

A list of price lists that meet the search criteria appears in the **Search Results** section.

- Click the **Broadcast** () icon corresponding to the price list whose price assignment requests you want to resolve.

The **List of Price Assignments** zone appears.

- Click the **Resolve** link in the **Resolve** column corresponding to the price assignment request that you want to resolve.

The **Modify/Resolve Price Assignment** screen appears where you can modify the pricing details, tiering ranges, and price assignment characteristics.

Note: Only those users who have access to the application services for each business object within the approval workflow group will be able to resolve the request, and resubmit it for approval.

- Make the required changes.

- Click **Save**.

The price assignment is updated and resubmitted for approval.

Related Topics

For more information on...	See...
Resolve Price Assignment screen	Resolve Price Assignment on page 819
Search zone	Search on page 819
List of Price Assignments zone	List of Price Assignments on page 822

Withdrawing a Price Assignment for an Account

Procedure

To withdraw a price assignment for an account:

- Click the **Menu** link in the **Application** toolbar.

A list appears.

- Do the following:

If you want to...	Then...
Withdraw a price assignment request when it is in the Pending Approval status	From the Main menu, select Approval Workflow and then click Modify Price Assignment . The Modify Price Assignment screen appears.
Withdraw a price assignment request when it has been rejected by an approver at any level in the hierarchy	From the Main menu, select Approval Workflow and then click Resolve Price Assignment . The Resolve Price Assignment screen appears.

- In the **Search** zone, enter the search criteria, such as the division to which the account belongs, account ID, or account identifier.

Note: ORMB search engine supports wildcard search, where you can substitute the percentage (%) symbol as a stand in for any word or letter in a search criteria. You can use the '%' wildcard character in all input fields except the date and ID fields. The '%' wildcard character is suffixed automatically at the end of the partial search criteria. Therefore, you may or may not specify the wildcard character at the end of the partial search criteria. However, you have to prefix the wildcard character manually wherever required.

- Click **Search**.

A list of accounts that meet the search criteria appears in the **Search Results** section.

- Click the **Broadcast** () icon corresponding to the account whose price assignment requests you want to withdraw.

The **List of Price Assignments** zone appears.

Note: The system provides you with a facility to view the log of a price assignment request from the **Modify Price Assignment** and **Resolve Price Assignment** screens before withdrawing a request.

- Click the **Withdraw** link in the **Withdraw** column corresponding to the price assignment request that you want to withdraw.

A message box appears confirming whether you want to delete the price assignment request.

- Click **OK**.

You will no longer be able to view this request in your workflow.

Related Topics

For more information on...	See...
Modify Price Assignment screen	Modify Price Assignment on page 808
Resolve Price Assignment screen	Resolve Price Assignment on page 819

Withdrawing a Price Assignment for a Person

Procedure

To withdraw a price assignment for a person:

- Click the **Menu** link in the **Application** toolbar.
A list appears.
- Select the **Main** menu and do the following:

If you want to...	Then...
Withdraw a price assignment request when it is in the Pending Approval status	From the Main menu, select Approval Workflow and then click Modify Price Assignment . The Modify Price Assignment screen appears.
Withdraw a price assignment request when it has been rejected by an approver at any level in the hierarchy	From the Main menu, select Approval Workflow and then click Resolve Price Assignment . The Resolve Price Assignment screen appears.

- In the **Search** zone, enter the search criteria, such as the division to which the person belongs or the person identification type and value.

Note: ORMB search engine supports wildcard search, where you can substitute the percentage (%) symbol as a stand in for any word or letter in a search criteria. You can use the '%' wildcard character in all input fields except the date and ID fields. The '%' wildcard character is suffixed automatically at the end of the partial search criteria. Therefore, you may or may not specify the wildcard character at the end of the partial search criteria. However, you have to prefix the wildcard character manually wherever required.

- Click **Search**.

A list of persons that meet the search criteria appears in the **Search Results** section.

- Click the **Broadcast** (📡) icon corresponding to the person whose price assignment requests you want to withdraw.

The **List of Price Assignments** zone appears.

Note: The system provides you with a facility to view the log of a price assignment request from the **Modify Price Assignment** and **Resolve Price Assignment** screens before withdrawing a request.

- Click the **Withdraw** link in the **Withdraw** column corresponding to the price assignment request that you want to withdraw.

A message box appears confirming whether you want to delete the price assignment request.

- Click **OK**.

You will no longer be able to view this request in your workflow.

Related Topics

For more information on...	See...
Modify Price Assignment screen	Modify Price Assignment on page 808
Resolve Price Assignment screen	Resolve Price Assignment on page 819

Withdrawing a Price Assignment for a Price List

Procedure

To withdraw a price assignment for a price list:

- Click the **Menu** link in the **Application** toolbar.

A list appears.

- Do the following:

If you want to...	Then...
Withdraw a price assignment request when it is in the Pending Approval status	From the Main menu, select Approval Workflow and then click Modify Price Assignment . The Modify Price Assignment screen appears.
Withdraw a price assignment request when it has been rejected by an approver at any level in the hierarchy	From the Main menu, select Approval Workflow and then click Resolve Price Assignment . The Resolve Price Assignment screen appears.

- In the **Search** zone, enter the search criteria, such as the description of the price list.

Note: ORMB search engine supports wildcard search, where you can substitute the percentage (%) symbol as a stand in for any word or letter in a search criteria. You can use the '%' wildcard character in all input fields except the date and ID fields. The '%' wildcard character is suffixed automatically at the end of the partial search criteria. Therefore, you may or may not specify the wildcard character at the end of the partial search criteria. However, you have to prefix the wildcard character manually wherever required.

- Click **Search**.

A list of price lists that meet the search criteria appears in the **Search Results** section.

- Click the **Broadcast** (📡) icon corresponding to the price list whose price assignment requests you want to withdraw.

The **List of Price Assignments** zone appears.

Note: The system provides you with a facility to view the log of a price assignment request from the **Modify Price Assignment** and **Resolve Price Assignment** screens before withdrawing a request.

- Click the **Withdraw** link in the **Withdraw** column corresponding to the price assignment request that you want to withdraw.

A message box appears confirming whether you want to delete the price assignment request.

- Click **OK**.

You will no longer be able to view this request in your workflow.

Related Topics

For more information on...	See...
Modify Price Assignment screen	Modify Price Assignment on page 808
Resolve Price Assignment screen	Resolve Price Assignment on page 819

Viewing the Log of an Approval Transaction

Procedure

To view the log of an approval transaction:

- Click the **Menu** link in the **Application** toolbar.

A list appears.

- From the **Main** menu, select **Approval Workflow** and then click **Modify Price Assignment**.

The **Resolve Price Assignment** screen appears.

- In the **Search** zone, enter the search criteria, such as the description of the price list.

Note: ORMB search engine supports wildcard search, where you can substitute the percentage (%) symbol as a stand in for any word or letter in a search criteria. You can use the ‘%’ wildcard character in all input fields except the date and ID fields. The ‘%’ wildcard character is suffixed automatically at the end of the partial search criteria. Therefore, you may or may not specify the wildcard character at the end of the partial search criteria. However, you have to prefix the wildcard character manually wherever required.

4. Click **Search**.

A list of price lists that meet the search criteria appears in the **Search Results** section.

5. Click the **Broadcast** () icon corresponding to the price list whose price assignment requests you want to modify.

The **List of Price Assignments** zone appears.

6. Click on **Log** link in the **View** column.

The **Approval Transaction Log** screen appears.

7. You can view the log of an approval transaction, as required.

Related Topics

For more information on...	See...
Approval Transaction screen	Approval Transaction on page 779
Search zone	Search on page 819
Approval Transaction Log zone	Approval Transaction Log on page 783

Approval Workflow Group (Used for Searching)

The **Approval Workflow Group** screen allows you to search for approval workflow group using various search criteria. Through this screen, you can navigate to the following screen:

- [Approval Workflow Group \(Used for Viewing\)](#) on page 839

This screen consists of the following zone:

- [Search Approval Workflow Group](#) on page 830

For more information on...	See...
How to search an approval workflow group	Searching for an Approval Workflow Group on page 831
How to view the details of approval workflow group	Viewing the Approval Workflow Group Details on page 832

Search Approval Workflow Group

The **Search Approval Workflow Group** zone allows you to search for an approval workflow group using various search criteria. It contains the following sections:

- **Search Criteria** - The **Search Criteria** section contains the following fields:

Field Name	Field Description	Mandatory (Yes or No)
Approval Workflow Group	Used to search a particular approval workflow group.	No

Field Name	Field Description	Mandatory (Yes or No)
Description	Used to search approval workflow groups with a particular description.	No

- **Search Results** - On clicking the **Search** button, the search results appear based on the specified search criteria. The **Search Results** section contains the following columns:

Column Name	Column Description
Approval Workflow Group	Displays the approval workflow group.
Description	Displays the description of the approval workflow group.
	Note: It has a link. On clicking the link, the Approval Workflow Group screen appears where you can view the details of the respective approval workflow group.

Note: You must specify at least one search criterion while searching for an Approval Workflow Group.

Related Topics

For more information on...	See...
How to search for an approval workflow group	Searching for an Approval Workflow Group on page 831
How to view the details of an approval workflow group	Viewing the Approval Workflow Group Details on page 832

Searching for an Approval Workflow Group

Procedure

To search for an approval workflow group:

1. Click the **Admin** link in the **Application** toolbar.
A list appears.
2. From the **Admin** menu, select **A** and then click **Approval Workflow Group**.
The **Approval Workflow Group** screen appears.
3. Enter the search criteria in the **Search Approval Workflow Group** zone.

Note: ORMB search engine supports wildcard search, where you can substitute the percentage (%) symbol as a stand in for any word or letter in a search criteria. You can use the ‘%’ wildcard character in all input fields except the date and ID fields. The ‘%’ wildcard character is suffixed automatically at the end of the partial search criteria. Therefore, you may or may not specify the wildcard character at the end of the partial search criteria. However, you have to prefix the wildcard character manually wherever required.

4. Click **Search**.

A list of approval workflow groups that meet the search criteria appear in the **Search Results** section.

Related Topics

For more information on...	See...
Search Approval Workflow Group screen	Approval Workflow Group (Used for Searching) on page 830

For more information on...	See...
Search Approval Workflow Group zone	Search Approval Workflow Group on page 830

Viewing the Approval Workflow Group Details

Procedure

To view the details of an approval workflow group:

1. Search for the approval workflow group in the **Approval Workflow Group** screen.
2. In the **Search Results** section, click the link in the **Description** column corresponding to the approval workflow group whose details you want to view.

The **Approval Workflow Group** screen appears. It consists of the **Main** tab with the following zone:

- [Approval Workflow Group](#) on page 839
3. View the details of the approval workflow group in the **Approval Workflow Group** zone.

Related Topics

For more information on...	See...
How to search for an approval workflow group	Searching for an Approval Workflow Group on page 831
Approval Workflow Group screen	Approval Workflow Group (Used for Searching) on page 830
Approval Workflow Group zone	Search Approval Workflow Group on page 830

Defining an Approval Workflow Group

Prerequisites

To define an approval workflow group, you should have:

- Input and Display UI maps created in the application in case you want to use custom UI maps.
- Dependency, Approval, and Approval Post Processing algorithms defined in the application in case you want to use any of them.

Note: Before you define an approval workflow group for the User BO, you need to attach the **C1-APPTXNBAS** algorithm on the **Audit** algorithm spot of the business object belonging to the USER-SC MO, and not the USER MO.

Procedure

To define an approval workflow group:

1. Click the **Admin** link in the **Application** toolbar.
A list appears.
2. From the **Admin** menu, Select **A** and then click **Approval Workflow Group**.
The **Approval Workflow Group** screen appears.
3. Click the **Add** button in the **Page Title** area of **Approval Workflow Group** screen.

The **Approval Workflow Group** screen appears. It contains the following sections:

- **Main** - Used to specify basic details about the approval workflow group.
- **Business Objects and Group BO Relation** - Used to add business objects and define group BO Relation for the approval workflow group.

The **Main** section contains the following:

Field Name	Field Description	Mandatory (Yes or No)
Approval Transaction Type	Used to indicate the transaction type to which the approval workflow group belongs.	Yes
Approval Workflow Group	Used to specify the approval workflow group.	Yes
Description	Used to specify the approval workflow group with a particular description.	Yes
Display UI Map	<p>Used to specify the UI map that you want to use for viewing data of the business objects within the approval workflow group.</p> <p>Note: You can search for a UI map, code, and an algorithm by clicking the Search icon (🔍) corresponding to the Display UI Map field.</p> <p>Note: If you clear the Display UI Map field, you need to either manually specify the UI map or automatically regenerate the UI map by clicking the Regenerate UI Maps icon corresponding to the group in the Approval Workflow Settings screen.</p>	No
Input UI Map	<p>Used to specify the UI map that you want to use for modifying data of the business objects within the approval workflow group.</p> <p>Note: You can search for a UI map, code, and an algorithm by clicking the Search icon (🔍) corresponding to the Input UI Map field.</p> <p>Note: If you clear the Input UI Map field, you need to either manually specify the UI map or automatically regenerate the UI map by clicking the Regenerate UI Maps icon corresponding to the group in the Approval Workflow Settings screen.</p>	No
Dependency Algorithm	<p>Used to specify the algorithm that will be triggered before creating the approval workflow group.</p> <p>Note: You can search for a Input UI map, code, and an algorithm by clicking the Search icon (🔍) corresponding to the Dependency Algorithm field.</p> <p>Note: This algorithm can be used to check all prerequisites before creating the approval workflow group.</p>	No
Approval Algorithm	Used to specify the algorithm that will be triggered after the approval workflow group is approved by the approver at the last level in the hierarchy. The following approval algorithms are shipped with ORMB:	No

Field Name	Field Description	Mandatory (Yes or No)
	<ul style="list-style-type: none"> • C1-APPROD - This approval algorithm is used for the C1PRODUCT group, which is shipped with ORMB. • C1-APPPL - This approval algorithm is used for the C1PRICELST group, which is shipped with ORMB. • C1-APPASG - This approval algorithm is used for the C1PRICEASG group, which is shipped with ORMB. • C1-APPALG - This is a standard approval algorithm that you can use for approval workflow groups where custom logic is not required. <p>You can also create your own approval algorithms for custom UIs.</p> <p>Note: You can search for a Input UI map, code, and an algorithm by clicking the Search icon (🔍) corresponding to the Approval Algorithm field.</p>	
Approval Post Processing Algorithm	<p>Used to specify the algorithm that will be triggered after the changes (which are approved by all approvers' in the hierarchy) are committed to the database.</p> <p>Note: You can search for a Input UI map, code, and an algorithm by clicking the Search icon (🔍) corresponding to the Approval Post Processing Algorithm field.</p>	No
Transaction Creation Algorithm	<p>Used to specify the algorithm that will create approval workflow group. The following transaction creation algorithms are shipped with ORMB:</p> <ul style="list-style-type: none"> • C1-APPASGCR - Used to create approval workflow group for price assignment. • C1-AXPROD - Used to create approval workflow group for price item. • C1-AXUSR - Used to create approval workflow group for user. • C1-IGCREATE - Used to create approval workflow group for invoicing group. • C1-AXCREATE - This is a standard transaction creation algorithm that you can use to create approval workflow group for most of the base objects. <p>You can also create your own transaction creation algorithms for custom UIs.</p> <p>In case of the base UIs, this algorithm is only used while modifying or resolving a group. The initial approval transaction creation for base UIs takes place through the Audit algorithm attached on the business object.</p>	Yes

Field Name	Field Description	Mandatory (Yes or No)
	<p>Note: You can search for a Input UI map, code, and an algorithm by clicking the Search icon (🔍) corresponding to the Transaction Creation Algorithm field.</p>	
Data Retrieval Algorithm	<p>Used to specify the algorithm that will be triggered to retrieve the original data of the business objects within the approval workflow group. This will help an approver to compare the original and new data in case where the submitter action is Update (UPD). The following data retrieval algorithms are shipped with ORMB:</p> <ul style="list-style-type: none"> • C1-APPIGDR - Used to retrieve data for invoicing group. • C1-AXPRICEOV - Used to retrieve data for price assignment. • C1_APPDATA - This is a standard data retrieval algorithm that you can use to retrieve data for most of the base objects. <p>You can also create your own data retrieval algorithms for custom UIs.</p> <p>Note: You can search for a Input UI map, code, and an algorithm by clicking the Search icon (🔍) corresponding to the Data Retrieval Algorithm field.</p>	Yes
Information Algorithm	<p>Used to specify the algorithm information.</p> <p>Note: You can search for a Input UI map, code, and an algorithm by clicking the Search icon (🔍) corresponding to the Approval Post Processing Algorithm field.</p>	No
Compare Map	<p>Used to specify the customized Display UI map that you want to use for the approval workflow group. It overrides the UI map specified in the Display UI Map field.</p> <p>Note: You can search for a Input UI map, code, and an algorithm by clicking the Search icon (🔍) corresponding to the Approval Post Processing Algorithm field.</p>	No
Input Script	<p>Used to specify the customized Input UI map that you want to use for the approval workflow group. It overrides the UI map specified in the Input UI Map field.</p> <p>Note: You can search for a Input UI map, code, and an algorithm by clicking the Search icon (🔍) corresponding to the Approval Post Processing Algorithm field.</p>	No

4. Enter the required details.
5. Add business objects and group BO relation with the approval workflow group, if required.

6. Click **Save**.

The approval workflow group is defined.

Related Topics

For more information on...	See...
Approval Workflow Group screen	Approval Workflow Group (Used for Viewing) on page 839
Approval Workflow Group zone	Approval Workflow Group on page 839
How to add business objects and group BO relation	Adding a Business Object on page 836

Adding a Business Object

Prerequisites

To add a business object in the approval workflow group, you should have:

- Business object and approval workflow group created in the application.

Procedure

To add a business object in the approval workflow group:

1. Click the **Admin** link in the **Application** toolbar.

A list appears.

2. From the **Admin** menu, Select **A**, and then click **Approval Workflow Group**.

The **Approval Workflow Group** screen appears.

3. Click the **Add** button in the page-title area of the **Approval Workflow Group** screen.

The **Approval Workflow Group** screen appears. It contains following sections:

- **Main** - Used to specify basic details of the approval workflow group.
- **Business Objects and Group BO Relation** - Used to specify the fields that allow to define business and parent objects and link them with the approval workflow group.

The **Business Objects and Group BO Relation** section contains following fields:

Field Name	Field Description	Mandatory (Yes or No)
Business Object	Used to specify the Business Object Code that you want to include in the Approval Workflow Group.	Yes
Reference ID 1	Used to specify the XPATH key of the field in the business object that you want to display in the approval transaction information string.	Yes
Reference ID 2	Used to specify the XPATH key of the field in the business object that you want to display in the approval transaction information string.	Yes
Reference ID 3	Used to specify the XPATH key of the field in the business object that you want to display in the approval transaction information string.	Yes
Reference ID 4	Used to specify the XPATH key of the field in the business object that you want to display in the approval transaction information string.	Yes

Field Name	Field Description	Mandatory (Yes or No)
Reference Key 1 Foreign	Used to specify the XPATH key of the field in the business object that you want to use for validating whether duplicate approval transaction exists in the system.	No
Reference Key 2 Foreign	Used to specify the XPATH key of the field in the business object that you want to use for validating whether duplicate approval transaction exists in the system.	No
Reference Key 3 Foreign	Used to specify the XPATH key of the field in the business object that you want to use for validating whether duplicate approval transaction exists in the system.	No
Reference Key 4 Foreign	Used to specify the XPATH key of the field in the business object that you want to use for validating whether duplicate approval transaction exists in the system.	No
Reference Key 5 Foreign	Used to specify the XPATH key of the field in the business object that you want to use for validating whether duplicate approval transaction exists in the system.	No
Reference Key 6 Foreign	Used to specify the XPATH key of the field in the business object that you want to use for validating whether duplicate approval transaction exists in the system.	No
List	Used to indicate whether the group contains one or multiple instance of the business object. For example, if you want to create a group that contains multiple account objects, you need to set this flag for the Account BO to True. If you want to create a group that contains single instance of the business object, you must set this flag for the business object to False.	Yes
Parent Object Business	Used to specify the parent business object. This should be one of the business objects within the group.	No
From Key	Used to specify the XPATH key of the field or list of fields in the parent business object.	No
To Key	Used to specify the XPATH key of the field or list of fields in the current business object.	No

Note: You can search for a business object and parent business object, by clicking the **Search** (🔍) icon placed corresponding to the **Business Object** field.

4. If you want to define more than one business and parent business object for the approval workflow group, click the **Add** (+) icon placed corresponding to the field.
5. Enter the required details in **Main** and **Business Objects and Group BO Relation** sections.
6. Click **Save**

The business object is added in the approval workflow group.

Note: When you add business objects in an approval workflow group, you need to regenerate the Input and Display UI maps by clicking the **Regenerate UI Maps** (🔄) icon corresponding to the group in the **Approval Workflow Settings** screen. You must do this when you are using automatically generated UI maps, and not otherwise.

Related Topics

For more information on...	See...
Approval Workflow Group screen	Approval Workflow Group (Used for Viewing) on page 839
Approval Workflow Group zone	Approval Workflow Group on page 839

Defining a Group BO Relation

Prerequisites

To define a relationship between business object in the approval workflow group, you should have:

- Business objects added in the approval workflow group.

Procedure

To define a relationship between business objects in the approval workflow group:

1. Click the **Admin** link in the **Application** toolbar.
A list appears.
2. From the **Admin** menu, Select **A** and then click **Approval Workflow Group**.
The **Approval Workflow Group** screen appears.
3. Search for an approval workflow group in the **Approval Workflow Group** screen.
4. In the **Search Results** section, click the link in the **Description** column corresponding to the approval workflow group.
5. The **Approval Workflow Group** screen appears. It contains following sections:
 - **Main** - Used to specify basic details of the approval workflow group.
 - **Business Objects and Group BO Relation** - Used to specify the fields that allow to define business and parent objects, and link them with the approval workflow group.
6. Define and edit the approval workflow group details from the **Main** section, if required.
7. If you only want to define a business object, enter the required details in the **Business Objects and Group BO Relation** section.
8. If you want to define a group BO relation with the business object, enter the required details in the following fields.
 - a) **Parent Business Object**
 - b) **From Key**
 - c) **To Key**

Note: If you want to define more than one business or parent object, click the **Add** (+) icon and then repeat step 2. However, if you want to remove a business or parent object, click the **Delete** (🗑) icon corresponding to the business or parent object field.

9. Click **Save**.

The business object is defined, and its relationship with the parent object is also defined in the approval workflow group.

Related Topics

For more information on...	See...
How to define an approval workflow group	Defining an Approval Workflow Group on page 832

For more information on...	See...
How to define an approval workflow business object	Adding a Business Object on page 836
How to define an approval workflow group BO object	Defining a Group BO Relation on page 838

Approval Workflow Group (Used for Viewing)

Once you define an approval workflow group, the **Approval Workflow Group** screen allows you to:

- Edit the details of an approval workflow group
- Edit the details of business objects and group business object relation
- Delete an approval workflow group
- Delete a business object and a group business object relation
- View the details of an approval workflow group

This screen consists of the following zone:

- [Approval Workflow Group](#) on page 839

Approval Workflow Group

The **Approval Workflow Group** zone displays the details of the approval workflow group. It contains the following sections:

- **Main** - Displays basic information about the approval workflow group. It contains the following fields:

Field Name	Field Description
Approval Workflow Group	Displays the name of the approval workflow group.
Description	Displays the description of the approval workflow group.
Display UI Map	Indicates the UI map that will be used for viewing data of the business objects within the approval workflow group. Note: It has a link. On clicking the link, the UI Map screen appears where you can view the details of the respective UI Map.
Input UI Map	Indicates the UI map that will be used for modifying data of the business objects within the approval workflow group. Note: It has a link. On clicking the link, the UI Map screen appears where you can view the details of the respective UI Map.
Dependency Algorithm	Indicates the algorithm that will be triggered before creating the approval workflow request. Note: This algorithm can be used to check all prerequisites before creating the approval workflow request.
Approval Algorithm	Indicates the algorithm that will be triggered after the approval workflow request is approved by the approver at the last level in the hierarchy.

Field Name	Field Description
Approval Post Processing Algorithm	Indicates the algorithm that will be triggered after the changes (which are approved by all approvers in the hierarchy) are committed to the database.
Transaction Creation Algorithm	Indicates the algorithm that will create approval workflow requests. Note: It has a link. On clicking the link, the Algorithm screen appears where you can view the details of the respective algorithm.
Data Retrieval Algorithm	Indicates the algorithm that will be triggered to retrieve the original data of the business objects within the approval workflow group. This will help an approver to compare the original and new data in case where the submitter action is Update (UPD). Note: It has a link. On clicking the link, the Algorithm screen appears where you can view the details of the respective algorithm.
Information Algorithm	Indicates the Approval Transaction information from the Approval Transactions that are created for a particular entity, based on the inputs of the XPath paths provided in the Reference IDs.
Compare Map	Indicates the customized Display UI map that you want to use for the approval workflow group. It overrides the UI map specified in the Display UI Map field.
Input Script	Indicates the customized Input UI map that you want to use for the approval workflow group. It overrides the UI map specified in the Input UI Map field.

- **Record Actions** - This section contains the following buttons:

Button Name	Button Description
Edit	Used to define, edit the approval workflow group. It is also used to delete the business objects and group BO relation.
Delete	Used to delete an approval workflow group.

- **Record Information** - This section contains the following fields:

Field Name	Field Description
Business Object	Indicates the business object using which the approval workflow group is created. In addition, a context menu appears corresponding to this field which helps in navigating to other screens in the application. Note: It has a link. On clicking the link, the Business Object screen appears where you can view the details of the respective business object.

- **Business Objects And Group BO Relation** - The Business Objects And Group BO Relation contains the following fields:

Field Name	Field Description
Business Object	Indicates the Business Object that you want to include in the Approval Workflow Group.
Reference ID 1	Indicates the XPATH key of the field in the business object that you want to display in the approval transaction information string.

Field Name	Field Description
Reference ID 2	Indicates the XPATH key of the field in the business object that you want to display in the approval transaction information string.
Reference ID 3	Indicates the XPATH key of the field in the business object that you want to display in the approval transaction information string.
Reference ID 4	Indicates the XPATH key of the field in the business object that you want to display in the approval transaction information string.
Reference Foreign Key 1	Indicates the XPATH key of the field in the business object that you want to use for validating whether duplicate approval transaction exists in the system.
Reference Foreign Key 2	Indicates the XPATH key of the field in the business object that you want to use for validating whether duplicate approval transaction exists in the system.
Reference Foreign Key 3	Indicates the XPATH key of the field in the business object that you want to use for validating whether duplicate approval transaction exists in the system.
Reference Foreign Key 4	Indicates the XPATH key of the field in the business object that you want to use for validating whether duplicate approval transaction exists in the system.
Reference Foreign Key 5	Indicates the XPATH key of the field in the business object that you want to use for validating whether duplicate approval transaction exists in the system.
Reference Foreign Key 6	Indicates the XPATH key of the field in the business object that you want to use for validating whether duplicate approval transaction exists in the system.
List	Indicates whether the group contains one or multiple instance of the business object. For example, if you want to create a group that contains multiple account objects, you need to set this flag for the Account BO to True. If you want to create a group that contains single instance of the business object, you must set this flag for the business object to False.
Parent Business Object	Indicates the parent business object. This should be one of the business objects within the group.
From Key	Indicates the XPATH key of the field or list of fields in the parent business object.
To Key	Indicates the XPATH key of the field or list of fields in the current business object.

Editing an Approval Workflow Group

Procedure

To edit an approval workflow group:

1. Search for the approval workflow group in the **Approval Workflow Group**.
2. In the **Search Results** section, click the link in the **Description** column corresponding to the approval workflow group whose details you want to edit.

The **Approval Workflow Group** screen appears.

3. Click the **Edit** button in the **Approval workflow Group** zone.

The **Approval Workflow Group** screen appears.

4. Modify the details of the approval workflow group, if required.
5. Define, edit, or remove business objects and group BO relation from the approval workflow group, if required.
6. Click **Save**.

The changes made to the approval workflow group are saved.

Related Topics

For more information on...	See...
How to search for an approval workflow group	Searching for an Approval Workflow Group on page 831
How to add a business object	Adding a Business Object on page 836
How to define a Group BO Relation	Defining a Group BO Relation on page 838

Deleting an Approval Workflow Group**Procedure**

To delete an approval workflow group:

1. Search for the approval workflow group in the **Search Approval Workflow Group** screen.
2. In the **Search Results** section, click the link in the **Description** column corresponding to the approval workflow group that you want to delete.
3. Click the **Delete** button in the **Approval Workflow Group** zone.

A message appears confirming whether you want to delete the approval workflow group.

4. Click **OK**.

The approval workflow group is deleted.

Related Topics

For more information on...	See...
How to search for an approval workflow group	Searching for an Approval Workflow Group on page 831

Editing a Business Object**Procedure**

To edit a business object in the approval workflow group:

1. From the **Admin** menu, select **A** and then click **Approval Workflow Group**.

The **Approval Workflow Group** screen appears.

2. Search for an approval workflow group in the **Search Approval Workflow Group** zone.
3. In the **Search Results** section, click the link in the **Description** column corresponding to the approval workflow group whose details you want to edit.
4. The **Approval Workflow Group** zone appears. Click the **Edit** button from **Record Action** sections.

The **Approval Workflow Group** screen appears. It contains the following sections:

- **Main** - Used to specify the basic details of the approval workflow group.
- **Business Objects and Group BO Relation** - Used to specify the fields that allow to define business objects and link them with the approval workflow group

The **Business Objects and Group BO Relation** section contains following fields:

Field Name	Field Description	Mandatory (Yes or No)
Business Object	Displays the Business Object Code that is included in the Approval Workflow Group.	Yes

Field Name	Field Description	Mandatory (Yes or No)
Reference ID 1	Displays the XPATH key of the field in the business object that you want to use as criteria for searching approval workflow groups.	No
Reference ID 2	Displays the XPATH key of the field in the business object that you want to use as criteria for searching approval workflow groups.	No
Reference ID 3	Displays the XPATH key of the field in the business object that you want to use as criteria for searching approval workflow groups.	No
Reference ID 4	Displays the XPATH key of the field in the business object that you want to use as criteria for searching approval workflow groups.	No
Reference Foreign Key 1	Displays the XPATH key of the field in the business object that you want to use for validating whether duplicate approval transaction exists in the system.	No
Reference Foreign Key 2	Displays the XPATH key of the field in the business object that you want to use for validating whether duplicate approval transaction exists in the system.	No
Reference Foreign Key 3	Displays the XPATH key of the field in the business object that you want to use for validating whether duplicate approval transaction exists in the system.	No
Reference Foreign Key 4	Displays the XPATH key of the field in the business object that you want to use for validating whether duplicate approval transaction exists in the system.	No
Reference Foreign Key 5	Displays the XPATH key of the field in the business object that you want to use for validating whether duplicate approval transaction exists in the system.	No
Reference Foreign Key 6	Displays the XPATH key of the field in the business object that you want to use for validating whether duplicate approval transaction exists in the system.	No
List	Indicates whether the group contains one or multiple instance of the business object. For example, if you want to create a group that contains multiple account objects, you need to set this flag for the Account BO to True. If you want to create a group that contains single instance of the business object, you must set this flag for the business object to False.	Yes
Parent Business Object	Used to specify the parent business object. This should be one of the business objects within the group.	No
From Key	Display the XPATH key of the field or list of fields in the parent business object.	No
To Key	Display the XPATH key of the field or list of fields in the current business object.	No

Note: You can search for a business object or parent business object by clicking the **Search** (🔍) icon placed corresponding to the **Business Object** and **Parent Business Object** field.

5. If you want to define more than one business object or parent object for the approval workflow group, click the **Add (+)** icon placed corresponding to the field.
6. Enter the required details in **Main** and **Business Objects and Group BO Relation** sections.
7. Click **Save**.

The changes made to the business object in approval workflow group are saved.

Note: When you change business objects in an approval workflow group, you need to regenerate the Input and Display UI maps by clicking the **Regenerate UI Maps** () icon corresponding to the group in the **Approval Workflow Settings** screen. You must do this when you are using automatically generated UI maps, and not otherwise.

Related Topics

For more information on...	See...
Approval Workflow Group screen	Approval Workflow Group (Used for Searching) on page 830
Approval Workflow Group zone	Search Approval Workflow Group on page 830
How to delete a Business Object	Deleting a Business Object on page 844

Deleting a Business Object

Procedure

To delete a business object in the approval workflow group:

1. Search for an approval workflow group in the **Approval Workflow Group** screen.
2. In the **Search Results** section, click the link in the **Description** column corresponding to the approval workflow group.

The **Approval Workflow Group** zone appears.

3. In the View section of **Approval Workflow Group**, click the **Edit** button.

The **Approval Workflow Group** window appears.

4. In the **Business Objects and Group BO Relation** zone, click the **Delete** () icon corresponding to the business object that you want to delete.
5. Click **Save**.

The business object is deleted from the approval workflow group.

Related Topics

For more information on...	See...
Approval Workflow Group screen	Approval Workflow Group (Used for Searching) on page 830
Approval Workflow Group zone	Search Approval Workflow Group on page 830

Editing a Group BO Relation

Procedure

To edit the business object's relationship details in the approval workflow group:

1. If required, filter the approval workflow group in the **Approval Workflow Group** screen.
2. In the **Search Results** section, click the link in the **Description** column corresponding to the approval workflow group.

The **Approval Workflow Group** screen appears. It contains following two sections:

- **Main** - Displays the basic details of the approval workflow group.
 - **Business Objects and Group BO Relation** - Displays the fields that allow to define or edit business objects, and link them with the approval workflow group.
3. If required, define and edit the approval workflow group details from the **Main** section.
 4. The **Business Objects and Group BO Relation** section contains following fields:

Field Name	Field Description	Mandatory (Yes or No)
Business Object	Used to specify the business object that you want to add in the approval workflow group.	Yes
Reference ID 1	Used to indicate the XPATH key of the field that you want to concatenate in the approval transaction information string.	No
Reference ID 2	Used to indicate the XPATH key of the field that you want to concatenate in the approval transaction information string.	No
Reference ID 3	Used to indicate the XPATH key of the field that you want to concatenate in the approval transaction information string.	No
Reference ID 4	Used to indicate the XPATH key of the field that you want to concatenate in the approval transaction information string.	No
Reference Foreign Key 1	Used to indicate the XPATH key of the field that you want to use while validating whether a duplicate approval transaction does not exist in the system.	No
Reference Foreign Key 2	Used to indicate the XPATH key of the field that you want to use while validating whether a duplicate approval transaction does not exist in the system.	No
Reference Foreign Key 3	Used to indicate the XPATH key of the field that you want to use while validating whether a duplicate approval transaction does not exist in the system.	No
Reference Foreign Key 4	Used to indicate the XPATH key of the field that you want to use while validating whether a duplicate approval transaction does not exist in the system.	No
Reference Foreign Key 5	Used to indicate the XPATH key of the field that you want to use while validating whether a duplicate approval transaction does not exist in the system.	No
Reference Foreign Key 6	Used to indicate the XPATH key of the field that you want to use while validating whether a duplicate approval transaction does not exist in the system.	No
List	Indicates whether the group contains one or multiple instance of the business object. For example, if you want to create a group that contains multiple account objects, you need to set this flag for the Account BO to True. If you want to create a group that contains single	Yes

Field Name	Field Description	Mandatory (Yes or No)
	instance of the business object, you must set this flag for the business object to False.	
Parent Business Object	Displays the parent business object. This should be one of the business objects within the group.	No
From Key	Displays the XPATH key of the field or list of fields in the parent business object.	No
To Key	Displays the XPATH key of the field or list of fields in the current business object.	No

Note: You can search for a parent business object by clicking the **Search** (🔍) icon placed corresponding to the field. You can also define a new parent business object by clicking the **Add** (+) icon placed corresponding to the field.

5. Modify the required details in **Business Objects and Group BO Relation** section.
6. Click **Save**.

The changes made to business object's relationship are saved in the approval workflow group.

Related Topics

For more information on...	See...
Search Approval Workflow Group screen	Approval Workflow Group (Used for Searching) on page 830
Search Approval Workflow Group zone	Search Approval Workflow Group on page 830
How to edit a Business Object	Editing a Business Object on page 842
How to edit a Group BO Relation	Editing a Group BO Relation on page 844

Deleting a Group BO Relation

Procedure

To delete the business object's relationship details in the approval workflow group:

1. If required, filter the approval workflow group in the **Approval Workflow Group** screen.
2. In the **Search Results** section, click the link in the **Description** column corresponding to the approval workflow group.
3. The **Approval Workflow Group** screen appears.
4. Click the **Edit** button in the **Record Actions** zone.
The **Approval Workflow Group** screen appears.
5. In the **Business Objects and Group BO Relation** section, click the **Delete** (🗑️) icon appearing next to the Business Object that you want to delete.
6. Click **Save**

The business object's relationship details are deleted from the approval workflow group.

Related Topics

For more information on...	See...
Approval Workflow Group screen	Approval Workflow Group (Used for Searching) on page 830
Approval Workflow Group zone	Search Approval Workflow Group on page 830
How to delete a Business Object	Deleting a Business Object on page 844
How to delete a Group BO Relation	Deleting a Group BO Relation on page 846

Approval Workflow Chain (Used for Searching)

The **Approval Workflow Chain** screen allows you to search for approval workflow chain using various search criteria. Through this screen, you can navigate to the following screen:

- [Approval Workflow Chain \(Used for Viewing\)](#) on page 850

This screen consists of the following zone:

- [Search Approval Workflow Chain](#) on page 847

Search Approval Workflow Chain

The **Search Approval Workflow Chain** zone allows you to search for an approval workflow chain using various search criteria. It contains the following two sections:

- **Search Criteria** - The **Search Criteria** section contains the following fields:

Field Name	Field Description	Mandatory (Yes or No)
Approval Workflow Chain	Used to search a particular approval workflow chain.	No
Description	Used to search approval workflow chains with a particular description.	No

- **Search Results** - On clicking the **Search** button, the search results appear based on the specified search. The **Search Results** section contains the following columns:

Column Name	Column Description
Approval Workflow Chain	Displays the approval workflow chain.
Description	Displays the description of the approval workflow chain. Note: It has a link. On clicking the link, the Approval Workflow Chain screen appears where you can view the details of the respective approval workflow chain.

Note: You must specify at least one search criterion while searching for an approval workflow chain.

Related Topics

For more information on...	See...
How to search for an approval workflow chain	Searching for an Approval Workflow Chain on page 848
How to view the details of an approval workflow chain	Viewing the Approval Workflow Chain Details on page 848

Searching for an Approval Workflow Chain

Procedure

To search the approval workflow chain:

1. Click the **Admin** link in the **Application** toolbar.
A list appears.
2. From the **Admin** menu, select **A** and then click **Approval Workflow Chain**.
The **Approval Workflow Chain** screen appears.
3. Enter the search criteria in the **Search Approval Workflow Chain** zone.

ORMB search engine supports wildcard search, where you can substitute the percentage (%) symbol as a stand in for any word or letter in a search criteria. You can use the ‘%’ wildcard character in all input fields except the date fields. The ‘%’ wildcard character is suffixed automatically at the end of the partial search criteria. Therefore, you may or may not specify the wildcard character at the end of the partial search criteria. However, you have to prefix the wildcard character manually wherever required.

4. Click **Search**.

A list of approval workflow chains that meet the search criteria appears in the **Search Results** section.

Related Topics

For more information on...	See...
Search Approval Workflow Chain zone	Search Approval Workflow Chain on page 847

Viewing the Approval Workflow Chain Details

Procedure

To view the details of an approval workflow chain:

1. Search for the approval workflow chain in the **Approval Workflow Chain** screen.
2. In the **Search Results** section, click the link in the **Description** column corresponding to the approval workflow chain whose details you want to view.

The **Approval Workflow Chain** screen appears. It contains the following zone:

- [Approval Workflow Chain](#) on page 850

3. View the details of the approval workflow chain in the **Approval Workflow Chain** zone.

Related Topics

For more information on...	See...
How to search an approval workflow chain	Searching for an Approval Workflow Chain on page 848

Defining an Approval Workflow Chain

Prerequisites

To define an approval workflow chain, you should have:

- The To Do role and To Do type defined in the application.
- Action algorithms defined in the application, in case you want to use any of them.

Procedure

To define an approval workflow chain:

1. Click the **Admin** link in the **Application** toolbar.
A list appears.
2. From the **Admin** menu, select **A** and then click **Approval Workflow Chain**.
The **Approval Workflow Chain** screen appears.
3. Click the **Add** button in the **Page Title** area of the **Approval Workflow Chain** screen.

The **Approval Workflow Chain** screen appears. It contains the following sections:

- **Main** - Used to specify basic details of the approval workflow chain.
- **Approval Levels** - Used to specify a level in the approval workflow chain.

The **Main** section contains the following fields:

Field Name	Field Description	Mandatory (Yes or No)
Approval Workflow Chain	Used to specify the approval workflow chain	Yes
Description	Used to specify the description for the approval workflow chain	Yes
To Do Role To Resolve	Used to specify the To Do Role to indicate the users who will receive a notification when the approval transactions are rejected by an approver at any level in the hierarchy.	Yes

4. Enter the required details.
5. Define approval levels for the approval workflow chain, if required.
6. Click **Save**.

The approval workflow chain is defined.

Related Topics

For more information on...	See...
Approval Workflow Chain screen	Approval Workflow Chain (Used for Searching) on page 847
Approval Workflow Chain zone	Approval Workflow Chain on page 850
How to define Approval Levels for an approval workflow chain	Defining Approval Levels for an Approval Workflow Chain on page 849

Defining Approval Levels for an Approval Workflow Chain**Prerequisites**

To define approval levels in the approval workflow chain, you should have:

- The To Do Role and To Do Type defined in the application.
- Action algorithms defined in the application, in case you want to use any of them.

Procedure

To define an approval levels for an approval workflow chain:

1. Ensure that the **Approval Levels** section is expanded when you are defining or editing an approval workflow chain.

The **Approval Levels** section contains the following fields

Field Name	Field Description	Mandatory (Yes or No)
Action Algorithm	Used to specify the additional action that you want the system to perform apart from generating a notification when the approver approves or rejects the request.	Yes
	Note: You can search for an action algorithm by clicking the Search (🔍) icon corresponding to the Action Algorithm field.	
Approver To Do Role	Used to specify the To Do role to indicate the users who will either approve or reject the request at this level in the hierarchy.	Yes
	Note: You can search for an approver to do role by clicking the Search (🔍) icon corresponding to the Approver To Do Role field.	
Approver To Do Type	Used to specify the type of notification that you want to generate when the approver approves or rejects the request.	Yes
	Note: You can search for an approver to do type by clicking the Search (🔍) icon corresponding to the Approver To Do Type field.	

2. Enter the required details in the **Approval Levels** section.
3. If you want to define more than one approval level for the approval workflow chain, click the **Add** (+) icon and then repeat step 2. However, if you want to remove a approval level from the approval workflow chain, click the **Delete** (🗑️) icon corresponding to the approval level.

Related Topics

For more information on...	See...
How to define an approval workflow chain	Defining an Approval Workflow Chain on page 848
How to edit an approval workflow chain	Editing an Approval Workflow Chain on page 851

Approval Workflow Chain (Used for Viewing)

Once you define an approval workflow chain, the **Approval Workflow Chain** screen allows you to:

- View the details of an approval workflow chain
- Edit an approval workflow chain
- Delete an approval workflow chain

This screen contains the following zone:

- [Approval Workflow Chain](#) on page 850

Approval Workflow Chain

The **Approval Workflow Chain** zone displays the details of the approval workflow chain. It contains the following sections:

- **Main** - Displays basic information about the approval workflow chain. It contains the following fields:

Field Name	Field Description
Approval Workflow Chain	Displays the approval workflow chain and levels.
Description	Displays the description of the approval workflow chain and levels.
To Do Role To Resolve	Displays the description of To Do Role role type.

- **Approval Levels** - Displays the levels defined in the approval workflow chain.

Field Name	Field Description
Action Algorithm	Indicates the additional action that the system will perform apart from generating a notification when the approver approves or rejects the request.
Level	Indicates the level in the hierarchy.
Approver To Do Role	Indicates that the users with the specified To Do role will either approve or reject the request at this level in the hierarchy.
Approval To Do Type	Indicates the type of notification that will be generated when the approver approves or rejects the request.

- **Record Actions** - This section contains the following buttons:

Button Name	Button Description
Edit	Used to edit and delete the approval workflow chain and approval levels.
Delete	Used to delete the approval workflow chain.

- **Record Information** - This section contains the following field:

Field Name	Field Description
Business Object	Indicates the business object using which the approval workflow chain is created. In addition, a context menu appears corresponding to this field which helps in navigating to other screens in the application.
	Note: It has a link. On clicking the link, the Business Object screen appears where you can view the details of the respective business object.

Editing an Approval Workflow Chain

Procedure

To edit an approval workflow chain:

1. Search for an approval workflow chain in the **Search Approval Workflow Chain** screen.
2. In the **Search Results** section, click the link in the **Description** column corresponding to the approval workflow chain whose details you want to edit.

The **Approval Workflow Chain** screen appears.

3. Click the **Edit** button in the **Approval Workflow Chain**.

The **Approval Workflow Chain** screen appears.

- **Main** - Used to specify the basic details of the approval workflow chain. It contains the following fields:

Field Name	Field Description	Mandatory (Yes or No)
Approval Workflow Chain	Displays the approval workflow chain.	Yes
Description	Displays the description for the approval workflow chain.	Yes
To Do Role To Resolve	Displays the To Do role to indicate the users who will be sent a notification when the approval workflow request is rejected by an approver at any level in the hierarchy.	Yes

- **Approval Levels** - Used to specify a level in the approval workflow chain. It contains the following fields:

Field Name	Field Description	Mandatory (Yes or No)
Action Algorithm	Displays the additional action that you want the system to perform apart from generating a notification when the approver approves or rejects the request.	Yes
Approver To Do Role	Displays the To Do role to indicate the users who will either approve or reject the request at this level in the hierarchy.	Yes
Approval To Do Type	Displays the type of notification that you want to generate when the approver approves or rejects the request.	Yes

4. Modify the required details in the **Main** section.
5. Edit, or remove approval levels from the approval workflow chain, if required.
6. Click **Save**.

The changes made to the approval workflow chain screen are saved.

Related Topics

For more information on...	See...
Approval Workflow Chain screen	Approval Workflow Chain (Used for Viewing) on page 850
Approval Workflow Chain zone	Approval Workflow Chain on page 850
How to define approval levels for an approval workflow chain	Defining an Approval Workflow Chain on page 848

Deleting an Approval Workflow Chain

Procedure

To delete an approval workflow chain:

1. Search for the approval workflow chain in the **Search Approval Workflow Chain** screen.
2. In the **Search Results** section, click the link in the **Description** column corresponding to the approval workflow chain that you want to delete.

The **Approval Workflow Chain** screen appears.

3. Click the **Delete** button in the **Approval Workflow Chain** zone.
A message appears confirming whether you want to delete the approval workflow chain.
4. Click **OK**.

The approval workflow chain is deleted.

Related Topics

For more information on...	See...
How to search for an approval workflow chain	Searching for an Approval Workflow Chain on page 848
Approval Workflow Chain screen	Approval Workflow Chain (Used for Viewing) on page 850
Approval Workflow Chain zone	Approval Workflow Chain on page 850

Approval Workflow Criterion Type (Used for Searching)

The **Approval Workflow Criterion Type** screen allows you to search for an approval workflow criterion type using various search criteria. Through this screen, you can navigate to the following screen:

- [Approval Workflow Criterion Type \(Used for Viewing\)](#) on page 856

This screen consists of the following zone:

- [Search Approval Workflow Criterion Type](#) on page 853

Search Approval Workflow Criterion Type

The **Search Approval Workflow Criterion Type** zone allows you to search for an approval workflow criterion type using various search criteria. It contains the following two sections:

- **Search Criteria** - The **Search Criteria** section contains the following fields:

Field Name	Field Description	Mandatory (Yes or No)
Approval Workflow Criterion Type	Used to search a particular approval workflow criterion type.	Yes
Description	Used to specify the description for the approval workflow criteria type.	No

Note: You must specify at least one search criterion while searching for an approval workflow criterion type.

- **Search Results** - On clicking the **Search** button, the search results are filtered based on the specified search criteria. The **Search Results** section contains the following columns:

Column Name	Column Description
Approval Workflow Criterion Type	Displays the approval workflow criterion type.
Description	Displays the description of the approval workflow criterion type.

Related Topics

For more information on...	See...
How to search for an approval workflow criterion type	Searching for an Approval Workflow Criterion Type on page 853
How to view the details of an approval workflow criterion type	Viewing the Approval Workflow Criterion Type Details on page 854

Searching for an Approval Workflow Criterion Type

Procedure

To search the approval workflow criterion type:

1. Click the **Admin** link in the **Application** toolbar.
A list appears.
2. From the **Admin** menu, select **A** and then click **Approval Workflow Criterion Type**.
The **Approval Workflow Criterion Type** screen appears.
3. Enter the search criteria in the **Search Approval Workflow Criterion Type** zone.

Note: ORMB search engine supports wildcard search, where you can substitute the percentage (%) symbol as a stand in for any word or letter in a search criteria. You can use the ‘%’ wildcard character in all input fields except the date and ID fields. The ‘%’ wildcard character is suffixed automatically at the end of the partial search criteria. Therefore, you may or may not specify the wildcard character at the end of the partial search criteria. However, you have to prefix the wildcard character manually wherever required.

4. Click **Search**

A list of approval workflow criterion types that meet the search criteria appears in the **Search Results** section.

Related Topics

For more information on...	See...
Approval Workflow Criterion Type screen	Approval Workflow Criterion Type (Used for Searching) on page 853
Approval Workflow Criterion Type zone	Search Approval Workflow Criterion Type on page 853

Viewing the Approval Workflow Criterion Type Details**Procedure**

To view the details of an approval workflow criterion type:

1. If required, filter the approval workflow criterion type details in the **Search Approval Workflow Criterion Type** screen.
2. In the **Search Results** section, click the link in the **Description** column corresponding to the approval workflow criterion type whose details you want to view.

The **Approval Workflow Criterion** screen appears. It contains the following zone:

- [Approval Workflow Criterion Type](#) on page 856

3. View the details of the approval workflow criterion type in the **Approval Workflow Criterion Type** zone.

Related Topics

For more information on...	See...
How to search the approval workflow criterion type	Searching for an Approval Workflow Criterion Type on page 853
Approval Workflow Criterion Type screen	Approval Workflow Criterion Type (Used for Viewing) on page 856
Approval Workflow Criterion Type zone	Approval Workflow Criterion Type on page 856

Defining an Approval Workflow Criterion Type

Prerequisites

To define an approval workflow criterion type, you should have:

- Algorithm, Business object, and Field object defined in the application.

Procedure

To define an approval workflow criterion type:

1. Click the **Admin** link in the **Application** toolbar.

A list appears.

2. From the **Admin** menu, select **A** and then click **Approval Workflow Criterion Type**.

The **Approval Workflow Criterion Type** screen appears.

3. Click the **Add** button in the **Page Title** area of the **Approval Workflow Criterion Type** screen.

The **Approval Workflow Criterion Type** screen appears. It contains the following section:

- **Main** - Used to specify basic details about the approval workflow criterion type.

The **Main** section contains the following fields:

Field Name	Field Description	Mandatory (Yes or No)
Approval Workflow Criterion Type	Used to specify the approval workflow criterion type.	Yes
Description	Used to specify the description for the approval workflow criterion type.	Yes
Derived From	Used to indicate the option which triggers the approval workflow. The valid values are: <ul style="list-style-type: none"> • Algorithm • Business Object 	Yes
Algorithm	Used to indicate the algorithm for which you want to define the approval workflow criterion type. <div style="border: 1px solid black; padding: 5px; margin-top: 10px;"> <p>Note:</p> <p>The Search (🔍) icon appears corresponding to this field. On clicking the Search icon, the Algorithm Search window appears.</p> <p>This field appears when you select the Algorithm option from the Derived From list.</p> </div>	Yes
Business Object	Used to indicate the business object for which you want to define the approval workflow criterion type.	Yes

Field Name	Field Description	Mandatory (Yes or No)
	<p>Note:</p> <p>The Search (🔍) icon appears corresponding to this field. On clicking the Search icon, the Business Object Search window appears.</p> <p>This field appears when you select the Business Object option form the Derived From list.</p>	
Field	<p>Used to indicate the field that you want to use to define the criteria for associating approval workflow requests with the approval workflow chains.</p> <p>Note:</p> <p>The Search (🔍) icon corresponding to this field. On clicking the Search icon, the Field Search window appears.</p> <p>This field appears when you select the Business Object option form the Derived From list.</p>	Yes

4. Enter the required details.
5. Click **Save**.

The approval workflow criterion type is created.

Related Topics

For more information on...	See...
Approval Workflow Criterion Type screen	Approval Workflow Criterion Type (Used for Viewing) on page 856
Search Approval Workflow Criterion Type zone	Search Approval Workflow Criterion Type on page 853

Approval Workflow Criterion Type (Used for Viewing)

Once you define an approval workflow criterion type, the **Approval Workflow Criterion Type** screen allows you to:

- Edit the details of an approval workflow criterion type
- Delete an approval workflow criterion type

This screen contains the following zone:

- [Approval Workflow Criterion Type](#) on page 856

Approval Workflow Criterion Type

The **Approval Workflow Criterion Type** zone displays the details of the approval workflow criterion types. It contains the following sections:

- **Main** - Displays basic information about the approval workflow criterion type. It contains the following fields:

Field Name	Field Description
Approval Workflow Criterion Type	Displays the approval workflow criterion type.
Description	Displays the description of the approval workflow criterion type.
Derived From	Indicates the criteria type that triggers the approval workflow. The valid values are: <ul style="list-style-type: none"> Algorithm Business Object
Business Object	Indicates the business object using which the approval workflow criterion type is created. In addition, a context menu appears corresponding to this field which helps in navigating to other screens in the application. <p>Note: It has a link. On clicking the link, the Business Object screen appears where you can view the details of the respective business object.</p>
Field	Indicates the field using which the criteria for associating approval workflow requests with the approval workflow chains will be defined. <p>Note: It has a link. On clicking the link, the Fields screen appears where you can view the details of the respective field.</p>

- **Record Actions** - This section contains the following buttons:

Button Name	Button Description
Edit	Used to edit the approval workflow criterion type.
Delete	Used to delete the approval workflow criterion type.

- **Record Information** - This section contains the following field:

Field Name	Field Description
Business Object	Indicates the business object using which the approval workflow chain and levels is created. In addition, a context menu appears corresponding to this field which helps in navigating to other screens in the application. <p>Note: It has a link. On clicking the link, the Business Object screen appears where you can view the details of the respective business object.</p>

Editing an Approval Workflow Criterion Type

Procedure

To edit an approval workflow criterion type:

1. Search for the approval workflow criterion type in the **Approval Workflow Criterion Type** screen.
2. In the **Search Results** section, click the link in the **Description** column corresponding to the approval workflow criterion type whose details you want to edit.

The **Approval Workflow Criterion Type** screen appears.

3. Click the **Edit** button in the **Approval Workflow Criterion Type** zone.

The **Approval Workflow Criterion Type** screen appears. It contains the following section:

- **Main** - This section contains the following fields:

Field Name	Field Description	Mandatory (Yes or No)
Approval Workflow Criterion Type	Displays the approval workflow criterion type.	Yes
Description	Displays the description for the approval workflow criterion type.	Yes
Derived From	Displays an option which triggers the approval workflow.	Yes
Algorithm	<p>Displays the algorithm for which you want to define the approval workflow criterion type.</p> <p>Note:</p> <p>The Search (🔍) icon corresponding to this field. On clicking the Search icon, the Algorithm Search window appears</p> <p>This field appears when you select the Algorithm option form the Derived From list.</p>	Yes
Business Object	<p>Displays the business object which is used to define the approval workflow criterion type.</p> <p>Note:</p> <p>The Search (🔍) icon corresponding to this field. On clicking the Search icon, the Business Object Search window appears.</p> <p>This field appears when you select the Business Object option form the Derived From list.</p>	Yes
Field	<p>Displays the field which is used to define the criteria for associating approval workflow requests with the approval workflow chains.</p> <p>Note:</p> <p>The Search (🔍) icon corresponding to the respective field. On clicking the Search icon, the Field Search window appears.</p> <p>This field appears when you select the Business Object option form the Derived From list.</p>	Yes

4. Modify the required details in the **Approval Workflow Criterion Type** screen.
5. Click **Save**.

The changes made to the approval workflow criterion type screen are saved.

Related Topics

For more information on...	See...
How to search for an approval workflow criterion type	Searching for an Approval Workflow Criterion Type on page 853
Approval Workflow Criterion Type screen	Approval Workflow Criterion Type (Used for Viewing) on page 856
Approval Workflow Criterion Type zone	Approval Workflow Criterion Type on page 856

Deleting an Approval Workflow Criterion Type

Procedure

To delete an approval workflow criterion type:

1. Search for the approval workflow criterion type in the **Approval Workflow Criterion Type** screen.
2. In the **Search Results** section, click the link in the **Description** column corresponding to the approval workflow criterion type whose details you want to delete.

The **Approval Workflow Criterion Type** screen appears.

3. Click the **Delete** button in the **Approval Workflow Criterion Type** zone.

A message appears confirming whether you want to delete the approval workflow criterion type.

4. Click **OK**.

The approval workflow criterion type is deleted.

Related Topics

For more information on...	See...
How to search for an approval workflow criterion type	Searching for an Approval Workflow Criterion Type on page 853
Approval Workflow Criterion Type screen	Approval Workflow Criterion Type (Used for Viewing) on page 856
Approval Workflow Criterion Type zone	Approval Workflow Criterion Type on page 856

Approval Workflow Group Chain Linkage (Used for Searching)

The **Approval Workflow Group Chain Linkage** screen allows you to search for an approval workflow group chain linkage using various search criteria. Through this screen, you can navigate to the following screen:

- [Approval Workflow Group Chain Linkage \(Used for Viewing\)](#) on page 865

This screen consists of the following zone:

- [Search Approval Workflow Group Chain Linkage](#) on page 859

For more information on...	See...
How to search for an approval workflow group chain linkage	Searching for an Approval Workflow Group Chain Linkage on page 860
How to view the details of an approval workflow group chain linkage	Viewing the Approval Workflow Group Chain Linkage Details on page 861

Search Approval Workflow Group Chain Linkage

The **Search Approval Workflow Group Chain Linkage** zone allows you to search for an approval workflow group chain linkage using various search criteria. It contains the following two sections:

- **Search Criteria** - The **Search Criteria** section contains the following fields:

Field Name	Field Description	Mandatory (Yes or No)
Group Chain Linkage ID	Used to search a particular approval workflow group chain linkage.	Yes
Approval Workflow Group	Used to search a group chain linkage for which an approval workflow group is defined.	Yes
Approval Workflow Chain	Used to search a group chain linkage for which an approval workflow chain is defined.	Yes

Note: You must specify at least one search criterion while searching for an approval workflow group chain linkage.

- **Search Results** - On clicking the **Search** button, the search results appear based on the specified search criteria.

The **Search Results** section contains the following columns:

Column Name	Column Description
Group Chain Linkage ID	Displays the ID which is generated automatically when the link is created.
Approval Workflow Group	Indicates the approval workflow group for which the link is created. Note: It has a link. On clicking the link, the Approval Workflow Group Chain Linkage screen appears with the details of the respective business object.
Approval Workflow Chain	Indicates the approval workflow chain for which the link is created.
Field Approval Rule	Indicates whether you want to configure approval rule for one or more fields of the business objects which are included in the approval workflow group. The valid values are: <ul style="list-style-type: none"> • Yes • No

Related Topics

For more information on...	See...
How to search for an approval work group chain linkage	Searching for an Approval Workflow Group Chain Linkage on page 860
How to view the details of an approval workflow group chain linkage	Viewing the Approval Workflow Group Chain Linkage Details on page 861

Searching for an Approval Workflow Group Chain Linkage

Procedure

To search an approval workflow group chain linkage:

1. Click the **Admin** link in the **Application** toolbar.

A list appears.

- From the **Admin** menu, select **A** and then click **Approval Workflow Group Chain Linkage**.

The **Approval Workflow Group Chain Linkage** screen appears.

- Enter the search criteria in the **Search Group Chain Linkage** zone.

Note: ORMB search engine supports wildcard search, where you can substitute the percentage (%) symbol as a stand in for any word or letter in a search criteria. You can use the ‘%’ wildcard character in all input fields except the date and ID fields. The ‘%’ wildcard character is suffixed automatically at the end of the partial search criteria. Therefore, you may or may not specify the wildcard character at the end of the partial search criteria. However, you have to prefix the wildcard character manually wherever required.

- Click **Search**.

A list of group chain linkages that meet the search criteria appears in the **Search Results** section.

Related Topics

For more information on...	See...
Approval Workflow Group Chain Linkage screen	Approval Workflow Group Chain Linkage (Used for Searching) on page 859
Search Approval Workflow Group Chain Linkage zone	Search Approval Workflow Group Chain Linkage on page 859

Viewing the Approval Workflow Group Chain Linkage Details

Procedure

To view the details of an approval workflow chain linkage:

- Search for the approval workflow group chain linkage in the **Approval Workflow Group Chain Linkage** screen.
- In the **Search Results** section, click the link in the **Approval Workflow Group** column corresponding to the approval workflow chain whose details you want to view.

The **Approval Workflow Group Chain Linkage** screen appears. It contains the following zone:

- [Approval Workflow Group Chain Linkage](#) on page 866
- View the details of the approval workflow group chain linkage in the **Approval Workflow Group Chain Linkage** zone.

Related Topics

For more information on...	See...
How to search for an approval workflow group chain linkage	Searching for an Approval Workflow Group Chain Linkage on page 860
Approval Workflow Group Chain Linkage screen	Approval Workflow Group Chain Linkage (Used for Viewing) on page 865

Defining an Approval Workflow Group Chain Linkage

Prerequisites

To define an approval workflow group chain linkage, you should have:

- Business Object, Field, Criterion Type, Approval Workflow Group and Approval Workflow Chain defined in the application.

Procedure

To define an approval workflow group chain linkage:

1. Click the **Admin** link in the **Application** toolbar.

A list appears.

2. From the **Admin** menu, select **A** and then click **Approval Workflow Group Chain Linkage**.

The **Approval Workflow Group Chain Linkage** screen appears.

3. Click the **Add** button in the **Page Title** area of the **Approval Workflow Group Chain Linkage** screen.

The **Approval Workflow Group Chain Linkage** screen appears. It contains the following sections:

- **Main** - Used to specify basic details about the approval workflow group chain linkage.
- **Group Chain Linkage Criteria** - Used to define group chain linkage criteria for the approval workflow type.

The **Main** section contains the following fields:

Field Name	Field Description	Mandatory (Yes or No)
Approval Workflow Group	Used to indicate the approval workflow group.	Yes
	Note: You can search for an approval workflow group type by clicking the Search (🔍) icon corresponding to the field.	
Approval Workflow Chain	Used to indicate the approval workflow chain.	Yes
	Note: You can search for an approval workflow chain by clicking the Search (🔍) icon corresponding to the field.	
Field Approval Rule	Used to indicate whether you want to configure approval rule for one or more fields of the business objects which are included in the approval workflow group. The valid values are: <ul style="list-style-type: none"> • Yes • No 	Yes

4. Enter the required details.
5. Define group chain linkage criteria for the approval workflow, if required.
6. Define field approval rule criteria for the approval workflow, if required.
7. Click **Save**.

The approval workflow group chain linkage is created.

Related Topics

For more information on...	See...
Approval Workflow Chain Linkage screen	Approval Workflow Group Chain Linkage (Used for Searching) on page 859
Search Approval Workflow Chain Linkage zone	Search Approval Workflow Group Chain Linkage on page 859
How to define group chain linkage criteria for an approval workflow	Defining an Approval Workflow Group Chain Linkage on page 861

Defining Group Chain Linkage Criteria for an Approval Workflow

Prerequisites

To define group chain linkage criteria for an approval workflow, you should have:

- Approval Workflow Criterion Type defined in the application.

Procedure

To define group chain linkage criteria for an approval workflow:

- Ensure that the **Group Chain Linkage Criteria** section is expanded when you are defining or editing an approval workflow.

The **Group Chain Linkage Criteria** section contains the following fields:

Field Name	Field Description	Mandatory (Yes or No)
Group Chain Linkage ID	Displays the Group Chain Linkage ID.	Yes
	Note: The data appears in this field when you are editing the details of an approval workflow criterion type.	
Criterion Type	Used to indicate the criteria type needed for defining the criterion.	Yes
	Note: The Search (🔍) icon appears corresponding to this field. On clicking the Search icon, the Approval Workflow Chain Search window appears.	
Operator	Used to indicate the relational operator used to define the relation between the criterion type and criterion value.	Yes
Criterion Value	Used to specify the criterion value.	Yes

- Enter the required details.
- If you want to define more than one group chain linkage criteria for the approval workflow, click the **Add (+)** icon, and then repeat step 2.

Note: However, if you want to remove a group chain linkage criteria from the approval workflow, click the **Delete (🗑)** icon corresponding to the group chain linkage criteria.

Related Topics

For more information on...	See...
How to edit an approval workflow group chain linkage	Editing an Approval Workflow Group Chain Linkage on page 868

Defining a Field Approval Rule

Prerequisites

To define a field approval rule for an approval workflow group chain linkage, you should have:

- Business Object, Field, and Approval Workflow Chain to be defined in the application.

Procedure

To define a field approval rule for an approval workflow group chain linkage:

1. Ensure that the

Field Approval Rule Criteria section is expanded when you select the Yes option from the Field Approval Rule field of the M

The **Field Approval Rule Criteria** section contains the following fields in a grid:

Field Name	Field Description	Mandatory (Yes or No)
Sequence.	Used to indicate the order in which the rule criteria should be executed while adding or updating the field value.	Yes
Applicable For	Used to indicate whether the rule criteria should be considered while adding and/or updating the field value. The valid values are: <ul style="list-style-type: none"> • Add • Update • Add and Update 	Yes
Business Object	Used to indicate the business object in which the field is included.	Yes
	Note: The Search (🔍) icon appears corresponding to the Business Object field. On clicking the search icon, the Search Group Based Business Object search window appears.	
Field	Used to indicate the field for which you want to define the approval rule criteria.	Yes
	Note: The Search (🔍) icon appears corresponding to the Field search field. On clicking the search icon, the Field Search search window appears.	
Approval Workflow Chain	Used to indicate the approval workflow chain that you want to use for the field value approval.	Yes
	Note: The Search (🔍) icon appears corresponding to the Approval Workflow Chain field. On clicking the search icon, the Approval Workflow Chain Search search window appears.	
Value Range	Used to indicate whether you want to define value based threshold limit for each approval level.	No
	Note: This field is enabled when the data type of the field is Numeric .	

Field Name	Field Description	Mandatory (Yes or No)
Hierarchical	Used to indicate whether multi-level or single-level approval is required while adding or updating the field value beyond the threshold limit.	No

If the **Value Range** check box is selected, a grid appears with the following set of fields:

Field	Field Description
Threshold Value	Used to specify the threshold value using which you want to control the approval hierarchy.
Approval Level	Used to indicate the approval level at which approval is required when the field value is within the threshold value.
	Note: The Search (🔍) icon appears corresponding to the Approval Level field. On clicking the search icon, the Approval Level Search search window appears.
	Note: The search results will include all those levels which are defined in the approval workflow chain.
Approval Level Information	Displays additional information about the approval level.

- Enter the required details in the **Field Approval Rule Criteria** section.
- If you want to define more than one field approval rule criteria for the approval workflow chain linkage, click the **Add** (+) icon and then repeat step 2. However, if you want to remove a field approval rule criteria from the approval workflow chain linkage, click the **Delete** (🗑) icon corresponding to the sequence field.
- Click **Save**.

The approval workflow field rule is defined.

Related Topics

For more information on...	See...
How to edit an approval workflow group chain linkage	Editing an Approval Workflow Group Chain Linkage on page 868

Approval Workflow Group Chain Linkage (Used for Viewing)

Once you define an approval workflow group chain linkage, the **Approval Workflow Group Chain Linkage** screen allows you to:

- Edit an approval workflow group chain linkage
- Delete an approval workflow group chain linkage

This screen contains the following zone:

- [Approval Workflow Group Chain Linkage](#) on page 866

For more information on...	See...
How to view the details of an approval workflow group chain linkage	Viewing the Approval Workflow Group Chain Linkage Details on page 861

Approval Workflow Group Chain Linkage

The **Approval Workflow Group Chain Linkage** zone displays the details of the approval workflow group chain linkage. It contains the following sections:

- **Main** - Displays basic information about the approval workflow group chain linkage. It contains the following fields:

Field Name	Field Description
Approval Workflow Group	Displays the approval workflow group for which a link is created.
	Note: It has a link. On clicking the link, the Approval Workflow Group screen appears with the details of the respective approval workflow group.
Approval Workflow Chain	Displays the approval workflow chain for which a link is created.
	Note: It has a link. On clicking the link, the Approval Workflow Chain screen appears with the details of the respective approval workflow group.
Field Approval Rule	Indicates whether you want to configure approval rule for one or more fields of the business objects which are included in the approval workflow group. The valid values are: <ul style="list-style-type: none"> • Yes • No

- **Record Actions** - This section contains the following buttons:

Button Name	Button Description
Edit	Used to edit the details of the approval workflow group chain linkage. Also used to define, edit, delete Group Chain Linkage Criteria and Field Approval Rule Criteria.
Delete	Used to delete the approval workflow group chain linkage.

- **Record Information** - This section contains the following field:

Field Name	Field Description
Business Object	Indicates the business object using which the approval workflow chain linkage is created. In addition, a context menu appears corresponding to this field which helps in navigating to other screens in the application.
	Note: It has a link. On clicking the link, the Business Object screen appears where you can view the details of the respective business object.

- **Group Chain Linkage Criteria** - Lists the group chain linkage criteria..This section contains the following columns:

Column Name	Column Description
Group Chain Linkage ID	Displays the ID which is generated automatically when the link is created.

Column Name	Column Description
Criterion Type	Displays the criterion type needed for defining the criterion.
	Note: It has a link. On clicking the link, the Approval Workflow Criterion Type screen appears where you can view the details of the respective criterion type.
Operator	Indicates the relational operator used to define the relation between the criterion type and criterion value. The valid values are: <ul style="list-style-type: none"> EQUALS IN
Criterion Value	Displays the criterion value.

- **Field Approval Rule Criteria** - Lists the field approval rule criteria for approval workflow group chain linkage. It contains the following columns:

Column Name	Column Description
Sequence	Indicates the order in which the rule criteria should be executed while adding or updating the field value.
Applicable For	Displays the rule criteria which should be considered while adding and/or updating the field value.
Business Object	Displays the business object in which the field is included.
Field	Displays the field for which you want to define the approval rule criteria.
	Note: The Context Menu () icon appears corresponding to the Field search field. On clicking the context menu icon, the Go to Field menu appears. On clicking the Go to Field menu item, the Field screen appears with the details of the respective field.
	Note: It has a link. On clicking the link, the Field screen appears with the details of the respective field.
Approval Workflow Chain	Indicates the approval workflow chain that you want to use for the field value approval.
	Note: It has a link. On clicking the link, the Approval Workflow Chain screen appears with the details of the respective approval workflow chain.
Value Range	Indicates whether you want to define value based threshold limit for each approval level.
	Note: This field is enabled when the data type of the field is Numeric .
Hierarchical Approval	Indicates whether multi-level or single-level approval is required while adding or updating the field value beyond the threshold limit.

Column Name	Column Description
	Note: This field is enabled when the Value Range check box is selected.

If the **Value Range** check box is selected, a grid appears with the following set of fields:

Field	Field Description
Threshold Value	Displays the threshold value using which you want to control the approval hierarchy.
Approval Level	<p>Displays the approval level at which approval is required when the field value is within the threshold value.</p> <p>Note:</p> <p>The Search (🔍) icon appears corresponding to the Approval Level field. On clicking the search icon, the Approval Level Search search window appears.</p> <p>Note: The search results will include all those levels which are defined in the approval workflow chain.</p>
Approval Level Information	Displays additional information about the approval level.

Editing an Approval Workflow Group Chain Linkage

Prerequisites

To edit an approval workflow group chain linkage, you should have:

- Business Object, Field, Criterion Type, Approval Workflow Group, and Approval Workflow Chain defined in the application.

Procedure

To edit an approval workflow group chain linkage:

1. Search for the Approval Workflow Group Chain Linkage in the **Approval Workflow Group Chain Linkage** screen.
2. In the **Search Results** section, click the link in the **Approval Workflow Group** column corresponding to the approval workflow chain whose details you want to edit.
The **Approval Workflow Group Chain Linkage** screen appears.
3. Click the **Edit** button in the **Approval Workflow Group Chain Linkage** zone.
The **Approval Workflow Group Chain Linkage** screen appears.
4. Define or edit approval workflow group chain linkage, if required.
5. Define, edit or remove approval workflow criterion from the approval workflow group chain linkage, if required.
6. Define, edit or remove field approval rule criteria from the approval workflow group chain linkage, if required.
7. Click **Save**.

The changes made to the approval workflow group chain linkage screen are saved.

Related Topics

For more information on...	See...
How to search approval workflow group chain linkage	Searching for an Approval Workflow Group Chain Linkage on page 860
Approval Workflow Group Chain Linkage screen	Approval Workflow Group Chain Linkage (Used for Viewing) on page 865
Approval Workflow Group Chain Linkage zone	Approval Workflow Group Chain Linkage on page 866

Deleting an Approval Workflow Group Chain Linkage

Procedure

To delete an approval workflow group chain linkage:

1. Search for an approval workflow group chain linkage in the **Search Approval Workflow Group Chain Linkage** zone.
2. In the **Search Results** section, click the link in the **Approval Workflow Group** column corresponding to the approval workflow chain that you want to delete.

The **Approval Workflow Group Chain Linkage** screen appears.

3. Click the **Delete** button in the **Approval Workflow Group Chain Linkage** zone.

A message appears confirming whether you want to delete the approval workflow group chain linkage.

4. Click **OK**.

The approval workflow group chain linkage is deleted.

Related Topics

For more information on...	See...
How to search for an approval workflow group chain linkage	Searching for an Approval Workflow Group Chain Linkage on page 860

Approval Workflow Setting (Used for Searching)

The **Approval Workflow Setting** screen allows you to search for approval workflow setting using various search criteria. It consists the following zone:

- [Search Approval Workflow Group](#) on page 869

Through this screen, you can navigate to the following screen:

- [Approval Workflow Setting \(Used for Viewing\)](#) on page 873

For more information on...	See...
How to search for an approval workflow setting	Searching for an Approval Workflow Group on page 870
How to view the details of approval workflow settings	Viewing the Approval Workflow Setting Details on page 871

Search Approval Workflow Group

The **Search Approval Workflow Group** zone allows you to search for an approval workflow group using various search criteria. It contains the following two sections:

- **Search Criteria** - The **Search Criteria** section contains the following fields::

Field Name	Field Description	Mandatory (Yes or No)
Approval Workflow Group	Used to search a particular approval workflow group.	Yes
Description	Used to search approval workflow group with a particular description.	Yes

Note: You must specify at least one search criterion while searching for an approval workflow group.

- **Search Results** - On clicking the **Search** button, the search results appear based on the specified search criteria. The **Search Results** section contains the following columns:

Column Name	Column Description
Approval Workflow Group	Displays the approval workflow group.
Description	Displays the description of the approval workflow group.
	Note: It has a link. On clicking the link, the Approval Workflow Group screen appears where you can view the details of the respective approval workflow group.

Related Topics

For more information on...	See...
How to search for an approval workflow group	Searching for an Approval Workflow Group on page 831
How to view the details of approval workflow setting	Viewing the Approval Workflow Setting Details on page 871

Searching for an Approval Workflow Group

Prerequisites

To search for an approval workflow group, you should have:

- Approval Workflow Group defined in the application.
- Active flag should be set to **Yes**

Procedure

To search for an approval workflow group:

1. Click the **Admin** link in the **Application** toolbar.
A list appears.
2. From the **Admin** menu, Select **A** and then click **Approval Workflow Setting**.
The **Approval Workflow Setting** screen appears.
3. Enter the search criteria in the **Search Approval Workflow Group** zone.

Note: ORMB search engine supports wildcard search, where you can substitute the percentage (%) symbol as a stand in for any word or letter in a search criteria. You can use the '%' wildcard character in all input fields except the date and ID fields. The '%' wildcard character is suffixed automatically at the end of the partial search criteria. Therefore, you may or may not specify the wildcard character at the end of the partial search criteria. However, you have to prefix the wildcard character manually wherever required.

4. Click **Search**.

A list of approval workflow groups that meet the search criteria appears in the **Search Results** section.

Related Topics

For more information on...	See...
Approval Workflow Setting screen	Approval Workflow Setting (Used for Viewing) on page 873
Search Approval Workflow Group zone	Search Approval Workflow Group on page 830

Viewing the Approval Workflow Setting Details

Procedure

To view the details of approval workflow setting:

1. Search for an approval workflow group in the **Approval Workflow Setting** screen.
2. In the **Search Results** section, click the link in the **Description** column corresponding to the approval workflow group whose details you want to view.

The **Approval Workflow Settings** screen appears.

3. View the details of the approval workflow group in the **Approval Workflow Group Settings** zone.

Related Topics

For more information on...	See...
Approval Workflow Group Settings screen	Approval Workflow Setting (Used for Viewing) on page 873
Approval Workflow Group Settings zone	Approval Workflow Group Settings on page 873
How to search for an approval workflow setting	Searching for an Approval Workflow Group on page 870

Defining Approval Workflow Group Settings

Prerequisites

To define an approval workflow group setting, you should have:

- Approval Workflow Group defined in the application.
- Active flag set to **Yes**

Procedure

To define an approval workflow group setting:

1. Click the **Admin** link in the **Application** toolbar.
A list appears.
2. From the **Admin** menu, select **A** and then click **Approval Workflow Setting**.
The **Approval Workflow Settings** screen appears.
3. Click the **Add** button in the **Page Title** area of the **Approval Workflow Settings** screen.

The **Approval Workflow Settings** screen appears. It contains the following section:

- **Main** - Used to specify the details for the approval workflow settings.

The **Main** section contains the following fields:

Field Name	Field Description	Mandatory (Yes or No)
Approval Workflow Group	Used to specify the approval workflow group.	Yes
Approval Chain Selection Algorithm	Used to specify the algorithm that will be triggered before creating the approval workflow request.	Yes
	Note: This algorithm identifies the approval workflow chain that must be used for the approval workflow group.	
	Note: You can search for an approval chain selection algorithm by clicking the Search (🔍) icon corresponding to the Approval Chain Selection Algorithm field.	
Prevalidation	Used to indicate whether validation must be done before the approval workflow request is created. The valid values are: <ul style="list-style-type: none"> • Yes • No 	Yes
	Note: You can search for a prevalidation by clicking the Search (🔍) icon corresponding to the Prevalidation field.	
Approval Reason Required	Used to indicate whether you want the approver to add reason and comments while approving the approval transaction. The valid values are: <ul style="list-style-type: none"> • Yes • No 	Yes
Active	Used to indicate whether the approval workflow is required for the business objects in the approval workflow group. The valid values are: <ul style="list-style-type: none"> • Yes - Used when you want to activate the approval workflow for the business objects in the approval workflow group. • No - Used when you do not want to activate the approval workflow for the business objects in the approval workflow group. • Conditional - Used when you want to activate the approval workflow for business objects that satisfy particular criteria (for example, when the person or account belongs to a particular division). Note that, at present, this functionality works only for an approval workflow group which consists of a single business object. 	Yes
Conditional Algorithm	Used to specify the algorithm that will be used to determine the business objects for which the approval workflow must be activated.	Yes

Field Name	Field Description	Mandatory (Yes or No)
	Note: This field appears when the Conditional option is selected from the Active list.	

4. Enter the required details.
5. Click **Save**.

The approval workflow group setting is defined.

Related Topics

For more information on...	See...
Approval Workflow Group screen	Approval Workflow Group (Used for Searching) on page 830
Search Approval Workflow Group zone	Search Approval Workflow Group on page 830

Approval Workflow Setting (Used for Viewing)

Once the approval workflow group setting is defined, the **Approval Workflow Settings** screen allows you to:

- View the details of an approval workflow setting
- Edit the approval workflow group settings
- Delete an approval workflow group settings
- Regenerate approval workflow setting UI maps

This screen consists of the following zone:

- [Approval Workflow Group Settings](#) on page 873

For more information on...	See...
How to edit the approval workflow group settings	Editing Approval Workflow Group Settings on page 875
How to delete an approval workflow group settings	Deleting Approval Workflow Group Settings on page 875
How to regenerate UI Maps	Regenerating Input and Display UI Maps on page 876

Approval Workflow Group Settings

The **Approval Workflow Group Settings** zone displays the details of the approval workflow group settings. It contains the following sections:

- **Main** - Displays the basic information about the approval workflow group settings. It contains the following fields:

Field Name	Field Description
Approval Workflow Group	Displays the approval workflow group.
Approval Chain Selection Algorithm	Displays the algorithm that will be triggered after creating the approval workflow request.
	Note: This algorithm identifies the approval workflow chain that must be used for the approval workflow group.

Field Name	Field Description
	<p>Note: It has a link. On clicking the link, the Algorithm screen appears where you can view the details of the respective approval chain selection algorithm.</p>
Prevalidation	<p>Indicates whether validation must be done before the approval workflow request is created. The valid values are:</p> <ul style="list-style-type: none"> • Yes • No
Approval Reason Required	<p>Indicates whether you want the approver to add reason and comments while approving the approval transaction. The valid values are:</p> <ul style="list-style-type: none"> • Yes • No
Active	<p>Indicates whether the approval workflow is required for the business objects in the approval workflow group. The valid values are:</p> <ul style="list-style-type: none"> • Yes - Used when you want to activate the approval workflow for the business objects in the approval workflow group. • No - Used when you do not want to activate the approval workflow for the business objects in the approval workflow group. • Conditional - Used when you want to activate the approval workflow for business objects that satisfy particular criteria (for example, when the person or account belongs to a particular division). Note that, at present, this functionality works only for an approval workflow group which consists of a single business object.
Conditional Algorithm	<p>Displays the algorithm that will be used to determine the business objects for which the approval workflow must be activated.</p> <p>Note: This field appears when the Conditional option is selected from the Active list.</p> <p>Note: It has a link. On clicking the link, the Algorithm screen appears where you can view the details of the respective conditional algorithm.</p>

- **Record Actions** - This section contains the following buttons:

Button Name	Button Description
Edit	Used to edit the settings of the approval workflow group.
Delete	Used to delete the approval workflow group setting.
Regenerate UI Maps	Used to regenerate the approval workflow group setting UI Maps.

- **Record Information** - This section contains the following fields:

Field Name	Field Description
Business Object	Indicates the business object using which the approval workflow reason is created. In addition, a context menu appears corresponding to this field which helps in navigating to other screens in the application.

Field Name	Field Description
	Note: It has a link. On clicking the link, the Business Object screen appears where you can view the details of the respective business object.

Editing Approval Workflow Group Settings

Prerequisites

To edit approval workflow group settings, you should have:

- Approval Chain Selection Algorithm defined in the application.
- Prevalidation, Approval Reason Required, and Active flag defined in the application.
- Conditional Algorithm defined in the application

Procedure

To edit approval workflow group settings:

1. Search for the approval workflow group in the **Approval Workflow Setting** screen.
2. In the **Search Results** section, click the link in the **Description** column corresponding to the approval workflow group whose details you want to edit.

The **Approval Workflow Settings** screen appears.

3. Click the **Edit** button in the **Approval Workflow Group Settings** zone.

The **Approval Workflow Group Settings** screen appears.

4. Edit the settings for the approval workflow group, if required.
5. Click **Save**.

The changes made to the approval workflow group settings are saved.

Related Topics

For more information on...	See...
How to search for an approval workflow group	Searching for an Approval Workflow Group on page 831
Approval Workflow Settings screen	Approval Workflow Setting (Used for Viewing) on page 873
Approval Workflow Group Settings zone	Approval Workflow Group Settings on page 873

Deleting Approval Workflow Group Settings

Procedure

To delete approval workflow group settings:

1. Search for the approval workflow group in the **Approval Workflow Setting** screen.
2. In the **Search Results** section, click the link in the **Description** column corresponding to the approval workflow group that you want to delete.

The **Approval Workflow Settings** screen appears.

3. Click the **Delete** button in the **Approval Workflow Group Settings** zone.

A message appears confirming whether you want to delete the approval workflow group settings.

4. Click **OK**.

The approval workflow setting is deleted.

Related Topics

For more information on...	See...
How to search for an approval workflow group	Searching for an Approval Workflow Group on page 831
Approval Workflow Settings screen	Approval Workflow Setting (Used for Viewing) on page 873
Approval Workflow Group Settings zone	Approval Workflow Group Settings on page 873

Regenerating Input and Display UI Maps

Procedure

To regenerate UI Maps for an approval workflow group setting:

1. Search for the approval workflow group in the **Approval Workflow Setting** screen.
2. In the **Search Results** section, click the link in the **Description** column corresponding to the approval workflow group for which you want to regenerate UI maps.

The **Approval Workflow Settings** screen appears.

3. Click the **Regenerate UI Maps** button in the **Approval Workflow Group Settings** zone.

A message appears confirming whether you want to replace the existing Input and Display UI Maps.

4. Click **OK**.

The Input and Display UI Maps are generated.

Related Topics

For more information on...	See...
How to search for an approval workflow group	Searching for an Approval Workflow Group on page 831
Approval Workflow Settings screen	Approval Workflow Setting (Used for Viewing) on page 873
Approval Workflow Setting zone	Approval Workflow Group Settings on page 873

Approval Workflow Reason (Used for Searching)

The **Approval Workflow Reason** screen allows you to search for an approval workflow reason using various search criteria. It also allows you to define an approval workflow reason. It contains the following zone:

- [Approval Workflow Reason List](#) on page 876

Approval Workflow Reason List

The **Approval Workflow Reason List** zone lists the approval workflow reasons that are already defined in the system. It contains the following two sections:

- **Search Criteria** - The **Search Criteria** section contains the following fields:

Field Name	Field Description	Mandatory (Yes or No)
Approval Workflow Reason	Used to search a particular approval workflow reason.	No

Field Name	Field Description	Mandatory (Yes or No)
Description	Used to search approval workflow reasons with a particular description.	No

- **Search Results** - On clicking the **Search** button, the search results are filtered based on the specified search criteria. The **Search Results** section contains the following columns:

Column Name	Column Description
Approval Workflow Reason	Displays the approval workflow reason.
Description	Displays the description of the approval workflow reason.
Reason Category	Indicates the category to which the approval workflow reason belongs. The valid values are: <ul style="list-style-type: none"> • Approve • Cancel • Reject

Related Topics

For more information on...	See...
How to filter approval workflow reasons	Filtering the Approval Workflow Reasons on page 877
How to view the details of an approval workflow reason	Viewing the Approval Workflow Reason Details on page 878
How to define an approval workflow reason	Defining an Approval Workflow Reason on page 878

Filtering the Approval Workflow Reasons

Procedure

To filter the approval workflow reasons:

1. Click the **Admin** link in the **Application** toolbar.
A list appears.
2. From the **Admin** menu, select **A** and then click **Approval Workflow Reason**.
The **Approval Workflow Reason** screen appears.
3. Enter the required search criteria in the **Approval Workflow Reason List** zone.

Note: ORMB search engine supports wildcard search, where you can substitute the percentage (%) symbol as a stand in for any word or letter in a search criteria. You can use the ‘%’ wildcard character in all input fields except the date and ID fields. The ‘%’ wildcard character is suffixed automatically at the end of the partial search criteria. Therefore, you may or may not specify the wildcard character at the end of the partial search criteria. However, you have to prefix the wildcard character manually wherever required.

4. Click **Search**.

The search results are filtered based on the specified criteria.

Related Topics

For more information on...	See...
Approval Workflow Reason screen	Approval Workflow Reason (Used for Searching) on page 876
Approval Workflow Reason List zone	Approval Workflow Reason List on page 876

Viewing the Approval Workflow Reason Details

Procedure

To view the details of an approval workflow reason:

1. If required, filter the approval workflow reasons in the **Approval Workflow Reason** screen.
2. In the **Search Results** section, click the link in the **Description** column corresponding to the approval workflow reason whose details you want to view.

The **Approval Workflow Reason** screen appears. It contains the following zone:

- [Approval Workflow Reason](#) on page 879

3. View the details of the approval workflow reason in the **Approval Workflow Reason** zone.

Related Topics

For more information on...	See...
How to filter the approval workflow reasons	Filtering the Approval Workflow Reasons on page 877
Approval Workflow Reason screen	Approval Workflow Reason (Used for Viewing) on page 879

Defining an Approval Workflow Reason

Prerequisites

To define an approval workflow reason, you should have:

- Values defined for the **APPTXN_REASON_TYPE** lookup field

Procedure

To define an approval workflow reason:

1. Click the **Admin** link in the **Application** toolbar.
A list appears.
2. From the **Admin** menu, select **A** and then click **Approval Workflow Reason**.
The **Approval Workflow Reason** screen appears.
3. Click the **Add** button in the **Page Title** area of the **Approval Workflow Reason** screen.

The **Approval Workflow Reason** screen appears. It contains the following fields:

Field Name	Field Description	Mandatory (Yes or No)
Approval Workflow Reason	Used to specify the approval workflow reason.	Yes
Description	Used to specify the description for the approval workflow reason.	Yes
Reason Category	Used to indicate the category to which the approval workflow reason belongs. The valid values are: <ul style="list-style-type: none"> • Approve 	Yes

Field Name	Field Description	Mandatory (Yes or No)
	<ul style="list-style-type: none"> Cancel Reject 	

- Enter the required details in the **Approval Workflow Reason** screen.
- Click **Save**.

The approval workflow reason is defined.

Related Topics

For more information on...	See...
Approval Workflow Reason screen	Approval Workflow Reason (Used for Searching) on page 876

Approval Workflow Reason (Used for Viewing)

Once you define an approval workflow reason, the **Approval Workflow Reason** screen allows you to:

- View the details of an approval workflow reason
- Edit and delete an approval workflow reason

This screen contains the following zone:

- [Approval Workflow Reason](#) on page 879

Approval Workflow Reason

The **Approval Workflow Reason** zone displays the details of the approval workflow reason. It contains the following sections:

- Main** - Displays basic information about the approval workflow reason. It contains the following fields:

Field Name	Field Description
Approval Workflow Reason	Displays the approval workflow reason.
Description	Displays the description of the approval workflow reason.
Reason Category	Indicates the category to which the approval workflow reason belongs. The valid values are: <ul style="list-style-type: none"> Approve Cancel Reject

- Record Actions** - This section contains the following buttons:

Button Name	Button Description
Edit	Used to edit the details of the approval workflow reason.
Delete	Used to delete the approval workflow reason.

- Record Information** - This section contains the following field:

Field Name	Field Description
Business Object	Indicates the business object using which the approval workflow reason is created. In addition, a context menu appears corresponding to this field which helps in navigating to other screens in the application.
	Note: It has a link. On clicking the link, the Business Object screen appears where you can view the details of the respective business object.

Related Topics

For more information on...	See...
How to edit an approval workflow reason	Editing an Approval Workflow Reason on page 880
How to delete an approval workflow reason	Deleting an Approval Workflow Reason on page 881

Editing an Approval Workflow Reason

Prerequisites

To edit an approval workflow reason, you should have:

- Values defined for the **APPTXN_REASON_TYPE** lookup field

Procedure

To edit an approval workflow reason:

1. Click the **Admin** link in the **Application** toolbar.
A list appears.
2. From the **Admin** menu, select **A** and then click **Approval Workflow Reason**.
The **Approval Workflow Reason** screen appears.
3. If required, filter the approval workflow reasons in the **Approval Workflow Reason** screen.
4. In the **Search Results** section, click the link in the **Description** column corresponding to the approval workflow reason whose details you want to edit.

The **Approval Workflow Reason** screen appears.

5. Click the **Edit** button in the **Approval Workflow Reason** zone.

The **Approval Workflow Reason** screen appears. It contains the following fields:

Field Name	Field Description	Mandatory (Yes or No)
Approval Workflow Reason	Displays the approval workflow reason.	Not applicable
Description	Used to specify the description for the approval workflow reason.	Yes
Reason Category	Used to indicate the category to which the approval workflow reason belongs. The valid values are: <ul style="list-style-type: none"> • Approve • Cancel 	Yes

Field Name	Field Description	Mandatory (Yes or No)
	<ul style="list-style-type: none"> Reject 	

6. Modify the required details in the **Approval Workflow Reason** screen.

7. Click **Save**.

The changes made to the approval workflow reason are saved.

Related Topics

For more information on...	See...
How to filter the approval workflow reasons	Filtering the Approval Workflow Reasons on page 877
Approval Workflow Reason screen	Approval Workflow Reason (Used for Viewing) on page 879
Approval Workflow Reason zone	Approval Workflow Reason on page 879

Deleting an Approval Workflow Reason

Procedure

To delete an approval workflow reason:

1. Click the **Admin** link in the **Application** toolbar.

A list appears.

2. From the **Admin** menu, select **A** and then click **Approval Workflow Reason**.

The **Approval Workflow Reason** screen appears.

3. If required, filter the approval workflow reasons in the **Approval Workflow Reason** screen.

4. In the **Search Results** section, click the link in the **Description** column corresponding to the approval workflow reason that you want to delete.

The **Approval Workflow Reason** screen appears.

5. Click the **Delete** button in the **Approval Workflow Reason** zone.

A message appears confirming whether you want to delete the approval workflow reason.

6. Click **OK**.

The approval workflow reason is deleted.

Related Topics

For more information on...	See...
How to filter the approval workflow reasons	Filtering the Approval Workflow Reasons on page 877
Approval Workflow Reason screen	Approval Workflow Reason (Used for Viewing) on page 879
Approval Workflow Reason zone	Approval Workflow Reason on page 879

Chapter 7

Multi-Currency Accounts

Topics:

- [Creating Adjustments](#)
- [Generating Bills](#)
- [Applying Payments](#)
- [Monitoring Overdue Debt](#)
- [Generating History](#)

Oracle Revenue Management and Billing allows you to change the currency in which an account is invoiced. While the charges on a bill must be in a single currency, accounts can now be billed in different currencies over time. For example, when a person opens an account, he/she might be billed in US Dollars. However, with the Multi-Currency Accounts feature enabled, the same account can be billed in Euros in the near future. You can use the Multi-Currency Accounts functionality when:

- You set the **Multi-Currency Accounts (C1_MLTCURACC)** feature configuration.
- The account's person class is enabled for open item accounting. In other words, the **Open Item Accounting** check box of the account's customer class is selected.
- The account does not have any active or pending loans, payment plans, payment arrangements, or recurring charge contracts.

The following are some limitations while using the Multi-Currency Accounts functionality:

- Overdue charges in multiple currencies may not be referred to a collection agency. Such cases would be handled via a manual referral.
- Because the account's customer class must be enabled for open-item accounting, you can only use Overdue Processing to collect overdue bills. The Collections and Severance processes are not supported for open-item accounting.
- Write offs involving multiple currencies must be performed manually.
- Budgets, deposits, pay plans, and payment arrangements are not supported.

Note: If there is an outstanding debt for an account in more than one currency, the system displays "***" instead of the total account balance across the application.

To use the Multi-Currency Accounts functionality, you need to:

- Set the **Multi-Currency Accounts (C1_MLTCURACC)** feature configuration
- Define required currencies along with currency symbols
- Define invoice currencies for divisions. This is because while changing the invoice currency of an account, you can only view those invoice currencies that are associated to the account's division.
- Define the required exchange rates for currency conversion

- Create tender control and deposit control for every invoice currency defined in the system
- Define an adjustment type that you want to use during currency conversion, and link it to the relevant adjustment profile
- Define an adjustment type that you want to use during Write off process, and link it to the relevant adjustment profile
- Define a contract type that you want to use during over payments to transfer the credit balance to other contracts
- Set the collection method of the account's customer class to **Overdue**
- Setup auto-pay to debit the bill amount, and not the account's balance
- Setup the account's customer class to keep credits on a separate contract

The following business processes are enhanced for implementing the Multi-Currency Accounts functionality:

- [Creating Adjustments](#) on page 885
- [Generating Bills](#) on page 885
- [Applying Payments](#) on page 885
- [Monitoring Overdue Debt](#) on page 885
- [Generating History](#) on page 885

For more information on...	See...
How to set the Multi-Currency Accounts (C1_MLTCURACC) feature configuration	Setting the C1_MLTCURACC Feature Configuration on page 4331

Creating Adjustments

If you are using the Multi-Currency Accounts functionality, you can create adjustments in the currency which is different from the account's invoice currency.

Generating Bills

A bill is generated in the account's invoice currency. If you change the invoice currency of an account, any new bills will be generated in the new currency. For example, if you have changed the invoice currency of an account from US Dollars to Euros on 1st Feb 2010, all bills generated thereafter will be generated in Euros.

When a bill is completed and adjustments are swept onto the bill, adjustments that are created in the currency which is different from the account's invoice currency will be converted to the account's invoice currency. The system will create a transfer adjustment for each adjustment that is converted to provide complete audit information. The adjustment type specified in the **Transfer Adjustment Type for Currency Conversion** option type of the **Multi-Currency Accounts (C1_MLTCURACC)** feature configuration will be used for the conversion. The original adjustment and to-side of the transfer adjustment will be placed on the same match event.

Also, during bill completion, the Contract Type – Bill Completion algorithm type, **CREDIT-XFER**, which is usually specified on the credit contract, will automatically convert credit amounts in one currency to the invoice currency before distributing those credits.

Applying Payments

If you are using the Multi-Currency Accounts feature, you can apply payments in the currency which is different from the account's invoice currency. However, note that the currency used for payment cannot be different from the one used for billing.

When applying a payment, you can only select **Bill ID** as the match type. Also, all tenders for the same payment event must be in the same currency.

Monitoring Overdue Debt

Currency code is now optional while defining collection class overdue rules. When a batch job is processed, the Overdue Debt Monitor will search for overdue rules that match the account's collection class, division, and currency. If overdue rules for that combination are found, those rules will be executed. If the overdue rules are not found, the Overdue Debt Monitor will search for overdue rules that match the account's collection class and division. If overdue rules for that combination are found, those rules will be executed. If the overdue rules are not found, the account will be skipped.

Generating History

If the account has financial transactions in multiple currencies, zero appears throughout the **Current Balance** and **Payoff Balance** columns in the following screens:

- Account Financial History
- Contract Financial History
- View Account Financial Transaction History

Chapter

8

Rules Engine

Topics:

- [Rule Type \(Used for Searching\)](#)
- [Rule Type \(Used for Viewing\)](#)
- [Rule](#)
- [Rule](#)
- [Rule Check](#)

A rules engine executes one or more business rules in a runtime production environment. It allows you to define, execute, and maintain these business rules separately from the application code. You can then use these business rules in any program to facilitate operational decisions at runtime. For example, you might use business rules in the Collection module to decide the collection strategy or in the Banking module to derive charges codes or price items for the transaction.

A rules engine allows you to classify these rules using the rule type. It also allows you to define the relationship between two or more rules and set the priority for each rule. When a calling program invokes these rules using the rule type, all effective rules with the specified rule type are executed, starting with the rule having highest priority. For example, a rule with the priority 10 will be executed before a rule with the priority 20.

Each rule contains one or more criteria. Depending on whether the criteria is satisfied, the system either executes the next criteria or indicates whether the rule is true or false. The rules engine allows you to define what should happen when the rule is true or false. In both the cases, you can enforce the system to either:

- Execute any dependent rule
- Execute a rule with the same rule type having lower priority
- Return the output parameters and their values to the calling program

You can define a criteria for a rule only using the input parameters that are defined for the rule type. Also, when the rule is true, you can only return the output parameters that are defined for the rule type to the calling programs. Therefore, in case you want to use any field in the rule, you have to associate it with the rule type as an input or output parameter.

A rules engine also allows you to execute preprocessing and postprocessing algorithms. A preprocessing algorithm is triggered before executing any criteria in the rule. It pre-processes the input parameters and then returns processed values against which the criteria is validated. A postprocessing algorithm is triggered after executing all criteria in the rule. It post-processes the output parameters and returns the updated values to the calling programs or dependent rules.

Oracle Revenue Management and Billing provides you with the Rule Check utility. It allows you to validate whether rules defined with a specific rule type get executed as expected. On validating, it indicates the sequence in which the rules were executed, the total execution time, and displays the output parameters of the rule that was successfully executed.

Normally, in the Transaction Feed Management feature, the transaction legs are created using the output parameters of the rule where the criteria returns **Rule**

Is True and the rule true action is set to **Success**. Oracle Revenue Management and Billing also enables you to accumulate the output parameters of all rules where the criteria returns **Rule Is True** irrespective of whether the rule true action is set to **Next Dependent**, **Next Rule by Priority**, or **Success**. This accumulation process continues until a rule is executed where the criteria returns **Rule Is True** and the rule true action is set to **Success**. Once the output parameters are accumulated, the transactions legs are created using these accumulated output parameters. You can enable the rule output accumulation feature for the Transaction Feed Management module by setting the **Rule Output Accumulation** option type in the **C1_FM** feature configuration to **true**.

There might be situations when duplicate transaction legs are created through the rule output accumulation process. The system enables you to indicate whether duplicate transaction legs must be created during the transaction aggregation cycle through the rule output accumulation process. If the **Remove Duplicates from Accumulated Rule Output** option type in **C1_FM** feature configuration is set to **true**, the system does not create duplicate transaction legs during the transaction aggregation cycle.

Note: The transaction legs with the same account ID, price item, variance parameter or price item parameters, and processing date are considered as duplicate transaction legs.

Rule Type (Used for Searching)

A rule type can be used for defining rule based auto pay instructions or business rules for mapping transactions with the price items. If you want to use the rule type for defining rule based auto pay instructions, you must set the **Rule Type Usage** field to **Auto Pay**. However, if you want to use the rule type for defining business rules for mapping transactions with the price items, you must leave the **Rule Type Usage** field blank.

It is the rule type which helps the system to determine:

- Fields that can be used while defining criteria for business rules or rule based auto pay instructions
- Entities whose characteristics can be used while defining criteria for rule based auto pay instructions
- Algorithms which must be used for deriving information from the financial transaction
- Maximum number of rules that can be defined when the rule based auto pay instruction is created using the rule type

The **Rule Type** screen allows you to search for a rule type using various search criteria. It also allows you to define, edit, delete, and copy a rule type. It contains the following zone:

- [Search Rule Type](#) on page 889

Search Rule Type





The **Search Rule Type** zone allows you to search for a rule type using various search criteria. It contains the following two sections:

- **Search Criteria** - The **Search Criteria** section contains the following fields:

Field Name	Field Description	Mandatory (Yes or No)
Rule Type	Used to search a particular rule type.	No
Description	Used to search rule types with a particular description.	No
Rule Type Usage	Used to indicate whether you want to search rule types which are used for defining rule based auto pay instructions or which are used for defining business rules for mapping transactions with the price items. The valid value is: <ul style="list-style-type: none"> • ASO Billing Line Item Eligibility • ASO Billing Markup/Down Eligibility • • Auto Pay 	No
	Note: If you want to search rule types which are used for defining business rules for mapping transactions with the price items, you must leave this field blank.	

- **Search Results** - On clicking the **Search** button, the search results appear based on the specified search criteria. The **Search Results** section contains the following columns:

Column Name	Column Description
Rule Type	Displays the rule type.
Description	Displays the description of the rule type.

Column Name	Column Description
Rule Type Usage	Indicates whether the rule type is used for defining rule based auto pay instructions or for defining business rules for mapping transactions with the price items.
View	On clicking the View () icon, the Rule Type screen appears where you can view the details of the rule type.
Edit	On clicking the Edit () icon, the Rule Type screen appears where you can edit the details of the rule type.
Delete	On clicking the Delete () icon, you can delete the rule type.
	Note: You can delete a rule type when the rule based auto pay instructions or business rules are not yet defined using the rule type.
Duplicate	On clicking the Duplicate () icon, the Rule Type screen appears where you can create a new rule type using an existing rule type.

Related Topics

For more information on...	See...
How to search for a rule type	Searching for a Rule Type on page 890
How to view the details of a rule type	Viewing the Rule Type Details on page 904
How to edit a rule type	Editing a Rule Type on page 897
How to delete a rule type	Deleting a Rule Type on page 899
How to copy a rule type	Copying a Rule Type on page 900

Searching for a Rule Type

Prerequisites

To search for a rule type, you should have:

- Values defined for the **C1_RULE_USAGE_FLG** lookup field

Procedure

To search for a rule type:

1. Click the **Admin** link in the **Application** toolbar.
A list appears.
2. From the **Admin** menu, select **R** and then click **Rule Type**.
A sub-menu appears.
3. Click the **Search** option from the **Rule Type** sub-menu.
The **Rule Type** screen appears.
4. Enter the search criteria in the **Search Rule Type** zone.

Note: ORMB search engine supports wildcard search, where you can substitute the percentage (%) symbol as a stand in for any word or letter in a search criteria. You can use the ‘%’ wildcard character in all input fields except the date and ID fields. The ‘%’ wildcard character is suffixed automatically at the end of the partial search criteria. Therefore, you may or may not specify the wildcard character at the end of the partial search criteria. However, you have to prefix the wildcard character manually wherever required.

5. Click **Search**.

A list of rule types that meet the search criteria appears in the **Search Results** section.

Related Topics

For more information on...	See...
Rule Type screen	Rule Type (Used for Searching) on page 889
Search Rule Type zone	Search Rule Type on page 889

Defining a Rule Type

Prerequisites

To define a rule type, you should have:

- Values defined for the **C1_RULE_USAGE_FLG** lookup field
- Values defined for the **RULE_TYPE_CAT_FLG** lookup field

Procedure

To define a rule type:

1. Click the **Admin** link in the **Application** toolbar.
A list appears.
2. From the **Admin** menu, select **R** and then click **Rule Type**.
A sub-menu appears.
3. Click the **Add** option from the **Rule Type** sub-menu.

The **Rule Type** screen appears. It contains the following sections:

- **Main** - Used to specify basic details about the rule type.
- **Input and Output Parameters** - Used to define input and output parameters for the rule type.
- **Rule Criteria Characteristic Entities** - Used to indicate the entities whose characteristics you can use while defining rule based auto pay instructions using the rule type.

Note: This section appears when you select the **Auto Pay** option from the **Rule Type Usage** list.

- **Rule Criteria Derivation Algorithms** - Used to attach algorithms which you want to use for deriving the following from the financial transaction:
 - Values of all those fields (such as, policy number, plan number, or price item) which are selected in the rule type as the input and output parameters
 - Characteristics of all those entities which are selected in the rule type as the rule criteria characteristic entities

Note: This section appears when you select the **Auto Pay** option from the **Rule Type Usage** list.

The **Main** section contains the following fields:

Field Name	Field Description	Mandatory (Yes or No)
Rule Type	Used to specify the rule type.	Yes
Rule Type Usage	Used to indicate whether you want to use the rule type for defining rule based auto pay instructions or for defining business	No

Field Name	Field Description	Mandatory (Yes or No)
	<p>rules for mapping transactions with the price items. The valid values are:</p> <ul style="list-style-type: none"> • Line Item Eligibility • Mark Up/Mark Down Eligibility • Domestic Provider Eligibility • Auto Pay • File Upload Interface • Price Item Eligibility • Related Pricing Rule Type Eligibility <p>Note: If you want to use the rule type for defining rule based auto pay instructions, you must set the rule type usage to Auto Pay. However, if you want to use the rule type for defining business rules for mapping transactions with the price items, you must leave this field blank.</p>	
Description	Used to specify the description for the rule type.	Yes
Maximum Rule Count	<p>Used to indicate the maximum number of rules that can be defined when the rule based auto pay instruction is created using the rule type.</p> <p>Note: This field appears when you select the Auto Pay option from the Rule Type Usage list. The maximum rule count cannot be less than or equal to zero.</p>	No
Rule Type Category	<p>Used to indicate whether you want to create a field based or parameter based rule type. The valid values are:</p> <ul style="list-style-type: none"> • Field Based • Parameter Based <p>Note: This field appears when you select the Price Item Eligibility or Related Pricing Rule Type Eligibility option from the Rule Type Usage list. By default the value of this option type is set to Field Based.</p>	No

Tip: Alternatively, you can access this screen by clicking the **Add** button in the **Page Title** area of the **Rule Type** screen.

4. Enter the required details in the **Main** section.
5. Define input and output parameters for the rule type.

Note: On selecting the **Parameter Based** option from the **Rule Type Category** list, the **Parameter** column appears in the **Input and Output Parameters** section. Here, you can specify a parameter whether the parameter usage is set to **Rule Eligibility Criteria**.

- Associate one or more characteristic entities with the rule type, if required.

Note: You must specify at least one input or output parameter when you want to use the rule type for defining business rules for mapping transactions with the price items. However, you must specify at least one input or output parameter or associate at least one characteristic entity when you want to use the rule type for defining rule based auto pay instructions.

- Associate the rule criteria derivation algorithm when you want to use the rule type for defining rule based auto pay instructions.

Note: You must associate the rule criteria derivation algorithm with the rule type when the **Rule Type Usage** field is set to **Auto Pay**.

- Click **Save**.

The rule type is defined.

Related Topics

For more information on...	See...
How to define input and output parameters for a rule type	Defining Input and Output Parameters for a Rule Type on page 893
How to associate a characteristic entity with a rule type	Associating a Characteristic Entity with a Rule Type on page 895
How to associate an algorithm with a rule type	Associating an Algorithm with a Rule Type on page 896

Defining Input and Output Parameters for a Rule Type

Prerequisites

To define the input and output parameters for a rule type, you should have:

- Fields defined in the application
- Field search zone defined in the application

Procedure

To define the input and output parameters for a rule type:

- Ensure that the **Input and Output Parameters** section is expanded when you are defining, editing, or copying a rule type.

The **Input and Output Parameters** section contains the following fields in a grid:

Field Name	Field Description	Mandatory (Yes or No)
Sequence	Used to specify the sequence number for the input or output parameter.	Yes
Field	Used to indicate the field that you want to use as the input or output parameter while defining a business rule.	Yes

Field Name	Field Description	Mandatory (Yes or No)
	<p>Note: The Search (🔍) icon appears corresponding to this field. On clicking the Search icon, the Field Search window appears. On specifying the field, the description of the field appears corresponding to the Field.</p>	
Parameter	<p>Used to indicate the parameter that you want to use as the input or output parameter while defining a business rule.</p> <p>Note:</p> <p>The Search (🔍) icon appears corresponding to this field. On clicking the Search icon, the Parameter Search window appears. On specifying the parameter, the description of the parameter appears corresponding to the Parameter field.</p> <p>This field appears when you select the Parameter Based option from the Rule Type Category field.</p>	Yes
Rule Input/Output	<p>Used to indicate whether you want to use the field as input and/or output parameter while defining a business rule. The valid values are:</p> <ul style="list-style-type: none"> • Input • Input and Output • Output <p>Note:</p> <p>By default, the Input option is selected.</p> <p>This field appears when you do not select the Auto Pay option from the Rule Type Usage list.</p>	Yes
Search Zone	<p>Used to indicate the search zone that you want to use for searching the field value while defining criteria for rule based auto pay instructions.</p> <p>Note:</p> <p>The Search (🔍) icon appears corresponding to this field. On clicking the Search icon, the Zone Search window appears.</p> <p>This field appears when you select the Auto Pay option from the Rule Type Usage list.</p>	No

2. Enter the required details in the **Input and Output Parameters** section.

Note:

At present, the following fields are only supported while defining a rule type where the **Rule Type Usage** field is set to **Auto Pay**:

- Policy Number
- Plan Number
- Price Item

If you want to use any other field while defining criteria for rule based auto pay instructions, the implementation team will have to develop the custom logic to implement the requirement.

3. If you want to define more than one input or output parameter for the rule type, click the **Add (+)** icon and then repeat step 2.

Note: However, if you want to remove an input or output parameter from the rule type, click the **Delete (🗑)** icon corresponding to the parameter.

Related Topics

For more information on...	See...
How to define a rule type	Defining a Rule Type on page 891
How to edit a rule type	Editing a Rule Type on page 897
How to copy a rule type	Copying a Rule Type on page 900

Associating a Characteristic Entity with a Rule Type**Prerequisites**

To associate a characteristic entity with a rule type, you should have:

- Values defined for the **RULE_CRITERIA_ENTITY_FLG** lookup field

Procedure

To associate a characteristic entity with a rule type:

1. Ensure that the **Rule Criteria Characteristic Entities** section is expanded when you are defining, editing, or copying a rule type.

The **Rule Criteria Characteristic Entities** section contains the following fields in a grid:

Field Name	Field Description	Mandatory (Yes or No)
Characteristic Entity	Used to indicate the entity whose characteristics you want to use while defining criteria for rule based auto pay instructions. The valid values are: <ul style="list-style-type: none"> • Adjustment • Billable Charge • Policy • Policy Plan • Price Item 	Yes

Field Name	Field Description	Mandatory (Yes or No)
	Note: At present, the characteristics of the above listed entities are only supported while defining criteria for rule based auto pay instructions. If you want to use characteristics of any other entity, the implementation team will have to develop the custom logic to implement the requirement.	

Note: This section appears when you select the **Auto Pay** option from the **Rule Type Usage** list.

- Enter the required details in the **Rule Criteria Characteristic Entities** section.
- If you want to associate more than one characteristic entity with the rule type, click the **Add (+)** icon and then repeat step 2.

Note: However, if you want to remove a characteristic entity from the rule type, click the **Delete (🗑)** icon corresponding to the characteristic entity.

Related Topics

For more information on...	See...
How to define a rule type	Defining a Rule Type on page 891
How to edit a rule type	Editing a Rule Type on page 897
How to copy a rule type	Copying a Rule Type on page 900

Associating an Algorithm with a Rule Type

Prerequisites

To associate an algorithm with a rule type, you should have:

- Rule criteria derivation algorithm defined using the **C1-APRCRIDER** algorithm type

Procedure

To associate an algorithm with a rule type:

- Ensure that the **Rule Criteria Derivation Algorithms** section is expanded when you are defining, editing, or copying a rule type.

The **Rule Criteria Derivation Algorithms** section contains the following fields in a grid:

Field Name	Field Description	Mandatory (Yes or No)
Sequence	Used to indicate the order in which the algorithm should be executed.	Yes
Algorithm	Used to attach an algorithm which you want to use for deriving the following from the financial transaction: <ul style="list-style-type: none"> Values of all those fields (such as, policy number, plan number, or price item) which are selected in the rule type as the input and output parameters Characteristics of all those entities which are selected in the rule type as the rule criteria characteristic entities 	Yes

Field Name	Field Description	Mandatory (Yes or No)
	Note: The Search (🔍) icon appears corresponding to this field. On clicking the Search icon, the Algorithm Search window appears.	

Note: This section appears when you select the **Auto Pay** option from the **Rule Type Usage** list.

- Enter the required details in the **Rule Criteria Derivation Algorithms** section.
- If you want to associate more than one algorithm with the rule type, click the **Add** (+) icon and then repeat step 2.

Note: However, if you want to remove an algorithm from the rule type, click the **Delete** (🗑️) icon corresponding to the algorithm.

Related Topics

For more information on...	See...
How to define a rule type	Defining a Rule Type on page 891
How to edit a rule type	Editing a Rule Type on page 897
How to copy a rule type	Copying a Rule Type on page 900

Editing a Rule Type

Procedure

To edit a rule type:

- Search for the rule type in the **Rule Type** screen.
- In the **Search Results** section, click the **Edit** (✎) icon in the **Edit** column corresponding to the rule type whose details you want to edit.

The **Rule Type** screen appears. It contains the following sections:

- Main** - Used to specify basic details about the rule type.
- Input and Output Parameters** - Used to define input and output parameters for the rule type.
- Rule Criteria Characteristic Entities** - Used to indicate the entities whose characteristics you can use while defining rule based auto pay instructions using the rule type.

Note: This section appears when you select the **Auto Pay** option from the **Rule Type Usage** list.

- Rule Criteria Derivation Algorithms** - Used to attach algorithms which you want to use for deriving the following from the financial transaction:
 - Values of all those fields (such as, policy number, plan number, or price item) which are selected in the rule type as the input and output parameters
 - Characteristics of all those entities which are selected in the rule type as the rule criteria characteristic entities

Note: This section appears when you select the **Auto Pay** option from the **Rule Type Usage** list.

The **Main** section contains the following fields:

Field Name	Field Description	Mandatory (Yes or No)
Rule Type	Displays the rule type.	Not applicable
	Note: This is a read-only field.	
Rule Type Usage	Indicates whether the rule type is used for defining rule based auto pay instructions or for defining business rules for mapping transactions with the price items. The valid values are: <ul style="list-style-type: none"> • Line Item Eligibility • Mark Up/Mark Down Eligibility • Domestic Provider Eligibility • Auto Pay • File Upload Interface • Price Item Eligibility • Related Pricing Rule Type Eligibility 	Not applicable
	Note: This is a read-only field.	
Description	Used to specify the description for the rule type.	Yes
Maximum Rule Count	Used to indicate the maximum number of rules that can be defined when the rule based auto pay instruction is created using the rule type.	No
	Note: This field appears when the Rule Type Usage field is set to Auto Pay . The maximum rule count cannot be less than or equal to zero. You cannot reduce the maximum rule count when one or more auto pay instructions contain the specified number of rules.	
Rule Type Category	Used to indicate whether you want to create a field based or parameter based rule type. The valid values are: <ul style="list-style-type: none"> • Field Based • Parameter Based 	No
	Note: This field appears when you have selected the Price Item Eligibility or Related Pricing Rule Type Eligibility option from the Rule Type Usage list while defining a rule type. This is a read-only field.	

Tip: Alternatively, you can edit the details of a rule type by clicking the **Edit** link in the **Rule Type** zone.

3. Modify the required details in the **Main** section.

- Define, edit, or remove input or output parameters from the rule type, if required.

Note: You cannot edit or remove an input or output parameter from the rule type when it is used for defining criteria in a business rule or rule based auto pay instruction.

- Associate or remove one or more characteristic entities from the rule type, if required.

Note:

You must specify at least one input or output parameter when you want to use the rule type for defining business rules for mapping transactions with the price items. However, you must specify at least one input or output parameter or associate at least one characteristic entity when you want to use the rule type for defining rule based auto pay instructions.

You cannot remove a characteristic entity from the rule type when it is used for defining criteria in a rule based auto pay instruction.

- Associate or remove one or more rule criteria derivation algorithm from the rule type, if required.

Note: You must associate the rule criteria derivation algorithm with the rule type when the **Rule Type Usage** field is set to **Auto Pay**.

- Click **Save**.

The changes made to the rule type are saved.

Related Topics

For more information on...	See...
How to search for a rule type	Searching for a Rule Type on page 890
How to define input and output parameters for a rule type	Defining Input and Output Parameters for a Rule Type on page 893
How to associate a characteristic entity with a rule type	Associating a Characteristic Entity with a Rule Type on page 895
How to associate an algorithm with a rule type	Associating an Algorithm with a Rule Type on page 896
Rule Type zone	Rule Type on page 902

Deleting a Rule Type

Procedure

To delete a rule type:

- Search for the rule type in the **Rule Type** screen.
- In the **Search Results** section, click the **Delete** (🗑️) icon in the **Delete** column corresponding to the rule type that you want to delete.

A message appears confirming whether you want to delete the rule type.

Note: You can delete a rule type when the rule based auto pay instructions or business rules are not yet defined using the rule type.

- Click **OK**.

The rule type is deleted.

Related Topics

For more information on...	See...
How to search for a rule type	Searching for a Rule Type on page 890

Copying a Rule Type

Instead of creating a rule type from scratch, you can create a new rule type using an existing rule type. This is possible through copying a rule type. On copying a rule type, the details including the input and output parameters, rule criteria characteristic entities, and rule criteria derivation algorithms are copied to the new rule type. You can then edit the details, if required.

Prerequisites

To copy a rule type, you should have:

- Rule type (whose copy you want to create) defined in the application
- Values defined for the **C1_RULE_USAGE_FLG** lookup field
- Values defined for the **RULE_TYPE_CAT_FLG** lookup field

Procedure

To copy a rule type:

1. Search for the rule type in the **Rule Type** screen.
2. In the **Search Results** section, click the **Copy** (📄) icon in the **Copy** column corresponding to the rule type whose copy you want to create.

The **Rule Type** screen appears. It contains the following sections:

- **Main** - Used to specify basic details about the rule type.
- **Input and Output Parameters** - Used to define input and output parameters for the rule type.
- **Rule Criteria Characteristic Entities** - Used to indicate the entities whose characteristics you can use while defining rule based auto pay instructions using the rule type.

Note: This section appears when you select the **Auto Pay** option from the **Rule Type Usage** list.

- **Rule Criteria Derivation Algorithms** - Used to attach algorithms which you want to use for deriving the following from the financial transaction:
 - Values of all those fields (such as, policy number, plan number, or price item) which are selected in the rule type as the input and output parameters
 - Characteristics of all those entities which are selected in the rule type as the rule criteria characteristic entities

Note: This section appears when you select the **Auto Pay** option from the **Rule Type Usage** list.

The **Main** section contains the following fields:

Field Name	Field Description	Mandatory (Yes or No)
Rule Type	Used to specify the rule type.	Yes
Rule Type Usage	Used to indicate whether you want to use the rule type for defining rule based auto pay instructions or for defining business rules for mapping transactions with the price items. The valid values are: <ul style="list-style-type: none"> • Line Item Eligibility 	No

Field Name	Field Description	Mandatory (Yes or No)
	<ul style="list-style-type: none"> Mark Up/Mark Down Eligibility Domestic Provider Eligibility Auto Pay File Upload Interface Price Item Eligibility Related Pricing Rule Type Eligibility <p>Note: If you want to use the rule type for defining rule based auto pay instructions, you must set the rule type usage to Auto Pay. However, if you want to use the rule type for defining business rules for mapping transactions with the price items, you must leave this field blank.</p>	
Description	Used to specify the description for the rule type.	Yes
Maximum Rule Count	<p>Used to indicate the maximum number of rules that can be defined when the rule based auto pay instruction is created using the rule type.</p> <p>Note: This field appears when you select the Auto Pay option from the Rule Type Usage list. The maximum rule count cannot be less than or equal to zero.</p>	No
Rule Type Category	<p>Used to indicate whether you want to create a field based or parameter based rule type. The valid values are:</p> <ul style="list-style-type: none"> Field Based Parameter Based <p>Note: This field appears when you select the Price Item Eligibility or Related Pricing Rule Type Eligibility option from the Rule Type Usage list. By default the value of this option type is set to Field Based.</p>	No

- Enter the required details in the **Main** section.
- Define, edit, or remove input or output parameters from the rule type, if required.

Note: On selecting the **Parameter Based** option from the **Rule Type Category** list, the **Parameter** column appears in the **Input and Output Parameters** section. Here, you can specify a parameter whether the parameter usage is set to **Rule Eligibility Criteria**.

- Associate or remove one or more characteristic entities from the rule type, if required.

Note: You must specify at least one input or output parameter when you want to use the rule type for defining business rules for mapping transactions with the price items. However, you must specify at least one input or output parameter or associate at least one characteristic entity when you want to use the rule type for defining rule based auto pay instructions.

- Associate the rule criteria derivation algorithm when you want to use the rule type for defining rule based auto pay instructions.

Note: You must associate the rule criteria derivation algorithm with the rule type when the **Rule Type Usage** field is set to **Auto Pay**.

- Click **Save**.

The new rule type is defined.

Related Topics

For more information on...	See...
How to search for a rule type	Searching for a Rule Type on page 890
How to define input and output parameters for a rule type	Defining Input and Output Parameters for a Rule Type on page 893
How to associate a characteristic entity with a rule type	Associating a Characteristic Entity with a Rule Type on page 895
How to associate an algorithm with a rule type	Associating an Algorithm with a Rule Type on page 896

Rule Type (Used for Viewing)

The **Rule Type** screen allows you to view the details of the rule type. It contains the following zone:

- [Rule Type](#) on page 902

Rule Type

The **Rule Type** zone displays the details of the rule type. It contains the following sections:

- Main** - Displays basic information about the rule type. It contains the following fields:

Field Name	Field Description
Rule Type	Displays the rule type.
Rule Type Usage	Indicates whether the rule type is used for defining rule based auto pay instructions or for defining business rules for mapping transactions with the price items. The valid values are: <ul style="list-style-type: none"> Line Item Eligibility Mark Up/Mark Down Eligibility Domestic Provider Eligibility Auto Pay File Upload Interface Price Item Eligibility Related Pricing Rule Type Eligibility

Field Name	Field Description
	Note: This field appears when the rule type usage is specified while defining the rule type.
Description	Displays the description of the rule type.
Maximum Rule Count	Indicates the maximum number of rules that can be defined when the rule based auto pay instruction is created using the rule type. Note: This field appears when the Rule Type Usage field is set to Auto Pay .
Rule Type Category	Indicates whether you want to create a field based or parameter based rule type. The valid values are: <ul style="list-style-type: none"> Field Based Parameter Based Note: This field appears when you select the Price Item Eligibility or Related Pricing Rule Type Eligibility option from the Rule Type Usage list while defining the rule type.

- **Input and Output Parameters** - Lists the input and output parameters defined for the rule type. It contains the following columns:

Column Name	Column Description
Sequence	Displays the sequence number of the input or output parameter.
Field	Indicates the field which is used as the input or output parameter.
Parameter	Indicates the parameter that you want to use as the input or output parameter.
Rule Input/Output	Indicates whether the field is used as input and/or output parameter while defining a business rule.
Search Zone	Indicates the search zone that is used for searching the field value while defining criteria for rule based auto pay instructions. Note: It has a link. On clicking the link, the Zone screen appears where you can view the details of the zone.

- **Rule Criteria Characteristic Entities** - This section contains the following column:

Column Name	Column Description
Characteristic Entity	Indicates the entity whose characteristics can be used while defining criteria for rule based auto pay instructions. The valid values are: <ul style="list-style-type: none"> Adjustment Billable Charge Policy Policy Plan Price Item

- **Rule Criteria Derivation Algorithms** - Lists the algorithms attached to the rule type. It contains the following columns:

Column Name	Column Description
Sequence	Indicates the order in which the algorithm should be executed.
Algorithm	Indicates the algorithm attached to the rule type which derives the following from the financial transaction: <ul style="list-style-type: none"> • Values of all those fields (such as, policy number, plan number, or price item) which are selected in the rule type as the input and output parameters • Characteristics of all those entities which are selected in the rule type as the rule criteria characteristic entities

Note: The **Rule Criteria Characteristic Entities** and **Rule Criteria Derivation Algorithms** sections appear when the **Rule Type Usage** field is set to **Auto Pay**.

You can edit the details of the rule type by clicking the **Edit** link in the upper-right corner of this zone.

Related Topics

For more information on...	See...
How to edit a rule type	Editing a Rule Type on page 897

Viewing the Rule Type Details

Procedure

To view the details of a rule type:

1. Search for the rule type in the **Rule Type** screen.
2. In the **Search Results** section, click the **View** () icon in the **View** column corresponding to the rule type whose details you want to view.

The **Rule Type** screen appears.

3. View the details of the rule type in the **Rule Type** zone.

Related Topics

For more information on...	See...
How to search for a rule type	Searching for a Rule Type on page 890
Rule Type screen	Rule Type (Used for Viewing) on page 902
Rule Type zone	Rule Type on page 902

Editing a Rule Type

Procedure

To edit a rule type:

1. Search for the rule type in the **Rule Type** screen.
2. In the **Search Results** section, click the **Edit** () icon in the **Edit** column corresponding to the rule type whose details you want to edit.

The **Rule Type** screen appears. It contains the following sections:

- **Main** - Used to specify basic details about the rule type.

- **Input and Output Parameters** - Used to define input and output parameters for the rule type.
- **Rule Criteria Characteristic Entities** - Used to indicate the entities whose characteristics you can use while defining rule based auto pay instructions using the rule type.

Note: This section appears when you select the **Auto Pay** option from the **Rule Type Usage** list.

- **Rule Criteria Derivation Algorithms** - Used to attach algorithms which you want to use for deriving the following from the financial transaction:
 - Values of all those fields (such as, policy number, plan number, or price item) which are selected in the rule type as the input and output parameters
 - Characteristics of all those entities which are selected in the rule type as the rule criteria characteristic entities

Note: This section appears when you select the **Auto Pay** option from the **Rule Type Usage** list.

The **Main** section contains the following fields:

Field Name	Field Description	Mandatory (Yes or No)
Rule Type	Displays the rule type.	Not applicable
	Note: This is a read-only field.	
Rule Type Usage	Indicates whether the rule type is used for defining rule based auto pay instructions or for defining business rules for mapping transactions with the price items. The valid values are: <ul style="list-style-type: none"> • Line Item Eligibility • Mark Up/Mark Down Eligibility • Domestic Provider Eligibility • Auto Pay • File Upload Interface • Price Item Eligibility • Related Pricing Rule Type Eligibility 	Not applicable
	Note: This is a read-only field.	
Description	Used to specify the description for the rule type.	Yes
Maximum Rule Count	Used to indicate the maximum number of rules that can be defined when the rule based auto pay instruction is created using the rule type.	No
	Note: This field appears when the Rule Type Usage field is set to Auto Pay . The maximum rule count cannot be less than or equal to zero. You cannot reduce the maximum rule count when one or more auto pay instructions contain the specified number of rules.	

Field Name	Field Description	Mandatory (Yes or No)
Rule Type Category	<p>Used to indicate whether you want to create a field based or parameter based rule type. The valid values are:</p> <ul style="list-style-type: none"> Field Based Parameter Based 	No
	<p>Note:</p> <p>This field appears when you have selected the Price Item Eligibility or Related Pricing Rule Type Eligibility option from the Rule Type Usage list while defining a rule type.</p> <p>This is a read-only field.</p>	

Tip: Alternatively, you can edit the details of a rule type by clicking the **Edit** link in the **Rule Type** zone.

- Modify the required details in the **Main** section.
- Define, edit, or remove input or output parameters from the rule type, if required.

Note: You cannot edit or remove an input or output parameter from the rule type when it is used for defining criteria in a business rule or rule based auto pay instruction.

- Associate or remove one or more characteristic entities from the rule type, if required.

Note:

You must specify at least one input or output parameter when you want to use the rule type for defining business rules for mapping transactions with the price items. However, you must specify at least one input or output parameter or associate at least one characteristic entity when you want to use the rule type for defining rule based auto pay instructions.

You cannot remove a characteristic entity from the rule type when it is used for defining criteria in a rule based auto pay instruction.

- Associate or remove one or more rule criteria derivation algorithm from the rule type, if required.

Note: You must associate the rule criteria derivation algorithm with the rule type when the **Rule Type Usage** field is set to **Auto Pay**.

- Click **Save**.

The changes made to the rule type are saved.

Related Topics

For more information on...	See...
How to search for a rule type	Searching for a Rule Type on page 890
How to define input and output parameters for a rule type	Defining Input and Output Parameters for a Rule Type on page 893
How to associate a characteristic entity with a rule type	Associating a Characteristic Entity with a Rule Type on page 895
How to associate an algorithm with a rule type	Associating an Algorithm with a Rule Type on page 896

For more information on...	See...
Rule Type zone	Rule Type on page 902

Rule

The **Rule** screen allows you to define, edit, delete, and copy a rule. This screen consists of the following zones:

- [Search Rule](#) on page 907



Search Rule

The **Search Rule** zone allows you to search for a rule. This zone contains the following two sections:

- **Search Criteria** - The **Search Criteria** section contains the following fields:

Field Name	Field Description	Mandatory (Yes or No)
Rule	Used to specify the rule code.	No
Rule Type	Used to specify the type of rule.	No
Description	Used to specify the description for the rule.	No
Rule Priority	Used to specify the priority of the rule.	No
Effective Start Date	Used to specify the date from when the rule is effective.	No

- **Search Results** - On clicking the **Search** button, the search results appear based on the specified search criteria. The **Search Results** section contains the following columns:

Column Name	Column Description
Rule Priority	Displays the priority of the rule.
Rule	Displays the rule code.
Description	Displays the description of the rule.
Rule Type	Displays the type of rule.
Effective Start Date	Displays the date from when the rule is effective.
Effective End Date	Displays the date till when the rule is effective.
Pre-Processing Algorithm	Indicates the algorithm that will be triggered before executing the criteria in the rule. It pre-processes the input parameters and then returns processed values against which the criteria is validated.
Post-Processing Algorithm	Indicates the algorithm that will be triggered when the rule is true. It post-processes the output parameters and returns the updated values to the calling programs or dependent rules.
View	On clicking the View () icon, the View Rule screen appears where you can view the details of the rule.
Edit	On clicking the Edit () icon, the Edit Rule screen appears where you can edit the details of the rule.
Delete	On clicking the Delete () icon, you can delete the rule.

Column Name	Column Description
	Note: You can delete a rule only if it is not used.
Duplicate	On clicking the Duplicate () icon, the Copy Rule screen appears where you can create a rule using an existing rule.

You can create a new rule by clicking the **Add** link in the upper right corner of this zone.

Related Topics

For more information on...	See...
How to search for a rule	Searching for a Rule on page 908
How to view the details of a rule	Viewing the Rule Details on page 909
How to define a rule	Defining a Rule on page 909
How to edit a rule	Editing a Rule on page 914
How to delete a rule	Deleting a Rule on page 920
How to copy a rule	Copying a Rule on page 921

Searching for a Rule

Procedure

To search for a rule:

1. Click the **Admin** link in the **Application** toolbar.
A list appears.
2. From the **Admin** menu, select **R** and then click **Rule**.
A sub-menu appears.
3. Click the **Search** option from the **Rule** sub-menu.
The **Rule** screen appears.
4. Enter the search criteria in the **Search** zone.

Note: ORMB search engine supports wildcard search, where you can substitute the percentage (%) symbol as a stand in for any word or letter in a search criteria. You can use the ‘%’ wildcard character in all input fields except the date and ID fields. The ‘%’ wildcard character is suffixed automatically at the end of the partial search criteria. Therefore, you may or may not specify the wildcard character at the end of the partial search criteria. However, you have to prefix the wildcard character manually wherever required.

5. Click **Search**.
A list of rules that meet the search criteria appears in the **Search Results** section.

Related Topics

For more information on...	See...
Rule screen	Rule on page 907
Search zone	Search Rule on page 907

Viewing the Rule Details

Procedure

To view the details of a rule:

1. Search for the rule in the **Rule** screen.
2. In the **Search Results** section, click the **View** () icon in the **View** column corresponding to the rule whose details you want to view.

The **View Rule** screen appears.

3. View the details of the rule in the **Rule Information** zone.

Related Topics

For more information on...	See...
View Rule screen	Rule on page 926
Rule Information zone	Rule Information on page 927
How to search for a rule	Searching for a Rule Type on page 890

Defining a Rule

Prerequisites

To define a rule, you should have:

- Rule types defined in the application
- Pre-processing and post-processing algorithms, dependent rules, and parameters defined in the application in case you want to use any of them

Procedure

To define a rule:

1. Click the **Admin** link in the **Application** toolbar.
A list appears.
2. From the **Admin** menu, select **R** and then click **Rule**.

A sub-menu appears.

3. Click the **Add** option from the **Rule** sub-menu.

The **Rule** screen appears. It contains the following fields:

Field Name	Field Description	Mandatory (Yes or No)
Rule	Used to specify the rule code.	Yes
Rule Type	Used to specify the type of rule.	Yes
Description	Used to specify the description for the rule.	Yes
Rule Priority	Used to specify the priority of the rule.	Yes
	Note: You cannot define two rules with the same rule type and priority in the same duration.	

Field Name	Field Description	Mandatory (Yes or No)
Effective Start Date	Used to specify the date from when the rule is effective.	Yes
Effective End Date	Used to specify the date till when the rule is effective.	No
	Note: The effective end date cannot be earlier than the effective start date.	
Pre-Processing Algorithm	Used to specify the algorithm that will be triggered before executing the criteria in the rule. It pre-processes the input parameters and then returns processed values against which the criteria is validated.	No
	Note: The Search (🔍) icon appears corresponding to this field. On clicking the Search icon, the Algorithm Search window appears. On specifying the algorithm, the description of the algorithm appears corresponding to the Pre-Processing Algorithm field.	
Post-Processing Algorithm	Used to specify the algorithm that will be triggered when the rule is true. It post-processes the output parameters and returns the updated values to the calling programs or dependent rules.	No
	Note: The Search (🔍) icon appears corresponding to this field. On clicking the Search icon, the Algorithm Search window appears. On specifying the algorithm, the description of the algorithm appears corresponding to the Post-Processing Algorithm field.	
Rule True Action	Used to indicate what should happen when all conditions in the rule are satisfied and returns Rule is True . The valid values are: <ul style="list-style-type: none"> • Next Dependent Rule — Used to indicate that the dependent rule should be executed when the rule is true. • Next Rule by Priority — Used to indicate that the rule of the same rule type having lower priority should be executed when the rule is true. • Success — Used to indicate that no more rules should be executed when the rule is true. The output parameters and their values are returned to the calling programs. 	Yes
Dependent Rule	Used to specify the next dependent rule that must be executed when Next Dependent Rule is selected from the Rule True Action list.	Yes (Conditional)

Field Name	Field Description	Mandatory (Yes or No)
		Note: This field is required when you select Next Dependent Rule from the Rule True Action list.
Rule False Action	Used to indicate what should happen when any of the criteria in the rule is not satisfied and returns Rule is False . The valid values are: <ul style="list-style-type: none"> • Next Dependent Rule — Used to indicate that the dependent rule should be executed when the rule is false. • Next Rule by Priority — Used to indicate that the rule of the same rule type having lower priority should be executed when the rule is false. • Success — Used to indicate that no more rules should be executed when the rule is false. The output parameters and their values are returned to the calling programs. 	Yes
Dependent Rule	Used to specify the next dependent rule that must be executed when Next Dependent Rule is selected from the Rule False Action list.	Yes (Conditional) Note: This field is required when you select Next Dependent Rule from the Rule False Action list.







In addition, it contains the following two sections:







- **Rule Output Parameters** — Used to specify the output parameters that must be returned to the calling programs or dependent rules when all conditions in the rule are satisfied. This section contains the following columns:

Column Name	Column Description	Mandatory (Yes or No)
Parameter Name	Used to specify the parameter. Note: For more information about the output parameters that you can specify while defining a rule, see Transaction Validation and Initial Price Item Determination (Specific to Financial Services Domain) on page 995. The Search (🔍) icon appears corresponding to this field. On clicking the Search icon, the Search Input or Output Parameter window appears. On specifying the parameter, the parameter description appears corresponding to the Parameter Name field.	Yes
Parameter Value	Used to specify the value for the parameter.	Yes

Column Name	Column Description	Mandatory (Yes or No)
	Note: You can specify any special characters except ampersand (&), comma (,), underscore (_), equal to (=), tilde (~), and semi-colon(;); in the parameter value.	

- **Criteria** — Used to define criteria for the rule. This section contains the following columns:

Column Name	Column Description	Mandatory (Yes or No)						
Sequence Number	Used to indicate the order in which the criteria should be executed in the rule.	Yes						
Parameter Name	<p>Used to indicate whether you want to specify a field or an algorithm as an input parameter. The valid values are:</p> <ul style="list-style-type: none"> • Field • Algorithm <p>Note: By default, the Field option is selected.</p> <p>If a business label is defined for a user defined field (that you have selected), the business label appears in the Parameter Name field.</p> <table border="1"> <thead> <tr> <th>If the parameter name is selected as ...</th> <th>Then...</th> </tr> </thead> <tbody> <tr> <td>Field</td> <td> <p>The Search  icon appears corresponding to this field. On clicking the Search icon, the Search Input or Output Parameter window appears.</p> <p>On specifying the field, the field description appears corresponding to the Parameter Name field.</p> </td> </tr> <tr> <td>Algorithm</td> <td> <p>The Search  icon appears corresponding to this field. On clicking the Search icon, the Algorithm Search window appears.</p> <p>On specifying the algorithm, the algorithm description appears corresponding to the Parameter Name field.</p> </td> </tr> </tbody> </table>	If the parameter name is selected as ...	Then...	Field	<p>The Search  icon appears corresponding to this field. On clicking the Search icon, the Search Input or Output Parameter window appears.</p> <p>On specifying the field, the field description appears corresponding to the Parameter Name field.</p>	Algorithm	<p>The Search  icon appears corresponding to this field. On clicking the Search icon, the Algorithm Search window appears.</p> <p>On specifying the algorithm, the algorithm description appears corresponding to the Parameter Name field.</p>	Yes
If the parameter name is selected as ...	Then...							
Field	<p>The Search  icon appears corresponding to this field. On clicking the Search icon, the Search Input or Output Parameter window appears.</p> <p>On specifying the field, the field description appears corresponding to the Parameter Name field.</p>							
Algorithm	<p>The Search  icon appears corresponding to this field. On clicking the Search icon, the Algorithm Search window appears.</p> <p>On specifying the algorithm, the algorithm description appears corresponding to the Parameter Name field.</p>							
Operator	Used to specify the relational operator to define the relation between the parameter name and value.	Yes						
Parameter Value	<p>Used to specify the parameter value. The valid values are:</p> <ul style="list-style-type: none"> • Field 	Yes						

Column Name	Column Description	Mandatory (Yes or No)						
	<ul style="list-style-type: none"> Algorithm <p>Note:</p> <p>By default, the Field option is selected.</p> <p>You can specify any special characters except ampersand (&), comma (,), underscore (_), equal to (=), tilde (~), and semi-colon(; in the parameter value.</p> <table border="1" data-bbox="586 506 1247 1213"> <thead> <tr> <th data-bbox="586 506 773 646">If the parameter value is selected as ...</th> <th data-bbox="773 506 1247 646">Then...</th> </tr> </thead> <tbody> <tr> <td data-bbox="586 646 773 932">Field</td> <td data-bbox="773 646 1247 932"> <p>The Search  icon appears corresponding to this field. On clicking the Search icon, the Search Input or Output Parameter window appears.</p> <p>On specifying the field, the field description appears corresponding to the Parameter Value field.</p> </td> </tr> <tr> <td data-bbox="586 932 773 1213">Algorithm</td> <td data-bbox="773 932 1247 1213"> <p>The Search  icon appears corresponding to this field. On clicking the Search icon, the Algorithm Search window appears.</p> <p>On specifying the algorithm, the algorithm description appears corresponding to the Parameter Value field.</p> </td> </tr> </tbody> </table>	If the parameter value is selected as ...	Then...	Field	<p>The Search  icon appears corresponding to this field. On clicking the Search icon, the Search Input or Output Parameter window appears.</p> <p>On specifying the field, the field description appears corresponding to the Parameter Value field.</p>	Algorithm	<p>The Search  icon appears corresponding to this field. On clicking the Search icon, the Algorithm Search window appears.</p> <p>On specifying the algorithm, the algorithm description appears corresponding to the Parameter Value field.</p>	
If the parameter value is selected as ...	Then...							
Field	<p>The Search  icon appears corresponding to this field. On clicking the Search icon, the Search Input or Output Parameter window appears.</p> <p>On specifying the field, the field description appears corresponding to the Parameter Value field.</p>							
Algorithm	<p>The Search  icon appears corresponding to this field. On clicking the Search icon, the Algorithm Search window appears.</p> <p>On specifying the algorithm, the algorithm description appears corresponding to the Parameter Value field.</p>							
Is True	<p>Used to indicate what should happen when the condition is true (satisfied). The valid values are:</p> <ul style="list-style-type: none"> Check next condition — Used to indicate that the condition with consecutive sequence number should be executed. Rule is false — Used to indicate that the action specified in the Rule False Action field should be executed. Rule is true — Used to indicate that the action specified in the Rule True Action field should be executed. 	Yes						
Is False	<p>Used to indicate what should happen when the condition is false (not satisfied). The valid values are:</p> <ul style="list-style-type: none"> Check next condition — Used to indicate that the condition with consecutive sequence number should be executed. Rule is false — Used to indicate that the action specified in the Rule False Action field should be executed. 	Yes						

Column Name	Column Description	Mandatory (Yes or No)
	<ul style="list-style-type: none"> Rule is true — Used to indicate that the action specified in the Rule True Action field should be executed. 	
Is Insufficient	<p>Used to indicate what should happen when the data is insufficient. The valid values are:</p> <ul style="list-style-type: none"> Check next condition — Used to indicate that the condition with consecutive sequence number should be executed. Rule is false — Used to indicate that the action specified in the Rule False Action field should be executed. Rule is true — Used to indicate that the action specified in the Rule True Action field should be executed. 	Yes

Tip: Alternatively, you can access the **Add Rule** screen by clicking the **Add** link in the upper right corner of the **Search** zone in the **Rule** screen.

4. Enter the required details.

Note:

You can search for a parameter, dependent rule and an algorithm by clicking the **Search** (🔍) icon corresponding to the respective field.

If you want to associate more than one output parameter with the rule or define more than one criteria for the rule, click the **Add** (+) icon and then specify the details. However, if you want to remove an output parameter or a criteria from the rule, click the **Delete** (🗑️) icon corresponding to it.

5. Click **Save**.

The rule is defined.

Related Topics

For more information on...	See...
Rule screen	Rule on page 907
Search zone	Search Rule on page 907

Editing a Rule

Prerequisites

To edit a rule, you should have:

- Pre-processing and post-processing algorithms, dependent rules, and parameters defined in the application in case you want to use any of them.

Procedure

To edit a rule:

- Search for the rule in the **Rule** screen.
- In the **Search Results** section, click the **Edit** (✎) icon in the **Edit** column corresponding to the rule whose details you want to edit.

The **Rule** screen appears. It contains the following fields:

Field Name	Field Description	Mandatory (Yes or No)
Rule	Used to specify the rule code.	Yes
Rule Type	Used to specify the type of rule.	Yes
Description	Used to specify the description for the rule.	Yes
Rule Priority	Used to specify the priority of the rule. Note: You cannot define two rules with the same rule type and priority in the same duration.	Yes
Effective Start Date	Used to specify the date from when the rule is effective.	Yes
Effective End Date	Used to specify the date till when the rule is effective. Note: The effective end date cannot be earlier than the effective start date.	No
Pre-Processing Algorithm	Used to specify the algorithm that will be triggered before executing the criteria in the rule. It pre-processes the input parameters and then returns processed values against which the criteria is validated. Note: The Search (🔍) icon appears corresponding to this field. On clicking the Search icon, the Algorithm Search window appears. On specifying the algorithm, the description of the algorithm appears corresponding to the Pre-Processing Algorithm field.	No
Post-Processing Algorithm	Used to specify the algorithm that will be triggered when the rule is true. It post-processes the output parameters and returns the updated values to the calling programs or dependent rules. Note: The Search (🔍) icon appears corresponding to this field. On clicking the Search icon, the Algorithm Search window appears. On specifying the algorithm, the description of the algorithm appears corresponding to the Post-Processing Algorithm field.	No
Rule True Action	Used to indicate what should happen when all conditions in the rule are satisfied and returns Rule is True . The valid values are: <ul style="list-style-type: none"> • Next Dependent Rule — Used to indicate that the dependent rule should be executed when the rule is true. 	Yes

Field Name	Field Description	Mandatory (Yes or No)
	<ul style="list-style-type: none"> • Next Rule by Priority — Used to indicate that the rule of the same rule type having lower priority should be executed when the rule is true. • Success — Used to indicate that no more rules should be executed when the rule is true. The output parameters and their values are returned to the calling programs. 	
Dependent Rule	Used to specify the next dependent rule that must be executed when Next Dependent Rule is selected from the Rule True Action list.	Yes (Conditional) Note: This field is required when you select Next Dependent Rule from the Rule True Action list.
Rule False Action	Used to indicate what should happen when any of the criteria in the rule is not satisfied and returns Rule is False . The valid values are: <ul style="list-style-type: none"> • Next Dependent Rule — Used to indicate that the dependent rule should be executed when the rule is false. • Next Rule by Priority — Used to indicate that the rule of the same rule type having lower priority should be executed when the rule is false. • Success — Used to indicate that no more rules should be executed when the rule is false. The output parameters and their values are returned to the calling programs. 	Yes
Dependent Rule	Used to specify the next dependent rule that must be executed when Next Dependent Rule is selected from the Rule False Action list.	Yes (Conditional) Note: This field is required when you select Next Dependent Rule from the Rule False Action list.

In addition, it contains the following two sections:







- **Rule Output Parameters** — Used to specify the output parameters that must be returned to the calling programs or dependent rules when all conditions in the rule are satisfied. This section contains the following columns:

Column Name	Column Description	Mandatory (Yes or No)
Parameter Name	Used to specify the parameter.	Yes

Column Name	Column Description	Mandatory (Yes or No)
	<p>Note: For more information about the output parameters that you can specify while defining a rule, see Transaction Validation and Initial Price Item Determination (Specific to Financial Services Domain) on page 995.</p> <p>The Search (🔍) icon appears corresponding to this field. On clicking the Search icon, the Search Rule Type Field window appears.</p> <p>On specifying the rule type field, the description of the rule type field appears corresponding to the Parameter Name field.</p>	
Parameter Value	<p>Used to specify the value for the parameter.</p> <p>Note: You can specify any special characters except ampersand (&), comma (,), underscore (_), equal to (=), tilde (~), and semi-colon(;) in the parameter value.</p>	Yes

- **Criteria** — Used to define criteria for the rule. This section contains the following columns:

Column Name	Column Description	Mandatory (Yes or No)
Sequence Number	Used to indicate the order in which the criteria should be executed in the rule.	Yes
Parameter Name	<p>Used to indicate whether you want to specify a field or an algorithm as an input parameter. The valid values are:</p> <ul style="list-style-type: none"> • Field • Algorithm 	Yes

Column Name	Column Description	Mandatory (Yes or No)						
	<p>Note:</p> <p>By default, the Field option is selected.</p> <p>If a business label is defined for a user defined field (that you have selected), the business label appears in the Parameter Name field.</p> <table border="1" data-bbox="602 457 1263 1199"> <thead> <tr> <th data-bbox="602 457 773 636">If the parameter name is selected as ...</th> <th data-bbox="773 457 1263 636">Then...</th> </tr> </thead> <tbody> <tr> <td data-bbox="602 636 773 919">Field</td> <td data-bbox="773 636 1263 919"> <p>The Search  icon appears corresponding to this field. On clicking the Search icon, the Search Input or Output Parameter window appears.</p> <p>On specifying the field, the field description appears corresponding to the Parameter Name field.</p> </td> </tr> <tr> <td data-bbox="602 919 773 1199">Algorithm</td> <td data-bbox="773 919 1263 1199"> <p>The Search  icon appears corresponding to this field. On clicking the Search icon, the Algorithm Search window appears.</p> <p>On specifying the algorithm, the algorithm description appears corresponding to the Parameter Name field.</p> </td> </tr> </tbody> </table>	If the parameter name is selected as ...	Then...	Field	<p>The Search  icon appears corresponding to this field. On clicking the Search icon, the Search Input or Output Parameter window appears.</p> <p>On specifying the field, the field description appears corresponding to the Parameter Name field.</p>	Algorithm	<p>The Search  icon appears corresponding to this field. On clicking the Search icon, the Algorithm Search window appears.</p> <p>On specifying the algorithm, the algorithm description appears corresponding to the Parameter Name field.</p>	
If the parameter name is selected as ...	Then...							
Field	<p>The Search  icon appears corresponding to this field. On clicking the Search icon, the Search Input or Output Parameter window appears.</p> <p>On specifying the field, the field description appears corresponding to the Parameter Name field.</p>							
Algorithm	<p>The Search  icon appears corresponding to this field. On clicking the Search icon, the Algorithm Search window appears.</p> <p>On specifying the algorithm, the algorithm description appears corresponding to the Parameter Name field.</p>							
Operator	Used to specify the relational operator to define the relation between the parameter name and value.	Yes						
Parameter Value	Used to specify the parameter value. The valid values are: <ul style="list-style-type: none"> • Field • Algorithm 	Yes						

Column Name	Column Description	Mandatory (Yes or No)						
	<p>Note:</p> <p>By default, the Field option is selected.</p> <p>You can specify any special characters except ampersand (&), comma (,), underscore (_), equal to (=), tilde (~), and semi-colon(;), in the parameter value.</p> <table border="1" data-bbox="602 457 1263 1171"> <thead> <tr> <th data-bbox="602 457 764 636">If the parameter value is selected as ...</th> <th data-bbox="764 457 1263 636">Then...</th> </tr> </thead> <tbody> <tr> <td data-bbox="602 636 764 919">Field</td> <td data-bbox="764 636 1263 919"> <p>The Search (🔍) icon appears corresponding to this field. On clicking the Search icon, the Search Input or Output Parameter window appears.</p> <p>On specifying the field, the field description appears corresponding to the Parameter Value field.</p> </td> </tr> <tr> <td data-bbox="602 919 764 1171">Algorithm</td> <td data-bbox="764 919 1263 1171"> <p>The Search (🔍) icon appears corresponding to this field. On clicking the Search icon, the Algorithm Search window appears.</p> <p>On specifying the algorithm, the algorithm description appears corresponding to the Parameter Value field.</p> </td> </tr> </tbody> </table>	If the parameter value is selected as ...	Then...	Field	<p>The Search (🔍) icon appears corresponding to this field. On clicking the Search icon, the Search Input or Output Parameter window appears.</p> <p>On specifying the field, the field description appears corresponding to the Parameter Value field.</p>	Algorithm	<p>The Search (🔍) icon appears corresponding to this field. On clicking the Search icon, the Algorithm Search window appears.</p> <p>On specifying the algorithm, the algorithm description appears corresponding to the Parameter Value field.</p>	
If the parameter value is selected as ...	Then...							
Field	<p>The Search (🔍) icon appears corresponding to this field. On clicking the Search icon, the Search Input or Output Parameter window appears.</p> <p>On specifying the field, the field description appears corresponding to the Parameter Value field.</p>							
Algorithm	<p>The Search (🔍) icon appears corresponding to this field. On clicking the Search icon, the Algorithm Search window appears.</p> <p>On specifying the algorithm, the algorithm description appears corresponding to the Parameter Value field.</p>							
Is True	<p>Used to indicate what should happen when the condition is true (satisfied). The valid values are:</p> <ul style="list-style-type: none"> • Check next condition — Used to indicate that the condition with consecutive sequence number should be executed. • Rule is false — Used to indicate that the action specified in the Rule False Action field should be executed. • Rule is true — Used to indicate that the action specified in the Rule True Action field should be executed. 	Yes						
Is False	<p>Used to indicate what should happen when the condition is false (not satisfied). The valid values are:</p> <ul style="list-style-type: none"> • Check next condition — Used to indicate that the condition with consecutive sequence number should be executed. • Rule is false — Used to indicate that the action specified in the Rule False Action field should be executed. 	Yes						

Column Name	Column Description	Mandatory (Yes or No)
	<ul style="list-style-type: none"> Rule is true — Used to indicate that the action specified in the Rule True Action field should be executed. 	
Is Insufficient	<p>Used to indicate what should happen when the data is insufficient. The valid values are:</p> <ul style="list-style-type: none"> Check next condition — Used to indicate that the condition with consecutive sequence number should be executed. Rule is false — Used to indicate that the action specified in the Rule False Action field should be executed. Rule is true — Used to indicate that the action specified in the Rule True Action field should be executed. 	Yes

Tip: Alternatively, you can access the **Edit Rule** screen by clicking the **Edit** link in the **View Rule** screen.

3. Modify the required details.

Note: You can search for a parameter, dependent rule and an algorithm by clicking the **Search** (🔍) icon corresponding to the respective field.

4. Add or remove output parameters or criteria from the rule, if required.

Note: If you want to associate more than one output parameter with the rule or define more than one criteria for the rule, click the **Add** (+) icon and then specify the details. However, if you want to remove an output parameter or a criteria from the rule, click the **Delete** (🗑️) icon corresponding to it.

5. Click **Save**.

The changes made to the rule are saved.

Related Topics

For more information on...	See...
Rule screen	Rule on page 907
Search zone	Search Rule on page 907

Deleting a Rule

Procedure

To delete a rule:

1. Search for the rule in the **Rule** screen.
2. In the **Search Results** section, click the **Delete** (🗑️) icon in the **Delete** column corresponding to the rule that you want to delete.

A message appears confirming whether you want to delete the rule.

Note: You can delete a rule when it is not yet used in the system.

3. Click **OK**.

The rule is deleted.

Related Topics

For more information on...	See...
Rule screen	Rule on page 907
Search zone	Search Rule on page 907

Copying a Rule

Instead of creating a rule from scratch, you can also create a new rule using an existing rule. You can do this by copying a rule. When you copy a rule, the output parameters and criteria defined for the original rule are copied to the new rule. You can then add or remove parameters or criteria from the new rule.

Prerequisites

To copy a rule, you should have:

- Rule (whose copy you want to create) defined in the application
- Preprocessing and postprocessing algorithms, dependent rules, and parameters defined in the application in case you want to use any of them

Procedure

To copy a rule:

1. Search for the rule in the **Rule** screen.
2. In the **Search Results** section, click the **Copy** () icon corresponding to the rule whose copy you want to create.

The **Rule** screen appears. It contains the following fields:

Field Name	Field Description	Mandatory (Yes or No)
Rule	Used to specify the rule code.	Yes
Rule Type	Used to specify the type of rule.	Yes
Description	Used to specify the description for the rule.	Yes
Rule Priority	Used to specify the priority of the rule.	Yes
	Note: You cannot define two rules with the same rule type and priority in the same duration.	
Effective Start Date	Used to specify the date from when the rule is effective.	Yes
Effective End Date	Used to specify the date till when the rule is effective.	No
	Note: The effective end date cannot be earlier than the effective start date.	
Pre-Processing Algorithm	Used to specify the algorithm that will be triggered before executing the criteria in the rule. It pre-processes the input parameters and then returns processed values against which the criteria is validated.	No

Field Name	Field Description	Mandatory (Yes or No)
	<p>Note:</p> <p>The Search (🔍) icon appears corresponding to this field. On clicking the Search icon, the Algorithm Search window appears.</p> <p>On specifying the algorithm, the description of the algorithm appears corresponding to the Pre-Processing Algorithm field.</p>	
Post-Processing Algorithm	<p>Used to specify the algorithm that will be triggered when the rule is true. It post-processes the output parameters and returns the updated values to the calling programs or dependent rules.</p> <p>Note:</p> <p>The Search (🔍) icon appears corresponding to this field. On clicking the Search icon, the Algorithm Search window appears.</p> <p>On specifying the algorithm, the description of the algorithm appears corresponding to the Post-Processing Algorithm field.</p>	No
Rule True Action	<p>Used to indicate what should happen when all conditions in the rule are satisfied and returns Rule is True. The valid values are:</p> <ul style="list-style-type: none"> • Next Dependent Rule — Used to indicate that the dependent rule should be executed when the rule is true. • Next Rule by Priority — Used to indicate that the rule of the same rule type having lower priority should be executed when the rule is true. • Success — Used to indicate that no more rules should be executed when the rule is true. The output parameters and their values are returned to the calling programs. 	Yes
Dependent Rule	<p>Used to specify the next dependent rule that must be executed when Next Dependent Rule is selected from the Rule True Action list.</p>	<p>Yes (Conditional)</p> <p>Note: This field is required when you select Next Dependent Rule from the Rule True Action list.</p>
Rule False Action	<p>Used to indicate what should happen when any of the criteria in the rule is not satisfied and returns Rule is False. The valid values are:</p> <ul style="list-style-type: none"> • Next Dependent Rule — Used to indicate that the dependent rule should be executed when the rule is false. • Next Rule by Priority — Used to indicate that the rule of the same rule type having lower priority should be executed when the rule is false. 	Yes

Field Name	Field Description	Mandatory (Yes or No)
	<ul style="list-style-type: none"> Success — Used to indicate that no more rules should be executed when the rule is false. The output parameters and their values are returned to the calling programs. 	
Dependent Rule	Used to specify the next dependent rule that must be executed when Next Dependent Rule is selected from the Rule False Action list.	Yes (Conditional)
		Note: This field is required when you select Next Dependent Rule from the Rule False Action list.

In addition, it contains the following two sections:

- **Rule Output Parameters** — Used to specify the output parameters that must be returned to the calling programs or dependent rules when all conditions in the rule are satisfied. This section contains the following columns:

Column Name	Column Description	Mandatory (Yes or No)
Parameter Name	Used to specify the parameter. Note: For more information about the output parameters that you can specify while defining a rule, see Transaction Validation and Initial Price Item Determination (Specific to Financial Services Domain) on page 995. The Search (🔍) icon appears corresponding to this field. On clicking the Search icon, the Search Rule Type Field window appears. On specifying the rule type field, the description of the rule type field appears corresponding to the Parameter Name field.	Yes
Parameter Value	Used to specify the value for the parameter. Note: You can specify any special characters except ampersand (&), comma (,), underscore (_), equal to (=), tilde (~), and semi-colon(:) in the parameter value.	Yes

- **Criteria** — Used to define criteria for the rule. This section contains the following columns:

Column Name	Column Description	Mandatory (Yes or No)
Sequence Number	Used to indicate the order in which the criteria should be executed in the rule.	Yes
Parameter Name	Used to indicate whether you want to specify a field or an algorithm as an input parameter. The valid values are: <ul style="list-style-type: none"> • Field 	Yes

Column Name	Column Description	Mandatory (Yes or No)						
	<ul style="list-style-type: none"> • Algorithm <p>Note: By default, the Field option is selected. If a business label is defined for a user defined field (that you have selected), the business label appears in the Parameter Name field.</p> <table border="1" data-bbox="597 506 1222 1276"> <thead> <tr> <th data-bbox="597 506 769 680">If the parameter name is selected as ...</th> <th data-bbox="769 506 1222 680">Then...</th> </tr> </thead> <tbody> <tr> <td data-bbox="597 680 769 961">Field</td> <td data-bbox="769 680 1222 961"> <p>The Search (🔍) icon appears corresponding to this field. On clicking the Search icon, the Search Input or Output Parameter window appears.</p> <p>On specifying the field, the field description appears corresponding to the Parameter Name field.</p> </td> </tr> <tr> <td data-bbox="597 961 769 1276">Algorithm</td> <td data-bbox="769 961 1222 1276"> <p>The Search (🔍) icon appears corresponding to this field. On clicking the Search icon, the Algorithm Search window appears.</p> <p>On specifying the algorithm, the algorithm description appears corresponding to the Parameter Name field.</p> </td> </tr> </tbody> </table>	If the parameter name is selected as ...	Then...	Field	<p>The Search (🔍) icon appears corresponding to this field. On clicking the Search icon, the Search Input or Output Parameter window appears.</p> <p>On specifying the field, the field description appears corresponding to the Parameter Name field.</p>	Algorithm	<p>The Search (🔍) icon appears corresponding to this field. On clicking the Search icon, the Algorithm Search window appears.</p> <p>On specifying the algorithm, the algorithm description appears corresponding to the Parameter Name field.</p>	
If the parameter name is selected as ...	Then...							
Field	<p>The Search (🔍) icon appears corresponding to this field. On clicking the Search icon, the Search Input or Output Parameter window appears.</p> <p>On specifying the field, the field description appears corresponding to the Parameter Name field.</p>							
Algorithm	<p>The Search (🔍) icon appears corresponding to this field. On clicking the Search icon, the Algorithm Search window appears.</p> <p>On specifying the algorithm, the algorithm description appears corresponding to the Parameter Name field.</p>							
Operator	Used to specify the relational operator to define the relation between the parameter name and value.	Yes						
Parameter Value	Used to specify the parameter value. The valid values are: <ul style="list-style-type: none"> • Field • Algorithm 	Yes						

Column Name	Column Description	Mandatory (Yes or No)						
	<p>Note:</p> <p>By default, the Field option is selected.</p> <p>You can specify any special characters except ampersand (&), comma (,), underscore (_), equal to (=), tilde (~), and semi-colon(;) in the parameter value.</p> <table border="1" data-bbox="597 457 1222 1234"> <thead> <tr> <th data-bbox="597 457 769 636">If the parameter value is selected as ...</th> <th data-bbox="769 457 1222 636">Then...</th> </tr> </thead> <tbody> <tr> <td data-bbox="597 636 769 919">Field</td> <td data-bbox="769 636 1222 919"> <p>The Search (🔍) icon appears corresponding to this field. On clicking the Search icon, the Search Input or Output Parameter window appears.</p> <p>On specifying the field, the field description appears corresponding to the Parameter Value field.</p> </td> </tr> <tr> <td data-bbox="597 919 769 1234">Algorithm</td> <td data-bbox="769 919 1222 1234"> <p>The Search (🔍) icon appears corresponding to this field. On clicking the Search icon, the Algorithm Search window appears.</p> <p>On specifying the algorithm, the algorithm description appears corresponding to the Parameter Value field.</p> </td> </tr> </tbody> </table>	If the parameter value is selected as ...	Then...	Field	<p>The Search (🔍) icon appears corresponding to this field. On clicking the Search icon, the Search Input or Output Parameter window appears.</p> <p>On specifying the field, the field description appears corresponding to the Parameter Value field.</p>	Algorithm	<p>The Search (🔍) icon appears corresponding to this field. On clicking the Search icon, the Algorithm Search window appears.</p> <p>On specifying the algorithm, the algorithm description appears corresponding to the Parameter Value field.</p>	
If the parameter value is selected as ...	Then...							
Field	<p>The Search (🔍) icon appears corresponding to this field. On clicking the Search icon, the Search Input or Output Parameter window appears.</p> <p>On specifying the field, the field description appears corresponding to the Parameter Value field.</p>							
Algorithm	<p>The Search (🔍) icon appears corresponding to this field. On clicking the Search icon, the Algorithm Search window appears.</p> <p>On specifying the algorithm, the algorithm description appears corresponding to the Parameter Value field.</p>							
Is True	<p>Used to indicate what should happen when the condition is true (satisfied). The valid values are:</p> <ul style="list-style-type: none"> • Check next condition — Used to indicate that the condition with consecutive sequence number should be executed. • Rule is false — Used to indicate that the action specified in the Rule False Action field should be executed. • Rule is true — Used to indicate that the action specified in the Rule True Action field should be executed. 	Yes						
Is False	<p>Used to indicate what should happen when the condition is false (not satisfied). The valid values are:</p> <ul style="list-style-type: none"> • Check next condition — Used to indicate that the condition with consecutive sequence number should be executed. 	Yes						

Column Name	Column Description	Mandatory (Yes or No)
	<ul style="list-style-type: none"> • Rule is false — Used to indicate that the action specified in the Rule False Action field should be executed. • Rule is true — Used to indicate that the action specified in the Rule True Action field should be executed. 	
Is Insufficient	<p>Used to indicate what should happen when the data is insufficient. The valid values are:</p> <ul style="list-style-type: none"> • Check next condition — Used to indicate that the condition with consecutive sequence number should be executed. • Rule is false — Used to indicate that the action specified in the Rule False Action field should be executed. • Rule is true — Used to indicate that the action specified in the Rule True Action field should be executed. 	Yes

3. Modify the required details.
4. Add or remove the output parameters or criteria from the new rule, if required.

Note:

You can specify any special characters except ampersand (&), comma (,), underscore (_), equal to (=), tilde (~), and semi-colon(;) in the parameter value.

You can search for a parameter, dependent rule and an algorithm by clicking the **Search** (🔍) icon corresponding to the respective field.

If you want to associate more than one output parameter with the rule or define more than one criteria for the rule, click the **Add** (+) icon and then specify the details. However, if you want to remove an output parameter or a criteria from the rule, click the **Delete** (🗑️) icon corresponding to it. For more information on the output parameters that you can specify while defining a rule, see [Transaction Validation and Initial Price Item Determination \(Specific to Financial Services Domain\)](#) on page 995.

5. Click **Save**.

The new rule is defined.

Related Topics

For more information on...	See...
Rule screen	Rule on page 907
Search zone	Search Rule on page 907
How to define a rule	Defining a Rule on page 909



Rule

The **Rule** screen allows you to view the details of a rule. This screen consists of the following zones:

- [Rule Information](#) on page 927

Rule Information

The **Rule Information** zone displays information about the rule. This zone contains the following fields:

Field Name	Field Description
Rule	Displays the rule code.
Rule Type	Indicates the type of rule.
Description	Displays the description of the rule.
Rule Priority	Indicates the priority of the rule. Note: You can use the Move Up () and Move Down () icons corresponding to this field to view the details of a rule (having the same rule type) with a higher or lower priority. Note that this functionality is available when you access the View Rule screen through the Rule screen.
Effective Start Date	Displays the date from when the rule is effective.
Effective End Date	Displays the date till when the rule is effective.
Pre-Processing Algorithm	Indicates the algorithm that will be triggered before executing the criteria in the rule. It pre-processes the input parameters and then returns processed values against which the criteria is validated.
Post-Processing Algorithm	Indicates the algorithm that will be triggered after executing the criteria in the rule. It post-processes the output parameters and returns the updated values to the calling programs or dependent rules.
Rule True Action	Indicates what should happen when all conditions in the rule are satisfied and returns Rule is True .
Dependent Rule	Indicates the next dependent rule that must be executed when Next Dependent Rule is selected from the Rule True Action list.
Rule False Action	Indicates what should happen when any of the criteria in the rule is not satisfied and returns Rule is False .
Dependent Rule	Indicates the next dependent rule that must be executed when Next Dependent Rule is selected from the Rule False Action list.

In addition, it contains the following two sections:

- **Rule Output Parameters** — Lists the output parameters that must be returned to the calling programs or dependent rules when all conditions in the rule are satisfied. This section contains the following columns:

Column Name	Column Description
Parameter Name	Displays the name of the parameter. In addition, this column has a context menu which helps in navigating to the Field screen.
Parameter Value	Displays the value of the parameter.

- **Criteria** — Lists the criteria defined in the rule. This section contains the following columns:

Column Name	Column Description
Sequence Number	Indicates the order in which the criteria should be executed in the rule.
Parameter Type	Indicates whether the input parameter is a field or an algorithm.
Parameter Name	Displays the field or algorithm name which is used as an input parameter.
Operator	Indicates the relational operator used to define the relation between the parameter name and value.
Parameter Value	Displays the parameter value.
Is True	Indicates what should happen when the condition is true (satisfied). The valid values are: <ul style="list-style-type: none"> • Check next condition — Indicates that the condition with consecutive sequence number should be executed. • Rule is false — Indicates that the action specified in the Rule False Action field should be executed. • Rule is true — Indicates that the action specified in the Rule True Action field should be executed.
Is False	Indicates what should happen when the condition is false (not satisfied). The valid values are: <ul style="list-style-type: none"> • Check next condition — Indicates that the condition with consecutive sequence number should be executed. • Rule is false — Indicates that the action specified in the Rule False Action field should be executed. • Rule is true — Indicates that the action specified in the Rule True Action field should be executed.
Is Insufficient	Indicates what should happen when the data is insufficient. The valid values are: <ul style="list-style-type: none"> • Check next condition — Indicates that the condition with consecutive sequence number should be executed. • Rule is false — Indicates that the action specified in the Rule False Action field should be executed. • Rule is true — Indicates that the action specified in the Rule True Action field should be executed.

The **Edit** link appears in the upper-right corner of the **Rule Information** zone. On clicking the **Edit** link, the **Edit Rule** screen appears where you can edit the details of the rule.

Related Topics

For more information on...	See...
How to view the details of a rule	Viewing the Rule Details on page 909

Viewing the Rule Details

Procedure

To view the details of a rule:

1. Search for the rule in the **Rule** screen.
2. In the **Search Results** section, click the **View** () icon in the **View** column corresponding to the rule whose details you want to view.

The **View Rule** screen appears.

3. View the details of the rule in the **Rule Information** zone.

Related Topics

For more information on...	See...
View Rule screen	Rule on page 926
Rule Information zone	Rule Information on page 927
How to search for a rule	Searching for a Rule Type on page 890

Rule Check

The **Rule Check** screen allows you to validate whether rules of a particular rule type are executed as expected. On validating, it indicates the sequence in which all effective rules were executed, the total execution time, and the output parameters of the rule that was successfully executed. This screen consists of the following sections:

- Rule Type Input Parameters
- Rule Output Parameters
- Rule Execution

Rule Type Input Parameters

The **Rule Type Input Parameters** section contains the following fields:

Field Name	Field Description	Mandatory (Yes or No)
Rule Type	Used to specify the rule type.	Yes
Effective Date	Used when you want to execute the rules which are effective on a particular date.	No
	Note: If you do not specify the effective date, the system executes all rules which are effective on the system date.	
Parameter Name	Indicates the input parameter.	Not applicable
	Note: The input parameters listed change depending on the rule type that you have selected.	
Parameter Value	Used to specify the value for the input parameter.	Yes

In addition, this section contains the **Check Rule** button. On clicking the button, you can validate the sequence in which the rules with the specified rule type are executed.

Rule Output Parameters

The **Rule Output Parameters** section contains the following fields:

Field Name	Field Description
Status	Displays the status of the rule execution. The valid values are: <ul style="list-style-type: none"> • Success — Indicates that one of the rule was successfully executed and returned the output parameters. • Fail — Indicates that none of the rules with the specified rule type were successfully executed. • Error — Indicates that an error occurred while executing a rule.
Execution Time	Displays the total time taken to execute all effective rules with the specified rule type.
Error	Displays the error message indicating the error that occurred while executing a rule.
	Note: This field appears when the status is Error .

In addition, this section contains the following columns:

Column Name	Column Description
Parameter Name	Displays the output parameter of the rule that was successfully executed.
Parameter Value	Displays the value of the output parameter.

Rule Execution

The **Rule Execution** section indicates the sequence in which all effective rules with the specified rule type were executed. This section contains the following columns:

Column Name	Column Description
Rule	Indicates the rule that was executed.
Rule Type	Indicates the type of rule.
Rule Priority	Indicates the priority of the rule.
Rule Status	Indicates whether the rule was true or false.
Rule Next Action	Indicates the action that took place when the rule was true or false.

Rule Check

The **Rule Check** zone allows you to validate whether rules of a particular rule type are executed as expected. It indicates the sequence in which all effective rules were executed along with the total execution time. This zone consists of the following sections:

- **Rule Type Input Parameters** — This sections contains the following fields:

Field Name	Field Description	Mandatory (Yes or No)
Rule Type	Used to specify the rule type.	Yes
Effective Date	Used when you want to execute the rules which are effective on a particular date.	No
Parameter Name	Indicates the input parameter.	Not applicable
	Note: The input parameters listed change depending on the rule type that you have selected.	

Field Name	Field Description	Mandatory (Yes or No)
Parameter Value	Used to specify the value for the input parameter.	Yes

In addition, this section contains the **Check Rule** button. On clicking the button, you can validate the sequence in which the rules with the specified rule type are executed.

- **Rule Output Parameters** — This section contains the following fields:

Field Name	Field Description
Status	Displays the status of the rule execution. The valid values are: <ul style="list-style-type: none"> • Success — Indicates that one of the rule was successfully executed and returned the output parameters. • Fail — Indicates that none of the rules with the specified rule type were successfully executed. • Error — Indicates that an error occurred while executing a rule.
Execution Time	Displays the total time taken to execute a set of rules.
Error	Displays the error message indicating the error that occurred while executing a rule. <div style="border: 1px solid black; padding: 2px; margin-top: 5px;"> Note: This field appears when the status is Error. </div>

In addition, this section contains the following columns:

Column Name	Column Description
Parameter Name	Displays the output parameter of the rule that was successfully executed.
Parameter Value	Displays the value of the output parameter.

- **Rule Execution** — Indicates the sequence in which the rules with the specified rule type were executed. This section contains the following columns:

Column Name	Column Description
Rule Code	Displays the rule code.
Rule Type	Displays the type of rule.
Rule Priority	Displays the priority of the rule.
Rule Status Flag	Indicates whether the rule was true or false.
Rule Next Action	Indicates the action that took place when the rule was true or false.

Related Topics

For more information on...	See...
Rule Check screen	Rule Check on page 929

Chapter 9

Alternate Sequential Bill Numbers

Topics:

- [Alternate Sequential Bill Number Generation Algorithms](#)
- [Enabling the Alternate Sequential Bill Numbers Feature](#)

Each bill is uniquely identified by its bill ID. Bill ID is a random system-generated number. In some locales, bills have an additional identifier known as alternate sequential bill number. Alternate sequential bill numbers are system-generated sequential numbers. For example, the first bill generated by the system is assigned a sequential bill number of 1, the next bill is assigned a value of 2, and so on.

If you want to generate alternate sequential bill numbers for the pending or completed bills, you must select the **Use Sequential Bill Numbers** option in the **Billing** tab of the **Installation Options** screen. You can configure the application to generate alternate sequential bill numbers which are either unique throughout the system or within the division. The **Assign Sequential Bill Numbers (ASSGNSBN)** batch allows you to generate alternate sequential bill numbers for the completed or pending bills. You need to configure this batch such that it is executed at regular intervals. For more information about the batch, refer to *Oracle Revenue Management and Billing Batch Guide*.

Related Topics

For more information on...	See...
How to enable the Alternate Sequential Bill Numbers feature	Enabling the Alternate Sequential Bill Numbers Feature on page 939

Alternate Sequential Bill Number Generation Algorithms

The following table lists the alternate sequential bill number generation algorithm types which are shipped with the product:

If you want to generate...	Then create an algorithm using the following algorithm type...
Alternate sequential bill numbers unique throughout the system	C1_ALTBLLSYS on page 934
Alternate sequential bill numbers unique within the division	C1_ALTBLDV on page 937
Alternate sequential bill numbers unique throughout the system in the required format using a set of parameters	C1_ALTBLSYS1 on page 934 Note: The alternate sequential bill number will be unique throughout the system when you configure the algorithm parameters appropriately.
Alternate sequential bill numbers unique within the division in the required format using a set of parameters	C1_ALTBLDIV1 on page 937 Note: The alternate sequential bill number will be unique within the division when you configure the algorithm parameters appropriately.

C1_ALTBLLSYS

The **C1_ALTBLLSYS** algorithm type is used to generate an alternate bill ID for the completed and pending bills. The alternate bill ID is sequenced using the sequence number, and is unique throughout the system. This algorithm type does not have any parameters.

If you attach an algorithm created using the **C1_ALTBLLSYS** algorithm type to the **Sequence Generation Algorithm** field in the **Billing** tab of the **Installation Options** screen, the algorithm is invoked while executing the **Assign Sequential Bill Numbers (ASSGNSBN)** batch.

C1_ALTBLSYS1

The **C1_ALTBLSYS1** algorithm type is used to generate an alternate bill ID for the completed and pending bills. You can generate an alternate bill ID in the required format using the following parameters:

Parameter	Description
'X'	Here, X stands for a separator. For example, ','. The separator must be enclosed within single quotes. It will act as a delimiter in the alternate sequential bill number.
CIS_DIVISION	The division to which the account belongs. It is retrieved from the bill. It should not be more than five characters.
BILL_CYC_CD	The bill cycle of the account for which the bill is generated. It is retrieved from the bill. It should not be more than four characters.
ACCT_IDENTIFIER=<Account_Identifier_Type>,<CharStartPosition>,<CharCount>	Here, you need to specify the following information separated by a comma: <ul style="list-style-type: none"> <Account_Identifier_Type> - Used to indicate the account identifier type whose value must be used to generate the alternate sequential bill number.

Parameter	Description
	<ul style="list-style-type: none"> • <CharStartPosition> - Used to indicate the starting position from where you want to extract the characters from the account identifier. If you do not specify the starting position, by default, it is set to zero (0) (i.e. from the first character). • <CharCount> - Used to indicate the number of characters that you want to extract from the account identifier. If you do not specify the count, by default, it is set to five.
CHARACC=<Characteristic_Type>,<CharStartPosition>,<CharCount>	<p>Here, you need to specify the following information separated by a comma:</p> <ul style="list-style-type: none"> • <Characteristic_Type> - Used to indicate the account's characteristic whose value must be used to generate the alternate sequential bill number. • <CharStartPosition> - Used to indicate the starting position from where you want to extract the characters from the characteristic value. If you do not specify the starting position, by default, it is set to zero (0) (i.e. from the first character). • <CharCount> - Used to indicate the number of characters that you want to extract from the characteristic value. If you do not specify the count, by default, it is set to five. <p>Note: If the same characteristic is defined multiple times for an account, the characteristic value which is effective on the batch business date is considered.</p>
CHARPER=<Characteristic_Type>,<CharStartPosition>,<CharCount>	<p>Here, you need to specify the following information separated by a comma:</p> <ul style="list-style-type: none"> • <Characteristic_Type> - Used to indicate the person's characteristic whose value must be used to generate the alternate sequential bill number. • <CharStartPosition> - Used to indicate the starting position from where you want to extract the characters from the characteristic value. If you do not specify the starting position, by default, it is set to zero (0) (i.e. from the first character). • <CharCount> - Used to indicate the number of characters that you want to extract from the characteristic value. If you do not specify the count, by default, it is set to five. <p>Note: If the same characteristic is defined multiple times for a person, the characteristic value which is effective on the batch business date is considered.</p>
BILL_DT=MMddy	<p>The date when the bill is created for the account. It should not be more than six characters. You can use the following patterns in the date format:</p>

Parameter	Description
	<ul style="list-style-type: none"> “yyyy” or “yy” for year “MM” or “M” for month “dd” or “d” for day
	Note: The date format should either start or end with the year.
SEQ_NBR	The sequence number generated by the database. It should not be more than 12 characters.
FIXED_SUFFIX=XX	Here, X stands for a letter or a group of letters that you want to add at the end of the alternate sequential bill number.
LEFT_PADDING_CHAR=ZERO LEFT_PADDING_CHAR=SPACE	or Indicates whether you want to add zero or space when the number of characters derived from the account’s or person’s characteristic value is less than the character count. The padding is added to the left.

You can specify the above mentioned parameters against any of the following parameters available in the **C1_ALTBLSYS1** algorithm type:

- Field1
- Field2
- Field3
- Field4
- Field5
- Field6
- Field7
- Field8
- Field9
- Field10

None of these algorithm type parameters are mandatory. The system will concatenate the parameter values and then generate alternate bill ID in the required format. For example, if you create an algorithm using the following parameters:

- Field1 — CIS_DIVISION
- Field2 — ‘|’
- Field3 — SEQ_NBR
- Field4 — ‘-’
- Field5 — FIXED_SUFFIX=01

In this case, the system will generate the alternate bill ID in the CIS_DIVISION|SEQ_NBR-01 format. For example, DIV1|12345678-01. If you want to generate unique alternate bill ID, we recommend you to use the **SEQ_NBR** parameter while creating an algorithm using the **C1_ALTBLSYS1** algorithm type.

Note that if you do not specify the value for any parameters while creating an algorithm using the **C1_ALTBLSYS1** algorithm type, the system will generate the alternate bill ID using the sequence number.

While specifying the value for these parameters, you need to ensure that the length of the alternate bill ID should not exceed 30 characters. An algorithm named **C1_ALTBLSYS1** is already shipped with the product. You can create custom algorithms using the **C1_ALTBLSYS1** algorithm type to design the required alternate bill ID format using the above mentioned parameters. If you attach an algorithm created using the **C1_ALTBLSYS1** algorithm type to the

Sequence Generation Algorithm field in the **Billing** tab of the **Installation Options** screen, the algorithm is invoked while executing the **Assign Sequential Bill Numbers (ASSGNSBN)** batch.

C1_ALTBLDV

The **C1_ALTBLDV** algorithm type is used to generate a unique alternate bill ID for the completed and pending bills within the division. For example, two bills (such as B1 and B2) belonging to the same division (such as D1) cannot have the same alternate bill ID. However, two bills (such as B1 and B2) belonging to different divisions, (such as D1 and D2) can have the same alternate bill ID.

This algorithm type contains the following parameter:

Parameter	Description	Mandatory (Yes or No)
Initial Bill Sequence Number	Used to specify the initial alternate bill ID that you want to use while sequencing. Note: If you do not specify any value for this parameter, by default, the system will generate the initial alternate bill ID for sequencing.	No

If you attach an algorithm created using the **C1_ALTBLDV** algorithm type to the **Sequence Generation Algorithm** field in the **Billing** tab of the **Installation Options** screen, the algorithm is invoked while executing the **Assign Sequential Bill Numbers (ASSGNSBN)** batch.

C1_ALTBLDIV1

The **C1_ALTBLDIV1** algorithm type is used to generate an alternate bill ID for the completed and pending bills. You can generate an alternate bill ID in the required format using the following parameters:

Parameter	Description
'X'	Here, X stands for a separator. For example, ','. The separator must be enclosed within single quotes. It will act as a delimiter in the alternate sequential bill number.
CIS_DIVISION	The division to which the account belongs. It is retrieved from the bill. It should not be more than five characters.
BILL_CYC_CD	The bill cycle of the account for which the bill is generated. It is retrieved from the bill. It should not be more than four characters.
ACCT_INDENTIFIER=<Account_Identifier_Type>,<CharStartPosition>,<CharCount>	Here, you need to specify the following information separated by a comma: <ul style="list-style-type: none"> <Account_Identifier_Type> - Used to indicate the account identifier type whose value must be used to generate the alternate sequential bill number. <CharStartPosition> - Used to indicate the starting position from where you want to extract the characters from the account identifier. If you do not specify the starting position, by default, it is set to zero (0) (i.e. from the first character). <CharCount> - Used to indicate the number of characters that you want to extract from the account identifier. If you do not specify the count, by default, it is set to five.

Parameter	Description
CHARACC=<Characteristic_Type>,<CharStartPosition>,<CharCount>	<p>Here, you need to specify the following information separated by a comma:</p> <ul style="list-style-type: none"> • <Characteristic_Type> - Used to indicate the account's characteristic whose value must be used to generate the alternate sequential bill number. • <CharStartPosition> - Used to indicate the starting position from where you want to extract the characters from the characteristic value. If you do not specify the starting position, by default, it is set to zero (0) (i.e. from the first character). • <CharCount> - Used to indicate the number of characters that you want to extract from the characteristic value. If you do not specify the count, by default, it is set to five. <p>Note: If the same characteristic is defined multiple times for an account, the characteristic value which is effective on the batch business date is considered.</p>
CHARPER=<Characteristic_Type>,<CharStartPosition>,<CharCount>	<p>Here, you need to specify the following information separated by a comma:</p> <ul style="list-style-type: none"> • <Characteristic_Type> - Used to indicate the person's characteristic whose value must be used to generate the alternate sequential bill number. • <CharStartPosition> - Used to indicate the starting position from where you want to extract the characters from the characteristic value. If you do not specify the starting position, by default, it is set to zero (0) (i.e. from the first character). • <CharCount> - Used to indicate the number of characters that you want to extract from the characteristic value. If you do not specify the count, by default, it is set to five. <p>Note: If the same characteristic is defined multiple times for a person, the characteristic value which is effective on the batch business date is considered.</p>
BILL_DT=MMddy	<p>The date when the bill is created for the account. It should not be more than six characters. You can use the following patterns in the date format:</p> <ul style="list-style-type: none"> • "yyyy" or "yy" for year • "MM" or "M" for month • "dd" or "d" for day <p>Note: The date format should either start or end with the year.</p>
FIXED_SUFFIX=XX	<p>Here, X stands for a letter or a group of letters that you want to add at the end of the alternate sequential bill number.</p>

Parameter	Description
LEFT_PADDING_CHAR=ZERO LEFT_PADDING_CHAR=SPACE	or Indicates whether you want to add zero or space when the number of characters derived from the account's or person's characteristic value is less than the character count. The padding is added to the left.

You can specify the above mentioned parameters against any of the following parameters available in the **C1_ALTBLDIV1** algorithm type:

- Field1
- Field2
- Field3
- Field4
- Field5
- Field6
- Field7
- Field8
- Field9
- Field10

None of these algorithm type parameters are mandatory. The system will concatenate the parameter values and then generate alternate bill ID in the required format. For example, if you create an algorithm using the following parameters:

- Field1 — CIS_DIVISION
- Field2 — '|'
- Field3 — BILL_DT=MMddy
- Field4 — '-'
- Field5 — FIXED_SUFFIX=01

In this case, the system will generate the alternate bill ID in the CIS_DIVISION|MMddy-01 format. For example, DIV1|110501-01. Note that if you do not specify the value for any of these algorithm type parameters, the system will not generate the alternate bill ID for the completed and pending bills.

While specifying the value for these parameters, you need to ensure that the length of the alternate bill ID should not exceed 30 characters. An algorithm named **C1_ALTBLDIV1** is already shipped with the product. You can create custom algorithms using the **C1_ALTBLDIV1** algorithm type to design the required alternate bill ID format using the above mentioned parameters. If you attach an algorithm created using the **C1_ALTBLDIV1** algorithm type to the **Sequence Generation Algorithm** field in the **Billing** tab of the **Installation Options** screen, the algorithm is invoked while executing the **Assign Sequential Bill Numbers (ASSGNSBN)** batch.

Enabling the Alternate Sequential Bill Numbers Feature

Prerequisites

To enable the alternate sequential bill numbers feature, you should have:

- An algorithm created using the **C1_ALTBLLSYS**, **C1_ALTBLSYS1**, **C1_ALTBLDV**, or **C1_ALTBLDIV1** algorithm type that you want to use for alternate sequential bill number generation

Procedure

To enable the alternate sequential bill numbers feature:

1. Click the **Admin** link in the **Application** toolbar.
A list appears.
2. From the **Admin** menu, select **I** and then click **Installation Options**.
The **Installation Options** screen appears.
3. Click the **Billing** tab.
The **Billing** tab appears.
4. Select the **Use Sequential Bill Numbers** option to indicate that you want to generate alternate sequential bill numbers for the completed and pending bills.
The **Sequential Invoice** field is enabled.
5. Select the **System-wide** or **Division-specific** option from the **Sequential Invoice** list depending on whether you want alternate sequential bill numbers to be unique throughout the system or within the division.
6. Do either of the following:

If you want to generate...	Then
Alternate sequential bill numbers unique throughout the system	<ol style="list-style-type: none"> 1. Attach an algorithm created using the C1_ALTBLLSYS algorithm type to the Sequence Generation Algorithm field to indicate how an alternate bill number which is unique throughout the system should be sequenced. <div style="border: 1px solid black; padding: 5px; background-color: #f0f0f0;"> <p>Note: The Sequence Generation Algorithm field is enabled when the System-wide option is selected from the Sequential Invoice list.</p> </div> 2. Click the Save button in the Page Title area. The changes made to the installation options are saved.
Alternate sequential bill numbers unique within the division	<ol style="list-style-type: none"> 1. Click the Save button in the Page Title area. The changes made to the installation options are saved. 2. From the Admin menu, select D and then click Division. The Division screen appears. 3. Search for the division, whose accounts' bills should have alternate sequential bill numbers unique within the division. 4. In the Division screen, click the Algorithms tab. The Algorithms tab appears. 5. Select the Sequential Bill Number Generation option from the Division Algorithm Entity list. 6. Enter the sequence number to indicate the order in which the algorithms with the same entity should be executed. 7. Attach an algorithm created using the C1_ALTBLDV algorithm type to the respective field to indicate how an alternate bill number which is unique within the division should be sequenced.

If you want to generate...	Then
	<p>8. Click the Save button in the Page Title area.</p> <p>The changes made to the division are saved.</p>
<p>Alternate sequential bill numbers unique throughout the system in the required format using a set of parameters</p>	<p>1. Attach an algorithm created using the C1_ALTBLSYS1 algorithm type to the Sequence Generation Algorithm field to indicate how an alternate bill number which is unique throughout the system should be generated.</p> <div data-bbox="716 485 1399 772" style="border: 1px solid black; padding: 5px;"> <p>Note:</p> <p>The Sequence Generation Algorithm field is enabled when the System-wide option is selected from the Sequential Invoice list.</p> <p>The alternate sequential bill number will be unique throughout the system when you configure the algorithm parameters appropriately.</p> </div> <p>2. Click the Save button in the Page Title area.</p> <p>The changes made to the installation options are saved.</p>
<p>Alternate sequential bill numbers unique within the division in the required format using a set of parameters</p>	<p>1. Click the Save button in the Page Title area.</p> <p>The changes made to the installation options are saved.</p> <p>2. From the Admin menu, select D and then click Division.</p> <p>The Division screen appears.</p> <p>3. Search for the division, whose accounts' bills should have alternate sequential bill numbers unique within the division.</p> <p>4. In the Division screen, click the Algorithms tab.</p> <p>The Algorithms tab appears.</p> <p>5. Select the Sequential Bill Number Generation option from the Division Algorithm Entity list.</p> <p>6. Enter the sequence number to indicate the order in which the algorithms with the same entity should be executed.</p> <p>7. Attach an algorithm created using the C1_ALTBLDIV1 algorithm type to the respective field to indicate how an alternate bill number which is unique within the division should be generated.</p> <div data-bbox="716 1671 1399 1780" style="border: 1px solid black; padding: 5px;"> <p>Note: The alternate sequential bill number will be unique within the division when you configure the algorithm parameters appropriately.</p> </div> <p>8. Click the Save button in the Page Title area.</p> <p>The changes made to the division are saved.</p>

Related Topics

For more information on...	See...
Alternate Sequential Bill Numbers	Alternate Sequential Bill Numbers on page 933
Alternate Sequential Bill Number Generation Algorithms	Alternate Sequential Bill Number Generation Algorithms on page 934

Chapter 10

Currency Conversion

Topics:

- [Prerequisites](#)
- [Bill Segment Generation](#)
- [Adjustment Creation](#)
- [Payment and Tender Creation](#)
- [Transaction Aggregation](#)
- [FT GL Creation](#)
- [Currency Conversion Algorithms](#)
- [Exchange Rate \(Used for Searching\)](#)
- [Exchange Rate \(Used for Viewing\)](#)

Oracle Revenue Management and Billing supports currency conversion using an exchange rate. The currency conversion feature is used only when the multi-currency accounts feature is enabled. In other words, you can use the currency conversion feature when the **Allow Multi-Currency Accounts** option type of the **Multi-Currency Accounts (C1_MLTCURACC)** feature configuration is set to **Y**.

The currency conversion can take place during the following business processes which are configured in the system:

- Bill Segment Generation
- Adjustment Creation
- Payment and Tender Creation
- FT GL Creation
- Transaction Aggregation

To enable the currency conversion feature, you need to attach the currency conversion algorithm at the division level. The system facilitates you to define different conversion currency algorithm for each business process. The currency conversion feature functions when the appropriate exchange rate is available in the system. Otherwise, erroneous results might occur.

The system allows you to define date or date and time based global and division-specific exchange rates. The date based exchange rate mean that the exchange rate is applicable throughout the day. However, the date and time based exchange rate mean that the exchange rate is applicable from that date and time onwards.

Note: At present, time is not passed as input from any module (such as, payments, adjustments, billing, transaction feed management, and so on) during currency conversion. Therefore, even if you define date and time based exchange rates and use the date and time based currency conversion algorithms at the division level, the system will not search date and time based exchange rate when multiple exchange rates are available on the same day. The system will randomly pick an exchange rate on that day. The implementation team has to build the custom logic to pass or input time to the date and time based currency conversion algorithms in order to derive the appropriate exchange rate.

The system might use the direct division-specific or global exchange rate (i.e. FROM CCY to TO CCY) or direct reverse division-specific or global exchange rate (i.e. TO CCY to FROM CCY) during currency conversion. If either direct or direct reverse exchange rate is not available, the system might use division-specific or global exchange rate through base currency during

currency conversion. You can define the order in which exchange rate must be searched in the currency conversion algorithm.

While converting the amount from the source currency to the target currency (i.e. FROM CCY to TO CCY), the system uses the precision (i.e. decimal positions) of the target currency (i.e. TO CCY). For example, if you set the decimal positions for USD and INR to 1 and 2, respectively, the system uses 1 decimal position during currency conversion from INR to USD.

The system provides you with a facility to define whether you want to enable or disable the currency conversion feature for a rate component. If the currency conversion feature is enabled for a rate component, the currency conversion will take place while generating bill segments for the rate (i.e. rate component) based billable charges.

Prerequisites

To setup the currency conversion feature, you need to do the following:

- Define the required divisions and currencies in the system
- Define the values for the **CONV_TYPE_FLG** and **EXCH_RATE_SRC_FLG** lookup fields
- Define the Determine Business Object algorithm using the **F1-MOBO** algorithm type and attach it to the **C1_EXCHRATE** maintenance object

Note: The **C1-ExchangeRate** and **C1_EXCHRATE_BO** business objects are shipped with the product. The **C1-ExchangeRate** business object is used while defining and editing date and time based exchange rates. However, the **C1_EXCHRATE_BO** business object is used while defining and editing date based exchange rates. Depending on whether you want to define date or date and time based exchange rates, you need to accordingly set the **Business Object** parameter in the Determine Business Object algorithm. The system will then accordingly display the fields while defining or editing an exchange rate.

- Define the required exchange rates for currency conversion
- Set the following option types of the **Multi-Currency Accounts (C1_MLTCURACC)** feature configuration:
 - Allow Multi-Currency Accounts
 - Transfer Adjustment Type
- Set the **Allow Currency Conversion** field for each rate component to either **Yes** or **No** depending on whether you want to enable the currency conversion feature for the rate (i.e. rate component) based billable charges
- Create an algorithm of the **C1_CURALGBS** or **C1_EXCRTBS** algorithm type and attach it to the **Currency Conversion For Bill Segments** algorithm spot of the division when you want to enable currency conversion during:
 - Bill Segment Generation
 - FT GL Creation for Bill Segments

Note: The **C1_CURALGBS** algorithm type uses date based exchange rate during currency conversion. However, the **C1_EXCRTBS** algorithm type uses date and time based exchange rate during currency conversion.

- Create an algorithm of the **C1_CURALGAD** or **C1_EXCRTAD** algorithm type and attach it to the **Currency Conversion For Adjustments** algorithm spot of the division when you want to enable currency conversion during:
 - Adjustment Creation
 - FT GL Creation for Adjustments

Note: The **C1_CURALGAD** algorithm type uses date based exchange rate during currency conversion. However, the **C1_EXCRTAD** algorithm type uses date and time based exchange rate during currency conversion.

- Create an algorithm of the **C1_CURALGPY** or **C1_EXCRTPY** algorithm type and attach it to the **Currency Conversion For Payments** algorithm spot of the division when you want to enable currency conversion during:
 - Payment and Tender Creation
 - FT GL Creation for Payments

Note: The **C1_CURALGPY** algorithm type uses date based exchange rate during currency conversion. However, the **C1_EXCRTPY** algorithm type uses date and time based exchange rate during currency conversion.

- Create an algorithm of the **C1_CURALGTFM** or **C1_EXCRTTFM** algorithm type and attach it to the **TFM - Currency Conversion** algorithm spot of the division when you want to enable currency conversion during transaction aggregation

Note: The **C1_CURALGTFM** algorithm type uses date based exchange rate during currency conversion. However, the **C1_EXCRTTFM** algorithm type uses date and time based exchange rate during currency conversion.

- Create an algorithm of the **FTFREZGLEXTN** algorithm type and attach it on the **FT Freeze** system event of the customer class for which you want to create FT GL extension

Related Topics

For more information on...	See...
FTFREZGLEXTN algorithm type	FTFREZGLEXTN on page 964
C1_CURALGBS algorithm type	C1_CURALGBS on page 949
C1_CURALGAD algorithm type	C1_CURALGAD on page 951
C1_CURALGPY algorithm type	C1_CURALGPY on page 953
C1_CURALGTFM algorithm type	C1_CURALGTFM on page 955
C1_EXCRTBS algorithm type	C1_EXCRTBS on page 957
C1_EXCRTAD algorithm type	C1_EXCRTAD on page 958
C1_EXCRTPY algorithm type	C1_EXCRTPY on page 960
C1_EXCRTTFM algorithm type	C1_EXCRTTFM on page 962
How to set the Multi-Currency Accounts (C1_MLTCURACC) feature configuration	Setting the C1_MLTCURACC Feature Configuration on page 4331
How to define an exchange rate	Defining an Exchange Rate on page 971

Bill Segment Generation

The system allows you to generate bill segments using the following:

- **Pass through billable charges** — If the pass through billable charges have a bill line currency which is different from the account's invoice currency, the bill line amount is converted into the account's invoice currency during the bill segment generation.
- **Rate based billable charges** — If the rate based billable charges have a pricing currency which is different from the account's invoice currency, the amount is converted into the account's invoice currency during the bill segment generation.

In addition, during the post processing bill segment generation, if the pricing currency is different from the account's invoice currency, then the amount is converted into the account's invoice currency. The currency conversion is done when you have an algorithm of the **C1_CURALGBS** or **C1_EXCRTBS** algorithm type attached on the **Currency Conversion For Bill Segments** algorithm spot of the respective division. In addition, the currency conversion is done for rate based billable charges when the **Allow Currency Conversion** field in the respective rate component is set to **Yes**. Otherwise, the currency conversion will not happen. If the required exchange rate is not available during currency conversion, the status of the bill segment will change to **Error**.

Related Topics

For more information on...	See...
C1_CURALGBS algorithm type	CI_CURALGBS on page 949
C1_EXCRTBS algorithm type	CI_EXCRTBS on page 957

Adjustment Creation

There might be situations when the adjustment currency is different from the account's invoice currency. The system enables you to determine whether currency conversion must be done during adjustment creation or during bill completion. If you clear the **Print by Default** check box in the respective adjustment type, the currency conversion takes place during adjustment creation. However, if you select the **Print by Default** check box in the respective adjustment type, the currency conversion takes place during bill completion and not during adjustment creation. A transfer adjustment is created in the account's invoice currency and the reverse adjustment is created against the original adjustment in the adjustment currency when you complete the next bill of the account. The system creates the transfer and reverse adjustments using the adjustment type specified in the **Transfer Adjustment Type** option type of the **Multi-Currency Accounts (C1_MLTCURACC)** feature configuration.

The currency conversion is done when you have an algorithm of the **C1_CURALGAD** or **C1_EXCRTAD** algorithm type attached on the **Currency Conversion For Adjustments** algorithm spot of the respective division. Otherwise, the currency conversion will not happen. If the required exchange rate is not available during currency conversion, the transfer adjustment will not be created.

Related Topics

For more information on...	See...
C1_CURALGAD algorithm type	CI_CURALGAD on page 951
C1_EXCRTAD algorithm type	CI_EXCRTAD on page 958

Payment and Tender Creation

If the payment currency is different from the account's invoice currency, the amount is converted into the account's invoice currency during payment and tender creation. The currency conversion is done when you have an algorithm of the **C1_CURALGPY** or **C1_EXCRTPY** algorithm type attached on the **Currency Conversion For Payments** algorithm spot of the respective division. Otherwise, the currency conversion will not happen. If the required exchange rate is not available during currency conversion, the payment and tenders will not be created.

Note:

The currency conversion feature is available when the payment currency (i.e. tender currency) is different from the payor account's invoice currency and not when the payor account's invoice currency is different from the payee account's invoice currency.

The currency conversion feature for payments is currently not supported from the **Payment Portal** screen and while uploading payment data from an external source.

Related Topics

For more information on...	See...
C1_CURALGPY algorithm type	CI_CURALGPY on page 953
C1_EXCRTPY algorithm type	CI_EXCRTPY on page 960

Transaction Aggregation

If the transaction or user defined (UDF) currency is different from the pricing currency, the amount is converted into the pricing currency when you are aggregating transactions based on the transaction or UDF amount. The currency conversion is done when you have an algorithm of the **C1_CURALGTFM** or **C1_EXCRTTFM** algorithm type attached on the **TFM - Currency Conversion** algorithm spot of the respective division. Otherwise, the currency conversion will not happen. If the required exchange rate is not available during currency conversion, the status of the transaction will change to **Error**.

Related Topics

For more information on...	See...
C1_CURALGTFM algorithm type	CI_CURALGTFM on page 955
C1_EXCRTTFM algorithm type	CI_EXCRTTFM on page 962

FT GL Creation

During FT GL creation, the system creates an FT GL extension when the account's invoice currency is different from the division's base currency. The FT GL extension is created for the following financial transaction (FT) types:

- Adjustment
- Adjustment Cancellation
- Bill Segment
- Bill Cancellation
- Pay Segment
- Pay Cancellation

The FT GL extension is created for bill segments when you have an algorithm of the **C1_CURALGBS** or **C1_EXCRTBS** algorithm type attached on the **Currency Conversion For Bill Segments** algorithm spot of the respective division. The FT GL extension is created for payments when you have an algorithm of the **C1_CURALGPY** or **C1_EXCRTPY** algorithm type attached on the **Currency Conversion For Payments** algorithm spot of the respective division. The FT GL extension is created for adjustments when you have an algorithm of the **C1_CURALGAD** or **C1_EXCRTAD** algorithm type attached on the **Currency Conversion For Adjustments** algorithm spot of the respective division. Otherwise, the currency conversion will not happen and the FT GL extension will not be created. In addition, if the required exchange rate is not available during currency conversion, the FT GL extension will not be created.

Related Topics

For more information on...	See...
FTFREZGLEXTN algorithm type	FTFREZGLEXTN on page 964
C1_CURALGBS algorithm type	CI_CURALGBS on page 949
C1_CURALGAD algorithm type	CI_CURALGAD on page 951
C1_CURALGPY algorithm type	CI_CURALGPY on page 953
C1_EXCRTBS algorithm type	CI_EXCRTBS on page 957
C1_EXCRTPY algorithm type	CI_EXCRTPY on page 960

For more information on...	See...
C1_EXCRTAD algorithm type	CI_EXCRTAD on page 958

Currency Conversion Algorithms

The following table lists the currency conversion algorithm types shipped with the product:

If you want to use...	Then create algorithm using the following algorithm type....
Date based exchange rate during currency conversion while: <ul style="list-style-type: none"> • Bill Segment Generation • FT GL Creation for Bill Segments 	CI_CURALGBS on page 949
Date based exchange rate during currency conversion while: <ul style="list-style-type: none"> • Adjustment Creation • FT GL Creation for Adjustments 	CI_CURALGAD on page 951
Date based exchange rate during currency conversion while: <ul style="list-style-type: none"> • Payment and Tender Creation • FT GL Creation for Payments 	CI_CURALGPY on page 953
Date based exchange rate during currency conversion while aggregating transactions	CI_CURALGTFM on page 955
Date and time based exchange rate during currency conversion while: <ul style="list-style-type: none"> • Bill Segment Generation • FT GL Creation for Bill Segments 	CI_EXCRTBS on page 957
Date and time based exchange rate during currency conversion while: <ul style="list-style-type: none"> • Adjustment Creation • FT GL Creation for Adjustments 	CI_EXCRTAD on page 958
Date and time based exchange rate during currency conversion while: <ul style="list-style-type: none"> • Payment and Tender Creation • FT GL Creation for Payments 	CI_EXCRTPY on page 960
Date and time based exchange rate during currency conversion while aggregating transactions	CI_EXCRTTFM on page 962

C1_CURALGBS

The **C1_CURALGBS** algorithm type is used to convert the amount in one currency to another currency using date based exchange rate. You can define date or date and time based global and division-specific exchange rates. The system might use the direct division-specific or global exchange rate (i.e. FROM CCY to TO CCY) or direct reverse division-specific or global exchange rate (i.e. TO CCY to FROM CCY) during currency conversion. If either direct or direct reverse exchange rate is not available, the system might use division-specific or global exchange rate through base currency during currency conversion. For example, if the FROM CCY is Canadian Dollars, TO CCY is Japanese Yen, and the division's base currency is U.S. Dollars, the system will first convert the amount from Canadian Dollars to U.S. Dollars and then convert the amount from U.S. Dollars to Japanese Yen.

The system allows you to indicate the order, in which the exchange rate must be searched, in the currency conversion algorithm. If you use the **Direct Rate First** search order, the system searches for an exchange rate in the specified order:

1. Division-specific direct exchange rate
2. Global direct exchange rate
3. Division-specific direct reverse exchange rate (if the **Division Reverse Rate** parameter is set to **Yes**)
4. Global direct reverse exchange rate (if the **Global Reverse Rate** parameter is set to **Yes**)
5. Division-specific exchange rate through base currency
6. Division-specific reverse exchange rate through base currency (if the **Division Reverse Rate** parameter is set to **Yes**)
7. Global exchange rate through base currency
8. Global reverse exchange rate through base currency (if the **Global Reverse Rate** parameter is set to **Yes**)

If you use the **Division First** search order, the system searches for an exchange rate in the specified order:

1. Division-specific direct exchange rate
2. Division-specific direct reverse exchange rate (if the **Division Reverse Rate** parameter is set to **Yes**)
3. Division-specific exchange rate through base currency
4. Division-specific reverse exchange rate through base currency (if the **Division Reverse Rate** parameter is set to **Yes**)
5. Global direct exchange rate
6. Global direct reverse exchange rate (if the **Global Reverse Rate** parameter is set to **Yes**)
7. Global exchange rate through base currency
8. Global reverse exchange rate through base currency (if the **Global Reverse Rate** parameter is set to **Yes**)

You need to attach an algorithm of the **C1_CURALGBS** algorithm type on the **Currency Conversion For Bill Segments** algorithm spot of the division for which you want to enable the currency conversion feature. Once the algorithm is attached, the currency conversion will take place during:

- Bill Segment Generation
- FT GL Creation for Bill Segments

The **C1_CURALGBS** algorithm type contains the following parameters:

Parameter	Description	Mandatory (Yes or No)
Override Base Currency	Used to specify the base currency. This will override division's base currency while searching for an exchange rate through base currency.	No
Conversion Type	Used when you want to use the exchanges rates with a particular conversion type during currency conversion.	No
	Note: The parameter value must be already defined as a value in the CONV_TYPE_FLG lookup field.	

Parameter	Description	Mandatory (Yes or No)
Search Order (Valid Values: Division First, Direct Rate First)	Used to indicate the order in which you want to search for an exchange rate during currency conversion. The valid values are: <ul style="list-style-type: none"> • Direct Rate First • Division First If you do not specify the value for this parameter, by default, the system uses the Division First search order.	No
Division Reverse Rate (Valid Values: Yes, No)	Used to indicate whether you want the system to search for division-specific reverse exchange rate (i.e. To CCY to From CCY). The valid values are: <ul style="list-style-type: none"> • Yes • No If you do not specify the value for this parameter, by default, the system does not use the division-specific reverse exchange rate.	No
Global Reverse Rate (Valid Values: Yes, No)	Used to indicate whether you want the system to search for global reverse exchange rate (i.e. To CCY to From CCY). The valid values are: <ul style="list-style-type: none"> • Yes • No If you do not specify the value for this parameter, by default, the system does not use the global reverse exchange rate.	No

Related Topics

For more information on...	See...
Bill Segment Generation	Bill Segment Generation on page 946
FT GL Creation	FT GL Creation on page 948
How to setup the currency conversion feature	Prerequisites on page 945

C1_CURALGAD

The **C1_CURALGAD** algorithm type is used to convert the amount in one currency to another currency using date based exchange rate. You can define date or date and time based global and division-specific exchange rates. The system might use the direct division-specific or global exchange rate (i.e. FROM CCY to TO CCY) or direct reverse division-specific or global exchange rate (i.e. TO CCY to FROM CCY) during currency conversion. If either direct or direct reverse exchange rate is not available, the system might use division-specific or global exchange rate through base currency during currency conversion. For example, if the FROM CCY is Canadian Dollars, TO CCY is Japanese Yen, and the division's base currency is U.S. Dollars, the system will first convert the amount from Canadian Dollars to U.S. Dollars and then convert the amount from U.S. Dollars to Japanese Yen.

The system allows you to indicate the order, in which the exchange rate must be searched, in the currency conversion algorithm. If you use the **Direct Rate First** search order, the system searches for an exchange rate in the specified order:

1. Division-specific direct exchange rate
2. Global direct exchange rate

3. Division-specific direct reverse exchange rate (if the **Division Reverse Rate** parameter is set to **Yes**)
4. Global direct reverse exchange rate (if the **Global Reverse Rate** parameter is set to **Yes**)
5. Division-specific exchange rate through base currency
6. Division-specific reverse exchange rate through base currency (if the **Division Reverse Rate** parameter is set to **Yes**)
7. Global exchange rate through base currency
8. Global reverse exchange rate through base currency (if the **Global Reverse Rate** parameter is set to **Yes**)

If you use the **Division First** search order, the system searches for an exchange rate in the specified order:

1. Division-specific direct exchange rate
2. Division-specific direct reverse exchange rate (if the **Division Reverse Rate** parameter is set to **Yes**)
3. Division-specific exchange rate through base currency
4. Division-specific reverse exchange rate through base currency (if the **Division Reverse Rate** parameter is set to **Yes**)
5. Global direct exchange rate
6. Global direct reverse exchange rate (if the **Global Reverse Rate** parameter is set to **Yes**)
7. Global exchange rate through base currency
8. Global reverse exchange rate through base currency (if the **Global Reverse Rate** parameter is set to **Yes**)

You need to attach an algorithm of the **C1_CURALGAD** algorithm type on the **Currency Conversion For Adjustments** algorithm spot of the division for which you want to enable the currency conversion feature. Once the algorithm is attached, the currency conversion will take place during:

- Adjustment Creation
- FT GL Creation for Adjustments

The **C1_CURALGAD** algorithm type contains the following parameters:

Parameter	Description	Mandatory (Yes or No)
Override Base Currency	Used to specify the base currency. This will override division's base currency while searching for an exchange rate through base currency.	No
Conversion Type	Used when you want to use the exchanges rates with a particular conversion type during currency conversion. Note: The parameter value must be already defined as a value in the CONV_TYPE_FLG lookup field.	No
Search Order (Valid Values: Division First, Direct Rate First)	Used to indicate the order in which you want to search for an exchange rate during currency conversion. The valid values are: <ul style="list-style-type: none"> • Direct Rate First • Division First If you do not specify the value for this parameter, by default, the system uses the Division First search order.	No
Division Reverse Rate (Valid Values: Yes, No)	Used to indicate whether you want the system to search for division-specific reverse exchange rate (i.e. To CCY to From CCY). The valid values are:	No

Parameter	Description	Mandatory (Yes or No)
	<ul style="list-style-type: none"> • Yes • No <p>If you do not specify the value for this parameter, by default, the system does not use the division-specific reverse exchange rate.</p>	
Global Reverse Rate (Valid Values: Yes, No)	<p>Used to indicate whether you want the system to search for global reverse exchange rate (i.e. To CCY to From CCY). The valid values are:</p> <ul style="list-style-type: none"> • Yes • No <p>If you do not specify the value for this parameter, by default, the system does not use the global reverse exchange rate.</p>	No

Related Topics

For more information on...	See...
Adjustment Creation	Adjustment Creation on page 947
FT GL Creation	FT GL Creation on page 948
How to setup the currency conversion feature	Prerequisites on page 945

C1_CURALGPY

The **C1_CURALGPY** algorithm type is used to convert the amount in one currency to another currency using date based exchange rate. You can define date or date and time based global and division-specific exchange rates. The system might use the direct division-specific or global exchange rate (i.e. FROM CCY to TO CCY) or direct reverse division-specific or global exchange rate (i.e. TO CCY to FROM CCY) during currency conversion. If either direct or direct reverse exchange rate is not available, the system might use division-specific or global exchange rate through base currency during currency conversion. For example, if the FROM CCY is Canadian Dollars, TO CCY is Japanese Yen, and the division's base currency is U.S. Dollars, the system will first convert the amount from Canadian Dollars to U.S. Dollars and then convert the amount from U.S. Dollars to Japanese Yen.

The system allows you to indicate the order, in which the exchange rate must be searched, in the currency conversion algorithm. If you use the **Direct Rate First** search order, the system searches for an exchange rate in the specified order:

1. Division-specific direct exchange rate
2. Global direct exchange rate
3. Division-specific direct reverse exchange rate (if the **Division Reverse Rate** parameter is set to **Yes**)
4. Global direct reverse exchange rate (if the **Global Reverse Rate** parameter is set to **Yes**)
5. Division-specific exchange rate through base currency
6. Division-specific reverse exchange rate through base currency (if the **Division Reverse Rate** parameter is set to **Yes**)
7. Global exchange rate through base currency
8. Global reverse exchange rate through base currency (if the **Global Reverse Rate** parameter is set to **Yes**)

If you use the **Division First** search order, the system searches for an exchange rate in the specified order:

1. Division-specific direct exchange rate
2. Division-specific direct reverse exchange rate (if the **Division Reverse Rate** parameter is set to **Yes**)
3. Division-specific exchange rate through base currency
4. Division-specific reverse exchange rate through base currency (if the **Division Reverse Rate** parameter is set to **Yes**)
5. Global direct exchange rate
6. Global direct reverse exchange rate (if the **Global Reverse Rate** parameter is set to **Yes**)
7. Global exchange rate through base currency
8. Global reverse exchange rate through base currency (if the **Global Reverse Rate** parameter is set to **Yes**)

You need to attach an algorithm of the **C1_CURALGPY** algorithm type on the **Currency Conversion For Payments** algorithm spot of the division for which you want to enable the currency conversion feature. Once the algorithm is attached, the currency conversion will take place during:

- Payment and Tender Creation
- FT GL Creation for Payments

The **C1_CURALGPY** algorithm type contains the following parameters:

Parameter	Description	Mandatory (Yes or No)
Override Base Currency	Used to specify the base currency. This will override division's base currency while searching for an exchange rate through base currency.	No
Conversion Type	Used when you want to use the exchanges rates with a particular conversion type during currency conversion. Note: The parameter value must be already defined as a value in the CONV_TYPE_FLG lookup field.	No
Search Order (Valid Values: Division First, Direct Rate First)	Used to indicate the order in which you want to search for an exchange rate during currency conversion. The valid values are: <ul style="list-style-type: none"> • Direct Rate First • Division First If you do not specify the value for this parameter, by default, the system uses the Division First search order.	No
Division Reverse Rate (Valid Values: Yes, No)	Used to indicate whether you want the system to search for division-specific reverse exchange rate (i.e. To CCY to From CCY). The valid values are: <ul style="list-style-type: none"> • Yes • No If you do not specify the value for this parameter, by default, the system does not use the division-specific reverse exchange rate.	No
Global Reverse Rate (Valid Values: Yes, No)	Used to indicate whether you want the system to search for global reverse exchange rate (i.e. To CCY to From CCY). The valid values are:	No

Parameter	Description	Mandatory (Yes or No)
	<ul style="list-style-type: none"> • Yes • No <p>If you do not specify the value for this parameter, by default, the system does not use the global reverse exchange rate.</p>	

Related Topics

For more information on...	See...
Payment and Tender Creation	Payment and Tender Creation on page 947
FT GL Creation	FT GL Creation on page 948
How to setup the currency conversion feature	Prerequisites on page 945

C1_CURALGTFM

The **C1_CURALGTFM** algorithm type is used to convert the amount in one currency to another currency using date based exchange rate. You can define date or date and time based global and division-specific exchange rates. The system might use the direct division-specific or global exchange rate (i.e. FROM CCY to TO CCY) or direct reverse division-specific or global exchange rate (i.e. TO CCY to FROM CCY) during currency conversion. If either direct or direct reverse exchange rate is not available, the system might use division-specific or global exchange rate through base currency during currency conversion. For example, if the FROM CCY is Canadian Dollars, TO CCY is Japanese Yen, and the division's base currency is U.S. Dollars, the system will first convert the amount from Canadian Dollars to U.S. Dollars and then convert the amount from U.S. Dollars to Japanese Yen.

The system allows you to indicate the order, in which the exchange rate must be searched, in the currency conversion algorithm. If you use the **Direct Rate First** search order, the system searches for an exchange rate in the specified order:

1. Division-specific direct exchange rate
2. Global direct exchange rate
3. Division-specific direct reverse exchange rate (if the **Division Reverse Rate** parameter is set to **Yes**)
4. Global direct reverse exchange rate (if the **Global Reverse Rate** parameter is set to **Yes**)
5. Division-specific exchange rate through base currency
6. Division-specific reverse exchange rate through base currency (if the **Division Reverse Rate** parameter is set to **Yes**)
7. Global exchange rate through base currency
8. Global reverse exchange rate through base currency (if the **Global Reverse Rate** parameter is set to **Yes**)

If you use the **Division First** search order, the system searches for an exchange rate in the specified order:

1. Division-specific direct exchange rate
2. Division-specific direct reverse exchange rate (if the **Division Reverse Rate** parameter is set to **Yes**)
3. Division-specific exchange rate through base currency
4. Division-specific reverse exchange rate through base currency (if the **Division Reverse Rate** parameter is set to **Yes**)
5. Global direct exchange rate
6. Global direct reverse exchange rate (if the **Global Reverse Rate** parameter is set to **Yes**)

7. Global exchange rate through base currency

8. Global reverse exchange rate through base currency (if the **Global Reverse Rate** parameter is set to **Yes**)

You need to attach an algorithm of the **C1_CURALGTFM** algorithm type on the **TFM - Currency Conversion** algorithm spot of the division for which you want to enable the currency conversion feature. Once the algorithm is attached, the currency conversion will take place during the transaction aggregation process when the transaction or UDF currency is different from the pricing currency.

The **C1_CURALGTFM** algorithm type contains the following parameters:

Parameter	Description	Mandatory (Yes or No)
Override Base Currency	Used to specify the base currency. This will override division's base currency while searching for an exchange rate through base currency.	No
Conversion Type	Used when you want to use the exchanges rates with a particular conversion type during currency conversion.	No
	Note: The parameter value must be already defined as a value in the CONV_TYPE_FLG lookup field.	
Search Order (Valid Values: Division First, Direct Rate First)	Used to indicate the order in which you want to search for an exchange rate during currency conversion. The valid values are: <ul style="list-style-type: none"> • Direct Rate First • Division First If you do not specify the value for this parameter, by default, the system uses the Division First search order.	No
Division Reverse Rate (Valid Values: Yes, No)	Used to indicate whether you want the system to search for division-specific reverse exchange rate (i.e. To CCY to From CCY). The valid values are: <ul style="list-style-type: none"> • Yes • No If you do not specify the value for this parameter, by default, the system does not use the division-specific reverse exchange rate.	No
Global Reverse Rate (Valid Values: Yes, No)	Used to indicate whether you want the system to search for global reverse exchange rate (i.e. To CCY to From CCY). The valid values are: <ul style="list-style-type: none"> • Yes • No If you do not specify the value for this parameter, by default, the system does not use the global reverse exchange rate.	No

Related Topics

For more information on...	See...
Transaction Aggregation	Transaction Aggregation on page 948
FT GL Creation	FT GL Creation on page 948

For more information on...	See...
How to setup the currency conversion feature	Prerequisites on page 945

C1_EXCRTBS

The **C1_EXCRTBS** algorithm type is used to convert the amount in one currency to another currency using date and time based exchange rate. You can define date or date and time based global and division-specific exchange rates. The system might use the direct division-specific or global exchange rate (i.e. FROM CCY to TO CCY) or direct reverse division-specific or global exchange rate (i.e. TO CCY to FROM CCY) during currency conversion. If either direct or direct reverse exchange rate is not available, the system might use division-specific or global exchange rate through base currency during currency conversion. For example, if the FROM CCY is Canadian Dollars, TO CCY is Japanese Yen, and the division's base currency is U.S. Dollars, the system will first convert the amount from Canadian Dollars to U.S. Dollars and then convert the amount from U.S. Dollars to Japanese Yen.

The system allows you to indicate the order, in which the exchange rate must be searched, in the currency conversion algorithm. If you use the **Direct Rate First** search order, the system searches for an exchange rate in the specified order:

1. Division-specific direct exchange rate
2. Global direct exchange rate
3. Division-specific direct reverse exchange rate (if the **Division Reverse Rate** parameter is set to **Yes**)
4. Global direct reverse exchange rate (if the **Global Reverse Rate** parameter is set to **Yes**)
5. Division-specific exchange rate through base currency
6. Division-specific reverse exchange rate through base currency (if the **Division Reverse Rate** parameter is set to **Yes**)
7. Global exchange rate through base currency
8. Global reverse exchange rate through base currency (if the **Global Reverse Rate** parameter is set to **Yes**)

If you use the **Division First** search order, the system searches for an exchange rate in the specified order:

1. Division-specific direct exchange rate
2. Division-specific direct reverse exchange rate (if the **Division Reverse Rate** parameter is set to **Yes**)
3. Division-specific exchange rate through base currency
4. Division-specific reverse exchange rate through base currency (if the **Division Reverse Rate** parameter is set to **Yes**)
5. Global direct exchange rate
6. Global direct reverse exchange rate (if the **Global Reverse Rate** parameter is set to **Yes**)
7. Global exchange rate through base currency
8. Global reverse exchange rate through base currency (if the **Global Reverse Rate** parameter is set to **Yes**)

You need to attach an algorithm of the **C1_EXCRTBS** algorithm type on the **Currency Conversion For Bill Segments** algorithm spot of the division for which you want to enable the currency conversion feature. Once the algorithm is attached, the currency conversion will take place during:

- Bill Segment Generation
- FT GL Creation for Bill Segments

The **C1_EXCRTBS** algorithm type contains the following parameters:

Parameter	Description	Mandatory (Yes or No)
Override Base Currency	Used to specify the base currency. This will override division's base currency while searching for an exchange rate through base currency.	No
Conversion Type	Used when you want to use the exchanges rates with a particular conversion type during currency conversion.	No
	Note: The parameter value must be already defined as a value in the CONV_TYPE_FLG lookup field.	

Parameter	Description	Mandatory (Yes or No)
Search Order (Valid Values: Division First, Direct Rate First)	Used to indicate the order in which you want to search for an exchange rate during currency conversion. The valid values are: <ul style="list-style-type: none"> • Direct Rate First • Division First If you do not specify the value for this parameter, by default, the system uses the Division First search order.	No
Division Reverse Rate (Valid Values: Yes, No)	Used to indicate whether you want the system to search for division-specific reverse exchange rate (i.e. To CCY to From CCY). The valid values are: <ul style="list-style-type: none"> • Yes • No If you do not specify the value for this parameter, by default, the system does not use the division-specific reverse exchange rate.	No
Global Reverse Rate (Valid Values: Yes, No)	Used to indicate whether you want the system to search for global reverse exchange rate (i.e. To CCY to From CCY). The valid values are: <ul style="list-style-type: none"> • Yes • No If you do not specify the value for this parameter, by default, the system does not use the global reverse exchange rate.	No
Exchange Rate Override Algorithm	Used to attach a custom algorithm when you want to use an exchange rate search mechanism other than the one defined in this algorithm.	No
Exchange Rate Source	Used when you want to use the exchanges rates received from a particular source during currency conversion. <p>Note: The parameter value must be already defined as a value in the EXCH_RATE_SRC_FLG lookup field.</p>	No

Related Topics

For more information on...	See...
Bill Segment Generation	Bill Segment Generation on page 946
FT GL Creation	FT GL Creation on page 948
How to setup the currency conversion feature	Prerequisites on page 945

C1_EXCRTAD

The **C1_EXCRTAD** algorithm type is used to convert the amount in one currency to another currency using date and time based exchange rate. You can define date or date and time based global and division-specific exchange rates. The system might use the direct division-specific or global exchange rate (i.e. FROM CCY to TO CCY) or direct reverse division-specific or global exchange rate (i.e. TO CCY to FROM CCY) during currency conversion. If either direct or

direct reverse exchange rate is not available, the system might use division-specific or global exchange rate through base currency during currency conversion. For example, if the FROM CCY is Canadian Dollars, TO CCY is Japanese Yen, and the division's base currency is U.S. Dollars, the system will first convert the amount from Canadian Dollars to U.S. Dollars and then convert the amount from U.S. Dollars to Japanese Yen.

The system allows you to indicate the order, in which the exchange rate must be searched, in the currency conversion algorithm. If you use the **Direct Rate First** search order, the system searches for an exchange rate in the specified order:

1. Division-specific direct exchange rate
2. Global direct exchange rate
3. Division-specific direct reverse exchange rate (if the **Division Reverse Rate** parameter is set to **Yes**)
4. Global direct reverse exchange rate (if the **Global Reverse Rate** parameter is set to **Yes**)
5. Division-specific exchange rate through base currency
6. Division-specific reverse exchange rate through base currency (if the **Division Reverse Rate** parameter is set to **Yes**)
7. Global exchange rate through base currency
8. Global reverse exchange rate through base currency (if the **Global Reverse Rate** parameter is set to **Yes**)

If you use the **Division First** search order, the system searches for an exchange rate in the specified order:

1. Division-specific direct exchange rate
2. Division-specific direct reverse exchange rate (if the **Division Reverse Rate** parameter is set to **Yes**)
3. Division-specific exchange rate through base currency
4. Division-specific reverse exchange rate through base currency (if the **Division Reverse Rate** parameter is set to **Yes**)
5. Global direct exchange rate
6. Global direct reverse exchange rate (if the **Global Reverse Rate** parameter is set to **Yes**)
7. Global exchange rate through base currency
8. Global reverse exchange rate through base currency (if the **Global Reverse Rate** parameter is set to **Yes**)

You need to attach an algorithm of the **C1_EXCRTAD** algorithm type on the **Currency Conversion For Adjustments** algorithm spot of the division for which you want to enable the currency conversion feature. Once the algorithm is attached, the currency conversion will take place during:

- Adjustment Creation
- FT GL Creation for Adjustments

The **C1_EXCRTAD** algorithm type contains the following parameters:

Parameter	Description	Mandatory (Yes or No)
Override Base Currency	Used to specify the base currency. This will override division's base currency while searching for an exchange rate through base currency.	No
Conversion Type	Used when you want to use the exchanges rates with a particular conversion type during currency conversion. Note: The parameter value must be already defined as a value in the CONV_TYPE_FLG lookup field.	No
Search Order (Valid Values: Division First, Direct Rate First)	Used to indicate the order in which you want to search for an exchange rate during currency conversion. The valid values are: <ul style="list-style-type: none"> • Direct Rate First • Division First If you do not specify the value for this parameter, by default, the system uses the Division First search order.	No

Parameter	Description	Mandatory (Yes or No)
Division Reverse Rate (Valid Values: Yes, No)	Used to indicate whether you want the system to search for division-specific reverse exchange rate (i.e. To CCY to From CCY). The valid values are: <ul style="list-style-type: none"> • Yes • No If you do not specify the value for this parameter, by default, the system does not use the division-specific reverse exchange rate.	No
Global Reverse Rate (Valid Values: Yes, No)	Used to indicate whether you want the system to search for global reverse exchange rate (i.e. To CCY to From CCY). The valid values are: <ul style="list-style-type: none"> • Yes • No If you do not specify the value for this parameter, by default, the system does not use the global reverse exchange rate.	No
Exchange Rate Override Algorithm	Used to attach a custom algorithm when you want to use an exchange rate search mechanism other than the one defined in this algorithm.	No
Exchange Rate Source	Used when you want to use the exchanges rates received from a particular source during currency conversion. Note: The parameter value must be already defined as a value in the EXCH_RATE_SRC_FLG lookup field.	No

Related Topics

For more information on...	See...
Adjustment Creation	Adjustment Creation on page 947
FT GL Creation	FT GL Creation on page 948
How to setup the currency conversion feature	Prerequisites on page 945

C1_EXCRTPY

The **C1_EXCRTPY** algorithm type is used to convert the amount in one currency to another currency using date and time based exchange rate. You can define date or date and time based global and division-specific exchange rates. The system might use the direct division-specific or global exchange rate (i.e. FROM CCY to TO CCY) or direct reverse division-specific or global exchange rate (i.e. TO CCY to FROM CCY) during currency conversion. If either direct or direct reverse exchange rate is not available, the system might use division-specific or global exchange rate through base currency during currency conversion. For example, if the FROM CCY is Canadian Dollars, TO CCY is Japanese Yen, and the division's base currency is U.S. Dollars, the system will first convert the amount from Canadian Dollars to U.S. Dollars and then convert the amount from U.S. Dollars to Japanese Yen.

The system allows you to indicate the order, in which the exchange rate must be searched, in the currency conversion algorithm. If you use the **Direct Rate First** search order, the system searches for an exchange rate in the specified order:

1. Division-specific direct exchange rate
2. Global direct exchange rate

3. Division-specific direct reverse exchange rate (if the **Division Reverse Rate** parameter is set to **Yes**)
4. Global direct reverse exchange rate (if the **Global Reverse Rate** parameter is set to **Yes**)
5. Division-specific exchange rate through base currency
6. Division-specific reverse exchange rate through base currency (if the **Division Reverse Rate** parameter is set to **Yes**)
7. Global exchange rate through base currency
8. Global reverse exchange rate through base currency (if the **Global Reverse Rate** parameter is set to **Yes**)

If you use the **Division First** search order, the system searches for an exchange rate in the specified order:

1. Division-specific direct exchange rate
2. Division-specific direct reverse exchange rate (if the **Division Reverse Rate** parameter is set to **Yes**)
3. Division-specific exchange rate through base currency
4. Division-specific reverse exchange rate through base currency (if the **Division Reverse Rate** parameter is set to **Yes**)
5. Global direct exchange rate
6. Global direct reverse exchange rate (if the **Global Reverse Rate** parameter is set to **Yes**)
7. Global exchange rate through base currency
8. Global reverse exchange rate through base currency (if the **Global Reverse Rate** parameter is set to **Yes**)

You need to attach an algorithm of the **C1_EXCRTPY** algorithm type on the **Currency Conversion For Payments** algorithm spot of the division for which you want to enable the currency conversion feature. Once the algorithm is attached, the currency conversion will take place during:

- Payment and Tender Creation
- FT GL Creation for Payments

The **C1_EXCRTPY** algorithm type contains the following parameters:

Parameter	Description	Mandatory (Yes or No)
Override Base Currency	Used to specify the base currency. This will override division's base currency while searching for an exchange rate through base currency.	No
Conversion Type	Used when you want to use the exchanges rates with a particular conversion type during currency conversion. Note: The parameter value must be already defined as a value in the CONV_TYPE_FLG lookup field.	No
Search Order (Valid Values: Division First, Direct Rate First)	Used to indicate the order in which you want to search for an exchange rate during currency conversion. The valid values are: <ul style="list-style-type: none"> • Direct Rate First • Division First If you do not specify the value for this parameter, by default, the system uses the Division First search order.	No
Division Reverse Rate (Valid Values: Yes, No)	Used to indicate whether you want the system to search for division-specific reverse exchange rate (i.e. To CCY to From CCY). The valid values are: <ul style="list-style-type: none"> • Yes • No 	No

Parameter	Description	Mandatory (Yes or No)
	If you do not specify the value for this parameter, by default, the system does not use the division-specific reverse exchange rate.	
Global Reverse Rate (Valid Values: Yes, No)	Used to indicate whether you want the system to search for global reverse exchange rate (i.e. To CCY to From CCY). The valid values are: <ul style="list-style-type: none"> • Yes • No If you do not specify the value for this parameter, by default, the system does not use the global reverse exchange rate.	No
Exchange Rate Override Algorithm	Used to attach a custom algorithm when you want to use an exchange rate search mechanism other than the one defined in this algorithm.	No
Exchange Rate Source	Used when you want to use the exchanges rates received from a particular source during currency conversion. <p>Note: The parameter value must be already defined as a value in the EXCH_RATE_SRC_FLG lookup field.</p>	No

Related Topics

For more information on...	See...
Payment and Tender Creation	Payment and Tender Creation on page 947
FT GL Creation	FT GL Creation on page 948
How to setup the currency conversion feature	Prerequisites on page 945

C1_EXCRTTFM

The **C1_EXCRTTFM** algorithm type is used to convert the amount in one currency to another currency using date and time based exchange rate. You can define date or date and time based global and division-specific exchange rates. The system might use the direct division-specific or global exchange rate (i.e. FROM CCY to TO CCY) or direct reverse division-specific or global exchange rate (i.e. TO CCY to FROM CCY) during currency conversion. If either direct or direct reverse exchange rate is not available, the system might use division-specific or global exchange rate through base currency during currency conversion. For example, if the FROM CCY is Canadian Dollars, TO CCY is Japanese Yen, and the division's base currency is U.S. Dollars, the system will first convert the amount from Canadian Dollars to U.S. Dollars and then convert the amount from U.S. Dollars to Japanese Yen.

The system allows you to indicate the order, in which the exchange rate must be searched, in the currency conversion algorithm. If you use the **Direct Rate First** search order, the system searches for an exchange rate in the specified order:

1. Division-specific direct exchange rate
2. Global direct exchange rate
3. Division-specific direct reverse exchange rate (if the **Division Reverse Rate** parameter is set to **Yes**)
4. Global direct reverse exchange rate (if the **Global Reverse Rate** parameter is set to **Yes**)
5. Division-specific exchange rate through base currency
6. Division-specific reverse exchange rate through base currency (if the **Division Reverse Rate** parameter is set to **Yes**)
7. Global exchange rate through base currency

8. Global reverse exchange rate through base currency (if the **Global Reverse Rate** parameter is set to **Yes**)

If you use the **Division First** search order, the system searches for an exchange rate in the specified order:

1. Division-specific direct exchange rate
2. Division-specific direct reverse exchange rate (if the **Division Reverse Rate** parameter is set to **Yes**)
3. Division-specific exchange rate through base currency
4. Division-specific reverse exchange rate through base currency (if the **Division Reverse Rate** parameter is set to **Yes**)
5. Global direct exchange rate
6. Global direct reverse exchange rate (if the **Global Reverse Rate** parameter is set to **Yes**)
7. Global exchange rate through base currency
8. Global reverse exchange rate through base currency (if the **Global Reverse Rate** parameter is set to **Yes**)

You need to attach an algorithm of the **C1_EXCRTTFM** algorithm type on the **TFM - Currency Conversion** algorithm spot of the division for which you want to enable the currency conversion feature. Once the algorithm is attached, the currency conversion will take place during the transaction aggregation process when the transaction or UDF currency is different from the pricing currency.

The **C1_EXCRTTFM** algorithm type contains the following parameters:

Parameter	Description	Mandatory (Yes or No)
Override Base Currency	Used to specify the base currency. This will override division's base currency while searching for an exchange rate through base currency.	No
Conversion Type	Used when you want to use the exchanges rates with a particular conversion type during currency conversion.	No
	Note: The parameter value must be already defined as a value in the CONV_TYPE_FLG lookup field.	
Search Order (Valid Values: Division First, Direct Rate First)	Used to indicate the order in which you want to search for an exchange rate during currency conversion. The valid values are: <ul style="list-style-type: none"> • Direct Rate First • Division First <p>If you do not specify the value for this parameter, by default, the system uses the Division First search order.</p>	No
Division Reverse Rate (Valid Values: Yes, No)	Used to indicate whether you want the system to search for division-specific reverse exchange rate (i.e. To CCY to From CCY). The valid values are: <ul style="list-style-type: none"> • Yes • No <p>If you do not specify the value for this parameter, by default, the system does not use the division-specific reverse exchange rate.</p>	No
Global Reverse Rate (Valid Values: Yes, No)	Used to indicate whether you want the system to search for global reverse exchange rate (i.e. To CCY to From CCY). The valid values are: <ul style="list-style-type: none"> • Yes • No 	No

Parameter	Description	Mandatory (Yes or No)
	If you do not specify the value for this parameter, by default, the system does not use the global reverse exchange rate.	
Exchange Rate Override Algorithm	Used to attach a custom algorithm when you want to use an exchange rate search mechanism other than the one defined in this algorithm. Note: A sample algorithm type named CI_EXCRTOVRD is shipped with the product. It is used to fetch the exchange rate which is available corresponding to the transaction in the CI_TXN_DETAIL table. The exchange rate is then used by the algorithm which is created using the CI_EXCRTTFM algorithm type to convert the transaction amount from the transaction currency to the pricing currency. You must specify the column from where the exchange rate must be picked during currency conversion in the Transaction Detail Field for Exchange Rate parameter.	No
Exchange Rate Source	Used when you want to use the exchanges rates received from a particular source during currency conversion. Note: The parameter value must be already defined as a value in the EXCH_RATE_SRC_FLG lookup field.	No

Related Topics

For more information on...	See...
Transaction Aggregation	Transaction Aggregation on page 948
FT GL Creation	FT GL Creation on page 948
How to setup the currency conversion feature	Prerequisites on page 945
CI_EXCRTOVRD algorithm type	CI_EXCRTOVRD on page 966

FTFREZGLEXTN

The **FTFREZGLEXTN** algorithm type is used to create FT GL extension for the following financial transaction (FT) types when the account's invoice currency is different from the division's base currency:

- Adjustment
- Adjustment Cancellation
- Bill Segment
- Bill Cancellation
- Pay Segment
- Pay Cancellation

You need to attach an algorithm of the **FTFREZGLEXTN** algorithm type on the **FT Freeze** system event of the customer class. The FT GL extension is created for bill segments when you have an algorithm of the **C1_CURALGBS** algorithm type attached on the **Currency Conversion For Bill Segments** algorithm spot of the respective division. The FT GL extension is created for payments when you have an algorithm of the **C1_CURALGPY** algorithm type attached on the **Currency Conversion For Payments** algorithm spot of the respective division. The FT GL extension is created for adjustments when you have an algorithm of the **C1_CURALGAD** algorithm type attached on the **Currency Conversion For Adjustments** algorithm spot of the respective division.

The **FTFREZGLEXTN** algorithm type contains the following parameters:

Parameter	Description	Mandatory (Yes or No)
Exchange Rate Date Type for Adjustments with Freeze At Will	Used to indicate the date on which the exchange rate should be picked up when FT GL extension is created for adjustments with the Freeze At Will option. The valid values are: <ul style="list-style-type: none"> • A (Accounting Date) – Used to search for an exchange rate which is effective on the accounting date. • R (Arrears Date) - Used to search for an exchange rate which is effective on the arrears date. • F (FT Freeze Date) - Used to search for an exchange rate which is effective on the FT freeze date. • C (FT Create Date) - Used to search for an exchange rate which is effective on the FT creation date. 	Yes
Exchange Rate Date Type for Adjustments with Freeze At Bill Completion	Used to indicate the date on which the exchange rate should be picked up when FT GL extension is created for adjustments with the Freeze At Bill Completion option. The valid values are: <ul style="list-style-type: none"> • A (Accounting Date) – Used to search for an exchange rate which is effective on the accounting date. • R (Arrears Date) - Used to search for an exchange rate which is effective on the arrears date. • F (FT Freeze Date) - Used to search for an exchange rate which is effective on the FT freeze date. • C (FT Create Date) - Used to search for an exchange rate which is effective on the FT creation date. 	Yes
Exchange Rate Date Type for Payments (Valid Values: A, R, F, C)	Used to indicate the date on which the exchange rate should be picked up when FT GL extension is created for payments. The valid values are: <ul style="list-style-type: none"> • A (Accounting Date) – Used to search for an exchange rate which is effective on the accounting date. • R (Arrears Date) - Used to search for an exchange rate which is effective on the arrears date. 	Yes

Parameter	Description	Mandatory (Yes or No)
	<ul style="list-style-type: none"> • F (FT Freeze Date) - Used to search for an exchange rate which is effective on the FT freeze date. • C (FT Create Date) - Used to search for an exchange rate which is effective on the FT creation date. 	
Exchange Rate Date Type for Bill Segments (Valid Values: A, R, F, C, E)	<p>Used to indicate the date on which the exchange rate should be picked up when FT GL extension is created for bill segments. The valid values are:</p> <ul style="list-style-type: none"> • A (Accounting Date) – Used to search for an exchange rate which is effective on the accounting date. • R (Arrears Date) - Used to search for an exchange rate which is effective on the arrears date. • F (FT Freeze Date) - Used to search for an exchange rate which is effective on the FT freeze date. • C (FT Create Date) - Used to search for an exchange rate which is effective on the FT creation date. • E (Bill Segment End Date) - Used to search for an exchange rate which is effective on the bill segment end date. <p>Note: If you set the Exchange Rate Date Type for Bill Segments parameter to R, ensure that you set the Bill Segment Freeze Option to Freeze At Bill Completion in the Billing tab of the Installation Options screen. Otherwise, erroneous results might occur.</p>	Yes

Related Topics

For more information on...	See...
FT GL Creation	FT GL Creation on page 948
How to setup the currency conversion feature	Prerequisites on page 945

C1_EXCRTOVRD

The **C1_EXCRTOVRD** algorithm type is used to fetch the exchange rate which is available corresponding to the transaction in the **CI_TXN_DETAIL** table. The exchange rate is then used by the algorithm which is created using the **C1_EXCRTTFM** algorithm type to convert the transaction amount from the transaction currency to the pricing currency. If you want to fetch exchange rate from the **CI_TXN_DETAIL** table, you need to create an algorithm using the **C1_EXCRTOVRD** algorithm type and attach it to the **Exchange Rate Override Algorithm** parameter in the algorithm which is created using the **C1_EXCRTTFM** algorithm type.

The **C1_EXCRTOVRD** algorithm type contains the following parameters:

Parameter	Description	Mandatory (Yes or No)
Transaction Detail Field for Exchange Rate	Used to indicate the column of the CI_TXN_DETAIL table from where the exchange rate must be picked during currency conversion.	Yes

Related Topics

For more information on...	See...
C1_EXCRTTFM algorithm type	CI_EXCRTTFM on page 962

Exchange Rate (Used for Searching)

You can define date or date and time based global and division-specific exchange rates. The date based exchange rate means that the exchange rate is applicable throughout the day. However, the date and time based exchange rate means that the exchange rate is applicable from that date and time onwards. The global exchange rate can be used for all divisions, whereas the division-specific exchange range can only be used for the division for which the exchange rate is defined.

Note: At present, time is not passed as input from any module (such as, payments, adjustments, billing, transaction feed management, and so on) during currency conversion. Therefore, even if you define date and time based exchange rates and use the date and time based currency conversion algorithms at the division level, the system will not search date and time based exchange rate when multiple exchange rates are available on the same day. The system will randomly pick an exchange rate on that day. The implementation team has to build the custom logic to pass or input time to the date and time based currency conversion algorithms in order to derive the appropriate exchange rate.

The system might use the direct division-specific or global exchange rate (i.e. FROM CCY to TO CCY) or direct reverse division-specific or global exchange rate (i.e. TO CCY to FROM CCY) during currency conversion. If either direct or direct reverse exchange rate is not available, the system might use division-specific or global exchange rate through base currency during currency conversion. For example, if the FROM CCY is Canadian Dollars, TO CCY is Japanese Yen, and the division's base currency is U.S. Dollars, the system will first convert the amount from Canadian Dollars to U.S. Dollars and then convert the amount from U.S. Dollars to Japanese Yen. You can define the order in which exchange rate must be searched in the currency conversion algorithm.

The **Exchange Rate** screen allows you to search for date or date and time based global and division-specific exchange rate using various search criteria. It also allows you to define, edit, and delete an exchange rate. This screen consists of the following zones:

- [Search Exchange Rate](#) on page 967

Search Exchange Rate

The **Search Exchange Rate** zone allows you to search for an exchange rate using various search criteria. This zone contains the following two sections:

- **Search Criteria** — The **Search Criteria** section contains the following fields:

Field Name	Field Description	Mandatory (Yes or No)
Search By	Used to indicate whether you want to search date or date and time based exchange rates. The valid values are: <ul style="list-style-type: none"> • Date/Time and Exchange Rate Source • Date 	Yes

Field Name	Field Description	Mandatory (Yes or No)
	Note: By default, the Date/Time and Exchange Rate Source option is selected.	
From Currency	Used to search exchange rates with a particular source currency.	No
To Currency	Used to search exchange rates with a particular target currency.	No
Division	Used to search exchange rates which are defined for a particular division. Note: You can only view those divisions to which you have access in the Division list.	No
Conversion Type	Used to search exchange rates which are defined using a particular conversion type.	No
Effective Start Date/Time	Used to search exchange rates which are effective from a particular date and time onwards. Note: This field appears when you select the Date/Time and Exchange Rate Source option from the Search By list.	No
Effective End Date/Time	Used to search exchange rates which are effective till a particular date and time. Note: This field appears when you select the Date/Time and Exchange Rate Source option from the Search By list.	No
Effective Start Date	Used to search exchange rates which are effective from a particular date onwards. Note: This field appears when you select the Date option from the Search By list.	No
Effective End Date	Used to search exchange rates which are effective till a particular date. Note: This field appears when you select the Date option from the Search By list.	No
Exchange Rate Source	Used to search exchange rates which are received from a particular source. Note: This field appears when you select the Date/Time and Exchange Rate Source option from the Search By list.	No

Note: You must specify at least one search criterion while searching for an exchange rate.

- **Search Results** — On clicking the **Search** button, the search results appear based on the specified search criteria. The **Search Results** section contains the following columns:

Column Name	Column Description
Exchange Rate ID	Displays the exchange rate ID.
	Note: It has a link. On clicking the link, the Exchange Rate screen appears with the details of the respective exchange rate.
From Currency	Indicates the currency which is translated. In other words, it is the source currency.
To Currency	Indicates the currency in which the source currency is translated. In other words, it is the target currency.
Division	Indicates the division for which the exchange rate is defined.
	Note: The data does not appear in this column when the exchange rate is a global exchange rate.
Exchange Rate Source	Indicates the source from where the exchange rate is received.
	Note: This column appears when you select the Date/Time and Exchange Rate Source option from the Search By list.
Conversion Type	Indicates the conversion type of the exchange rate.
Effective Start Date/Time	Displays the date and time from when the exchange rate is effective.
	Note: This column appears when you select the Date/Time and Exchange Rate Source option from the Search By list.
Effective End Date/Time	Displays the date and time till when the exchange rate is effective.
	Note:
	This column appears when you select the Date/Time and Exchange Rate Source option from the Search By list. The data does not appear in this column when the exchange rate is a global exchange rate. This is because a global exchange rate does not have an end date and time.
Effective Start Date	Displays the date from when the exchange rate is effective.
	Note: This column appears when you select the Date option from the Search By list.
Effective End Date	Displays the date till when the exchange rate is effective.
	Note:
	This column appears when you select the Date option from the Search By list. The data does not appear in this column when the exchange rate is a global exchange rate. This is because a global exchange rate does not have an end date.
Exchange Rate	Displays the exchange rate.
Spread	Indicates the spread for the exchange rate.

Column Name	Column Description
Inverse Rate	Displays the reverse exchange rate.
Edit	On clicking the Edit (✎) icon, the Add/Edit Exchange Rate screen appears where you can edit the details of the exchange rate.
Delete	On clicking the Delete (🗑) icon, you can delete the exchange rate.

Note:

If you specify the effective start date and time while searching for an exchange rate, the system searches exchange rates which are effective from the specified date and time onwards. Let us understand this with the help of an example. The following table lists the exchange rates which are defined in the system where the From Currency is USD, To Currency is INR, and Division is D1:

Exchange Rate	Effective Start Date and Time	Effective End Date and Time
RT1	01-01-2014 12:00:00 PM	-
RT2	02-01-2014 12:00:00 PM	-
RT3	03-01-2014 12:00:00 PM	-

Now, when you search for exchange rates using the following search criteria, the system accordingly displays the search results:

Search Criteria	Search Results
Effective Start Date and Time: 01-01-2014 12:00:00 PM	All three exchange rates — RT1, RT2, and RT3 — will appear in the search results.
Effective Start Date and Time: 01-01-2014 12:00:00 PM; Effective End Date and Time: 31-01-2014 22:00:00 PM	RT1 will appear in the search results.
Effective Start Date and Time: 01-01-2014 12:00:00 PM; Effective End Date and Time: 02-01-2014 22:00:00 PM	RT1 and RT2 will appear in the search results.
Effective Start Date and Time: 02-01-2014 12:00:00 PM	RT2 and RT3 will appear in the search results.
Effective Start Date and Time: 02-01-2014 12:00:00 PM; Effective End Date and Time: 02-28-2014 22:00:00 PM	RT2 will appear in the search results.
Effective Start Date and Time: 03-01-2014 12:00:00 PM	RT3 will appear in the search results.

Related Topics

For more information on...	See...
How to search for an exchange rate	Searching for an Exchange Rate on page 971
How to view the details of an exchange rate	Viewing the Exchange Rate Details on page 981
How to define an exchange rate	Defining an Exchange Rate on page 971
How to edit an exchange rate	Editing an Exchange Rate on page 975

For more information on...	See...
How to delete an exchange rate	Deleting an Exchange Rate on page 977

Searching for an Exchange Rate

Prerequisites

To search for an exchange rate, you should have:

- Currencies and divisions defined in the application
- Conversion types defined in the **CONV_TYPE_FLG** lookup field
- Exchange rate sources defined in the **EXCH_RATE_SRC_FLG** lookup field

Procedure

To search for an exchange rate:

1. Click the **Menu** link in the **Application** toolbar.
A list appears.
2. From the **Main** menu, select **Pricing Management** and then click **Exchange Rate**.
A sub-menu appears.
3. Click the **Search** option from the **Exchange Rate** sub-menu.
The **Exchange Rate** screen appears.
4. Select the required option from the **Search By** list depending on whether you want to search date or date and time based exchange rates.
5. Enter the search criteria in the **Search Exchange Rate** zone.

Note: ORMB search engine supports wildcard search, where you can substitute the percentage (%) symbol as a stand in for any word or letter in a search criteria. You can use the ‘%’ wildcard character in all the input fields except the date fields. The ‘%’ wildcard character is suffixed automatically at the end of the partial search criteria. Therefore, you may or may not specify the wildcard character at the end of the partial search criteria. However, you have to prefix the wildcard character manually wherever required.

6. Click **Search**.
A list of exchange rates that meet the search criteria appears in the **Search Results** section.

Related Topics

For more information on...	See...
Exchange Rate screen	Exchange Rate (Used for Searching) on page 967
Search Exchange Rate zone	Search Exchange Rate on page 967

Defining an Exchange Rate

Prerequisites

To define an exchange rate, you should have:

- Determine Business Object algorithm defined using the **F1-MOBO** algorithm type and attached to the **C1_EXCHRATE** maintenance object

Note: The **C1-ExchangeRate** and **C1_EXCHRATE_BO** business objects are shipped with the product. The **C1-ExchangeRate** business object is used while defining and editing date and time based exchange rates. However, the **C1_EXCHRATE_BO** business object is used while defining and editing date based exchange rates. Depending on whether you want to define date or date and time based exchange rates, you need to accordingly set the **Business Object** parameter in the Determine Business Object algorithm. The system will then accordingly display the fields while defining or editing an exchange rate.

- Currencies and divisions defined in the application
- Conversion types defined in the **CONV_TYPE_FLG** lookup field
- Exchange rate sources defined in the **EXCH_RATE_SRC_FLG** lookup field

Procedure

To define an exchange rate:

1. Click the **Menu** link in the **Application** toolbar.
A list appears.
2. From the **Main** menu, select **Pricing Management** and then click **Exchange Rate**.
A sub-menu appears.
3. Click the **Add** option from the **Exchange Rate** sub-menu.

The **Add/Edit Exchange Rate** screen appears. It contains the following fields:

Field Name	Field Description	Mandatory (Yes or No)
Business Object	Indicates the business object using which you are defining an exchange rate.	Not applicable
From Currency	Used to indicate the currency that you want to translate. In other words, it is used to indicate the source currency.	Yes
To Currency	Used to indicate the currency in which you want to translate the source currency. In other words, it is used to indicate the target currency.	Yes
Conversion Type	Used to indicate the conversion type for the exchange rate.	Yes
Division	Used to indicate the division for which you want to define the exchange rate.	Yes (Conditional)
	<p>Note:</p> <p>You can only view those divisions to which you have access in the Division list.</p> <p>You must leave this field blank while defining a global exchange rate.</p>	<p>Note: This field is required when you are defining a division-specific exchange rate.</p>
Exchange Rate Source	Used to indicate the source from where the exchange rate is received.	No
	<p>Note: This field appears when you are defining a date and time based exchange rate.</p>	

Field Name	Field Description	Mandatory (Yes or No)
Effective Start Date/Time	Used to specify the date and time from when the exchange rate is effective.	Yes
	<p>Note:</p> <p>This field appears when you are defining a date and time based exchange rate.</p> <p>By default, the time is set to 12:00 AM. You can change the time, if required.</p>	
Effective End Date/Time	Used to specify the date and time till when the exchange rate is effective.	Yes (Conditional)
	<p>Note:</p> <p>The effective end date and time cannot be earlier than the effective start date and time.</p> <p>You must leave this field blank while defining a global exchange rate. This is because a global exchange rate does not have an end date and time.</p> <p>This field appears when you are defining a date and time based exchange rate.</p> <p>By default, the time is set to 12:00 AM. You can change the time, if required.</p>	
Effective Start Date	Used to specify the date from when the exchange rate is effective.	Yes
	<p>Note: This field appears when you are defining a date based exchange rate.</p>	
Effective End Date	Used to specify the date till when the exchange rate is effective.	Yes (Conditional)
	<p>Note:</p> <p>The effective end date cannot be earlier than the effective start date.</p> <p>You must leave this field blank while defining a global exchange rate. This is because a global exchange rate does not have an end date.</p> <p>This field appears when you are defining a date based exchange rate.</p>	
Exchange Rate	Used to specify the exchange rate. In other words, it is the number of units of the target currency that is equivalent to a single unit of the source currency.	Yes

Field Name	Field Description	Mandatory (Yes or No)
	Note: The system provides you with the facility to specify the exchange rate value with a precision of upto 18 decimal places (0.000000000000000001).	
Spread	Used to specify the spread for the exchange rate.	No

Tip: Alternatively, you can access the **Add/Edit Exchange Rate** screen by clicking the **Add Exchange Rate** button in the **Page Title** area of the **Exchange Rate** screen.

- Enter the required details in the **Add/Edit Exchange Rate** screen.
- Define characteristics for the exchange rate, if required.

Note: You can define characteristics when you are defining a date and time based exchange rate.

- Click **Save**.

The exchange rate is defined in the system.

Note: If an exchange rate is already defined with a source and conversion type combination on a given date and time, the system will not allow you to define another exchange rate with the same specifications.

Related Topics

For more information on...	See...
Exchange Rate screen	Exchange Rate (Used for Searching) on page 967
Search Exchange Rate zone	Search Exchange Rate on page 967
How to define a characteristic for an exchange rate	Defining a Characteristic for an Exchange Rate on page 974
How to set the C1_EXCHRATE feature configuration	Setting the C1_EXCHRATE Feature Configuration on page 4317

Defining a Characteristic for an Exchange Rate

Prerequisites

To define a characteristic for an exchange rate, you should have:

- Characteristic types defined in the application (where the characteristic entity is set to **Exchange Rate**)

Procedure

To define a characteristic for an exchange rate:

- Ensure that the **Characteristics** section is expanded when you are defining or editing an exchange rate.

The **Characteristics** section contains the following fields:

Field Name	Field Description	Mandatory (Yes or No)
Effective Date	Used to specify the date from when the characteristic is effective for the exchange rate.	Yes (Conditional)

Field Name	Field Description	Mandatory (Yes or No)
		Note: This field is required when you are defining a characteristic for the exchange rate.
Characteristic Type	Used to indicate the characteristic type.	Yes (Conditional)
	Note: The list includes only those characteristic types where the characteristic entity is set to Exchange Rate .	Note: This field is required when you are defining a characteristic for the exchange rate.
Characteristic Value	Used to specify the value for the characteristic type.	Yes (Conditional)
	Note: On specifying the value for a predefined characteristic type, the description of the characteristic value appears corresponding to the Characteristic Value field.	Note: This field is required when you are defining a characteristic for the exchange rate.

Note: The **Characteristics** section appears when you are defining or editing a date and time based exchange rate.

2. Enter the required details in the **Characteristics** section.

Note: If you select a predefined characteristic type, the **Search** (🔍) icon appears corresponding to the **Characteristic Value** field. On clicking the **Search** icon, you can search for a predefined characteristic value.

3. If you want to define more than one characteristic for the exchange rate, click the **Add** (+) icon and then repeat step 2.

Note: However, if you want to remove a characteristic from the exchange rate, click the **Delete** (🗑️) icon corresponding to the characteristic.

Related Topics

For more information on...	See...
How to define an exchange rate	Defining an Exchange Rate on page 971
How to edit an exchange rate	Editing an Exchange Rate on page 975

Editing an Exchange Rate

Procedure

To edit an exchange rate:

1. Search for the exchange rate in the **Exchange Rate** screen.
2. In the **Search Results** section, click the **Edit** (✎) icon in the **Edit** column corresponding to the exchange rate whose details you want to edit.

The **Add/Edit Exchange Rate** screen appears. It contains the following fields:

Field Name	Field Description	Mandatory (Yes or No)
Exchange Rate ID	Displays the exchange rate ID.	Not applicable

Field Name	Field Description	Mandatory (Yes or No)
Business Object	Indicates the business object used while defining an exchange rate.	Not applicable
From Currency	Indicates the currency which is translated. In other words, it is the source currency.	Not applicable
To Currency	Indicates the currency in which the source currency is translated. In other words, it is the target currency.	Not applicable
Conversion Type	Indicates the conversion type of the exchange rate.	Not applicable
Division	Indicates the division for which the exchange rate is defined. Note: The data does not appear corresponding to this field when the exchange rate is a global exchange rate.	Not applicable
Exchange Rate Source	Indicates the source from where the exchange rate is received. Note: This field appears when you are editing a date and time based exchange rate.	Not applicable
Effective Start Date/Time	Displays the date and time from when the exchange rate is effective. Note: This field appears when you are editing a date and time based exchange rate.	Not applicable
Effective End Date/Time	Used to specify the date and time till when the exchange rate is effective. Note: The effective end date and time cannot be earlier than the effective start date and time. This field appears when you are editing a date and time based exchange rate. This field is non-editable when you are editing a date and time based global exchange rate. This is because a global exchange rate does not have an end date and time.	Yes (Conditional) Note: If the End Date Required for Division Override option type of the C1_EXCHRATE feature configuration is set to Y , this field is required when you are defining a division-specific exchange rate.
Effective Start Date	Displays the date from when the exchange rate is effective. Note: This field appears when you are editing a date based exchange rate.	Not applicable
Effective End Date	Used to specify the date till when the exchange rate is effective.	Yes (Conditional)

Field Name	Field Description	Mandatory (Yes or No)
	<p>Note:</p> <p>The effective end date cannot be earlier than the effective start date.</p> <p>This field appears when you are editing a date based exchange rate.</p> <p>This field is non-editable when you are editing a date based global exchange rate. This is because a global exchange rate does not have an end date.</p>	<p>Note: If the End Date Required for Division Override option type of the C1_EXCHRATE feature configuration is set to Y, this field is required when you are defining a division-specific exchange rate.</p>
Exchange Rate	<p>Used to specify the exchange rate. In other words, it is the number of units of the target currency that is equivalent to a single unit of the source currency.</p> <p>Note: The system provides you with the facility to specify the exchange rate value with a precision of upto 18 decimal places (0.000000000000000001).</p>	Yes
Spread	Used to specify the spread for the exchange rate.	No

Tip: Alternatively, you can click the **Edit** button in the **Exchange Rate** zone to edit the details of the exchange rate.

3. Modify the required details in the **Add/Edit Exchange Rate** screen.
4. Define, edit, or remove characteristics of the exchange rate, if required.

Note: The **Characteristics** section appears when you are editing a date and time based exchange rate.

5. Click **Save**.

The changes made to the exchange rate are saved.

Related Topics

For more information on...	See...
How to search for an exchange rate	Searching for an Exchange Rate on page 971
Exchange Rate zone	Exchange Rate on page 978
How to set the C1_EXCHRATE feature configuration	Setting the C1_EXCHRATE Feature Configuration on page 4317

Deleting an Exchange Rate

Procedure

To delete an exchange rate:

1. Search for the exchange rate in the **Exchange Rate** screen.
2. In the **Search Results** section, click the **Delete** (🗑️) icon in the **Delete** column corresponding to the exchange rate that you want to delete.

A message appears confirming whether you want to delete the exchange rate.

Tip: Alternatively, you can click the **Delete** button in the **Exchange Rate** zone to delete the exchange rate.

3. Click **OK**.

The exchange rate is deleted.

Related Topics

For more information on...	See...
How to search for an exchange rate	Searching for an Exchange Rate on page 971

Exchange Rate (Used for Viewing)

The **Exchange Rate** screen allows you to:

- Edit the details of the exchange rate
- Delete the exchange rate
- View the details of the exchange rate
- View the log of the exchange rate

It consists of the following tabs:

- [Exchange Rate - Main](#) on page 978
- [Exchange Rate - Log](#) on page 980

Exchange Rate - Main

The **Main** tab displays information about the exchange rate. It contains the following zones:

- [Exchange Rate](#) on page 978

Exchange Rate

The **Exchange Rate** zone displays the details of the exchange rate. This zone contains the following sections:

- **Main** — This section provides basic information about the exchange rate. It contains the following fields:

Field Name	Field Description
Exchange Rate ID	Displays the exchange rate ID.
From Currency	Indicates the currency which is translated. In other words, it is the source currency.
To Currency	Indicates the currency in which the source currency is translated. In other words, it is the target currency.
Conversion Type	Indicates the conversion type of the exchange rate.
Division	Indicates the division for which the exchange rate is defined.

Field Name	Field Description
	<p>Note:</p> <p>The data does not appear corresponding to this field when the exchange rate is a global exchange rate.</p> <p>It has a link. On clicking the link, the Division screen appears with the details of the respective division.</p>
Exchange Rate Source	<p>Indicates the source from where the exchange rate is received.</p> <p>Note: This field appears when you are viewing the details of a date and time based exchange rate.</p>
Effective Start Date/Time	<p>Displays the date and time from when the exchange rate is effective.</p> <p>Note: This field appears when you are viewing the details of a date and time based exchange rate.</p>
Effective End Date/Time	<p>Displays the date and time till when the exchange rate is effective.</p> <p>Note:</p> <p>This field appears when you are viewing the details of a date and time based exchange rate.</p> <p>The data does not appear corresponding to this field when the exchange rate is a global exchange rate. This is because a global exchange rate does not have an end date and time.</p>
Effective Start Date	<p>Displays the date from when the exchange rate is effective.</p> <p>Note: This field appears when you are viewing the details of a date based exchange rate.</p>
Effective End Date	<p>Displays the date till when the exchange rate is effective.</p> <p>Note:</p> <p>This field appears when you are viewing the details of a date based exchange rate.</p> <p>The data does not appear corresponding to this field when the exchange rate is a global exchange rate. This is because a global exchange rate does not have an end date.</p>
Exchange Rate	Displays the exchange rate.
Spread	Indicates the spread for the exchange rate.

- **Characteristics** — This section lists the characteristics of the exchange rate. It contains the following columns:

Column Name	Column Description
Effective Date	Indicates the date from when the characteristic is effective for the exchange rate.
Characteristic Type	Indicates the characteristic type.
Characteristic Value	Displays the value of the characteristic type.

Note: The **Characteristics** section appears when you are viewing the details of a date and time based exchange rate.

- **Record Actions** — This section contains the following buttons:

Button Name	Button Description
Edit	Used to edit the details of the exchange rate.
Delete	Used to delete the exchange rate.

- **Record Information** — This section contains the following fields:

Field Name	Field Description
Business Object	Indicates the business object using which the exchange rate is created. In addition, a context menu appears corresponding to this field which helps in navigating to other screens in the application. Note: It has a link. On clicking the link, the Business Object screen appears where you can view the details of the respective business object.
Create Date/Time	Displays the date and time when the exchange rate is created.

Related Topics

For more information on...	See...
How to edit an exchange rate	Editing an Exchange Rate on page 975
How to delete an exchange rate	Deleting an Exchange Rate on page 977

Exchange Rate - Log

The **Log** tab contains the following zone:

- [Exchange Rate Log](#) on page 980

Exchange Rate Log

The **Exchange Rate Log** zone lists the complete trail of actions performed on the exchange rate. It contains the following columns:

Column Name	Column Description
Date/Time	Displays the date and time when the action was performed on the exchange rate.
Details	Displays the details about the action performed on the exchange rate.
User	Indicates the user who has performed the action on the exchange rate.
Log Type	Indicates the type of log.
Related Object	Indicates the object or entity which is generated when the action is performed on the exchange rate. Note: At present, no data appears in this column. The implementation team can build the custom logic to meet the business requirements.
Status Reason	Indicates the reason why the status was changed. Note: At present, no data appears in this column. The implementation team can create a custom exchange rate business object with the status lifecycle.

Viewing the Exchange Rate Details

Procedure

To view the details of an exchange rate:

1. Search for the exchange rate in the **Exchange Rate** screen.
2. In the **Search Results** section, click the link in the **Exchange Rate ID** column corresponding to the exchange rate whose details you want to view.

The **Exchange Rate** screen appears. It contains the following zones:

- **Exchange Rate** — Displays the details of the exchange rate.
 - **Exchange Rate Log** — Lists the complete trail of actions performed on the exchange rate.
3. View the details of the exchange rate in the **Exchange Rate** zone.
 4. View the log of the exchange rate in the **Exchange Rate Log** zone.

Related Topics

For more information on...	See...
How to search for an exchange rate	Searching for an Exchange Rate on page 971
Exchange Rate screen	Exchange Rate (Used for Viewing) on page 978
Exchange Rate zone	Exchange Rate on page 978
Exchange Rate Log zone	Exchange Rate Log on page 980

Chapter 11

Transaction Feed Management

Topics:

- [Prerequisites](#)
- [Transaction Rating Before Billing](#)
- [Transaction Aggregation](#)
- [Transaction Aggregation Batch Processing](#)
- [Transaction Disaggregation](#)
- [Transaction Disaggregation Batch Processing](#)
- [Transaction Cancellation](#)
- [Transaction Cancellation Batch Processing](#)
- [Transaction Rollback](#)
- [Feed Status Transition](#)
- [Transaction Status Transition](#)
- [Transaction Leg Status Transition](#)
- [Transaction Data File](#)
- [Error List](#)
- [Alert Notification for Transaction Feed Management](#)
- [Feed Management Dashboard](#)
- [Transaction Details](#)
- [Transaction Source](#)
- [Transaction Record Type](#)
- [Transaction Aggregation Rule](#)
- [Schedule](#)
- [Disaggregation Request](#)

Oracle Revenue Management and Billing provides you with a facility to upload banking and Administrative Services Only (ASO) transactions received from various product processors or applications for billing. You can use the **File Upload Interface** feature to upload transaction data files in the following formats:

- Comma Separated Values
- JavaScript Object Notation
- Fixed Position
- Pipe Separated Values
- Tilde Separated Values
- Extensible Markup Language

For more information on how to upload the data using the **File Upload Interface** feature, refer to the respective feature documentation. Once the transaction data is uploaded in the system, you need to:

- Validate Header Details
- Validate Transaction Details and Determine Initial Product
- Verify Price Item Pricing
- Rate Transactions Before Billing (if required)
- Create and Update Billable Charge with the SQI values
- Clean-up Unwanted Data

The system provides the flexibility to rate the transactions either prior to billing or during billing. Based on the business requirements, you can configure the system such that transactions mapped to some price item can be rated at a frequency which is different than the account's billing frequency. For example, daily, weekly, etc. During the transaction feed management process, each transaction goes through various statuses until it is billed to the person. For more information about the transaction statuses, see [Transaction Status Transition](#) on page 1033.

The transaction feed management process includes the following sub-processes:

- [Transaction Aggregation](#) on page 992
- [Transaction Disaggregation](#) on page 1018
- [Transaction Cancellation](#) on page 1026
- [Transaction Rollback](#) on page 1030

Prerequisites

To setup the transaction feed management process, you need to do the following:

- Define the required transaction sources in the system
- Define the required transaction record types for each transaction source
- Associate the required SQIs with a price item —division combination
- Define the required transaction aggregation rule for each SQI
- Define the aggregation schedules in the system
- Define the required rules in the system to determine initial price item for transactions
- Attach a validation algorithm to each account identifier type (to ensure that the account identifier type and account identifier combination is unique in or across divisions)
- Attach the **Price Assignment Search** algorithm to each division
- Define the **TFM - Processing Date** characteristic for each division
- Create an algorithm of the **C1_CURALGTFM** algorithm type and attach it to the **TFM - Currency Conversion** algorithm spot of the division for which you want to enable the currency conversion feature
- Define the required exchange rates for currency conversion
- Define values for the PAGE_NUMBER lookup field
- Create an algorithm of the **C1_RTCL_POPC** algorithm type and attach it to the **TFM - Rate Post-Processing** algorithm spot of the required division

Besides this, you need to setup the following feature configurations:

- [Setting the C1_RLENG Feature Configuration](#) on page 4346
- [Setting the C1-TXNDMYID Feature Configuration](#) on page 4347
- [Setting the C1_PPARM_FLG Feature Configuration](#) on page 4340
- [Setting the C1_FM Feature Configuration](#) on page 4324

Transaction Rating Before Billing

The system provides the flexibility to rate the transaction legs either prior to billing or during billing. Based on the business requirements, you can configure the system such that transactions mapped to some price items can be rated at a frequency which is different than the account's billing frequency. For example, daily, weekly, etc. This will help to reduce the performance issues which are caused when large volume of transactions are rated at the time of billing.

The system offers the following ways in which a transaction leg can be priced, rated and billed:

1. **Rate the Transaction Leg During Billing** – In this approach, you can use either of the following ways:
 - a. Determine effective pricing for a transaction leg, create a billable charge for the transaction leg, and then determine the rate during billing.
 - b. Determine effective pricing for a transaction leg, create a billable charge for aggregated transaction legs, and then determine the rate during billing.
2. **Rate the Transaction Leg Prior to Billing** – In this approach, you can use either of the following ways:
 - a. Determine effective pricing and rate for a transaction leg, and accumulate pre-calculated charges in a pass through billable charge based on the distribution code, currency code, description on bill, aggregation

parameter group ID (which is created based on the rate component characteristics). The pass through billable charge is then billed during billing.

- b. Determine effective pricing for a transaction leg, aggregate the transaction legs, determine rate for aggregated service quantities, and then accumulate pre-calculated charges in a pass through billable charge based on the distribution code, currency code, description on bill, aggregation parameter group ID (which is created based on the rate component characteristics). The pass through billable charge is then billed during billing.
- c. Determine effective pricing and rate for a transaction leg and create a pass through billable charge for the transaction leg which is billed during billing.

3. Ignore the Transaction Leg for Billing – In this approach, you can use either of the following ways:

- a. Determine effective pricing for a transaction leg, but the billable charge is not created for the transaction leg.
- b. Determine effective pricing and rate for a transaction leg, but the billable charge is not created for the transaction leg.

Note:

Once the rate is determined for transaction legs, a set of rate component characteristics and their values are grouped. For example, if a price assignment has the following rate components, the system creates two groups — Group A and Group B:

- RC1, Char1=Y, Char2=Y
- RC2, Char1=N, Char2=Y
- RC3, Char1=Y, Char2=Y

Group A contains Char1=Y, Char2=Y and Group B contains Char1=N, Char2=Y. These groups are used for accumulating pre-calculated charges. A unique aggregation parameter group ID is generated for each group. If a group with a set of rate component characteristics and their values already exists in the system, a new group is not created. Instead, the existing group is used for accumulating pre-calculated charges. The aggregation parameter group ID is created when you attach an algorithm of the **C1_RTCL_POPC** algorithm type on the **TFM - Rate Post-Processing** algorithm entity in the **Algorithms** tab of the **Division** screen. Note that the system invokes the algorithm which is attached on the derived account's division and not on the division to which the transaction belongs.

While defining a price item pricing, you need to specify the rating criteria which indicates how and when you want to rate the transaction legs. The valid values are:

- Do Not Rate Transactions (DNRT)
- Aggregate transactions and then rate aggregated SQs (AGTR)
- Rate individual transactions and aggregate calc lines across transactions (RITA)
- Rate Transactions (RITX)

Along with the **Rating Criteria** field, the **Ignore Transaction** and **Aggregate Transaction** fields help the system to determine how and when the corresponding transaction leg must be rated. The following table indicates how to configure the system in order to use the above mentioned ways:

Transaction Rating Approach and Way	Ignore Transaction (Yes or No)	Aggregate Transaction (Yes or No)	Rating Criteria	Batch in which the Rate is Determined
3a	Yes	Not applicable	Do Not Rate Transactions (DNRT)	Not applicable because ignored transactions are not considered for billing.

Transaction Rating Approach and Way	Ignore Transaction (Yes or No)	Aggregate Transaction (Yes or No)	Rating Criteria	Batch in which the Rate is Determined
3b	Yes	Not applicable	Rate Transactions (RITX)	Update Status (C1-TXNEX)
1b	No	Yes	Do Not Rate Transactions (DNRT)	Not applicable because the rate is determined during billing.
2b	No	Yes	Aggregate transactions and then rate aggregated SQs (AGTR)	Service Quantity Calculation (C1-TXNSQ)
2a	No	Yes	Rate individual transactions and aggregate calc lines across transactions (RITA)	Update Status (C1-TXNEX)
1a	No	No	Do Not Rate Transactions (DNRT)	Not applicable because the rate is determined during billing.
2c	No	No	Rate Transactions (RITX)	Service Quantity Calculation (C1-TXNSQ)

Let us understand the following transaction rating ways with the help of an example:

- 2a
- 2b
- 2c

The following table lists the account, price item, and price item parameters combination to which transaction T1 and T2 are mapped:

Transaction	Transaction Volume	Transaction Date	Account	Price Item	Price Item Parameter Group ID	Price Assignment ID	Aggregation Schedule
T1	300	01/01/2015	A1	P1	PG1	PA1	Monthly
T1	300	01/01/2015	A2	P1	PG1	PA2	Monthly
T2	200	15/01/2015	A1	P1	PG1	PA1	Monthly
T2	200	15/01/2015	A3	P1	PG1	PA3	Monthly

The following table lists the rate components available on the PA1, PA2, and PA3 price assignments:

Transaction	Price Assignment ID	Rate Component	Currency Code	Distribution Code	Description on Bill	Aggregation Parameter Group ID (Rate Component's Characteristics)
T1	PA1	RC1-0.1*Transaction Volume	USD	BK-AR1	XYZ	Char1=Y
T1	PA1	RC2-0.2*Transaction Volume	USD	BK-AR2	ABC	Char2=Y
T1	PA2	RC3-0.3*Transaction Volume	USD	BK-AR3	XYZ	Char1=Y
T1	PA2	RC4-0.2*Transaction Volume	USD	BK-AR4	ABC	Char2=Y
T2	PA1	RC1-0.1*Transaction Volume	USD	BK-AR1	XYZ	Char1=Y
T2	PA1	RC2-0.2*Transaction Volume	USD	BK-AR2	ABC	Char2=Y
T2	PA3	RC3-0.3*Transaction Volume	USD	BK-AR3	XYZ	Char1=Y
T2	PA3	RC4-0.2*Transaction Volume	USD	BK-AR3	XYZ	Char1=Y

Now, if you use **RITA (2a)** approach, the system will rate a transaction leg and accumulate pre-calculated charges in a pass through billable charge based on the distribution code, currency code, description on bill, aggregation parameter group ID, as shown in the following table:

Billable Charge	Start Date	End Date	Transaction Leg	Rate Component	Calculation Details	Pass Through Charge (\$)	Comments
BC1	01/01/2015	31/01/2015	T1- A1P1PG1- PA1, T2- A1P1PG1- PA1	RC1	$300*0.1 = 30$, $200*0.1 = 20$	$30+20 = 50$	The pass through charge is calculated for each transaction leg and then accumulated because the distribution code, currency code, description on bill, and characteristics of the rate

Billable Charge	Start Date	End Date	Transaction Leg	Rate Component	Calculation Details	Pass Through Charge (\$)	Comments
							components are same.
BC1	01/01/2015	31/01/2015	T1–A1P1PG1–PA1, T2–A1P1PG1–PA1	RC2	300*0.2 = 60, 200*0.2 = 40	60+40 = 100	The pass through charge is calculated for each transaction leg and then accumulated because the distribution code, currency code, description on bill, and characteristics of the rate components are same.
BC2	01/01/2015	31/01/2015	T1–A2P1PG1–PA2	RC3	300*0.3 = 90	90	The pass through charge is calculated for the transaction leg.
BC2	01/01/2015	31/01/2015	T1–A2P1PG1–PA2	RC4	300*0.2 = 60	60	The pass through charge is calculated for the transaction leg.
BC3	01/01/2015	31/01/2015	T2–A3P1PG1–PA3	RC3, RC4	200*0.3 = 60, 200*0.2 = 40	60+40 = 100	The pass through charges are calculated for the transaction leg and then accumulated because the distribution code, currency code, description on bill, and characteristics of the rate components are same.

In the above example, the BC1 and BC2 will have two pass through lines, whereas the BC3 will have one pass through line.

Now, if you use **RITX (2c)** approach, the system will rate a transaction leg and calculate charges for each transaction leg in a separate pass through billable charge, as shown in the following table:

Billable Charge	Start Date	End Date	Transaction Leg	Rate Component	Calculation Details	Pass Through Charge (\$)	Comments
BC1	01/01/2015	31/01/2015	T1–A1P1PG1–PA1	RC1	300*0.1 = 30	30	The pass through charge

Billable Charge	Start Date	End Date	Transaction Leg	Rate Component	Calculation Details	Pass Through Charge (\$)	Comments
							is calculated for the transaction leg.
BC1	01/01/2015	31/01/2015	T1-A1P1PG1-PA1	RC2	$300 * 0.2 = 60$	60	The pass through charge is calculated for the transaction leg.
BC2	01/01/2015	31/01/2015	T1-A2P1PG1-PA2	RC3	$300 * 0.3 = 90$	90	The pass through charge is calculated for the transaction leg.
BC2	01/01/2015	31/01/2015	T1-A2P1PG1-PA2	RC4	$300 * 0.2 = 60$	60	The pass through charge is calculated for the transaction leg.
BC3	01/01/2015	31/01/2015	T2-A1P1PG1-PA1	RC1	$200 * 0.1 = 20$	20	The pass through charge is calculated for the transaction leg.
BC3	01/01/2015	31/01/2015	T2-A1P1PG1-PA1	RC2	$200 * 0.2 = 40$	40	The pass through charge is calculated for the transaction leg.
BC4	01/01/2015	31/01/2015	T2-A3P1PG1-PA3	RC3, RC4	$200 * 0.3 = 60$, $200 * 0.2 = 40$	$60 + 40 = 100$	The pass through charges are calculated for the transaction leg and then accumulated because the distribution code, currency code, description on bill, and characteristics of the rate components are same.

In the above example, the BC1, BC2, and BC3 will have two pass through lines, whereas the BC4 will have one pass through line.

Now, if you use **AGTR (2b)** approach, the system will determine effective pricing for a transaction leg, aggregate the transaction legs, determine rate for aggregated service quantities, and then accumulate pre-calculated charges in a pass through billable charge based on the distribution code, currency code, description on bill, aggregation parameter group ID (which is created based on the rate component characteristics), as shown in the following table:

Account- Price Item- Price Item Parameter Group- Price Assignment- Aggregation Schedule	Total Transaction Volume	Billable Charge	Start Date	End Date	Rate Component	Calculation Details	Pass Through Charge (\$)	Comments
A1PIPG1- PA1- Monthly	300+200 = 500	BC1	01/01/2015	31/01/2015	RC1	500*0.1 = 50	50	The transaction volume of T1 and T2 legs having the same price item and price item parameters combination and whose transaction date falls between the aggregation schedule is first aggregated and then pass through charge is calculated for aggregated service quantities.
A1PIPG1- PA1- Monthly	300+200 = 500	BC1	01/01/2015	31/01/2015	RC2	500*0.2 = 100	100	The transaction volume of T1 and T2 legs having the same price item and price item parameters combination and whose

Account- Price Item- Price Item Parameter Group- Price Assignment- Aggregation Schedule	Total Transaction Volume	Billable Charge	Start Date	End Date	Rate Component	Calculation Details	Pass Through Charge (\$)	Comments
								transaction date falls between the aggregation schedule is first aggregated and then pass through charge is calculated for aggregated service quantities.
A2P1PG1- PA2- Monthly	300	BC2	01/01/2015	31/01/2015	RC3	$300 * 0.3 = 90$	90	The pass through charge is calculated for the transaction leg.
A2P1PG1- PA2- Monthly	300	BC2	01/01/2015	31/01/2015	RC4	$300 * 0.2 = 60$	60	The pass through charge is calculated for the transaction leg.
A3P1PG1- PA3- Monthly	200	BC3	01/01/2015	31/01/2015	RC3, RC4	$200 * 0.3 = 60, 200 * 0.2 = 40$	$60 + 40 = 100$	The pass through charges are calculated for the transaction leg and then accumulated because the distribution code, currency code,

Account-Price Item-Price Item Parameter Group-Price Assignment-Aggregation Schedule	Total Transaction Volume	Billable Charge	Start Date	End Date	Rate Component	Calculation Details	Pass Through Charge (\$)	Comments
								description on bill, and characteristics of the rate components are same.

In the above example, the BC1 and BC2 will have two pass through lines, whereas the BC3 will have one pass through line.

Transaction Aggregation

The transaction aggregation process includes the following sub-processes:

- [Header Validation](#) on page 993
- [Transaction Validation and Initial Price Item Determination \(Specific to Financial Services Domain\)](#) on page 995
- [Price Item Pricing Verification](#) on page 1005
- [Aggregation](#) on page 1009
- [Clean Up](#) on page 1013

The following figure graphically explains the transaction aggregation process:

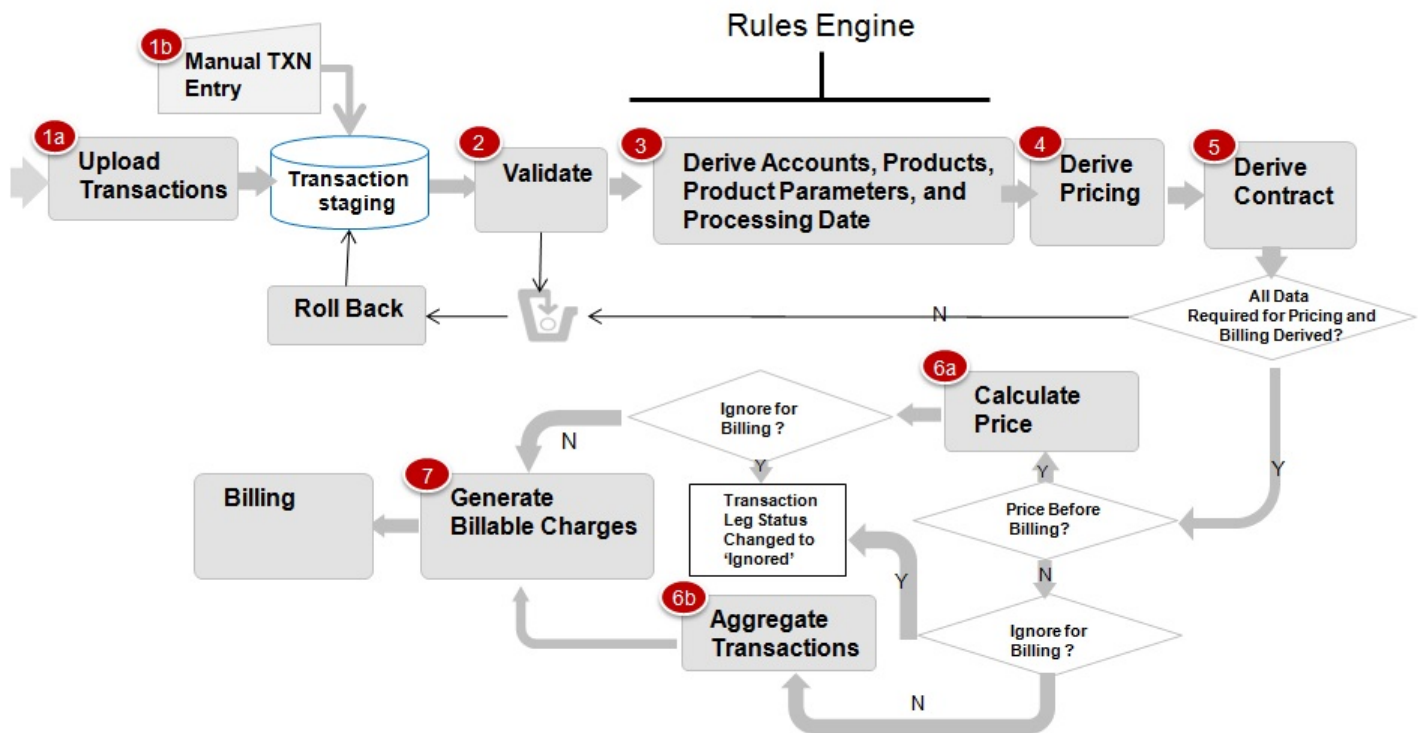

Header Validation

Once the file is uploaded in the system, you can execute the **Header Validation (C1-TXNHV)** batch to validate the file or header level information. It checks whether:

- Transaction Header ID and Transaction Source is available in the header.
- At least one transaction record is available in the file.
- The number of transaction records in the file matches the total transaction records in the header.
- The sum of transaction amount matches the total transaction amount in the header.
- The sum of transaction volume matches the total transaction volume in the header.
- File with the same header date and transaction header ID is not available in the system.
- External reference number is specified in each transaction record of the file.

If the file or header information is validated successfully, the status of the file or feed is changed to **Validated (VALI)** and the status of all transactions in the feed remains as **Uploaded (UPLD)**. However, if the header validation fails, the status of the feed and all transactions in the feed is changed to **Invalid (INVL)**.

The **Header Validation (C1-TXNHV)** batch is a multi-threaded batch. You can specify either of the following parameters while executing this batch:

Parameter Name	Description	Mandatory (Yes or No)
Transaction Header ID	Used when you want to validate a particular transaction feed.	No

Parameter Name	Description	Mandatory (Yes or No)
Transaction Source	Used when you want to validate the transaction feeds which are received from a particular transaction source.	No
Checksum Validation Required	Used to indicate whether the following should be validated: <ul style="list-style-type: none"> The number of transaction records in the file matches the total transaction records in the header. The sum of transaction amount matches the total transaction amount in the header. The sum of transaction volume matches the total transaction volume in the header. The valid values are: <ul style="list-style-type: none"> Y N 	No
Duplicate Check Required	Used to indicate whether the following should be validated: <ul style="list-style-type: none"> File with the same header date and external header ID is not available in the system. The valid values are: <ul style="list-style-type: none"> Y N <p>Note: The duplicate check is done only against the transaction feeds which are in the Validated (VALI) status and not against the transaction feeds which are in the Uploaded (UPLD) status.</p>	No
Allow Positive Transaction Volume in Header	Used to indicate whether you want to allow positive value in the total transaction volume which is specified in the header record. The valid values are: <ul style="list-style-type: none"> Y N <p>Note: By default, the parameter value is set to Y.</p>	Yes
Allow Negative Transaction Volume in Header	Used to indicate whether you want to allow negative value in the total transaction volume which is specified in the header record. The valid values are: <ul style="list-style-type: none"> Y N <p>Note: By default, the parameter value is set to N.</p>	Yes
Allow Zero Transaction Volume in Header	Used to indicate whether you want to allow zero value in the total transaction volume which is specified in the header record. The valid values are:	Yes

Parameter Name	Description	Mandatory (Yes or No)
	<ul style="list-style-type: none"> • Y • N 	
	Note: By default, the parameter value is set to N.	
Thread Pool Name	Used to specify the thread pool on which you want to execute the batch.	No

Transaction Validation and Initial Price Item Determination (Specific to Financial Services Domain)

This process includes the following three sub-processes:

- **Transaction Validation** - In this sub-process, the transaction records are validated. The transaction level validations are done to check the integrity of the data. During the transaction validation, the system checks whether:
 - Transaction source is defined in the system.
 - Transaction record type is defined for the transaction source in the system.
 - Division and currencies are defined in the system.
 - The account with the specified account identifier, account identifier type and division exists in the system.

Note: This validation is done when the **Transaction Detail Account Validation** option type of the **Feed Management (C1_FM)** feature configuration is set to **Y**. If you set the **Transaction Detail Account Validation** option type of the **Feed Management (C1_FM)** feature configuration to **N**, the system overrides the transaction's account identifier type, account identifier, and division with the first derived account's account identifier type, account identifier, and division, respectively.

- User ID (if available in the transaction information) is defined in the system.
- The value other than 'Y' or 'N' is not specified in the **Manual Switch** column.
- The value other than '+' or '-' is not specified in the **Credit/Debit Indicator** column.
- Transaction Amount is specified when Transaction Currency is specified, and vice versa.
- Additional Amount 1 is specified when Amount 1 Currency Code is specified, and vice versa.
- Additional Amount 2 is specified when Amount 2 Currency Code is specified, and vice versa.
- Additional Amount 3 is specified when Amount 3 Currency Code is specified, and vice versa.
- Additional Amount 4 is specified when Amount 4 Currency Code is specified, and vice versa.
- Additional Amount 5 is specified when Amount 5 Currency Code is specified, and vice versa.
- Additional Amount 6 is specified when Amount 6 Currency Code is specified, and vice versa.
- Additional Amount 7 is specified when Amount 7 Currency Code is specified, and vice versa.
- Additional Amount 8 is specified when Amount 8 Currency Code is specified, and vice versa.
- Additional Amount 9 is specified when Amount 9 Currency Code is specified, and vice versa.
- Additional Amount 10 is specified when Amount 10 Currency Code is specified, and vice versa.

If the transaction information is invalid or incorrect (for example, division is invalid), the status of the transaction is changed to **Error (EROR)**. But, if the transaction information is not available, the status of the transaction is changed to **Invalid (INVL)**.

- **Initial Price Item Determination** - Once the transaction records are validated, the account which will bear the charges for the transaction and the price item and variance parameter or price item parameters to which the transaction will be mapped are determined using certain business rules. These business rules are invoked through a rule type. Depending on the transaction record type, a rule type is invoked for each transaction. The effective rules with the specified rule type are executed, starting with the rule having highest priority, until a rule is satisfied. For example, a rule with the priority 10 will be executed before a rule with the priority 20.

Note: The system determines rules which are effective based on the **Processing Date for Transaction Feed Management** characteristic defined for the division to which the transaction belongs. The system uses the **Processing Date for Transaction Feed Management** characteristic which is effective on the transaction date. If the **Processing Date for Transaction Feed Management** characteristic type is set to BATCH_DT, the system executes rules which are effective on the batch business date. However, if the **Processing Date for Transaction Feed Management** characteristic type is set to TXN_DT, the system executes rules which are effective on the transaction date. Note that the transaction date must be earlier than or equal to the batch business date. And, if the **Processing Date for Transaction Feed Management** characteristic is not defined for the division to which a transaction belongs, the system, by default, executes rules which are effective on the transaction date.

Each rule contains one or more conditions or criteria. For example, Rule A states that if the transaction record type is R001 and the division is New York, then set the following output parameters:

- ACCT_NO1_Val - Account 1
- DIVISION1_VAL - D1
- PRODUCT1_1_Val - Price Item X

Here, Transaction Record Type = R001 and Division = New York are two conditions. If these two conditions in the rule are satisfied, then set three output parameters - ACCT_NO1_Val, DIVISION1_VAL and PRODUCT1_1_Val. Now, when this rule is executed and the transaction satisfies this criteria, the transaction is mapped to Price Item X and Account 1 which belongs to D1 bears the charges for the transaction. In case, the rule has four output parameters (ACCT_NO1_Val set to Account 1, DIVISION1_VAL set to D1, PRODUCT1_1_Val set to Price Item X, and PRODUCT1_2_Val set to Price Item Y), the transaction will be mapped to both the price items (i.e. Price Item X and Price Item Y) and Account 1 which belongs to D1 bears the charges for the transaction. A transaction can be mapped to one or more price items or to one or more price item and TOU (variance parameter) combinations. If the multi parameter based pricing feature is enabled, you can map a transaction to one or more price item and price item parameters combinations. Let us understand this with the help of an example.

Rule B states that if the transaction is performed in US and the transaction amount exceeds 1000 USD, then set the following output parameters:

- ACCT_NO1_Val - Account A
- DIVISION1_VAL - D1
- PRODUCT1_1_Val - Price Item X
- PCD1_1_1_VAL - Country
- PVL1_1_1_VAL - US
- PCD1_1_2_VAL - Currency
- PVL1_1_2_VAL - USD
- PRODUCT1_2_Val - Price Item Y
- PCD1_2_1_VAL - Country
- PVL1_2_1_VAL - US
- PCD1_2_2_VAL - Currency
- PVL1_2_2_VAL - USD

Now, when this rule is executed and the transaction satisfies the criteria, Account A which belongs to D1 bears the charges for the transaction which is mapped to the following price item and price item parameters combinations:

- Price Item X, Country - US, Currency - USD
- Price Item Y, Country - US, Currency - USD

More than one account can bear the charges for a transaction and each account can belong to a different division. You can map a transaction to one or more price items, to one or more price item and TOU (variance parameter) combinations, or to one or more price item and price item parameters combinations. The system allows you to map price items for each account. For example, Rule C states that if the transaction is performed in UK and the transaction amount exceeds 1000 USD, then set the following output parameters:

- ACCT_NO1_Val - Account A
- DIVISION1_VAL - D1
- PRODUCT1_1_Val - Price Item X
- PCD1_1_1_VAL - Country
- PVL1_1_1_VAL - UK
- PCD1_1_2_VAL - Currency
- PVL1_1_2_VAL - USD
- PRODUCT1_2_Val - Price Item Y
- PCD1_2_1_VAL - Country
- PVL1_2_1_VAL - UK
- PCD1_2_2_VAL - Currency
- PVL1_2_2_VAL - USD
- ACCT_NO2_Val - Account B
- DIVISION2_VAL - D2
- PRODUCT2_1_Val - Price Item A
- PCD2_1_1_VAL - Country
- PVL2_1_1_VAL - US
- PCD2_1_2_VAL - Currency
- PVL2_1_2_VAL - USD

Now, when this rule is executed and the transaction satisfies the criteria, the transaction is mapped to the following price item and price item parameters combinations:

Charges Borne By	Division to which the account belongs...	Price Item	Country	Currency
Account A	D1	Price Item X	UK	USD
Account A	D1	Price Item Y	UK	USD
Account B	D2	Price Item A	US	USD

You can limit the maximum accounts that can bear the charges for a transaction, maximum price item that can be mapped to a transaction, and maximum parameters that can be used with each price item to determine price item pricing. For more information, see [Defining a Transaction Record Type](#) on page 1115. You can also define rules

to ignore transactions based on the transaction attributes. If the rule returns the **IGNORE_SW** equal to **Y**, the status of the transaction is changed to **Ignored (IGNR)** and no further processing takes place on the transaction.

You can use the following output parameters while defining rules in the system:

Output Parameter	Naming Convention	Example	Description
Account Identifier	ACCT_NOX_Val	ACCT_NO1_Val, ACCT_NO2_Val, ACCT_NO3_Val,	Used to indicate the account which must bear the charges for the transaction.
Account Identifier Column Name	ACCT_NOX_Col	ACCT_NO1_Col, ACCT_NO2_Col, ACCT_NO3_Col, ...	Used to indicate the column from where the account identifier corresponding to the transaction (in the transaction details) must be picked.
Account Identifier Type	ACCT_NO_TYPEX_Val	ACCT_NO_TYPE1_Val, ACCT_NO_TYPE2_Val, ACCT_NO_TYPE3_Val, ...	Used to indicate the type of account identifier.
Account Identifier Type Column Name	ACCT_NO_TYPEX_Col	ACCT_NO_TYPE1_Col, ACCT_NO_TYPE2_Col, ACCT_NO_TYPE3_Col, ...	Used to indicate the column from where the account identifier type corresponding to the transaction (in the transaction details) must be picked.
Account Division	DIVISIONX_VAL	DIVISION1_VAL	Used to indicate the division to which the account belongs.
Account Division Column Name	DIVISIONX_COL	DIVISION1_COL	Used to indicate the column from where the division corresponding to the transaction (in the transaction details) must be picked.
Price Item Name	PRODUCTX_Y_Val	PRODUCT1_1_Val, PRODUCT2_1_Val, PRODUCT2_2_Val,	Used to indicate the price item to which the transaction must be mapped.
	Note: Here, X represents the account and Y represents the price item.		
Price Item Column Name	PRODUCTX_Y_Col	PRODUCT1_1_Col,, PRODUCT2_1_Col, PRODUCT2_2_Col, ...	Used to indicate the column from where the price item corresponding to the transaction (in the transaction details) must be picked.
	Note: Here, X represents the account and Y represents the price item.		
TOU	TOUX_Y_Val	TOU1_1_Val, TOU2_1_Val, TOU2_2_Val, ...	Used to indicate the variance parameter which you want to use along with the price item for price determination.
	Note: Here, X represents the account and Y represents the price item.		

Output Parameter	Naming Convention	Example	Description
			<p>Note: This output parameter appears when the Multi Price Parameter option type of the Multi Parameter Based Pricing (C1_PPARM_FLG) feature configuration is set to False.</p>
TOU Column Name	TOUX_Y_Col	TOU1_1_Col, TOU2_1_Col, TOU2_2_Col, ...	Used to indicate the column from where the variance parameter corresponding to the transaction (in the transaction details) must be picked.
	<p>Note: Here, X represents the account and Y represents the price item.</p>		
Parameter Code	PCDX_Y_Z_VAL	PCD1_1_1_VAL, PCD1_2_1_VAL, PCD2_1_1_VAL, ...	Used to indicate the parameter which you want to use along with the price item for price determination.
	<p>Note: At present, the system does not support the Parameter Code Column output parameter.</p>		
	<p>Note: Here, X represents the account, Y represents the price item, and Z represents the parameter.</p>		<p>Note: This output parameter appears when the Multi Price Parameter option type of the Multi Parameter Based Pricing (C1_PPARM_FLG) feature configuration is set to False.</p>
Parameter Value	PVLX_Y_Z_VAL	PVL1_1_1_VAL, PVL1_2_1_VAL, PVL2_1_1_VAL, ...	Used to specify the value for the parameter.
	<p>Note: Here, X represents the account, Y represents the price item, and Z represents the parameter.</p>		
			<p>Note: This output parameter appears when the Multi Price Parameter option type of the Multi Parameter Based Pricing (C1_PPARM_FLG) feature configuration is set to True.</p> <p>You must not specify any special character except underscore (_) in the parameter code. Otherwise, the status of the transaction is changed to Error (EROR).</p>
			<p>Note: This output parameter appears when the Multi Price Parameter option type of the Multi Parameter Based Pricing (C1_PPARM_FLG) feature configuration is set to True.</p> <p>The parameter value must not contain the equal to (=) and tilde (~) symbols. Otherwise, the status of the transaction is changed to Error (EROR).</p>

Output Parameter	Naming Convention	Example	Description
Parameter Value Column Name	PVLX_Y_Z_COL	PVL1_1_1_COL, PVL1_2_1_COL, PVL2_1_1_COL, ...	Used to indicate the column from where the parameter value corresponding to the transaction (in the transaction details) must be picked.
	<p>Note: Here, X represents the account, Y represents the price item, and Z represents the parameter.</p>		
Processing Date Type	PRCS_DTX_Y_TYP	PRCS_DT1_1_TYP, PRCS_DT1_2_TYP, PRCS_DT2_1_TYP, ...	<p>Used to indicate the date type using which you want to determine the effective price item parameters, pricing, and exchange rate. The valid values are:</p> <ul style="list-style-type: none"> • TXN_DT - Used when you want to determine price item parameters, pricing, and exchange rate which are effective on the transaction date. • Batch_DT - Used when you want to determine price item parameters, pricing, and exchange rate which are effective on the batch business date.
	<p>Note: Here, X represents the account and Y represents the price item.</p>		

Output Parameter	Naming Convention	Example	Description
			<p>Note: Based on the Processing Date for Transaction Feed Management characteristic defined for the division to which a transaction belongs, the system determines the rules, price item parameters, pricing, and exchange rate which are effective on the transaction or batch business date. The price item parameters, pricing, and exchange rate which are effective is determined for all account and price item combinations to which the transaction is mapped. If you want to use a custom processing date for a particular account and price item combination to which the transaction is mapped, you need to set the PRCS_DTX_Y_TYP output parameter. In other words, the PRCS_DTX_Y_TYP output parameter helps you to override the processing date for a particular account and price item combination. However, the overridden processing date is used only while determining effective price item parameters, pricing, and exchange rate.</p>
Processing Date	PRCS_DTX_Y_VAL Note: Here, X represents the account and Y represents the price item.	PRCS_DT1_1_VAL, PRCS_DT1_2_VAL, PRCS_DT2_1_VAL, ...	Used to specify a custom date on which you want to determine the effective price item parameters, pricing, and exchange rate.

Output Parameter	Naming Convention	Example	Description
			<p>Note:</p> <p>The custom date must be a date other than the transaction or batch business date.</p> <p>Based on the Processing Date for Transaction Feed Management characteristic defined for the division to which a transaction belongs, the system determines the rules, price item parameters, pricing, and exchange rate which are effective on the transaction or batch business date. The price item parameters, pricing, and exchange rate which are effective is determined for all account and price item combinations to which the transaction is mapped. If you want to use a custom processing date for a particular account and price item combination to which the transaction is mapped, you need to set the PRCS_DTX_Y_VAL output parameter. In other words, the PRCS_DTX_Y_VAL output parameter helps you to override the processing date for a particular account and price item combination. However, the overridden processing date is used only while determining effective price item parameters, pricing, and exchange rate.</p>
Ignore Transaction	IGNORE_SW		<p>Used to ignore transactions based on the transaction attributes. The valid values are:</p> <ul style="list-style-type: none"> • Y • N

Once the transaction satisfies any rule (invoked through the rule type), one transaction leg is created for each account, division, price item, and variance parameter or price item parameters combination. Let us understand this with the help of an example. The following table lists the accounts and price items to which T1, T2, and T3 are mapped:

Transaction	Charges Borne By	Division to which the account belongs...	Price Item	Variance Parameter	Price Item Parameters
T1	A1	D1	P1	-	Country - US, Currency - USD
T1	A1	D1	P2	-	Country - Germany, Currency - USD

Transaction	Charges Borne By	Division to which the account belongs...	Price Item	Variance Parameter	Price Item Parameters
T1	A2	D2	P3	USD	-
T2	A1	D1	P1	-	Country - US, Currency - USD
T2	A2	D2	P2	USD	-
T3	A1	D1	P3	-	Country - Germany, Currency - USD

In such case, the system will create three legs for T1, two legs for T2, and one leg for T3. Each transaction leg will have its own status. The status of the transaction legs and transaction is changed to **Initial Price Item Determined (INPD)**. However, if a transaction does not satisfy any rule, the status of the transaction is changed to **Error (EROR)**.

Note:

During this sub-process, the system validates the following:

- Whether the price item parameters specified in the output parameters are effective for the price item on the processing date.
- Whether the mandatory price item parameter which is effective on the processing date is specified in the output parameter.
- Whether the parameter value is specified for all mandatory price item parameters which are effective on the processing date.

If any of the above validation fails, the status of the transaction is changed to **Error (EROR)** and no transaction legs are created.

- **Parameter Group Creation** - Once the transaction legs are created, the price item parameters of each transaction leg are grouped. For example, when a transaction is mapped to the following price item and price item parameters combinations, the system creates three groups - Group A, Group B, and Group C:
 - Account A, Price Item X, Country - US, Currency - USD
 - Account A, Price Item Y, Country - Germany, Currency - USD
 - Account B, Price Item X, Country - England, Currency - USD

Group A contains Country - US, Currency - USD; Group B contains Country - Germany, Currency - USD; and Group C contains Country - England, Currency - USD.

A set of price item parameters are grouped when the multi parameter based pricing feature is enabled. A group is used to determine the price item pricing. A unique group ID is generated for each group. If a group with a set of price item parameters already exists in the system, a new group is not created. Instead, the existing group is used for determining the price item pricing.

You can execute this process through a multi-threaded batch named **Validate Transaction and Derive Price Item (C1-TXNIP)**. You can specify the following parameters while executing this batch:

Parameter Name	Description	Mandatory (Yes or No)
Batch Business Date	Used to identify the transactions for which you want to perform validation and determine price item. The system considers the transactions whose transaction date is earlier than or equal to the batch business date.	No

Parameter Name	Description	Mandatory (Yes or No)
	<p>Note:</p> <p>If you do not specify any date, the batch business date is set to the current date.</p> <p>The batch business date used while executing the C1-TXNIP batch is stamped in the database. It is then used while executing all other consequent batches in the transaction aggregation cycle.</p>	
Transaction Header ID	Used when you want to validate and derive price item for the transactions which are received in a particular transaction feed.	No
Transaction Source	Used when you want to validate and derive price item for the transactions which are received from a particular transaction source.	No
Division	Used when you want to validate and derive price item for the transactions belonging to a particular division.	No
Shuffle Work Unit	<p>Used to indicate whether you want to shuffle the work units across threads to correct the uneven thread processing time. The valid values are:</p> <ul style="list-style-type: none"> • Y • N <p>Note: By default, the parameter value is set to N.</p>	No
Chunk Size	Used to specify the number of transactions you want to execute in each work unit.	Yes
Maximum Batch Count	Used to specify the maximum number of transactions after which the data must be transferred to the database.	Yes
Thread Pool Name	Used to specify the thread pool on which you want to execute the batch.	No

A log is generated if the **Logging Rules for Transaction Feed** option type in the **Rule Engine (C1_RLENG)** feature configuration is set to **True**. This log indicates the rules that were executed for each transaction and whether each rule passed or failed during the execution.

Note:

You can aggregate transaction legs in a billable charge using aggregation parameters other than account ID, price item code, variance or price item parameters, aggregation start date, and aggregation end date. The additional aggregation parameters can be stamped in the form of aggregation parameter group ID while performing post-processing activities for each transaction leg. This aggregation parameter group ID will be used in subsequent batches during the transaction aggregation cycle. If you want to perform some post-processing activities on the transaction legs, you need to attach a post-processing algorithm on the **TFM - Price Item Derivation Post-Processing** algorithm entity in the **Algorithms** tab of the **Division** screen. Note that the system invokes the algorithm which is attached on the division to which the transaction belongs. This algorithm is triggered only for transactions which are in the **Initial Price Item Determined (INPD)** status. It is triggered before the price item parameter group is created.

A sample post-processing algorithm type named **C1_PRDR_POPC** is shipped with the price item. It does not have any business logic. If you want to undertake some post-processing activities for a transaction leg, you need to create custom algorithm type and attach the respective algorithm on the **Feed Management Price Item Derivation Post-Processing** algorithm spot of the respective division. You can refer to the **C1_PRDR_POPC** algorithm type to understand the input parameters that must be passed to the custom algorithm type.

Once the **Validate Transaction and Derive Price Item (C1-TXNIP)** batch is executed, the processing date is stamped against each transaction leg in the database. If a custom processing date is specified for a particular account and price item combination, the custom processing date is stamped against the respective transaction leg. Otherwise, the processing date defined for the division to which a transaction belongs is stamped against the legs of the respective transaction. The processing date which is stamped against a transaction leg in the database is used while executing all subsequent batches in the transaction aggregation cycle.

Related Topics

For more information on...	See...
Rules Engine	Rules Engine on page 887
How to define a rule	Defining a Rule on page 909

Price Item Pricing Verification

In this process, the system behaves in the following manner:

If the Multi Parameter Based Pricing feature is...	Then...
Disabled	<p>The system checks whether effective pricing is available for the account, price item or regular bundle (to which the price item belongs) or parent (regular) bundle (to which the regular bundle belongs) and/or TOU combination on the processing date. The system searches for the price item, regular bundle or parent bundle pricing depending on the value defined for the Prefer Price Item Over Bundle parameter in the price assignment search algorithm (which is defined for the division to which the account belongs).</p> <p>If the price item belongs to a regular bundle and the effective pricing is available for the regular bundle at the account level, the system considers the regular bundle as the final price item and maps it to the transaction leg. If the effective pricing is not available for the regular bundle, the system checks whether the effective pricing is available for the parent bundle (if assigned) at the account level. If the effective pricing is available for the parent bundle, the system considers the parent bundle as the final price item and maps it to the transaction leg. If the effective pricing is not available for the price item, regular bundle, or parent bundle, the status of the transaction leg is changed to Error (EROR). If the effective pricing</p>

If the Multi Parameter Based Pricing feature is...	Then...
	is not available for one or more price items to which a transaction is mapped, the status of the transaction is also changed to Error (EROR) .
Enabled	<p>The system checks whether effective pricing is available for the account, price item or regular bundle (to which the price item belongs) or parent (regular) bundle (to which the regular bundle belongs)and/or price item parameters (parameter group) combination on the processing date. The system searches for the price item, regular bundle or parent bundle pricing depending on the value defined for the Prefer Price Item Over Bundle parameter in the price assignment search algorithm (which is defined for the division to which the account belongs).</p> <p>The system searches for a price with exact match at all levels defined in the search order. If the exact match is available at two or more levels, the price assignment at the higher precedence level is considered for calculating the charges. But, if the system does not find the exact match at any level, it searches for the best fit match at all levels. For more information about best fit match, see Multi Parameter Based Pricing on page 271. If the system finds the best fit match with same weight at multiple levels, the price assignment at the higher precedence level is considered for calculating the charges.</p> <p>If the price item belongs to a regular bundle and the exact or best fit price is available for the regular bundle at the account level, the system considers the regular bundle as the final price item and maps it to the transaction leg. If the exact or best fit price is not available for the regular bundle, the system checks whether the exact or best fit price is available for the parent bundle (if assigned) at the account level. If the exact or best fit price is available for the parent bundle, the system considers the parent bundle as the final price item and maps it to the transaction leg. If the exact or best fit price is not available for the price item, regular bundle, or parent bundle, the status of the transaction leg is changed to Error (EROR). If the exact or best fit price is not available for one or more price items to which a transaction is mapped, the status of the transaction is also changed to Error (EROR).</p>

Note:

The processing date which is stamped against a transaction leg is used to determine effective pricing for the transaction leg.

The order in which the system searches effective pricing for the price item, regular bundle, or parent (regular) bundle at the same level depends on the value defined for the **Prefer Price Item Over Bundle** parameter in the price assignment search algorithm. If the value of the **Prefer Price Item Over Bundle** parameter is set to **Y**, the system first searches whether effective pricing is available for the price item. If the effective pricing is not available for the price item, then the system searches whether effective pricing is available for the regular bundle at the same level. If the effective pricing is not available for the regular bundle, then the system searches whether effective pricing is available for the parent bundle at the same level. However, if the value of the **Prefer Price Item Over Bundle** parameter is set to **N**, the system first searches whether effective pricing is available for the parent bundle. If the effective pricing is not available for the parent bundle, then the system searches whether effective pricing is available for the regular bundle at the same level. If the effective pricing is not available for the regular bundle, then the system searches whether effective pricing is available for the price item at the same level.

In addition, the status of the transaction and transaction leg is changed to **Error (EROR)** when:

- There is no contract available with the specified contract type on the transaction date or when the contract is inactive.

- There are multiple effective contracts of the same contract type (available on the transaction date) in **Active**, **Pending Stop**, or **Stop** status.
- The **Price Assignment Search** algorithm is not defined for the division.
- The parameter values are either not defined or invalid in the **Price Assignment Search** algorithm on the processing date.
- The period in which the transaction date falls is not defined in the aggregation schedule.

Once the effective pricing is determined for the initial or final price item, the values of the following pricing attributes are retrieved:

- Ignore Transaction
- Aggregate Transaction
- Aggregation Schedule
- Rating Criteria
- Price Assignment ID
- Account ID (in case of account agreed and price list pricing)
- Person ID (in case of customer agreed and price list pricing)
- Price List ID (in case of price list pricing)
- Contract ID
- Regular Bundle Code
- Pricing Currency

You can execute this process through a multi-threaded batch named **Price Item Pricing Verification (C1-TXNVP)**. You can specify either of the following parameters while executing this batch:

Parameter Name	Description	Mandatory (Yes or No)
Transaction Header ID	Used when you want to find the price item pricing for transactions which are received in a particular transaction feed.	No
Transaction Source	Used when you want to find the price item pricing for transactions which are received from a particular transaction source.	No
Division	Used when you want to find the price item pricing for transactions belonging to a particular division.	No
Chunk Size	Used to specify the number of transactions you want to execute in each work unit.	Yes
Thread Pool Name	Used to specify the thread pool on which you want to execute the batch.	No

Note that the **Price Item Pricing Verification (C1-TXNVP)** batch does not change the status of the transaction and its legs. You need to execute the **Update Status (C1-TXNEX)** batch to update the status of the transaction and its legs. Besides updating the status, the **Update Status (C1-TXNEX)** batch determines the rate for transaction legs whose effective pricing has either of the following set of attributes:

- **Ignore Transaction** is set to **Yes** and **Rating Criteria** is set to **Rate Transactions (RITX)**
- **Ignore Transaction** is set to **No**, **Aggregate Transaction** is set to **Yes**, and **Rating Criteria** is set to **Rate individual transactions and aggregate calc lines across transactions (RITA)**

Each set of pricing attributes indicates how the transaction legs must be rated before billing. For more information about the different ways in which a transaction leg can be rated, see [Transaction Rating Before Billing](#) on page 984.

You can specify either of the following parameters while executing this batch:

Parameter Name	Description	Mandatory (Yes or No)
Transaction Header ID	Used when you want to change the status of transactions which are received in a particular transaction feed.	No
Transaction Source	Used when you want to change the status of transactions which are received from a particular transaction source.	No
Division	Used when you want to change the status of transactions belonging to a particular division.	No
Shuffle Work Unit	Used to indicate whether you want to shuffle the work units across threads to correct the uneven thread processing time. The valid values are: <ul style="list-style-type: none"> • Y • N 	No
	Note: By default, the parameter value is set to N.	
Chunk Size	Used to specify the number of transactions you want to execute in each work unit.	Yes
Maximum Batch Count	Used to specify the maximum number of transactions after which the data must be transferred to the database.	Yes
Thread Pool Name	Used to specify the thread pool on which you want to execute the batch.	No

Note:

You must specify same parameters in the **Product Pricing Verification (C1-TXNVP)** and **Update Status (C1-TXNEX)** batches. Otherwise, erroneous results might occur.

If you want to do some preprocessing activities before invoking the rates engine, you need to attach a preprocessing algorithm on the **TFM - Rate Pre-Processing** algorithm entity in the **Algorithms** tab of the **Division** screen. Note that the system invokes the algorithm which is attached on the derived account's division and not on the division to which the transaction belongs. A sample preprocessing algorithm type named **C1_RTCL_PRPC** is shipped with the product. It does not have any business logic. If you want to undertake some preprocessing activities before invoking the rates engine, you need to create custom algorithm type and attach the respective algorithm on the **TFM - Rate Pre-Processing** algorithm spot of the respective division. You can refer to the **C1_RTCL_PRPC** algorithm type to understand the input parameters that must be passed to the custom algorithm type.

If a transaction leg is ignored and not considered for billing, the status of the transaction leg is changed to **Ignored (IGNR)**, whereas the status of the transaction remains as **Initial Price Item Determined (INPD)**. However, if all legs of a transaction are ignored and not considered for billing, the status of the transaction and transaction legs is changed to **Ignored (IGNR)**.

You can store the price item pricing information, and thereby improve the **Price Item Pricing Verification (C1-TXNVP)** batch performance. If you set the **Use Materialized Views** option type of the **C1_FM** feature configuration to **true**, the system will store the product pricing information in the following tables:

- CI_PRC_AGRD
- CI_PRC_PL

- CI_PRC_INH_PL

But, if you set the **Use Materialized Views** option type of the **C1_FM** feature configuration to **false**, the system will not store the product pricing information in the above mentioned tables. If there are any pricing changes, you will have to update these tables before executing the **Price Item Pricing Verification (C1-TXNVP)** batch. You can update the product pricing information in these tables by executing the **Refresh Pricing (C1-TXNRP)** batch. Ideally, you must execute the **Refresh Pricing (C1-TXNRP)** batch after you execute the **Flush All Caches (F1-FLUSH)** batch in the transaction aggregation cycle. You can specify the following parameters while executing the **Refresh Pricing (C1-TXNRP)** batch:

Parameter Name	Description	Mandatory (Yes or No)
Division	Used when you want to update the price item pricing information of accounts belonging to a particular division.	No
Chunk Size	Used to specify the number of persons whose regular and post-processing price item pricing information you want to update in each work unit.	Yes
Thread Pool Name	Used to specify the thread pool on which you want to execute the batch.	No

Related Topics

For more information on...	See...
Transaction Leg Status Transition	Transaction Leg Status Transition on page 1034
How to set the C1_FM feature configuration	Setting the C1_FM Feature Configuration on page 4324

Aggregation

Once the price item pricing verification is complete, you can aggregate the transaction legs, create a billable charge, and update the SQI values in the billable charge. In the aggregation process, the system behaves in the following manner:

If the Multi Parameter Based Pricing feature is...	Then...
Disabled	The system checks the value defined in the Aggregate Transaction field. If the Aggregate Transaction field is set to No , the system creates one billable charge (with the Billable status) for each transaction leg. However, if the Aggregate Transaction field is set to Yes , the system creates one billable charge (with the Billable status) for all transactions legs having the same price item and TOU combination and whose transaction date falls between the aggregation schedule.

If the Multi Parameter Based Pricing feature is...	Then...
	<p>Note:</p> <p>During the billable charge creation, the system also considers the contract start and end dates along with the aggregation schedule. If the contract start date falls between the aggregation schedule, the billable charge start date is equal to the contract start date. If the contract start date is earlier than the aggregation schedule start date, the billable charge start date is equal to the aggregation schedule start date. If the contract end date is earlier than the aggregation schedule end date, the billable charge end date is equal to the contract end date. If the contract end date is later than the aggregation schedule end date, the billable charge end date is equal to the aggregation schedule end date. However, if the contract start date is later than the aggregation schedule end date or if the contract end date is earlier than the aggregation schedule start date, the status of the transaction leg is changed to Error (EROR).</p> <p>If the aggregated billable charge already exists for the account, price item and TOU combination and there is no bill segment associated with the billable charge, the system will update the SQI values in the existing billable charge.</p>
Enabled	<p>The system checks the value defined in the Aggregate Transaction field. If the Aggregate Transaction field is set to No, the system creates one billable charge (with the Billable status) for each transaction leg. However, if the Aggregate Transaction field is set to Yes, the system creates one billable charge (with the Billable status) for all transaction legs having the same price item and price item parameters (parameter group) combination and whose transaction date falls between the aggregation schedule.</p> <p>Note:</p> <p>During the billable charge creation, the system also considers the contract start and end dates along with the aggregation schedule. If the contract start date falls between the aggregation schedule, the billable charge start date is equal to the contract start date. If the contract start date is earlier than the aggregation schedule start date, the billable charge start date is equal to the aggregation schedule start date. If the contract end date is earlier than the aggregation schedule end date, the billable charge end date is equal to the contract end date. If the contract end date is later than the aggregation schedule end date, the billable charge end date is equal to the aggregation schedule end date. However, if the contract start date is later than the aggregation schedule end date or if the contract end date is earlier than the aggregation schedule start date, the status of the transaction leg is changed to Error (EROR).</p> <p>If the aggregated billable charge already exists for the account, price item and price item parameters combination and there is no bill segment associated with the billable charge, the system will update the SQI values in the existing billable charge.</p>

The transaction aggregation is done based on the aggregation schedule defined in the price item pricing. You can use the following standard schedules or you can create your own custom schedules for aggregation:

- Daily
- Weekly
- Monthly

- Quarterly
- Yearly

Once the billable charge is created, the system aggregates the SQIs defined for the price item — division combination using the aggregation function and then updates the billable charge with the respective SQI values. If the aggregation function is based on the transaction amount or on any other user defined amount and the transaction or user defined currency is different from the pricing currency, the system does currency conversion if the appropriate exchange rate is available in the system. The processing date which is stamped against a transaction leg is used to determine effective exchange rate for the transaction leg.

Once the SQI values are updated in the billable charge, the rate is determined for the transaction leg whose effective pricing has either of the following set of attributes:

- **Ignore Transaction** is set to **No**, **Aggregate Transaction** is set to **Yes**, and **Rating Criteria** is set to **Aggregate transactions and then rate aggregated SQs (AGTR)**
- **Ignore Transaction** is set to **No**, **Aggregate Transaction** is set to **No**, and **Rating Criteria** is set to **Rate Transactions (RITX)**

Each set of pricing attributes indicates how the transaction legs must be rated before billing. For more information about the different ways in which a transaction leg can be rated, see [Transaction Rating Before Billing](#) on page 984.

Note: If you want to do some preprocessing activities while determining rate, you need to attach a preprocessing algorithm on the **TFM - Rate Pre-Processing** algorithm entity in the **Algorithms** tab of the **Division** screen. Note that the system invokes the algorithm which is attached on the derived account's division and not on the division to which the transaction belongs. A sample preprocessing algorithm type named **C1_RTCL_PRPC** is shipped with the price item. It does not have any business logic. If you want to undertake some preprocessing activities while determining rate for transaction legs, you need to create custom algorithm type and attach the respective algorithm on the **TFM - Rate Pre-Processing** algorithm spot of the respective division. You can refer to the **C1_RTCL_PRPC** algorithm type to understand the input parameters that must be passed to the custom algorithm type.

Once the billable charge is created and updated successfully, the status of the transaction leg is changed to **Completed (COMP)**. However, if the SQIs are not defined for the price item — division combination, the transaction aggregation rule is not defined for the SQI, or if the exchange rate is not available during currency conversion, the status of the transaction leg is changed to **Error (EROR)**. If all legs of a transaction are in the **Completed (COMP)** status, the status of the transaction is changed to **Completed (COMP)**. But, if any of the transaction leg is in the **Error (EROR)** status, the status of the transaction is changed to **Error (EROR)**.

You can execute this process through a multi-threaded batch named **Service Quantity Calculation (C1-TXNSQ)**. You can specify either of the following parameters while executing this batch:

Parameter Name	Description	Mandatory (Yes or No)
Transaction Header ID	Used when you want to create the billable charges for transactions which are received in a particular transaction feed.	No
Transaction Source	Used when you want to create the billable charges for transactions which are received from a particular transaction source.	No
Division	Used when you want to create the billable charges for transactions belonging to a particular division.	No
Chunk Size	Used to specify the number of transactions you want to execute in each work unit.	Yes
Maximum Batch Count	Used to specify the maximum number of transactions after which the data must be transferred to the database.	Yes

Parameter Name	Description	Mandatory (Yes or No)
Thread Pool Name	Used to specify the thread pool on which you want to execute the batch.	No

The **Service Quantity Calculation (C1-TXNSQ)** batch does not change the status of the transaction and its legs. You need to execute the **Mark Completion (C1-TXNCM)** batch to update the status of the transaction and its legs. Besides updating the status, the **Mark Completion (C1-TXNCM)** batch does the following with other legs when billable charge is not created for one or more transaction legs:

Rate for other transaction leg is determined using the following set of pricing attributes...	Then....
Ignore Transaction is set to Yes and Rating Criteria is set to Rate Transactions (RITX)	The corresponding calculation lines of the transaction leg are deleted.
Ignore Transaction is set to No , Aggregate Transaction is set to No , and Rating Criteria is set to Rate Transactions (RITX)	The corresponding billable charge and calculation lines of the transaction leg are deleted.
Ignore Transaction is set to No , Aggregate Transaction is set to Yes , and Rating Criteria is set to Rate individual transactions and aggregate calc lines across transactions (RITA)	The corresponding calculation lines of the transaction leg are deleted.
Ignore Transaction is set to No , Aggregate Transaction is set to Yes , and Rating Criteria is set to Aggregate transactions and then rate aggregated SQs (AGTR)	The corresponding billable charge and calculation lines are not deleted.
Ignore Transaction is set to No , Aggregate Transaction is set to No , and Rating Criteria is set to Do Not Rate Transactions	The corresponding non-aggregated billable charge is deleted.

You can specify either of the following parameters while executing the **Mark Completion (C1-TXNCM)** batch:

Parameter Name	Description	Mandatory (Yes or No)
Transaction Header ID	Used when you want to change the status of transactions which are received in a particular transaction feed.	No
Transaction Source	Used when you want to change the status of transactions which are received from a particular transaction source.	No
Division	Used when you want to change the status of transactions belonging to a particular division.	No
Chunk Size	Used to specify the number of transactions you want to execute in each work unit.	Yes
Maximum Batch Count	Used to specify the maximum number of transactions after which the data must be transferred to the database.	Yes
Thread Pool Name	Used to specify the thread pool on which you want to execute the batch.	No

Note:

You must specify same parameters in the **Service Quantity Calculation (C1-TXNSQ)** and **Mark Completion (C1-TXNCM)** batches. Otherwise, erroneous results might occur.

If you want to perform some post-processing activities on a billable charge, you need to attach a post-processing algorithm on the **TFM - Billable Charge Post-Processing** algorithm entity in the **Algorithms** tab of the **Division** screen. This algorithm is triggered once the billable charge is created and SQIs are updated in the billable charge. Note that the system invokes the algorithm which is attached on the derived account's division and not on the division to which the transaction belongs. A sample post-processing algorithm type named **C1_BCHG_POPC** is shipped with the product. It does not have any business logic. If you want to undertake some post-processing activities on a billable charge, you need to create custom algorithm type and attach the respective algorithm on the **Feed Management Billable Charge Post-Processing** algorithm spot of the respective division. You can refer to the **C1_BCHG_POPC** algorithm type to understand the input parameters that must be passed to the custom algorithm type.

Related Topics

For more information on...	See...
Transaction Leg Status Transition	Transaction Leg Status Transition on page 1034

Clean Up

There might be situations when a transaction is mapped to one or more price items and due to some reasons a billable charge could not be created for one of the price item. And, therefore the status of the transaction is changed to **Error (EROR)**. In such case, you need to either recalculate SQIs in the aggregated billable charge or delete the aggregated billable charge depending on whether the aggregated billable charge includes transaction legs in the **Completed (COMP)** status. You can perform this clean up process through a multi-threaded batch named **Clean Up (C1-TXNCU)**.

When the transaction legs in the **Error (EROR)** and **Completed (COMP)** statuses are aggregated together in a billable charge, the **Clean Up (C1-TXNCU)** batch does the following:

Billable charge contain transaction legs with the following set of pricing attributes...	Then....
Ignore Transaction is set to No , Aggregate Transaction is set to Yes , and Rating Criteria is set to Do Not Rate Transactions	The SQIs are recalculated in the billable charge.
Ignore Transaction is set to No , Aggregate Transaction is set to Yes , and Rating Criteria is set to Aggregate transactions and then rate aggregated SQs (AGTR)	The SQIs are recalculated in the billable charge and the rate is determined for aggregated service quantities. Once the rate is determined, pass through charges are calculated and accumulated accordingly.
Ignore Transaction is set to No , Aggregate Transaction is set to Yes , and Rating Criteria is set to Rate individual transactions and aggregate calc lines across transactions (RITA)	The pass through charges are recalculated and accumulated accordingly.

However, when the transaction legs in the **Error (EROR)** status are only aggregated in a billable charge, the **Clean Up (C1-TXNCU)** batch does the following:

Billable charge contain transaction legs with the following set of pricing attributes...	Then....
Ignore Transaction is set to No , Aggregate Transaction is set to Yes , and Rating Criteria is set to Do Not Rate Transactions	The aggregated billable charge is deleted.

Billable charge contain transaction legs with the following set of pricing attributes...	Then....
Ignore Transaction is set to No , Aggregate Transaction is set to Yes , and Rating Criteria is set to Aggregate transactions and then rate aggregated SQs (AGTR)	The aggregated billable charge and the corresponding calculation lines are deleted.
Ignore Transaction is set to No , Aggregate Transaction is set to Yes , and Rating Criteria is set to Rate individual transactions and aggregate calc lines across transactions (RITA)	The aggregated billable charge is deleted.

Note:

If the aggregation function is based on the transaction amount or on any other user defined amount and the transaction or user defined currency is different from the pricing currency, the system does currency conversion if the appropriate exchange rate is available in the system. The processing date which is stamped against a transaction leg is used to determine effective exchange rate for the transaction leg.

The SQIs in an aggregated billable charge are recalculated only when the **SQ Recalculation Required** option type in the **C1_FM** feature configuration is set to **Y**. If you set the **SQ Recalculation Required** option type in the **C1_FM** feature configuration to **N**, the SQIs are not recalculated in an aggregated billable charge. We recommend you to recalculate SQIs in an aggregated billable charge when more than one account bears the charges for a transaction.

If you want to perform some post-processing activities on a billable charge, you need to attach a post-processing algorithm on the **TFM - Billable Charge Post-Processing** algorithm entity in the **Algorithms** tab of the **Division** screen. This algorithm is triggered once the billable charge is created and SQIs are updated in the billable charge. Note that the system invokes the algorithm which is attached on the derived account's division and not on the division to which the transaction belongs. A sample post-processing algorithm type named **C1_BCHG_POPC** is shipped with the product. It does not have any business logic. If you want to undertake some post-processing activities on a billable charge, you need to create custom algorithm type and attach the respective algorithm on the **TFM - Billable Charge Post-Processing** algorithm spot of the respective division. You can refer to the **C1_BCHG_POPC** algorithm type to understand the input parameters that must be passed to the custom algorithm type.

Besides the transaction aggregation process, the **Clean Up (C1-TXNCU)** batch is also used during the following sub-processes:

- **Cancellation** — During the cancellation process, it deletes non-aggregated billable charges and recalculates SQIs in aggregated billable charges.
- **Disaggregation** — During the disaggregation process, it deletes an aggregated billable charge when all the corresponding transaction legs which were aggregated in the billable charge are deleted during disaggregation.

You can specify either of the following parameters while executing the **Clean Up (C1-TXNCU)** batch:

Parameter Name	Description	Mandatory (Yes or No)
Transaction Header ID	Used when you want to update or delete billable charges created for transactions which are received in a particular transaction feed.	Yes (Conditional)
	Note: This parameter should not be used during the disaggregation process.	Note: This parameter is required when you set the request type to CNCL .
Transaction Source	Used when you want to update or delete billable charges created for transactions which are received from a particular transaction source.	No

Parameter Name	Description	Mandatory (Yes or No)
	Note: This parameter should not be used during the cancellation and disaggregation processes.	
Division	Used when you want to update or delete billable charges created for transactions belonging to a particular division. Note: This parameter should not be used during the cancellation process.	No
Account ID	Used when you want to update or delete billable charges created for transactions of a particular account. Note: This parameter should be used only during the disaggregation process.	No
Bill Cycle	Used when you want to update or delete billable charges created for transactions of accounts having a particular bill cycle. Note: This parameter should be used only during the disaggregation process.	No
Disaggregate Transactions From Date	Used when you want to update or delete billable charges created for transactions which were performed from a particular date onwards. Note: You must specify the date in the YYYY-MM-DD format. This parameter should be used only during the disaggregation process.	Yes (Conditional) Note: This parameter is required when you set the request type to DISAGG .
Request Type	Used to indicate the process during which you want to execute the batch. The valid values are: <ul style="list-style-type: none"> • CNCL • EROR • DISAGG 	Yes
Chunk Size	Used to specify the number of transactions you want to execute in each work unit.	Yes
Maximum Batch Count	Used to specify the maximum number of transactions after which the data must be transferred to the database.	Yes
Thread Pool Name	Used to specify the thread pool on which you want to execute the batch.	No

Related Topics

For more information on...	See...
Transaction Leg Status Transition	Transaction Leg Status Transition on page 1034
How to set the C1_FM feature configuration	Setting the C1_FM Feature Configuration on page 4324

Transaction Aggregation Batch Processing

During the transaction aggregation process, you need to execute the following batches in the specified order:

1. Flush All Caches (F1-FLUSH)
2. Refresh Pricing (C1-TXNRP)
3. Header Validation (C1-TXNHV)
4. Validate Transaction and Derive Price Item (C1-TXNIP)
5. Price Item Pricing Verification (C1-TXNVP)
6. Update Status (C1-TXNEX)
7. Service Quantity Calculation (C1-TXNSQ)
8. Mark Completion (C1-TXNCM)
9. Clean Up (C1-TXNCU) with the **Request Type** parameter set to **EROR**

The **Validate Transaction and Derive Price Item (C1-TXNIP)** batch locks the **CI_TXN_DTL_PRITM_SUMMARY** table before inserting records to ensure that only unique records are inserted in this table. The locking mechanism results in performance issue when there is no or very little aggregation of transactions. Therefore, we recommend you to use an alternative transaction aggregation process when the aggregation ratio is low. You can enable the alternative transaction aggregation process by setting the **Use C1-TXNPS During Transaction Aggregation** option type in the **C1_FM** feature configuration to **true**. In this alternative transaction aggregation process, you need to execute the following batches in the specified order:

1. Flush All Caches (F1-FLUSH)
2. Refresh Pricing (C1-TXNRP)
3. Header Validation (C1-TXNHV)
4. Validate Transaction and Derive Price Item (C1-TXNIP)
5. Populate CI_TXN_DTL_PRITM_SUMMARY Table (C1-TXNPS)
6. Price Item Pricing Verification (C1-TXNVP)
7. Update Status (C1-TXNEX)
8. Service Quantity Calculation (C1-TXNSQ)
9. Mark Completion (C1-TXNCM)
10. Clean Up (C1-TXNCU) with the **Request Type** parameter set to **EROR**

The following figure graphically explains the sequence in which you need to execute the batches during the transaction aggregation process:

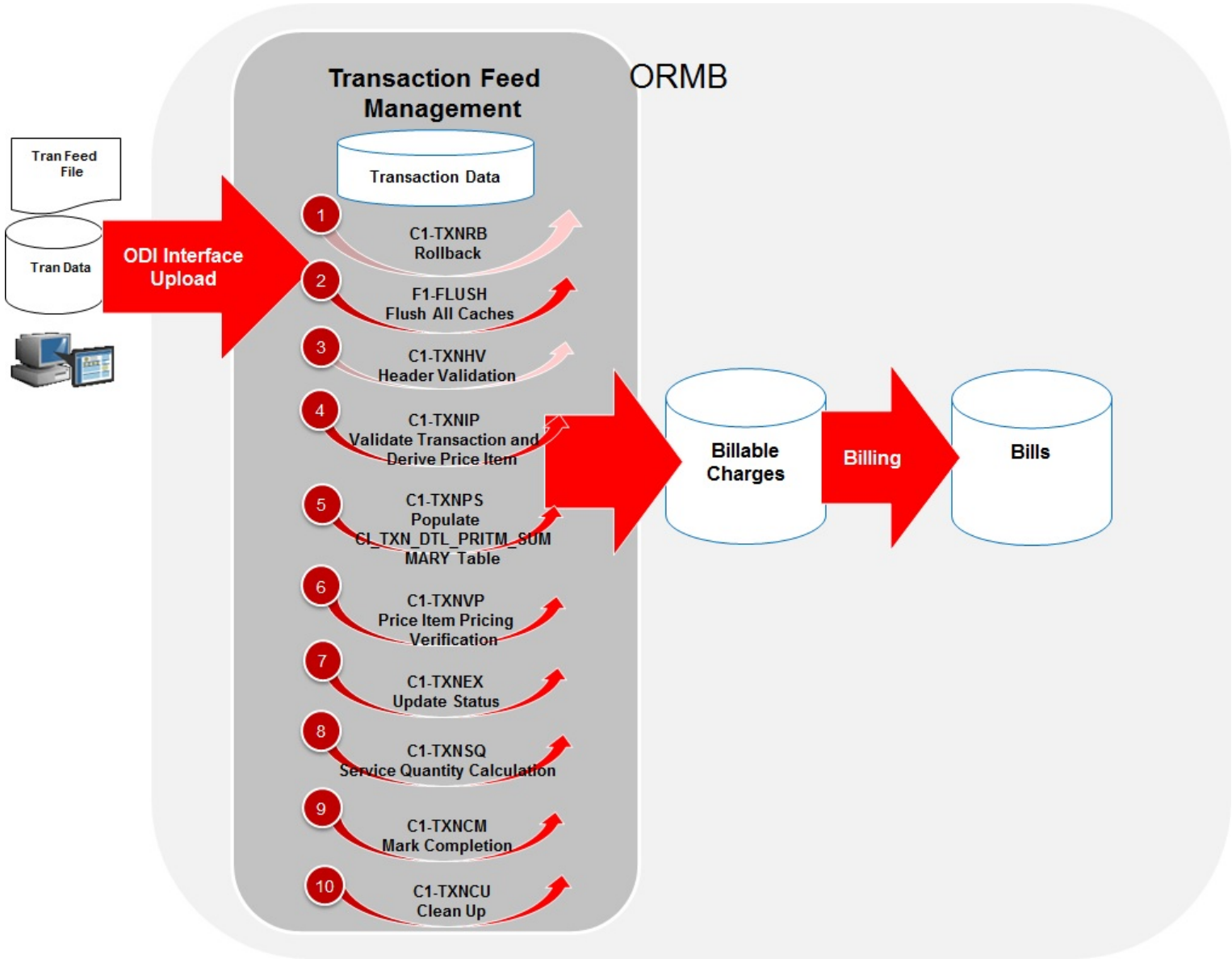

Note:

You need to remember the following points during the transaction aggregation process:

- Before you start the transaction aggregation process, you need to execute the **Flush All Caches (F1-FLUSH)** batch to clean the cache. This batch has one parameter named **Thread Pool** which allows you to clean cache of a particular thread pool. In case you want to reprocess the error transactions from the earlier cycle, you need to execute the **Rollback (C1-TXNRB)** batch.
- You can store the price item pricing information, and thereby improve the **Price Item Pricing Verification (C1-TXNVP)** batch performance. If you set the **Use Materialized Views** option type of the **C1_FM** feature configuration to **true**, the system will store the price item pricing information in the following tables:
 - CI_PRC_AGRD
 - CI_PRC_PL
 - CI_PRC_INH_PL

But, if you set the **Use Materialized Views** option type of the **C1_FM** feature configuration to **false**, the system will not store the price item pricing information in the above mentioned tables. If there are any pricing changes, you can update the price item pricing information in these tables by executing the **Refresh Pricing (C1-TXNRP)** batch.

- The **Header Validation (C1-TXNHV)** batch is optional. You can directly execute the **Validate Transaction and Derive Price Item (C1-TXNIP)** batch once the transactions are uploaded in the system.
- The system allows you to execute each batch consecutively. You can execute the **Validate Transaction and Derive Price Item (C1-TXNIP)** batch consecutively with the same division and same parameters, or with the different division and different parameters. But, you cannot execute the **Validate Transaction and Derive Price Item (C1-TXNIP)** batch consecutively with the same division and different parameters. For example, once you execute this batch with division as D1 and transaction source as S1, you cannot execute this batch again with division as D1 and transaction source as S2 until the former transaction aggregation cycle is complete.
- Once the **Price Item Pricing Verification (C1-TXNVP)** batch is executed, you cannot execute the **Validate Transaction and Derive Price Item (C1-TXNIP)** batch again with the same division and same parameters unless and until the transaction aggregation cycle is complete. Similarly, once the **Service Quantity Calculation (C1-TXNSQ)** batch is executed, you cannot execute the **Price Item Pricing Verification (C1-TXNVP)** batch again with the same division and same parameters unless and until the transaction aggregation cycle is complete. This rule is applicable to all subsequent batches in the transaction aggregation cycle.
- During the transaction aggregation process, you must specify the same division and same parameters across each batch. Otherwise, erroneous results might occur.
- If you have already executed the **Validate Transaction and Derive Price Item (C1-TXNIP)** batch without any division, then you cannot execute this batch once again with a division unless and until the transaction aggregation cycle is complete.

Transaction Disaggregation

As the aggregation cycle is different from the billing cycle, there might be situations when due to pricing changes, the billable charges are no longer valid. In such cases, you need to disaggregate the transactions. In the following scenarios, the system automatically creates a disaggregation request in the CI_TXN_DISAGG_REQ table:

If...	Then
A price item is assigned to an account	A disaggregation request is created for the account.
The following values in the price item pricing assigned to an account is changed:	A disaggregation request is created for the account.

If...	Then
<ul style="list-style-type: none"> • Effective Start Date • Effective End Date • Aggregation Schedule • Ignore Transaction • Aggregate Transaction • Rating Criteria • Price Item Parameter 	
A price item is assigned to a person	A disaggregation request is created for each account of the person and its child person.
<p>The following values in the price item pricing assigned to a person is changed:</p> <ul style="list-style-type: none"> • Effective Start Date • Effective End Date • Aggregation Schedule • Ignore Transaction • Aggregate Transaction • Rating Criteria • Price Item Parameter 	A disaggregation request is created for each account of the person and its child person.
A price list is assigned to an account.	A disaggregation request is created for the account.
<p>The following values in the price list assigned to an account is changed:</p> <ul style="list-style-type: none"> • Effective Start Date • Effective End Date • Priority • Price List Inheritance 	A disaggregation request is created for the account.
A price list is assigned to a person.	A disaggregation request is created for each account of the person and its child person.
<p>The following values in the price list assigned to a person is changed:</p> <ul style="list-style-type: none"> • Effective Start Date • Effective End Date • Priority • Price List Inheritance 	A disaggregation request is created for each account of the person and its child person.

However, there are various other scenarios for which you have to disaggregate the transactions. But, at the moment, the system does not automatically create a disaggregation request for these scenarios in the CI_TXN_DISAGG_REQ table. You will have to create an appropriate disaggregation request in this table. The system allows you to create a disaggregation request manually through the **Disaggregation Request** screen or through a batch named **Disaggregation Request Creation (C1-DISTG)**.

In the following scenarios, you have to create an appropriate disaggregation request for the account or person, respectively:

- Effective price item pricing assigned to an account is overridden.
- Variance parameter in the price item pricing assigned to an account is changed.
- A price list assignment has expired or a price list is no longer available to an account.
- Effective price item pricing assigned to a person is overridden.
- Variance parameter in the price item pricing assigned to a person is changed.
- A price list assignment has expired or a price list is no longer available to a person.
- A price item is added to a price list.
- The following details in the price item pricing assigned to a price list is changed:
 - Variance Parameter
 - Effective Start Date
 - Effective End Date
 - Aggregation Schedule
 - Ignore Transaction
 - Rating Criteria
 - Aggregate Transaction
- A new bundle is created.
- A price item is added to a bundle.
- A price item is removed from a bundle.
- A bundle is eliminated (that is, all its price item are removed).
- A price item is added.
- A price list hierarchy is changed.
- SQIs associated with a price item - division combination are changed.
- Transaction aggregation rule defined for an SQI is changed or deleted.
- Business rules used for initial price item mapping are changed.

At present, the system disaggregates transactions at the account level and not at the price item level. Let us understand this with the help of an example. The following table lists the accounts and price items to which T1 is mapped:

Transaction	Account	Price Item
T1	A1	P1
T1	A1	P2
T1	A2	P1
T1	A2	P2

Now, if the pricing of P1 assigned to A1 changes, the system creates a disaggregation request for A1 and identifies all transaction legs which are mapped to A1 for disaggregation. In this example, the system will consider the first two transaction legs - T1-A1-P1 and T1-A1-P2 - for disaggregation even if the pricing of P2 assigned to A1 has not changed.

The **Disaggregation Request Creation (C1-DISTG)** batch creates a disaggregation request for an account. When you create a disaggregation request for an account, the transactions mapped to the account are disaggregated. This batch is

a multi-threaded batch. The multi-threading is based on account ID and chunks for multi-threading are created based on numerical distribution of account ID. You can specify either of the following parameters while executing this batch:

Parameter Name	Description	Mandatory (Yes or No)
Division	Used when you want to create disaggregation request for accounts belonging to a particular division.	No
Person ID	Used when you want to create disaggregation request for accounts belonging to a particular person.	No
Bill Cycle	Used when you want to create disaggregation request for accounts having a particular bill cycle.	No
Disaggregate Transactions From Date	Used when you want to create disaggregation request for accounts for which transactions were performed from a particular date onwards.	Yes
	Note: You must specify the date in the YYYY-MM-DD format.	
Thread Pool Name	Used to specify the thread pool on which you want to execute the batch.	No

Before you proceed with the disaggregation process, you need to ensure that there are no pending bills for the accounts whose transactions need to be disaggregated. If there are pending bills for these accounts, you need to first execute the **Pending Bill Segments Deletion (C1-BSEGD)** batch and then execute the **Pending Bill Deletion (C1-PNBD)** batch. While executing these batches in the specified order, ensure that you specify the same parameters in both these batches. For more information about these batches, see *Oracle Revenue Management and Billing Batch Execution Guide*.

Note: The **Pending Bill Deletion (C1-PNBD)** batch deletes those pending bills which are generated through the billing batches (i.e. **BILLING** or **C1-PNDBL**). It does not delete pending bills which are generated through the user interface. Also, it deletes regular pending bills and not adhoc pending bills.

Once a disaggregation request is either manually or automatically created for an account, you need to execute the following batches in the specified order to disaggregate transactions:

- **Identify Transactions for Disaggregation (C1-IDENT)** - This batch fetches disaggregation requests which are created for accounts from the CI_TXN_DISAGG_REQ table. It identifies the transactions and the corresponding aggregated and non-aggregated billable charges for disaggregation. If the bill segment of a billable charge is in the **Pending Cancel** or **Frozen** status, the system will not identify the billable charge for deletion. You can specify either of the following parameters while executing this batch:

Parameter Name	Description	Mandatory (Yes or No)
Division	Used when you want to identify the transactions of accounts belonging to a particular division for disaggregation.	No
Account ID	Used when you want to identify the transactions of a particular account for disaggregation.	No
Bill Cycle	Used when you want to identify the transactions of accounts having a particular bill cycle for disaggregation.	No
Disaggregate Transactions From Date	Used when you want to identify the transactions which were performed from a particular date onwards for disaggregation.	No

Parameter Name	Description	Mandatory (Yes or No)
	<p>Note:</p> <p>You must specify the date in the YYYY-MM-DD format.</p> <p>The aggregated billable charge, which is affected, should not contain a transaction leg whose transaction date is earlier than the date specified in this parameter. Otherwise, erroneous results will occur. Therefore, ensure that you specify the appropriate value for the Disaggregate Transactions From Date parameter.</p>	
Chunk Size	Used to specify the number of transactions you want to execute in each work unit.	Yes
Maximum Batch Count	Used to specify the maximum number of transactions after which the data must be transferred to the database.	Yes
Post-Processing Algorithm	Used to attach a post-processing algorithm. This algorithm is triggered once the transactions and corresponding billable charges are identified for disaggregation.	No
Exclude Canceled Billable Charges (Y or N)	<p>Used to indicate whether you want to exclude the aggregated and non-aggregated billable charges which are in the Canceled status during the disaggregation process. The valid values are:</p> <ul style="list-style-type: none"> • Y • N <p>Note: If you do not specify any value, by default, the parameter value is set to N.</p>	No
Thread Pool Name	Used to specify the thread pool on which you want to execute the batch.	No

- **Process Non-Aggregated Transactions (C1-PDTEXN)** - This batch processes the identified transactions, deletes the required transaction legs, and changes the status of the transaction to **Uploaded (UPLD)**. If a non-aggregated billable charge exists for a transaction leg and the corresponding bill segment is in the **Cancel** status, then:
 - The billable charge is cancelled.
 - The corresponding transaction leg and calculation lines (if any) are deleted.
 - The status of the transaction is changed to **Uploaded (UPLD)**.

However, if a non-aggregated billable charge exists for a transaction leg, but if the bill segment is not yet generated, then the billable charge, the corresponding calculation lines (if any), and transaction leg are deleted, and the status of the transaction is changed to **Uploaded (UPLD)**. If a non-aggregated billable charge is in the **Cancel** status, then the corresponding transaction leg and calculation lines (if any) are deleted and the status of the transaction is changed to **Uploaded (UPLD)**. If the rate is determined for a transaction leg which is in the **Ignored (IGNR)** status, the calculation lines are deleted along with the transaction leg during disaggregation.

If aggregated billable charge exists for a transaction leg, then the corresponding transaction legs and calculation lines (if any) are deleted and the status of the transaction is changed to **Uploaded (UPLD)**. You can specify either of the following parameters while executing this batch:

Parameter Name	Description	Mandatory (Yes or No)
Division	Used when you want to disaggregate the transactions of accounts belonging to a particular division.	No
Account ID	Used when you want to disaggregate the transactions of a particular account.	No
Bill Cycle	Used when you want to disaggregate the transactions of accounts having a particular bill cycle.	No
Disaggregate Transactions From Date	Used when you want to disaggregate the transactions which were performed from a particular date onwards. Note: You must specify the date in the YYYY-MM-DD format.	Yes
Chunk Size	Used to specify the number of transactions you want to execute in each work unit.	Yes
Maximum Batch Count	Used to specify the maximum number of transactions after which the data must be transferred to the database.	Yes
Thread Pool Name	Used to specify the thread pool on which you want to execute the batch.	No

Note:

If you want to undertake some preprocessing activities (such as cleaning data in any custom tables) during the disaggregation process, you need to attach a preprocessing algorithm on the **TFM - Disaggregation Pre-Processing** algorithm entity in the **Algorithms** tab of the **Division** screen. This algorithm is triggered when you execute the **Process Non-Aggregated Transactions (C1-PDTXN)** batch. Note that the system invokes the algorithm which is attached on the derived account's division and not on the division to which the transaction belongs.

A sample preprocessing algorithm type named **C1_DSAG_PRPC** is shipped with the product. It does not have any business logic. If you want to undertake some preprocessing activities during the disaggregation process, you need to create custom algorithm type and attach the respective algorithm on the **TFM - Disaggregation Pre-Processing** algorithm spot of the respective division. You can refer to the **C1_DSAG_PRPC** algorithm type to understand the input parameters that must be passed to the custom algorithm type.

- **Clean Up (C1-TXNCU)** - This batch deletes an aggregated billable charge when all the corresponding transaction legs which were aggregated in the billable charge are deleted during disaggregation. If an aggregated billable charge exists for a transaction leg and the corresponding bill segment is in the **Cancel** status, then:
 - The billable charge is cancelled.
 - The status of the transaction is changed to **Uploaded (UPLD)**.

However, if an aggregated billable charge exists for a transaction leg, but if the bill segment is not yet generated, then the billable charge, and the corresponding calculation lines (if any) are deleted, and the status of the transaction is changed to **Uploaded (UPLD)**. If an aggregated billable charge is in the **Cancel** status, then the corresponding calculation lines (if any) are deleted and the status of the transaction is changed to **Uploaded (UPLD)**.

While executing the **Clean Up (C1-TXNCU)** batch during disaggregation, you must set the **Request Type** parameter to **DISAGG**. For more information about the parameters that you can specify while executing this batch, refer to [Clean Up](#) on page 1013.

- **Update Disaggregation Request Status (C1-DRSUA)** - This batch changes the status of the disaggregation request in the `CI_TXN_DISAGG_REQ` table to **COMPLETE**. You can specify either of the following parameters while executing this batch:

Parameter Name	Description	Mandatory (Yes or No)
Account ID	Used when you want to update the disaggregation requests' status of a particular account.	No
Division	Used when you want to update the disaggregation requests' status of accounts belonging to a particular division.	No
Bill Cycle	Used when you want to update the disaggregation requests' status of accounts having a particular bill cycle.	No
Disaggregate Transactions From Date	Used when you want to update the disaggregation requests' status of accounts whose transactions were performed from a particular date onwards and the bill segments created for these transactions are in the Pending Cancel or Frozen status. Note: You must specify the date in the YYYY-MM-DD format.	Yes
Chunk Size	Used to specify the number of transactions you want to execute in each work unit.	Yes
Update Status Algorithm	Used to attach a custom algorithm which indicates when the status of the disaggregation request in the <code>CI_TXN_DISAGG_REQ</code> table must be changed to COMPLETE . Note: If an algorithm is specified in this parameter, the system uses the custom logic and not the in-built logic for updating the status of the disaggregation requests.	No
Exclude Canceled Billable Charges (Y or N)	Used to indicate whether you want to change the status of the disaggregation request to COMPLETE when the canceled billable charges are excluded during the disaggregation process. The valid values are: <ul style="list-style-type: none"> • Y • N Note: If you do not specify any value, by default, the parameter value is set to N. You must specify the same value for this parameter while executing the Identify Transactions for Disaggregation (C1-IDENT) and Update Disaggregation Request Status (C1-DRSUA) batches during the disaggregation process. Otherwise, erroneous results will occur.	No
Thread Pool Name	Used to specify the thread pool on which you want to execute the batch.	No

Related Topics

For more information on...	See...
Transaction Leg Status Transition	Transaction Leg Status Transition on page 1034
How to create a disaggregation request for a person	Creating a Disaggregation Request for a Person on page 1145
How to create a disaggregation request for an account	Creating a Disaggregation Request for an Account on page 1151
How to create a disaggregation request for a price item	Creating a Disaggregation Request for a Price item on page 1156
How to create a disaggregation request for a price assignment	Creating a Disaggregation Request for a Price Assignment on page 1162
How to create a disaggregation request for a billable charge	Creating a Disaggregation Request for a Billable Charge on page 1166
How to create a reseeding request for a parent accumulation group	Creating a Reseeding Request for a Parent Accumulation Group (Specific to Health Insurance Domain)

Transaction Disaggregation Batch Processing

During the transaction disaggregation process, you need to execute the following batches in the specified order:

1. Disaggregation Request Creation (C1-DISTG)
2. Pending Bill Segments Deletion (C1-BSEGD)
3. Pending Bill Deletion (C1-PNBD)
4. Identify Transactions for Disaggregation (C1-IDENT)
5. Process Non-Aggregated Transactions (C1-PDTXN)
6. Clean Up (C1-TXNCU) with the **Request Type** parameter set to **DISAGG**
7. Update Disaggregation Request Status (C1-DRSUA)

The following figure graphically explains the sequence in which you need to execute the batches during the transaction disaggregation process:

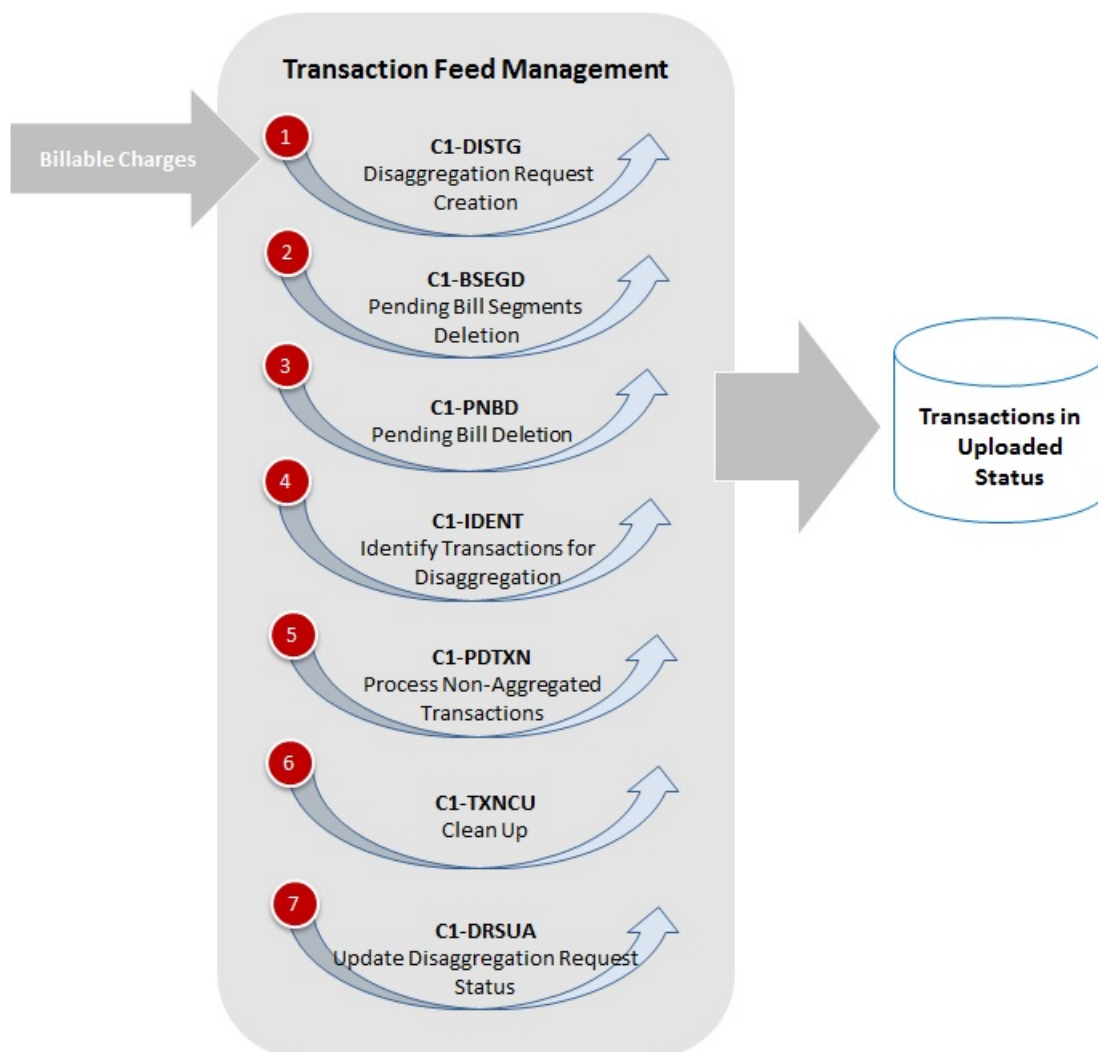

Transaction Cancellation

There might be situations when incorrect transaction data file is uploaded in the system. In such cases, the system provides you with an ability to cancel the whole transaction feed. You can cancel a transaction feed either before the transaction aggregation process starts (that is, before executing the **Validate Transaction and Derive Price Item (C1-TXNIP)** batch) or after the transaction aggregation process ends (that is, after executing the **Clean Up (C1-TXNCU)** batch). In other words, you cannot cancel a transaction feed during the transaction aggregation process. Once the transaction feed is cancelled, the status of the feed and all transactions in the feed is changed to **Cancelled (CNCL)**.

The following table explains how the system behaves:

When you cancel a transaction feed for which...	Then
A bill (with the Pending status) is already generated in the system	The corresponding billable charges, bill segments, and bill are deleted. The corresponding transaction legs and their calculation lines (if any) are deleted, and the status of the transactions is changed to Cancelled (CNCL) .

When you cancel a transaction feed for which...	Then
	<p>Note:</p> <p>If a pending bill has a bill segment in the Frozen or Pending Cancel status, the system does not allow you to cancel the transaction feed.</p> <p>If a pending bill has a bill segment in the Cancel status, the system behaves in the following manner:</p> <ul style="list-style-type: none"> • Deletes all other bill segments which are not in the Cancel status. • The billable charge corresponding to the bill segment which is not in the Cancel status is deleted if the billable charge is in the Billable status and if the billable charge only includes transactions from the feed that you want to cancel. • The billable charge corresponding to the bill segment which is not in the Cancel status is not deleted or recalculated if the billable charge is in the Cancelled status. • The billable charge corresponding to the bill segment which is in the Cancel status is cancelled if the billable charge only includes transactions from the feed that you want to cancel. • The SQIs in the billable charge are recalculated if the billable charge includes transactions from multiple feeds. <p>If a bill is created for transactions which are uploaded through multiple transaction feeds (for example, Feed A and Feed B and you want to cancel Feed A), then:</p> <ul style="list-style-type: none"> • The bill and their corresponding bill segments are deleted. • The SQIs are recalculated in the corresponding billable charges. • The legs of transactions uploaded through Feed A and the corresponding calculation lines (if any) are deleted. • The status of the transactions uploaded through Feed A is changed to Cancelled (CNCL). • The status of Feed A is changed to Cancelled (CNCL). • The status of the transactions uploaded through Feed B remains the same (i.e. Completed (COMP)).
A bill (with the Complete status) already exists in the system	The system does not allow you to cancel the transaction feed.
A bill (with the Complete status) has all bill segments in the Cancelled status	The corresponding billable charges are cancelled. The corresponding transaction legs and their calculation lines (if any) are deleted, and the status of the transactions is changed to Cancelled (CNCL) .

When you cancel a transaction feed for which...	Then
A billable charge (with the Billable status) exists in the system	<p>The billable charge is deleted. The corresponding transaction legs and their calculation lines (if any) are deleted, and the status of the transactions is changed to Cancelled (CNCL).</p> <p>Note:</p> <p>In case a billable charge is created for transactions uploaded through multiple transaction feeds (for example, Feed A and Feed B and you want to cancel Feed A), then:</p> <ul style="list-style-type: none"> • The SQIs are recalculated in the billable charge. • The legs of transactions uploaded through Feed A and the corresponding calculation lines (if any) are deleted. • The status of the transactions uploaded through Feed A is changed to Cancelled (CNCL). • The status of Feed A is changed to Cancelled (CNCL). • The status of the transactions uploaded through Feed B remains the same (i.e. Completed (COMP)).
A billable charge (with the Cancelled status) exists in the system	The billable charge is not deleted. However, the corresponding transaction legs and their calculation lines (if any) are deleted and the status of the transactions is changed to Cancelled (CNCL) .

To cancel a transaction feed, you need to execute the following batches in the specified order:

1. **Pending Bill Deletion (C1-DELBL)** — This batch deletes the bills (with the **Pending** status) and their corresponding bill segments. You can specify either of the following parameters while executing this batch:

Parameter Name	Description	Mandatory (Yes or No)
Transaction Header ID	Used when you want to delete bills which include charges for transactions which are received in a particular transaction feed.	Yes
Chunk Size	Used to specify the number of transactions you want to execute in each work unit.	Yes
Maximum Batch Count	Used to specify the maximum number of transactions after which the data must be transferred to the database.	Yes
Thread Pool Name	Used to specify the thread pool on which you want to execute the batch.	No

2. **Clean Up (C1-TXNCU)** — This batch deletes non-aggregated and aggregated billable charges. An aggregated billable charge is deleted when it includes legs of transactions from the feed that you want to cancel. If an aggregated billable charge includes legs of transactions from multiple feeds, the SQIs and calculation lines (if any) are recalculated in the aggregated billable charge. The corresponding calculation lines are deleted whenever an aggregated billable charge, which includes transaction legs whose rating criteria is set to **Aggregate transactions and then rate aggregated SQs (AGTR)**, is cancelled or deleted during the cancellation process. Note that while executing this batch, the **Request Type** parameter must be set to **CNCL**. For more information about the parameters that you can specify while executing this batch, refer to [Clean Up](#) on page 1013.
3. **Cancellation (C1-TXCNC)** — This batch deletes the transaction legs. The corresponding calculation lines are deleted whenever an aggregated billable charge, which includes transaction legs whose rating criteria is set to **Rate individual transactions and aggregate calc lines across transactions (RITA)** or **Rate Transactions (RITX)**, is cancelled or deleted during the cancellation process. Finally, this batch changes the status of the feed and all

transactions in the feed to **Cancelled (CNCL)**. You can specify either of the following parameters while executing this batch:

Parameter Name	Description	Mandatory (Yes or No)
Transaction Header ID	Used when you want to cancel a particular transaction feed.	Yes
Chunk Size	Used to specify the number of transactions you want to execute in each work unit.	Yes
Maximum Batch Count	Used to specify the maximum number of transactions after which the data must be transferred to the database.	Yes
Thread Pool Name	Used to specify the thread pool on which you want to execute the batch.	No

Note:

If you want to undertake some preprocessing activities (such as cleaning data in any custom tables) during the cancellation process, you need to attach a preprocessing algorithm on the **TFM - Cancellation Pre-Processing** algorithm entity in the **Algorithms** tab of the **Division** screen. This algorithm is triggered when you execute the **Cancellation (C1-TXCNC)** batch. Note that the system invokes the algorithm which is attached on the derived account's division and not on the division to which the transaction belongs.

A sample preprocessing algorithm type named **C1_CNCL_PRPC** is shipped with the product. It does not have any business logic. If you want to undertake some preprocessing activities during the cancellation process, you need to create custom algorithm type and attach the respective algorithm on the **TFM - Cancellation Pre-Processing** algorithm spot of the respective division. You can refer to the **C1_CNCL_PRPC** algorithm type to understand the input parameters that must be passed to the custom algorithm type.

Related Topics

For more information on...	See...
Transaction Leg Status Transition	Transaction Leg Status Transition on page 1034

Transaction Cancellation Batch Processing

During the transaction cancellation process, you need to execute the following batches in the specified order:

1. Pending Bill Deletion (C1-DELBL)
2. Clean Up (C1-TXNCU) with the **Request Type** parameter set to **CNCL**
3. Cancellation (C1-TXCNC)

The following figure graphically explains the sequence in which you need to execute the batches during the transaction cancellation process:

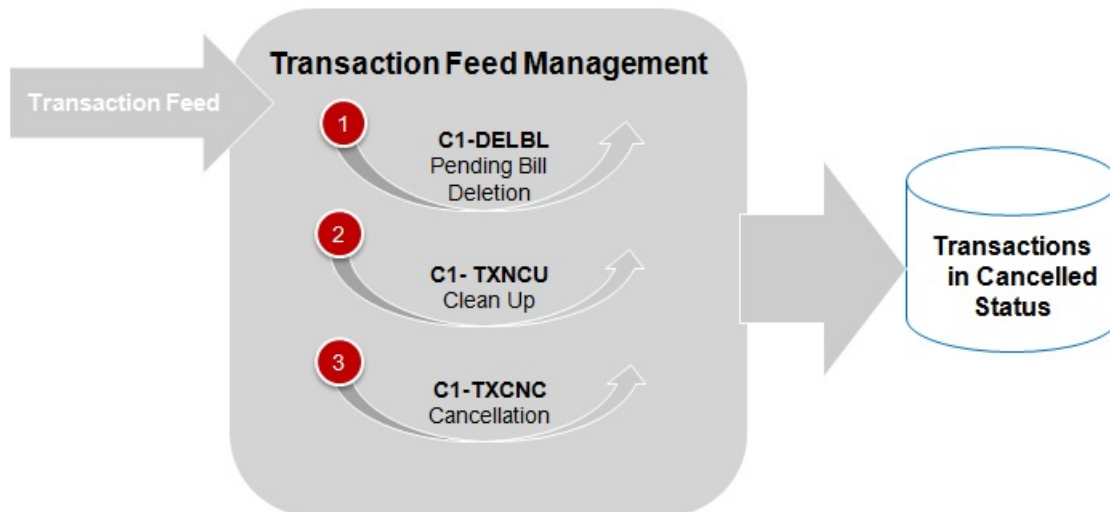

Transaction Rollback

In the transaction aggregation process, an error occurs when:

- Transaction validation fails.
- Transaction does not satisfy any rule invoked through the rule type.
- Effective pricing is not available for one or more price items to which a transaction is mapped.
- SQIs are not defined for the price item — division combination.
- Transaction aggregation rule is not defined for the SQL.
- Exchange rate is not available during currency conversion.
- There is no contract available with the specified contract type on the transaction date or when the contract is inactive.
- There are multiple effective contracts of the same contract type (available on the transaction date) in **Active**, **Pending Stop**, or **Stop** status.
- The **Price Assignment Search** algorithm is not defined for the division.
- The parameter values are either not defined or invalid in the **Price Assignment Search** algorithm on the processing date.
- The period in which the transaction date falls is not defined in the aggregation schedule.
- Price Item parameters specified in the output parameters are not effective for the price item on the processing date.
- Mandatory price item parameter which is effective on the processing date is not specified in the output parameter.
- Parameter value is not specified for all mandatory price item parameters which are effective on the processing date.

In such cases, the status of the transaction is changed to **Error**. You can configure the required setup and then execute the following batches once again in the specified order:

1. Flush All Caches (F1-FLUSH)
2. Refresh Pricing (C1-TXNRP)
3. Header Validation (C1-TXNHV)
4. Validate Transaction and Derive Price Item (C1-TXNIP)
5. Populate CI_TXN_DTL_PRITM_SUMMARY Table (C1-TXNPS)

Note: You must execute the **Populate CI_TXN_DTL_PRITM_SUMMARY Table (C1-TXNPS)** batch when the **Use C1-TXNPS During Transaction Aggregation** option type in the **C1_FM** feature configuration is set to **true**.

6. Price Item Pricing Verification (C1-TXNVP)
7. Update Status (C1-TXNEX)
8. Service Quantity Calculation (C1-TXNSQ)
9. Mark Completion (C1-TXNCM)
10. Clean Up (C1-TXNCU)

But, before you execute these batches, you need to rollback the transaction status to **Uploaded (UPLD)**. The system allows you to rollback transactions which are in the **Ignored (IGNR)** and **Error (EROR)** status. When you rollback a transaction, the corresponding transaction legs are deleted and the status of the transaction is changed to **Uploaded (UPLD)**. On rolling back a transaction leg whose effective pricing has the **Ignore Transaction** field set to **Yes** and the **Rating Criteria** field set to **Rate Transactions (RITX)**, the corresponding calculation lines are also deleted along with the transaction leg. If you rollback a partially disaggregated transaction which is in the **Error (EROR)** status, the transaction legs which are in the **Error (EROR)** status are only deleted and the status of the transaction is changed to **Uploaded (UPLD)**.

You need to execute the **Rollback (C1-TXNRB)** batch to rollback transactions which are in the **Ignored (IGNR)** and **Error (EROR)** status. You can specify the following parameters while executing this batch:

Parameter Name	Description	Mandatory (Yes or No)
Transaction Status	Used to indicate whether you want to rollback transactions which are in the Ignored or Error status. The valid values are: <ul style="list-style-type: none"> • IGNR • EROR 	Yes
Transaction Header ID	Used when you want to rollback transactions which are received in a particular transaction feed.	No
Transaction Source	Used when you want to rollback transactions which are received from a particular transaction source.	No
Division	Used when you want to rollback transactions belonging to a particular division.	No
Rollback From Date	Used when you want to rollback transactions which were performed from a particular date onwards. <p>Note: You must specify the date in the YYYY-MM-DD format. The rollback from date cannot be later than the rollback to date.</p>	No
Rollback To Date	Used when you want to rollback transactions which were performed till a particular date. <p>Note: You must specify the date in the YYYY-MM-DD format. The rollback to date cannot be earlier than the rollback from date.</p>	No

Parameter Name	Description	Mandatory (Yes or No)
Chunk Size	Used to specify the number of transactions you want to execute in each work unit.	Yes
Maximum Batch Count	Used to specify the maximum number of transactions after which the data must be transferred to the database.	Yes
Thread Pool Name	Used to specify the thread pool on which you want to execute the batch.	No

Note:

If you want to undertake some preprocessing activities (such as cleaning data in any custom tables) during the rollback process, you need to attach a preprocessing algorithm on the **Transaction Feed Management Rollback Preprocessing** algorithm entity in the **Algorithms** tab of the **Division** screen. This algorithm is triggered when you execute the **Rollback (C1-TXNRB)** batch. Note that the system invokes the algorithm which is attached on the division to which the transaction belongs.

A sample preprocessing algorithm type named **C1_ROBK_PRPC** is shipped with the product. It does not have any business logic. If you want to undertake some preprocessing activities during the rollback process, you need to create custom algorithm type and attach the respective algorithm on the **TFM - Rollback Pre-Processing** algorithm spot of the respective division. You can refer to the **C1_ROBK_PRPC** algorithm type to understand the input parameters that must be passed to the custom algorithm type.

Related Topics

For more information on...	See...
Transaction Leg Status Transition	Transaction Leg Status Transition on page 1034

Feed Status Transition

The following figure graphically indicates how a feed moves from one status to another during the transaction feed management process:

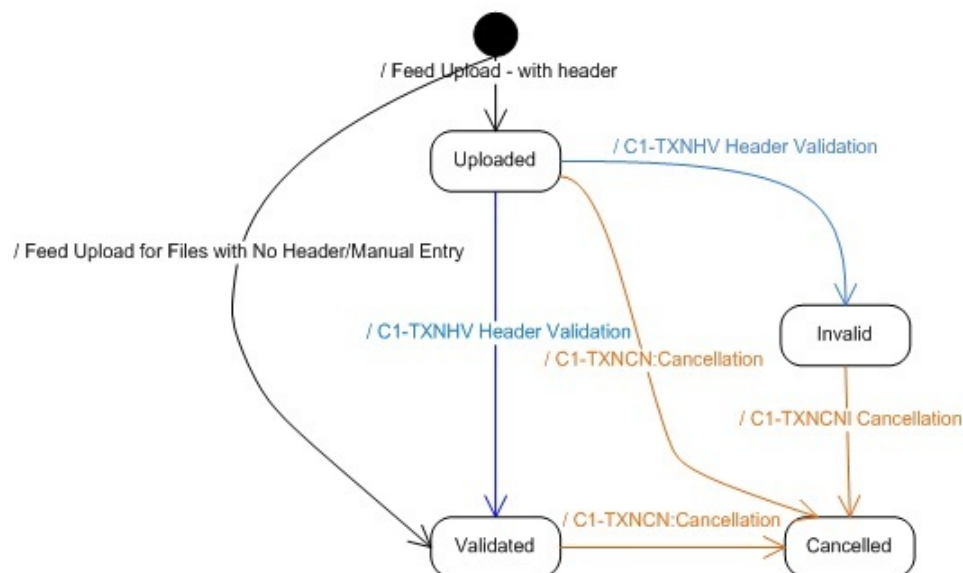

Transaction Status Transition

Aggregation

The following figure graphically indicates how a transaction moves from one status to another during the aggregation process:

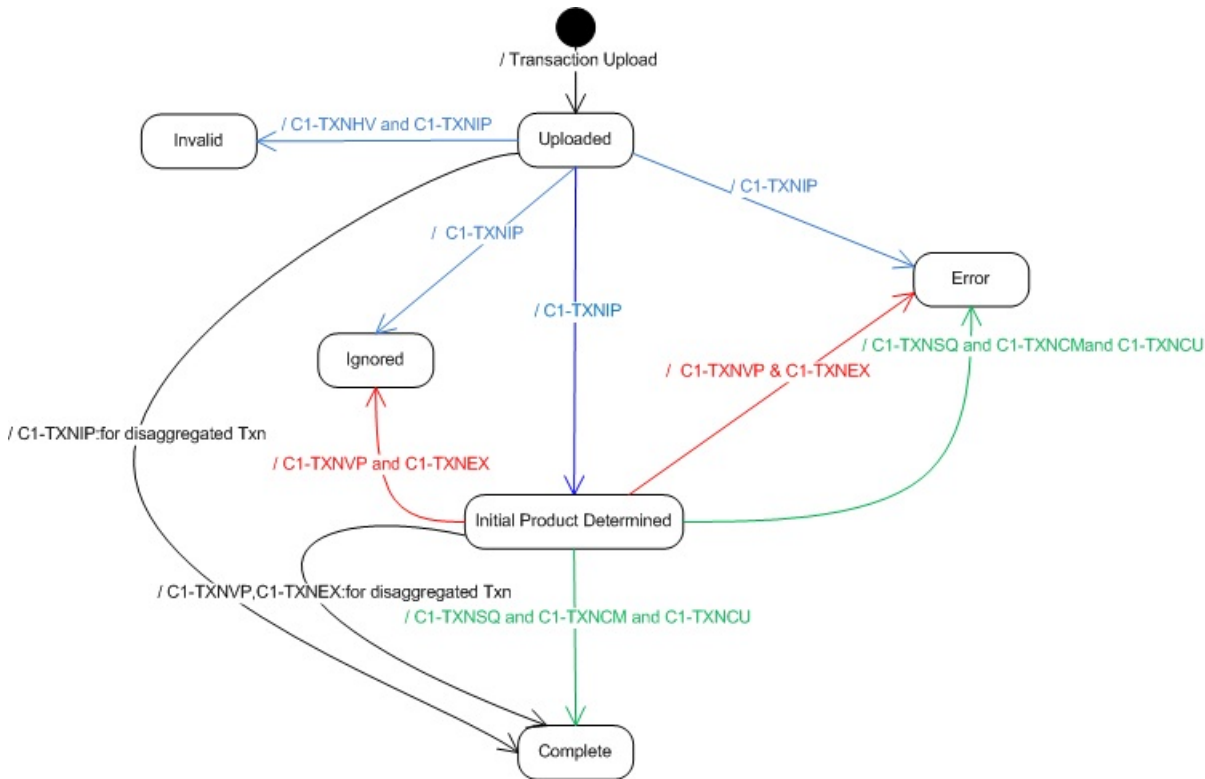

Disaggregation, Rollback, and Cancellation

The following figure graphically indicates how a transaction moves from one status to another during the disaggregation, rollback, and cancellation processes:

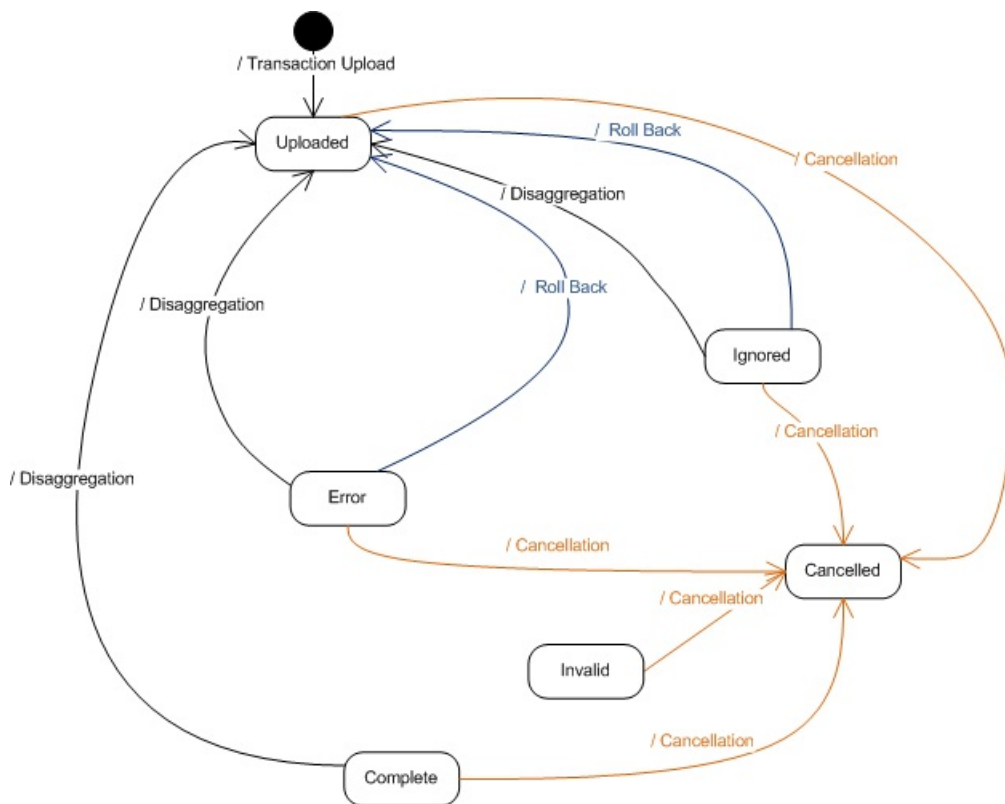

Transaction Leg Status Transition

This section explains how a transaction leg moves from one status to another during the following sub-processes:

- Transaction Aggregation

Note: This is the aggregation process for transactions that are recently uploaded or reaggregated after being fully disaggregated.

- Transaction Rollback
- Transaction Cancellation
- Transaction Disaggregation
- Transaction Reaggregation

Note: This is the aggregation process for transactions that are reaggregated after being partially disaggregated.

Transaction Aggregation

The following table indicates how a transaction leg moves from one status to another during the aggregation process:

Sr. No.	Batch	Event	Pre Event Transaction Status	Pre Event Transaction Leg Status	Post Event Transaction Status	Post Event Transaction Leg Status
1	C1-TXNIP	Transaction validation fails due to incomplete transaction data	UPLOADED	Not applicable as the transaction legs are not yet created	INVALID	Not applicable as the transaction legs are not yet created
2	C1-TXNIP	Transaction validation fails due to invalid or incorrect transaction data	UPLOADED	Not applicable as the transaction legs are not yet created	ERROR	Not applicable as the transaction legs are not yet created
3	C1-TXNIP	Transaction validation is successful but no product is derived	UPLOADED	Not applicable as the transaction legs are not yet created	ERROR	Not applicable as the transaction legs are not yet created
4	C1-TXNIP	Transaction validation is successful and product is derived	UPLOADED	Not applicable as the transaction legs are not yet created	INITIAL PRODUCT DETERMINED	INITIAL PRODUCT DETERMINED
5	C1-TXNIP	Transaction validation is successful and the transaction is ignored by the rule based on the transaction attributes	UPLOADED	Not applicable as the transaction legs are not yet created	IGNORED	Not applicable as the transaction legs are not yet created
6	C1-TXNVP and C1-TXNEX	Effective pricing is not found for any of the transaction legs	INITIAL PRODUCT DETERMINED	INITIAL PRODUCT DETERMINED	ERROR	ERROR
7	C1-TXNVP and C1-TXNEX	Ignore Transaction flag is set to Y in the effective pricing for one or more transaction legs but not for all transaction legs	INITIAL PRODUCT DETERMINED	INITIAL PRODUCT DETERMINED	INITIAL PRODUCT DETERMINED	IGNORED (when Ignore Transaction flag is set to Y in the effective pricing) INITIAL PRODUCT DETERMINED (when Ignore Transaction flag is set to N in the effective pricing)
8	C1-TXNVP and C1-TXNEX	Ignore Transaction flag is set to Y in the effective pricing for all transaction legs	INITIAL PRODUCT DETERMINED	INITIAL PRODUCT DETERMINED	IGNORED	IGNORED

Sr. No.	Batch	Event	Pre Event Transaction Status	Pre Event Transaction Leg Status	Post Event Transaction Status	Post Event Transaction Leg Status
9	C1-TXNVP and C1-TXNEX	Ignore Transaction flag is set to N in the effective pricing for all transaction legs	INITIAL PRODUCT DETERMINED	INITIAL PRODUCT DETERMINED	INITIAL PRODUCT DETERMINED	INITIAL PRODUCT DETERMINED
10	C1-TXNSQ and C1-TXNCM	SQIs are not defined for the product — division combination, Transaction aggregation rule is not defined for the SQI, or Exchange rate is not available during currency conversion	INITIAL PRODUCT DETERMINED	INITIAL PRODUCT DETERMINED	ERROR	ERROR
11	C1-TXNSQ and C1-TXNCM	Billable charges are created successfully for all transaction legs	INITIAL PRODUCT DETERMINED	INITIAL PRODUCT DETERMINED	COMPLETED	COMPLETED

Transaction Rollback

The following table indicates how a transaction leg moves from one status to another during the rollback process:

Sr. No.	Batch	Event	Pre Event Transaction Status	Pre Event Transaction Leg Status	Post Event Transaction Status	Post Event Transaction Leg Status
1	C1-TXNRB	Transactions with the Error (EROR) status are rolled back	ERROR	ERROR	UPLOADED	Not applicable as the transaction legs are not yet created
2	C1-TXNRB	Transactions with the Ignored (IGNR) status are rolled back	IGNORED	IGNORED	UPLOADED	Not applicable as the transaction legs are not yet created

Transaction Cancellation

The following table indicates how a transaction leg moves from one status to another during the cancellation process:

Sr. No.	Batch	Event	Pre Event Transaction Status	Pre Event Transaction Leg Status	Post Event Transaction Status	Post Event Transaction Leg Status
1	C1-TXCNC	Transactions in any status are cancelled	UPLOADED, INITIAL PRODUCT DETERMINED, ERROR, COMPLETED, INVALID, or IGNORED	INITIAL PRODUCT DETERMINED, ERROR, IGNORED, or COMPLETED	CANCELLED	CANCELLED

Transaction Disaggregation

The following table indicates how a transaction leg moves from one status to another during the disaggregation process:

Sr. No.	Batch	Event	Pre Event Transaction Status	Pre Event Transaction Leg Status	Post Event Transaction Status	Post Event Transaction Leg Status
1	C1-DISTG	Transactions in the COMPLETED, ERROR, or IGNORED status are disaggregated.	COMPLETED, ERROR, or IGNORED Note: The transactions in the ERROR or IGNORED status must have legs for disaggregation.	COMPLETED, ERROR, or IGNORED	No change in the status	No change in the status
2	C1-DISTG	Transactions in the INVALID or CANCELLED status cannot be disaggregated. In addition, the newly uploaded transactions and fully disaggregated transactions which are in the UPLOADED status cannot be disaggregated.	CANCELLED, INVALID, or UPLOADED	Not applicable as the transactions will not have any legs in these statuses	No change in the status	Not applicable as the transactions will not have any legs in these statuses
3	C1-IDENT	Transactions in the COMPLETED, ERROR, or IGNORED status are disaggregated.	COMPLETED, ERROR, or IGNORED Note: The transactions in the ERROR or IGNORED status must have legs for disaggregation.	COMPLETED, ERROR, or IGNORED	No change in the status	No change in the status
4	C1-IDENT	Transaction has already been disaggregated and is in the UPLOADED status. The transaction legs which were not affected are moved in the staging table and the transaction legs which were affected are deleted. Now, if the effective pricing is changed for the account to which the transaction leg in the staging table is mapped,	UPLOADED	UPLOADED	No change in the status	No change in the status

Sr. No.	Batch	Event	Pre Event Transaction Status	Pre Event Transaction Leg Status	Post Event Transaction Status	Post Event Transaction Leg Status
		then that transaction leg must be disaggregated. Thus, disaggregation is done even though the transaction is in the UPLOADED status.				
5	C1-PDTXN	Transactions in the COMPLETED, ERROR, or IGNORED status are disaggregated.	COMPLETED, ERROR, or IGNORED Note: The transactions in the ERROR or IGNORED status must have legs for disaggregation.	COMPLETED, ERROR, or IGNORED	UPLOADED	Transaction legs which are affected during disaggregation are deleted and the other legs which are not affected are moved to the staging table.

Transaction Reaggregation

The following table indicates how a transaction leg moves from one status to another during the reaggregation process:

Sr. No.	Batch	Event	Transaction Status Before Disaggregation	Transaction Leg Status Before Disaggregation	Transaction Status After Reaggregation	Transaction Leg Status After Reaggregation
1	C1-TXNIP	Transaction in the COMPLETED status was disaggregated. It had four transaction legs – two in the COMPLETED status and other two in the IGNORED status. A transaction leg in the COMPLETED status was disaggregated due to change in the business rule (i.e. IGNORE_SW is set to Y).	COMPLETED	COMPLETED, IGNORED	COMPLETED	Derived Leg: IGNORED Existing Legs: COMPLETED and IGNORED
2	C1-TXNIP	Transaction in the COMPLETED status was disaggregated. It had one transaction leg in the COMPLETED	COMPLETED	COMPLETED, IGNORED	IGNORED	Derived Leg: IGNORED Existing Legs: IGNORED

Sr. No.	Batch	Event	Transaction Status Before Disaggregation	Transaction Leg Status Before Disaggregation	Transaction Status After Reaggregation	Transaction Leg Status After Reaggregation
		status and all other transaction legs in the IGNORED status. The leg in the COMPLETED status was disaggregated due to change in the business rule (i.e. IGNORE_SW is set to Y).				
3	C1-TXNIP	Transaction in the COMPLETED status was disaggregated. All the transaction legs were in the COMPLETED status. One of the transaction legs in the COMPLETED status was disaggregated. During reaggregation, no product was derived for this transaction leg.	COMPLETED	COMPLETED	ERROR	Derived Leg: No new transaction leg was created Existing Legs: COMPLETED
4	C1-TXNIP	Transaction in the ERROR status was disaggregated. It had no transaction legs. During reaggregation, no product was derived for the transaction.	ERROR	No Transaction Legs Exist	ERROR	Derived Leg: No new transaction leg was created Existing Legs: None
5	C1-TXNIP	Transaction in the ERROR status was disaggregated. It had no transaction legs. During reaggregation, a product was derived for the transaction.	ERROR	No Transaction Legs Exist	INITIAL PRODUCT DETERMINED	Derived Leg: INITIAL PRODUCT DETERMINED Existing Legs: None
6	C1-TXNVP	Transaction in the COMPLETED status was	COMPLETED	COMPLETED, IGNORED	ERROR	Derived Leg: ERROR

Sr. No.	Batch	Event	Transaction Status Before Disaggregation	Transaction Leg Status Before Disaggregation	Transaction Status After Reaggregation	Transaction Leg Status After Reaggregation
	and C1-TXNEX	disaggregated. It had four transaction legs – two in the COMPLETED status and other two in the IGNORED status. A transaction leg in the COMPLETED status was disaggregated. During reaggregation, the effective pricing was not found for the transaction leg.				Existing Legs: COMPLETED and IGNORED
7	C1-TXNVP and C1-TXNEX	Transaction in the ERROR status was disaggregated. It had no transaction legs. During reaggregation, the effective pricing is found for the transaction legs.	ERROR	No Transaction Legs Exist	INITIAL PRODUCT DETERMINED	Derived Legs: INITIAL PRODUCT DETERMINED Existing Legs: None
8	C1-TXNVP and C1-TXNEX	Transaction in the COMPLETED status was disaggregated. It had four transaction legs – two in the COMPLETED status and other two in the IGNORED status. A transaction leg in the COMPLETED status was disaggregated due to change in the effective pricing (i.e. Ignore Transaction flag is set to Y).	COMPLETED	COMPLETED, IGNORED	COMPLETED	Derived Leg: IGNORED Existing Legs: COMPLETED and IGNORED
9	C1-TXNVP and C1-TXNEX	Transaction in the COMPLETED status was disaggregated. It had one transaction	COMPLETED	COMPLETED, IGNORED	IGNORED	Derived Leg: IGNORED Existing Legs: IGNORED

Sr. No.	Batch	Event	Transaction Status Before Disaggregation	Transaction Leg Status Before Disaggregation	Transaction Status After Reaggregation	Transaction Leg Status After Reaggregation
		leg in the COMPLETED status and all other transaction legs in the IGNORED status. The leg in the COMPLETED status was disaggregated due to change in the effective pricing (i.e. Ignore Transaction flag is set to Y).				
10	C1-TXNSQ and C1-TXNCM	While reaggregating transaction legs, SQIs are not defined for the product — division combination, Transaction aggregation rule is not defined for the SQI, or Exchange rate is not available during currency conversion.	COMPLETED, ERROR, IGNORED Note: There must be no legs for the transaction in the IGNORED status.	COMPLETED, ERROR	ERROR	Derived Legs: ERROR Existing Legs: No change in the status
11	C1-TXNSQ and C1-TXNCM	Billable charges are created successfully for all transaction legs which were earlier disaggregated and now reaggregated.	COMPLETED, ERROR, IGNORED Note: There must be no legs for the transaction in the IGNORED status.	COMPLETED, ERROR	COMPLETED	Derived Leg: COMPLETED Existing Legs: No change in the status

Transaction Data File

You can upload a transaction data file in the following formats:

- Comma Separated Values
- JavaScript Object Notation
- Fixed Position
- Pipe Separated Values

- Tilde Separated Values
- Extensible Markup Language

Before uploading a transaction data file, you need to ensure that it contains the following:

- **File Header** - Every file must have one header record. It should contain the following details:

Header Data	Description	Mandatory (Yes or No)
Transaction Source	Used to specify the source from where the transactions are received.	Yes
Header Date (YYYYMMDD)	Used to specify the header date.	Yes
Transaction Header ID	Used to specify the external transaction header ID.	Yes
File Name	Used to specify the file name.	Yes
Number of Transactions	Used to specify the total number of transaction records in the file.	Yes
Total Transaction Volume	Used to specify the total transaction volume.	Yes
Total Transaction Amount	Used to specify the total transaction amount.	Yes

- **Transaction Record** - Every file must have one or more transaction records. It should contain the following details:

Record Data	Description	Mandatory (Yes or No)
Transaction Record Type	Used to specify the record type of the transaction.	Yes
Transaction Source	Used to specify the source from where the transaction is received.	Yes
Transaction Date (YYYYMMDD)	Used to specify the date when the transaction was performed.	Yes
External Reference Number	Used to specify the external reference number of the transaction.	Yes
Customer Reference Number	Used to indicate the customer who has performed the transaction.	No
Division	Used to specify the division to which the transaction belongs.	Yes
Transaction Volume	Used to specify the transaction volume.	Yes
Transaction Amount	Used to specify the transaction amount.	Yes
Transaction Currency	Used to specify the currency in which the transaction was performed. Note: If you specify a currency other than the pricing currency, the system will do the currency conversion when the appropriate exchange rate is available in the system.	Yes

Record Data	Description	Mandatory (Yes or No)
Credit/Debit Indicator	Used to indicate whether the transaction is a debit or a credit transaction. The valid values are: <ul style="list-style-type: none"> • Plus (+) • Minus (-) 	Yes
Account Identifier Type	Used to indicate the account identifier type.	Yes
Account Identifier	Used to indicate the account for which the transaction was performed.	Yes
UDF_NUM_1, UDF_NUM_2, UDF_NUM_3, ..., UDF_NUM_20	Used to specify additional information about the transaction.	No
UDF_AMT_1, UDF_AMT_2, UDF_AMT_3, ..., UDF_AMT_10	Used to specify additional transaction amount.	Yes (Conditional) Note: The UDF_AMT_N is required when the corresponding UDF_CCY_N is specified.
UDF_CCY_1, UDF_CCY_2, UDF_CCY_3, ..., UDF_CCY_10	Used to specify additional transaction currency. Note: If you specify a currency other than the pricing currency, the system will do the currency conversion when the appropriate exchange rate is available in the system.	Yes (Conditional) Note: The UDF_CCY_N is required when the corresponding UDF_AMT_N is specified.
UDF_DTTM_1, UDF_DTTM_2, ..., UDF_DTTM_5	Used to specify additional information about the transaction.	No
UDF_CHAR_1, UDF_CHAR_2, UDF_CHAR_3, ..., UDF_CHAR_50	Used to specify additional information about the transaction. Note: If the data in these columns will be used for price item parameter mapping, you must not use the equal to (=) and tilde (~) symbols in these columns.	No

Error List

The following table lists the errors that may occur while executing various batches in the transaction feed management process. It also indicates how you can resolve these errors.

Batch Name	Message Number	Error Message	Message Category	Possible Issues
C1-TXNHV	102	{Checksum Validation Required} field invalid.	11001	The possible issues could be: <ul style="list-style-type: none"> The value other than 'Y', 'y', 'N' or 'n' is specified for the Checksum Validation Required parameter.
C1-TXNHV	102	{Duplicate Check Required} field invalid.	11001	The possible issues could be: <ul style="list-style-type: none"> The value other than 'Y', 'y', 'N' or 'n' is specified for the Duplicate Check Required parameter.
C1-TXNHV	1314	The Transaction Source is mandatory.	17000	The possible issues could be: <ul style="list-style-type: none"> The data is not available in the Transaction Source column.
C1-TXNHV	1332	Sum of transaction records in the header does not match the total number of records in the file.	17000	The possible issues could be: <ul style="list-style-type: none"> Inappropriate file is uploaded in the system.
C1-TXNHV	1333	Sum of transaction volume in the header does not match the total transaction volume in the file.	17000	The possible issues could be: <ul style="list-style-type: none"> Inappropriate file is uploaded in the system.
C1-TXNHV	1334	Sum of transaction amount in the header does not match the total transaction amount in the file.	17000	The possible issues could be: <ul style="list-style-type: none"> Inappropriate file is uploaded in the system.
C1-TXNHV	1338	The Transaction Header ID already exists in the system. Please enter unique header ID.	17000	The possible issues could be: <ul style="list-style-type: none"> The same file is uploaded multiple times in the system.
C1-TXNHV	1341	Exception occurred during the transaction header validation.	17000	The possible issues could be: <ul style="list-style-type: none"> The data is not available in the required format.
C1-TXNHV	1421	Transaction records does not exist in the file. Please check.	17000	The possible issues could be: <ul style="list-style-type: none"> Inappropriate file is uploaded in the system.
C1-TXNHV	1422	Sum of transaction records in the header cannot be zero. Please enter valid data in the header.	17000	The possible issues could be: <ul style="list-style-type: none"> The value available in the Number of Transactions column is less than or equal to zero.
C1-TXNHV	1423	Sum of transaction volume in the header cannot be zero. Please enter valid data in the header.	17000	The possible issues could be: <ul style="list-style-type: none"> The value available in the Total Transaction Volume column is less than or equal to zero.

Batch Name	Message Number	Error Message	Message Category	Possible Issues
C1-TXNHV	1663	Transaction Header External Id is missing.	17000	The possible issues could be: <ul style="list-style-type: none"> The data is not available in the Transaction Header ID column.
C1-TXNHV	1664	Header Transaction Amount should be greater than 0.	17000	The possible issues could be: <ul style="list-style-type: none"> The value available in the Total Transaction Amount column is less than or equal to zero.
C1-TXNIP	102	{ Chunk Size } field invalid	11001	The possible issues could be: <ul style="list-style-type: none"> The value specified for the Chunk Size parameter is less than or equal to one.
C1-TXNIP	102	{ Maximum Batch Size } field invalid	11001	The possible issues could be: <ul style="list-style-type: none"> The value specified for the Maximum Batch Count parameter is greater than the value specified for the Chunk Size parameter.
C1-TXNIP	106	Value { Given Transaction Header Id } too long for field { transactionHeaderId }. Maximum length: 14. Found: { Length of given Transaction Header Id }	11001	The possible issues could be: <ul style="list-style-type: none"> The value specified for the Transaction Header ID parameter exceeds the maximum length of 14 characters.
C1-TXNIP	106	Value { Given Transaction Source Code } too long for field { transactionSource }. Maximum length: 30. Found: { Length of given Transaction Source Code }	11001	The possible issues could be: <ul style="list-style-type: none"> The value specified for the Transaction Source parameter exceeds the maximum length of 30 characters.
C1-TXNIP	106	Value { Given Transaction Division } too long for field { division }. Maximum length: 5 Found: { Length of given Transaction Division }	11001	The possible issues could be: <ul style="list-style-type: none"> The value specified for the Division parameter exceeds the maximum length of 5 characters.
C1-TXNIP	1301	The account with the specified identifier does not exist in the system. Enter a valid identifier.	17000	The possible issues could be: <ul style="list-style-type: none"> The account with the specified account identifier is not found in the system.
C1-TXNIP	1302	UDF_CURRENCY_1 is mandatory when UDF_AMT_1 is non-zero. Enter a valid currency code.	17000	The possible issues could be: <ul style="list-style-type: none"> The currency is not available in the UDF_CURRENCY_CD_1 column of the CI_TXN_DETAIL table.

Batch Name	Message Number	Error Message	Message Category	Possible Issues
C1-TXNIP	1303	UDF_AMT_1 is mandatory when UDF_CURRENCY_1 is specified. Enter the amount.	17000	The possible issues could be: <ul style="list-style-type: none"> The amount is not available in the UDF_AMT_1 column of the CI_TXN_DETAIL table.
C1-TXNIP	1304	UDF_CURRENCY_2 is mandatory when UDF_AMT_2 is non-zero. Enter a valid currency code.	17000	The possible issues could be: <ul style="list-style-type: none"> The currency is not available in the UDF_CURRENCY_CD_2 column of the CI_TXN_DETAIL table.
C1-TXNIP	1305	UDF_AMT_2 is mandatory when UDF_CURRENCY_2 is specified. Enter the amount.	17000	The possible issues could be: <ul style="list-style-type: none"> The amount is not available in the UDF_AMT_2 column of the CI_TXN_DETAIL table.
C1-TXNIP	1306	UDF_CURRENCY_3 is mandatory when UDF_AMT_3 is non-zero. Enter a valid currency code.	17000	The possible issues could be: <ul style="list-style-type: none"> The currency is not available in the UDF_CURRENCY_CD_3 column of the CI_TXN_DETAIL table.
C1-TXNIP	1307	UDF_AMT_3 is mandatory when UDF_CURRENCY_3 is specified. Enter the amount.	17000	The possible issues could be: <ul style="list-style-type: none"> The amount is not available in the UDF_AMT_3 column of the CI_TXN_DETAIL table.
C1-TXNIP	1308	UDF_CURRENCY_4 is mandatory when UDF_AMT_4 is non-zero. Enter a valid currency code.	17000	The possible issues could be: <ul style="list-style-type: none"> The currency is not available in the UDF_CURRENCY_CD_4 column of the CI_TXN_DETAIL table.
C1-TXNIP	1309	UDF_AMT_4 is mandatory when UDF_CURRENCY_4 is specified. Enter the amount.	17000	The possible issues could be: <ul style="list-style-type: none"> The amount is not available in the UDF_AMT_4 column of the CI_TXN_DETAIL table.
C1-TXNIP	1310	UDF_CURRENCY_5 is mandatory when UDF_AMT_5 is non-zero. Enter a valid currency code.	17000	The possible issues could be: <ul style="list-style-type: none"> The currency is not available in the UDF_CURRENCY_CD_5 column of the CI_TXN_DETAIL table.
C1-TXNIP	1311	UDF_AMT_5 is mandatory when UDF_CURRENCY_5 is specified. Enter the amount.	17000	The possible issues could be: <ul style="list-style-type: none"> The amount is not available in the UDF_AMT_5 column of the CI_TXN_DETAIL table.
C1-TXNIP	1312	UDF_CURRENCY_6 is mandatory when UDF_AMT_6 is non-zero. Enter a valid currency code.	17000	The possible issues could be: <ul style="list-style-type: none"> The currency is not available in the UDF_CURRENCY_CD_6 column of the CI_TXN_DETAIL table.

Batch Name	Message Number	Error Message	Message Category	Possible Issues
C1-TXNIP	1313	UDF_AMT_6 is mandatory when UDF_CURRENCY_6 is specified. Enter the amount.	17000	The possible issues could be: <ul style="list-style-type: none"> The amount is not available in the UDF_AMT_6 column of the CI_TXN_DETAIL table.
C1-TXNIP	1314	UDF_CURRENCY_7 is mandatory when UDF_AMT_7 is non-zero. Enter a valid currency code.	17000	The possible issues could be: <ul style="list-style-type: none"> The currency is not available in the UDF_CURRENCY_CD_7 column of the CI_TXN_DETAIL table.
C1-TXNIP	1315	UDF_AMT_7 is mandatory when UDF_CURRENCY_7 is specified. Enter the amount.	17000	The possible issues could be: <ul style="list-style-type: none"> The amount is not available in the UDF_AMT_7 column of the CI_TXN_DETAIL table.
C1-TXNIP	1316	UDF_CURRENCY_8 is mandatory when UDF_AMT_8 is non-zero. Enter a valid currency code.	17000	The possible issues could be: <ul style="list-style-type: none"> The currency is not available in the UDF_CURRENCY_CD_8 column of the CI_TXN_DETAIL table.
C1-TXNIP	1317	UDF_AMT_8 is mandatory when UDF_CURRENCY_8 is specified. Enter the amount.	17000	The possible issues could be: <ul style="list-style-type: none"> The amount is not available in the UDF_AMT_8 column of the CI_TXN_DETAIL table.
C1-TXNIP	1318	UDF_CURRENCY_9 is mandatory when UDF_AMT_9 is non-zero. Enter a valid currency code.	17000	The possible issues could be: <ul style="list-style-type: none"> The currency is not available in the UDF_CURRENCY_CD_9 column of the CI_TXN_DETAIL table.
C1-TXNIP	1319	UDF_AMT_9 is mandatory when UDF_CURRENCY_9 is specified. Enter the amount.	17000	The possible issues could be: <ul style="list-style-type: none"> The amount is not available in the UDF_AMT_9 column of the CI_TXN_DETAIL table.
C1-TXNIP	1320	UDF_CURRENCY_10 is mandatory when UDF_AMT_10 is non-zero. Enter a valid currency code.	17000	The possible issues could be: <ul style="list-style-type: none"> The currency is not available in the UDF_CURRENCY_CD_10 column of the CI_TXN_DETAIL table.
C1-TXNIP	1321	UDF_AMT_10 is mandatory when UDF_CURRENCY_10 is specified. Enter the amount.	17000	The possible issues could be: <ul style="list-style-type: none"> The amount is not available in the UDF_AMT_10 column of the CI_TXN_DETAIL table.
C1-TXNIP	1347	Could not derive a price item from the rules engine.	17000	The possible issues could be: <ul style="list-style-type: none"> There is some technical issue while executing the rule or while processing the rule output.

Batch Name	Message Number	Error Message	Message Category	Possible Issues
				<ul style="list-style-type: none"> No rules are effective on the processing date. The rule type is not defined for the transaction source and transaction record type combination in the system.
C1-TXNIP	1349	Division is invalid. Please enter a valid division for the transaction.	17000	<p>The possible issues could be:</p> <ul style="list-style-type: none"> Division (to which the transaction belongs) is not defined in the system.
C1-TXNIP	1351	Transaction Currency is invalid. Please enter a valid currency code.	17000	<p>The possible issues could be:</p> <ul style="list-style-type: none"> The currency in which the transaction was performed is not available in the Transaction Currency column. Currency is not defined in the system.
C1-TXNIP	1362	UDF Currency 1 is invalid. Please enter a valid currency code.	17000	<p>The possible issues could be:</p> <ul style="list-style-type: none"> Currency is not defined in the system.
C1-TXNIP	1363	UDF Currency 2 is invalid. Please enter a valid currency code.	17000	<p>The possible issues could be:</p> <ul style="list-style-type: none"> Currency is not defined in the system.
C1-TXNIP	1364	UDF Currency 3 is invalid. Please enter a valid currency code.	17000	<p>The possible issues could be:</p> <ul style="list-style-type: none"> Currency is not defined in the system.
C1-TXNIP	1365	UDF Currency 4 is invalid. Please enter a valid currency code.	17000	<p>The possible issues could be:</p> <ul style="list-style-type: none"> Currency is not defined in the system.
C1-TXNIP	1366	UDF Currency 5 is invalid. Please enter a valid currency code.	17000	<p>The possible issues could be:</p> <ul style="list-style-type: none"> Currency is not defined in the system.
C1-TXNIP	1377	Transaction currency is mandatory when transaction amount is non-zero. Enter a valid currency code.	17000	<p>The possible issues could be:</p> <ul style="list-style-type: none"> The currency is not available in the Transaction Currency column.
C1-TXNIP	1378	Transaction amount is mandatory when transaction currency is specified. Enter the amount.	17000	<p>The possible issues could be:</p> <ul style="list-style-type: none"> The amount is not available in the Transaction Amount column.

Batch Name	Message Number	Error Message	Message Category	Possible Issues
C1-TXNIP	1379	The user does not exist in the system. Please enter a valid user ID.	17000	The possible issues could be: <ul style="list-style-type: none"> The user is not defined in the system.
C1-TXNIP	1380	The value entered in the Credit/Debit Indicator column is incorrect. Enter either "+" or "-".	17000	The possible issues could be: <ul style="list-style-type: none"> The value other than '+' or '-' is available in the HOW_TO_USE_TXN_FLG column of the CI_TXN_DETAIL table.
C1-TXNIP	1381	The value entered in the Manual Switch field is incorrect. Enter either "Y" or "N".	17000	The possible issues could be: <ul style="list-style-type: none"> The value other than 'Y' or 'N' is available in the MANUAL_SW column of the CI_TXN_DETAIL table.
C1-TXNIP	1556	{Maximum Batch Size} field should be greater than zero	17000	The possible issues could be: <ul style="list-style-type: none"> The value specified for the Maximum Batch Count parameter is less than or equal to zero.
C1-TXNIP	1636	Invalid batch run [%1] for [%2] division(s). %3 Note: [%1] stands for batch code; [%2] stands for division; [%3] stands for expected batch code	17000	The possible issues could be: <ul style="list-style-type: none"> You are trying to execute the C1-TXNVP, C1-TXNEX, C1-TXNSQ, C1-TXNCM or C1-TXNCU batch instead of the C1-TXNIP batch (which is first mandatory batch in the transaction aggregation cycle).
C1-TXNIP	1637	Batch [%1] is already executed for [%2] division(s). Please complete pending batch runs before starting new cycle for [%3] division(s). Note: [%1] stands for batch code; [%2] and [%3] stands for division	17000	The possible issues could be: <ul style="list-style-type: none"> You are trying to execute this batch once again with the same division (for example, D1) after executing any other batch in the transaction aggregation cycle which is already initiated for D1.
C1-TXNIP	1638	Transaction Feed Management cycle for individual division(s) is not yet complete. Please complete pending batch runs before starting new cycle for processing [ALL] divisions.	17000	The possible issues could be: <ul style="list-style-type: none"> You are trying to execute this batch for all divisions before completing the transaction aggregation cycle which is initiated for a particular division.

Batch Name	Message Number	Error Message	Message Category	Possible Issues
C1-TXNIP	1639	Transaction Feed Management cycle for [ALL] divisions is not yet complete. Please complete pending batch runs before starting new cycle for individual division [%1]. Note: [%1] stands for division	17000	The possible issues could be: <ul style="list-style-type: none"> You are trying to execute this batch for a particular division before completing the transaction aggregation cycle which is initiated for all divisions.
C1-TXNIP	1646	Value for mandatory parameter is missing.	17000	The possible issues could be: <ul style="list-style-type: none"> No value is defined for the mandatory price item parameter in the rule.
C1-TXNIP	1647	Mandatory parameter is missing.	17000	The possible issues could be: <ul style="list-style-type: none"> The mandatory price item parameter is not defined as the output parameter in the rule.
C1-TXNIP	1648	Account Number derived by the rule is invalid.	17000	The possible issues could be: <ul style="list-style-type: none"> No value is defined for either Account Identifier (ACCT_NOX_Val) or Account Identifier Column Name (ACCT_NOX_Col) output parameter in the rule.
C1-TXNIP	1649	Account Number type code derived by the rule is invalid.	17000	The possible issues could be: <ul style="list-style-type: none"> No value is defined for either Account Identifier Type (ACCT_NO_TYPEX_Val) or Account Identifier Type Column Name (ACCT_NO_TYPEX_Col) output parameter in the rule.
C1-TXNIP	1650	Division derived by the rule is invalid.	17000	The possible issues could be: <ul style="list-style-type: none"> No value is defined for either Account Division (DIVISIONX_VAL) or Account Division Column Name (DIVISIONX_COL) output parameter in the rule.
C1-TXNIP	1651	Not able to derive account ID.	17000	The possible issues could be: <ul style="list-style-type: none"> The account with the specified account identifier type, account identifier, and division is not found in the system.
C1-TXNIP	1652	Product derived by the rule is invalid.	17000	The possible issues could be:

Batch Name	Message Number	Error Message	Message Category	Possible Issues
				<ul style="list-style-type: none"> No value is defined for either Product Name (PRODUCTX_Y_Val) or Product Column Name (PRODUCTX_Y_Col) output parameter in the rule.
C1-TXNIP	1653	Length of the derived product is greater than 10.	17000	<p>The possible issues could be:</p> <ul style="list-style-type: none"> The value specified for the Product Name (PRODUCTX_Y_Val) or Product Column Name (PRODUCTX_Y_Col) output parameter in the rule exceeds the maximum length of 10 characters.
C1-TXNIP	1654	Length of the derived variance parameter is greater than 8.	17000	<p>The possible issues could be:</p> <ul style="list-style-type: none"> The value specified for the TOU (TOUX_Y_Val) or TOU Column Name (TOUX_Y_Col) output parameter in the rule exceeds the maximum length of 8 characters.
C1-TXNIP	1656	Length of the product parameter value derived by the rule is greater than 254.	17000	<p>The possible issues could be:</p> <ul style="list-style-type: none"> The value specified for the Parameter Value (PVLX_Y_Z_VAL) or Parameter Value Column Name (PVLX_Y_Z_COL) output parameter in the rule exceeds the maximum length of 254 characters.
C1-TXNIP	1657	Length of the product parameter code derived by the rule is greater than 30.	17000	<p>The possible issues could be:</p> <ul style="list-style-type: none"> The value specified for the Parameter Code (PCDX_Y_Z_VAL) output parameter in the rule exceeds the maximum length of 30 characters.
C1-TXNIP	2002	Transaction is in EROR due to one or more reasons.	17000	<p>The possible issues could be:</p> <ul style="list-style-type: none"> There might be one or more reasons why the status of the transaction is set to Error (EROR).
C1-TXNIP	2007	%1 cannot be blank. Note: [%1] stands for division	17000	<p>The possible issues could be:</p> <ul style="list-style-type: none"> The division to which the transaction belongs is not available in the Division column.
C1-TXNIP	2007	%1 cannot be blank. Note: [%1] stands for user ID	17000	<p>The possible issues could be:</p> <ul style="list-style-type: none"> No data exists in the USER_ID column of the CI_TXN_DETAIL

Batch Name	Message Number	Error Message	Message Category	Possible Issues
				table when the MANUAL_SW column is set to Y .
C1-TXNIP	2011	<p>%1 is mandatory when %2 is non-zero. Enter a valid currency code.</p> <p>Note: [%1] stands for “Currency Code”; [%2] stands for “Transaction Amount”</p>	17000	<p>The possible issues could be:</p> <ul style="list-style-type: none"> The currency in which the transaction was performed is not available in the CURRENCY_CD column of the CI_TXN_DETAIL table.
C1-TXNIP	2011	<p>%1 is mandatory when %2 is non-zero. Enter a valid currency code.</p> <p>Note: [%1] stands for “Amount 1 Currency Code”; [%2] stands for “Additional Amount 1”</p>	17000	<p>The possible issues could be:</p> <ul style="list-style-type: none"> The currency is not available in the UDF_CURRENCY_CD_1 column of the CI_TXN_DETAIL table.
C1-TXNIP	2011	<p>%1 is mandatory when %2 is non-zero. Enter a valid currency code.</p> <p>Note: [%1] stands for “Amount 2 Currency Code”; [%2] stands for “Additional Amount 2”</p>	17000	<p>The possible issues could be:</p> <ul style="list-style-type: none"> The currency is not available in the UDF_CURRENCY_CD_2 column of the CI_TXN_DETAIL table.
C1-TXNIP	2011	<p>%1 is mandatory when %2 is non-zero. Enter a valid currency code.</p> <p>Note: [%1] stands for “Amount 3 Currency Code”; [%2] stands for “Additional Amount 3”</p>	17000	<p>The possible issues could be:</p> <ul style="list-style-type: none"> The currency is not available in the UDF_CURRENCY_CD_3 column of the CI_TXN_DETAIL table.
C1-TXNIP	2011	<p>%1 is mandatory when %2 is non-zero. Enter a valid currency code.</p>	17000	<p>The possible issues could be:</p> <ul style="list-style-type: none"> The currency is not available in the UDF_CURRENCY_CD_4 column of the CI_TXN_DETAIL table.

Batch Name	Message Number	Error Message	Message Category	Possible Issues
		<p>Note:</p> <p>[%1] stands for “Amount 4 Currency Code”;</p> <p>[%2] stands for “Additional Amount 4”</p>		
C1-TXNIP	2011	<p>%1 is mandatory when %2 is non-zero. Enter a valid currency code.</p> <p>Note:</p> <p>[%1] stands for “Amount 5 Currency Code”;</p> <p>[%2] stands for “Additional Amount 5”</p>	17000	<p>The possible issues could be:</p> <ul style="list-style-type: none"> The currency is not available in the UDF_CURRENCY_CD_5 column of the CI_TXN_DETAIL table.
C1-TXNIP	2011	<p>%1 is mandatory when %2 is non-zero. Enter a valid currency code.</p> <p>Note:</p> <p>[%1] stands for “Amount 6 Currency Code”;</p> <p>[%2] stands for “Additional Amount 6”</p>	17000	<p>The possible issues could be:</p> <ul style="list-style-type: none"> The currency is not available in the UDF_CURRENCY_CD_6 column of the CI_TXN_DETAIL table.
C1-TXNIP	2011	<p>%1 is mandatory when %2 is non-zero. Enter a valid currency code.</p> <p>Note:</p> <p>[%1] stands for “Amount 7 Currency Code”;</p> <p>[%2] stands for “Additional Amount 7”</p>	17000	<p>The possible issues could be:</p> <ul style="list-style-type: none"> The currency is not available in the UDF_CURRENCY_CD_7 column of the CI_TXN_DETAIL table.
C1-TXNIP	2011	<p>%1 is mandatory when %2 is non-zero. Enter a valid currency code.</p> <p>Note:</p> <p>[%1] stands for “Amount 8 Currency Code”;</p> <p>[%2] stands for “Additional Amount 8”</p>	17000	<p>The possible issues could be:</p> <ul style="list-style-type: none"> The currency is not available in the UDF_CURRENCY_CD_8 column of the CI_TXN_DETAIL table.

Batch Name	Message Number	Error Message	Message Category	Possible Issues
C1-TXNIP	2011	<p>%1 is mandatory when %2 is non-zero. Enter a valid currency code.</p> <p>Note:</p> <p>[%1] stands for “Amount 9 Currency Code”;</p> <p>[%2] stands for “Additional Amount 9”</p>	17000	<p>The possible issues could be:</p> <ul style="list-style-type: none"> The currency is not available in the UDF_CURRENCY_CD_9 column of the CI_TXN_DETAIL table.
C1-TXNIP	2011	<p>%1 is mandatory when %2 is non-zero. Enter a valid currency code.</p> <p>Note:</p> <p>[%1] stands for “Amount 10 Currency Code”;</p> <p>[%2] stands for “Additional Amount 10”</p>	17000	<p>The possible issues could be:</p> <ul style="list-style-type: none"> The currency is not available in the UDF_CURRENCY_CD_10 column of the CI_TXN_DETAIL table.
C1-TXNIP	2012	<p>%1 %2 is invalid. Please enter a valid currency code.</p> <p>Note:</p> <p>[%1] stands for “Currency Code”;</p> <p>[%2] stands for transaction currency</p>	17000	<p>The possible issues could be:</p> <ul style="list-style-type: none"> Currency is not defined in the system.
C1-TXNIP	2012	<p>%1 %2 is invalid. Please enter a valid currency code.</p> <p>Note:</p> <p>[%1] stands for “Amount 1 Currency Code”;</p> <p>[%2] stands for UDF_CURRENCY_CD_1</p>	17000	<p>The possible issues could be:</p> <ul style="list-style-type: none"> Currency is not defined in the system.
C1-TXNIP	2012	<p>%1 %2 is invalid. Please enter a valid currency code.</p>	17000	<p>The possible issues could be:</p> <ul style="list-style-type: none"> Currency is not defined in the system.

Batch Name	Message Number	Error Message	Message Category	Possible Issues
		<p>Note:</p> <p>[%1] stands for “Amount 2 Currency Code”;</p> <p>[%2] stands for UDF_CURRENCY_CD_2</p>		
C1-TXNIP	2012	<p>%1 %2 is invalid. Please enter a valid currency code.</p> <p>Note:</p> <p>[%1] stands for “Amount 3 Currency Code”;</p> <p>[%2] stands for UDF_CURRENCY_CD_3</p>	17000	<p>The possible issues could be:</p> <ul style="list-style-type: none"> • Currency is not defined in the system.
C1-TXNIP	2012	<p>%1 %2 is invalid. Please enter a valid currency code.</p> <p>Note:</p> <p>[%1] stands for “Amount 4 Currency Code”;</p> <p>[%2] stands for UDF_CURRENCY_CD_4</p>	17000	<p>The possible issues could be:</p> <ul style="list-style-type: none"> • Currency is not defined in the system.
C1-TXNIP	2012	<p>%1 %2 is invalid. Please enter a valid currency code.</p> <p>Note:</p> <p>[%1] stands for “Amount 5 Currency Code”;</p> <p>[%2] stands for UDF_CURRENCY_CD_5</p>	17000	<p>The possible issues could be:</p> <ul style="list-style-type: none"> • Currency is not defined in the system.
C1-TXNIP	2012	<p>%1 %2 is invalid. Please enter a valid currency code.</p> <p>Note:</p> <p>[%1] stands for “Amount 6 Currency Code”;</p> <p>[%2] stands for UDF_CURRENCY_CD_6</p>	17000	<p>The possible issues could be:</p> <ul style="list-style-type: none"> • Currency is not defined in the system.
C1-TXNIP	2012	<p>%1 %2 is invalid. Please enter a valid currency code.</p>	17000	<p>The possible issues could be:</p>

Batch Name	Message Number	Error Message	Message Category	Possible Issues
		<p>Note:</p> <p>[%1] stands for “Amount 7 Currency Code”;</p> <p>[%2] stands for UDF_CURRENCY_CD_7</p>		<ul style="list-style-type: none"> Currency is not defined in the system.
C1-TXNIP	2012	<p>%1 %2 is invalid. Please enter a valid currency code.</p> <p>Note:</p> <p>[%1] stands for “Amount 8 Currency Code”;</p> <p>[%2] stands for UDF_CURRENCY_CD_8</p>	17000	<p>The possible issues could be:</p> <ul style="list-style-type: none"> Currency is not defined in the system.
C1-TXNIP	2012	<p>%1 %2 is invalid. Please enter a valid currency code.</p> <p>Note:</p> <p>[%1] stands for “Amount 9 Currency Code”;</p> <p>[%2] stands for UDF_CURRENCY_CD_9</p>	17000	<p>The possible issues could be:</p> <ul style="list-style-type: none"> Currency is not defined in the system.
C1-TXNIP	2012	<p>%1 %2 is invalid. Please enter a valid currency code.</p> <p>Note:</p> <p>[%1] stands for “Amount 10 Currency Code”;</p> <p>[%2] stands for UDF_CURRENCY_CD_10</p>	17000	<p>The possible issues could be:</p> <ul style="list-style-type: none"> Currency is not defined in the system.
C1-TXNIP	2013	<p>The user %1 does not exist in the system. Please enter a valid user ID.</p> <p>Note: [%1] stands for user ID</p>	17000	<p>The possible issues could be:</p> <ul style="list-style-type: none"> The user is not defined in the system.
C1-TXNIP	2014	<p>%1 derived using %2 by the rule is invalid.</p>	17000	<p>The possible issues could be:</p> <ul style="list-style-type: none"> No value is defined for either Account Identifier (ACCT_NOX_Val) or Account Identifier Column Name (ACCT_NOX_Col) output parameter in the rule.

Batch Name	Message Number	Error Message	Message Category	Possible Issues
		<p>Note:</p> <p>[%1] stands for “Account Number”</p> <p>[%2] stands for the ACCT_NOX_Val or ACCT_NOX_Col output parameter</p>		
C1-TXNIP	2014	<p>%1 derived using %2 by the rule is invalid.</p> <p>Note:</p> <p>[%1] stands for “Account Identifier Type”</p> <p>[%2] stands for the ACCT_NO_TYPEX_Val or ACCT_NO_TYPEX_Col output parameter</p>	17000	<p>The possible issues could be:</p> <ul style="list-style-type: none"> No value is defined for either Account Identifier Type (ACCT_NO_TYPEX_Val) or Account Identifier Type Column Name (ACCT_NO_TYPEX_Col) output parameter in the rule.
C1-TXNIP	2014	<p>%1 derived using %2 by the rule is invalid.</p> <p>Note:</p> <p>[%1] stands for “Division”</p> <p>[%2] stands for the DIVISIONX_VAL or DIVISIONX_COL output parameter</p>	17000	<p>The possible issues could be:</p> <ul style="list-style-type: none"> No value is defined for either Account Division (DIVISIONX_VAL) or Account Division Column Name (DIVISIONX_COL) output parameter in the rule.
C1-TXNIP	2014	<p>%1 derived using %2 by the rule is invalid.</p> <p>Note:</p> <p>[%1] stands for “Initial Product Code”</p> <p>[%2] stands for the PRODUCTX_Y_Val or PRODUCTX_Y_Col output parameter</p>	17000	<p>The possible issues could be:</p> <ul style="list-style-type: none"> No value is defined for either Product Name (PRODUCTX_Y_Val) or Product Column Name (PRODUCTX_Y_Col) output parameter in the rule.
C1-TXNIP	2015	<p>Not able to derive account id for given Account Number %1, Account Number Type Code %2 and Division %3.</p>	17000	<p>The possible issues could be:</p> <ul style="list-style-type: none"> The account with the specified account identifier type, account identifier and division is not found in the system.

Batch Name	Message Number	Error Message	Message Category	Possible Issues
		<p>Note:</p> <p>[%1] stands for account identifier;</p> <p>[%2] stands for account identifier type;</p> <p>[%3] stands for division</p>		
C1-TXNIP	2016	<p>Length of the derived %1 using %2 by the rule is greater than %3.</p> <p>Note:</p> <p>[%1] stands for “Initial Product Code”;</p> <p>[%2] stands for PRODUCTX_Y_Val or PRODUCTX_Y_Col output parameter;</p> <p>[%3] stands for length of product code (i.e. 30)</p>	17000	<p>The possible issues could be:</p> <ul style="list-style-type: none"> The value specified for the Product Name (PRODUCTX_Y_Val) or Product Column Name (PRODUCTX_Y_Col) output parameter in the rule exceeds the maximum length of 30 characters.
C1-TXNIP	2016	<p>Length of the derived %1 using %2 by the rule is greater than %3.</p> <p>Note:</p> <p>[%1] stands for “Variance Parameter”;</p> <p>[%2] stands for TOUX_Y_Val or TOUX_Y_Col output parameter;</p> <p>[%3] stands for length of variance parameter (i.e. 8)</p>	17000	<p>The possible issues could be:</p> <ul style="list-style-type: none"> The value specified for the TOU (TOUX_Y_Val) or TOU Column Name (TOUX_Y_Col) output parameter in the rule exceeds the maximum length of 8 characters.
C1-TXNIP	2016	<p>Length of the derived %1 using %2 by the rule is greater than %3.</p>	17000	<p>The possible issues could be:</p> <ul style="list-style-type: none"> The value specified for the Parameter Code (PCDX_Y_Z_VAL) output parameter in the rule exceeds the maximum length of 30 characters.

Batch Name	Message Number	Error Message	Message Category	Possible Issues
		<p>Note:</p> <p>[%1] stands for “Parameter”;</p> <p>[%2] stands for PCDX_Y_Z_VAL output parameter;</p> <p>[%3] stands for length of parameter (i.e. 30)</p>		
C1-TXNIP	2016	<p>Length of the derived %1 using %2 by the rule is greater than %3.</p> <p>Note:</p> <p>[%1] stands for “Parameter Value”;</p> <p>[%2] stands for PVLX_Y_Z_VAL or PVLX_Y_Z_COL output parameter;</p> <p>[%3] stands for length of parameter value (i.e. 254)</p>	17000	<p>The possible issues could be:</p> <ul style="list-style-type: none"> The value specified for the Parameter Value (PVLX_Y_Z_VAL) or Parameter Value Column Name (PVLX_Y_Z_COL) output parameter in the rule exceeds the maximum length of 254 characters.
C1-TXNIP	2017	<p>Mandatory parameter %1 is missing for %2 %3 and processing date %4.</p> <p>Note:</p> <p>[%1] stands for the product parameter code;</p> <p>[%2] stands for “Initial Product Code”</p> <p>[%3] stands for the product code</p> <p>[%4] stands for the processing date</p>	17000	<p>The possible issues could be:</p> <ul style="list-style-type: none"> The mandatory product parameter is not defined as the output parameter in the rule.
C1-TXNIP	2018	<p>Value for mandatory parameter %1 is missing for product %2 and processing date %3.</p>	17000	<p>The possible issues could be:</p> <ul style="list-style-type: none"> No value is defined for the mandatory product parameter in the rule.

Batch Name	Message Number	Error Message	Message Category	Possible Issues
		<p>Note:</p> <p>[%1] stands for product parameter code;</p> <p>[%2] stands for product code;</p> <p>[%3] stands for processing date</p>		
C1-TXNIP	2019	<p>Value of the derived %1 %2 contains '~' or '='.</p> <p>Note:</p> <p>[%1] stands for parameter code</p> <p>[%2] stands for parameter value</p>	17000	<p>The possible issues could be:</p> <ul style="list-style-type: none"> The parameter code or value contains the equal to (=) and tide (~) symbols.
C1-TXNIP	2037	<p>Error during executing rules for transaction record type %1, transaction source %2 and processing date %3.</p> <p>Note:</p> <p>[%1] stands for transaction record type;</p> <p>[%2] stands for transaction source;</p> <p>[%3] stands for processing date</p>	17000	<p>The possible issues could be:</p> <ul style="list-style-type: none"> There is some technical issue while executing the rule or while processing the rule output. No rules are effective on the processing date. The rule type is not defined for the transaction source and transaction record type combination in the system.
C1-TXNIP	2043	<p>Unable to derive Rule Type with Transaction Source %1 and Transaction Record Type %2.</p> <p>Note:</p> <p>[%1] stands for transaction source;</p> <p>[%2] stands for transaction record type</p>	17000	<p>The possible issues could be:</p> <ul style="list-style-type: none"> The rule type is not defined for the transaction source and transaction record type combination in the system.
C1-TXNIP	2087	<p>Division %1 is invalid. Please enter a valid division for the transaction.</p> <p>Note: [%1] stands for division</p>	17000	<p>The possible issues could be:</p> <ul style="list-style-type: none"> Division (to which the transaction belongs) is not defined in the system.
C1-TXNVP	102	{Chunk Size} field invalid	11001	The possible issues could be:

Batch Name	Message Number	Error Message	Message Category	Possible Issues
				<ul style="list-style-type: none"> The value specified for the Chunk Size parameter is less than or equal to one.
C1-TXNVP	106	Value { Given Transaction Header Id } too long for field { transactionHeaderId }. Maximum length: 14. Found: { Length of given Transaction Header Id }	11001	<p>The possible issues could be:</p> <ul style="list-style-type: none"> The value specified for the Transaction Header ID parameter exceeds the maximum length of 14 characters.
C1-TXNVP	106	Value { Given Transaction Source Code } too long for field { transactionSource }. Maximum length: 30. Found: { Length of given Transaction Source Code }	11001	<p>The possible issues could be:</p> <ul style="list-style-type: none"> The value specified for the Transaction Source parameter exceeds the maximum length of 30 characters.
C1-TXNVP	106	Value { Given Transaction Division } too long for field { division }. Maximum length: 5 Found: { Length of given Transaction Division }	11001	<p>The possible issues could be:</p> <ul style="list-style-type: none"> The value specified for the Division parameter exceeds the maximum length of 5 characters.
C1-TXNVP	1636	<p>Invalid batch run [% 1] for [%2] division(s). %3</p> <div style="border: 1px solid black; padding: 5px;"> <p>Note: [%1] stands for batch code; [%2] stands for division; [%3] stands for expected batch code</p> </div>	17000	<p>The possible issues could be:</p> <ul style="list-style-type: none"> You are trying to execute the C1-TXNVP batch before executing the C1-TXNIP batch (which is first mandatory batch in the transaction aggregation cycle). You are trying to execute the C1-TXNVP batch in between the C1-TXNCM and C1-TXNCU batches during the transaction aggregation cycle.
C1-TXNVP	1638	Transaction Feed Management cycle for individual division(s) is not yet complete. Please complete pending batch runs before starting new cycle for processing [ALL] divisions.	17000	<p>The possible issues could be:</p> <ul style="list-style-type: none"> You are trying to execute this batch for all divisions before completing the transaction aggregation cycle which is initiated for a particular division.
C1-TXNVP	1639	<p>Transaction Feed Management cycle for [ALL] divisions is not yet complete. Please complete pending batch runs before starting new cycle for individual division [% 1].</p> <div style="border: 1px solid black; padding: 5px;"> <p>Note: [% 1] stands for division</p> </div>	17000	<p>The possible issues could be:</p> <ul style="list-style-type: none"> You are trying to execute this batch for a particular division before completing the transaction aggregation cycle which is initiated for all divisions.
C1-TXNVP	1644	Transaction Feed Management cycle for division(s) [% 1] is	17000	<p>The possible issues could be:</p>

Batch Name	Message Number	Error Message	Message Category	Possible Issues
		<p>already in progress with filter [Source= %2, Header= %3] criteria. Filter criteria must be same for complete cycle.</p> <p>Note: [%1] stands for division; [%2] stands for transaction source; [%3] stands for transaction header ID</p>		<ul style="list-style-type: none"> You are trying to execute this batch once again with the same division and different parameters.
C1-TXNEX	102	{Chunk Size} field invalid	11001	<p>The possible issues could be:</p> <ul style="list-style-type: none"> The value specified for the Chunk Size parameter is less than or equal to one.
C1-TXNEX	102	{ Maximum Batch Size } field invalid	11001	<p>The possible issues could be:</p> <ul style="list-style-type: none"> The value specified for the Maximum Batch Count parameter is greater than the value specified for the Chunk Size parameter.
C1-TXNEX	106	Value { Given Transaction Header Id } too long for field { transactionHeaderId }. Maximum length: 14. Found: { Length of given Transaction Header Id }	11001	<p>The possible issues could be:</p> <ul style="list-style-type: none"> The value specified for the Transaction Header ID parameter exceeds the maximum length of 14 characters.
C1-TXNEX	106	Value { Given Transaction Source Code } too long for field { transactionSource }. Maximum length: 30. Found: { Length of given Transaction Source Code }	11001	<p>The possible issues could be:</p> <ul style="list-style-type: none"> The value specified for the Transaction Source parameter exceeds the maximum length of 30 characters.
C1-TXNEX	106	Value { Given Transaction Division } too long for field { division }. Maximum length: 5 Found: { Length of given Transaction Division }	11001	<p>The possible issues could be:</p> <ul style="list-style-type: none"> The value specified for the Division parameter exceeds the maximum length of 5 characters.
C1-TXNEX	790	The selected Member account does not have active Contracts.	17000	<p>The possible issues could be:</p> <ul style="list-style-type: none"> There are no contracts for the account in Active, Pending Stop, or Stop status on the transaction date.
C1-TXNEX	1336	Effective pricing is not available for the product. Please check.	17000	<p>The possible issues could be:</p> <ul style="list-style-type: none"> The effective pricing is not available for the product.

Batch Name	Message Number	Error Message	Message Category	Possible Issues
C1-TXNEX	1392	Invalid configuration of Price Search Algorithm Parameters or Contracts or Schedule Periods.	17000	The possible issues could be: <ul style="list-style-type: none"> The parameter values are either not defined or invalid in the Price Assignment Search algorithm (which is associated with the division). The period in which the transaction date falls is not defined in the aggregation schedule. There are multiple effective contracts of the same contract type (available on the transaction date) in Active, Pending Stop, or Stop status.
C1-TXNEX	1556	{Maximum Batch Size} field should be greater than zero	17000	The possible issues could be: <ul style="list-style-type: none"> The value specified for the Maximum Batch Count parameter is less than or equal to zero.
C1-TXNEX	1588	No Schedule Period found for the transaction date.	17000	The possible issues could be: <ul style="list-style-type: none"> The period in which the transaction date falls is not defined in the aggregation schedule.
C1-TXNEX	1611	Division specific Price Search Algorithm is not configured.	17000	The possible issues could be: <ul style="list-style-type: none"> The Price Assignment Search algorithm is not defined for the division.
C1-TXNEX	1612	Price Search Algorithm parameters are not set or are invalid.	17000	The possible issues could be: <ul style="list-style-type: none"> The parameter values are either not defined or invalid in the Price Assignment Search algorithm (which is associated with the division).
C1-TXNEX	1613	Multiple contracts in Active, Pending Stop, Stop status exists for same contract type.	17000	The possible issues could be: <ul style="list-style-type: none"> There are multiple effective contracts of the same contract type in Active, Pending Stop, or Stop status on the transaction date.
C1-TXNEX	1636	Invalid batch run [% 1] for [%2] division(s). %3	17000	The possible issues could be: <ul style="list-style-type: none"> You are trying to execute the C1-TXNEX batch before executing the C1-TXNIP batch (which is first mandatory batch in the transaction aggregation cycle).

Batch Name	Message Number	Error Message	Message Category	Possible Issues
		<p>Note:</p> <p>[%1] stands for batch code;</p> <p>[%2] stands for division;</p> <p>[%3] stands for expected batch code</p>		<ul style="list-style-type: none"> You are trying to execute the C1-TXNEX batch in between the C1-TXNCM and C1-TXNCU batches during the transaction aggregation cycle.
C1-TXNEX	1638	Transaction Feed Management cycle for individual division(s) is not yet complete. Please complete pending batch runs before starting new cycle for processing [ALL] divisions.	17000	<p>The possible issues could be:</p> <ul style="list-style-type: none"> You are trying to execute this batch for all divisions before completing the transaction aggregation cycle which is initiated for a particular division.
C1-TXNEX	1639	Transaction Feed Management cycle for [ALL] divisions is not yet complete. Please complete pending batch runs before starting new cycle for individual division [%1].	17000	<p>The possible issues could be:</p> <ul style="list-style-type: none"> You are trying to execute this batch for a particular division before completing the transaction aggregation cycle which is initiated for all divisions.
		<p>Note: [%1] stands for division</p>		
C1-TXNEX	1644	Transaction Feed Management cycle for division(s) [%1] is already in progress with filter [Source= %2, Header= %3] criteria. Filter criteria must be same for complete cycle.	17000	<p>The possible issues could be:</p> <ul style="list-style-type: none"> You are trying to execute this batch once again with the same division and different parameters.
		<p>Note:</p> <p>[%1] stands for division;</p> <p>[%2] stands for transaction source;</p> <p>[%3] stands for transaction header ID</p>		
C1-TXNIP	2003	One or more Sub Transactions are in EROR state.	17000	<p>The possible issues could be:</p> <ul style="list-style-type: none"> One or more transaction legs are in the Error (EROR) status.
C1-TXNEX	2006	No active contract exists for account %1, product %2 and transaction date %3.	17000	<p>The possible issues could be:</p> <ul style="list-style-type: none"> There is no contract with the specified contract type available on the transaction date. The contract is inactive.
		<p>Note: [%1] stands for derived account; [%2] stands for derived product; and [%3] stands for transaction date</p>		

Batch Name	Message Number	Error Message	Message Category	Possible Issues
C1-TXNEX	2020	<p>Invalid configuration of Price Search Algorithm Parameters or Contracts or Schedule Periods for division %1, account %2, product %3, transaction date %4 and processing date %5.</p> <p>Note: [%1] stands for derived division; [%2] stands for derived account; [%3] stands for derived product; [%4] stands for transaction date; [%5] stands for processing date</p>	17000	<p>The possible issues could be:</p> <ul style="list-style-type: none"> The parameter values are either not defined or invalid in the Price Assignment Search algorithm (which is associated with the division). The period in which the transaction date falls is not defined in the aggregation schedule. There are multiple effective contracts of the same contract type (available on the transaction date) in Active, Pending Stop, or Stop status.
C1-TXNEX	2021	<p>Division specific Price Search Algorithm is not configured for division %1 and processing date %2.</p> <p>Note: [%1] stands for derived division; [%2] stands for processing date</p>	17000	<p>The possible issues could be:</p> <ul style="list-style-type: none"> The Price Assignment Search algorithm is not defined for the derived division on the processing date.
C1-TXNEX	2022	<p>Price Search Algorithm parameters are not set or are invalid for division %1 and processing date %2.</p> <p>Note: [%1] stands for derived division; [%2] stands for processing date</p>	17000	<p>The possible issues could be:</p> <ul style="list-style-type: none"> The parameter values are either not defined or invalid in the Price Assignment Search algorithm which is associated with the derived division on the processing date.
C1-TXNEX	2023	<p>Effective pricing is not available for account %1, product %2, parameters %3 and processing date %4.</p>	17000	<p>The possible issues could be:</p> <ul style="list-style-type: none"> The effective pricing is not available for the account, product and product parameters combination on the processing date.

Batch Name	Message Number	Error Message	Message Category	Possible Issues
		<p>Note:</p> <p>[%1] stands for derived account;</p> <p>[%2] stands for derived product;</p> <p>[%3] stands for derived product parameter;</p> <p>[%4] stands for processing date</p>		
C1-TXNEX	2024	<p>No Schedule Period found for product %1, price assignment id %2 and transaction date %3.</p> <p>Note:</p> <p>[%1] stands for derived product;</p> <p>[%2] stands for price assignment ID;</p> <p>[%3] stands for transaction date</p>	17000	<p>The possible issues could be:</p> <ul style="list-style-type: none"> The period in which the transaction date falls is not defined in the aggregation schedule (which is used in the product pricing).
C1-TXNEX	2025	<p>Multiple contracts in Active, Pending Stop, Stop status exists for same contract type against account %1, product %2 and transaction date %3.</p> <p>Note:</p> <p>[%1] stands for derived account;</p> <p>[%2] stands for derived product;</p> <p>[%3] stands for transaction date</p>	17000	<p>The possible issues could be:</p> <ul style="list-style-type: none"> There are multiple effective contracts of the same contract type in Active, Pending Stop, or Stop status on the transaction date.
C1-TXNEX	2026	<p>No active contract exists for account %1, product %2 and transaction date %3.</p> <p>Note:</p> <p>[%1] stands for derived account;</p> <p>[%2] stands for derived product;</p> <p>[%3] stands for transaction date</p>	17000	<p>The possible issues could be:</p> <ul style="list-style-type: none"> There are no contracts for the account in Active, Pending Stop, or Stop status on the transaction date.

Batch Name	Message Number	Error Message	Message Category	Possible Issues
C1-TXNSQ	102	{ Maximum Batch Size } field invalid	11001	The possible issues could be: <ul style="list-style-type: none"> The value specified for the Maximum Batch Count parameter is greater than the value specified for the Chunk Size parameter.
C1-TXNSQ	102	{ Chunk Size } field invalid	11001	The possible issues could be: <ul style="list-style-type: none"> The value specified for the Chunk Size parameter is less than or equal to one.
C1-TXNSQ	106	Value { Given Transaction Header Id } too long for field { transactionHeaderId }. Maximum length: 14. Found: { Length of given Transaction Header Id }	11001	The possible issues could be: <ul style="list-style-type: none"> The value specified for the Transaction Header ID parameter exceeds the maximum length of 14 characters.
C1-TXNSQ	106	Value { Given Transaction Source Code } too long for field { transactionSource }. Maximum length: 30. Found: { Length of given Transaction Source Code }	11001	The possible issues could be: <ul style="list-style-type: none"> The value specified for the Transaction Source parameter exceeds the maximum length of 30 characters.
C1-TXNSQ	106	Value { Given Transaction Division } too long for field { division }. Maximum length: 5 Found: { Length of given Transaction Division }	11001	The possible issues could be: <ul style="list-style-type: none"> The value specified for the Division parameter exceeds the maximum length of 5 characters.
C1-TXNSQ	1388	Data configuration error for { ENV_ID }.	17000	The possible issues could be: <ul style="list-style-type: none"> No data exists in the ENV_ID column of the CI_INSTALLATION table. The data available in the ENV_ID column of the CI_INSTALLATION table is not properly cached.
C1-TXNSQ	1388	Data configuration error for { SQI Fragment }.	17000	The possible issues could be: <ul style="list-style-type: none"> No data exists in the SQL_FRAG, TXN_PRM, SQI_CD, and SQL_FUNC columns of the CI_TXN_SQI_FRAG table. The data available in the SQL_FRAG, TXN_PRM, SQI_CD, and SQL_FUNC columns of the CI_TXN_SQI_FRAG table is not properly cached.

Batch Name	Message Number	Error Message	Message Category	Possible Issues
C1-TXNSQ	1388	Data configuration error for { Price Item SQI }.	17000	The possible issues could be: <ul style="list-style-type: none"> No data exists in the PRICEITEM_CD, CIS_DIVISION, and SQL_CD columns of the CI_PRICEITEM_SQI table. The data available in the PRICEITEM_CD, CIS_DIVISION, and SQL_CD columns of the CI_PRICEITEM_SQI table is not properly cached.
C1-TXNSQ	1556	{Maximum Batch Size} field should be greater than zero	17000	The possible issues could be: <ul style="list-style-type: none"> The value specified for the Maximum Batch Count parameter is less than or equal to zero.
C1-TXNSQ	1636	Invalid batch run [%1] for [%2] division(s). %3 Note: [%1] stands for batch code; [%2] stands for division; [%3] stands for expected batch code	17000	The possible issues could be: <ul style="list-style-type: none"> You are trying to execute the C1-TXNSQ batch before executing the C1-TXNIP batch (which is first mandatory batch in the transaction aggregation cycle). You are trying to execute the C1-TXNSQ batch in between the C1-TXNCM and C1-TXNCU batches during the transaction aggregation cycle.
C1-TXNSQ	1638	Transaction Feed Management cycle for individual division(s) is not yet complete. Please complete pending batch runs before starting new cycle for processing [ALL] divisions.	17000	The possible issues could be: <ul style="list-style-type: none"> You are trying to execute this batch for all divisions before completing the transaction aggregation cycle which is initiated for a particular division.
C1-TXNSQ	1639	Transaction Feed Management cycle for [ALL] divisions is not yet complete. Please complete pending batch runs before starting new cycle for individual division [%1]. Note: [%1] stands for division	17000	The possible issues could be: <ul style="list-style-type: none"> You are trying to execute this batch for a particular division before completing the transaction aggregation cycle which is initiated for all divisions.
C1-TXNSQ	1644	Transaction Feed Management cycle for division(s) [%1] is already in progress with filter [Source= %2, Header= %3]	17000	The possible issues could be: <ul style="list-style-type: none"> You are trying to execute this batch once again with the same division and different parameters.

Batch Name	Message Number	Error Message	Message Category	Possible Issues
		<p>criteria. Filter criteria must be same for complete cycle.</p> <p>Note: [%1] stands for division; [%2] stands for transaction source; [%3] stands for transaction header ID</p>		
C1-TXNSQ	2003	One or more Sub Transactions are in EROR state.	17000	<p>The possible issues could be:</p> <ul style="list-style-type: none"> One or more transaction legs are in the Error (EROR) status.
C1-TXNSQ	2026	<p>SQIs not configured for product %1 and division %2.</p> <p>Note: [%1] stands for final product code; [%2] stands for derived division</p>	17000	<p>The possible issues could be:</p> <ul style="list-style-type: none"> The SQIs are not defined for the product — division combination.
C1-TXNSQ	2027	Currency Conversion from Currency [%1] to Currency [%2] not successful.	17000	<p>The possible issues could be:</p> <ul style="list-style-type: none"> The exchange rate is not available during currency conversion.
C1-TXNCM	102	{ Chunk Size } field invalid	11001	<p>The possible issues could be:</p> <ul style="list-style-type: none"> The value specified for the Chunk Size parameter is less than or equal to one.
C1-TXNCM	102	{ Maximum Batch Size } field invalid	11001	<p>The possible issues could be:</p> <ul style="list-style-type: none"> The value specified for the Maximum Batch Count parameter is greater than the value specified for the Chunk Size parameter.
C1-TXNCM	106	Value { Given Transaction Header Id } too long for field { transactionHeaderId }. Maximum length: 14. Found: { Length of given Transaction Header Id }	11001	<p>The possible issues could be:</p> <ul style="list-style-type: none"> The value specified for the Transaction Header ID parameter exceeds the maximum length of 14 characters.
C1-TXNCM	106	Value { Given Transaction Source Code } too long for field { transactionSource }. Maximum length: 30. Found:	11001	<p>The possible issues could be:</p> <ul style="list-style-type: none"> The value specified for the Transaction Source parameter

Batch Name	Message Number	Error Message	Message Category	Possible Issues
		{ Length of given Transaction Source Code }		exceeds the maximum length of 30 characters.
C1-TXNCM	106	Value { Given Transaction Division } too long for field { division }. Maximum length: 5 Found: { Length of given Transaction Division }	11001	The possible issues could be: <ul style="list-style-type: none"> The value specified for the Division parameter exceeds the maximum length of 5 characters.
C1-TXNCM	1393	Either the transaction feed management setup is incomplete, or there is no active contract available.	17000	The possible issues could be: <ul style="list-style-type: none"> The SQIs are not defined for the product — division combination. The transaction aggregation rule is not defined for the SQI. There is no contract with the specified contract type available in the system. The contract is inactive.
C1-TXNCM	1556	{Maximum Batch Size} field should be greater than zero	17000	The possible issues could be: <ul style="list-style-type: none"> The value specified for the Maximum Batch Count parameter is less than or equal to zero.
C1-TXNCM	1636	Invalid batch run [% 1] for [%2] division(s). %3 Note: [%1] stands for batch code; [%2] stands for division; [%3] stands for expected batch code	17000	The possible issues could be: <ul style="list-style-type: none"> You are trying to execute the C1-TXNCM batch before executing the C1-TXNIP batch.
C1-TXNCM	1638	Transaction Feed Management cycle for individual division(s) is not yet complete. Please complete pending batch runs before starting new cycle for processing [ALL] divisions.	17000	The possible issues could be: <ul style="list-style-type: none"> You are trying to execute this batch for all divisions before completing the transaction aggregation cycle which is initiated for a particular division.
C1-TXNCM	1639	Transaction Feed Management cycle for [ALL] divisions is not yet complete. Please complete pending batch runs before starting new cycle for individual division [%1]. Note: [% 1] stands for division	17000	The possible issues could be: <ul style="list-style-type: none"> You are trying to execute this batch for a particular division before completing the transaction aggregation cycle which is initiated for all divisions.

Batch Name	Message Number	Error Message	Message Category	Possible Issues
C1-TXNCM	1644	Transaction Feed Management cycle for division(s) [%1] is already in progress with filter [Source= %2, Header= %3] criteria. Filter criteria must be same for complete cycle. Note: [%1] stands for division; [%2] stands for transaction source; [%3] stands for transaction header ID	17000	The possible issues could be: <ul style="list-style-type: none"> You are trying to execute this batch once again with the same division and different parameters.
C1-TXNCM	2003	One or more Sub Transactions are in EROR state.	17000	The possible issues could be: <ul style="list-style-type: none"> One or more transaction legs are in the Error (EROR) status.
C1-TXNCM	2026	SQIs not configured for product %1 and division %2. Note: [%1] stands for final product code; [%2] stands for derived division	17000	The possible issues could be: <ul style="list-style-type: none"> The SQIs are not defined for the product — division combination.
C1-TXNCM	2027	Currency Conversion from Currency [%1] to Currency [%2] not successful.	17000	The possible issues could be: <ul style="list-style-type: none"> The exchange rate is not available during currency conversion.
C1-TXNCU	101	{ Disaggregation From Date } field missing	11001	The possible issues could be: <ul style="list-style-type: none"> No value is specified for the Disaggregate Transactions From Date parameter when the request type is set to DISAGG.
C1-TXNCU	101	{ Request Type } field missing	11001	The possible issues could be: <ul style="list-style-type: none"> No value is specified for the Request Type parameter.
C1-TXNCU	101	{ Transaction Header Id } field missing	11001	The possible issues could be: <ul style="list-style-type: none"> No value is specified for the Transaction Header ID parameter when the request type is set to CNCL.
C1-TXNCU	102	{ Chunk Size } field invalid	11001	The possible issues could be:

Batch Name	Message Number	Error Message	Message Category	Possible Issues
				<ul style="list-style-type: none"> The value specified for the Chunk Size parameter is less than or equal to one.
C1-TXNCU	102	{ Maximum Batch Size } field invalid	11001	<p>The possible issues could be:</p> <ul style="list-style-type: none"> The value specified for the Maximum Batch Count parameter is greater than the value specified for the Chunk Size parameter.
C1-TXNCU	102	{ Request Type } field invalid	11001	<p>The possible issues could be:</p> <ul style="list-style-type: none"> The value other than 'EROR', 'CNCL' or 'DISAGG' is specified for the Request Type parameter.
C1-TXNCU	102	{ Transaction Division } field invalid	11001	<p>The possible issues could be:</p> <ul style="list-style-type: none"> The value for the Division parameter is specified when the request type is set to CNCL.
C1-TXNCU	102	{ Transaction Source Code } field invalid	11001	<p>The possible issues could be:</p> <ul style="list-style-type: none"> The value for the Transaction Source parameter is specified when the request type is set to CNCL.
C1-TXNCU	102	{ Account Id } field invalid	11001	<p>The possible issues could be:</p> <ul style="list-style-type: none"> The value for the Account ID parameter is specified when the request type is set to CNCL.
C1-TXNCU	102	{ Bill Cycle Code } field invalid	11001	<p>The possible issues could be:</p> <ul style="list-style-type: none"> The value for the Bill Cycle parameter is specified when the request type is set to CNCL.
C1-TXNCU	102	{ Disaggregation From Date } field invalid	11001	<p>The possible issues could be:</p> <ul style="list-style-type: none"> The value for the Disaggregate Transactions From Date parameter is specified when the request type is set to CNCL.
C1-TXNCU	102	{ Account Id } field invalid	11001	<p>The possible issues could be:</p> <ul style="list-style-type: none"> The value for the Account ID parameter is specified when the request type is set to EROR.
C1-TXNCU	102	{ Bill Cycle Code } field invalid	11001	<p>The possible issues could be:</p> <ul style="list-style-type: none"> The value for the Bill Cycle parameter is specified when the request type is set to EROR.

Batch Name	Message Number	Error Message	Message Category	Possible Issues
C1-TXNCU	102	{Disaggregation From Date } field invalid	11001	The possible issues could be: <ul style="list-style-type: none"> The value for the Disaggregate Transactions From Date parameter is specified when the request type is set to EROR.
C1-TXNCU	102	{Transaction Header Id } field invalid	11001	The possible issues could be: <ul style="list-style-type: none"> The value for the Transaction Header ID parameter is specified when the request type is set to DISAGG.
C1-TXNCU	102	{ Transaction Source Code } field invalid	11001	The possible issues could be: <ul style="list-style-type: none"> The value for the Transaction Source parameter is specified when the request type is set to DISAGG.
C1-TXNCU	106	Value { Given Transaction Header Id } too long for field { transactionHeaderId }. Maximum length: 14. Found: { Length of given Transaction Header Id}	11001	The possible issues could be: <ul style="list-style-type: none"> The value specified for the Transaction Header ID parameter exceeds the maximum length of 14 characters.
C1-TXNCU	106	Value { Given Transaction Source Code } too long for field { transactionSource }. Maximum length: 30. Found: { Length of given Transaction Source Code}	11001	The possible issues could be: <ul style="list-style-type: none"> The value specified for the Transaction Source parameter exceeds the maximum length of 30 characters.
C1-TXNCU	106	Value { Given Transaction Division } too long for field { division }. Maximum length: 5 Found: { Length of given Transaction Division}	11001	The possible issues could be: <ul style="list-style-type: none"> The value specified for the Division parameter exceeds the maximum length of 5 characters.
C1-TXNCU	1388	Data configuration error for { SQL Fragment }.	17000	The possible issues could be: <ul style="list-style-type: none"> No data exists in the SQL_FRAG, TXN_PRM, SQL_CD, and SQL_FUNC columns of the CI_TXN_SQL_FRAG table. The data available in the SQL_FRAG, TXN_PRM, SQL_CD, and SQL_FUNC columns of the CI_TXN_SQL_FRAG table is not properly cached.
C1-TXNCU	1388	Data configuration error for { Price Item SQI }.	17000	The possible issues could be: <ul style="list-style-type: none"> No data exists in the PRICEITEM_CD, CIS_DIVISION,

Batch Name	Message Number	Error Message	Message Category	Possible Issues
				<p>and <code>SQL_CD</code> columns of the <code>CI_PRICEITEM_SQI</code> table.</p> <ul style="list-style-type: none"> The data available in the <code>PRICEITEM_CD</code>, <code>CIS_DIVISION</code>, and <code>SQL_CD</code> columns of the <code>CI_PRICEITEM_SQI</code> table is not properly cached.
C1-TXNCU	1391	Bill is completed hence cant cancel the header.	17000	<p>The possible issues could be:</p> <ul style="list-style-type: none"> You are trying to cancel a transaction feed for which a bill with the Complete status already exists in the system.
C1-TXNCU	1424	There are pending bills for the feed you want to cancel. Please execute the Pending Bill Deletion (C1-DELBL) batch.	17000	<p>The possible issues could be:</p> <ul style="list-style-type: none"> The Pending Bill Deletion (C1-DELBL) batch is not yet executed to delete the bills (generated for the feed) which are in the Pending status.
C1-TXNCU	1556	{Maximum Batch Size} field should be greater than zero	17000	<p>The possible issues could be:</p> <ul style="list-style-type: none"> The value specified for the Maximum Batch Count parameter is less than or equal to zero.
C1-TXNCU	1636	<p>Invalid batch run [% 1] for [%2] division(s). %3</p> <div style="border: 1px solid black; padding: 5px; margin-top: 5px;"> <p>Note:</p> <p>[% 1] stands for batch code;</p> <p>[%2] stands for division;</p> <p>[%3] stands for expected batch code</p> </div>	17000	<p>The possible issues could be:</p> <ul style="list-style-type: none"> You are trying to execute the C1-TXNCU batch before executing the C1-TXNIP or C1-TXNCM batch.
C1-TXNCU	1638	Transaction Feed Management cycle for individual division(s) is not yet complete. Please complete pending batch runs before starting new cycle for processing [ALL] divisions.	17000	<p>The possible issues could be:</p> <ul style="list-style-type: none"> You are trying to execute this batch for all divisions before completing the transaction aggregation cycle which is initiated for a particular division.
C1-TXNCU	1639	Transaction Feed Management cycle for [ALL] divisions is not yet complete. Please complete pending batch runs before starting new cycle for individual division [% 1].	17000	<p>The possible issues could be:</p> <ul style="list-style-type: none"> You are trying to execute this batch for a particular division before completing the transaction aggregation cycle which is initiated for all divisions.

Batch Name	Message Number	Error Message	Message Category	Possible Issues
		Note: [% 1] stands for division		
C1-TXNCU	1644	Transaction Feed Management cycle for division(s) [%1] is already in progress with filter [Source= %2, Header= %3] criteria. Filter criteria must be same for complete cycle. Note: [%1] stands for division; [%2] stands for transaction source; [%3] stands for transaction header ID	17000	The possible issues could be: <ul style="list-style-type: none"> You are trying to execute this batch once again with the same division and different parameters.
C1-TXNRB	102	{ Chunk Size } field invalid	11001	The possible issues could be: <ul style="list-style-type: none"> The value specified for the Chunk Size parameter is less than or equal to one.
C1-TXNRB	102	{ Maximum Batch Size } field invalid	11001	The possible issues could be: <ul style="list-style-type: none"> The value specified for the Maximum Batch Count parameter is greater than the value specified for the Chunk Size parameter.
C1-TXNRB	102	{ Status Value } field invalid	11001	The possible issues could be: <ul style="list-style-type: none"> The value other than 'ERROR' or 'IGNR' is specified for the Transaction Status parameter.
C1-TXNRB	102	{ RollBack From Date } field invalid	11001	The possible issues could be: <ul style="list-style-type: none"> The date specified in the Rollback From Date parameter is later than the date specified in the Rollback To Date parameter.
C1-TXNRB	1556	{Maximum Batch Size} field should be greater than zero	17000	The possible issues could be: <ul style="list-style-type: none"> The value specified for the Maximum Batch Count parameter is less than or equal to zero.
C1-DELBL	101	{ Transaction Header Id } field missing	11001	The possible issues could be: <ul style="list-style-type: none"> No value is specified for the Transaction Header ID parameter.
C1-DELBL	102	{ Chunk Size } field invalid	11001	The possible issues could be:

Batch Name	Message Number	Error Message	Message Category	Possible Issues
				<ul style="list-style-type: none"> The value specified for the Chunk Size parameter is less than or equal to one.
C1-DELBL	106	Value { Given Transaction Header Id } too long for field { transactionHeaderId }. Maximum length: 14. Found: { Length of given Transaction Header Id }	11001	<p>The possible issues could be:</p> <ul style="list-style-type: none"> The value specified for the Transaction Header ID parameter exceeds the maximum length of 14 characters.
C1-DELBL	1391	Bill is completed or bill segment is frozen or pending-cancelled hence can not cancel the header.	17000	<p>The possible issues could be:</p> <ul style="list-style-type: none"> You are trying to cancel a transaction feed for which a bill with the Pending status is already generated in the system. This pending bill has a bill segment in either Frozen or Pending Cancel status.
C1-DELBL	1556	{Maximum Batch Size} field should be greater than zero	17000	<p>The possible issues could be:</p> <ul style="list-style-type: none"> The value specified for the Maximum Batch Count parameter is less than or equal to zero.
C1-TXCNC	101	{ Transaction Header Id } field missing	11001	<p>The possible issues could be:</p> <ul style="list-style-type: none"> No value is specified for the Transaction Header ID parameter.
C1-TXCNC	102	{Chunk Size} field invalid	11001	<p>The possible issues could be:</p> <ul style="list-style-type: none"> The value specified for the Chunk Size parameter is less than or equal to one.
C1-TXCNC	102	{ Maximum Batch Size } field invalid	11001	<p>The possible issues could be:</p> <ul style="list-style-type: none"> The value specified for the Maximum Batch Count parameter is greater than the value specified for the Chunk Size parameter.
C1-TXCNC	1391	Bill is completed or bill segment is frozen or pending-cancelled hence can not cancel the header.	17000	<p>The possible issues could be:</p> <ul style="list-style-type: none"> You are trying to cancel a transaction feed for which a bill with the Pending status is already generated in the system. This pending bill has a bill segment in either Frozen or Pending Cancel status.
C1-TXCNC	1424	There are pending bills for the feed you want to cancel. Please execute the Pending Bill Deletion (C1-DELBL) batch.	17000	<p>The possible issues could be:</p> <ul style="list-style-type: none"> The Pending Bill Deletion (C1-DELBL) batch is not yet executed to delete the bills (generated for

Batch Name	Message Number	Error Message	Message Category	Possible Issues
				the feed) which are in the Pending status.
C1-TXCNC	1556	{Maximum Batch Size} field should be greater than zero	17000	The possible issues could be: <ul style="list-style-type: none"> The value specified for the Maximum Batch Count parameter is less than or equal to zero.
C1-DISTG	102	{Division} field invalid	11001	The possible issues could be: <ul style="list-style-type: none"> Division is not defined in the system.
C1-DISTG	102	{ Billing Cycle Code } field invalid	11001	The possible issues could be: <ul style="list-style-type: none"> Bill cycle is not defined in the system.
C1-IDENT	102	{Chunk Size} field invalid	11001	The possible issues could be: <ul style="list-style-type: none"> The value specified for the Chunk Size parameter is less than or equal to one.
C1-IDENT	1660	Disaggregate Transactions From Date would impose partial disaggregation for some billable charges	17000	The possible issues could be: <ul style="list-style-type: none"> The identified aggregated billable charges aggregate transactions whose transaction date falls before the disaggregate transactions from date.
C1-DRSUA	102	{Chunk Size} field invalid	11001	The possible issues could be: <ul style="list-style-type: none"> The value specified for the Chunk Size parameter is less than or equal to one.
C1-DRSUA	102	{Chunk Size} field invalid	11001	The possible issues could be: <ul style="list-style-type: none"> The value specified for the Chunk Size parameter is less than or equal to one.
C1-PDTXN	102	{Chunk Size} field invalid	11001	The possible issues could be: <ul style="list-style-type: none"> The value specified for the Chunk Size parameter is less than or equal to one.
C1-PDTXN	102	{ Maximum Batch Size } field invalid	11001	The possible issues could be: <ul style="list-style-type: none"> The value specified for the Maximum Batch Count parameter is greater than the value specified for the Chunk Size parameter.
C1-PDTXN	1556	{Maximum Batch Size} field should be greater than zero	17000	The possible issues could be:

Batch Name	Message Number	Error Message	Message Category	Possible Issues
				<ul style="list-style-type: none"> The value specified for the Maximum Batch Count parameter is less than or equal to zero.

Alert Notification for Transaction Feed Management

Oracle Revenue Management and Billing enables you to configure alert notification for the **Transaction Feed Management** feature. At present, the system supports the following two alert notifications:

- To Do Creation
- Email Notification

The objective of these notifications is to create an alert for the records which are in the **Ignored** or **Error** status. Once a To Do is created, it indicates the number of records which are in the **Ignored** or **Error** status. However, the email notification provides the error summary statistics.

A new batch named **C1-ERRAL** is introduced in this release. While executing the **C1-ERRAL** batch, you need to set the **To Do Created For** parameter to **TFM**. In addition, you need to specify the transaction status (for example, EROR or IGNR) for which you want to create an alert notification. On executing the **C1-ERRAL** batch, the system creates a To Do using the **C1-TXNER** To Do type.

The **C1-ERRAL** batch must be executed only after all the transaction feed management batches are executed successfully. If the **C1-ERRAL** batch is executed for the first time, the system considers all the transactions whose **CURR_SYS_PRS_DT** is earlier than or equal to the batch business date. However, in the subsequent execution, the system considers only those transactions whose **CURR_SYS_PRS_DT** is later than the last To Do generation date and earlier than or equal to the batch business date.

On clicking the To Do notification in the **To Do List** screen, you can view the error records in the **Feed Management Dashboard** screen. Note that the system will not create a new To Do when the To Do for the same drill key combination already exists in the **Open** status.

To create an email notification, you need to attach an algorithm which is created using the **C1-TFMERREML** algorithm type to the **To Do Post-Processing** system event of the **C1-TXNER** To Do type. On creating a To Do, the batch creates an email outbound message which contains the error summary statistics.

Feed Management Dashboard

The **Feed Management Dashboard** screen allows you to view the details of a transaction feed. It allows you to drill down and view:

- Transaction volume details of a feed at the division level
- Transactions in a feed which belong to a division
- Legs of a transaction
- SQIs which are associated with the price item-division combination to which a transaction is mapped
- Calculation lines generated for a transaction leg
- Characteristics of each calculation line

The **Feed Management Dashboard** screen contains the following zones:

- [Search](#) on page 1079
- [Division Level Information](#) on page 1085

- [Transaction Level Information](#) on page 1086
- [Transaction Leg Information](#) on page 1087
- [Transaction Leg Service Quantity](#) on page 1088
- [Transaction Leg Calculation Lines](#) on page 1089
- [Transaction Leg Calc Line Characteristics](#) on page 1090

Search

The **Search** zone allows you to search for a transaction feed using various search criteria. It also allows you to view the details of a transaction feed which is already uploaded in the system. It contains the following two sections:

- **Search Criteria** - The **Search Criteria** section contains the following fields:

Field Name	Field Description	Mandatory (Yes or No)
Search By	Used to indicate whether you want to search for the transaction volume details of a feed at the division level or transaction level. The valid values are: <ul style="list-style-type: none"> • Feed Level Details - Used to indicate that you want to search for the transaction volume details of a feed at the division level. • Transaction Level Details - Used to indicate that you want to search for the transaction volume details of a feed at the transaction level. 	Yes (Conditional)
	Note: By default, the Feed Level Details option is selected.	Note: This field is required for searching the transaction volume details at the division or transaction level.
Feed Header Date From	Used to search for transaction feeds having header date later than or equal to the specified date.	No
Transaction Source	Used to search for transaction feeds received from a particular transaction source.	No
Feed Header Date To	Used to search for transaction feeds having header date earlier than or equal to the specified date.	No
File Name	Used to search for a transaction feed based on the file name.	No
Feed Load Date From	Used to search for transaction feeds which are uploaded on or later than the specified date.	No
Transaction Header ID	Used to search for a transaction feed based on the header ID.	No
Feed Load Date To	Used to search for transaction feeds which are uploaded on or earlier than the specified date.	No
Account Identifier Type	Used to indicate the identifier type based on which you want to search transaction feed details of an account.	Yes (Conditional)

Field Name	Field Description	Mandatory (Yes or No)
	Note: This field appears when you select the Transaction Level Details option from the Search By field.	Note: If you enter the primary account identifier as a search criteria, you have to select the account identifier type.
Primary Account Identifier	Used to search transaction feed for a particular account. Note: This field appears when you select the Transaction Level Details option from the Search By field.	Yes (Conditional) Note: If you select the account identifier type as a search criteria, you have to enter the primary account identifier.
Transaction Record Type	Used to search transaction feeds for transactions with a particular record type. Note: This field appears when you select the Transaction Level Details option from the Search By field.	No
Transaction Source	Used to search transaction feeds received from a particular transaction source. Note: This field appears when you select the Transaction Level Details option from the Search By field.	No
Transaction ID	Used to search for a particular transaction feed. Note: This field appears when you select the Transaction Level Details option from the Search By field.	No
Transaction Date From	Used to search transaction feeds for transactions which are performed on or later than the specified date. Note: This field appears when you select the Transaction Level Details option from the Search By field.	Yes (Conditional) Note: This field is required while searching for transactions which are in the Error status.
External Reference Number	Used to search transaction feed with a particular external reference number. Note: This field appears when you select the Transaction Level Details option from the Search By field.	No
Transaction Date To	Used to search transaction feeds for transactions which are performed on or earlier than the specified date.	No

Field Name	Field Description	Mandatory (Yes or No)
	<p>Note:</p> <p>This field appears when you select the Transaction Level Details option from the Search By field.</p> <p>If you do not specify the date in the Transaction Date To field, the system by default sets it to the system date.</p>	
Transaction Status	<p>Used to search transaction feeds for transactions which are in a particular status. The valid values are:</p> <ul style="list-style-type: none"> • Cancelled • Completed • Error • Ignored • Initial Product Derived • Invalid • Uploaded <p>Note: This field appears when you select the Transaction Level Details option from the Search By field.</p>	No
Division	<p>Used to search transaction feeds that belong to a particular division.</p> <p>Note:</p> <p>This field appears when you select the Transaction Level Details option from the Search By field.</p> <p>You can view only those divisions to which you have access in the Division list.</p>	No
Error Code/Message	<p>Used to search transaction feeds for transactions which are in the Error status and with a particular error message or error code.</p> <p>Note: This field appears when you select the Transaction Level Details option from the Search By field.</p>	No
Error Category	<p>Used to search transaction feeds for transactions which are in the Error status and which belong to a particular error category.</p>	No

Field Name	Field Description	Mandatory (Yes or No)
	Note: This field appears when you select the Transaction Level Details option from the Search By field.	

Note: You must specify at least one search criterion while searching for a transaction feed.

- **Search Results** - On clicking the **Search** button, the search results appear based on the specified search criteria. The **Search Results** section contains the following columns:

Column Name	Column Description
File Name	Displays the name of the file from where the transaction feed is uploaded.
Transaction Source	Displays the transaction source from where the transaction feed is received.
Transaction Header ID	Displays the transaction header ID. Note: The transaction header ID is generated automatically when the file is uploaded.
Transaction Header External ID	Displays the ID mentioned in the file header.
Feed Header Date	Displays the date mentioned in the file header.
Feed Load Date	Displays the date when the transaction feed was uploaded in the system.
Feed Status	Displays the status of the transaction feed. The valid values are: <ul style="list-style-type: none"> • Uploaded - Indicates that the transaction feed is uploaded. • Validated - Indicates that the file header is validated. • Cancelled - Indicates that the transaction feed is cancelled. • Invalid - Indicates that the file header validation failed.
Error Message	Indicates the reason why the file header validation failed.
Total Volume	Displays the total transaction volume of the feed.
Total Amount	Displays the total amount of the transaction feeds.
Uploaded	Displays the total transactions which are uploaded in the system.
Price Item	Displays the total transactions which are validated and for which price items are determined in the system.
Completed	Displays the total transactions for which the billable charges are created and completed in the system.
Error Message	Displays the total transactions which could not pass through the validation, price item determination, or billable charge creation process. Note: If a transaction has only one transaction leg, the error message is displayed from the CI_TXN_DETAIL_EXCP table instead of the CI_TXN_DETAIL table. The objective is that the user should be able to view the transaction leg level error instead of the transaction level error.
Cancelled	Displays the total transactions which are cancelled in the system.

Column Name	Column Description
Ignored	Displays the total transactions which are ignored in the system.
Invalid	Displays the total transactions which are invalid.
Transactions Archived	Displays the total transaction volume which is archived in the system.
Transaction ID	<p>Displays the transaction record number for which the transaction information is saved in the system.</p> <p>Note: This column appears when you select the Transaction Level Details option from the Search By field.</p>
External Reference Number	<p>Displays the external reference number of the transaction.</p> <p>Note: This column appears when you select the Transaction Level Details option from the Search By field.</p>
Division	<p>Indicates the division to which the transaction belongs.</p> <p>Note: This column appears when you select the Transaction Level Details option from the Search By field.</p>
Transaction Record Type	<p>Displays the record type of the transaction.</p> <p>Note: This column appears when you select the Transaction Level Details option from the Search By field.</p>
Transaction Date	<p>Displays the date when the transaction is performed.</p> <p>Note: This column appears when you select the Transaction Level Details option from the Search By field.</p>
Processing Date	<p>Displays the date when the transaction is processed in the system.</p> <p>Note: This column appears when you select the Transaction Level Details option from the Search By field.</p>
Account Information	<p>Displays the concatenated string of information about the account for which the transaction is performed separated by a comma (,).</p> <p>Note: It has a link. On clicking the link, the Account screen appears where you can view the details of the respective account. This column appears when you select the Transaction Level Details option from the Search By field.</p>
Account Identifier Type	<p>Indicates the identifier type based on which the transaction is created for the account.</p> <p>Note: This column appears when you select the Transaction Level Details option from the Search By field.</p>
Primary Account Identifier	Indicates the account for which the transaction is performed.

Column Name	Column Description
	<p>Note: This column appears when you select the Transaction Level Details option from the Search By field.</p>
Transaction Volume	<p>Displays the total transaction volume of the account.</p> <p>Note: This column appears when you select the Transaction Level Details option from the Search By field.</p>
Transaction Amount	<p>Displays the total transaction amount of the account.</p> <p>Note: This column appears when you select the Transaction Level Details option from the Search By field.</p>
Credit/Debit Indicator	<p>Indicates whether the transaction is a debit or credit transaction.</p> <p>Note: This column appears when you select the Transaction Level Details option from the Search By field.</p>
Customer Reference Number	<p>Indicates the customer who has performed the transaction.</p> <p>Note: This column appears when you select the Transaction Level Details option from the Search By field.</p>
Transaction Status	<p>Indicates the status of the transaction.</p> <p>Note: This column appears when you select the Transaction Level Details option from the Search By field.</p>
Rule	<p>Indicates the rule which was met while determining the initial price item for the transaction.</p> <p>Note:</p> <p>It has a link. On clicking the link, the Rule window appears where you can view the details of the rule that was applied while determining the initial price item for the transaction.</p> <p>This column appears when you select the Transaction Level Details option from the Search By field.</p>
Transaction Information	<p>Displays the concatenated string of information about the transaction separated by a comma (,).</p> <p>Note:</p> <p>It has a link. On clicking the link, the Transaction Detail View window appears where you can view the details of the respective transaction.</p> <p>This column appears when you select the Transaction Level Details option from the Search By field.</p>

Note: Pagination is used to display limited number of records in the **Search Results** section. You can use the navigation links, such as **Previous** and **Next** to navigate between pages.

On clicking the **Broadcast** (📡) icon corresponding to the transaction feed in the **Search Results** section, the **Division Level Information** zone or the **Transaction Leg Information** zone appears depending on whether you select the **Feed Level Details** or the **Transaction Level Details** option from the **Search By** field respectively.

Related Topics

For more information on...	See...
How to search for a transaction feed	Searching for a Transaction Feed on page 1090
Division Level Information zone	Division Level Information on page 1085
Transaction Leg Information zone	Transaction Leg Information on page 1087

Division Level Information

The **Division Level Information** zone allows you to drill down and view the transaction volume details of a feed at the division level. It contains the following two sections:

- **Search Criteria** - The **Search Criteria** section contains the following field:

Field Name	Field Description	Mandatory (Yes or No)
Division	Used when you want to view the transaction volume details of a particular division received through the feed. Note: You can only view those divisions to which you have access in the Division list.	No

- **Search Results** - On clicking the **Search** button, the search results are filtered based on the specified search criteria. The **Search Results** section contains the following columns:

Column Name	Column Description
Division	Indicates the division.
Total Volume	Displays the total transaction volume of the division.
Uploaded Volume	Displays the total transaction volume (of the division) which is uploaded in the system.
Price Item Determined	Displays the total transaction volume (of the division) which is validated and for which price item is determined in the system.
Completed Volume	Displays the total transaction volume (of the division) for which billable charges are created and completed in the system.
Error Volume	Displays the total transaction volume (of the division) which could not pass through the validation, price item determination, or billable charge creation process.
Cancelled Volume	Displays the total transaction volume (of the division) which is cancelled in the system.
Ignored Volume	Displays the total transaction volume (of the division) which is ignored in the system.
Invalid Volume	Displays the total transaction volume (of the division) which is invalid.

By default, the **Division Level Information** zone does not appear in the **Feed Management Dashboard** screen. It appears when you select the **Feed Level Details** option from the **Search By** field and click the **Broadcast** (📡) icon corresponding to the transaction feed in the **Search Results** section of the **Search** zone.

Related Topics

For more information on...	See...
How to view the division level details of a transaction feed	Viewing Division Level Details of a Transaction Feed on page 1091

Transaction Level Information

The **Transaction Level Information** zone lists the transactions in a feed which belong to a particular division. It contains the following columns:

Column Name	Column Description
Transaction ID	Displays the transaction ID.
External Reference Number	Displays the external reference number of the transaction.
Division	Indicates the division to which the transaction belongs.
Transaction Record Type	Displays the record type of the transaction.
Transaction Date	Displays the date when the transaction was performed.
Account Information	Displays the account for which the transaction is performed. Note: It has a link. On clicking the link, the Account screens appears where you can view the details of the respective account.
Account Identifier Type	Displays the type of account identifier.
Account Identifier	Indicates the account for which the transaction is performed.
Transaction Volume	Displays the transaction volume.
Transaction Amount	Displays the transaction amount.
Credit/Debit Indicator	Indicates whether the transaction is a debit or credit transaction.
Customer Reference Number	Indicates the customer who performed the transaction.
Transaction Status	Indicates the status of the transaction.
Error Message	Indicates the reason why the validation, price item determination, or billable charge creation process failed.
Rule	Indicates the rule which was met while determining initial price item for the transaction. Note: It has a link. On clicking the link, the Rule screen appears where you can view the details of the respective rule.
Transaction Information	Displays additional information about the transaction. Note: It has a link. On clicking the link, the Transaction Details screen appears where you can view the details of the respective transaction.

By default, the **Transaction Level Information** zone does not appear in the **Feed Management Dashboard** screen. It appears only when you click the **Broadcast** (📡) icon corresponding to a division in the **Division Level Information** zone.

On clicking the **Broadcast** (📡) icon corresponding to a transaction, the **Transaction Leg Information** zone appears where you can view a list of transaction legs of a particular transaction.

You can filter the list using various search criteria (such as, **External Reference Number**, **Primary Account Identifier**, **Account Identifier Type**, **Transaction Source**, **Transaction Record Type**, and **Transaction Status**) available in the **Filter** area. By default, the **Filter** area is hidden. You can view the **Filter** area by clicking the **Filters** (🔍) icon available in the upper right corner of this zone.

Related Topics

For more information on...	See...
How to view the transaction details of a division	Viewing Transactions that Belong to a Division on page 1092
Feed Management Dashboard screen	Feed Management Dashboard on page 1078
Transaction Leg Information zone	Transaction Leg Information on page 1087

Transaction Leg Information

The **Transaction Leg Information** zone lists the legs of a transaction. It contains the following columns:

Column Name	Column Description
Transaction ID	Indicates the transaction to which the transaction leg belongs.
Display Sequence	Displays the sequence number of transaction leg.
Account Identifier Type	Indicates the type of account identifier to which the transaction is mapped.
Primary Account Identifier	Indicates the account which will bear the charges for the transaction.
Error Message	Indicates the reason why the validation, price item determination, or billable charge creation process failed.
Price Item	Indicates the price item to which the transaction is mapped. Note: It has a link. On clicking the link, the Price Item screen appears where you can view the details of the respective price item.
Billable Charge ID	Indicates the billable charge which is created for the transaction leg. Note: The data appears in this column when the billable charge is created for the transaction leg. It has a link. On clicking the link, the Billable Charge screen appears where you can view the details of the billable charge.
Transaction Calculation ID	Displays the transaction calculation ID. Note: The data appears in this column when the transaction leg is rated before billing.

Column Name	Column Description
Initial Price Item Code	Indicates the initial price item to which the transaction was mapped.
Bill ID	Indicates the bill in which the transaction leg of the billable charge is included for billing.
Bill Segment ID	Indicates the bill segment to which the bill belongs.
Variance	Indicates the variance parameter which is used along with the price item for determining price item pricing. Note: This column appears when the Multi Price Parameter option type of the Multi Parameter Based Pricing (C1_PPARM_FLG) feature configuration is set to False .
Price Item Parameters	Displays a comma-separated list of parameter values. It indicates the price item parameters and their values which are used along with the price item for determining price item pricing. Note: This column appears when the Multi Price Parameter option type of the Multi Parameter Based Pricing (C1_PPARM_FLG) feature configuration is set to True .
Aggregation Parameter Group ID	Indicates the aggregation parameter group using which the transaction leg is aggregated in the billable charge.

Note: Pagination is used to display limited number of records in this zone. You can use the navigation links, such as **Previous** and **Next** to navigate between pages.

By default, the **Transaction Leg Information** zone does not appear in the **Feed Management Dashboard** screen. It appears when you click the **Broadcast** (📡) icon corresponding to a transaction in the **Transaction Level Information** zone.

Related Topics

For more information on...	See...
How to view the legs of a transaction	Viewing Legs of a Transaction on page 1092
Feed Management Dashboard screen	Feed Management Dashboard on page 1078
Transaction Level Information zone	Transaction Level Information on page 1086

Transaction Leg Service Quantity

The **Transaction Leg Service Quantity** zone lists the SQIs which are associated with the price item-division combination to which a transaction is mapped. It contains the following columns:

Column Name	Column Description
SQI	Indicates the service quantity identifier.
Daily Service Quantity	Displays the SQI value which is calculated using the transaction aggregation rule defined for the price item-division combination.

Note: Pagination is used to display limited number of records in this zone. You can use the navigation links, such as **Previous** and **Next** to navigate between pages.

By default, the **Transaction Leg Service Quantity** zone does not appear in the **Feed Management Dashboard** screen. It appears when you click the **Broadcast** (📡) icon corresponding to a transaction leg, which is rated before billing, in the **Transaction Leg Information** zone.

Related Topics

For more information on...	See...
How to view the SQIs calculated for a transaction leg	Viewing the SQIs Calculated for a Transaction Leg on page 1093
Feed Management Dashboard screen	Feed Management Dashboard on page 1078
Transaction Leg Information zone	Transaction Leg Information on page 1087

Transaction Leg Calculation Lines

During the pass through charge calculation, a calculation line is created for each rate component. The **Transaction Leg Calculation Lines** zone lists the calculation lines created for a transaction leg. It contains the following columns:

Column Name	Column Description
Transaction Calculation ID	Displays the transaction calculation ID.
Sequence	Indicates the sequence in which the calculation line is created. It is the sequence of the rate component which is used in the rate schedule.
Price Component ID	Indicates the price component which is used during calculation.
Rate Information	Displays the rate which is used for calculation.
SQI	Indicates the service quantity identifier.
Billable Service Quantity	Displays the SQI value used by the rates engine for calculation.
Calculated Amount	Displays the calculated charge amount which is rounded off. This amount appears in the invoice currency.
Description on Bill	Displays the summarized information about the calculation line that will be printed on the bill.
Precise Calculated Amount	Displays the calculated charge amount. This amount appears in the invoice currency.
Exempt Amount	Displays the amount of the calculated charge that the person does not have to pay due to tax exemption.
Base Amount	Displays the total amount derived from the cross-referenced line(s) that the current line is then used to calculate the charge amount.
Pricing Amount	Displays the calculated charge amount. This amount appears in the pricing currency.
Exchange Rate	Indicates the exchange rate which is used when the invoice currency is different from the pricing currency.
Print	Indicates whether information about the calculation line must be printed on the person's bill. The valid values are: <ul style="list-style-type: none"> • Y • N
Distribution Code	Indicates the distribution code associated with the rate component.
Pricing Currency	Indicates the currency in which the price item pricing is defined.

Column Name	Column Description
Aggregation Parameter Group ID	Indicates the aggregation parameter group using which the transaction leg is aggregated in the billable charge.

Note: Pagination is used to display limited number of records in this zone. You can use the navigation links, such as **Previous** and **Next** to navigate between pages.

By default, the **Transaction Leg Calculation Lines** zone does not appear in the **Feed Management Dashboard** screen. It appears when you click the **Broadcast** (📡) icon corresponding to a transaction leg, which is rated before billing, in the **Transaction Leg Information** zone.

Related Topics

For more information on...	See...
How to view the calculation lines of a transaction leg	Viewing the Calculation Lines of a Transaction Leg on page 1093
Feed Management Dashboard screen	Feed Management Dashboard on page 1078
Transaction Leg Information zone	Transaction Leg Information on page 1087

Transaction Leg Calc Line Characteristics

The **Transaction Leg Calc Line Characteristics** zone lists the characteristics of each calculation line. It contains the following columns:

Column Name	Column Description
Transaction Calculation ID	Displays the transaction calculation ID.
Sequence	Indicates the sequence in which the calculation line was created. It is the sequence of the rate component which is used in the rate schedule.
Characteristic Type	Indicates the characteristic type.
Characteristic Value	Displays the value of the characteristic type.

Note: Pagination is used to display limited number of records in this zone. You can use the navigation links, such as **Previous** and **Next** to navigate between pages.

By default, the **Transaction Leg Calc Line Characteristics** zone does not appear in the **Feed Management Dashboard** screen. It appears when you click the **Broadcast** (📡) icon corresponding to a transaction leg, which is rated before billing, in the **Transaction Leg Information** zone.

Related Topics

For more information on...	See...
How to view characteristics of a calculation line	Viewing Characteristics of a Calculation Line on page 1094
Feed Management Dashboard screen	Feed Management Dashboard on page 1078
Transaction Leg Information zone	Transaction Leg Information on page 1087

Searching for a Transaction Feed

Procedure

To search for a transaction feed:

1. Click the **Menu** link in the **Application** toolbar.
A list appears.
2. From the **Main** menu, select **Transaction and Audit Event Management** and then click **Feed Management Dashboard**.
The **Feed Management Dashboard** screen appears.
3. Enter the search criteria in the **Search** zone.

Note: ORMB search engine supports wildcard search, where you can substitute the percentage (%) symbol as a stand in for any word or letter in a search criteria. You can use the ‘%’ wildcard character in all input fields except the date and ID fields. The ‘%’ wildcard character is suffixed automatically at the end of the partial search criteria. Therefore, you may or may not specify the wildcard character at the end of the partial search criteria. However, you have to prefix the wildcard character manually wherever required.

4. Click **Search**.
A list of transaction feeds that meet the search criteria appears in the **Search Results** section.

Related Topics

For more information on...	See...
Feed Management Dashboard screen	Feed Management Dashboard on page 1078
Search zone	Search on page 1079

Viewing Division Level Details of a Transaction Feed

Procedure

To view the division level details of a transaction feed:

1. Ensure that the **Feed Level Details** option is selected from the **Search By** field in the **Search** zone of the **Feed Management Dashboard** screen for viewing the division level details of a transaction feed.
2. Click **Search**.
The search results appear based on the specified search criteria.
3. In the **Search Results** section, click the **Broadcast** (📡) icon corresponding to the transaction feed whose *division level details* you want to view.
The **Division Level Information** zone appears.
4. View the transaction volume details of each division in the **Division Level Information** zone.

Related Topics

For more information on...	See...
How to search for a transaction feed	Searching for a Transaction Feed on page 1090
Search zone	Search on page 1079
Feed Management Dashboard screen	Feed Management Dashboard on page 1078
Division Level Information zone	Division Level Information on page 1085

Viewing Transactions that Belong to a Division

Procedure

To view the transactions that belong to a division:

1. Ensure that the **Feed Level Details** option is selected from the **Search By** field in the **Search** zone of the **Feed Management Dashboard** screen for viewing the transactions that belong to a division.

2. Click **Search**.

The search results appear based on the specified search criteria.

3. In the **Search Results** section, click the **Broadcast** () icon corresponding to the transaction feed whose details you want to view.

The **Division Level Information** zone appears.

4. Click the **Broadcast** () icon corresponding to the division whose transaction details you want to view.

The **Transaction Level Information** zone appears.

5. View the list of the transactions that belong to the division in the **Transaction Level Information** zone.

Related Topics

For more information on...	See...
How to search for a transaction feed	Searching for a Transaction Feed on page 1090
Search zone	Search on page 1079
Feed Management Dashboard screen	Feed Management Dashboard on page 1078
Division Level Information zone	Division Level Information on page 1085
Transaction Level Information zone	Transaction Level Information on page 1086

Viewing Legs of a Transaction

Procedure

To view the legs of a transaction:

1. Search for the transaction feed in the **Feed Management Dashboard** screen.

Note: Ensure that the **Transaction Level Information** zone is expanded in the **Feed Management Dashboard** screen while you are viewing the division level details of a transaction feed.

2. In the **Search Results** section or the **Transaction Level Information** zone, click the **Broadcast** () icon corresponding to the transaction feed whose details you want to view.

The **Transaction Leg Information** zone appears.

3. View the details of transaction legs in the **Transaction Leg Information** zone.

Related Topics

For more information on...	See...
How to search for a transaction feed	Searching for a Transaction Feed on page 1090
Feed Management Dashboard screen	Feed Management Dashboard on page 1078
Transaction Level Information zone	Transaction Level Information on page 1086
Transaction Leg Information zone	Transaction Leg Information on page 1087

Viewing the SQIs Calculated for a Transaction Leg

Procedure

To view the SQIs calculated for a transaction leg:

1. Ensure that the **Transaction Leg Information** zone is expanded in the **Feed Management Dashboard** screen.
2. Click the **Broadcast** () icon corresponding to the transaction leg (which is rated before billing) whose SQIs you want to view.

The **Transaction Leg Service Quantity**, **Transaction Leg Calculation Lines**, and **Transaction Leg Calc Line Characteristics** zones appear.

3. View the SQIs calculated for the transaction leg in the **Transaction Leg Service Quantity** zone.

Related Topics

For more information on...	See...
How to search for a transaction feed	Searching for a Transaction Feed on page 1090
Transaction Leg Information zone	Transaction Leg Information on page 1087
Feed Management Dashboard screen	Feed Management Dashboard on page 1078
Transaction Leg Service Quantity zone	Transaction Leg Service Quantity on page 1088
Transaction Leg Calculation Lines zone	Transaction Leg Calculation Lines on page 1089
Transaction Leg Calc Line Characteristics zone	Transaction Leg Calc Line Characteristics on page 1090

Viewing the Calculation Lines of a Transaction Leg

Procedure

To view the calculation lines of a transaction leg:

1. Ensure that the **Transaction Leg Information** zone is expanded in the **Feed Management Dashboard** screen.
2. Click the **Broadcast** () icon corresponding to the transaction leg (which is rated before billing) whose calculation lines you want to view.

The **Transaction Leg Service Quantity**, **Transaction Leg Calculation Lines**, and **Transaction Leg Calc Line Characteristics** zones appear.

3. View the list of calculation lines generated for the transaction leg in the **Transaction Leg Calculation Lines** zone.

Related Topics

For more information on...	See...
How to search for a transaction feed	Searching for a Transaction Feed on page 1090

For more information on...	See...
Transaction Leg Information zone	Transaction Leg Information on page 1087
Feed Management Dashboard screen	Feed Management Dashboard on page 1078
Transaction Leg Service Quantity zone	Transaction Leg Service Quantity on page 1088
Transaction Leg Calculation Lines zone	Transaction Leg Calculation Lines on page 1089
Transaction Leg Calc Line Characteristics zone	Transaction Leg Calc Line Characteristics on page 1090

Viewing Characteristics of a Calculation Line

Procedure

To view the characteristics of a calculation line:

1. Ensure that the **Transaction Leg Information** zone is expanded in the **Feed Management Dashboard** screen.
2. Click the **Broadcast** () icon corresponding to the transaction leg (which is rated before billing) whose calculation line characteristics you want to view.

The **Transaction Leg Service Quantity**, **Transaction Leg Calculation Lines**, and **Transaction Leg Calc Line Characteristics** zones appear.

3. View the characteristics of each calculation line in the **Transaction Leg Calc Line Characteristics** zone.

Related Topics

For more information on...	See...
How to search for a transaction feed	Searching for a Transaction Feed on page 1090
Transaction Leg Information zone	Transaction Leg Information on page 1087
Feed Management Dashboard screen	Feed Management Dashboard on page 1078
Transaction Leg Service Quantity zone	Transaction Leg Service Quantity on page 1088
Transaction Leg Calculation Lines zone	Transaction Leg Calculation Lines on page 1089
Transaction Leg Calc Line Characteristics zone	Transaction Leg Calc Line Characteristics on page 1090

Transaction Details

The **Transaction Details** screen allows you to search for a transaction using various search criteria. It also allows you to add and copy an existing transaction. It contains the following zones:

- [Search](#) on page 1094
- [Transaction Legs](#) on page 1098
- [Transaction Error Messages](#) on page 1101

Search

The **Search** zone allows you to search for a transaction using various search criteria. It contains the following two sections:

- **Search Criteria** - The **Search Criteria** section contains the following fields:

Field Name	Field Description	Mandatory (Yes or No)
Search By	Used to indicate whether you want to search transactions based on their current status. The valid values are: <ul style="list-style-type: none"> • Uploaded - Used to search transactions which are uploaded in the system. • Initial Price Item Determined - Used to search transactions for which a price item is determined. • Ignored - Used to search transactions which are ignored in the system. • Error - Used to search transactions with an error. • Cancelled - Used to search for transactions which are cancelled. • Completed - Used to search for transactions whose billable charge is completed. • Invalid - Used to search for invalid transactions. 	Yes (Conditional)
	Note: By default the Uploaded option is selected.	Note: This field is required for searching transactions which are in a particular status.
External Reference Number	Used to search a transaction with a particular external reference number.	No
Division	Used to search transactions that belong to a particular division.	No
	Note: You can only view those divisions to which you have access in the Division list.	
Transaction Source	Used to search transactions received from a particular transaction source.	No
Transaction Record Type	Used to search transactions with a particular record type.	No
Account Identifier Type	Used to select the identifier type based on which you want to search transactions of an account.	Yes (Conditional)
		Note: If you enter the primary account identifier as a search criteria, you have to select the account identifier type.
Primary Account Identifier	Used to search transactions which are performed for a particular account.	Yes (Conditional)

Field Name	Field Description	Mandatory (Yes or No)
		Note: If you select the account identifier type as a search criteria, you have to enter the primary account identifier.
Transaction Date	Used to search transactions which are performed on a particular date.	No
Transaction Upload Date	Used to search transactions which are uploaded in the system on a particular date.	No
Transaction Header ID	Used to search transactions which are uploaded through a particular transaction feed. Note: This field appears when you select the Uploaded, Ignored, Error, Cancelled, or Invalid options from the Search By field.	No
Price Item	Used to search transactions which are mapped to a particular price item. Note: This field appears when you select the Initial Price Item Determined option from the Search By field.	No
Billable Charge ID	Used to search transactions which are included in a particular billable charge. Note: This field appears when you select the Completed option from the Search By field.	No
Disaggregated	Used to indicate whether you want to search transactions which are disaggregated. The valid values are: <ul style="list-style-type: none"> • Yes • No 	No

Note: You must specify at least one search criterion while searching for a transaction.

- **Search Results** - On clicking the **Search** button, the search results appear based on the specified search criteria. The **Search Results** section contains the following columns:

Column Name	Column Description
Transaction ID	Displays the transaction ID. Note: It has a link. On clicking the link, the Transaction Detail View screen appears where you can view the details of the respective transaction.
Transaction Source	Displays the transaction source from where the transaction is received.
Transaction Record Type	Displays the record type of the transaction.

Column Name	Column Description
Transaction Upload Date	Displays the date when the transaction is uploaded in the system.
	Note: This column appears when you select the Uploaded, Initial Price Item Determined, Ignored, Error, Cancelled, or Invalid options from the Search By list.
Transaction Header ID	Indicates the transaction feed through which the transaction was uploaded in the system.
	Note: This column appears when you select the Uploaded, Ignored, Cancelled, or Invalid options from the Search By list.
External Reference Number	Displays the external reference number of the transaction.
Customer Reference Number	Displays the reference number of the customer for the particular transaction.
	Note: This column appears when you select the Error option from the Search By field.
Disaggregation Status	Indicates whether the transaction was disaggregated or not. The valid values are: <ul style="list-style-type: none"> • Yes • No
Manual Entry	Indicates whether the transaction is manually added in the system. The valid values are: <ul style="list-style-type: none"> • Yes • No
	Note: This column appears when you select the Uploaded or Cancelled options from the Search By list.
Transaction Date	Displays the date when the transaction was performed.
Transaction Amount	Displays the transaction amount.
Transaction Volume	Displays the transaction volume.
Division	Indicates the division to which the transaction belongs.
Error Message	Displays the reason why the validation, price item determination, or billable charge creation process failed.
	Note: This column appears when you select the Error, or Invalid options from the Search By list.
Account Information	Displays the concatenated string of information about the account for which the transaction is performed separated by a comma (.). The string includes the account identifier type and account identifier.
Rule	Indicates the rule which was met while determining initial price item for the transaction.

Column Name	Column Description
	<p>Note:</p> <p>It has a link. On clicking the link, the Rule screen appears where you can view the details of the respective rule.</p> <p>This column appears when you select the Initial Price Item Determined, Ignored, Error, or Completed options from the Search By list.</p>
Transaction Information	<p>Displays additional information about the transaction.</p> <p>Note: It has a link. On clicking the link, the Transaction Detail View screen appears where you can view the details of the respective transaction.</p>

Note: Pagination is used to display limited number of records in the **Search Results** section. You can use the navigation links, such as **Previous** and **Next** to navigate between pages.

On clicking the **Broadcast** (📡) icon corresponding to a transaction in the **Search Results** section, the **Transaction Legs** or the **Transaction Error Messages** zone appears based on the status of the transaction.

Note: The **Broadcast** (📡) icon does not appear for transactions which are in the **Cancelled** status.

Related Topics

For more information on...	See...
How to search for a transaction	Searching for a Transaction on page 1101
How to copy a transaction	Adding a Transaction on page 1103
How to view the details of a transaction	Viewing the Transaction Details on page 1103
Transaction Legs zone	Transaction Legs on page 1098
Transaction Error Messages zone	Transaction Error Messages on page 1101

Transaction Legs

The **Transaction Legs** zone allows you to view the legs of a transaction. It contains the following columns:

Column Name	Column Description
Transaction ID	Indicates the transaction to which the transaction leg belongs.
Transaction Leg Status	<p>Indicates the status of the transaction leg. The valid values are:</p> <ul style="list-style-type: none"> • Uploaded • Initial Price Item Derived • Ignored • Error • Cancelled • Completed • Invalid

Column Name	Column Description
	Note: This column appears only when you select the Initial Price Item Determined, Ignored, or Completed options from the Search By list.
Initial Price Item Code	Indicates the initial price item to which the transaction is mapped. Note: This column appears only when you select the Initial Price Item Determined, Ignored, or Completed options from the Search By list.
Price Item Parameters	Displays a comma-separated list of parameter values. It indicates the price item parameters and their values which are used along with the final price item for determining price item pricing. Note: This column appears only when you select the Initial Price Item Determined, Ignored, or Completed options from the Search By list and when the Multi Price Parameter option type of the Multi Parameter Based Pricing (C1_PPARM_FLG) feature configuration is set to True .
Final Price Item Code	Indicates the final price item to which the transaction is mapped. Note: This column appears only when you select the Initial Price Item Determined, Ignored, or Completed options from the Search By list.
Pricing Rule Information	Note: This column appears only when you select the Initial Price Item Determined option from the Search By list and when the transaction is uploaded for the health care domain.
Price Assignment ID	Indicates the effective pricing which is available for the account, price item or regular bundle (to which the price item belongs) or parent (regular) bundle (to which the regular bundle belongs) and/or variance parameter or price item parameters (parameter group) combination on the processing date. Note: This column appears only when you select the Initial Price Item Determined, Ignored, or Completed options from the Search By list.
Aggregate Transaction	Indicates whether the transaction leg is aggregated. The valid values are: <ul style="list-style-type: none"> • Yes • No Note: This column appears only when you select the Initial Price Item Determined, Ignored, or Completed options from the Search By list.
Billable Charge ID	Indicates the billable charge in which the transaction leg is included for billing. Note: This column appears only when you select the Initial Price Item Determined, Ignored, or Completed options from the Search By list.
Transaction Source	Displays the transaction source from where the transaction is received.
Transaction Record Type	Displays the record type of the transaction.
Transaction Upload Date	Displays the date when the transaction is uploaded in the system.
External Reference Number	Displays the external reference number of the transaction.

Column Name	Column Description
Customer Reference Number	Displays the reference number using which the error message is created for the transaction performed by particular customer.
	Note: This column appears only when you select the Error option from the Search By list.
Disaggregation Status	Indicates whether the transaction is disaggregated or not. The valid values are: <ul style="list-style-type: none"> • Yes • No
Transaction Date	Displays the date when the transaction is performed.
Transaction Amount	Displays the transaction amount.
Transaction Volume	Displays the total transaction volume.
Division	Indicates the division to which the derived account belongs. The derived account means the account which will bear the charges for the transaction.
Sequence	Displays the sequence number of the transaction leg.
	Note: This column appears only when you select the Initial Price Item Determined, Ignored, or Completed options from the Search By list.
Error Message	Indicates the reason why the price item pricing verification or billable charge creation process failed.
	Note: This column appears only when you select the Initial Price Item Determined, Ignored, Error, or Completed options from the Search By list.
Account Information	Displays the concatenated string of information about the account which bears the charges for the transaction separated by a comma (.). The string includes the account identifier type, account identifier, and division (to which the derived account belongs).
	Note: This column appears only when you select the Initial Price Item Determined, Ignored, Error, or Completed options from the Search By list.
Rule	Indicates the rule which was met while determining the initial price item for the transaction.
	<p>Note:</p> <p>It has a link. On clicking the link, the Rule screen appears where you can view the details of the respective rule.</p> <p>This column appears only when you select the Ignored, Error, or Completed options from the Search By list and when the transaction is uploaded for the financial services domain.</p>
Transaction Information	Displays the concatenated string of information about the transaction separated by a comma (.).
	Note: It has a link. On clicking the link, the Transaction Detail View screen appears where you can view the details of the respective transaction.

Note:

The **Transaction Legs** zone does not appear for transactions which are in the **Uploaded**, **Cancelled**, or **Invalid** status. However, the **Transaction Legs** zone appears for transactions which are in the **Uploaded** status and partially disaggregated.

Related Topics

For more information on...	See...
How to search for a transaction	Searching for a Transaction on page 1101
How to view the details of a transaction	Viewing the Transaction Details on page 1103

Transaction Error Messages

The **Transaction Error Messages** zone allows you to view the reason why the transaction is in the **Error** or **Invalid** status. It contains the following column:

Column Name	Column Description
Error Message	Displays the reason why the transaction is in the Error or Invalid status.

Note: The **Transaction Error Messages** zone appears for transactions which are in the **Invalid** status only when the errors occur while executing the **Validate Transaction and Derive Price Item (C1-TXNIP)** batch. It does not appear when the errors occur while executing the **Price Item Pricing Verification (C1-TXNVP)** or **Service Quantity Calculation (C1-TXNSQ)** batch.

Related Topics

For more information on...	See...
How to search for a transaction	Searching for a Transaction on page 1101
How to view the details of a transaction	Viewing the Transaction Details on page 1103

Searching for a Transaction**Procedure**

To search for a transaction:

1. Click the **Admin** link in the **Application** toolbar.
A list appears.
2. From the **Admin** menu, select **T** and then click **Transaction Details**.
The **Transaction Details** screen appears.
3. Enter the search criteria in the **Search** zone.

Note: ORMB search engine supports wildcard search, where you can substitute the percentage (%) symbol as a stand in for any word or letter in a search criteria. You can use the ‘%’ wildcard character in all input fields except the date and ID fields. The ‘%’ wildcard character is suffixed automatically at the end of the partial search criteria. Therefore, you may or may not specify the wildcard character at the end of the partial search criteria. However, you have to prefix the wildcard character manually wherever required.

4. Click **Search**.

A list of transactions that meet the search criteria appears in the **Search Results** section.

Related Topics

For more information on...	See...
Transaction Details screen	Transaction Details on page 1094
Search zone	Search on page 1094

Viewing the Transaction Legs

Procedure

To view the legs of a transaction:

1. Search for the transaction in the **Transaction Details** screen.
2. In the **Search Results** section, click the **Broadcast** () icon corresponding to the transaction whose legs you want to view.

The **Transaction Legs** zone appears.

Note:

The **Broadcast** () icon appears corresponding to a transaction which is in the **Uploaded, Initial Price Item Determined, Ignored, Error, and Completed** status. This is because you can only view legs of an uploaded, initial price item determined, ignored, error, or completed transaction

You can only view the legs of an uploaded transaction which is partially disaggregated.

3. View the details of the transaction legs in the **Transaction Legs** zone.

Related Topics

For more information on...	See...
How to search for a transaction	Searching for a Transaction on page 1101
Transaction Legs zone	Transaction Legs on page 1098

Viewing Error Messages

Procedure

To view the error messages logged for a transaction:

1. Search for the transaction which is in the **Invalid** or **Error** status in the **Transaction Details** screen.
2. In the **Search Results** section, click the **Broadcast** () icon corresponding to the transaction whose error messages you want to view.

The **Transaction Error Messages** zone appears.

3. View the error messages in the **Transaction Error Messages** zone.

Note: The **Transaction Error Messages** zone appears for transactions which are in the **Invalid (INVL)** status only when the errors occur while executing the **Validate Transaction and Derive Price Item (C1-TXNIP)** batch. It does not appear when the errors occur while executing the **Price Item Pricing Verification (C1-TXNVP)** or **Service Quantity Calculation (C1-TXNSQ)** batch.

Related Topics

For more information on...	See...
How to search for a transaction	Searching for a Transaction on page 1101
Transaction Error Messages zone	Transaction Error Messages on page 1101

Viewing the Transaction Details

Procedure

To view the details of a transaction:

1. Search for the transaction in the **Transaction Details** screen.
2. In the **Search Results** section, click the link in the **Transaction ID** or the **Transaction Information** column corresponding to the transaction whose details you want to view.

The **Transaction Detail View** screen appears.

3. View the details of the transaction in the **Transaction Detail View** screen.

Related Topics

For more information on...	See...
How to search for a transaction	Searching for a Transaction on page 1101
Transaction Details screen	Transaction Details on page 1094

Adding a Transaction

Prerequisites

To add a transaction manually, you should have:

- Divisions, account identifier types, transaction sources, transaction record types, and currencies defined in the application

Procedure

To add a transaction manually:

1. Click the **Admin** link in the **Application** toolbar.
A list appears.
2. From the **Admin** menu, select **T** and then click **Transaction Details**.
The **Transaction Details** screen appears.
3. Click the **Add** button in the upper right corner of the **Transaction Details** screen.

The **Transaction Details** screen appears. It contains the following fields:

Field Name	Field Description	Mandatory (Yes or No)
Transaction Source	Used to specify the transaction source from where the transaction is received.	Yes
Division	Used to specify the division to which the transaction belongs.	Yes
	Note: You can only view those divisions to which you have access in the Division list.	
Transaction Record Type	Used to specify the record type of the transaction.	Yes
Transaction Date	Used to specify the date when the transaction is performed.	Yes
Manual Entry	Indicates that the transaction is manually entered in the system.	Not applicable
Credit/Debit Indicator	Used to indicate whether the transaction is a debit or a credit transaction.	Yes
External Reference Number	Used to specify the external reference number of the transaction.	No
Customer Reference Number	Used to indicate the person who performed the transaction.	No
Account Identifier Type	Used to specify the type of account identifier.	Yes (Conditional)
		Note: If you enter the account identifier as a search criteria, you have to select the account identifier type.
Primary Account Identifier	Used to indicate the account for which the transaction is performed.	Yes (Conditional)
		Note: If you specify the account identifier type as a search criteria, you have to enter the account identifier.
Transaction Amount	Used to specify the transaction amount.	Yes
Transaction Currency	Used to indicate the currency in which the transaction is performed.	Yes
Transaction Volume	Used to specify the transaction volume.	Yes
Additional Amount 1, Additional Amount 2, ..., Additional Amount 10	Used to specify additional information about the transaction.	Yes (Conditional)
	Note: These fields appear when you select the transaction source and record type from the respective list.	
Note: If the business label is defined for any of these user defined fields, the business label appears instead of the field name.		Note: This field is required when you are specifying the currency in the corresponding field.

Field Name	Field Description	Mandatory (Yes or No)
Amount 1 Currency Code, Amount 2 Currency Code, ..., Amount 10 Currency Code	Used to specify additional information about the transaction.	Yes (Conditional)
Note: If the business label is defined for any of these user defined fields, the business label appears instead of the field name.	Note: These fields appear when you select the transaction source and record type from the respective list.	Note: This field is required when you are specifying the amount in the corresponding field.
Additional Date 1, Additional Date 2, ..., Additional Date 5	Used to specify additional information about the transaction.	No
Note: If the business label is defined for any of these user defined fields, the business label appears instead of the field name.	Note: These fields appear when you select the transaction source and record type from the respective list.	
Additional Numeric Data 1, Additional Numeric Data 2, Additional Numeric Data 3,, Additional Numeric Data 20	Used to specify additional information about the transaction.	No
Note: If the business label is defined for any of these user defined fields, the business label appears instead of the field name.	Note: These fields appear when you select the transaction source and record type from the respective list.	
Additional Data 1, Additional Data 2, Additional Data 3, ..., Additional Data 50	Used to specify additional information about the transaction.	No
Note: If the business label is defined for any of these user defined fields, the business label appears instead of the field name.	Note: These fields appear when you select the transaction source and record type from the respective list.	

4. Enter the required details in the **Transaction Details** screen.
5. Click **Save**.

The transaction is added in the system.

Note:

If the following option types are set in the **Dummy Header (C1-TXNDMYID)** feature configuration, the header details including the header ID are generated automatically for the manually added transaction:

- Dummy File Name
- Dummy Header ID
- Dummy Transaction Source
- Dummy Header Date

The header ID remains same for all transactions which are manually created on a particular date. You can cancel manually added transactions using the Transaction Header ID.

Related Topics

For more information on...	See...
Transaction Details screen	Transaction Details on page 1094
How to set the Dummy Header (C1-TXNDMYID) feature configuration	Setting the C1-TXNDMYID Feature Configuration on page 4347

Copying a Transaction

Instead of creating a manual transaction from scratch, you can create a manual transaction using an existing transaction. This is possible through copying a transaction. On copying a transaction, the details including the division, account identifier type, primary account identifier, transaction source, transaction record type, external reference number, and customer reference number are also copied to the new transaction. You can then edit the details, if required.

Prerequisites

To copy a transaction, you should have:

- Transaction (whose copy you want to create) available in the application
- Divisions, account identifier types, transaction sources, transaction record types, and currencies defined in the application

Procedure

To copy a transaction:

1. Search for the transaction in the **Transaction Details** screen.
2. In the **Search Results** section, click the link in the **Transaction ID** or the **Transaction Information** column corresponding to the transaction whose copy you want to create.

The **Transaction Details** screen appears.

Note: The fields are in the read-only mode.

3. Click the **Copy** button available in the lower right corner of this screen.

The **Transaction Details** screen appears. It contains the following fields:

Field Name	Field Description	Mandatory (Yes or No)
Transaction Source	Used to specify the transaction source from where the transaction is received.	Yes

Field Name	Field Description	Mandatory (Yes or No)
Division	Used to specify the division to which the transaction belongs.	Yes
	Note: You can only view those divisions to which you have access in the Division list.	
Transaction Record Type	Used to specify the record type of the transaction.	Yes
Transaction Date	Used to specify the date when the transaction is performed.	Yes
Manual Entry	Indicates that the transaction is manually entered in the system.	Not applicable
Credit/Debit Indicator	Used to indicate whether the transaction is a debit or a credit transaction.	Yes
External Reference Number	Used to specify the external reference number of the transaction.	No
Customer Reference Number	Used to indicate the person who performed the transaction.	No
Account Identifier Type	Used to specify the type of account identifier.	Yes (Conditional)
		Note: If you enter the account identifier as a search criteria, you have to select the account identifier type.
Primary Account Identifier	Used to indicate the account for which the transaction is performed.	Yes (Conditional)
		Note: If you specify the account identifier type as a search criteria, you have to enter the account identifier.
Transaction Amount	Used to specify the transaction amount.	Yes
Transaction Currency	Used to indicate the currency in which the transaction is performed.	Yes
Transaction Volume	Used to specify the transaction volume.	Yes
Additional Amount 1, Additional Amount 2, ..., Additional Amount 10	Used to specify additional information about the transaction.	Yes (Conditional)
	Note: These fields appear when you select the transaction source and record type from the respective list.	Note: This field is required when you are specifying the currency in the corresponding field.
Note: If the business label is defined for any of these user defined fields, the business label appears instead of the field name.		
Amount 1 Currency Code, Amount 2 Currency Code, ..., Amount 10 Currency Code	Used to specify additional information about the transaction.	Yes (Conditional)

Field Name	Field Description	Mandatory (Yes or No)
Note: If the business label is defined for any of these user defined fields, the business label appears instead of the field name.	Note: These fields appear when you select the transaction source and record type from the respective list.	Note: This field is required when you are specifying the amount in the corresponding field.
Additional Date 1, Additional Date 2,, Additional Date 5	Used to specify additional information about the transaction.	No
Note: If the business label is defined for any of these user defined fields, the business label appears instead of the field name.	Note: These fields appear when you select the transaction source and record type from the respective list.	
Additional Numeric Data 1, Additional Numeric Data 2, Additional Numeric Data 3,, Additional Numeric Data 20	Used to specify additional information about the transaction.	No
Note: If the business label is defined for any of these user defined fields, the business label appears instead of the field name.	Note: These fields appear when you select the transaction source and record type from the respective list.	
Additional Data 1, Additional Data 2, Additional Data 3,, Additional Data 50	Used to specify additional information about the transaction.	No
Note: If the business label is defined for any of these user defined fields, the business label appears instead of the field name.	Note: These fields appear when you select the transaction source and record type from the respective list.	

4. Enter the required details in the **Transaction Details** screen.

5. Click **Save**.

The new transaction is added in the system.

Related Topics

For more information on...	See...
How to search for a transaction	Searching for a Transaction on page 1101
Transaction Details screen	Transaction Details on page 1094

Transaction Source

The **Transaction Source** screen allows you to define, edit, delete, and copy a transaction source. It contains the following zone:

- [Search Transaction Source](#) on page 1109

Search Transaction Source

The **Search Transaction Source** zone allows you to search for a transaction source using various search criteria. It contains the following two sections:

- **Search Criteria** - The **Search Criteria** section contains the following fields:

Field name	Field Description	Mandatory (Yes or No)
Transaction Source	Used to search for a particular transaction source.	No
Description	Used to search transaction sources having a particular description.	No

- **Search Results** - On clicking the **Search** button, the search results appear based on the specified search criteria. The **Search Results** section contains the following columns:

Column Name	Column Description
Transaction Source	Displays the transaction source.
Description	Displays the description of the transaction source.
Account Identifier Type	Indicates the type of account identifier that will be received from the transaction source.
Edit	On clicking the Edit (✎) icon, the Transaction Source screen appears where you can edit the details of the existing transaction source.
Delete	On clicking the Delete (🗑) icon, you can delete the transaction source.
	Note: You can delete a transaction source only when it is not yet used in the system.
Copy	On clicking the Copy (📄) icon, the Transaction Source screen appears where you can define a new transaction source using an existing transaction source.

By default, the **Filter** area is hidden. You can view the **Filter** area by clicking the **Filters** (🔍) icon available in the upper right corner of this zone.

Related Topics

For more information on...	See...
How to search for a transaction source	Searching for a Transaction Source on page 1110
How to edit a transaction source	Editing a Transaction Source on page 1111
How to delete a transaction source	Deleting a Transaction Source on page 1113
How to copy a transaction source	Copying a Transaction Source on page 1112

Searching for a Transaction Source

Procedure

To search for a transaction source:

1. Click the **Admin** link in the **Application** toolbar.
A list appears.
2. From the **Admin** menu, select **T** and then click **Transaction Source**.
The **Transaction Source** screen appears.
3. Enter the search criteria in the **Search Transaction Source** zone.

Note: ORMB search engine supports wildcard search, where you can substitute the percentage (%) symbol as a stand in for any word or letter in a search criteria. You can use the ‘%’ wildcard character in all input fields except the date and ID fields. The ‘%’ wildcard character is suffixed automatically at the end of the partial search criteria. Therefore, you may or may not specify the wildcard character at the end of the partial search criteria. However, you have to prefix the wildcard character manually wherever required.

4. Click **Search**.

A list of transaction sources that meet the search criteria appears in the **Search Results** section.

Related Topics

For more information on...	See...
Transaction Source screen	Transaction Source on page 1109
Search Transaction Source zone	Search Transaction Source on page 1109

Defining a Transaction Source

Prerequisites

To define a transaction source, you should have:

- Account identifier types defined in the application

Procedure

To define a transaction source:

1. Click the **Admin** link in the **Application** toolbar.
A list appears.
2. From the **Admin** menu, select **T** and then click **Transaction Source**.
The **Transaction Source** screen appears.
3. Click the **Add** button in the upper right corner of the **Transaction Source** screen.

The **Transaction Source** screen appears. It contains the following fields:

Field Name	Field Description	Mandatory (Yes or No)
Transaction Source	Used to specify the transaction source.	Yes

Field Name	Field Description	Mandatory (Yes or No)
	Note: You cannot specify any special character except underscore (_) in the Transaction Source field.	
Description	Used to specify the description for the transaction source.	Yes
Account Identifier Type	Used to indicate the type of account identifier that will be received from the transaction source.	Yes

- Enter the required details in the **Transaction Source** screen.
- Click **Save**.

The transaction source is defined.

Related Topics

For more information on...	See...
Transaction Source screen	Transaction Source on page 1109

Editing a Transaction Source

Prerequisites

To edit a transaction source, you should have:

- Account identifier types defined in the application

Procedure

To edit a transaction source:

- Search for the transaction source in the **Transaction Source** screen.
- In the **Search Results** section, click the **Edit** (✎) icon in the **Edit** column corresponding to the transaction source whose details you want to edit.

The **Transaction Source** screen appears. It contains the following fields:

Field Name	Field Description	Mandatory (Yes or No)
Transaction Source	Displays the transaction source.	Not applicable
Description	Used to specify the description for the transaction source.	Yes
Account Identifier Type	Used to indicate the type of account identifier that will be received from the transaction source.	Yes

- Modify the required details in the **Transaction Source** screen.
- Click **Save**.

The changes made to the transaction source are saved.

Related Topics

For more information on...	See...
How to search for a transaction source	Searching for a Transaction Source on page 1110

Copying a Transaction Source

Instead of creating a transaction source from scratch, you can create a new transaction source using an existing transaction source. This is possible through copying a transaction source. On copying a transaction source, the details including the description and account identifier type are also copied to the new transaction source. You can then edit the details, if required.

Prerequisites

To copy a transaction source, you should have:

- Transaction source (whose copy you want to create) defined in the application
- Account identifier types defined in the application

Procedure

To copy a transaction source:

1. Search for the transaction source in the **Transaction Source** screen.
2. In the **Search Results** section, click the **Copy** (📄) icon in the **Copy** column corresponding to the transaction source whose copy you want to create.

The **Transaction Source** screen appears. It contains the following fields:

Field Name	Field Description	Mandatory (Yes or No)
Transaction Source	Used to specify the transaction source.	Yes
	Note: You cannot specify any special character except underscore (_) in the Transaction Source field.	
Description	Used to specify the description for the transaction source.	Yes
Account Identifier Type	Used to indicate the type of account identifier that will be received from the transaction source.	Yes

3. Enter the required details in the **Transaction Source** screen.
4. Click **Save**.

The new transaction source is defined.

Related Topics

For more information on...	See...
How to search for a transaction source	Searching for a Transaction Source on page 1110
Transaction Source screen	Transaction Source on page 1109

Deleting a Transaction Source

Procedure

To delete a transaction source:

1. Search for the transaction source in the **Transaction Source** screen.
2. In the **Search Results** section, click the **Delete** (🗑️) icon in the **Delete** column corresponding to the transaction source that you want to delete.

A message appears confirming whether you want to delete the transaction source.

3. Click **OK**.

The transaction source is deleted.

Note: You can delete a transaction source only when it is not yet used in the system.

Related Topics

For more information on...	See...
How to search for a transaction source	Searching for a Transaction Source on page 1110

Transaction Record Type

The **Transaction Record Type** screen allows you to define, edit, delete, and copy a transaction record type. While defining a transaction record type, you need to define a rule type. This rule type is invoked for transactions with the transaction source and record type combination. While defining a rule type, you can select the transaction detail fields that you want to use as input or output parameters in a rule.

Besides using the transaction detail fields, the system allows you to use fields which are not part of the standard transaction details. These fields are referred to as temporary fields and are defined similar to other fields, but are not associated with any ORMB tables. You need to associate temporary fields with the rule type while defining a transaction record type. Once associated, you can use the temporary field as input or output parameter while defining a rule using the rule type.

Note: At present, you can only associate a temporary field with a rule type, but cannot use the temporary field in a rule which is created using the rule type. The latter part of the functionality will be available in a future release of Oracle Revenue Management and Billing.

The **Transaction Record Type** screen consists of the following zones:

- [Search Transaction Record Type](#) on page 1113

Search Transaction Record Type

The **Search Transaction Record Type** zone allows you to search for a transaction record type. This zone contains the following two sections:

- **Search Criteria** - The **Search Criteria** section contains the following fields:

Field Name	Field Description	Mandatory (Yes or No)
Transaction Source	Used to search transaction record types defined for a particular transaction source.	No

Field Name	Field Description	Mandatory (Yes or No)
Transaction Record Type	Used to search a particular transaction record type.	No
Description	Used to search transaction record types with a particular description.	No

- **Search Results** - On clicking the **Search** button, the search results appear based on the specified search criteria. The **Search Results** section contains the following columns:

Column Name	Column Description
Transaction Record Type	Displays the transaction record type.
Description	Displays the description of the transaction record type.
Transaction Source	Indicates the transaction source for which the transaction record type is defined.
Rule Type	Indicates the rule type that is invoked for the transaction record type. Note: It has a link. On clicking the link, the View Rule Type screen appears where you can view the details of the respective rule type.
Edit	On clicking the Edit (✎) icon, the Transaction Record Type screen appears where you can edit the details of the transaction record type.
Delete	On clicking the Delete (🗑) icon, you can delete the transaction record type. Note: You can delete a transaction record type when: <ul style="list-style-type: none"> • It is not yet used. • Rules are not yet defined using the rule type which is invoked by the transaction source and record type combination.
Copy	On clicking the Copy (📄) icon, the Transaction Record Type screen appears where you can create a new transaction record type using an existing transaction record type.

You can create a new transaction record type by clicking the **Add** link in the upper right corner of this zone.

Related Topics

For more information on...	See...
How to search for a transaction record type	Searching for a Transaction Record Type on page 1114
How to define a transaction record type	Defining a Transaction Record Type on page 1115
How to edit a transaction record type	Editing a Transaction Record Type on page 1120
How to delete a transaction record type	Deleting a Transaction Record Type on page 1125
How to copy a transaction record type	Copying a Transaction Record Type on page 1126

Searching for a Transaction Record Type

Procedure

To search for a transaction record type:

1. Click the **Admin** link in the **Application** toolbar.
A list appears.
2. From the **Admin** menu, select **T** and then click **Transaction Record Type**.
The **Transaction Record Type** screen appears.
3. Enter the search criteria in the **Search Transaction Record Type** zone.

Note: ORMB search engine supports wildcard search, where you can substitute the percentage (%) symbol as a stand in for any word or letter in a search criteria. You can use the ‘%’ wildcard character in all input fields except the date and ID fields. The ‘%’ wildcard character is suffixed automatically at the end of the partial search criteria. Therefore, you may or may not specify the wildcard character at the end of the partial search criteria. However, you have to prefix the wildcard character manually wherever required.

4. Click **Search**.
The search results appear.

Related Topics

For more information on...	See...
Transaction Record Type screen	Transaction Record Type on page 1113
Search Transaction Record Type zone	Search Transaction Record Type on page 1113

Defining a Transaction Record Type

Prerequisites

To define a transaction record type, you should have:

- Transaction sources defined in the application
- Validation algorithm defined using the **C1-RULE-VAL** algorithm type
- Transaction Information String algorithm defined using the **C1-TXDETINFO** algorithm type
- Fields (that you want to use as input or output parameter) defined in the application

Procedure

To define a transaction record type:

1. Click the **Admin** link in the **Application** toolbar.
A list appears.
2. From the **Admin** menu, select **T** and then click **Transaction Record Type**.
The **Transaction Record Type** screen appears.
3. Click the **Add** link in the upper right corner of the **Search Transaction Record Type** zone.

The **Transaction Record Type** screen appears. It contains the following fields:

Field Name	Field Description	Mandatory (Yes or No)
Transaction Source	Used to indicate the transaction source for which you want to define the transaction record type.	Yes

Field Name	Field Description	Mandatory (Yes or No)
	<p>Note:</p> <p>The Search (🔍) icon appears corresponding to this field. On clicking the Search icon, the Search Transaction Source window appears.</p>	
Transaction Record Type	<p>Used to specify the transaction record type.</p> <p>Note: You cannot specify any special character except underscore (_) in the transaction record type.</p>	Yes
Description	Used to specify the description for the transaction record type.	Yes
Rule Type	<p>Used to specify the rule type.</p> <p>Note: You cannot specify any special character except underscore (_) in the rule type.</p>	Yes
Rule Type Description	Used to specify the description for the rule type.	Yes
Rule Validation Algorithm	<p>Used to specify the validation algorithm that will be triggered when a rule is defined using the rule type.</p> <p>Note: This algorithm checks whether:</p> <ul style="list-style-type: none"> • The values specified against the output parameters exist in the system • The same price item parameter (for example, PCD1_1_1_VAL) is not used multiple times for a division, account, and price item combination <p>The Search (🔍) icon appears corresponding to this field. On clicking the Search icon, the Algorithm Search window appears.</p>	No
Info String Algorithm	<p>Used to specify the algorithm that will generate the information string which appears in the Transaction Information column throughout the application.</p> <p>Note: This algorithm concatenates the fields (related to the transaction) and delimiters specified as parameters in the algorithm.</p> <p>The Search (🔍) icon appears corresponding to this field. On clicking the Search icon, the Algorithm Search window appears.</p>	No
Maximum Accounts to be charged	<p>Used to indicate the maximum number of accounts which can bear the charges for a transaction. The valid values are:</p> <ul style="list-style-type: none"> • 01 	Yes

Field Name	Field Description	Mandatory (Yes or No)
	<ul style="list-style-type: none"> • 02 • 03 • 04 • 05 • 06 • 07 • 08 • 09 • 10 <p>Note: At present, the system supports maximum 10 accounts which can bear the charges for a transaction.</p>	
Maximum Price Items to be mapped	<p>Used to indicate the maximum number of price items to which a transaction can be mapped for each account. The valid values are:</p> <ul style="list-style-type: none"> • 01 • 02 • 03 • 04 • 05 • 06 • 07 • 08 • 09 • 10 <p>Note: At present, the system supports maximum 10 price items to which a transaction can be mapped for each account.</p>	Yes
Maximum Price Item Parameters	<p>Used to indicate the maximum number of parameters that can be used with each price item to determine the price item pricing. The valid values are:</p> <ul style="list-style-type: none"> • 00 • 01 • 02 • 03 • 04 • 05 • 06 	Yes

Field Name	Field Description	Mandatory (Yes or No)
	<ul style="list-style-type: none"> • 07 • 08 • 09 • 10 • 11 • 12 • 13 • 14 • 15 	
	<p>Note: At present, the system supports maximum 15 parameters that can be used with each price item to determine the price item pricing.</p>	

In addition, this screen contains the following two sections:

- **Input/Output Parameters** — Enables you to select the transaction detail fields that you can use as input or output parameter while defining a rule. It contains the following fields:

Field Name	Field Description	Mandatory (Yes or No)
Rule Input/Output	Used to indicate whether you want to use the transaction detail field as input or output parameter.	No
Transaction Field	Displays the transaction field name.	Not applicable
Business Label	Used to specify a business label for the user defined fields.	No
	<p>Note: The business label appears when you add, copy, or view a transaction in the Transaction Details screen. The label changes depending on the transaction source and record type combination that you have selected.</p>	

Note: At present, you can use the following transaction fields as input or output parameter while defining a rule — Account Identifier (ACCT_NBR), Account Identifier Type (ACCT_NBR_TYPE_CD), Division (CIS_DIVISION), Currency Code (CURRENCY_CD), Customer Reference Number (CUST_REF_NBR), Do not Aggregate Switch (DO_NOT_AGG_SW), External Reference Number (EXT_TXN_NBR), Credit/Debit Indicator (HOW_TO_USE_TXN_FLG), Manual Entry (MANUAL_SW), Transaction Amount (TXN_AMT), Transaction Date (TXN_DTTM), Transaction Record Type (TXN_REC_TYPE_CD), Transaction Source (TXN_SOURCE_CD), Transaction Upload Date (TXN_UPLOAD_DTTM), Transaction Volume (TXN_VOL), Additional Amount 1 (UDF_AMT_1), Additional Amount 2 (UDF_AMT_2), Additional Amount 3 (UDF_AMT_3), Additional Amount 4 (UDF_AMT_4), Additional Amount 5 (UDF_AMT_5), Additional Amount 6 (UDF_AMT_6), Additional Amount 7 (UDF_AMT_7), Additional Amount 8 (UDF_AMT_8), Additional Amount 9 (UDF_AMT_9), Additional Amount 10 (UDF_AMT_10), Additional Data 1 (UDF_CHAR_1), Additional Data 2 (UDF_CHAR_2), Additional Data 3 (UDF_CHAR_3), Additional Data 4 (UDF_CHAR_4), Additional Data 5 (UDF_CHAR_5), Additional Data 6 (UDF_CHAR_6), Additional Data 7 (UDF_CHAR_7), Additional Data 8 (UDF_CHAR_8), Additional Data 9 (UDF_CHAR_9), Additional Data 10 (UDF_CHAR_10), Additional Data 11 (UDF_CHAR_11), Additional Data 12 (UDF_CHAR_12), Additional Data 13 (UDF_CHAR_13), Additional Data 14 (UDF_CHAR_14), Additional Data 15 (UDF_CHAR_15), Additional Data 16 (UDF_CHAR_16), Additional Data 17 (UDF_CHAR_17), Additional Data 18 (UDF_CHAR_18), Additional Data 19 (UDF_CHAR_19), Additional Data 20 (UDF_CHAR_20), Additional Data 21 (UDF_CHAR_21), Additional Data 22 (UDF_CHAR_22), Additional Data 23 (UDF_CHAR_23), Additional Data 24 (UDF_CHAR_24), Additional Data 25 (UDF_CHAR_25), Additional Data 26 (UDF_CHAR_26), Additional Data 27 (UDF_CHAR_27), Additional Data 28 (UDF_CHAR_28), Additional Data 29 (UDF_CHAR_29), Additional Data 30 (UDF_CHAR_30), Additional Data 31 (UDF_CHAR_31), Additional Data 32 (UDF_CHAR_32), Additional Data 33 (UDF_CHAR_33), Additional Data 34 (UDF_CHAR_34), Additional Data 35 (UDF_CHAR_35), Additional Data 36 (UDF_CHAR_36), Additional Data 37 (UDF_CHAR_37), Additional Data 38 (UDF_CHAR_38), Additional Data 39 (UDF_CHAR_39), Additional Data 40 (UDF_CHAR_40), Additional Data 41 (UDF_CHAR_41), Additional Data 42 (UDF_CHAR_42), Additional Data 43 (UDF_CHAR_43), Additional Data 44 (UDF_CHAR_44), Additional Data 45 (UDF_CHAR_45), Additional Data 46 (UDF_CHAR_46), Additional Data 47 (UDF_CHAR_47), Additional Data 48 (UDF_CHAR_48), Additional Data 49 (UDF_CHAR_49), Additional Data 50 (UDF_CHAR_50), Amount 1 Currency Code (UDF_CURRENCY_CD_1), Amount 2 Currency Code (UDF_CURRENCY_CD_2), Amount 3 Currency Code (UDF_CURRENCY_CD_3), Amount 4 Currency Code (UDF_CURRENCY_CD_4), Amount 5 Currency Code (UDF_CURRENCY_CD_5), Amount 6 Currency Code (UDF_CURRENCY_CD_6), Amount 7 Currency Code (UDF_CURRENCY_CD_7), Amount 8 Currency Code (UDF_CURRENCY_CD_8), Amount 9 Currency Code (UDF_CURRENCY_CD_9), Amount 10 Currency Code (UDF_CURRENCY_CD_10), Additional Date 1 (UDF_DTTM_1), Additional Date 2 (UDF_DTTM_2), Additional Date 3 (UDF_DTTM_3), Additional Date 4 (UDF_DTTM_4), Additional Date 5 (UDF_DTTM_5), Additional Numeric Data 1 (UDF_NBR_1), Additional Numeric Data 2 (UDF_NBR_2), Additional Numeric Data 3 (UDF_NBR_3), Additional Numeric Data 4 (UDF_NBR_4), Additional Numeric Data 5 (UDF_NBR_5), Additional Numeric Data 6 (UDF_NBR_6), Additional Numeric Data 7 (UDF_NBR_7), Additional Numeric Data 8 (UDF_NBR_8), Additional Numeric Data 9 (UDF_NBR_9), Additional Numeric Data 10 (UDF_NBR_10), Additional Numeric Data 11 (UDF_NBR_11), Additional Numeric Data 12 (UDF_NBR_12), Additional Numeric Data 13 (UDF_NBR_13), Additional Numeric Data 14 (UDF_NBR_14), Additional Numeric Data 15 (UDF_NBR_15), Additional Numeric Data 16 (UDF_NBR_16), Additional Numeric Data 17 (UDF_NBR_17), Additional Numeric Data 18 (UDF_NBR_18), Additional Numeric Data 19 (UDF_NBR_19), Additional Numeric Data 20 (UDF_NBR_20).

- **Temporary Fields** — Enables you to select non-transactional fields that you can use as input or output parameter while defining a rule. It contains the following fields:

Field Name	Field Description	Mandatory (Yes or No)
Temporary Field	Used to indicate the non-transactional field that you want to use as input or output parameter.	No

Field Name	Field Description	Mandatory (Yes or No)
	<p>Note:</p> <p>The Search (🔍) icon appears corresponding to this field. On clicking the Search icon, the Transaction Record Type Tempo Field Search window appears.</p>	

4. Enter the required details.

Note: You can search for a transaction source and algorithm by clicking the **Search** (🔍) icon corresponding to the respective field.

5. Select the check box corresponding to the transaction fields that you want to use as input or output parameters.
6. If required, you can select a non-transactional field as input or output parameter in the **Temporary Fields** section.

Note:

You can search for a field by clicking the **Search** (🔍) icon corresponding to the respective field.

If you want to add more than one temporary field to the transaction record type, click the **Add** (+) icon and then repeat step 7. However, if you want to remove a temporary field from the transaction record type, click the **Delete** (🗑️) icon corresponding to the temporary field.

7. Click **Save**.

The transaction record type is defined.

Related Topics

For more information on...	See...
Transaction Record Type screen	Transaction Record Type on page 1113
Search Transaction Record Type zone	Search Transaction Record Type on page 1113

Editing a Transaction Record Type

Prerequisites

To edit a transaction record type, you should have:

- Validation algorithm defined using the **C1-RULE-VAL** algorithm type
- Transaction Information String algorithm defined using the **C1-TXDETINFO** algorithm type
- Fields (that you want to use as input or output parameter) defined in the application

Procedure

To edit a transaction record type:

1. Search for the transaction record type in the **Transaction Record Type** screen.
2. In the **Search Results** section, click the **Edit** (✎) icon in the **Edit** column corresponding to the transaction record type whose details you want to edit.

The **Transaction Record Type** screen appears. It contains the following fields:

Field Name	Field Description	Mandatory (Yes or No)
Transaction Source	Used to indicate the transaction source for which you want to define the transaction record type.	Yes
	Note: The Search (🔍) icon appears corresponding to this field. On clicking the Search icon, the Search Transaction Source window appears.	
Transaction Record Type	Used to specify the transaction record type.	Yes
	Note: You cannot specify any special character except underscore (_) in the transaction record type.	
Description	Used to specify the description for the transaction record type.	Yes
Rule Type	Used to specify the rule type.	Yes
	Note: You cannot specify any special character except underscore (_) in the rule type.	
Rule Type Description	Used to specify the description for the rule type.	Yes
Rule Validation Algorithm	Used to specify the validation algorithm that will be triggered when a rule is defined using the rule type.	No
	Note: This algorithm checks whether: <ul style="list-style-type: none"> • The values specified against the output parameters exist in the system • The same price item parameter (for example, PCD1_1_1_VAL) is not used multiple times for a division, account, and price item combination The Search (🔍) icon appears corresponding to this field. On clicking the Search icon, the Algorithm Search window appears.	
Info String Algorithm	Used to specify the algorithm that will generate the information string which appears in the Transaction Information column throughout the application.	No
	Note: This algorithm concatenates the fields (related to the transaction) and delimiters specified as parameters in the algorithm. The Search (🔍) icon appears corresponding to this field. On clicking the Search icon, the Algorithm Search window appears.	

Field Name	Field Description	Mandatory (Yes or No)
Maximum Accounts to be charged	<p>Used to indicate the maximum number of accounts which can bear the charges for a transaction. The valid values are:</p> <ul style="list-style-type: none"> • 01 • 02 • 03 • 04 • 05 • 06 • 07 • 08 • 09 • 10 <p>Note: At present, the system supports maximum 10 accounts which can bear the charges for a transaction.</p>	Yes
Maximum Price Items to be mapped	<p>Used to indicate the maximum number of price items to which a transaction can be mapped for each account. The valid values are:</p> <ul style="list-style-type: none"> • 01 • 02 • 03 • 04 • 05 • 06 • 07 • 08 • 09 • 10 <p>Note: At present, the system supports maximum 10 price items to which a transaction can be mapped for each account.</p>	Yes
Maximum Price Item Parameters	<p>Used to indicate the maximum number of parameters that can be used with each price item to determine the price item pricing. The valid values are:</p> <ul style="list-style-type: none"> • 00 • 01 • 02 • 03 	Yes

Field Name	Field Description	Mandatory (Yes or No)
	<ul style="list-style-type: none"> • 04 • 05 • 06 • 07 • 08 • 09 • 10 • 11 • 12 • 13 • 14 • 15 	
	<p>Note: At present, the system supports maximum 15 parameters that can be used with each price item to determine the price item pricing.</p>	

In addition, this screen contains the following two sections:

- **Input/Output Parameters** — Enables you to select the transaction detail fields that you can use as input or output parameter while defining a rule. It contains the following fields:

Field Name	Field Description	Mandatory (Yes or No)
Rule Input/Output	Used to indicate whether you want to use the transaction detail field as input or output parameter.	No
Transaction Field	Displays the transaction field name.	Not applicable
Business Label	Used to specify a business label for the user defined fields.	No
	<p>Note: The business label appears when you add, copy, or view a transaction in the Transaction Details screen. The label changes depending on the transaction source and record type combination that you have selected.</p>	

Note: At present, you can use the following transaction fields as input or output parameter while defining a rule — Account Identifier (ACCT_NBR), Account Identifier Type (ACCT_NBR_TYPE_CD), Division (CIS_DIVISION), Currency Code (CURRENCY_CD), Customer Reference Number (CUST_REF_NBR), Do not Aggregate Switch (DO_NOT_AGG_SW), External Reference Number (EXT_TXN_NBR), Credit/Debit Indicator (HOW_TO_USE_TXN_FLG), Manual Entry (MANUAL_SW), Transaction Amount (TXN_AMT), Transaction Date (TXN_DTTM), Transaction Record Type (TXN_REC_TYPE_CD), Transaction Source (TXN_SOURCE_CD), Transaction Upload Date (TXN_UPLOAD_DTTM), Transaction Volume (TXN_VOL), Additional Amount 1 (UDF_AMT_1), Additional Amount 2 (UDF_AMT_2), Additional Amount 3 (UDF_AMT_3), Additional Amount 4 (UDF_AMT_4), Additional Amount 5 (UDF_AMT_5), Additional Amount 6 (UDF_AMT_6), Additional Amount 7 (UDF_AMT_7), Additional Amount 8 (UDF_AMT_8), Additional Amount 9 (UDF_AMT_9), Additional Amount 10 (UDF_AMT_10), Additional Data 1 (UDF_CHAR_1), Additional Data 2 (UDF_CHAR_2), Additional Data 3 (UDF_CHAR_3), Additional Data 4 (UDF_CHAR_4), Additional Data 5 (UDF_CHAR_5), Additional Data 6 (UDF_CHAR_6), Additional Data 7 (UDF_CHAR_7), Additional Data 8 (UDF_CHAR_8), Additional Data 9 (UDF_CHAR_9), Additional Data 10 (UDF_CHAR_10), Additional Data 11 (UDF_CHAR_11), Additional Data 12 (UDF_CHAR_12), Additional Data 13 (UDF_CHAR_13), Additional Data 14 (UDF_CHAR_14), Additional Data 15 (UDF_CHAR_15), Additional Data 16 (UDF_CHAR_16), Additional Data 17 (UDF_CHAR_17), Additional Data 18 (UDF_CHAR_18), Additional Data 19 (UDF_CHAR_19), Additional Data 20 (UDF_CHAR_20), Additional Data 21 (UDF_CHAR_21), Additional Data 22 (UDF_CHAR_22), Additional Data 23 (UDF_CHAR_23), Additional Data 24 (UDF_CHAR_24), Additional Data 25 (UDF_CHAR_25), Additional Data 26 (UDF_CHAR_26), Additional Data 27 (UDF_CHAR_27), Additional Data 28 (UDF_CHAR_28), Additional Data 29 (UDF_CHAR_29), Additional Data 30 (UDF_CHAR_30), Additional Data 31 (UDF_CHAR_31), Additional Data 32 (UDF_CHAR_32), Additional Data 33 (UDF_CHAR_33), Additional Data 34 (UDF_CHAR_34), Additional Data 35 (UDF_CHAR_35), Additional Data 36 (UDF_CHAR_36), Additional Data 37 (UDF_CHAR_37), Additional Data 38 (UDF_CHAR_38), Additional Data 39 (UDF_CHAR_39), Additional Data 40 (UDF_CHAR_40), Additional Data 41 (UDF_CHAR_41), Additional Data 42 (UDF_CHAR_42), Additional Data 43 (UDF_CHAR_43), Additional Data 44 (UDF_CHAR_44), Additional Data 45 (UDF_CHAR_45), Additional Data 46 (UDF_CHAR_46), Additional Data 47 (UDF_CHAR_47), Additional Data 48 (UDF_CHAR_48), Additional Data 49 (UDF_CHAR_49), Additional Data 50 (UDF_CHAR_50), Amount 1 Currency Code (UDF_CURRENCY_CD_1), Amount 2 Currency Code (UDF_CURRENCY_CD_2), Amount 3 Currency Code (UDF_CURRENCY_CD_3), Amount 4 Currency Code (UDF_CURRENCY_CD_4), Amount 5 Currency Code (UDF_CURRENCY_CD_5), Amount 6 Currency Code (UDF_CURRENCY_CD_6), Amount 7 Currency Code (UDF_CURRENCY_CD_7), Amount 8 Currency Code (UDF_CURRENCY_CD_8), Amount 9 Currency Code (UDF_CURRENCY_CD_9), Amount 10 Currency Code (UDF_CURRENCY_CD_10), Additional Date 1 (UDF_DTTM_1), Additional Date 2 (UDF_DTTM_2), Additional Date 3 (UDF_DTTM_3), Additional Date 4 (UDF_DTTM_4), Additional Date 5 (UDF_DTTM_5), Additional Numeric Data 1 (UDF_NBR_1), Additional Numeric Data 2 (UDF_NBR_2), Additional Numeric Data 3 (UDF_NBR_3), Additional Numeric Data 4 (UDF_NBR_4), Additional Numeric Data 5 (UDF_NBR_5), Additional Numeric Data 6 (UDF_NBR_6), Additional Numeric Data 7 (UDF_NBR_7), Additional Numeric Data 8 (UDF_NBR_8), Additional Numeric Data 9 (UDF_NBR_9), Additional Numeric Data 10 (UDF_NBR_10), Additional Numeric Data 11 (UDF_NBR_11), Additional Numeric Data 12 (UDF_NBR_12), Additional Numeric Data 13 (UDF_NBR_13), Additional Numeric Data 14 (UDF_NBR_14), Additional Numeric Data 15 (UDF_NBR_15), Additional Numeric Data 16 (UDF_NBR_16), Additional Numeric Data 17 (UDF_NBR_17), Additional Numeric Data 18 (UDF_NBR_18), Additional Numeric Data 19 (UDF_NBR_19), Additional Numeric Data 20 (UDF_NBR_20).

- **Temporary Fields** — Enables you to select non-transactional fields that you can use as input or output parameter while defining a rule. It contains the following fields:

Field Name	Field Description	Mandatory (Yes or No)
Temporary Field	Used to indicate the non-transactional field that you want to use as input or output parameter.	No

Field Name	Field Description	Mandatory (Yes or No)
	<p>Note:</p> <p>The Search (🔍) icon appears corresponding to this field. On clicking the Search icon, the Transaction Record Type Tempo Field Search window appears.</p>	

3. Modify the required details.

<p>Note:</p> <p>You can search for an algorithm and field by clicking the Search (🔍) icon corresponding to the respective field.</p> <p>You can edit and remove an input or output parameter from a rule type when it is not yet used in a rule (which is created using the rule type).</p> <p>If you want to add more than one temporary field to the transaction record type, click the Add (+) icon and then specify the details in the Temporary Fields section. However, if you want to remove a temporary field from the transaction record type, click the Delete (🗑️) icon corresponding to the temporary field.</p>

4. Click **Save**.

The changes made to the transaction record type are saved.

Related Topics

For more information on...	See...
How to search for a transaction record type	Searching for a Transaction Record Type on page 1114

Deleting a Transaction Record Type

Procedure

To delete a transaction record type:

1. Search for the transaction record type in the **Transaction Record Type** screen.
2. In the **Search Results** section, click the **Delete** (🗑️) icon in the **Delete** column corresponding to the transaction record type that you want to delete.

A message appears confirming whether you want to delete the transaction record type.

3. Click **OK**.

The transaction record type is deleted.

Note: You can delete a transaction record type only when it is not yet used in the system.

Related Topics

For more information on...	See...
How to search for a transaction record type	Searching for a Transaction Record Type on page 1114

Copying a Transaction Record Type

Instead of creating a transaction record type from scratch, you can create a new transaction record type using an existing transaction record type. This is possible through copying a transaction record type. On copying of a transaction record type, the details including the input or output parameters and temporary fields are also copied to the new transaction record type. You can then edit the details, if required.

Prerequisites

To copy a transaction record type, you should have:

- Transaction record type (whose copy you want to create) defined in the application
- Validation algorithm defined using the **C1-RULE-VAL** algorithm type
- Transaction Information String algorithm defined using the **C1-TXDETINFO** algorithm type
- Fields (that you want to use as input or output parameter) defined in the application

Procedure

To copy a transaction record type:

1. Search for the transaction record type in the **Transaction Record Type** screen.
2. In the **Search Results** section, click the **Copy**  icon in the **Copy** column corresponding to the transaction record type whose copy you want to create.

The **Transaction Record Type** screen appears. It contains the following fields:

Field Name	Field Description	Mandatory (Yes or No)
Transaction Source	Used to indicate the transaction source for which you want to define the transaction record type. Note: The Search  icon appears corresponding to this field. On clicking the Search icon, the Search Transaction Source window appears where you can search for the required transaction source.	Yes
Transaction Record Type	Used to specify the transaction record type. Note: You cannot specify any special character except underscore (_) in the transaction record type.	Yes
Description	Used to specify the description for the transaction record type.	Yes
Rule Type	Used to specify the rule type. Note: You cannot specify any special character except underscore (_) in the rule type.	Yes
Rule Type Description	Used to specify the description for the rule type.	Yes
Rule Validation Algorithm	Used to specify the validation algorithm that will be triggered when a rule is defined using the rule type.	No

Field Name	Field Description	Mandatory (Yes or No)
	<p>Note: This algorithm checks whether:</p> <ul style="list-style-type: none"> • The values specified against the output parameters exist in the system • The same price item parameter (for example, PCD1_1_1_VAL) is not used multiple times for a division, account, and price item combination <p>The Search (🔍) icon appears corresponding to this field. On clicking the Search icon, the Algorithm Search window appears where you can search for the required algorithm.</p>	
Info String Algorithm	<p>Used to specify the algorithm that will generate the information string which appears in the Transaction Information column throughout the application.</p> <p>Note: This algorithm concatenates the fields (related to the transaction) and delimiters specified as parameters in the algorithm.</p> <p>The Search (🔍) icon appears corresponding to this field. On clicking the Search icon, the Algorithm Search window appears where you can search for the required algorithm.</p>	No
Maximum Accounts to be charged	<p>Used to indicate the maximum number of accounts which can bear the charges for a transaction. The valid values are:</p> <ul style="list-style-type: none"> • 01 • 02 • 03 • 04 • 05 • 06 • 07 • 08 • 09 • 10 <p>Note: At present, the system supports maximum 10 accounts which can bear the charges for a transaction.</p>	Yes
Maximum Price Items to be mapped	<p>Used to indicate the maximum number of price items to which a transaction can be mapped for each account. The valid values are:</p> <ul style="list-style-type: none"> • 01 	Yes

Field Name	Field Description	Mandatory (Yes or No)
	<ul style="list-style-type: none"> • 02 • 03 • 04 • 05 • 06 • 07 • 08 • 09 • 10 <div style="border: 1px solid black; padding: 5px; margin-top: 10px;"> <p>Note: At present, the system supports maximum 10 price items to which a transaction can be mapped for each account.</p> </div>	
Maximum Price Item Parameters	<p>Used to indicate the maximum number of parameters that can be used with each price item to determine the price item pricing. The valid values are:</p> <ul style="list-style-type: none"> • 00 • 01 • 02 • 03 • 04 • 05 • 06 • 07 • 08 • 09 • 10 • 11 • 12 • 13 • 14 • 15 <div style="border: 1px solid black; padding: 5px; margin-top: 10px;"> <p>Note: At present, the system supports maximum 15 parameters that can be used with each price item to determine the price item pricing.</p> </div>	Yes

In addition, this screen contains the following two sections:

- **Input/Output Parameters** — Enables you to select the transaction detail fields that you can use as input or output parameter while defining a rule. It contains the following fields:

Field Name	Field Description	Mandatory (Yes or No)
Rule Input/Output	Used to indicate whether you want to use the transaction detail field as input or output parameter.	No
Transaction Field	Displays the transaction field name.	Not applicable
Business Label	Used to specify a business label for the user defined fields.	No
	<p>Note: The business label appears when you add, copy, or view a transaction in the Transaction Details screen. The label changes depending on the transaction source and record type combination that you have selected.</p>	

Note: At present, you can use the following transaction fields as input or output parameter while defining a rule — Account Identifier (ACCT_NBR), Account Identifier Type (ACCT_NBR_TYPE_CD), Division (CIS_DIVISION), Currency Code (CURRENCY_CD), Customer Reference Number (CUST_REF_NBR), Do not Aggregate Switch (DO_NOT_AGG_SW), External Reference Number (EXT_TXN_NBR), Credit/Debit Indicator (HOW_TO_USE_TXN_FLG), Manual Entry (MANUAL_SW), Transaction Amount (TXN_AMT), Transaction Date (TXN_DTTM), Transaction Record Type (TXN_REC_TYPE_CD), Transaction Source (TXN_SOURCE_CD), Transaction Upload Date (TXN_UPLOAD_DTTM), Transaction Volume (TXN_VOL), Additional Amount 1 (UDF_AMT_1), Additional Amount 2 (UDF_AMT_2), Additional Amount 3 (UDF_AMT_3), Additional Amount 4 (UDF_AMT_4), Additional Amount 5 (UDF_AMT_5), Additional Amount 6 (UDF_AMT_6), Additional Amount 7 (UDF_AMT_7), Additional Amount 8 (UDF_AMT_8), Additional Amount 9 (UDF_AMT_9), Additional Amount 10 (UDF_AMT_10), Additional Data 1 (UDF_CHAR_1), Additional Data 2 (UDF_CHAR_2), Additional Data 3 (UDF_CHAR_3), Additional Data 4 (UDF_CHAR_4), Additional Data 5 (UDF_CHAR_5), Additional Data 6 (UDF_CHAR_6), Additional Data 7 (UDF_CHAR_7), Additional Data 8 (UDF_CHAR_8), Additional Data 9 (UDF_CHAR_9), Additional Data 10 (UDF_CHAR_10), Additional Data 11 (UDF_CHAR_11), Additional Data 12 (UDF_CHAR_12), Additional Data 13 (UDF_CHAR_13), Additional Data 14 (UDF_CHAR_14), Additional Data 15 (UDF_CHAR_15), Additional Data 16 (UDF_CHAR_16), Additional Data 17 (UDF_CHAR_17), Additional Data 18 (UDF_CHAR_18), Additional Data 19 (UDF_CHAR_19), Additional Data 20 (UDF_CHAR_20), Additional Data 21 (UDF_CHAR_21), Additional Data 22 (UDF_CHAR_22), Additional Data 23 (UDF_CHAR_23), Additional Data 24 (UDF_CHAR_24), Additional Data 25 (UDF_CHAR_25), Additional Data 26 (UDF_CHAR_26), Additional Data 27 (UDF_CHAR_27), Additional Data 28 (UDF_CHAR_28), Additional Data 29 (UDF_CHAR_29), Additional Data 30 (UDF_CHAR_30), Additional Data 31 (UDF_CHAR_31), Additional Data 32 (UDF_CHAR_32), Additional Data 33 (UDF_CHAR_33), Additional Data 34 (UDF_CHAR_34), Additional Data 35 (UDF_CHAR_35), Additional Data 36 (UDF_CHAR_36), Additional Data 37 (UDF_CHAR_37), Additional Data 38 (UDF_CHAR_38), Additional Data 39 (UDF_CHAR_39), Additional Data 40 (UDF_CHAR_40), Additional Data 41 (UDF_CHAR_41), Additional Data 42 (UDF_CHAR_42), Additional Data 43 (UDF_CHAR_43), Additional Data 44 (UDF_CHAR_44), Additional Data 45 (UDF_CHAR_45), Additional Data 46 (UDF_CHAR_46), Additional Data 47 (UDF_CHAR_47), Additional Data 48 (UDF_CHAR_48), Additional Data 49 (UDF_CHAR_49), Additional Data 50 (UDF_CHAR_50), Amount 1 Currency Code (UDF_CURRENCY_CD_1), Amount 2 Currency Code (UDF_CURRENCY_CD_2), Amount 3 Currency Code (UDF_CURRENCY_CD_3), Amount 4 Currency Code (UDF_CURRENCY_CD_4), Amount 5 Currency Code (UDF_CURRENCY_CD_5), Amount 6 Currency Code (UDF_CURRENCY_CD_6), Amount 7 Currency Code (UDF_CURRENCY_CD_7), Amount 8 Currency Code (UDF_CURRENCY_CD_8), Amount 9 Currency Code (UDF_CURRENCY_CD_9), Amount 10 Currency Code (UDF_CURRENCY_CD_10), Additional Date 1 (UDF_DTTM_1), Additional Date 2 (UDF_DTTM_2), Additional Date 3 (UDF_DTTM_3), Additional Date 4 (UDF_DTTM_4), Additional Date 5 (UDF_DTTM_5), Additional Numeric Data 1 (UDF_NBR_1), Additional Numeric Data 2 (UDF_NBR_2), Additional Numeric Data 3 (UDF_NBR_3), Additional Numeric Data 4 (UDF_NBR_4), Additional Numeric Data 5 (UDF_NBR_5), Additional Numeric Data 6 (UDF_NBR_6), Additional Numeric Data 7 (UDF_NBR_7), Additional Numeric Data 8 (UDF_NBR_8), Additional Numeric Data 9 (UDF_NBR_9), Additional Numeric Data 10 (UDF_NBR_10), Additional Numeric Data 11 (UDF_NBR_11), Additional Numeric Data 12 (UDF_NBR_12), Additional Numeric Data 13 (UDF_NBR_13), Additional Numeric Data 14 (UDF_NBR_14), Additional Numeric Data 15 (UDF_NBR_15), Additional Numeric Data 16 (UDF_NBR_16), Additional Numeric Data 17 (UDF_NBR_17), Additional Numeric Data 18 (UDF_NBR_18), Additional Numeric Data 19 (UDF_NBR_19), Additional Numeric Data 20 (UDF_NBR_20).

- **Temporary Fields** — Enables you to select non-transactional fields that you can use as input or output parameter while defining a rule. It contains the following fields:

Field Name	Field Description	Mandatory (Yes or No)
Temporary Field	Used to indicate the non-transactional field that you want to use as input or output parameter.	No

Field Name	Field Description	Mandatory (Yes or No)
	<p>Note:</p> <p>The Search (🔍) icon appears corresponding to this field. On clicking the Search icon, the Transaction Record Type Tempo Field Search window appears.</p>	

- Enter the required details.

Note: You can search for an algorithm by clicking the **Search** (🔍) icon corresponding to the respective field.

- Select the check box corresponding to the transaction fields that you want to use as input or output parameters.
- If required, you can select a non-transactional field as input or output parameter in the **Temporary Fields** section.

Note:

You can search for a field by clicking the **Search** (🔍) icon corresponding to the respective field.

If you want to add more than one temporary field to the transaction record type, click the **Add** (+) icon and then repeat step 5. However, if you want to remove a temporary field from the transaction record type, click the **Delete** (🗑️) icon corresponding to the temporary field.

- Click **Save**.

The new transaction record type is defined.

Related Topics

For more information on...	See...
How to search for a transaction record type	Searching for a Transaction Record Type on page 1114

Transaction Aggregation Rule

The **Transaction Aggregation Rule** screen allows you to define transaction aggregation rule for an SQL. You can also edit and delete the transaction aggregation rule of an SQL. This screen consists of the following zones:

- [Transaction Aggregation Rules](#) on page 1131

Transaction Aggregation Rules

The **Transaction Aggregation Rules** zone lists transaction aggregation rules that are already defined in the system. You can define, edit, and delete a transaction aggregation rule through this zone.

This zone contains the following columns:

Column Name	Column Description
SQL Description	Displays the description of the service quantity identifier (SQI).
Aggregation Function	Indicates the formula used in the transaction aggregation rule defined for the SQL.

Column Name	Column Description
Function	Indicates the function used for aggregation.
Transaction Parameter	Indicates the transaction parameter used for aggregation.
Edit	On clicking the Edit (✎) icon, the Transaction Aggregation Rule screen appears where you can edit the aggregation rule.
Delete	On clicking the Delete (🗑) icon, you can delete the transaction aggregation rule.

You can define transaction aggregation rule for an SQI by clicking the **Add** link in the upper right corner of this zone. You can also change the layout of this zone. For more information on how to change the layout, see [Changing the Layout](#) on page 4300.

Related Topics

For more information on...	See...
How to define transaction aggregation rule for an SQI	Defining Transaction Aggregation Rule for an SQI on page 1132
How to edit transaction aggregation rule of an SQI	Editing Transaction Aggregation Rule of an SQI on page 1133
How to delete transaction aggregation rule of an SQI	Deleting Transaction Aggregation Rule of an SQI on page 1134

Defining Transaction Aggregation Rule for an SQI

Prerequisites

To define transaction aggregation rule for an SQI, you should have:

- SQI defined in the application

Procedure

To define transaction aggregation rule for an SQI:

1. Click the **Admin** link in the **Application** toolbar.
A list appears.
2. From the **Admin** menu, select **T** and then click **Transaction Aggregation Rule**.
The **Transaction Aggregation Rule** screen appears.
3. Click the **Add** link in the upper right corner of the **Transaction Aggregation Rules** zone.

The **Transaction Aggregation Rule** screen appears. It contains the following fields:

Field Name	Field Description	Mandatory (Yes or No)
SQI	Used to indicate the SQI for which you want to define the transaction aggregation rule.	Yes
Function	Used to indicate the function that you want to use for aggregation. The valid values are: <ul style="list-style-type: none"> • SUM() • MIN() • MAX() 	Yes

Field Name	Field Description	Mandatory (Yes or No)
	<ul style="list-style-type: none"> COUNT() 	
Transaction Parameter	Used to indicate the transaction parameter that you want to use for aggregation. The valid values are: <ul style="list-style-type: none"> TXN_AMT TXN_VOL UDF_AMT_1, UDF_AMT_2, UDF_AMT_3, ..., UDF_AMT_10 UDF_NBR_1, UDF_NBR_2, UDF_NBR_3, ..., UDF_NBR_20 	Yes

- Enter the required details.
- Click **Save**.

The transaction aggregation rule is defined for the SQI.

Related Topics

For more information on...	See...
Transaction Aggregation Rule screen	Transaction Aggregation Rule on page 1131
Transaction Aggregation Rules zone	Transaction Aggregation Rules on page 1131

Editing Transaction Aggregation Rule of an SQI

Procedure

To edit the transaction aggregation rule of an SQI:

- Click the **Admin** link in the **Application** toolbar.
A list appears.
- From the **Admin** menu, select **T** and then click **Transaction Aggregation Rule**.
The **Transaction Aggregation Rule** screen appears.
- Click the **Edit** (✎) icon in the **Edit** column corresponding to the SQI whose transaction aggregation rule you want to edit.

The **Transaction Aggregation Rule** screen appears. It contains the following fields:

Field Name	Field Description	Mandatory (Yes or No)
SQI	Indicates the SQI for which the transaction aggregation rule is defined.	Not applicable
Function	Used to indicate the function that you want to use for aggregation. The valid values are: <ul style="list-style-type: none"> SUM() MIN() MAX() 	Yes

Field Name	Field Description	Mandatory (Yes or No)
	<ul style="list-style-type: none"> • COUNT() 	
Transaction Parameter	Used to indicate the transaction parameter that you want to use for aggregation. The valid values are: <ul style="list-style-type: none"> • TXN_AMT • TXN_VOL • UDF_AMT_1, UDF_AMT_2, UDF_AMT_3, ..., UDF_AMT_10 • UDF_NBR_1, UDF_NBR_2, UDF_NBR_3, ..., UDF_NBR_20 	Yes

4. Modify the required details.

5. Click **Save**.

The changes made to the transaction aggregation rule are saved.

Related Topics

For more information on...	See...
Transaction Aggregation Rule screen	Transaction Aggregation Rule on page 1131
Transaction Aggregation Rules zone	Transaction Aggregation Rules on page 1131

Deleting Transaction Aggregation Rule of an SQI

Procedure

To delete the transaction aggregation rule of an SQI:

1. Click the **Admin** link in the **Application** toolbar.

A list appears.

2. From the **Admin** menu, select **T** and then click **Transaction Aggregation Rule**.

The **Transaction Aggregation Rule** screen appears.

3. Click the **Delete** (🗑️) icon in the **Delete** column corresponding to the SQI whose transaction aggregation rule you want to delete.

A message appears confirming whether you want to delete the transaction aggregation rule.

4. Click **OK**.

The transaction aggregation rule is deleted.

Related Topics

For more information on...	See...
Transaction Aggregation Rule screen	Transaction Aggregation Rule on page 1131
Transaction Aggregation Rules zone	Transaction Aggregation Rules on page 1131

Schedule

The **Schedule** screen allows you to view, define, edit, and delete a schedule. It contains the following zone:

- [Search Schedule](#) on page 1135



Search Schedule

The **Search Schedule** zone allows you to search for a schedule using various search criteria. It contains the following two sections:

- **Search Criteria** - The **Search Criteria** section contains the following fields:

Field Name	Field Description	Mandatory (Yes or No)
Aggregation Schedule	Used to search for a particular schedule.	No
Description	Used to search schedules with a particular description	No

- **Search Results** - On clicking the **Search** button, the search results appear based on the specified search criteria. The **Search Results** section contains the following columns:

Column Name	Column Description
Aggregation Schedule	Displays the schedule.
Description	Displays the description of the schedule.
View	On clicking the View () icon, the View Schedule UI Map screen appears where you can view the details of the schedule.
Edit	On clicking the Edit () icon, the Edit Schedule screen appears where you can edit the details of the schedule.
Delete	On clicking the Delete () icon, you can delete the schedule.
Note: You can delete a schedule only when it is not yet used in the system.	

By default, the **Filter** area is hidden. You can view the **Filter** area by clicking the **Filters** () icon available in the upper right corner of this zone.

Related Topics

For more information on...	See...
How to search for a schedule	Searching for a Schedule on page 1135
How to view the details of a schedule	Viewing the Schedule Details on page 1136
How to define a schedule	Defining a Schedule on page 1136
How to edit a schedule	Editing a Schedule on page 1138
How to delete a schedule	Deleting a Schedule on page 1139

Searching for a Schedule

Procedure

To search for a schedule:

1. Click the **Admin** link in the **Application** toolbar.
A list appears.
2. From the **Admin** menu, select **S** and then click **Schedule**.
The **Schedule** screen appears.
3. Enter the search criteria in the **Search Schedule** zone.

Note: ORMB search engine supports wildcard search, where you can substitute the percentage (%) symbol as a stand in for any word or letter in a search criteria. You can use the ‘%’ wildcard character in all input fields except the date and ID fields. The ‘%’ wildcard character is suffixed automatically at the end of the partial search criteria. Therefore, you may or may not specify the wildcard character at the end of the partial search criteria. However, you have to prefix the wildcard character manually wherever required.

4. Click **Search**.
A list of schedules that meet the search criteria appears in the **Search Results** section.

Related Topics

For more information on...	See...
Schedule screen	Schedule on page 1135
Search Schedule zone	Search Schedule on page 1135

Viewing the Schedule Details**Procedure**

To view the details of a schedule:

1. Search for the schedule in the **Schedule** screen.
2. In the **Search Results** section, click the **View** () icon in the **View** column corresponding to the schedule whose details you want to view.
The **View Schedule UI Map** screen appears.
3. View the details of the schedule in the **View Schedule UI Map** screen.

Related Topics

For more information on...	See...
How to search for a schedule	Searching for a Schedule on page 1135

Defining a Schedule**Prerequisites**

To define a schedule, you should have:

- Schedule types defined in the application.

Procedure

To define a schedule:

1. Click the **Admin** link in the **Application** toolbar.

A list appears.

- From the **Admin** menu, select **S** and then click **Schedule**.

The **Schedule** screen appears.

- Click the **Add** link in the upper right corner of the **Search Schedule** zone.

The **Add/Edit Schedule UI Map** screen appears. It contains the following fields:

Field Name	Field Description	Mandatory (Yes or No)
Aggregation Schedule	Used to specify the schedule code.	Yes
Description	Used to specify the description for the schedule.	Yes

In addition, the **Add/Edit Schedule UI Map** screen contains the following two sections:

- Schedule Periods** - Used to specify schedule periods for the schedule. It contains the following fields in a grid:

Field Name	Field Description	Mandatory (Yes or No)
Start Date	Used to specify the start date of the schedule period.	Yes
	Note: The start date cannot be later than the end date.	
End Date	Used to specify the end date of the schedule period.	Yes
	Note: The end date cannot be earlier than the start date.	

Note: At least one schedule period must be defined for the schedule. Also, ensure that the schedule periods do not have overlapping days.

- Schedule Types** - Used to associate schedule types with the schedule. It contains the following field in a grid:

Field Name	Field Description	Mandatory (Yes or No)
Schedule Type	Used to indicate the functionality where you want to use the schedule.	Yes
	Note: You can associate multiple schedule types with a schedule.	

- Enter the required details in the **Add/Edit Schedule UI Map** screen.
- If you want to define more than one schedule period for the schedule, click the **Add (+)** icon corresponding to the schedule period and then specify the *details*.

Note: However, if you want to remove a schedule period from the schedule, click the **Delete** (🗑️) icon corresponding to the schedule period.

6. Similarly, If you want to associate more than one schedule type with the schedule, click the **Add (+)** icon corresponding to the schedule type and then specify the *details*.

Note: However, if you want to remove a schedule type from the schedule, click the **Delete** (🗑️) icon corresponding to the schedule type.

7. Click **Save**.

The schedule is defined.

Related Topics

For more information on...	See...
Schedule screen	Schedule on page 1135
Search Schedule zone	Search Schedule on page 1135

Editing a Schedule

Prerequisites

To edit a schedule, you should have:

- Schedules (which you want to edit) defined in the application
- Schedule types defined in the application.

Procedure

To edit a schedule:

1. Search for the schedule in the **Schedule** screen.
2. In the **Search Results** section, click the **Edit** (✎) icon in the **Edit** column corresponding to the schedule whose details you want to edit.

The **Add/Edit Schedule UI Map** screen appears. It contains the following fields:

Field Name	Field Description	Mandatory (Yes or No)
Schedule	Displays the schedule code.	Not applicable
Description	Used to specify the description for the schedule.	Yes

In addition, this screen contains the following two sections:

- **Schedule Periods** - Used to add, edit, or delete the schedule periods from the schedule. It contains the following fields in a grid:

Field Name	Field Description	Mandatory (Yes or No)
Start Date	Used to specify the start date of the schedule period.	Yes
	Note: The start date cannot be later than the end date.	
End Date	Used to specify the end date of the schedule period.	Yes

Field Name	Field Description	Mandatory (Yes or No)
	Note: The end date cannot be earlier than the start date.	

- **Schedule Types** - Used to associate or disassociate schedule types from the schedule. It contains the following field in a grid:

Field Name	Field Description	Mandatory (Yes or No)
Schedule Type	Used to indicate the functionality where you want to use the schedule.	Yes

3. Modify the required details in the **Add/Edit Schedule UI Map** screen.

4. Click **Save**.

The changes made to the schedule are saved.

Related Topics

For more information on...	See...
How to search for a schedule	Searching for a Schedule on page 1135

Deleting a Schedule

Procedure

To delete a schedule:

1. Search for the schedule in the **Schedule** screen.
2. In the **Search Results** section, click the **Delete** (🗑️) icon in the **Delete** column corresponding to the schedule that you want to delete.

A message appears confirming whether you want to delete the schedule.

Note: You can delete a schedule only when it is not yet used in the system.

3. Click **OK**.

The schedule is deleted.

Related Topics

For more information on...	See...
How to search for a schedule	Searching for a Schedule on page 1135

Disaggregation Request

Through the **Disaggregation Request Creation (C1-DISTG)** batch, you can only create a disaggregation request for an account. However, from the **Disaggregation Request** screen, you can create a disaggregation request for a person, account, price item, price assignment, billable charge, and parent accumulation group. When you create a disaggregation request for a person, the system does not create the disaggregation request for the person. Instead, the system creates the disaggregation request for all accounts of the person (where the person is the main customer) and its child persons.

The **Disaggregation Request** screen allows you to search for disaggregation requests using various search criteria. It also allows you to create and delete a disaggregation request. It contains the following zone:

- [Search Disaggregation Request](#) on page 1140

Search Disaggregation Request

The **Search Disaggregation Request** zone allows you to search for a disaggregation request using various search criteria. It contains the following two sections:

- **Search Criteria** - The **Search Criteria** section contains the following fields:

Field Name	Field Description	Mandatory (Yes or No)
Search By	Used to indicate whether you want to search for a disaggregation request using the person, account, or accumulation group details. The valid values are: <ul style="list-style-type: none"> • Person • Account • Accumulation Group 	Yes
	Note: By default, the Person option is selected.	
Person ID	Used to search disaggregation requests which are created for accounts of a particular person.	No
	Note: This field appears only when the Person option is selected from the Search By list.	
Division	Used to search disaggregation requests which are created for accounts belonging to a particular division.	Yes (Conditional)
	Note: You can only view those divisions to which you have access in the Division list. This field appears only when the Person or Account option is selected from the Search By list.	Note: This field is required while searching for a disaggregation request using the account details.
Person Name	Used to search disaggregation requests which are created for accounts belonging to persons with a particular name.	No
	Note: This field appears only when the Person option is selected from the Search By list.	
Request Source	Used to search disaggregation requests which are created using a particular process. The valid values are:	No

Field Name	Field Description	Mandatory (Yes or No)
	<ul style="list-style-type: none"> AUTOMATIC BATCH MANUAL 	
Person Identifier Type	Used to indicate the person identifier type based on which you want to search disaggregation requests created for a person. Note: This field appears when the Person option is selected from the Search By list.	Yes (Conditional) Note: If you specify the person identifier as a search criteria, you have to select the person identifier type.
Person Identifier	Used to specify the value for the person identifier type based on which you want to search disaggregation requests created for a person. Note: This field appears only when the Person option is selected from the Search By list.	Yes (Conditional) Note: If you specify the person identifier type as a search criteria, you have to specify the person identifier.
Request Created From	Used to search disaggregation requests which are created from a particular date onwards.	Yes (Conditional) Note: This field is required while searching for a disaggregation request using the person or account details.
Request Created Until	Used to search disaggregation requests which are created till a particular date.	Yes (Conditional) Note: This field is required while searching for a disaggregation request using the person or account details.
From Processing Date	Used to search disaggregation requests which are processed from a particular date onwards.	No
To Processing Date	Used to search disaggregation requests which are processed till a particular date.	No
Request Type	Used to search disaggregation requests with a particular request type. The valid values are: <ul style="list-style-type: none"> Account - Used to search disaggregation requests which are created for accounts. Billable Charge - Used to search disaggregation requests which are created for billable charges. Person - Used to search disaggregation requests which are created for all the accounts of a person. 	No

Field Name	Field Description	Mandatory (Yes or No)
	<ul style="list-style-type: none"> • Price Assignment - Used to search disaggregation requests which are created for price assignments. • Price Item - Used to search disaggregation requests which are created for price items. <p>Note: This field appears only when the Person or Account option is selected from the Search By list.</p>	
Request Status	Used to search disaggregation requests which are in a particular status. The valid values are: <ul style="list-style-type: none"> • COMPLETE • PENDING 	No
Price Item	Used to search disaggregation request for an account or for one or more accounts of a person and its child persons where a particular price item is assigned. <p>Note: This field appears only when the Person or Account option is selected from the Search By list.</p>	No
Billable Charge ID	Used to search disaggregation request for an account for which a particular billable charge is created. <p>Note: This field appears only when the Person or Account option is selected from the Search By list.</p>	No
Price Assignment ID	Used to search disaggregation request for an account with a particular price assignment. <p>Note: This field appears only when the Person or Account option is selected from the Search By list.</p>	No
Account ID	Used to search disaggregation requests which are created for a particular account. <p>Note: This field appears only when you select the Account option from the Search By list.</p>	No
Account Identifier Type	Used to indicate the account identifier type based on which you want to search disaggregation requests created for an account. <p>Note: If you specify the account identifier as a search criteria, you have to select the account identifier type.</p>	Yes (Conditional)

Field Name	Field Description	Mandatory (Yes or No)
	Note: This field appears when you select the Account option from the Search By list.	
Account Identifier	Used to specify the value for the account identifier type based on which you want to search disaggregation requests created for an account. Note: This field appears only when you select the Account option from the Search By list.	Yes (Conditional) Note: If you specify the account identifier type as a search criteria, you have to specify the account identifier.
Accumulation Type	Used to indicate the accumulation type based on which you want to search disaggregation requests created for an accumulation group. Note: This field appears only when you select the Accumulation Group option from the Search By list.	No
Parent Accumulation Group ID	Used to search disaggregation requests created for a particular parent accumulation group. Note: This field appears only when you select the Accumulation Group option from the Search By list.	No

- **Search Results** - On clicking the **Search** button, the search results appear based on the specified search criteria. The **Search Results** section contains the following columns:

Column Name	Column Description
Request ID	Displays the disaggregation request ID.
Request Creation Date	Displays the date when the disaggregation request is created.
Status	Indicates the status of the disaggregation request. The valid values are: <ul style="list-style-type: none"> • COMPLETE • PENDING
Account ID	Indicates the account for which the disaggregation request is created.
Person ID	Indicates the person for whom the disaggregation request is created.
Person Information	Displays the concatenated string of information about the person separated by a comma (.). In addition, a context menu appears corresponding to this field which helps in navigating to other screens in the application. Note: It has a link. On clicking the link, the Person screen appears with the details of the respective person.
Account Information	Displays the concatenated string of information about the account separated by a comma (.). In addition, a context menu appears corresponding to this field which helps in navigating to other screens in the application.

Column Name	Column Description
	<p>Note:</p> <p>It has a link. On clicking the link, the Account screen appears with the details of the respective account.</p> <p>This column appears only when you select the Account option from the Search By list.</p>
Processing Date	Displays the date when the disaggregation request is processed.
Request Type	<p>Displays the request type based on which the disaggregation request is processed. The valid values are:</p> <ul style="list-style-type: none"> • Account - Indicates that the disaggregation request is created for an account. • Billable Charge - Indicates that the disaggregation request is created for a billable charge. • Person - Indicates that the disaggregation request is created for a all the accounts of a person. • Price Assignment - Indicates that the disaggregation request is created for a price assignment. • Price Item - Indicates that the disaggregation request is created for a price item.
Price Item Information	<p>Displays the concatenated string of information about the price item for which the disaggregation request is created separated by a comma (,).</p> <p>Note:</p> <p>It has a link. On clicking the link, the Price Item screen appears where you can view the details of the respective price item.</p> <p>The information in this column appears only when the disaggregation request is created for a price item</p>
Pricing Information	<p>Displays the pricing details using which the disaggregation request is processed.</p> <p>Note: It has a link. On clicking the link, the Pricing screen appears where you can view the details of the respective pricing.</p>
Billable Charge ID	<p>Displays the charge id billable for the processed disaggregation request.</p> <p>Note: It has a link. On clicking the link, the Billable Charge ID screen appears where you can view the details of the respective billable charge.</p>
Delete	<p>On clicking the Delete (🗑️) icon, you can delete the disaggregation request.</p> <p>Note: You can delete a disaggregation request only when it is in the Pending status.</p>
Accumulation Information	<p>Displays the accumulation information.</p> <p>Note: This column appears only when you select the Accumulation Group option from the Search By list.</p>

Note: Pagination is used to display limited number of records in this zone. You can use the navigation links, such as **Previous** and **Next** to navigate between pages.

Related Topics

For more information on...	See...
How to search for a disaggregation request	Searching for a Disaggregation Request on page 1145
How to delete a disaggregation request	Deleting a Disaggregation Request on page 1170

Searching for a Disaggregation Request

Procedure

To search for a disaggregation request:

1. Click the **Menu** link in the **Application** toolbar.
A list appears.
2. From the **Main** menu, select **Transaction and Audit Event Management** and then click **Disaggregation Request**.
The **Disaggregation Request** screen appears.
3. Enter the search criteria in the **Search Disaggregation Request** zone.

Note: ORMB search engine supports wildcard search, where you can substitute the percentage (%) symbol as a stand in for any word or letter in a search criteria. You can use the ‘%’ wildcard character in all input fields except the date and ID fields. The ‘%’ wildcard character is suffixed automatically at the end of the partial search criteria. Therefore, you may or may not specify the wildcard character at the end of the partial search criteria. However, you have to prefix the wildcard character manually wherever required.

4. Click **Search**.
A list of disaggregation requests that meet the search criteria appears in the **Search Results** section.

Related Topics

For more information on...	See...
Disaggregation Request screen	Disaggregation Request on page 1139
Search Disaggregation Request zone	Search Disaggregation Request on page 1140

Creating a Disaggregation Request for a Person

Prerequisites

To create a disaggregation request for a person, you should have:

- Person (for whom you want to create the disaggregation request) defined in the application
- Person associated with the division to which the user belongs
- Price list assigned to the person (in case you want to search a person based on an assigned price list)

Procedure

To create a disaggregation request for a person:

1. Click the **Menu** link in the **Application** toolbar.

A list appears.

- From the **Main** menu, select **Transaction and Audit Event Management** and then click **Disaggregation Request**.

The **Disaggregation Request** screen appears.

- Click the **Add** button available in the upper right corner of the **Disaggregation Request** screen.

The **Add Disaggregation Request** screen appears. It contains the following field:

Field Name	Field Description	Mandatory (Yes or No)
Disaggregation Request Type	<p>Used to indicate the entity for which you want to create a disaggregation request. The valid values are:</p> <ul style="list-style-type: none"> Account - Used to create a disaggregation request for an account. <div style="border: 1px solid black; padding: 2px; margin: 5px 0;"> <p>Note: In this case, the system will disaggregate all billable charges of the account.</p> </div> Billable Charge - Used to create a disaggregation request for an account for which a particular billable charge is created. <div style="border: 1px solid black; padding: 2px; margin: 5px 0;"> <p>Note: In this case, the system will disaggregate a specific billable charge of the account.</p> </div> Parent Accumulation Group - Used to create reseeding requests for the accounts using a parent accumulation group and by specifying the accumulation type (i.e. whether it is stop-loss or discount arrangement). <div style="border: 1px solid black; padding: 2px; margin: 5px 0;"> <p>Note: The Parent Accumulation Group option is used to create reseeding requests for accounts which belong to the healthcare domain.</p> </div> Person - Used to create a disaggregation request for one or more accounts of a person and its child persons. <div style="border: 1px solid black; padding: 2px; margin: 5px 0;"> <p>Note: In this case, the system will disaggregate all billable charges of the account.</p> </div> Price Assignment - Used to create a disaggregation request for an account with a particular price assignment. 	Yes

Field Name	Field Description	Mandatory (Yes or No)
	<p>Note: In this case, the system will disaggregate only those billable charges of the account which are created using the respective price assignment.</p> <ul style="list-style-type: none"> • Price Item - Used to create a disaggregation request for an account or for one or more accounts of a person and its child persons where a particular price item is assigned. <p>Note: In this case, the system will disaggregate only those billable charges of the accounts which are created for the respective price item.</p>	

4. Select the **Person** option from the **Disaggregation Request Type** list.

5. Click **OK**.

The **Add Disaggregation Request For Person** screen appears. It contains the following two sections:

- **Search Criteria** - Used to search for a person and its child persons for whose accounts you want to create a disaggregation request. It contains the following fields:

Filed Name	Field Description	Mandatory (Yes or No)
Request Type	Indicates the entity for which you want to create the disaggregation request. The valid value is: <ul style="list-style-type: none"> • Person 	Not applicable
Division	Used to search persons which belong to a particular division. <p>Note: You can view only those divisions to which you have access in the Division list.</p>	Yes
Person ID	Used to search for a particular person. <p>Note: The Search (🔍) icon appears corresponding to the Person ID field. On clicking the Search icon, the Person Search window appears where you can search for the person.</p>	No
Person Name	Used to search persons having a particular name.	No
Person Identifier Type	Used to indicate the person identifier type based on which you want to search for a person.	Yes (Conditional)

Filed Name	Field Description	Mandatory (Yes or No)
		Note: If you specify the person identifier as a search criteria, you have to select the person identifier type.
Person Identifier	Used to specify the value of the person identifier type using which you want to search for a person.	Yes (Conditional) Note: If you select the person identifier type as a search criteria, you have to specify the person identifier.
Price List Assignment Start Date	Used to search for a person based on an assigned price list which is effective from a particular date onwards.	Yes (Conditional) Note: If you specify the price list assignment end date or the assigned price list as a search criteria, you have to specify the price list assignment start date.
Price List Assignment End Date	Used to search for a person based on an assigned price list which is effective till a particular date.	Yes (Conditional) Note: If you specify the price list assignment start date or the assigned price list as a search criteria, you have to specify the price list assignment end date.
Assigned Price List	Used when you want to search for a person to which a particular price list is assigned. Note: The Search (🔍) icon appears corresponding to the Assigned Price List field. On clicking the Search icon, the Price List Search window appears where you can search for the price list.	Yes (Conditional) Note: If you specify the price list assignment start date or the price list assignment end date as a search criteria, you have to specify the assigned price list.
Price Assignment ID	Used to search for a person to whom a particular price item pricing is assigned.	No
Price Item	Used to search for persons to whom a particular price item is assigned.	No

Filed Name	Field Description	Mandatory (Yes or No)
	<p>Note:</p> <p>The Search (🔍) icon appears corresponding to the Price Item field. On clicking the Search icon, the Price Item Search window appears where you can search for the price item.</p> <p>On specifying the price item, the details of the price item appears corresponding to the Price Item field.</p>	
Billable Charge ID	<p>Used to search for a person for whose accounts a particular billable charge is created.</p> <p>Note:</p> <p>The Search (🔍) icon appears corresponding to the Billable Charge ID field. On clicking the Search icon, the Billable Charge Search window appears where you can search for the billable charge.</p> <p>On specifying the billable charge, the details of the billable charge appears corresponding to the Billable Charge ID field.</p>	No

- **Search Results** - On clicking the **Search** button, the search results appear based on the specified search criteria. The **Search Results** section contains the following columns:

Column Name	Column Description
Account Identifier Type	<p>Indicates the account identifier type using which the account is defined in the system.</p> <p>Note: The data appears in this column when you search for an account.</p>
Account Identifier	<p>Displays the value of the account identifier type.</p> <p>Note: The data appears in this column when you search for an account.</p>
Division	Displays the division to which the person belongs.
Person Identifier Type	Indicates the person identifier type using which the person is defined in the system.
Person Identifier	Displays the value of the person identifier type.
Person Name	Displays the name of the person.
Assigned Price List	<p>Displays the price list assigned to the person.</p> <p>Note: The data appears in this column when you search for a person based on an assigned price list.</p>

Column Name	Column Description
Price List Assignment Start Date	Displays the date from when the price list is assigned to the person. Note: The data appears in this column when you search for a person based on an assigned price list.
Price List Assignment End Date	Displays the date till when the price list is assigned to the person. Note: The data appears in this column when you search for a person based on an assigned price list.
Account Information	Displays the concatenated string of information about the account separated by a comma (.). Note: The data appears in this column when you search for an account.
Bill Cycle	Indicates the bill cycle defined for the account. Note: The data appears in this column when you search for an account.

Note:

Pagination is used to display limited number of records in the **Search Results** section. By default, 20 records are displayed in the **Search Results** section. You can change the number of records displayed per page from the **Page Limit** list, if required.

The **Page Limit** list includes only those values which are defined in the **PAGE_NUMBER** lookup field.

You can use the navigation buttons, such as **First** (<<), **Previous** (<), **Next** (>), and **Last** (>>) to navigate between pages. You can also select the page to which you want to navigate from the **Go To** list.

ORMB search engine supports wildcard search, where you can substitute the percentage (%) symbol as a stand in for any word or letter in a search criteria. You can use the '%' wildcard character in all input fields except the date and ID fields. The '%' wildcard character is suffixed automatically at the end of the partial search criteria. Therefore, you may or may not specify the wildcard character at the end of the partial search criteria. However, you have to prefix the wildcard character manually wherever required.

6. Do either of the following:

If you want to...	Then...
Create disaggregation request for one or more persons	<ol style="list-style-type: none"> In the Search Results section, select the check box corresponding to the person for which you want to create a disaggregation request. Click Disaggregate. A message appears confirming that the disaggregation request is created successfully. Click OK. The disaggregation request is created for each account of the person (where the person is the main customer) and its child persons.

If you want to...	Then...
Create disaggregation request for all persons that meet the search criteria	<ol style="list-style-type: none"> 1. Click Disaggregate All. The Disaggregate All Confirmation window appears confirming whether you want to create disaggregation requests for all records. 2. Click OK. The disaggregation request is created for each account of the person (where the person is the main customer) and its child persons.

Related Topics

For more information on...	See...
Disaggregation Request screen	Disaggregation Request on page 1139
Search Disaggregation Request zone	Search Disaggregation Request on page 1140

Creating a Disaggregation Request for an Account

Prerequisites

To create a disaggregation request for an account, you should have:

- Account (for whom you want to create the disaggregation request) defined in the application
- Account associated with the division to which the user belongs
- Price list assigned to the account (in case you want to search an account based on an assigned price list)

Procedure

To create a disaggregation request for an account:

1. Click the **Menu** link in the **Application** toolbar.
A list appears.
2. From the **Main** menu, select **Transaction and Audit Event Management** and then click **Disaggregation Request**.
The **Disaggregation Request** screen appears.
3. Click the **Add** button available in the upper right corner of the **Disaggregation Request** screen.

The **Add Disaggregation Request** screen appears. It contains the following field:

Field Name	Field Description	Mandatory (Yes or No)
Disaggregation Request Type	Used to indicate the entity for which you want to create a disaggregation request. The valid values are: <ul style="list-style-type: none"> • Account - Used to create a disaggregation request for an account. 	Yes

Field Name	Field Description	Mandatory (Yes or No)
	<p data-bbox="690 212 1120 310">Note: In this case, the system will disaggregate all billable charges of the account.</p> <ul data-bbox="657 331 1120 457" style="list-style-type: none"> <li data-bbox="657 331 1120 457">• Billable Charge - Used to create a disaggregation request for an account for which a particular billable charge is created. <p data-bbox="690 485 1120 583">Note: In this case, the system will disaggregate a specific billable charge of the account.</p> <ul data-bbox="657 611 1120 800" style="list-style-type: none"> <li data-bbox="657 611 1120 800">• Parent Accumulation Group - Used to create reseeding requests for the accounts using a parent accumulation group and by specifying the accumulation type (i.e. whether it is stop-loss or discount arrangement). <p data-bbox="690 827 1120 961">Note: The Parent Accumulation Group option is used to create reseeding requests for accounts which belong to the healthcare domain.</p> <ul data-bbox="657 982 1120 1073" style="list-style-type: none"> <li data-bbox="657 982 1120 1073">• Person - Used to create a disaggregation request for one or more accounts of a person and its child persons. <p data-bbox="690 1100 1120 1199">Note: In this case, the system will disaggregate all billable charges of the account.</p> <ul data-bbox="657 1226 1120 1316" style="list-style-type: none"> <li data-bbox="657 1226 1120 1316">• Price Assignment - Used to create a disaggregation request for an account with a particular price assignment. <p data-bbox="690 1344 1120 1478">Note: In this case, the system will disaggregate only those billable charges of the account which are created using the respective price assignment.</p> <ul data-bbox="657 1505 1120 1661" style="list-style-type: none"> <li data-bbox="657 1505 1120 1661">• Price Item - Used to create a disaggregation request for an account or for one or more accounts of a person and its child persons where a particular price item is assigned. <p data-bbox="690 1688 1120 1822">Note: In this case, the system will disaggregate only those billable charges of the accounts which are created for the respective price item.</p>	

4. Select the **Account** option from the **Disaggregation Request Type** list.

5. Click **OK**.

The **Add Disaggregation Request For Account** screen appears. It contains the following two sections:

- **Search Criteria** - Used to search for an account for whose billable charges you want to create a disaggregation request. It contains the following fields:

Filed Name	Field Description	Mandatory (Yes or No)
Request Type	Indicates the entity for which you want to create the disaggregation request. The valid value is: <ul style="list-style-type: none"> • Account 	Not applicable
Division	Used to search accounts which belong to a particular division. Note: You can view only those divisions to which you have access in the Division list.	Yes
Account ID	Used to search for a particular account. Note: The Search (🔍) icon appears corresponding to the Account ID field. On clicking the Search icon, the Account Search window appears where you can search for the account.	No
Bill Cycle	Used to search accounts having a particular bill cycle.	No
Account Identifier Type	Used to indicate the account identifier type based on which you want to search for an account.	Yes (Conditional) Note: If you specify the account identifier as a search criteria, you have to select the account identifier type.
Account Identifier	Used to specify the value of the account identifier type using which you want to search for an account.	Yes (Conditional) Note: If you select the account identifier type as a search criteria, you have to specify the account identifier.
Invoice Currency	Used to search accounts whose billable charges are defined using a particular invoice currency.	No
Assigned Price List	Used when you want to search for an account to which a particular price list is assigned.	Yes (Conditional)

Filed Name	Field Description	Mandatory (Yes or No)
	<p>Note: The Search (🔍) icon appears corresponding to the Assigned Price List field. On clicking the Search icon, the Price List Search window appears where you can search for the price list.</p>	<p>Note: If you specify the price list assignment start date or the price list assignment end date as a search criteria, you have to specify the assigned price list.</p>
Price List Assignment Start Date	Used to search for an account based on an assigned price list which is effective from a particular date onwards.	<p>Yes (Conditional)</p> <p>Note: If you specify the price list assignment end date or the assigned price list as a search criteria, you have to specify the price list assignment start date.</p>
Price List Assignment End Date	Used to search for an account based on an assigned price list which is effective till a particular date.	<p>Yes (Conditional)</p> <p>Note: If you specify the price list assignment start date or the assigned price list as a search criteria, you have to specify the price list assignment end date.</p>
Price Assignment ID	Used to search for an account to which a particular price item pricing is assigned.	No
Price Item	<p>Used to search for accounts to which a particular price item is assigned.</p> <p>Note:</p> <p>The Search (🔍) icon appears corresponding to the Price Item field. On clicking the Search icon, the Price Item Search window appears where you can search for the price item.</p> <p>On specifying the price item, the details of the price item appears corresponding to the Price Item field.</p>	No
Billable Charge ID	Used to search for an account for which a particular billable charge is created.	No

Filed Name	Field Description	Mandatory (Yes or No)
	<p>Note:</p> <p>The Search (🔍) icon appears corresponding to the Billable Charge ID field. On clicking the Search icon, the Billable Charge Search window appears where you can search for the billable charge.</p> <p>On specifying the billable charge, the details of the billable charge appears corresponding to the Billable Charge ID field.</p>	

- **Search Results** - On clicking the **Search** button, the search results appear based on the specified search criteria. The **Search Results** section contains the following columns:

Column Name	Column Description
Account Identifier Type	Indicates the account identifier type using which the account is defined in the system.
Account Identifier	Displays the value of the account identifier type.
Division	Displays the division to which the account belongs.
Person Identifier Type	Indicates the person identifier type using which the person is defined in the system. Note: The data appears in this column when you search for a person.
Person Identifier	Displays the value of the person identifier type. Note: The data appears in this column when you search for a person.
Person Name	Displays the name of the person to whom the account belongs.
Assigned Price List	Displays the price list assigned to the account. Note: The data appears in this column when you search for an account based on an assigned price list.
Price List Assignment Start Date	Displays the date from when the price list is assigned to the account. Note: The data appears in this column when you search for an account based on an assigned price list.
Price List Assignment End Date	Displays the date till when the price list is assigned to the account. Note: The data appears in this column when you search for an account based on an assigned price list.
Account Information	Displays the concatenated string of information about the account separated by a comma (.).
Bill Cycle	Indicates the bill cycle defined for the account.

Note:

Pagination is used to display limited number of records in the **Search Results** section. By default, 20 records are displayed in the **Search Results** section. You can change the number of records displayed per page from the **Page Limit** list, if required.

The **Page Limit** list includes only those values which are defined in the **PAGE_NUMBER** lookup field.

You can use the navigation buttons, such as **First** (<<), **Previous** (<), **Next** (>), and **Last** (>>) to navigate between pages. You can also select the page to which you want to navigate from the **Go To** list.

ORMB search engine supports wildcard search, where you can substitute the percentage (%) symbol as a stand in for any word or letter in a search criteria. You can use the '%' wildcard character in all input fields except the date and ID fields. The '%' wildcard character is suffixed automatically at the end of the partial search criteria. Therefore, you may or may not specify the wildcard character at the end of the partial search criteria. However, you have to prefix the wildcard character manually wherever required.

6. Do either of the following:

If you want to...	Then...
Create disaggregation request for one or more accounts	<ol style="list-style-type: none"> 1. In the Search Results section, select the check box corresponding to the account for which you want to create a disaggregation request. 2. Click Disaggregate. A message appears confirming that the disaggregation request is created successfully. 3. Click OK. The disaggregation request is created for the selected account.
Create disaggregation request for all accounts that meet the search criteria	<ol style="list-style-type: none"> 1. Click Disaggregate All. The Disaggregate All Confirmation window appears confirming whether you want to create disaggregation requests for all records. 2. Click OK. The disaggregation request is created for all the accounts.

Related Topics

For more information on...	See...
Disaggregation Request screen	Disaggregation Request on page 1139
Search Disaggregation Request zone	Search Disaggregation Request on page 1140

Creating a Disaggregation Request for a Price item

Prerequisites

To create a disaggregation request for a price item, you should have:

- Price item (for which you want to create the disaggregation request) defined in the application
- Price item associated with the division to which the user belongs
- Person or accounts defined in the application (in case you want to search for a price item associated to a person or an account)
- Price item associated with the price list (in case you want to search a price item based on an assigned price list)

Procedure

To create a disaggregation request for a price item:

1. Click the **Menu** link in the **Application** toolbar.

A list appears.

2. From the **Main** menu, select **Transaction and Audit Event Management** and then click **Disaggregation Request**.

The **Disaggregation Request** screen appears.

3. Click the **Add** button available in the upper right corner of the **Disaggregation Request** screen.

The **Add Disaggregation Request** screen appears. It contains the following field:

Field Name	Field Description	Mandatory (Yes or No)
Disaggregation Request Type	<p>Used to indicate the entity for which you want to create a disaggregation request. The valid values are:</p> <ul style="list-style-type: none"> • Account - Used to create a disaggregation request for an account. <div style="border: 1px solid black; padding: 2px; margin: 5px 0;"> <p>Note: In this case, the system will disaggregate all billable charges of the account.</p> </div> <ul style="list-style-type: none"> • Billable Charge - Used to create a disaggregation request for an account for which a particular billable charge is created. <div style="border: 1px solid black; padding: 2px; margin: 5px 0;"> <p>Note: In this case, the system will disaggregate a specific billable charge of the account.</p> </div> <ul style="list-style-type: none"> • Parent Accumulation Group - Used to create reseeding requests for the accounts using a parent accumulation group and by specifying the accumulation type (i.e. whether it is stop-loss or discount arrangement). <div style="border: 1px solid black; padding: 2px; margin: 5px 0;"> <p>Note: The Parent Accumulation Group option is used to create reseeding requests for accounts which belong to the healthcare domain.</p> </div>	Yes

Field Name	Field Description	Mandatory (Yes or No)
	<ul style="list-style-type: none"> • Person - Used to create a disaggregation request for one or more accounts of a person and its child persons. <div style="border: 1px solid black; padding: 2px; margin: 5px 0;"> <p>Note: In this case, the system will disaggregate all billable charges of the account.</p> </div> <ul style="list-style-type: none"> • Price Assignment - Used to create a disaggregation request for an account with a particular price assignment. <div style="border: 1px solid black; padding: 2px; margin: 5px 0;"> <p>Note: In this case, the system will disaggregate only those billable charges of the account which are created using the respective price assignment.</p> </div> <ul style="list-style-type: none"> • Price Item - Used to create a disaggregation request for an account or for one or more accounts of a person and its child persons where a particular price item is assigned. <div style="border: 1px solid black; padding: 2px; margin: 5px 0;"> <p>Note: In this case, the system will disaggregate only those billable charges of the accounts which are created for the respective price item.</p> </div>	

4. Select the **Price Item** option from the **Disaggregation Request Type** list.

5. Click **OK**.

The **Add Disaggregation Request For Price Item** screen appears. It contains the following two sections:

- **Search Criteria** - Used to search for a price item assigned to an account for whose billable charges want to create a disaggregation request. It contains the following fields:

Filed Name	Field Description	Mandatory (Yes or No)
Request Type	Indicates the entity for which you want to create the disaggregation request. The valid value is: <ul style="list-style-type: none"> • Price Item 	Not applicable
Division	Used to search price items which belong to a particular division. <div style="border: 1px solid black; padding: 2px; margin-top: 5px;"> <p>Note: You can view only those divisions to which you have access in the Division list.</p> </div>	Yes
Account ID	Used to search price items which are assigned to a particular account.	Yes (Conditional)

Filed Name	Field Description	Mandatory (Yes or No)
	Note: The Search (🔍) icon appears corresponding to the Account ID field. On clicking the Search icon, the Account Search window appears where you can search for the account.	Note: This field is required when you specify the price item in the Price Item field as a search criteria.
Person ID	Used to search price items which are assigned to a particular person. Note: The Search (🔍) icon appears corresponding to the Person ID field. On clicking the Search icon, the Person Search window appears where you can search for the person.	Yes (Conditional) Note: This field is required when you specify the price item in the Price Item field as a search criteria.
Account Identifier Type	Used to search price items assigned to accounts which are created using a particular identifier type.	Yes (Conditional) Note: If you specify the account identifier as a search criteria, you have to select the account identifier type.
Account Identifier	Used to specify the value of the account identifier type.	Yes (Conditional) Note: If you select the account identifier type as a search criteria, you have to specify the account identifier.
Person Identifier Type	Used to search price items assigned to persons which are created using a particular identifier type.	Yes (Conditional) Note: If you specify the person identifier as a search criteria, you have to select the person identifier type.
Person Identifier	Used to specify the value of the person identifier type.	Yes (Conditional) Note: If you select the person identifier type as a search criteria, you have to specify the person identifier.
Bill Cycle	Used to search price items assigned to accounts or accounts of a person having a particular bill cycle.	No
Invoice Currency	Used to search price items assigned to accounts or accounts of a person whose	No

Filed Name	Field Description	Mandatory (Yes or No)
	billable charges are defined using a particular invoice currency.	
Price Item	Used to search for a particular price item. Note: The Search (🔍) icon appears corresponding to the Price Item field. On clicking the Search icon, the Price Item Search window appears where you can search for the price item. On specifying the price item, the details of the price item appears corresponding to the Price Item field.	Yes
Assigned Price List	Used to search price items which belong to a price list assigned to accounts or accounts of a person. Note: The Search (🔍) icon appears corresponding to the Assigned Price List field. On clicking the Search icon, the Price List Search window appears where you can search for the price list.	Yes (Conditional) Note: If you specify the price list assignment start date or the price list assignment end date as a search criteria, you have to specify the assigned price list.
Price List Assignment Start Date	Used to search for price items based on an assigned price list which is effective from a particular date onwards.	Yes (Conditional) Note: If you specify the price list assignment end date or the assigned price list as a search criteria, you have to specify the price list assignment start date.
Price List Assignment End Date	Used to search for price items based on an assigned price list which is effective till a particular date.	Yes (Conditional) Note: If you specify the price list assignment start date or the assigned price list as a search criteria, you have to specify the price list assignment end date.

- **Search Results** - On clicking the **Search** button, the search results appear based on the specified search criteria. The **Search Results** section contains the following columns:

Column Name	Column Description
Account Identifier Type	Indicates the account identifier type using which the account is defined in the system.

Column Name	Column Description
	Note: The data appears in this column when you search for a price item which is assigned to an account.
Account Identifier	Displays the value of the account identifier type. Note: The data appears in this column when you search for a price item which is assigned to an account.
Division	Displays the division to which the price item belongs.
Person Identifier Type	Indicates the person identifier type using which the person is defined in the system. Note: The data appears in this column when you search for a price item which is assigned to a person.
Person Identifier	Displays the value of the person identifier type. Note: The data appears in this column when you search for a price item which is assigned to a person.
Person Name	Displays the name of the person.
Assigned Price List	Displays the assigned price list of the account or the account of a person to which the price item is associated. Note: The data appears in this column when you search for a price item based on an assigned price list.
Price List Assignment Start Date	Displays the date from when the price list is assigned to the account or the account of a person. Note: The data appears in this column when you search for a price item based on an assigned price list.
Price List Assignment End Date	Displays the date till when the price list is assigned to the account or the account of a person. Note: The data appears in this column when you search for a price item based on an assigned price list.
Account Information	Displays the concatenated string of information about the account separated by a comma (,).
Bill Cycle	Indicates the bill cycle defined for the account or accounts of the person to which the price item is assigned.

Note:

Pagination is used to display limited number of records in the **Search Results** section. By default, 20 records are displayed in the **Search Results** section. You can change the number of records displayed per page from the **Page Limit** list, if required.

The **Page Limit** list includes only those values which are defined in the **PAGE_NUMBER** lookup field.

You can use the navigation buttons, such as **First** (<<), **Previous** (<), **Next** (>), and **Last** (>>) to navigate between pages. You can also select the page to which you want to navigate from the **Go To** list.

ORMB search engine supports wildcard search, where you can substitute the percentage (%) symbol as a stand in for any word or letter in a search criteria. You can use the '%' wildcard character in all input fields except the date and ID fields. The '%' wildcard character is suffixed automatically at the end of the partial search criteria. Therefore, you may or may not specify the wildcard character at the end of the partial search criteria. However, you have to prefix the wildcard character manually wherever required.

6. Do either of the following:

If you want to...	Then...
Create disaggregation request for one or more price items	<ol style="list-style-type: none"> 1. In the Search Results section, select the check box corresponding to the person or account for which you want to create a disaggregation request. 2. Click Disaggregate. A message appears confirming that the disaggregation request is created successfully. 3. Click OK. The disaggregation request is created for the selected price item.
Create disaggregation request for all price items that meet the search criteria	<ol style="list-style-type: none"> 1. Click Disaggregate All. The Disaggregate All Confirmation window appears confirming whether you want to create disaggregation requests for all records. 2. Click OK. The disaggregation request is created for all the price items.

Related Topics

For more information on...	See...
Disaggregation Request screen	Disaggregation Request on page 1139
Search Disaggregation Request zone	Search Disaggregation Request on page 1140

Creating a Disaggregation Request for a Price Assignment

Prerequisites

To create a disaggregation request for a price assignment, you should have:

- Price item pricing (whose disaggregation request you want to create) assigned to the account or the accounts of a person or child person

Procedure

To create a disaggregation request for a price assignment:

1. Click the **Menu** link in the **Application** toolbar.

A list appears.

2. From the **Main** menu, select **Transaction and Audit Event Management** and then click **Disaggregation Request**.

The **Disaggregation Request** screen appears.

3. Click the **Add** button available in the upper right corner of the **Disaggregation Request** screen.

The **Add Disaggregation Request** screen appears. It contains the following field:

Field Name	Field Description	Mandatory (Yes or No)
Disaggregation Request Type	<p>Used to indicate the entity for which you want to create a disaggregation request. The valid values are:</p> <ul style="list-style-type: none"> • Account - Used to create a disaggregation request for an account. <div style="border: 1px solid black; padding: 2px; margin: 5px 0;"> <p>Note: In this case, the system will disaggregate all billable charges of the account.</p> </div> <ul style="list-style-type: none"> • Billable Charge - Used to create a disaggregation request for an account for which a particular billable charge is created. <div style="border: 1px solid black; padding: 2px; margin: 5px 0;"> <p>Note: In this case, the system will disaggregate a specific billable charge of the account.</p> </div> <ul style="list-style-type: none"> • Parent Accumulation Group - Used to create reseeding requests for the accounts using a parent accumulation group and by specifying the accumulation type (i.e. whether it is stop-loss or discount arrangement). <div style="border: 1px solid black; padding: 2px; margin: 5px 0;"> <p>Note: The Parent Accumulation Group option is used to create reseeding requests for accounts which belong to the healthcare domain.</p> </div> <ul style="list-style-type: none"> • Person - Used to create a disaggregation request for one or more accounts of a person and its child persons. 	Yes

Field Name	Field Description	Mandatory (Yes or No)
	<p>Note: In this case, the system will disaggregate all billable charges of the account.</p> <ul style="list-style-type: none"> • Price Assignment - Used to create a disaggregation request for an account with a particular price assignment. <p>Note: In this case, the system will disaggregate only those billable charges of the account which are created using the respective price assignment.</p> <ul style="list-style-type: none"> • Price Item - Used to create a disaggregation request for an account or for one or more accounts of a person and its child persons where a particular price item is assigned. <p>Note: In this case, the system will disaggregate only those billable charges of the accounts which are created for the respective price item.</p>	

4. Select the **Price Assignment** option from the **Disaggregation Request Type** list.

5. Click **OK**.

The **Add Disaggregation Request For Price Assignment** screen appears. It contains the following two sections:

- **Search Criteria** - Used to search for an account with a particular price assignment for which you want to create a disaggregation request. It contains the following fields:

Filed Name	Field Description	Mandatory (Yes or No)
Request Type	Indicates the entity for which you want to create the disaggregation request. The valid value is: <ul style="list-style-type: none"> • Price Assignment 	Not applicable
Price Assignment ID	Used to search for an account to which a particular price item pricing is assigned.	Yes

- **Search Results** - On clicking the **Search** button, the search results appear based on the specified search criteria. The **Search Results** section contains the following columns:

Column Name	Column Description
Account Identifier Type	Indicates the account identifier type using which the account is defined in the system. <p>Note: The data appears in this column when the price assignment belongs to an account.</p>
Account Identifier	Displays the value of the account identifier type.

Column Name	Column Description
	Note: The data appears in this column when the price assignment belongs to an account.
Division	Displays the division to which the account belongs.
Person Identifier Type	Indicates the person identifier type using which the person is defined in the system. Note: The data appears in this column when the price assignment belongs to a persons account.
Person Identifier	Displays the value of the person identifier type. Note: The data appears in this column when the price assignment belongs to a persons account.
Person Name	Displays the name of the person to whom the account belongs.
Assigned Price List	Displays the price list assigned to the account. Note: The data appears in this column when the price item pricing is assigned through a price list.
Price List Assignment Start Date	Displays the date from when the price list is assigned to the account. Note: The data appears in this column when the price item pricing is assigned through a price list.
Price List Assignment End Date	Displays the date till when the price list is assigned to the account. Note: The data appears in this column when the price item pricing is assigned through a price list.
Account Information	Displays the concatenated string of information about the account separated by a comma (,).
Bill Cycle	Indicates the bill cycle defined for the account.

Note:

Pagination is used to display limited number of records in the **Search Results** section. By default, 20 records are displayed in the **Search Results** section. You can change the number of records displayed per page from the **Page Limit** list, if required.

The **Page Limit** list includes only those values which are defined in the **PAGE_NUMBER** lookup field.

You can use the navigation buttons, such as **First** (<<), **Previous** (<), **Next** (>), and **Last** (>>) to navigate between pages. You can also select the page to which you want to navigate from the **Go To** list.

ORMB search engine supports wildcard search, where you can substitute the percentage (%) symbol as a stand in for any word or letter in a search criteria. You can use the '%' wildcard character in all input fields except the date and ID fields. The '%' wildcard character is suffixed automatically at the end of the partial search criteria. Therefore, you may or may not specify the wildcard character at the end of the partial search criteria. However, you have to prefix the wildcard character manually wherever required.

6. Do either of the following:

If you want to...	Then...
Create disaggregation request for price assignment of one or more accounts	<ol style="list-style-type: none"> <li data-bbox="805 226 1401 323">1. In the Search Results section, select the check box corresponding to the account for which you want to create a disaggregation request. <li data-bbox="805 350 1401 464">2. Click Disaggregate. A message appears confirming that the disaggregation request is created successfully. <li data-bbox="805 491 1401 604">3. Click OK. The disaggregation request is created for the price assignment of the selected account.
Create disaggregation request for all accounts that meet the search criteria	<ol style="list-style-type: none"> <li data-bbox="805 655 1401 800">1. Click Disaggregate All. The Disaggregate All Confirmation window appears confirming whether you want to create disaggregation requests for all records. <li data-bbox="805 827 1401 940">2. Click OK. The disaggregation request is created for all the price assignments of all accounts.

Related Topics

For more information on...	See...
Disaggregation Request screen	Disaggregation Request on page 1139
Search Disaggregation Request zone	Search Disaggregation Request on page 1140

Creating a Disaggregation Request for a Billable Charge

Prerequisites

To create a disaggregation request for a billable charge, you should have:

- Billable charge (for which you want to create a disaggregation request) created for the account or accounts of the person or child persons

Procedure

To create a disaggregation request for a billable charge:

1. Click the **Menu** link in the **Application** toolbar.
A list appears.
2. From the **Main** menu, select **Transaction and Audit Event Management** and then click **Disaggregation Request**.
The **Disaggregation Request** screen appears.
3. Click the **Add** button available in the upper right corner of the **Disaggregation Request** screen.
The **Add Disaggregation Request** screen appears. It contains the following field:

Field Name	Field Description	Mandatory (Yes or No)
Disaggregation Request Type	<p>Used to indicate the entity for which you want to create a disaggregation request. The valid values are:</p> <ul style="list-style-type: none"> • Account - Used to create a disaggregation request for an account. <div data-bbox="686 405 1125 516" style="border: 1px solid black; padding: 2px;"> <p>Note: In this case, the system will disaggregate all billable charges of the account.</p> </div> <ul style="list-style-type: none"> • Billable Charge - Used to create a disaggregation request for an account for which a particular billable charge is created. <div data-bbox="686 678 1125 789" style="border: 1px solid black; padding: 2px;"> <p>Note: In this case, the system will disaggregate a specific billable charge of the account.</p> </div> <ul style="list-style-type: none"> • Parent Accumulation Group - Used to create reseeding requests for the accounts using a parent accumulation group and by specifying the accumulation type (i.e. whether it is stop-loss or discount arrangement). <div data-bbox="686 1024 1125 1163" style="border: 1px solid black; padding: 2px;"> <p>Note: The Parent Accumulation Group option is used to create reseeding requests for accounts which belong to the healthcare domain.</p> </div> <ul style="list-style-type: none"> • Person - Used to create a disaggregation request for one or more accounts of a person and its child persons. <div data-bbox="686 1297 1125 1409" style="border: 1px solid black; padding: 2px;"> <p>Note: In this case, the system will disaggregate all billable charges of the account.</p> </div> <ul style="list-style-type: none"> • Price Assignment - Used to create a disaggregation request for an account with a particular price assignment. <div data-bbox="686 1543 1125 1682" style="border: 1px solid black; padding: 2px;"> <p>Note: In this case, the system will disaggregate only those billable charges of the account which are created using the respective price assignment.</p> </div> <ul style="list-style-type: none"> • Price Item - Used to create a disaggregation request for an account or for one or more accounts of a person and its child persons where a particular price item is assigned. 	Yes

Field Name	Field Description	Mandatory (Yes or No)
	<p>Note: In this case, the system will disaggregate only those billable charges of the accounts which are created for the respective price item.</p>	

4. Select the **Billable Charge** option from the **Disaggregation Request Type** list.
5. Click **OK**.

The **Add Disaggregation Request For Billable Charge** screen appears. It contains the following two sections:

- **Search Criteria** - Used to search for a billable charge of an account for which you want to create a disaggregation request. It contains the following fields:

Filed Name	Field Description	Mandatory (Yes or No)
Request Type	Indicates the entity for which you want to create the disaggregation request. The valid value is: <ul style="list-style-type: none"> • Billable Charge 	Not applicable
Billable Charge ID	Used to search for a particular billable charge of an account.	Yes

- **Search Results** - On clicking the **Search** button, the search results appear based on the specified search criteria. The **Search Results** section contains the following columns:

Column Name	Column Description
Account Identifier Type	Indicates the account identifier type using which the account is defined in the system. <p>Note: The data appears in this column when the billable charge belongs to an account.</p>
Account Identifier	Displays the value of the account identifier type. <p>Note: The data appears in this column when the billable charge belongs to an account.</p>
Division	Displays the division to which the account belongs.
Person Identifier Type	Indicates the person identifier type using which the person is defined in the system. <p>Note: The data appears in this column when the billable charge belongs to an account of a person or child person.</p>
Person Identifier	Displays the value of the person identifier type. <p>Note: The data appears in this column when the billable charge belongs to an account of a person or child person.</p>
Person Name	Displays the name of the person to whom the account belongs.
Assigned Price List	Displays the price list assigned to the account.

Column Name	Column Description
	Note: The data appears in this column when the price item pricing for which the billable charge is created is assigned through a price list.
Price List Assignment Start Date	Displays the date from when the price list is assigned to the account. Note: The data appears in this column when the price item pricing for which the billable charge is created is assigned through a price list.
Price List Assignment End Date	Displays the date till when the price list is assigned to the account. Note: The data appears in this column when the price item pricing for which the billable charge is created is assigned through a price list.
Account Information	Displays the concatenated string of information about the account separated by a comma (,).
Bill Cycle	Indicates the bill cycle defined for the account.

Note:

Pagination is used to display limited number of records in the **Search Results** section. By default, 20 records are displayed in the **Search Results** section. You can change the number of records displayed per page from the **Page Limit** list, if required.

The **Page Limit** list includes only those values which are defined in the **PAGE_NUMBER** lookup field.

You can use the navigation buttons, such as **First** (<<), **Previous** (<), **Next** (>), and **Last** (>>) to navigate between pages. You can also select the page to which you want to navigate from the **Go To** list.

ORMB search engine supports wildcard search, where you can substitute the percentage (%) symbol as a stand in for any word or letter in a search criteria. You can use the '%' wildcard character in all input fields except the date and ID fields. The '%' wildcard character is suffixed automatically at the end of the partial search criteria. Therefore, you may or may not specify the wildcard character at the end of the partial search criteria. However, you have to prefix the wildcard character manually wherever required.

6. Do either of the following:

If you want to...	Then...
Create disaggregation request for billable charge of one or more accounts	<ol style="list-style-type: none"> In the Search Results section, select the check box corresponding to the account for whose billable charge you want to create a disaggregation request. Click Disaggregate. A message appears confirming that the disaggregation request is created successfully. Click OK. The disaggregation request is created for the billable charge of the selected account.
Create disaggregation request for all billable charges that meet the search criteria	<ol style="list-style-type: none"> Click Disaggregate All.

If you want to...	Then...
	<p>The Disaggregate All Confirmation window appears confirming whether you want to create disaggregation requests for all records.</p> <p>2. Click OK.</p> <p>The disaggregation request is created for all the billable charges of all accounts.</p>

Related Topics

For more information on...	See...
Disaggregation Request screen	Disaggregation Request on page 1139
Search Disaggregation Request zone	Search Disaggregation Request on page 1140

Deleting a Disaggregation Request

Procedure

To delete a disaggregation request:

1. Search for the disaggregation request in the **Disaggregation Request** screen.
2. In the **Search Results** section, click the **Delete** (🗑️) icon in the **Delete** column corresponding to the disaggregation request that you want to delete.
A message appears confirming whether you want to delete the disaggregation request.
3. Click **OK**.
The disaggregation request is deleted.

Note:

You can only delete a disaggregation request which is in the **Pending** status.

If the disaggregation process is already started for a disaggregation request, we recommend you not to delete the disaggregation request from the system. Otherwise, erroneous results might occur.

Related Topics

For more information on...	See...
How to search for a disaggregation request	Searching for a Disaggregation Request on page 1145
Search zone	Search Disaggregation Request on page 1140

Chapter 12

On Demand Billing

Topics:

- [Prerequisites](#)
- [CSV File Format for Banking Usage Data](#)
- [CSV File Format for Insurance Usage Data](#)
- [Usage Record Status Transition](#)
- [File Type](#)
- [On Demand Billing](#)
- [Usage Data Processing](#)

Oracle no longer supports the Off Cycle Billing feature introduced in Oracle Revenue Management and Billing Version 2.2.4.2. Instead, the On Demand Billing feature has been introduced to facilitate adhoc billing. Earlier, you were only able to carry out billing based on the bill cycle (defined for the account). In other words, you were able to generate a bill for a bill cycle using the billable charges whose start and end dates fall within the bill cycle. However, there might be situations where you have received certain billing information after the bill is generated for the bill cycle. In such scenarios, you would like to generate a separate bill for the newly created billable charges. The system now allows you to generate an adhoc bill. However, note that you cannot generate adhoc bills through the **Bill** screen.

A bill is generated using the billable charges. Now, in order to differentiate between the normal and adhoc billable charges, you need to set the **Adhoc Bill** flag for the billable charges. If the value of the **Adhoc Bill** flag is set to **Y**, the system will consider the billable charge during adhoc billing. And, if the value of the **Adhoc Bill** flag is set to **N**, the system will consider the billable charge during regular billing based on the bill cycle.

A new batch named **Adhoc Billing (C1-FABL)** is created which generates adhoc bills. Both, automatically generated and manually created billable charges (with the **Adhoc Bill** flag set to **Y**) are considered during adhoc billing.

With Oracle Revenue Management and Billing V2.4.0.0.0, the On Demand Billing feature has been enhanced to facilitate billing for multiple usage data files in one go. Till now you were only able to create billable charges and bill for only one usage data file at a time using the using the **On Demand Billing** screen. However, there might be situations where you want to upload multiple usage data files and generate billable charges for the usage records (of a single or multiple accounts) that you may want to group together based on certain criteria. For example, you may want to generate billable charges for all debit transactions of one or more accounts. In such scenarios, you can now upload multiple usage data files using a file group and create billable charges for the records uploaded through the **Usage Data Processing** screen. You can create file groups based on various criteria to upload multiple usage data files. For example, you may want to create a file group for uploading usage data files of accounts that need to be billed for the services to be charged for using the credit card facility. You can create a file group using the **On Demand Billing** screen. You can then upload one or more usage data files using the file group through the **Usage Data Processing** screen. Oracle Revenue Management and Billing provides you with a facility to upload usage data received from various product processors or banking applications for billing. You can upload a usage data file in the CSV format. The **Usage Data Processing** screen allows you to upload usage data files for both banking and insurance modules. You need to ensure that the CSV file is in the required format; otherwise the file will not be uploaded in the system. For more information about the CSV file format,

see CSV File Format for Banking and CSV File Format for Insurance. When you upload a usage data file, mapping algorithm parses the flat file in the CSV format and maps the columns in the CSV file to an XML schema named Interface. The validation process starts immediately after the file is uploaded in the system. During the validation process, the system and custom validations (if any) are executed. The status of each usage record is changed to Valid or Invalid depending on whether the usage record was validated successfully or not. Once a usage record is successfully validated, you can submit the valid records and create billable charges for them. Once the usage data files are uploaded and billable charges are generated through the **Usage Data Processing** screen, you can then create and freeze the bills using the **On Demand Billing** screen.

You can optionally configure the system to use the approval workflow process for a usage data file. On submitting a valid record, the approval workflow process routes the usage record to the approver for approval. The approver receives a notification to approve the valid records. The approver can either approve or reject one or more valid records. Once the approver approves a valid record, a billable charge is created for the usage record. However, if the approver rejects a valid record, a notification is sent to the submitter to resolve the usage record. The submitter can then correct the existing data or add missing data (based on the review comments), and can again submit the valid record for approval. Once the valid record is approved, a billable charge is created for the usage record.

The system generates the bills based on the Bill After Date. The Bill After Date indicates the date after which adhoc or normal bills must be generated. In case of adhoc billing, the Bill After Date is specified for a file group using which you can upload one or more usage data files.

While uploading usage data files for adhoc billing, you may or may not specify the Bill After Date for a file group. The system behaves in the following manner when:

- **Bill After Date — Specified:** Adhoc bill is generated for the usage data file and account combination when the Bill After Date is equal to or earlier than the current date.
- **Bill After Date — Not Specified:** During the upload process, the Bill After Date is set to the current date. And, adhoc bill is generated for the usage data file and account combination when the Bill After Date is equal to or earlier than the current date.

In case of regular billing, you may or may not specify the Bill After Date while uploading a usage data file. The system behaves in the following manner when:

- **Bill After Date — Specified:** Normal bill is generated for the account in the bill cycle in which the bill after date falls.
- **Bill After Date — Not Specified:** Normal bill is generated for the account based on the bill cycle defined for the account.

Once the adhoc or normal bills are generated for a usage data file, you can freeze and complete the bills. Oracle Revenue Management and Billing provides you with the ability to freeze and complete adhoc bills generated for a usage data file from the **On Demand Billing** screen.

During the on demand billing process, each usage record of a file goes through various statuses until it is billed to the person. For more information about the usage record statuses, see [Usage Record Status Transition](#) on page 1180.

Prerequisites

To setup the on demand billing process, you need to do the following:

- Ensure approver's user group has access to the **F1-DFLTS** application service
- Create a To Do Type for submitter named **C1-ODBSU** using the following information:
 - **Navigation Option** — C1_SUBMIT
 - **Priority** — Priority 10 – Highest
 - **Message Category** — 17000
 - **Message Number** — 1470
 - **Sort Keys** — Define the following sort keys for the To Do type:

Sort Key	Use as Default	Sort Order
Usage Data ID	Yes	Descending

- **Drill Keys** — Define the following drill keys for the To Do type:
- | Table Name | Field Name |
|-------------|-------------------|
| CI_BCHG_STG | BCHG_HSTG_ID |
| CI_BCHG_STG | FILE_NAME |
| CI_BCHG_STG | BCHG_STG_STAT_FLG |
- Create a To Do Type for approver named **C1-ODBAP** using the following information:
 - **Navigation Option** — CI_NDAP
 - **Priority** — Priority 10 – Highest
 - **Message Category** — 17000
 - **Message Number** — 1470
 - **Sort Keys** — Define the following sort keys for the To Do type:

Sort Key	Use as Default	Sort Order
Usage Data ID	Yes	Descending

- **Drill Keys** — Define the following drill keys for the To Do type:
- | Table Name | Field Name |
|-------------|--------------|
| CI_BCHG_STG | BCHG_HSTG_ID |
| CI_BCHG_STG | FILE_NAME |
- Create a To Do role named **C1-ODBSU** for submitter and **C1-ODBAP** for approver
 - Assign the **C1-ODBSU** To Do type to the **C1-ODBSU** To Do role
 - Assign the **C1-ODBAP** To Do type to the **C1-ODBAP** To Do role
 - Create a To Do role named **C1-ODFU** and assign users to this To Do role. The users who have the **C1-ODFU** To Do role will receive the To Do entries generated while executing the **Upload and Validate Usage Data File (C1-ODFU)** batch.

- Assign the **C1-ODFU** To Do type to the **C1-ODFU** To Do role
- Create a To Do role named **C1-ODBCH** and assign users to this To Do role. The users who have the **C1-ODBCH** To Do role will receive the To Do entries generated while executing the **Billable Charge Creation (C1-ODBCH)** batch.
- Assign the **C1-ODBCH** To Do type to the **C1-ODBCH** To Do role
- Create a To Do role named **C1-FABL** and assign users to this To Do role. The users who have the **C1-FABL** To Do role will receive the To Do entries generated while executing the **Adhoc Billing (C1-FABL)** batch.
- Assign the **C1-FABL** To Do type to the **C1-FABL** To Do role
- Create a To Do role named **C1-FCADH** and assign users to this To Do role. The users who have the **C1-FCADH** To Do role will receive the To Do entries generated while executing the **Freeze and Complete Adhoc Bills (C1-FCADH)** batch.
- Assign the **C1-FCADH** To Do type to the **C1-FCADH** To Do role
- Set e-mail address for the users who are going to use the **On Demand Billing** screen (otherwise To Do entry will not be generated on executing the above batches)
- Create a mapping algorithm using the **C1-CSVPMALGO** algorithm type
- Create a validation algorithm using the **C1-VLDALGO** algorithm type
- Create an extract algorithm using the **C1-EXTALGO** algorithm type
- Create a To Do algorithm using the **C1_ODBDALGO** algorithm type and set the following parameters in the algorithm:
 - **To Do Role for Submitter** — Used to indicate that users with the specified To Do role can only resolve the records which are rejected by the approver.
 - **To Do Type for Submitter** — Used to indicate that a To Do entry of the specified To Do type must be created when the approver rejects the records.
 - **To Do Role for Approver** — Used to indicate that users with the specified To Do role can only approve the records submitted by the submitter.
 - **To Do Type for Approver** — Used to indicate that a To Do entry of the specified To Do type must be created when the submitter submits the valid records for approval.
- Define the required file types in the system
- Define values for the following lookup fields:
 - ODB_CAN_RSN_FLG
 - ODB_REJ_RSN_FLG
 - PAGE_NUMBER
- If you want to create billable charges with future date for a contract, then ensure that the **Use Calendar Billing** option is set to **Allow Advanced Billing** in the respective contract type.
- Create an algorithm using the **C1-ODDFILEIN** algorithm type and attach it to the **Upload File Information** system event in the **Algorithms** tab of the **Installation Options — Framework** screen.

Besides this, you need to setup the following feature configurations:

- On Demand Billing (C1-ODBFC)
- Multi Parameter Based Pricing (C1_PPARAM_FLG)

Note: If you want to use the **On Demand Billing** feature in an ORMB Cloud Service Premium Edition environment, you need to set the **ODB Extendable Lookup and Bucket** option type of the **C1-CFS** feature configuration.

Related Topics

For more information on...	See...
How to set the On Demand Billing (C1-ODBFC) feature configuration	Setting the C1-ODBFC Feature Configuration on page 4333
How to set the Multi Parameter Based Pricing (C1_PPARM_FLG) feature configuration	Setting the C1_PPARM_FLG Feature Configuration on page 4340
How to set the C1-CFS feature configuration	Setting the C1-CFS Feature Configuration on page 4349

CSV File Format for Banking Usage Data

Before uploading a usage data file for banking, you need to ensure that the CSV file contains the following columns:

Column Name	Description	Mandatory (Yes or No)
DATA IDENTIFIER	Used to specify the serial number of the usage record.	No
ACCOUNT ID TYPE	Used to specify the account identifier type.	Yes
ACCOUNT IDENTIFIER	Used to indicate the account to which the usage record belongs.	Yes
START DATE	Used to specify the date from when the price item was used.	No
	Note: You must specify the date in the YYYY-MM-DD format.	
END DATE	Used to specify the date till when the price item was used.	No
	Note: You must specify the date in the YYYY-MM-DD format.	
DIVISION	Used to specify the division to which the usage record belongs.	Yes
DESCRIPTION	Used to specify the description for the usage record. It is shown on the billable charge.	Yes
BILL LINE DESCRIPTION1, BILL LINE DESCRIPTION2,, BILL LINE DESCRIPTION10	Used to specify the description for the line item (charge).	Yes (Conditional)
		Note: This data is required when the charge amount is specified.
AMOUNT1, AMOUNT2,, AMOUNT10	Used to specify the charge amount.	Yes (Conditional)
		Note: This data is required when the bill line description or currency is specified.
CURRENCY1, CURRENCY2,, CURRENCY10	Used to specify the currency in which the amount is charged.	Yes (Conditional)

Column Name	Description	Mandatory (Yes or No)
	Note: If you specify a currency other than the account's invoice currency, the system will do the currency conversion if the appropriate exchange rate is available in the system.	Note: This data is required when the charge amount is specified.
MEMO ONLY1, MEMO ONLY2,, MEMO ONLY10	Used to indicate whether the charge should be included in the bill amount or not. The valid values are: <ul style="list-style-type: none"> • true • false Note: By default, the value will be set to false if the column does not contain any value.	No
SUMMARY1, SUMMARY2,, SUMMARY10	Used to indicate whether the charge should be included in the summary line or not. The valid values are: <ul style="list-style-type: none"> • true • false Note: By default, the value will be set to true if the column does not contain any value.	No
SHOW ON BILL1, SHOW ON BILL2,, SHOW ON BILL10	Used to indicate whether the charge should appear on the person's printed bill or not. The valid values are: <ul style="list-style-type: none"> • true • false Note: By default, the value will be set to true if the column does not contain any value.	No
GL DISTRIBUTION CODE 1, GL DISTRIBUTION CODE 2,, GL DISTRIBUTION CODE 10	Used to specify the distribution code which indicates the GL account associated with the charge.	Yes (Conditional) Note: This data is required when false is specified in the Memo Only column corresponding to the bill line description.
PRICE ITEM	Used to specify the price item code.	Yes
VARIANCE	Used to indicate the variance that must be used along with the price item for determining the price item pricing.	No
PARAM TYPE1, PARAM TYPE2,, PARAM TYPE15	Used to indicate the price item parameter that must be used along with the price item for determining the price item pricing. Note: If the data in these columns will be used for price item parameter mapping, you must not use the equal to (=) and tilde (~) symbols in these columns.	Yes (Conditional) Note: This data is required when the parameter value is specified.

Column Name	Description	Mandatory (Yes or No)
PARAM VALUE1, PARAM VALUE2,, PARAM VALUE15	Used to specify the parameter value. Note: If the data in these columns will be used for price item parameter mapping, you must not use the equal to (=) and tilde (~) symbols in these columns.	Yes (Conditional) Note: This data is required when the parameter type is specified.
SQI1, SQI2,, SQI10	Used to indicate the service quantity identifier that must be used for calculating the price item charges.	Yes (Conditional) Note: This data is required when the service quantity is specified.
SQIVALUE1, SQIVALUE2,, SQIVALUE10	Used to specify the number of units of the service quantity.	Yes (Conditional) Note: This data is required when the SQI is specified.
CHARTYPE1, CHARTYPE2,, CHARTYPE10	Used to indicate the characteristic that must be defined for the billable charge.	Yes (Conditional) Note: This data is required when the characteristic value is specified.
CHARVAL1, CHARVAL2,, CHARVAL10	Used to specify the value of the characteristic type.	Yes (Conditional) Note: This data is required when the characteristic type is specified.

Note:

The column names in the CSV file must be in the Upper case. Otherwise, erroneous results might occur when you upload the usage data file.

While uploading a file using a file type where business labels are defined for usage data fields, the CSV file should contain the business label in the respective column. Otherwise, the usage data file will not be uploaded in the system.

CSV File Format for Insurance Usage Data

Before uploading a usage data file for insurance, you need to ensure that the CSV file contains the following columns:

Column Name	Description	Mandatory (Yes or No)
DATA IDENTIFIER	Used to specify the serial number of the usage record.	No
START DATE	Used to specify the date from when the price item was used. Note: You must specify the date in the YYYY-MM-DD format.	No
END DATE	Used to specify the date till when the price item was used.	No

Column Name	Description	Mandatory (Yes or No)
	Note: You must specify the date in the YYYY-MM-DD format.	
CONTRACT ID	Used to specify the contract ID.	Yes
CHARGE TYPE	Used to indicate the charge type.	No
DESCRIPTION	Used to specify the description for the usage record. It is shown on the billable charge.	Yes
BILL DESCRIPTION1, LINE BILL DESCRIPTION2,, BILL LINE DESCRIPTION10	Used to specify the description for the line item (charge).	Yes (Conditional) Note: This data is required when the charge amount is specified.
AMOUNT1, AMOUNT2,, AMOUNT10	Used to specify the charge amount.	Yes (Conditional) Note: This data is required when the bill line description or currency is specified.
CURRENCY1, CURRENCY2,, CURRENCY10	Used to specify the currency in which the amount is charged. Note: If you specify a currency other than the account's invoice currency, the system will do the currency conversion if the appropriate exchange rate is available in the system.	Yes (Conditional) Note: This data is required when the charge amount is specified.
MEMO ONLY1, MEMO ONLY2,, MEMO ONLY10	Used to indicate whether the charge should be included in the bill amount or not. The valid values are: <ul style="list-style-type: none"> true false Note: By default, the value will be set to false if the column does not contain any value.	No
SUMMARY1, SUMMARY2,, SUMMARY10	Used to indicate whether the charge should be included in the summary line or not. The valid values are: <ul style="list-style-type: none"> true false Note: By default, the value will be set to true if the column does not contain any value.	No
SHOW ON BILL1, SHOW ON BILL2,, SHOW ON BILL10	Used to indicate whether the charge should appear on the person's printed bill or not. The valid values are: <ul style="list-style-type: none"> true false 	No

Column Name	Description	Mandatory (Yes or No)
	Note: By default, the value will be set to true if the column does not contain any value.	
GL DISTRIBUTION CODE 1, GL DISTRIBUTION CODE 2,, GL DISTRIBUTION CODE 10	Used to specify the distribution code which indicates the GL account associated with the charge.	Yes (Conditional) Note: This data is required when false is specified in the Memo Only column corresponding to the bill line description.
PRICE ITEM	Used to specify the price item code.	Yes
VARIANCE	Used to indicate the variance that must be used along with the price item for determining the price item pricing.	No
PARAM TYPE1, PARAM TYPE2,, PARAM TYPE15	Used to indicate the price item parameter that must be used along with the price item for determining the price item pricing. Note: If the data in these columns will be used for price item parameter mapping, you must not use the equal to (=) and tilde (~) symbols in these columns.	Yes (Conditional) Note: This data is required when the parameter value is specified.
PARAM VALUE1, PARAM VALUE2,, PARAM VALUE15	Used to specify the parameter value. Note: If the data in these columns will be used for price item parameter mapping, you must not use the equal to (=) and tilde (~) symbols in these columns.	Yes (Conditional) Note: This data is required when the parameter type is specified.
SQI1, SQI2,, SQI10	Used to indicate the service quantity identifier that must be used for calculating the price item charges.	Yes (Conditional) Note: This data is required when the service quantity is specified.
SQIVALUE1, SQIVALUE2,, SQIVALUE10	Used to specify the number of units of the service quantity.	Yes (Conditional) Note: This data is required when the SQI is specified.
CHARTYPE1, CHARTYPE2,, CHARTYPE10	Used to indicate the characteristic that must be defined for the billable charge.	Yes (Conditional) Note: This data is required when the characteristic value is specified.
CHARVAL1, CHARVAL2,, CHARVAL10	Used to specify the value of the characteristic type.	Yes (Conditional) Note: This data is required when the characteristic type is specified.

Column Name	Description	Mandatory (Yes or No)
RECURRING FLAG	Used to indicate whether recurring bill segments must be created at the intervals defined in the bill period or at the set invoice frequency.	No
BILL PERIOD	Used to indicate the bill period that you want to use for specifying the intervals at which the recurring bill segments must be created.	Yes (Conditional) Note: This data is required when the recurring flag is equal to Bill Period.
FREQUENCY	Used to indicate the invoice frequency at which the recurring bill segments must be created.	Yes (Conditional) Note: This data is required when the recurring flag is equal to Frequency.

Note:

The column names in the CSV file must be in the Upper case. Otherwise, erroneous results might occur when you upload the usage data file.

While uploading a file using a file type where business labels are defined for usage data fields, the CSV file should contain the business label in the respective column. Otherwise, the usage data file will not be uploaded in the system.

Usage Record Status Transition

The following figure graphically indicates how a usage record moves from one status to another during the on demand billing process:

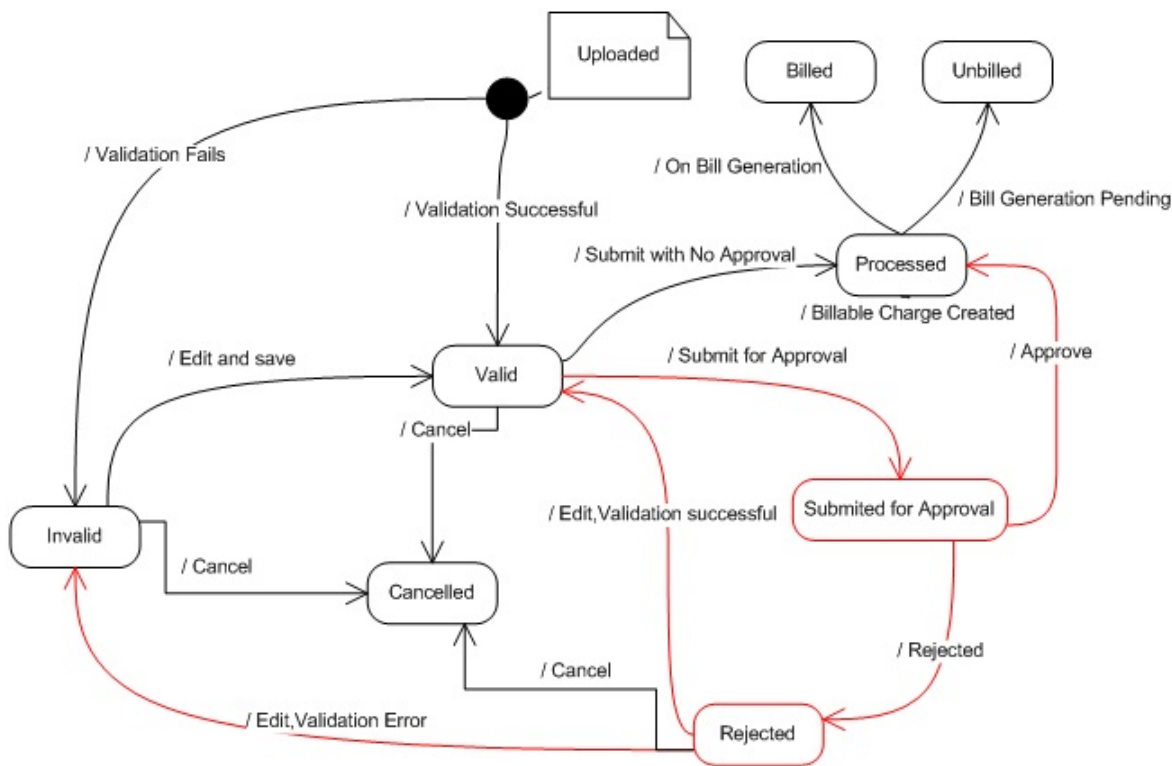

File Type

Oracle Revenue Management and Billing allows you to define file types using which you can upload a usage or payment data file. It is the file type which helps the system to understand how to process the file. The feed type specified in the file type indicates the type of data that you can upload using the file type. You can upload the following types of data using a file type:

- Banking Usage Data
- Insurance Usage Data
- Payment Upload Data

The following table lists the algorithms that you need to specify while defining file types for uploading usage or payment data:

Feed Type	Algorithm	Mandatory (Yes or No)	Algorithm Type Shipped with the Product...	Algorithm Type Purpose
Payment Upload Data	Mapping algorithm	Yes	C1-CSVUPLPAY	Parses the flat file in the CSV format and maps the columns in the CSV file to various tables in the database.
Payment Upload Data	Validation algorithm	Yes	C1-PUPLVALID	Validates a payment data file.
Banking Usage Data	Mapping algorithm	Yes	C1-CSVPMALGO	Parses the flat file in the CSV format and maps the columns in the

Feed Type	Algorithm	Mandatory (Yes or No)	Algorithm Type Shipped with the Product...	Algorithm Type Purpose
				CSV file to an XML schema named Interface .
Banking Usage Data	Validation algorithm	No	C1-VLDALGO	Validates a usage data file.
Banking Usage Data	To Do algorithm	No	C1_ODBTDALGO	Initiates the approval process for usage records before creating the billable charges.
Banking Usage Data	Extract algorithm	No	C1-EXTALGO	Extracts the usage records along with the error messages (if any) in the CSV format.
Insurance Usage Data	Mapping algorithm	Yes	C1-CSVPMALGO	Parses the flat file in the CSV format and maps the columns in the CSV file to an XML schema named Interface .
Insurance Usage Data	Validation algorithm	No	None	-
			Note: You need to design custom algorithm type to validate insurance usage data.	
Insurance Usage Data	To Do algorithm	No	C1_ODBTDALGO	Initiates the approval process for usage records before creating the billable charges.
Insurance Usage Data	Extract algorithm	No	C1-EXTALGO	Extracts the usage records along with the error messages (if any) in the CSV format.

The **File Type** screen allows you to define, edit, and delete a file type. This screen consists of the following zones:

- [File Types](#) on page 1182

File Types

The **File Types** zone lists the file types that are already defined in the system. You can define, edit and delete a file type through this zone.

This zone contains the following columns:

Column Name	Column Description
File Type	Displays the file type.
Description	Displays the description of the file type.
Feed Type	Indicates the type of data that you can upload using the file type. The valid values are: <ul style="list-style-type: none"> • Banking Usage Data • Insurance Usage Data

Column Name	Column Description
	<ul style="list-style-type: none"> Payment Upload Data
Mapping Algorithm	Indicates the mapping algorithm which is triggered when you upload a file.
Validation Algorithm	Indicates the validation algorithm which is triggered once the file is uploaded in the system.
To Do Algorithm	Indicates whether the usage records must be approved before creating the billable charges. If the algorithm is attached, it means the approval is required.
Extract Algorithm	Indicates the extract algorithm which extracts the usage records along with the error messages (if any) in the CSV format.
Edit	<p>On clicking the Edit (✎) icon, the File Type screen appears where you can edit the details of the file type.</p> <p>Note: You can edit the details of a file type when no files are uploaded using the file type.</p>
Delete	<p>On clicking the Delete (🗑) icon, you can delete the file type.</p> <p>Note: You can only delete a file type which is not yet used for uploading a file.</p>

You can define a file type by clicking the **Add** link in the upper right corner of this zone. You can also change the layout of this zone. For more information on how to change the layout, see [Changing the Layout](#) on page 4300.

Related Topics

For more information on...	See...
How to define a file type	Defining a File Type on page 1183
How to edit a file type	Editing a File Type on page 1188
How to delete a file type	Deleting a File Type on page 1193

Defining a File Type

Prerequisites

To define a file type, you should have:

- Mapping algorithm defined using the **C1-CSVUPLPAY** or **C1-CSVPMALGO** algorithm type
- Validation algorithm defined using the **C1-PUPLVALID** or **C1-VLDALGO** algorithm type.
- Extract algorithm defined using the **C1-EXTALGO** algorithm type
- To Do algorithm defined using the **C1_ODBDALGO** algorithm type

Procedure

To define a file type:

- Click the **Admin** link in the **Application** toolbar.
A list appears.
- From the **Admin** menu, select **F** and then click **File Type**.
The **File Type** screen appears.
- Click the **Add** link in the upper right corner of the **File Types** zone.
The **File Type** screen appears. It contains the following fields:

Field Name	Field Description	Mandatory (Yes or No)
File Type	Used to specify the file type.	Yes
Description	Used to specify the description for the file type.	Yes
Feed Type	Used to indicate the type of data that you can upload using the file type. The valid values are: <ul style="list-style-type: none"> • Banking Usage Data • Insurance Usage Data • Payment Upload Data 	Yes
Disable Move to Staging	Used to indicate whether you want to disable the Move to Staging functionality in the Payment Upload screen.	No
	Note: This field appears when you select the Payment Upload Data option from the Feed Type list.	
Mapping Algorithm	Used to attach a mapping algorithm which is triggered when you upload a file.	Yes

Field Name	Field Description	Mandatory (Yes or No)
	<p>Note:</p> <p>The C1-CSVUPLPAY algorithm type is designed for uploading payment data and the C1-CSVPMALGO algorithm type is designed for uploading usage data. The C1-CSVUPLPAY algorithm type does the following:</p> <ol style="list-style-type: none"> 1. Validates whether the file is in the CSV format 2. Validates whether at least one payment record is available in the CSV file 3. Parses the flat file in the CSV format and maps the columns in the CSV file to various tables in the database 4. Uploads the payments records in the pre-staging area <p>However, the C1-CSVPMALGO algorithm type does the following:</p> <ol style="list-style-type: none"> 1. Validates whether the file is in the CSV format 2. Validates whether the CSV file contains data in the required format 3. Validates whether the following data is available for each usage record: <ul style="list-style-type: none"> • Account Identifier Type • Account Identifier • Division • Price Item • Description 4. Parses the flat file in the CSV format and maps the columns in the CSV file to an XML schema named Interface <p>The Search  icon appears corresponding to this field. On clicking the Search icon, the Algorithm Search window appears.</p>	
To Do Algorithm	Used to indicate whether the usage records must be approved before creating the billable charges. If the algorithm is attached, it means the approval is required.	No

Field Name	Field Description	Mandatory (Yes or No)
	<p>Note:</p> <p>The C1_ODBTDALGO algorithm type contains the following parameters:</p> <ul style="list-style-type: none"> • To Do Role For Submitter — Used to indicate that users with the specified To Do role can only resolve the records which are rejected by the approver. • To Do Type For Submitter — Used to indicate that a To Do using the specified To Do type must be created when the approver rejects the records. • To Do Role For Approver — Used to indicate that users with the specified To Do role can only approve the records submitted by the submitter. • To Do Type For Approver — Used to indicate that a To Do using the specified To Do type must be created when the submitter submits the valid records for approval. <p>This field is disabled when you select the Payment Upload Data option from the Feed Type list.</p> <p>The Search (🔍) icon appears corresponding to this field. On clicking the Search icon, the Algorithm Search window appears.</p>	
Validation Algorithm	Used to attach a validation algorithm which is triggered once the file is uploaded in the system.	Yes (Conditional) <div data-bbox="1174 1136 1472 1312" style="border: 1px solid black; padding: 5px; margin-top: 5px;"> <p>Note: This field is required when you select the Payment Upload Data option from the Feed Type list.</p> </div>

Field Name	Field Description	Mandatory (Yes or No)
	<p>Note:</p> <p>The C1-PUPLVALID algorithm type is designed for validating a payment data file. It has some pre-defined validations based on which the status of the payment record is set to Valid, Invalid, or Error. For more information about the pre-defined validations, see Upload Payment Records in the Pre-Staging Area on page 1260.</p> <p>However, the C1-VLDALGO algorithm type is designed for validating a banking usage data file. It checks whether account identifier specified for each usage record contains any special characters. You can define any custom validations in this algorithm, if required. You cannot use an algorithm created using the C1-VLDALGO algorithm type to validate an insurance usage data file. If you want to validate an insurance usage data file, you need to create a custom algorithm type.</p> <p>The Search (🔍) icon appears corresponding to this field. On clicking the Search icon, the Algorithm Search window appears.</p>	
Extract Algorithm	<p>Used to attach an extract algorithm which extracts the usage records along with the error messages (if any) in the CSV format.</p> <p>Note: This field is disabled when you select the Payment Upload Data option from the Feed Type list.</p> <p>The Search (🔍) icon appears corresponding to this field. On clicking the Search icon, the Algorithm Search window appears.</p>	No

In addition, it contains the following two sections:

- **Map Divisions** — Used to indicate the divisions for which you want to use the file type.

Field Name	Field Description	Mandatory (Yes or No)
Division	<p>Used to indicate the division.</p> <p>Note: You can only view those divisions to which you have access in the Division list.</p>	No

Note: This section does not appear when you select the **Payment Upload Data** option from the **Feed Type** list.

- **Custom Labels** — Used to specify business labels for the usage data fields. The usage data fields will change depending on whether you have selected the **Banking Usage Data** or **Insurance Usage Data** option from the **Feed Type** list.

Note:

This section does not appear when you select the **Payment Upload Data** option from the **Feed Type** list.

If you have defined the business label for a usage data field, the CSV file should contain business label in the respective column. Otherwise, the usage data file will not be uploaded in the system.

4. Enter the required details.

Note:

You can search for an algorithm by clicking the **Search** (🔍) icon corresponding to the respective field.

If you want to associate more than one division with the file type, click the **Add** (+) icon and then specify the details in the **Map Divisions** section. However, if you want to remove a division from the file type, click the **Delete** (🗑️) icon corresponding to the division.

5. Click **Save**.

The file type is defined.

Related Topics

For more information on...	See...
File Type screen	File Type on page 1181
File Types zone	File Types on page 1182

Editing a File Type**Prerequisites**

To edit a file type, you should have:

- Mapping algorithm defined using the **C1-CSVUPLPAY** or **C1-CSVPMALGO** algorithm type
- Validation algorithm defined using the **C1-PUPLVALID** or **C1-VLDALGO** algorithm type.
- Extract algorithm defined using the **C1-EXTALGO** algorithm type
- To Do algorithm defined using the **C1_ODBDALGO** algorithm type

Note: You can edit the details of a file type when no files are uploaded using the file type.

Procedure

To edit a file type:

1. Click the **Admin** link in the **Application** toolbar.
A list appears.
2. From the **Admin** menu, select **F** and then click **File Type**.
The **File Type** screen appears.
3. Click the **Edit** (✎) icon in the **Edit** column corresponding to the file type whose details you want to edit.
The **File Type** screen appears. It contains the following fields:

Field Name	Field Description	Mandatory (Yes or No)
File Type	Used to specify the file type.	Yes

Field Name	Field Description	Mandatory (Yes or No)
Description	Used to specify the description for the file type.	Yes
Feed Type	Used to indicate the type of data that you can upload using the file type. The valid values are: <ul style="list-style-type: none"> • Banking Usage Data • Insurance Usage Data • Payment Upload Data 	Yes
Disable Move to Staging	Used to indicate whether you want to disable the Move to Staging functionality in the Payment Upload screen. Note: This field appears when you select the Payment Upload Data option from the Feed Type list.	No
Mapping Algorithm	Used to attach a mapping algorithm which is triggered when you upload a file.	Yes

Field Name	Field Description	Mandatory (Yes or No)
	<p>Note:</p> <p>The C1-CSVUPLPAY algorithm type is designed for uploading payment data and the C1-CSVPMALGO algorithm type is designed for uploading usage data. The C1-CSVUPLPAY algorithm type does the following:</p> <ol style="list-style-type: none"> 1. Validates whether the file is in the CSV format 2. Validates whether at least one payment record is available in the CSV file 3. Parses the flat file in the CSV format and maps the columns in the CSV file to various tables in the database 4. Uploads the payments records in the pre-staging area <p>However, the C1-CSVPMALGO algorithm type does the following:</p> <ol style="list-style-type: none"> 1. Validates whether the file is in the CSV format 2. Validates whether the CSV file contains data in the required format 3. Validates whether the following data is available for each usage record: <ul style="list-style-type: none"> • Account Identifier Type • Account Identifier • Division • Price Item • Description 4. Parses the flat file in the CSV format and maps the columns in the CSV file to an XML schema named Interface <p>The Search  icon appears corresponding to this field. On clicking the Search icon, the Algorithm Search window appears.</p>	
To Do Algorithm	Used to indicate whether the usage records must be approved before creating the billable charges. If the algorithm is attached, it means the approval is required.	No

Field Name	Field Description	Mandatory (Yes or No)
	<p>Note:</p> <p>The C1_ODBTDALGO algorithm type contains the following parameters:</p> <ul style="list-style-type: none"> • To Do Role For Submitter — Used to indicate that users with the specified To Do role can only resolve the records which are rejected by the approver. • To Do Type For Submitter — Used to indicate that a To Do using the specified To Do type must be created when the approver rejects the records. • To Do Role For Approver — Used to indicate that users with the specified To Do role can only approve the records submitted by the submitter. • To Do Type For Approver — Used to indicate that a To Do using the specified To Do type must be created when the submitter submits the valid records for approval. <p>This field is disabled when you select the Payment Upload Data option from the Feed Type list.</p> <p>The Search (🔍) icon appears corresponding to this field. On clicking the Search icon, the Algorithm Search window appears.</p>	
Validation Algorithm	Used to attach a validation algorithm which is triggered once the file is uploaded in the system.	Yes (Conditional) <div style="border: 1px solid black; padding: 5px; margin-top: 5px;"> <p>Note: This field is required when you select the Payment Upload Data option from the Feed Type list.</p> </div>

Field Name	Field Description	Mandatory (Yes or No)
	<p>Note:</p> <p>The C1-PUPLVALID algorithm type is designed for validating a payment data file. It has some pre-defined validations based on which the status of the payment record is set to Valid, Invalid, or Error. For more information about the pre-defined validations, see Upload Payment Records in the Pre-Staging Area on page 1260.</p> <p>However, the C1-VLDALGO algorithm type is designed for validating a banking usage data file. It checks whether account identifier specified for each usage record contains any special characters. You can define any custom validations in this algorithm, if required. You cannot use an algorithm created using the C1-VLDALGO algorithm type to validate an insurance usage data file. If you want to validate an insurance usage data file, you need to create a custom algorithm type.</p> <p>The Search (🔍) icon appears corresponding to this field. On clicking the Search icon, the Algorithm Search window appears.</p>	
Extract Algorithm	<p>Used to attach an extract algorithm which extracts the usage records along with the error messages (if any) in the CSV format.</p> <p>Note: This field is disabled when you select the Payment Upload Data option from the Feed Type list.</p> <p>The Search (🔍) icon appears corresponding to this field. On clicking the Search icon, the Algorithm Search window appears.</p>	No

In addition, it contains the following two sections:

- **Map Divisions** — Used to indicate the divisions for which you want to use the file type.

Field Name	Field Description	Mandatory (Yes or No)
Division	<p>Used to indicate the division.</p> <p>Note: You can only view those divisions to which you have access in the Division list.</p>	No

Note: This section does not appear when the feed type is set to **Payment Upload Data**.

- **Custom Labels** — Used to specify business labels for the usage data fields. The usage data fields will change depending on whether you have selected the **Banking Usage Data** or **Insurance Usage Data** option from the **Feed Type** list.

Note:

This section does not appear when the feed type is set to **Payment Upload Data**.

If you have defined the business label for a usage data field, the CSV file should contain business label in the respective column. Otherwise, the usage data file will not be uploaded in the system.

4. Modify the required details.

Note:

You can search for an algorithm by clicking the **Search** (🔍) icon corresponding to the respective field.

If you want to associate more than one division with the file type, click the **Add** (+) icon and then specify the details in the **Map Divisions** section. However, if you want to remove a division from the file type, click the **Delete** (🗑️) icon corresponding to the division.

5. Click **Save**.

The changes made to the file type are saved.

Related Topics

For more information on...	See...
File Type screen	File Type on page 1181
File Types zone	File Types on page 1182

Deleting a File Type**Procedure**

To delete a file type:

1. Click the **Admin** link in the **Application** toolbar.
A list appears.
2. From the **Admin** menu, select **F** and then click **File Type**.
The **File Type** screen appears.
3. Click the **Delete** (🗑️) icon in the **Delete** column corresponding to the file type that you want to delete.
A message appears confirming whether you want to delete the file type.

Note: You can only delete a file type which is not yet used for uploading a file.

4. Click **OK**.

The file type is deleted.

Related Topics

For more information on...	See...
File Type screen	File Type on page 1181
File Types zone	File Types on page 1182

On Demand Billing

The **On Demand Billing** screen allows you to search for a file group based on various search criteria. Through this screen, you can:

- Define a file group
- Edit a file group
- Delete a file group
- Close a file group
- Generate adhoc bills for a file group
- Freeze and complete adhoc bills of a file group
- View all bills generated for a file group
- View usage data files of a file group
- Cancel a usage data file

This screen consists of the following zones:

- [Search](#) on page 1194

Search

The **Search** zone allows you to search for file groups for which bills are processed and/or generated in the system. This zone contains the following two sections:

- **Search Criteria** — The **Search Criteria** section contains the following fields:

Field Name	Field Description	Mandatory (Yes or No)
File Group	Used to specify the file group.	No
Description	Used to specify the description for the file group.	No
User ID	Used to specify the name of the user who has uploaded the usage data files in the file group.	No
Bill After Date	Used to specify the date after which the bills must be generated for the file group.	No
Status	Used to indicate the status of the file group. The valid values are: <ul style="list-style-type: none"> • Closed • Open 	No

Note: You must specify at least one search criterion while searching for a file group.

- **Search Results** — On clicking the **Search** button, the search results appear based on the specified search criteria. The **Search Results** section contains the following columns:

Column Name	Column Description
File Group	Displays the name of the file group.

Column Name	Column Description
	Note: It has a link. On clicking the link, the File Group screen appears where you can view the details of the file group.
Bill After Date	Displays the date after which the bills must be generated for the file group.
Default Usage Start Date	Displays the date from when the price item was used.
Default Usage End Date	Displays the date till when the price item was used.
Status	Displays the status of the file group. The valid values are: <ul style="list-style-type: none"> • Open • Close
Close	On clicking the Close (✖) icon, you can close a file group. Note: You can only close a file group in which all the records of the usage data files are either in the processed or cancelled status.
Generate Bill	On clicking the Generate Bill (📄) icon, you can generate bills for a file group.
Complete Bill	On clicking the Complete Bill (✅) icon, you can freeze and complete the bills of a file group.
Total	Displays the total number of records that are uploaded through the file group.
Valid	Displays the number of records which are successfully validated in the system.
Invalid	Displays the number of records which could not pass through the validation process in the system.
Submitted	Displays the number of valid records which are submitted for approval.
Processed	Displays the number of valid records for which billable charges are already created.
Rejected	Displays the number of records which are rejected by the approver.
Cancelled	Displays the number of records which are cancelled in the system.
Unbilled	Displays the number of records for which billable charges are created, but are not yet billed to the person.
Billed	Displays the number of records for which billable charges are created and billed to the person.
Bills	Displays the number of bills generated for the file group. Note: It has a link. On clicking the link, the View Bill Data screen appears where you can view all bills generated for the usage data file.
Last Batch Status	Indicates the batch that was last executed on the file group and its current status. Note: It has a link. On clicking the link, the Batch Run Tree screen appears where you can view the execution details of the batch.

Related Topics

For more information on...	See...
On Demand Billing screen	On Demand Billing on page 1194
How to search for a file group	Searching for a File Group on page 1197
How to define a file group	Defining a File Group on page 1198
How to edit a file group	Editing a File Group on page 1199
How to delete a file group	Deleting a File Group on page 1201
How to close a file group	Closing a File Group on page 1201
How to generate adhoc bills for a file group	Generating Adhoc Bills for a File Group on page 1202
How to freeze and complete one or more bills	Freezing Selected Bills of a File Group on page 1204
How to freeze and complete all bills of a file group	Freezing All Bills of a File Group on page 1203
How to view all bills generated for a file group	Viewing All Bills Generated for a File Group on page 1205
How to view usage data files of a file group	Viewing Usage Data Files of a File Group on page 1207
How to cancel a usage data file	Cancelling a Usage Data File on page 1254

Group Files

The **Group Files** zone allows you to view the usage data files uploaded using a file group. This zone contains the following two sections:

- **Search Criteria** — the **Search Criteria** section contains the following fields:

Field Name	Field Description	Mandatory (Yes or No)
File Name	Used to specify the name of the usage data file.	No
File Type	Used to specify the type of usage data file.	No
File Upload From Date	Used to specify the start date of the period during which the usage data file that you want to search was uploaded in the system.	No
File Upload To Date	Used to specify the end date of the period during which the usage data file that you want to search was uploaded in the system.	No

- **Search Results** — On clicking the **Search** button, the search results appear based on the specified search criteria. The **Search Results** section contains the following columns:

Column Name	Column Description
File Information	Displays the name of the usage data file of the file group and its related details.
Total	Displays the total number of records that are uploaded through the usage data file.
Valid	Displays the number of records which are successfully validated in the system.
Invalid	Displays the number of records which could not pass through the validation process in the system.
Submitted	Displays the number of valid records which are submitted for approval.
Rejected	Displays the number of records which are rejected by the approver.
Processed	Displays the number of valid records for which billable charges are already created.

Column Name	Column Description
Cancelled	Displays the number of records of a usage data file which are cancelled.
UnBilled	Displays the number of records for which billable charges are created, but are not yet billed to the person.
Billed	Displays the number of records for which billable charges are created and billed to the person.
Cancel	On clicking the Cancel () icon, you can cancel a file.

By default, the **Group Files** zone does not appear in the **On Demand Billing** screen. It appears when you click the **Broadcast** () icon corresponding to the file group in the **Search Results** section.

Note: By default, the **Group Files** zone displays a list of usage data files that are uploaded using the file group in the **Search Results** section. However, you can filter the list of usage data files by specifying a search criteria in the **Search Criteria** section.

Related Topics

For more information on...	See...
How to view usage data files of a file group	Viewing Usage Data Files of a File Group on page 1207
How to cancel a file in the file group	Cancelling a Usage Data File on page 1254

Searching for a File Group

Procedure

To search for a file group:

1. Click the **Menu** link in the **Application** toolbar.
A list appears.
2. From the **Main** menu, select **Billing Management** and then click **On Demand Billing**.
The **On Demand Billing** screen appears.
3. Enter the search criteria in the **Search** zone.

Note: ORMB search engine supports wildcard search, where you can substitute the percentage (%) symbol as a stand in for any word or letter in a search criteria. You can use the ‘%’ wildcard character in all input fields except the date and ID fields. The ‘%’ wildcard character is suffixed automatically at the end of the partial search criteria. Therefore, you may or may not specify the wildcard character at the end of the partial search criteria. However, you have to prefix the wildcard character manually wherever required.

4. Click **Search**.
A list of file groups that meet the search criteria appears in the **Search Results** section.

Related Topics

For more information on...	See...
On Demand Billing screen	On Demand Billing on page 1194
Search zone	Search on page 1194

Defining a File Group

Prerequisites

To define a file group, you should have:

- Access to the divisions for which you want to define the file group

Procedure

To define a file group:

1. Click the **Menu** link in the **Application** toolbar.

A list appears.

2. From the **Main** menu, select **Billing Management** and then click **On Demand Billing**.

The **On Demand Billing** screen appears.

3. Click the **Add** link in the upper right corner of the **Search** zone.

The **File Group** screen appears. It contains the following fields:

Field Name	Field Description	Mandatory (Yes or No)
File Group	Used to specify the file group.	Yes
Description	Used to specify the description for the file group.	Yes
Bill After Date	Used to specify the date after which the bill must be generated for the file group.	Yes
Default Usage Start Date	Used to specify the date from when the price item was used. The default usage start date is used when the start date is not specified for a record in the usage data file. By default, the current date appears in this field. You can change the default usage start date, if required.	Yes
	Note: The default usage start date cannot be later than the default usage end date.	
Default Usage End Date	Used to specify the date till when the price item was used. The default usage end date is used when the end date is not specified for a record in the usage data file. By default, the current date appears in this field. You can change the default usage end date, if required.	Yes
	Note: The default usage end date cannot be earlier than the default usage start date.	

In addition, the **File Group** screen contains the following section:

Map Divisions— The **Map Divisions** section contains the following fields:

Field Name	Field Description	Mandatory (Yes or No)
Division	Used to indicate the division for which you want to define the file group.	No

Field Name	Field Description	Mandatory (Yes or No)
		Note: If you do not associate division(s) with the file group, the file group is not available for uploading a usage data file. This means only those file groups for which you have specified division(s) can be used for uploading a usage data file.

- Enter the required details.
- If you want to define the file group for more than one division, click the **Add (+)** icon and then repeat step 5.

Note: However, if you want to remove a division from the file group, click the **Delete (🗑)** icon corresponding to the division.

- Click **Save**.

The file group is defined.

Related Topics

For more information on...	See...
On Demand Billing screen	On Demand Billing on page 1194
Search zone	Search on page 1194

Editing a File Group

Procedure

To edit a file group:

Note: You can edit the details of a file group when no usage data files of this group have been uploaded in the system or all the records in the usage data files of a file group are cancelled.

- Click the **Menu** link in the **Application** toolbar.
A list appears.
- Select **Billing Management** and then click **On Demand Billing**.
The **On Demand Billing** screen appears.
- Search for the file group in the **On Demand Billing** screen.
- In the **Search Results** section, click the link in the **File Group** column corresponding to the file group whose details you want to edit.

The **File Group** screen appears. It contains the following fields:

Field Name	Field Description	Mandatory (Yes or No)
File Group	Displays the file group.	Not applicable

Field Name	Field Description	Mandatory (Yes or No)
Description	Used to specify the description for the file group.	Yes
Bill After Date	Used to specify the date after which the bill must be generated for the file group	Yes
Usage Start Date	Used to specify the date from when the price item was used. The default usage start date is used when the start date is not specified for a record in the usage data file.	Yes
	Note: The default usage start date cannot be later than the default usage end date.	
Usage End Date	Used to specify the date till when the price item was used. The default usage end date is used when the end date is not specified for a record in the usage data file.	Yes
	Note: The default usage end date cannot be earlier than the default usage start date.	

In addition, the **Add/Edit File Group** screen contains the following section:

- **Map Divisions**— The **Map Divisions** section contains the following fields:

Field Name	Field Description	Mandatory (Yes or No)
Division	Used to indicate the division for which you want to define the file group.	No
		Note: If you do not associate division(s) with the file group, the file group is not available for uploading a usage data file. This means only those file groups for which you have specified division(s) can be used for uploading a usage data file.

5. Modify the required details.

Note: If you want to define the file group for more than one division, click the **Add** (+) icon and then specify the details. However, if you want to remove a division from the file group, click the **Delete** (🗑️) icon corresponding to it.

6. Click **Save**.

The changes made to the file group are saved.

Related Topics

For more information on...	See...
On Demand Billing screen	On Demand Billing on page 1194
Search zone	Search on page 1194

Deleting a File Group

Procedure

To delete a file group:

1. Click the **Menu** link in the **Application** toolbar.
A list appears.
2. Select **Billing Management** and then click **On Demand Billing**.
The **On Demand Billing** screen appears.
3. Search for the file group in the **On Demand Billing** screen.
4. In the **Search Results** section, click the link in the **File Group** column corresponding to the file group that you want to delete.
The **File Group** screen appears.
5. Click **Delete**.
The file group is deleted.

Note: The delete button appears only if the file group is not yet used. In other words, you cannot delete a file group that you have used for uploading usage data files.

Related Topics

For more information on...	See...
On Demand Billing screen	On Demand Billing on page 1194
Search zone	Search on page 1194

Closing a File Group

Procedure

To close a file group:

1. Click the **Menu** link in the **Application** toolbar.
A list appears.
2. From the **Main** menu, select **Billing Management** and then click **On Demand Billing**.
The **On Demand Billing** screen appears.
3. Search for the file group in the **On Demand Billing** screen.
4. In the **Search Results** section, click the **Close** (✖) icon in the **Close** column corresponding to the file group that you want to close.
The status of the file group is changed to **Closed**.

Note: You can only close a file group in which all the records of the usage data files are either in the processed, cancelled, or rejected status. However, you may close a file group in which all the records are not in the cancelled and/or processed status, but in that case a to do entry is sent to the approver for approval of the pending records.

Related Topics

For more information on...	See...
On Demand Billing screen	On Demand Billing on page 1194
Search zone	Search on page 1194

Generating Adhoc Bills for a File Group

The **On Demand Billing** screen allows you to generate adhoc bills for a file group. However, you can generate bills only after you close the file group for which you want to generate adhoc bills.

Procedure

To generate adhoc bills for a file group:

1. Search for the file group in the **On Demand Billing** screen.
2. In the **Search Results** section, click the **Generate Bill** () icon corresponding to the file group for which you want to generate the adhoc bills.

The **Generate Bill** window appears. It contains the following fields:

Field Name	Field Description	Mandatory (Yes or No)
Cutoff Date	Used to specify the cutoff date for the bill.	Yes
Accounting Date	Used to specify the accounting date of the bill.	Yes

3. Enter the required details.
4. Click **OK**.

The adhoc bills are generated for the usage data files of a file group. An adhoc bill is generated for a usage data file and account combination when the bill after date is equal to or earlier than the current date. The status of the usage records is changed to **Billed**. If the total number of billable charges created for a usage data file exceeds the online bill creation limit, a batch job is created using the **Adhoc Billing (C1-FABL)** batch. A message appears indicating the batch job ID. This batch job creates adhoc bills for the usage data file.

Note:

You can change the online bill creation limit, whenever required, using the **On Demand Billing (C1-ODBFC)** feature configuration. For more information on the **Adhoc Billing (C1-FABL)** batch, see *Oracle Revenue Management and Billing Batch Execution Guide*.

If an adhoc bill with the **Pending** status already exists for a usage data file and account combination, then the existing bill is deleted and regenerated. However, you can generate the bill again for a file group only after manually deleting the bill from the **Bill** screen.

On successful completion of the **Adhoc Billing (C1-FABL)** batch, a To Do entry is created using the **C1-FABL** To Do type. You can view this To Do entry when you are assigned a To Do role which is mapped to the **C1-FABL** To Do type. This To Do indicates whether the batch was successfully executed or not. If the batch was successfully executed, it indicates the following:

- Number of billable charges which were processed
- Number of billable charges for which the bill after date is a future date
- Number of adhoc bills generated for the usage data file
- Number of billable charges which could not be processed successfully

Once the batch is executed successfully, the status of the usage records in a usage data file of a file group is changed to **Billed**.

Related Topics

For more information on...	See...
How to search for a file group	Searching for a File Group on page 1197
How to set the On Demand Billing (C1-ODBFC) feature configuration	Setting the C1-ODBFC Feature Configuration on page 4333

Freezing All Bills of a File Group

Oracle Revenue Management and Billing provides you with the ability to freeze and complete adhoc bills generated for the usage data files of a file group from the **On Demand Billing** screen. You can either freeze and complete all or selected adhoc bills, whenever required. However, you cannot freeze and complete normal or regular bills from the **On Demand Billing** screen.

Procedure

To freeze and complete all adhoc bills generated for a file group:

1. Search for the file group in the **On Demand Billing** screen.
2. In the **Search Results** section, click the **Freeze and Complete** (🗑️) icon corresponding to the file group whose adhoc bills you want to freeze and complete.

The **Complete Bill** window appears. It contains the following fields:

Field Name	Field Description	Mandatory (Yes or No)
Bill Date	Used to specify the date on which the bill was completed.	Yes
Accounting Date	Used to specify the accounting date of the bill.	Yes

3. Enter the required details.
4. Click **OK** in the message box.

A batch job is created using the **Freeze and Complete Adhoc Bills (C1-FCADH)** batch. A message appears indicating the batch job ID. This batch job freezes and completes all adhoc bills of the usage data file which are in the **Pending** status. The system does not freeze and complete pending adhoc bills which have bill segments in the **Error** status. For more information on the **Freeze and Complete Adhoc Bills (C1-FCADH)** batch, see *Oracle Revenue Management and Billing Batch Execution Guide*.

Note:

On successful completion of the **Freeze and Complete Adhoc Bills (C1-FCADH)** batch, a To Do entry is created using the **C1-FCADH** To Do type. You can view this To Do entry when you are assigned a To Do role which is mapped to the **C1-FCADH** To Do type. This To Do indicates whether the batch was successfully executed or not. If the batch was successfully executed, it indicates the following:

- Number of bills which were picked up for completion
- Number of bills which were completed
- Number of bills which could not be completed successfully

Once the batch is executed successfully, the status of the bills is changed to **Complete**.

Related Topics

For more information on...	See...
How to search for a file group	Searching for a File Group on page 1197
How to freeze and complete one or more bills	Freezing Selected Bills of a File Group on page 1204

Freezing Selected Bills of a File Group

Oracle Revenue Management and Billing provides you with the ability to freeze and complete adhoc bills generated for a file group from the **On Demand Billing** screen. You can either freeze and complete all or selected adhoc bills, whenever required. However, you cannot freeze and complete normal or regular bills from the **On Demand Billing** screen.

Procedure

To freeze and complete selected adhoc bills of a file group:

1. Search for the file group in the **On Demand Billing** screen.
2. In the **Search Results** section, click the link in the **Bills** column corresponding to the file group whose adhoc bills you want to freeze and complete.

The **View Bill Data** screen appears.

3. Select the check box corresponding to the pending adhoc bill that you want to freeze and complete.

Note: The check box does not appear corresponding to the completed adhoc bills and pending adhoc bills which have bill segments in the **Error** status.

4. Click **Freeze/Complete**.

The **Complete Bill** window appears. It contains the following fields:

Field Name	Field Description	Mandatory (Yes or No)
Bill Date	Used to specify the date on which the bill was completed.	Yes
Accounting Date	Used to specify the accounting date of the bill.	Yes

5. Enter the required details.
6. Click **OK** in the message box.

The status of the bills is changed to **Complete**.

Note:

The **Freeze/Complete** button is not available in the **View Bill Data** screen when:

- All bills generated for a file group are in the **Complete** status
- Multiple bills are generated for a usage data file of a file group and one or more bill segments of each bill are in the **Error** status

In other words, the **Freeze/Complete** button is available in the **View Bill Data** screen when there is at least one pending bill for a file group where none of the bill segments are in the **Error** status.

Related Topics

For more information on...	See...
How to search for a file group	Searching for a File Group on page 1197
How to freeze and complete all bills of a file group	Freezing All Bills of a File Group on page 1203

Viewing All Bills Generated for a File Group

Procedure

To view all bills generated for a file group:

1. Search for the file group in the **On Demand Billing** screen.
2. In the **Search Results** section, click the link in the **Bills** column corresponding to the file group whose bills you want to view.

The **View Bill Data** screen appears. It contains the following fields:

Field Name	Field Description
File Group	Displays the name of the file group.
Description	Displays the description of the file group.
Bill Generation Date	Used to specify the date when the bills were generated for the file group.
Billing Method	Indicates the type of billing used for the file group. The valid values are: <ul style="list-style-type: none"> • Adhoc Billing
Bill Status	Used to indicate the status of the bill. The valid values are: <ul style="list-style-type: none"> • Pending • Complete

In addition, this screen contains the following columns:

Column Name	Column Description
Bill ID	Displays the bill ID. Note: It has a link. On clicking the link, the Bill screen appears with the details of the respective bill.
Alternate Bill ID	Displays the alternate bill ID.
Bill Status	Displays the status of the bill. The valid values are: <ul style="list-style-type: none"> • Pending • Complete
Bill Date	Displays the date when the bill was completed.
Accounting Date	Displays the accounting date for which the financial transaction of the bill is created.
Invoice Amount	Displays the total amount billed to the person.

Column Name	Column Description
Invoice Currency	Displays the currency in which the amount is billed to the person.
Invoice Account ID	Indicates the account for which the bill is created. Note: It has a link. On clicking the link, the Account screen appears where you can view the details of the respective account.
Display Bill	On clicking this link, you can view the details of the respective bill. Note: This link appears only for the bills that are in the Complete status. The facility to view the generated bills in PDF format is available only if Oracle Documaker is integrated with Oracle Revenue Management and Billing.

Note:

Pagination is used to display limited number of records in the **Search Results** section. You can change the number of records displayed per page, if required. You can use the navigation buttons, such as **First** (<<), **Previous** (<), **Next** (>), and **Last** (>>) to navigate between pages. You can also select the page to which you want to navigate from the **Go To** list.

3. Click **Search**.
4. View the bills generated for the usage data file in the **View Bill Data** screen.
5. If required, you can change the number of records displayed per page.

Note: By default, the number of records that appear in each page depends on the minimum value defined in the **PAGE_NUMBER** lookup field. For example, if the **PAGE_NUMBER** lookup field has four values — 10, 20, 30, and 40, then the number of records displayed in each page, by default, would be 10.

6. If required, you can click the **First** (<<), **Previous** (<), **Next** (>), and **Last** (>>) buttons to navigate between pages.
7. If required, you can freeze and complete adhoc bills which are generated for the usage data file.

Note:

The **Freeze/Complete** button is not available in the **View Bill Data** screen when:

- All bills generated for a usage data file are in the **Complete** status
- Multiple bills are generated for a usage data file and one or more bill segments of each bill are in the **Error** status

In other words, the **Freeze/Complete** button is available in the **View Bill Data** screen when there is at least one pending bill for a usage data file where none of the bill segments are in the **Error** status.

Related Topics

For more information on...	See...
How to search for a usage data file	Searching for a Usage Data File on page 1210
How to freeze and complete one or more bills	Freezing Selected Bills of a File Group on page 1204
How to freeze and complete all bills of a file group	Freezing All Bills of a File Group on page 1203

Viewing Usage Data Files of a File Group

Procedure

To view usage data files of a file group:

1. Search for the file group in the **On Demand Billing** screen.
2. In the **Search Results** section, click the **Broadcast** () icon corresponding to the file group whose usage data files you want to view.

The **Group Files** zone appears.

3. View the usage data files of the file group in the **Group Files** zone.

Related Topics

For more information on...	See...
How to cancel a usage data file of a file group	Cancelling a Usage Data File on page 1254
How to search for a file group	Searching for a File Group on page 1197
Group Files zone	Group Files on page 1196

Usage Data Processing

The **Usage Data Processing** screen allows you to search for a usage data file based on various search criteria. Through this screen, you can:

- Upload a usage data file
- Cancel a usage data file
- View all records uploaded through a usage data file
- View the valid, invalid, and cancelled records of a usage data file
- View the valid records of a usage data file which are submitted for approval
- View the valid records of a usage data file for which billable charges are already created
- View the rejected, billed and unbilled records of a usage data file
- Submit the valid records of a usage data file and create billable charges for them
- Approve or reject one or more valid records of a usage data file
- Revalidate the valid and invalid records of a usage data file
- Edit the valid, invalid and rejected records of a usage data file
- Export the usage data of a usage data file into a CSV file

This screen consists of the following zones:

- [Search](#) on page 1207

Search



The **Search** zone allows you to search for usage data files that are uploaded and/or processed in the system. This zone contains the following two sections:

- **Search Criteria** — the **Search Criteria** section contains the following fields:

Field Name	Field Description	Mandatory (Yes or No)
File Name	Used to specify the name of the usage data file.	No
File Type	Used to indicate the type of usage data file.	No
File Upload From Date	Used when you want to search for usage data files that were uploaded from a particular date onwards.	No
To	Used when you want to search for usage data files that were uploaded till a particular date.	No
User ID	Used to specify the name of the user who has uploaded the usage data file.	No
Billing Method	Used to specify the type of billing used for the usage data file. The valid values are: <ul style="list-style-type: none"> • Adhoc Billing • Regular Billing 	No
File Group	Used to specify the file group of the usage data file.	No

Note: You must specify at least one search criterion while searching for a usage data file.

- **Search Results** — On clicking the **Search** button, the search results appear based on the specified search criteria. The **Search Results** section contains the following columns:

Column Name	Column Description
File Information	Displays the name of the usage data file and its related details.
Revalidate	<p>On clicking the Revalidate () icon, you can execute the validation process once again on the valid, invalid, and rejected records.</p> <p>Note: The Revalidate icon appears when the usage records are in the Valid, Invalid, and/or Rejected status. In other words, you cannot revalidate a usage data file for which billable charges are created or when the bills are generated for a usage data file.</p>
Cancel	<p>On clicking the Cancel () icon, you can cancel all valid, invalid, and rejected records of the usage data file.</p> <p>Note: The Cancel icon appears when the usage records are in the Valid, Invalid, and/or Rejected status. In other words, you cannot cancel a usage data file for which billable charges are created or when the bills are generated for a usage data file.</p>
Submit	<p>On clicking the Submit () icon, you can submit the valid records and create billable charges for them. If the valid usage records need to be approved before creating the billable charges, a To Do entry is created for the approver to approve the valid records.</p>

Column Name	Column Description
	<p>Note: The Submit icon appears when all the records of a usage data file are in the Valid status. In other words, if a usage data file contains records in the Invalid status, you cannot create billable charges for a usage data file.</p>
Approve	<p>On clicking the Approve (☑) icon, the approver can approve all valid records of the usage data file.</p> <p>Note: The Approve icon appears when the usage data file (with all usage records in the Valid status) is uploaded using a file type to which the To Do algorithm (for enabling approval workflow) is attached.</p>
Total	<p>Displays the total number of records that are uploaded through the usage data file.</p> <p>Note: It has a link. On clicking the link, the Usage Data screen appears where you can view all records uploaded through the usage data file.</p>
Valid	<p>Displays the number of records which are successfully validated in the system.</p> <p>Note: It has a link. On clicking the link, the Usage Data screen appears where you can view and edit all valid records of the usage data file.</p>
Invalid	<p>Displays the number of records which could not pass through the validation process in the system.</p> <p>Note: It has a link. On clicking the link, the Usage Data screen appears where you can view and edit all invalid records of the usage data file.</p>
Submitted	<p>Displays the number of valid records which are submitted for approval.</p> <p>Note: It has a link. On clicking the link, the Usage Data screen appears where you can view all submitted records of the usage data file.</p>
Rejected	<p>Displays the number of records which are rejected by the approver.</p> <p>Note: It has a link. On clicking the link, the Usage Data screen appears where you can view and edit all rejected records of the usage data file.</p>
Processed	<p>Displays the number of valid records for which billable charges are already created.</p> <p>Note: It has a link. On clicking the link, the Usage Data screen appears where you can view all processed records of the usage data file.</p>
Billed	<p>Displays the number of records for which billable charges are created and billed to the person.</p> <p>Note: It has a link. On clicking the link, the Usage Data screen appears where you can view all billed records of the usage data file.</p>
Unbilled	<p>Displays the number of records for which billable charges are created, but are not yet billed to the person.</p> <p>Note: It has a link. On clicking the link, the Usage Data screen appears where you can view all unbilled records of the usage data file.</p>

Column Name	Column Description
Cancelled	Displays the number of records which are cancelled in the system.
	Note: It has a link. On clicking the link, the Usage Data screen appears where you can view all cancelled records of the usage data file.
Batch Run Status	Indicates the batch that was last executed on the usage data file and its current status.
	Note: It has a link. On clicking the link, the Batch Run Tree screen appears where you can view the execution details of the batch.

You can upload a usage data file by clicking the **Upload** link in the upper right corner of this zone.

Related Topics

For more information on...	See...
Usage Data Processing screen	Usage Data Processing on page 1207
How to upload a usage data file	Uploading a Usage Data File on page 1211
How to replace an existing file	Replacing an Existing File on page 1214
How to search for a usage data file	Searching for a Usage Data File on page 1210
How to view all records of a usage data file	Viewing All Records of a Usage Data File on page 1217
How to view valid records of a usage data file	Viewing Valid Records of a Usage Data File on page 1221
How to view invalid records of a usage data file	Viewing Invalid Records of a Usage Data File on page 1224
How to view submitted records of a usage data file	Viewing Submitted Records of a Usage Data File on page 1227
How to view processed records of a usage data file	Viewing Processed Records of a Usage Data File on page 1231
How to view rejected records of a usage data file	Viewing Rejected Records of a Usage Data File on page 1238
How to view cancelled records of a usage data file	Viewing Cancelled Records of a Usage Data File on page 1234
How to view billed records of a usage data file	Viewing Billed Records of a Usage Data File on page 1241
How to view unbilled records of a usage data file	Viewing Unbilled Records of a Usage Data File on page 1245
How to view all bills generated for a usage data file	Viewing All Bills Generated for a File Group on page 1205
How to submit the valid records	Submitting a Valid Record on page 1248
How to edit the valid, invalid or rejected records	Editing a Valid, Invalid, or Rejected Usage Record on page 1256
How to approve the valid records	Approving a Valid Record on page 1250
How to reject the valid records	Rejecting a Valid Record on page 1252
How to cancel a usage data file	Cancelling a Usage Data File on page 1254
How to revalidate a usage data file	Revalidating a Usage Data File on page 1255
How to generate adhoc bills for a usage data file	Generating Adhoc Bills for a File Group on page 1202

Searching for a Usage Data File

Procedure

To search for a usage data file:

1. Click the **Menu** link in the **Application** toolbar.
A list appears.
2. From the **Main** menu, select **Billing Management** and then click **Usage Data Processing**.
The **Usage Data Processing** screen appears.
3. Enter the search criteria in the **Search** zone.

Note: ORMB search engine supports wildcard search, where you can substitute the percentage (%) symbol as a stand in for any word or letter in a search criteria. You can use the ‘%’ wildcard character in all input fields except the date and ID fields. The ‘%’ wildcard character is suffixed automatically at the end of the partial search criteria. Therefore, you may or may not specify the wildcard character at the end of the partial search criteria. However, you have to prefix the wildcard character manually wherever required.

4. Click **Search**.

A list of usage data files that meet the search criteria appears in the **Search Results** section.

Related Topics

For more information on...	See...
Usage Data Processing screen	Usage Data Processing on page 1207
Search zone	Search on page 1207

Uploading a Usage Data File

Prerequisites

To upload a usage data file, you should have:

- File types defined in the application
- Usage data in the required CSV file format
- File group using which you want to upload the usage data files is in **Open** status

Procedure

To upload a usage data file:

1. Click the **Menu** link in the **Application** toolbar.
A list appears.
2. From the **Main** menu, select **Billing Management** and then click **Usage Data Processing**.
The **Usage Data Processing** screen appears.
3. Click the **Upload** link in the upper right corner of the **Search** zone.

The **Upload Usage Data File** screen appears. It contains the following fields:

Field Name	Field Description	Mandatory (Yes or No)
Billing Method	Used to specify the type of billing you want to use for the usage data file. The valid values are: <ul style="list-style-type: none"> • Adhoc Billing 	Yes

Field Name	Field Description	Mandatory (Yes or No)
	<ul style="list-style-type: none"> Regular Billing 	
File Group	Used to specify the file group to which you want to add the usage data file.	Yes (Conditional)
	<p>Note: This field appears when you select the Adhoc Billing option from the File Group list. You can only view those file groups that are in the open status and to which you have access in the File Group list.</p>	<p>Note: If you select the billing method as Adhoc Billing, you have to specify the file group to which you want to add the usage data file.</p>
Bill After Date	Used to specify the date after which the bills must be generated for the usage data file. By default, the current date appears in this field.	Yes (Conditional)
	<p>Note: If you have selected the billing method as Adhoc Billing, this field appears in read-only mode and displays the bill after date as defined for the selected file group. If you have selected the billing method as Regular Billing then this field is enabled displaying the current date.</p>	<p>Note: If you select the billing method as Regular Billing, you have to specify the bill after date.</p>
Default Usage Start Date	Used to specify the date from when the price item was used. The default usage start date is used when the start date is not specified for a record in the usage data file. By default, the current date appears in this field. You can change the default usage start date, if required.	Yes (Conditional)
	<p>Note: If you have selected the billing method as Adhoc Billing, this field appears in read-only mode and displays the default usage start date as defined for the selected file group. If you have selected the billing method as Regular Billing then this field is enabled displaying the current date. The default usage start date cannot be later than the default usage end date.</p>	<p>Note: If you select the billing method as Regular Billing, you have to specify the default usage start date.</p>
Default Usage End Date	Used to specify the date till when the price item was used. The default usage end date is used when the end date is not specified for a record in the usage data file. By default, the current date appears in this field. You can change the default usage end date, if required.	Yes (Conditional)
	<p>Note: If you have selected the billing method as Adhoc Billing, this field appears in read-only mode and displays the default usage end date as defined for the selected file group. If you have selected the billing method as Regular Billing then this field is enabled displaying the current date. The default usage end date cannot be earlier than the default usage start date.</p>	<p>Note: If you select the billing method as Regular Billing, you have to specify the default usage end date.</p>
File Type	Used to specify the type of usage data file.	Yes

Field Name	Field Description	Mandatory (Yes or No)
Replace Existing File	Used to indicate whether you want to replace any existing file in the system. You must select this check box when you want to upload the same file once again.	No
File Name	Used to specify the name and path of the usage data file that you want to upload. Note: You can also click the Browse button corresponding to this field to browse to the location where the usage data file is available in the system.	Yes

4. Enter the required details.

5. Click the **Browse** button corresponding to the **File Name** field.

The **Choose File to Upload** dialog box appears.

6. Browse to the location where the usage data file that you want to upload is available.

7. Click **Open**.

The usage data file name and path appears in the **File Name** field.

8. Click **Upload**.

A message appears indicating that the usage data file has been uploaded successfully. If an error occurs while parsing, the usage data file is not uploaded in the system.

Note:

The validation process starts immediately after the file is uploaded in the system. If a usage record is successfully validated, the status of the usage record is changed to **Valid**. And, if a usage record could not pass through the validation process, the status of the usage record is changed to **Invalid**. You can view the details of the uploaded file and its records in the **Usage Data Processing** screen.

If the usage data file size exceeds the file size limit set in the **C1-ODBFC** feature configuration, a batch job is created using the **Upload and Validate Usage Data File (C1-ODFU)** batch. A message appears indicating the batch job ID. This batch job uploads and validates the usage data file. You can change the file size limit using the **On Demand Billing (C1-ODBFC)** feature configuration. For more information on the **Upload and Validate Usage Data File (C1-ODFU)** batch, see *Oracle Revenue Management and Billing Batch Execution Guide*.

The number of usage records that are parsed and mapped in an XML file depends on the value defined for the **Staging XML Size** option type in the **On Demand Billing (C1-ODBFC)** feature configuration. For example, if the **Staging XML Size** option type is set to 100 and a usage data file contains 500 records, then the system creates 5 XML files — each containing 100 records.

If a batch job is created automatically, the number of usage records that are validated in each work unit depends on the value defined for the **Validation Chunk Size** option type in the **On Demand Billing (C1-ODBFC)** feature configuration.

On successful completion of the **Upload and Validate Usage Data File (C1-ODFU)** batch, a To Do entry is created using the **C1-ODFU To Do** type. You can view this To Do entry when you are assigned a To Do role which is mapped to the **C1-ODFU To Do** type. This To Do indicates whether the batch was successfully executed or not. If the batch was successfully executed, it indicates the following:

- Number of records that were uploaded in the system
- Number of records which were successfully validated
- Number of records which could not pass through the validation process
- Number of records which failed to validate due to some technical reasons

- Click **OK** in the message box.

Once a usage record is successfully validated, the status of the usage record is changed to **Valid**. And, if a usage record could not pass through the validation process, the status of the usage record is changed to **Invalid**.

Related Topics

For more information on...	See...
Usage Data Processing screen	Usage Data Processing on page 1207
Search zone	Search on page 1207
How to set the On Demand Billing (C1-ODBFC) feature configuration	Setting the C1-ODBFC Feature Configuration on page 4333

Replacing an Existing File

Prerequisites

To replace an existing usage data file, you should have:

- File types defined in the application
- Usage data in the required CSV file format
- File group using which you want to upload the usage data files is in **Open** status

Procedure

To replace an existing usage data file:

- Click the **Menu** link in the **Application** toolbar.
A list appears.
- Select **Billing Management** and then click **Usage Data Processing**.
The **Usage Data Processing** screen appears.
- Click the **Upload** link in the upper right corner of the **Search** zone.

The **Upload Usage Data File** screen appears. It contains the following fields:

Field Name	Field Description	Mandatory (Yes or No)
Billing Method	Used to specify the type of billing you want to use for the usage data file. The valid values are: <ul style="list-style-type: none"> Adhoc Billing Regular Billing 	Yes
File Group	Used to specify the file group to which you want to add the usage data file. Note: This field appears when you select the Adhoc Billing option from the File Group list. You can only view those file groups that are in the open status and to which you have access in the File Group list.	Yes (Conditional) Note: If you select the billing method as Adhoc Billing , you have to specify the file group to which you want to add the usage data file.

Field Name	Field Description	Mandatory (Yes or No)
Bill After Date	Used to specify the date after which the bills must be generated for the usage data file. By default, the current date appears in this field.	Yes (Conditional) Note: If you select the billing method as Regular Billing , you have to specify the bill after date.
	Note: If you have selected the billing method as Adhoc Billing , this field appears in read-only mode and displays the bill after date as defined for the selected file group. If you have selected the billing method as Regular Billing then this field is enabled displaying the current date.	
Default Usage Start Date	Used to specify the date from when the price item was used. The default usage start date is used when the start date is not specified for a record in the usage data file. By default, the current date appears in this field. You can change the default usage start date, if required.	Yes (Conditional) Note: If you select the billing method as Regular Billing , you have to specify the default usage start date.
	Note: If you have selected the billing method as Adhoc Billing , this field appears in read-only mode and displays the default usage start date as defined for the selected file group. If you have selected the billing method as Regular Billing then this field is enabled displaying the current date. The default usage start date cannot be later than the default usage end date.	
Default Usage End Date	Used to specify the date till when the price item was used. The default usage end date is used when the end date is not specified for a record in the usage data file. By default, the current date appears in this field. You can change the default usage end date, if required.	Yes (Conditional) Note: If you select the billing method as Regular Billing , you have to specify the default usage end date.
	Note: If you have selected the billing method as Adhoc Billing , this field appears in read-only mode and displays the default usage end date as defined for the selected file group. If you have selected the billing method as Regular Billing then this field is enabled displaying the current date. The default usage end date cannot be earlier than the default usage start date.	
File Type	Used to specify the type of usage data file.	Yes
Replace Existing File	Used to indicate that you want to replace any existing file in the system.	Yes
File Name	Used to specify the name and path of the usage data file that you want to upload.	Yes
	Note: You can also click the Browse button corresponding to this field to browse to the location where the usage data file is available in the system.	

- Select the **Replace Existing File** check box.

Note: You can replace an existing file when the usage records of a usage data file are in any of the statuses:

- **Valid** and/or **Invalid**
- **Rejected**
- **Cancelled**

In other words, you cannot replace a file when the billable charges are already created for the usage records of a usage data file, or are pending for approval with the approver.

5. Click the **Browse** button corresponding to the **File Name** field.

The **Choose File to Upload** dialog box appears.

6. Browse to the location where the usage data file that you want to replace is available.
7. Click **Open**.

The usage data file name and path appears in the **File Name** field.

8. Click **Upload**.

A message appears indicating that the usage data file has been uploaded successfully. If an error occurs while parsing, the usage data file is not uploaded in the system.

Note:

The validation process starts immediately after the file is uploaded in the system. If a usage record is successfully validated, the status of the usage record is changed to **Valid**. And, if a usage record could not pass through the validation process, the status of the usage record is changed to **Invalid**. You can view the details of the uploaded file and its records in the **Usage Data Processing** screen.

If the usage data file size exceeds the file size limit set in the **C1-ODBFC** feature configuration, a batch job is created using the **Upload and Validate Usage Data File (C1-ODFU)** batch. A message appears indicating the batch job ID. This batch job uploads and validates the usage data file. You can change the file size limit using the **On Demand Billing (C1-ODBFC)** feature configuration. For more information on the **Upload and Validate Usage Data File (C1-ODFU)** batch, see *Oracle Revenue Management and Billing Batch Execution Guide*.

The number of usage records that are parsed and mapped in an XML file depends on the value defined for the **Staging XML Size** option type in the **On Demand Billing (C1-ODBFC)** feature configuration. For example, if the **Staging XML Size** option type is set to 100 and a usage data file contains 500 records, then the system creates 5 XML files — each containing 100 records.

If a batch job is created automatically, the number of usage records that are validated in each work unit depends on the value defined for the **Validation Chunk Size** option type in the **On Demand Billing (C1-ODBFC)** feature configuration.

On successful completion of the **Upload and Validate Usage Data File (C1-ODFU)** batch, a To Do entry is created using the **C1-ODFU To Do** type. You can view this To Do entry when you are assigned a To Do role which is mapped to the **C1-ODFU To Do** type. This To Do indicates whether the batch was successfully executed or not. If the batch was successfully executed, it indicates the following:

- Number of records that were uploaded in the system
- Number of records which were successfully validated
- Number of records which could not pass through the validation process
- Number of records which failed to validate due to some technical reasons

9. Click **OK** in the message box.

Once a usage record is successfully validated, the status of the usage record is changed to **Valid**. And, if a usage record could not pass through the validation process, the status of the usage record is changed to **Invalid**.

Related Topics

For more information on...	See...
Usage Data Processing screen	Usage Data Processing on page 1207
Search zone	Search on page 1207

Viewing All Records of a Usage Data File**Procedure**

To view all records of a usage data file:

1. Search for the usage data file in the **Usage Data Processing** screen.
2. In the **Search Results** section, click the link in the **Total** column corresponding to the usage data file whose records you want to view.

The **Usage Data** screen appears. It contains the following two sections:

- **Search Criteria** — This section allows you to filter the usage records based on the various search criteria. It contains the following fields:

Field Name	Field Description	Mandatory (Yes or No)
File Name	Displays the name of the usage data file.	Not applicable
File Type	Indicates the type of the usage data file.	Not applicable
Default Usage Start Date	Displays the usage start date entered while uploading the usage data file.	Not applicable
Default Usage End Date	Displays the usage end date entered while uploading the usage data file.	Not applicable
Usage Record Status	Used to specify the status of the usage record. The valid values are: <ul style="list-style-type: none"> • Valid • Invalid • Submitted for Approval • Processed • Rejected • Cancelled 	No
Division	Used to specify the division to which the usage record belongs.	No
Account Identifier Type	Used to specify the identifier type based on which you want to search for the usage records.	Yes (Conditional)
		Note: If you enter the account identifier as a search criteria, you have to enter the account identifier type.

Field Name	Field Description	Mandatory (Yes or No)
Account Identifier	Used to indicate the account whose usage records you want to view.	Yes (Conditional)
		Note: If you enter the account identifier type as a search criteria, you have to enter the account identifier.

- **Search Results** — By default, all records of the usage data file are listed in the **Search Results** section. You can filter the search results based on the specified criteria. the **Search Results** section contains the following columns:

Column Name	Column Description
BILLABLE CHARGE ID	Indicates the billable charge which is generated for the usage record. Note: This column appears only for the valid records for which billable charges have been created.
ACCOUNT ID TYPE	Indicates the account identifier type.
ACCOUNT IDENTIFIER	Indicates the account to which the usage record belongs.
ACCOUNT INFORMATION	Displays information about the account.
DIVISION	Indicates the division to which the usage record belongs.
CONTRACT ID	Displays the contract ID. Note: This column appears only if usage data files are uploaded for the insurance module.
CHARGE TYPE	Indicates the charge type. Note: This column appears only if usage data files are uploaded for the insurance module.
START DATE	Displays the date from when the price item was used. Note: If the start date is not available, the default usage start date appears in this column.
END DATE	Displays the date till when the price item was used. Note: If the end date is not available, the default usage end date appears in this column.
DESCRIPTION	Displays the description of the usage record. It is shown on the billable charge.
PRICE ITEM	Displays the price item code.
VARIANCE	Indicates the variance that must be used along with the price item for determining the price item pricing.

Column Name	Column Description
	Note: This column appears when the Multi Price Parameter option type of the Multi Parameter Based Pricing (C1_PPARM_FLG) feature configuration is set to False .
PARAM TYPE1, PARAM TYPE2,, PARAM TYPE15	Indicates the price item parameter that must be used along with the price item for determining the price item pricing. Note: These columns appear when the Multi Price Parameter option type of the Multi Parameter Based Pricing (C1_PPARM_FLG) feature configuration is set to True .
PARAM VALUE1, PARAM VALUE2,, PARAM VALUE15	Displays the value of the price item parameter. Note: These columns appear when the Multi Price Parameter option type of the Multi Parameter Based Pricing (C1_PPARM_FLG) feature configuration is set to True .
SQI1, SQI2,, SQI10	Indicates the service quantity identifier that must be used for calculating the price item charges.
SQVALUE1, SQVALUE2,, SQVALUE10	Displays the number of units of the service quantity.
BILL LINE DESCRIPTION1, BILL LINE DESCRIPTION2,, BILL LINE DESCRIPTION10	Displays the description of the line item (charge).
AMOUNT1, AMOUNT2,, AMOUNT10	Displays the charge amount.
CURRENCY1, CURRENCY2,, CURRENCY10	Displays the currency in which the amount is charged.
MEMO ONLY1, MEMO ONLY2,, MEMO ONLY10	Indicates whether the charge should be included in the bill amount or not.
SUMMARY1, SUMMARY2,, SUMMARY10	Indicates whether the charge should be included in the summary line or not.
SHOW ON BILL1, SHOW ON BILL2,, SHOW ON BILL10	Indicates whether the charge should appear on the person's printed bill or not.
GL DISTRIBUTION CODE 1, GL DISTRIBUTION CODE 2,, GL DISTRIBUTION CODE 10	Displays the distribution code which indicates the GL account associated with the charge.

Column Name	Column Description
CHARTYPE1, CHARTYPE2,, CHARTYPE10	Indicates the characteristic that must be defined for the billable charge.
CHARVAL1, CHARVAL2,, CHARVAL10	Displays the value of the characteristic type.

Note:

If you have defined business labels for usage data fields, the columns will appear with the business labels defined for the respective column.

Only those columns that contain data in the CSV file appear in the **Usage Data** screen. For example, if information about characteristics is provided in the CHARTYPE4 and CHARVAL4 columns of the CSV file, then only the CHARTYPE4 and CHARVAL4 columns appear in the **Usage Data** screen. Similarly, if information about the line item (charge) is provided in the BILL LINE DESCRIPTION6, AMOUNT6, CURRENCY6, MEMO ONLY6, SUMMARY6, SHOW ON BILL6, and GL DISTRIBUTION CODE 6 columns of the CSV file, then only the BILL LINE DESCRIPTION6, AMOUNT6, CURRENCY6, MEMO ONLY6, SUMMARY6, SHOW ON BILL6, AND GL DISTRIBUTION CODE 6 columns appear in the **Usage Data** screen.

Note:

Pagination is used to display limited number of records in the **Search Results** section. You can change the number of records displayed per page, if required. You can use the navigation buttons, such as **First** (<<), **Previous** (<), **Next** (>), and **Last** (>>) to navigate between pages. You can also select the page to which you want to navigate from the **Go To** list.

Note: You can download details of all the records of a usage data file in a CSV file format using the **Export TO Excel** link provided in the **Search** section.

- View the records of the usage data file in the **Usage Data** screen.
- If required, you can change the number of records displayed per page.

Note: By default, the number of records that appear in each page depends on the minimum value defined in the **PAGE_NUMBER** lookup field. For example, if the **PAGE_NUMBER** lookup field has four values — 10, 20, 30, and 40, then the number of records displayed in each page, by default, would be 10.

- If required, you can click the **First** (<<), **Previous** (<), **Next** (>), and **Last** (>>) buttons to navigate between pages.
- If required, you can filter the usage records in the **Usage Data** screen.
- If required, you can click the **Export TO Excel** link to download details of all the records of a usage data file in a CSV file format.

Related Topics

For more information on...	See...
How to search for a usage data file	Searching for a Usage Data File on page 1210
How to filter the usage records	Filtering Usage Records on page 1257

Viewing Valid Records of a Usage Data File

Procedure

To view valid records of a usage data file:

1. Search for the usage data file in the **Usage Data Processing** screen.
2. In the **Search Results** section, click the link in the **Valid** column corresponding to the usage data file whose valid records you want to view.

The **Usage Data** screen appears. It contains the following two sections:

- **Search Criteria** — This section allows you to filter the valid records based on the various search criteria. It contains the following fields:

Field Name	Field Description	Mandatory (Yes or No)
File Name	Displays the name of the usage data file.	Not applicable
File Type	Indicates the type of the usage data file.	Not applicable
Default Usage Start Date	Displays the usage start date entered while uploading the usage data file.	Not applicable
Default Usage End Date	Displays the usage end date entered while uploading the usage data file.	Not applicable
Status	Indicates that all valid records are displayed in the Usage Data screen.	Not applicable
Division	Used to specify the division to which the valid record belongs.	No
Account Identifier Type	Used to specify the identifier type based on which you want to search for the valid records.	Yes (Conditional) Note: If you enter the account identifier as a search criteria, you have to enter the account identifier type.
Account Identifier	Used to indicate the account whose valid records you want to view.	Yes (Conditional) Note: If you enter the account identifier type as a search criteria, you have to enter the account identifier.

- **Search Results** — By default, all valid records of the usage data file are listed in the **Search Results** section. You can filter the search results based on the specified criteria. the **Search Results** section contains the following columns:

Column Name	Column Description
ACCOUNT ID TYPE	Indicates the account identifier type.
ACCOUNT IDENTIFIER	Indicates the account to which the usage record belongs.

Column Name	Column Description
ACCOUNT INFORMATION	Displays information about the account.
DIVISION	Indicates the division to which the usage record belongs.
CONTRACT ID	Displays the contract ID. Note: This column appears only if usage data files are uploaded for the insurance module.
CHARGE TYPE	Indicates the charge type. Note: This column appears only if usage data files are uploaded for the insurance module.
START DATE	Displays the date from when the price item was used. Note: If the start date is not available, the default usage start date appears in this column.
END DATE	Displays the date till when the price item was used. Note: If the end date is not available, the default usage end date appears in this column.
DESCRIPTION	Displays the description of the usage record. It is shown on the billable charge.
PRICE ITEM	Displays the price item code.
VARIANCE	Indicates the variance that must be used along with the price item for determining the price item pricing. Note: This column appears when the Multi Price Parameter option type of the Multi Parameter Based Pricing (C1_PPARM_FLG) feature configuration is set to False .
PARAM TYPE1, PARAM TYPE2,, PARAM TYPE15	Indicates the price item parameter that must be used along with the price item for determining the price item pricing. Note: These columns appear when the Multi Price Parameter option type of the Multi Parameter Based Pricing (C1_PPARM_FLG) feature configuration is set to True .
PARAM VALUE1, PARAM VALUE2,, PARAM VALUE15	Displays the value of the price item parameter. Note: These columns appear when the Multi Price Parameter option type of the Multi Parameter Based Pricing (C1_PPARM_FLG) feature configuration is set to True .
SQI1, SQI2,, SQI10	Indicates the service quantity identifier that must be used for calculating the price item charges.
SQIVALUE1, SQIVALUE2,, SQIVALUE10	Displays the number of units of the service quantity.

Column Name	Column Description
BILL LINE DESCRIPTION1, BILL LINE DESCRIPTION2,, BILL LINE DESCRIPTION10	Displays the description of the line item (charge).
AMOUNT1, AMOUNT2,, AMOUNT10	Displays the charge amount.
CURRENCY1, CURRENCY2,, CURRENCY10	Displays the currency in which the amount is charged.
MEMO ONLY1, MEMO ONLY2,, MEMO ONLY10	Indicates whether the charge should be included in the bill amount or not.
SUMMARY1, SUMMARY2,, SUMMARY10	Indicates whether the charge should be included in the summary line or not.
SHOW ON BILL1, SHOW ON BILL2,, SHOW ON BILL10	Indicates whether the charge should appear on the person's printed bill or not.
GL DISTRIBUTION CODE 1, GL DISTRIBUTION CODE 2,, GL DISTRIBUTION CODE 10	Displays the distribution code which indicates the GL account associated with the charge.
CHARTYPE1, CHARTYPE2,, CHARTYPE10	Indicates the characteristic that must be defined for the billable charge.
CHARVAL1, CHARVAL2,, CHARVAL10	Displays the value of the characteristic type.

Note:

If you have defined business labels for usage data fields, the columns will appear with the business labels defined for the respective column.

Only those columns that contain data in the CSV file appear in the **Usage Data** screen. For example, if information about characteristics is provided in the CHARTYPE4 and CHARVAL4 columns of the CSV file, then only the CHARTYPE4 and CHARVAL4 columns appear in the **Usage Data** screen. Similarly, if information about the line item (charge) is provided in the BILL LINE DESCRIPTION6, AMOUNT6, CURRENCY6, MEMO ONLY6, SUMMARY6, SHOW ON BILL6, and GL DISTRIBUTION CODE 6 columns of the CSV file, then only the BILL LINE DESCRIPTION6, AMOUNT6, CURRENCY6, MEMO ONLY6, SUMMARY6, SHOW ON BILL6, AND GL DISTRIBUTION CODE 6 columns appear in the **Usage Data** screen.

Note:

Pagination is used to display limited number of records in the **Search Results** section. You can change the number of records displayed per page, if required. You can use the navigation buttons, such as **First** (<<), **Previous** (<), **Next** (>), and **Last** (>>) to navigate between pages. You can also select the page to which you want to navigate from the **Go To** list.

- View the valid records of the usage data file in the **Usage Data** screen.
- If required, you can change the number of records displayed per page.

Note: By default, the number of records that appear in each page depends on the minimum value defined in the **PAGE_NUMBER** lookup field. For example, if the **PAGE_NUMBER** lookup field has four values — 10, 20, 30, and 40, then the number of records displayed in each page, by default, would be 10.

- If required, you can click the **First** (<<), **Previous** (<), **Next** (>), and **Last** (>>) buttons to navigate between pages.
- If required, you can filter the valid records in the **Usage Data** screen.

Related Topics

For more information on...	See...
How to search for a usage data file	Searching for a Usage Data File on page 1210
How to filter the usage records	Filtering Usage Records on page 1257

Viewing Invalid Records of a Usage Data File**Procedure**

To view invalid records of a usage data file:

- Search for the usage data file in the **Usage Data Processing** screen.
- In the **Search Results** section, click the link in the **Invalid** column corresponding to the usage data file whose invalid records you want to view.

The **Usage Data** screen appears. It contains the following two sections:

- Search Criteria** — This section allows you to filter the invalid records based on the various search criteria. It contains the following fields:

Field Name	Field Description	Mandatory (Yes or No)
File Name	Displays the name of the usage data file.	Not applicable
File Type	Indicates the type of the usage data file.	Not applicable
Default Usage Start Date	Displays the usage start date entered while uploading the usage data file.	Not applicable
Default Usage End Date	Displays the usage end date entered while uploading the usage data file.	Not applicable
Status	Indicates that all invalid records are displayed in the Usage Data screen.	Not applicable

Field Name	Field Description	Mandatory (Yes or No)
Division	Used to specify the division to which the invalid record belongs.	No
Account Identifier Type	Used to specify the identifier type based on which you want to search for the invalid records.	Yes (Conditional) Note: If you enter the account identifier as a search criteria, you have to enter the account identifier type.
Account Identifier	Used to indicate the account whose invalid records you want to view.	Yes (Conditional) Note: If you enter the account identifier type as a search criteria, you have to enter the account identifier.

- **Search Results** — By default, all invalid records of the usage data file are listed in the **Search Results** section. You can filter the search results based on the specified criteria. the **Search Results** section contains the following columns:

Column Name	Column Description
ACCOUNT ID TYPE	Indicates the account identifier type.
ACCOUNT IDENTIFIER	Indicates the account to which the usage record belongs.
ACCOUNT INFORMATION	Displays information about the account.
DIVISION	Indicates the division to which the usage record belongs.
CONTRACT ID	Displays the contract ID. Note: This column appears only if usage data files are uploaded for the insurance module.
CHARGE TYPE	Indicates the charge type. Note: This column appears only if usage data files are uploaded for the insurance module.
START DATE	Displays the date from when the price item was used. Note: If the start date is not available, the default usage start date appears in this column.
END DATE	Displays the date till when the price item was used. Note: If the end date is not available, the default usage end date appears in this column.
DESCRIPTION	Displays the description of the usage record. It is shown on the billable charge.

Column Name	Column Description
PRICE ITEM	Displays the price item code.
VARIANCE	Indicates the variance that must be used along with the price item for determining the price item pricing. Note: This column appears when the Multi Price Parameter option type of the Multi Parameter Based Pricing (C1_PPARM_FLG) feature configuration is set to False .
PARAM TYPE1, PARAM TYPE2,, PARAM TYPE15	Indicates the price item parameter that must be used along with the price item for determining the price item pricing. Note: These columns appear when the Multi Price Parameter option type of the Multi Parameter Based Pricing (C1_PPARM_FLG) feature configuration is set to True .
PARAM VALUE1, PARAM VALUE2,, PARAM VALUE15	Displays the value of the price item parameter. Note: These columns appear when the Multi Price Parameter option type of the Multi Parameter Based Pricing (C1_PPARM_FLG) feature configuration is set to True .
SQI1, SQI2,, SQI10	Indicates the service quantity identifier that must be used for calculating the price item charges.
SQIVALUE1, SQIVALUE2,, SQIVALUE10	Displays the number of units of the service quantity.
BILL LINE DESCRIPTION1, BILL LINE DESCRIPTION2,, BILL LINE DESCRIPTION10	Displays the description of the line item (charge).
AMOUNT1, AMOUNT2,, AMOUNT10	Displays the charge amount.
CURRENCY1, CURRENCY2,, CURRENCY10	Displays the currency in which the amount is charged.
MEMO ONLY1, MEMO ONLY2,, MEMO ONLY10	Indicates whether the charge should be included in the bill amount or not.
SUMMARY1, SUMMARY2,, SUMMARY10	Indicates whether the charge should be included in the summary line or not.
SHOW ON BILL1, SHOW ON BILL2,, SHOW ON BILL10	Indicates whether the charge should appear on the person's printed bill or not.
GL DISTRIBUTION CODE 1, GL DISTRIBUTION	Displays the distribution code which indicates the GL account associated with the charge.

Column Name	Column Description
CODE 2, ..., GL DISTRIBUTION CODE 10	
CHARTYPE1, CHARTYPE2, CHARTYPE10	Indicates the characteristic that must be defined for the billable charge.
CHARVAL1, CHARVAL2, CHARVAL10	Displays the value of the characteristic type.

Note:

If you have defined business labels for usage data fields, the columns will appear with the business labels defined for the respective column.

Only those columns that contain data in the CSV file appear in the **Usage Data** screen. For example, if information about characteristics is provided in the CHARTYPE4 and CHARVAL4 columns of the CSV file, then only the CHARTYPE4 and CHARVAL4 columns appear in the **Usage Data** screen. Similarly, if information about the line item (charge) is provided in the BILL LINE DESCRIPTION6, AMOUNT6, CURRENCY6, MEMO ONLY6, SUMMARY6, SHOW ON BILL6, and GL DISTRIBUTION CODE 6 columns of the CSV file, then only the BILL LINE DESCRIPTION6, AMOUNT6, CURRENCY6, MEMO ONLY6, SUMMARY6, SHOW ON BILL6, AND GL DISTRIBUTION CODE 6 columns appear in the **Usage Data** screen.

Note:

Pagination is used to display limited number of records in the **Search Results** section. You can change the number of records displayed per page, if required. You can use the navigation buttons, such as **First** (<<), **Previous** (<), **Next** (>), and **Last** (>>) to navigate between pages. You can also select the page to which you want to navigate from the **Go To** list.

- View the invalid records of the usage data file in the **Usage Data** screen.
- If required, you can change the number of records displayed per page.

Note: By default, the number of records that appear in each page depends on the minimum value defined in the **PAGE_NUMBER** lookup field. For example, if the **PAGE_NUMBER** lookup field has four values — 10, 20, 30, and 40, then the number of records displayed in each page, by default, would be 10.

- If required, you can click the **First** (<<), **Previous** (<), **Next** (>), and **Last** (>>) buttons to navigate between pages.
- If required, you can filter the invalid records in the **Usage Data** screen.

Related Topics

For more information on...	See...
How to search for a usage data file	Searching for a Usage Data File on page 1210
How to filter the usage records	Filtering Usage Records on page 1257

Viewing Submitted Records of a Usage Data File

Procedure

To view submitted records of a usage data file:

1. Search for the usage data file in the **Usage Data Processing** screen.
2. In the **Search Results** section, click the link in the **Submitted** column corresponding to the usage data file whose submitted records you want to view.

The **Usage Data** screen appears. It contains the following two sections:

- **Search Criteria** — This section allows you to filter the submitted records based on the various search criteria. It contains the following fields:

Field Name	Field Description	Mandatory (Yes or No)
File Name	Displays the name of the usage data file.	Not applicable
File Type	Indicates the type of the usage data file.	Not applicable
Default Usage Start Date	Displays the usage start date entered while uploading the usage data file.	Not applicable
Default Usage End Date	Displays the usage end date entered while uploading the usage data file.	Not applicable
Usage Record Status	Indicates that all records submitted for approval are displayed in the Usage Data screen.	Not applicable
Division	Used to specify the division to which the submitted record belongs.	No
Account Identifier Type	Used to specify the identifier type based on which you want to search for the submitted records.	Yes (Conditional) Note: If you enter the account identifier as a search criteria, you have to enter the account identifier type.
Account Identifier	Used to indicate the account whose submitted records you want to view.	Yes (Conditional) Note: If you enter the account identifier type as a search criteria, you have to enter the account identifier.

- **Search Results** — By default, all submitted records of the usage data file are listed in the **Search Results** section. You can filter the search results based on the specified criteria. the **Search Results** section contains the following columns:

Column Name	Column Description
BILLABLE CHARGE ID	Indicates the billable charge which is generated for the usage record.
ACCOUNT ID TYPE	Indicates the account identifier type.
ACCOUNT IDENTIFIER	Indicates the account to which the usage record belongs.
ACCOUNT INFORMATION	Displays information about the account.

Column Name	Column Description
DIVISION	Indicates the division to which the usage record belongs.
CONTRACT ID	Displays the contract ID. Note: This column appears only if usage data files are uploaded for the insurance module.
CHARGE TYPE	Indicates the charge type. Note: This column appears only if usage data files are uploaded for the insurance module.
START DATE	Displays the date from when the price item was used. Note: If the start date is not available, the default usage start date appears in this column.
END DATE	Displays the date till when the price item was used. Note: If the end date is not available, the default usage end date appears in this column.
DESCRIPTION	Displays the description of the usage record. It is shown on the billable charge.
PRICE ITEM	Displays the price item code.
VARIANCE	Indicates the variance that must be used along with the price item for determining the price item pricing. Note: This column appears when the Multi Price Parameter option type of the Multi Parameter Based Pricing (C1_PPARM_FLG) feature configuration is set to False .
PARAM TYPE1, PARAM TYPE2,, PARAM TYPE15	Indicates the price item parameter that must be used along with the price item for determining the price item pricing. Note: These columns appear when the Multi Price Parameter option type of the Multi Parameter Based Pricing (C1_PPARM_FLG) feature configuration is set to True .
PARAM VALUE1, PARAM VALUE2,, PARAM VALUE15	Displays the value of the price item parameter. Note: These columns appear when the Multi Price Parameter option type of the Multi Parameter Based Pricing (C1_PPARM_FLG) feature configuration is set to True .
SQI1, SQI2,, SQI10	Indicates the service quantity identifier that must be used for calculating the price item charges.
SQIVALUE1, SQIVALUE2,, SQIVALUE10	Displays the number of units of the service quantity.
BILL DESCRIPTION1, LINE BILL	Displays the description of the line item (charge).

Column Name	Column Description
LINE DESCRIPTION2,, BILL LINE DESCRIPTION10	
AMOUNT1, AMOUNT2,, AMOUNT10	Displays the charge amount.
CURRENCY1, CURRENCY2,, CURRENCY10	Displays the currency in which the amount is charged.
MEMO ONLY1, MEMO ONLY2,, MEMO ONLY10	Indicates whether the charge should be included in the bill amount or not.
SUMMARY1, SUMMARY2,, SUMMARY10	Indicates whether the charge should be included in the summary line or not.
SHOW ON BILL1, SHOW ON BILL2,, SHOW ON BILL10	Indicates whether the charge should appear on the person's printed bill or not.
GL DISTRIBUTION CODE 1, GL DISTRIBUTION CODE 2,, GL DISTRIBUTION CODE 10	Displays the distribution code which indicates the GL account associated with the charge.
CHARTYPE1, CHARTYPE2,, CHARTYPE10	Indicates the characteristic that must be defined for the billable charge.
CHARVAL1, CHARVAL2,, CHARVAL10	Displays the value of the characteristic type.

Note:

If you have defined business labels for usage data fields, the columns will appear with the business labels defined for the respective column.

Only those columns that contain data in the CSV file appear in the **Usage Data** screen. For example, if information about characteristics is provided in the CHARTYPE4 and CHARVAL4 columns of the CSV file, then only the CHARTYPE4 and CHARVAL4 columns appear in the **Usage Data** screen. Similarly, if information about the line item (charge) is provided in the BILL LINE DESCRIPTION6, AMOUNT6, CURRENCY6, MEMO ONLY6, SUMMARY6, SHOW ON BILL6, and GL DISTRIBUTION CODE 6 columns of the CSV file, then only the BILL LINE DESCRIPTION6, AMOUNT6, CURRENCY6, MEMO ONLY6, SUMMARY6, SHOW ON BILL6, AND GL DISTRIBUTION CODE 6 columns appear in the **Usage Data** screen.

Note:

Pagination is used to display limited number of records in the **Search Results** section. You can change the number of records displayed per page, if required. You can use the navigation buttons, such as **First** (<<), **Previous** (<), **Next** (>), and **Last** (>>) to navigate between pages. You can also select the page to which you want to navigate from the **Go To** list.

3. View the submitted records of the usage data file in the **Usage Data** screen.
4. If required, you can change the number of records displayed per page.

Note: By default, the number of records that appear in each page depends on the minimum value defined in the **PAGE_NUMBER** lookup field. For example, if the **PAGE_NUMBER** lookup field has four values — 10, 20, 30, and 40, then the number of records displayed in each page, by default, would be 10.

5. If required, you can click the **First** (<<), **Previous** (<), **Next** (>), and **Last** (>>) buttons to navigate between pages.
6. If required, you can filter the submitted records in the **Usage Data** screen.

Related Topics

For more information on...	See...
How to search for a usage data file	Searching for a Usage Data File on page 1210
How to filter the usage records	Filtering Usage Records on page 1257

Viewing Processed Records of a Usage Data File

Procedure

To view processed records of a usage data file:

1. Search for the usage data file in the **Usage Data Processing** screen.
2. In the **Search Results** section, click the link in the **Processed** column corresponding to the usage data file whose processed records you want to view.

The **Usage Data** screen appears. It contains the following two sections:

- **Search Criteria** — This section allows you to filter the processed records based on the various search criteria. It contains the following fields:

Field Name	Field Description	Mandatory (Yes or No)
File Name	Displays the name of the usage data file.	Not applicable
File Type	Indicates the type of the usage data file.	Not applicable
Default Usage Start Date	Displays the usage start date entered while uploading the usage data file.	Not applicable
Default Usage End Date	Displays the usage end date entered while uploading the usage data file.	Not applicable
Usage Record Status	Indicates that all processed records are displayed in the Usage Data screen.	Not applicable
Division	Used to specify the division to which the processed record belongs.	No
Account Identifier Type	Used to specify the identifier type based on which you want to search for the processed records.	Yes (Conditional)

Field Name	Field Description	Mandatory (Yes or No)
		Note: If you enter the account identifier as a search criteria, you have to enter the account identifier type.
Account Identifier	Used to indicate the account whose processed records you want to view.	Yes (Conditional)
		Note: If you enter the account identifier type as a search criteria, you have to enter the account identifier.

- **Search Results** — By default, all processed records of the usage data file are listed in the **Search Results** section. You can filter the search results based on the specified criteria. the **Search Results** section contains the following columns:

Column Name	Column Description
BILLABLE CHARGE ID	Indicates the billable charge which is generated for the usage record.
ACCOUNT ID TYPE	Indicates the account identifier type.
ACCOUNT IDENTIFIER	Indicates the account to which the usage record belongs.
ACCOUNT INFORMATION	Displays information about the account.
DIVISION	Indicates the division to which the usage record belongs.
CONTRACT ID	Displays the contract ID. Note: This column appears only if usage data files are uploaded for the insurance module.
CHARGE TYPE	Indicates the charge type. Note: This column appears only if usage data files are uploaded for the insurance module.
START DATE	Displays the date from when the price item was used. Note: If the start date is not available, the default usage start date appears in this column.
END DATE	Displays the date till when the price item was used. Note: If the end date is not available, the default usage end date appears in this column.
DESCRIPTION	Displays the description of the usage record. It is shown on the billable charge.
PRICE ITEM	Displays the price item code.

Column Name	Column Description
VARIANCE	Indicates the variance that must be used along with the price item for determining the price item pricing. Note: This column appears when the Multi Price Parameter option type of the Multi Parameter Based Pricing (C1_PPARAM_FLG) feature configuration is set to False .
PARAM TYPE1, PARAM TYPE2,, PARAM TYPE15	Indicates the price item parameter that must be used along with the price item for determining the price item pricing. Note: These columns appear when the Multi Price Parameter option type of the Multi Parameter Based Pricing (C1_PPARAM_FLG) feature configuration is set to True .
PARAM VALUE1, PARAM VALUE2,, PARAM VALUE15	Displays the value of the price item parameter. Note: These columns appear when the Multi Price Parameter option type of the Multi Parameter Based Pricing (C1_PPARAM_FLG) feature configuration is set to True .
SQI1, SQI2,, SQI10	Indicates the service quantity identifier that must be used for calculating the price item charges.
SQIVALUE1, SQIVALUE2,, SQIVALUE10	Displays the number of units of the service quantity.
BILL LINE DESCRIPTION1, BILL LINE DESCRIPTION2,, BILL LINE DESCRIPTION10	Displays the description of the line item (charge).
AMOUNT1, AMOUNT2,, AMOUNT10	Displays the charge amount.
CURRENCY1, CURRENCY2,, CURRENCY10	Displays the currency in which the amount is charged.
MEMO ONLY1, MEMO ONLY2,, MEMO ONLY10	Indicates whether the charge should be included in the bill amount or not.
SUMMARY1, SUMMARY2,, SUMMARY10	Indicates whether the charge should be included in the summary line or not.
SHOW ON BILL1, SHOW ON BILL2,, SHOW ON BILL10	Indicates whether the charge should appear on the person's printed bill or not.
GL DISTRIBUTION CODE 1, GL DISTRIBUTION CODE 2,, GL DISTRIBUTION CODE 10	Displays the distribution code which indicates the GL account associated with the charge.

Column Name	Column Description
CHARTYPE1, CHARTYPE2,, CHARTYPE10	Indicates the characteristic that must be defined for the billable charge.
CHARVAL1, CHARVAL2,, CHARVAL10	Displays the value of the characteristic type.

Note:

If you have defined business labels for usage data fields, the columns will appear with the business labels defined for the respective column.

Only those columns that contain data in the CSV file appear in the **Usage Data** screen. For example, if information about characteristics is provided in the CHARTYPE4 and CHARVAL4 columns of the CSV file, then only the CHARTYPE4 and CHARVAL4 columns appear in the **Usage Data** screen. Similarly, if information about the line item (charge) is provided in the BILL LINE DESCRIPTION6, AMOUNT6, CURRENCY6, MEMO ONLY6, SUMMARY6, SHOW ON BILL6, and GL DISTRIBUTION CODE 6 columns of the CSV file, then only the BILL LINE DESCRIPTION6, AMOUNT6, CURRENCY6, MEMO ONLY6, SUMMARY6, SHOW ON BILL6, AND GL DISTRIBUTION CODE 6 columns appear in the **Usage Data** screen.

Note:

Pagination is used to display limited number of records in the **Search Results** section. You can change the number of records displayed per page, if required. You can use the navigation buttons, such as **First** (<<), **Previous** (<), **Next** (>), and **Last** (>>) to navigate between pages. You can also select the page to which you want to navigate from the **Go To** list.

- View the processed records of the usage data file in the **Usage Data** screen.
- If required, you can change the number of records displayed per page.

Note: By default, the number of records that appear in each page depends on the minimum value defined in the **PAGE_NUMBER** lookup field. For example, if the **PAGE_NUMBER** lookup field has four values — 10, 20, 30, and 40, then the number of records displayed in each page, by default, would be 10.

- If required, you can click the **First** (<<), **Previous** (<), **Next** (>), and **Last** (>>) buttons to navigate between pages.
- If required, you can filter the processed records in the **Usage Data** screen.

Related Topics

For more information on...	See...
How to search for a usage data file	Searching for a Usage Data File on page 1210
How to filter the usage records	Filtering Usage Records on page 1257

Viewing Cancelled Records of a Usage Data File

Procedure

To view cancelled records of a usage data file:

1. Search for the usage data file in the **Usage Data Processing** screen.
2. In the **Search Results** section, click the link in the **Cancelled** column corresponding to the usage data file whose cancelled records you want to view.

The **Usage Data** screen appears. It contains the following two sections:

- **Search Criteria** — This section allows you to filter the cancelled records based on the various search criteria. It contains the following fields:

Field Name	Field Description	Mandatory (Yes or No)
File Name	Displays the name of the usage data file.	Not applicable
File Type	Indicates the type of the usage data file.	Not applicable
Default Usage Start Date	Displays the usage start date entered while uploading the usage data file.	Not applicable
Default Usage End Date	Displays the usage end date entered while uploading the usage data file.	Not applicable
Usage Record Status	Indicates that all cancelled records are displayed in the Usage Data screen.	Not applicable
Division	Used to specify the division to which the cancelled record belongs.	No
Account Identifier Type	Used to specify the identifier type based on which you want to search for the cancelled records.	Yes (Conditional) Note: If you enter the account identifier as a search criteria, you have to enter the account identifier type.
Account Identifier	Used to indicate the account whose cancelled records you want to view.	Yes (Conditional) Note: If you enter the account identifier type as a search criteria, you have to enter the account identifier.

- **Search Results** — By default, all cancelled records of the usage data file are listed in the **Search Results** section. You can filter the search results based on the specified criteria. the **Search Results** section contains the following columns:

Column Name	Column Description
BILLABLE CHARGE ID	Indicates the billable charge which is generated for the usage record. Note: This column appears only if you have cancelled a valid record for which billable charges have been created.
ACCOUNT ID TYPE	Indicates the account identifier type.
ACCOUNT IDENTIFIER	Indicates the account to which the usage record belongs.
ACCOUNT INFORMATION	Displays information about the account.

Column Name	Column Description
DIVISION	Indicates the division to which the usage record belongs.
CONTRACT ID	Displays the contract ID. Note: This column appears only if usage data files are uploaded for the insurance module.
CHARGE TYPE	Indicates the charge type. Note: This column appears only if usage data files are uploaded for the insurance module.
START DATE	Displays the date from when the price item was used. Note: If the start date is not available, the default usage start date appears in this column.
END DATE	Displays the date till when the price item was used. Note: If the end date is not available, the default usage end date appears in this column.
DESCRIPTION	Displays the description of the usage record. It is shown on the billable charge.
PRICE ITEM	Displays the price item code.
VARIANCE	Indicates the variance that must be used along with the price item for determining the price item pricing. Note: This column appears when the Multi Price Parameter option type of the Multi Parameter Based Pricing (C1_PPARM_FLG) feature configuration is set to False .
PARAM TYPE1, PARAM TYPE2,, PARAM TYPE15	Indicates the price item parameter that must be used along with the price item for determining the price item pricing. Note: These columns appear when the Multi Price Parameter option type of the Multi Parameter Based Pricing (C1_PPARM_FLG) feature configuration is set to True .
PARAM VALUE1, PARAM VALUE2,, PARAM VALUE15	Displays the value of the price item parameter. Note: These columns appear when the Multi Price Parameter option type of the Multi Parameter Based Pricing (C1_PPARM_FLG) feature configuration is set to True .
SQI1, SQI2,, SQI10	Indicates the service quantity identifier that must be used for calculating the price item charges.
SQIVALUE1, SQIVALUE2,, SQIVALUE10	Displays the number of units of the service quantity.
BILL DESCRIPTION1, LINE BILL	Displays the description of the line item (charge).

Column Name	Column Description
LINE DESCRIPTION2,, BILL LINE DESCRIPTION10	
AMOUNT1, AMOUNT2,, AMOUNT10	Displays the charge amount.
CURRENCY1, CURRENCY2,, CURRENCY10	Displays the currency in which the amount is charged.
MEMO ONLY1, MEMO ONLY2,, MEMO ONLY10	Indicates whether the charge should be included in the bill amount or not.
SUMMARY1, SUMMARY2,, SUMMARY10	Indicates whether the charge should be included in the summary line or not.
SHOW ON BILL1, SHOW ON BILL2,, SHOW ON BILL10	Indicates whether the charge should appear on the person's printed bill or not.
GL DISTRIBUTION CODE 1, GL DISTRIBUTION CODE 2,, GL DISTRIBUTION CODE 10	Displays the distribution code which indicates the GL account associated with the charge.
CHARTYPE1, CHARTYPE2,, CHARTYPE10	Indicates the characteristic that must be defined for the billable charge.
CHARVAL1, CHARVAL2,, CHARVAL10	Displays the value of the characteristic type.
REASON	Indicates the reason why the usage record was cancelled.
COMMENTS	Displays additional information entered while cancelling a usage record.

Note:

If you have defined business labels for usage data fields, the columns will appear with the business labels defined for the respective column.

Only those columns that contain data in the CSV file appear in the **Usage Data** screen. For example, if information about characteristics is provided in the CHARTYPE4 and CHARVAL4 columns of the CSV file, then only the CHARTYPE4 and CHARVAL4 columns appear in the **Usage Data** screen. Similarly, if information about the line item (charge) is provided in the BILL LINE DESCRIPTION6, AMOUNT6, CURRENCY6, MEMO ONLY6, SUMMARY6, SHOW ON BILL6, and GL DISTRIBUTION CODE 6 columns of the CSV file, then only the BILL LINE DESCRIPTION6, AMOUNT6, CURRENCY6, MEMO ONLY6, SUMMARY6, SHOW ON BILL6, AND GL DISTRIBUTION CODE 6 columns appear in the **Usage Data** screen.

Note:

Pagination is used to display limited number of records in the **Search Results** section. You can change the number of records displayed per page, if required. You can use the navigation buttons, such as **First** (<<), **Previous** (<), **Next** (>), and **Last** (>>) to navigate between pages. You can also select the page to which you want to navigate from the **Go To** list.

- View the cancelled records of the usage data file in the **Usage Data** screen.
- If required, you can change the number of records displayed per page.

Note: By default, the number of records that appear in each page depends on the minimum value defined in the **PAGE_NUMBER** lookup field. For example, if the **PAGE_NUMBER** lookup field has four values — 10, 20, 30, and 40, then the number of records displayed in each page, by default, would be 10.

- If required, you can click the **First** (<<), **Previous** (<), **Next** (>), and **Last** (>>) buttons to navigate between pages.
- If required, you can filter the cancelled records in the **Usage Data** screen.

Related Topics

For more information on...	See...
How to search for a usage data file	Searching for a Usage Data File on page 1210
How to filter the usage records	Filtering Usage Records on page 1257

Viewing Rejected Records of a Usage Data File**Procedure**

To view rejected records of a usage data file:

- Search for the usage data file in the **Usage Data Processing** screen.
- In the **Search Results** section, click the link in the **Rejected** column corresponding to the usage data file whose rejected records you want to view.

The **Usage Data** screen appears. It contains the following two sections:

- Search Criteria** — This section allows you to filter the rejected records based on the various search criteria. It contains the following fields:

Field Name	Field Description	Mandatory (Yes or No)
File Name	Displays the name of the usage data file.	Not applicable
File Type	Indicates the type of the usage data file.	Not applicable
Default Usage Start Date	Displays the usage start date entered while uploading the usage data file.	Not applicable
Default Usage End Date	Displays the usage end date entered while uploading the usage data file.	Not applicable
Status	Indicates that all rejected records are displayed in the Usage Data screen.	Not applicable

Field Name	Field Description	Mandatory (Yes or No)
Division	Used to specify the division to which the rejected record belongs.	No
Account Identifier Type	Used to specify the identifier type based on which you want to search for the rejected records.	Yes (Conditional) Note: If you enter the account identifier as a search criteria, you have to enter the account identifier type.
Account Identifier	Used to indicate the account whose rejected records you want to view.	Yes (Conditional) Note: If you enter the account identifier type as a search criteria, you have to enter the account identifier.

- **Search Results** — By default, all rejected records of the usage data file are listed in the **Search Results** section. You can filter the search results based on the specified criteria. the **Search Results** section contains the following columns:

Column Name	Column Description
ACCOUNT ID TYPE	Indicates the account identifier type.
ACCOUNT IDENTIFIER	Indicates the account to which the usage record belongs.
ACCOUNT INFORMATION	Displays information about the account.
DIVISION	Indicates the division to which the usage record belongs.
CONTRACT ID	Displays the contract ID. Note: This column appears only if usage data files are uploaded for the insurance module.
CHARGE TYPE	Indicates the charge type. Note: This column appears only if usage data files are uploaded for the insurance module.
START DATE	Displays the date from when the price item was used. Note: If the start date is not available, the default usage start date appears in this column.
END DATE	Displays the date till when the price item was used. Note: If the end date is not available, the default usage end date appears in this column.
DESCRIPTION	Displays the description of the usage record. It is shown on the billable charge.

Column Name	Column Description
PRICE ITEM	Displays the price item code.
VARIANCE	Indicates the variance that must be used along with the price item for determining the price item pricing. Note: This column appears when the Multi Price Parameter option type of the Multi Parameter Based Pricing (C1_PPARM_FLG) feature configuration is set to False .
PARAM TYPE 1, PARAM TYPE 2,, PARAM TYPE 15	Indicates the price item parameter that must be used along with the price item for determining the price item pricing. Note: These columns appear when the Multi Price Parameter option type of the Multi Parameter Based Pricing (C1_PPARM_FLG) feature configuration is set to True .
PARAM VALUE 1, PARAM VALUE 2,, PARAM VALUE 15	Displays the value of the price item parameter. Note: These columns appear when the Multi Price Parameter option type of the Multi Parameter Based Pricing (C1_PPARM_FLG) feature configuration is set to True .
SQI1, SQI2,, SQI10	Indicates the service quantity identifier that must be used for calculating the price item charges.
SQIVALUE1, SQIVALUE2,, SQIVALUE10	Displays the number of units of the service quantity.
BILL LINE DESCRIPTION1, BILL LINE DESCRIPTION2,, BILL LINE DESCRIPTION10	Displays the description of the line item (charge).
AMOUNT1, AMOUNT2,, AMOUNT10	Displays the charge amount.
CURRENCY 1, CURRENCY 2,, CURRENCY 10	Displays the currency in which the amount is charged.
MEMO ONLY 1, MEMO ONLY 2,, MEMO ONLY 10	Indicates whether the charge should be included in the bill amount or not.
SUMMARY 1, SUMMARY 2,, SUMMARY 10	Indicates whether the charge should be included in the summary line or not.
SHOW ON BILL 1, SHOW ON BILL 2,, SHOW ON BILL 10	Indicates whether the charge should appear on the person's printed bill or not.
GL DISTRIBUTION CODE 1, GL DISTRIBUTION CODE 2,, GL DISTRIBUTION CODE 10	Displays the distribution code which indicates the GL account associated with the charge.

Column Name	Column Description
CHARTYPE 1, CHARTYPE 2,, CHARTYPE 10	Indicates the characteristic that must be defined for the billable charge.
CHARVAL 1, CHARVAL 2,, CHARVAL 10	Displays the value of the characteristic type.
REASON	Indicates the reason why the usage record was rejected by the approver.
COMMENTS	Displays additional information entered while rejecting a usage record.

Note:

If you have defined business labels for usage data fields, the columns will appear with the business labels defined for the respective column.

Only those columns that contain data in the CSV file appear in the **Usage Data** screen. For example, if information about characteristics is provided in the CHARTYPE4 and CHARVAL4 columns of the CSV file, then only the CHARTYPE4 and CHARVAL4 columns appear in the **Usage Data** screen. Similarly, if information about the line item (charge) is provided in the BILL LINE DESCRIPTION6, AMOUNT6, CURRENCY6, MEMO ONLY6, SUMMARY6, SHOW ON BILL6, and GL DISTRIBUTION CODE 6 columns of the CSV file, then only the BILL LINE DESCRIPTION6, AMOUNT6, CURRENCY6, MEMO ONLY6, SUMMARY6, SHOW ON BILL6, AND GL DISTRIBUTION CODE 6 columns appear in the **Usage Data** screen.

Note:

Pagination is used to display limited number of records in the **Search Results** section. You can change the number of records displayed per page, if required. You can use the navigation buttons, such as **First** (<<), **Previous** (<), **Next** (>), and **Last** (>>) to navigate between pages. You can also select the page to which you want to navigate from the **Go To** list.

- View the rejected records of the usage data file in the **Usage Data** screen.
- If required, you can change the number of records displayed per page.

Note: By default, the number of records that appear in each page depends on the minimum value defined in the **PAGE_NUMBER** lookup field. For example, if the **PAGE_NUMBER** lookup field has four values — 10, 20, 30, and 40, then the number of records displayed in each page, by default, would be 10.

- If required, you can click the **First** (<<), **Previous** (<), **Next** (>), and **Last** (>>) buttons to navigate between pages.
- If required, you can filter the rejected records in the **Usage Data** screen.

Related Topics

For more information on...	See...
How to search for a usage data file	Searching for a Usage Data File on page 1210
How to filter the usage records	Filtering Usage Records on page 1257

Viewing Billed Records of a Usage Data File**Procedure**

To view billed records of a usage data file:

1. Search for the usage data file in the **Usage Data Processing** screen.
2. In the **Search Results** section, click the link in the **Billed** column corresponding to the usage data file whose billed records you want to view.

The **Usage Data** screen appears. It contains the following two sections:

- **Search Criteria** — This section allows you to filter the billed records based on the various search criteria. It contains the following fields:

Field Name	Field Description	Mandatory (Yes or No)
File Name	Displays the name of the usage data file.	Not applicable
File Type	Indicates the type of the usage data file.	Not applicable
Default Usage Start Date	Displays the usage start date entered while uploading the usage data file.	Not applicable
Default Usage End Date	Displays the usage end date entered while uploading the usage data file.	Not applicable
Usage Record Status	Indicates that all billed records are displayed in the Usage Data screen.	Not applicable
Division	Used to specify the division to which the billed record belongs.	No
Account Identifier Type	Used to specify the identifier type based on which you want to search for the billed records.	Yes (Conditional) Note: If you enter the account identifier as a search criteria, you have to enter the account identifier type.
Account Identifier	Used to indicate the account whose billed records you want to view.	Yes (Conditional) Note: If you enter the account identifier type as a search criteria, you have to enter the account identifier.

- **Search Results** — By default, all billed records of the usage data file are listed in the **Search Results** section. You can filter the search results based on the specified criteria. the **Search Results** section contains the following columns:

Column Name	Column Description
BILLABLE CHARGE ID	Indicates the billable charge which is generated for the usage record.
ACCOUNT ID TYPE	Indicates the account identifier type.
ACCOUNT IDENTIFIER	Indicates the account to which the usage record belongs.
ACCOUNT INFORMATION	Displays information about the account.
DIVISION	Indicates the division to which the usage record belongs.

Column Name	Column Description
CONTRACT ID	Displays the contract ID.
	Note: This column appears only if usage data files are uploaded for the insurance module.
CHARGE TYPE	Indicates the charge type.
	Note: This column appears only if usage data files are uploaded for the insurance module.
START DATE	Displays the date from when the price item was used.
	Note: If the start date is not available, the default usage start date appears in this column.
END DATE	Displays the date till when the price item was used.
	Note: If the end date is not available, the default usage end date appears in this column.
DESCRIPTION	Displays the description of the usage record. It is shown on the billable charge.
PRICE ITEM	Displays the price item code.
VARIANCE	Indicates the variance that must be used along with the price item for determining the price item pricing.
	Note: This column appears when the Multi Price Parameter option type of the Multi Parameter Based Pricing (C1_PPARM_FLG) feature configuration is set to False .
PARAM TYPE1, PARAM TYPE2,, PARAM TYPE15	Indicates the price item parameter that must be used along with the price item for determining the price item pricing.
	Note: These columns appear when the Multi Price Parameter option type of the Multi Parameter Based Pricing (C1_PPARM_FLG) feature configuration is set to True .
PARAM VALUE1, PARAM VALUE2,, PARAM VALUE15	Displays the value of the price item parameter.
	Note: These columns appear when the Multi Price Parameter option type of the Multi Parameter Based Pricing (C1_PPARM_FLG) feature configuration is set to True .
SQI1, SQI2,, SQI10	Indicates the service quantity identifier that must be used for calculating the price item charges.
SQIVALUE1, SQIVALUE2,, SQIVALUE10	Displays the number of units of the service quantity.
BILL LINE DESCRIPTION1, BILL LINE DESCRIPTION2,,	Displays the description of the line item (charge).

Column Name	Column Description
BILL DESCRIPTION1 LINE	
AMOUNT1, AMOUNT2, AMOUNT10	Displays the charge amount.
CURRENCY1, CURRENCY2, CURRENCY10	Displays the currency in which the amount is charged.
MEMO ONLY1, MEMO ONLY2, MEMO ONLY10	Indicates whether the charge should be included in the bill amount or not.
SUMMARY1, SUMMARY2, SUMMARY10	Indicates whether the charge should be included in the summary line or not.
SHOW ON BILL1, SHOW ON BILL2, SHOW ON BILL10	Indicates whether the charge should appear on the person's printed bill or not.
GL DISTRIBUTION CODE 1, GL DISTRIBUTION CODE 2,, GL DISTRIBUTION CODE 10	Displays the distribution code which indicates the GL account associated with the charge.
CHARTYPE1, CHARTYPE2, CHARTYPE10	Indicates the characteristic that must be defined for the billable charge.
CHARVAL1, CHARVAL2, CHARVAL10	Displays the value of the characteristic type.

Note:

If you have defined business labels for usage data fields, the columns will appear with the business labels defined for the respective column.

Only those columns that contain data in the CSV file appear in the **Usage Data** screen. For example, if information about characteristics is provided in the CHARTYPE4 and CHARVAL4 columns of the CSV file, then only the CHARTYPE4 and CHARVAL4 columns appear in the **Usage Data** screen. Similarly, if information about the line item (charge) is provided in the BILL LINE DESCRIPTION6, AMOUNT6, CURRENCY6, MEMO ONLY6, SUMMARY6, SHOW ON BILL6, and GL DISTRIBUTION CODE 6 columns of the CSV file, then only the BILL LINE DESCRIPTION6, AMOUNT6, CURRENCY6, MEMO ONLY6, SUMMARY6, SHOW ON BILL6, AND GL DISTRIBUTION CODE 6 columns appear in the **Usage Data** screen.

Note:

Pagination is used to display limited number of records in the **Search Results** section. You can change the number of records displayed per page, if required. You can use the navigation buttons, such as **First** (<<), **Previous** (<), **Next** (>), and **Last** (>>) to navigate between pages. You can also select the page to which you want to navigate from the **Go To** list.

- View the billed records of the usage data file in the **Usage Data** screen.

- If required, you can change the number of records displayed per page.

Note: By default, the number of records that appear in each page depends on the minimum value defined in the **PAGE_NUMBER** lookup field. For example, if the **PAGE_NUMBER** lookup field has four values — 10, 20, 30, and 40, then the number of records displayed in each page, by default, would be 10.

- If required, you can click the **First** (<<), **Previous** (<), **Next** (>), and **Last** (>>) buttons to navigate between pages.
- If required, you can filter the billed records in the **Usage Data** screen.

Related Topics

For more information on...	See...
How to search for a usage data file	Searching for a Usage Data File on page 1210
How to filter the usage records	Filtering Usage Records on page 1257

Viewing Unbilled Records of a Usage Data File

Procedure

To view unbilled records of a usage data file:

- Search for the usage data file in the **Usage Data Processing** screen.
- In the **Search Results** section, click the link in the **Unbilled** column corresponding to the usage data file whose unbilled records you want to view.

The **Usage Data** screen appears. It contains the following two sections:

- Search Criteria** — This section allows you to filter the unbilled records based on the various search criteria. It contains the following fields:

Field Name	Field Description	Mandatory (Yes or No)
File Name	Displays the name of the usage data file.	Not applicable
File Type	Indicates the type of the usage data file.	Not applicable
Default Usage Start Date	Displays the usage start date entered while uploading the usage data file.	Not applicable
Default Usage End Date	Displays the usage end date entered while uploading the usage data file.	Not applicable
Usage Record Status	Indicates that all unbilled records are displayed in the Usage Data screen.	Not applicable
Division	Used to specify the division to which the unbilled record belongs.	No
Account Identifier Type	Used to specify the identifier type based on which you want to search for the unbilled records.	Yes (Conditional)

Note: If you enter the account identifier as a search criteria, you have to enter the account identifier type.

Field Name	Field Description	Mandatory (Yes or No)
Account Identifier	Used to indicate the account whose unbilled records you want to view.	Yes (Conditional)
		Note: If you enter the account identifier type as a search criteria, you have to enter the account identifier.

- **Search Results** — By default, all unbilled records of the usage data file are listed in the **Search Results** section. You can filter the search results based on the specified criteria. the **Search Results** section contains the following columns:

Column Name	Column Description
BILLABLE CHARGE ID	Indicates the billable charge which is generated for the usage record.
ACCOUNT ID TYPE	Indicates the account identifier type.
ACCOUNT IDENTIFIER	Indicates the account to which the usage record belongs.
ACCOUNT INFORMATION	Displays information about the account.
DIVISION	Indicates the division to which the usage record belongs.
CONTRACT ID	Displays the contract ID. Note: This column appears only if usage data files are uploaded for the insurance module.
CHARGE TYPE	Indicates the charge type. Note: This column appears only if usage data files are uploaded for the insurance module.
START DATE	Displays the date from when the price item was used. Note: If the start date is not available, the default usage start date appears in this column.
END DATE	Displays the date till when the price item was used. Note: If the end date is not available, the default usage end date appears in this column.
DESCRIPTION	Displays the description of the usage record. It is shown on the billable charge.
PRICE ITEM	Displays the price item code.
VARIANCE	Indicates the variance that must be used along with the price item for determining the price item pricing. Note: This column appears when the Multi Price Parameter option type of the Multi Parameter Based Pricing (C1_PPARM_FLG) feature configuration is set to False .

Column Name	Column Description
PARAM TYPE1, PARAM TYPE2,, PARAM TYPE15	Indicates the price item parameter that must be used along with the price item for determining the price item pricing. Note: These columns appear when the Multi Price Parameter option type of the Multi Parameter Based Pricing (C1_PPARAM_FLG) feature configuration is set to True .
PARAM VALUE1, PARAM VALUE2,, PARAM VALUE15	Displays the value of the price item parameter. Note: These columns appear when the Multi Price Parameter option type of the Multi Parameter Based Pricing (C1_PPARAM_FLG) feature configuration is set to True .
SQI1, SQI2,, SQI10	Indicates the service quantity identifier that must be used for calculating the price item charges.
SQIVALUE1, SQIVALUE2,, SQIVALUE10	Displays the number of units of the service quantity.
BILL LINE DESCRIPTION1, BILL LINE DESCRIPTION2,, BILL LINE DESCRIPTION10	Displays the description of the line item (charge).
AMOUNT1, AMOUNT2,, AMOUNT10	Displays the charge amount.
CURRENCY1, CURRENCY2,, CURRENCY10	Displays the currency in which the amount is charged.
MEMO ONLY1, MEMO ONLY2,, MEMO ONLY10	Indicates whether the charge should be included in the bill amount or not.
SUMMARY1, SUMMARY2,, SUMMARY10	Indicates whether the charge should be included in the summary line or not.
SHOW ON BILL1, SHOW ON BILL2,, SHOW ON BILL10	Indicates whether the charge should appear on the person's printed bill or not.
GL DISTRIBUTION CODE 1, GL DISTRIBUTION CODE 2,, GL DISTRIBUTION CODE 10	Displays the distribution code which indicates the GL account associated with the charge.
CHARTYPE1, CHARTYPE2,, CHARTYPE10	Indicates the characteristic that must be defined for the billable charge.
CHARVAL1, CHARVAL2,, CHARVAL10	Displays the value of the characteristic type.

Note:

If you have defined business labels for usage data fields, the columns will appear with the business labels defined for the respective column.

Only those columns that contain data in the CSV file appear in the **Usage Data** screen. For example, if information about characteristics is provided in the CHARTYPE4 and CHARVAL4 columns of the CSV file, then only the CHARTYPE4 and CHARVAL4 columns appear in the **Usage Data** screen. Similarly, if information about the line item (charge) is provided in the BILL LINE DESCRIPTION6, AMOUNT6, CURRENCY6, MEMO ONLY6, SUMMARY6, SHOW ON BILL6, and GL DISTRIBUTION CODE 6 columns of the CSV file, then only the BILL LINE DESCRIPTION6, AMOUNT6, CURRENCY6, MEMO ONLY6, SUMMARY6, SHOW ON BILL6, AND GL DISTRIBUTION CODE 6 columns appear in the **Usage Data** screen.

Note:

Pagination is used to display limited number of records in the **Search Results** section. You can change the number of records displayed per page, if required. You can use the navigation buttons, such as **First** (<<), **Previous** (<), **Next** (>), and **Last** (>>) to navigate between pages. You can also select the page to which you want to navigate from the **Go To** list.

- View the unbilled records of the usage data file in the **Usage Data** screen.
- If required, you can change the number of records displayed per page.

Note: By default, the number of records that appear in each page depends on the minimum value defined in the **PAGE_NUMBER** lookup field. For example, if the **PAGE_NUMBER** lookup field has four values — 10, 20, 30, and 40, then the number of records displayed in each page, by default, would be 10.

- If required, you can click the **First** (<<), **Previous** (<), **Next** (>), and **Last** (>>) buttons to navigate between pages.
- If required, you can filter the unbilled records in the **Usage Data** screen.

Related Topics

For more information on...	See...
How to search for a usage data file	Searching for a Usage Data File on page 1210
How to filter the usage records	Filtering Usage Records on page 1257

Submitting a Valid Record**Procedure**

To submit a valid record:

- Search for the usage data file in the **Usage Data Processing** screen.
- In the **Search Results** section, click the **Submit** (👉) icon corresponding to the usage data file whose valid records you want to submit.

The system behaves in the following manner when:

- Billing Method — Adhoc Billing, Approval Workflow — Off, and Bill After Date — Current or Future Date:** A billable charge is created for each valid usage record. The **Adhoc Bill** flag is set to **Y** and

the **Bill After Date** is stamped on the billable charge. If the total number of valid records in a usage data file exceeds the transaction limit, a batch job is created using the **Billable Charge Creation (C1-ODBCH)** batch. A message appears indicating the batch job ID. This batch job creates a billable charge for each valid usage record. The status of the usage record is changed to **Processed**.

- **Billing Method — Adhoc Billing, Approval Workflow — On, and Bill After Date — Current or Future Date:** A To Do entry is created for the approver to approve the valid records. The status of the usage record is changed to **Submitted**.
- **Billing Method — Regular Billing, Approval Workflow — Off, and Bill After Date — Specified:** A billable charge is created for each valid usage record. The **Adhoc Bill** flag is set to **N** and the **Bill After Date** is stamped on the billable charge. If the total number of valid records in a usage data file exceeds the transaction limit, a batch job is created using the **Billable Charge Creation (C1-ODBCH)** batch. A message appears indicating the batch job ID. This batch job creates a billable charge for each valid usage record. The status of the usage record is changed to **Processed**. The bills will be generated for the account in the bill cycle in which the bill after date falls.
- **Billing Method — Regular Billing, Approval Workflow — Off, and Bill After Date — Not Specified:** A billable charge is created for each valid usage record. The **Adhoc Bill** flag is set to **N** in the billable charge. If the total number of valid records in a usage data file exceeds the transaction limit, a batch job is created using the **Billable Charge Creation (C1-ODBCH)** batch. A message appears indicating the batch job ID. This batch job creates a billable charge for each valid usage record. The status of the usage record is changed to **Processed**. The bills will be generated for the account based on the bill cycle defined for the account.
- **Billing Method — Regular Billing and Approval Workflow — On:** A To Do entry is created for the approver to approve the valid records. The status of the usage record is changed to **Submitted**.

Note:

You can change the transaction limit, whenever required, using the **On Demand Billing (C1-ODBFC)** feature configuration. For more information on the **Billable Charge Creation (C1-ODBCH)** batch, see *Oracle Revenue Management and Billing Batch Execution Guide*.

If you want to create billable charges for valid usage records where start date is a future date, then ensure that the **Use Calendar Billing** option is set to **Allow Advanced Billing** in the respective contract type.

If a batch job is created automatically, the number of valid records for which billable charges are created in each work unit depends on the value defined for the **Billable Charge Chunk Size** option type in the **On Demand Billing (C1-ODBFC)** feature configuration.

In case an account belongs to an invoicing group, the billable charge is created for the member account and the bill is generated for the master account.

On successful completion of the **Billable Charge Creation (C1-ODBCH)** batch, a To Do entry is created using the **C1-ODBCH To Do** type. You can view this To Do entry when you are assigned a To Do role which is mapped to the **C1-ODBCH To Do** type. This To Do indicates whether the batch was successfully executed or not. If the batch was successfully executed, it indicates the following:

- Number of records for which billable charges were created
- Number of records for which billable charges could not be created successfully

3. If a batch job is created automatically, click **OK** in the message box.

Related Topics

For more information on...	See...
How to search for a usage data file	Searching for a Usage Data File on page 1210
How to set the On Demand Billing (C1-ODBFC) feature configuration	Setting the C1-ODBFC Feature Configuration on page 4333



Approving a Valid Record

You can view the number of records which are pending for approval in the **Submitted** column corresponding to the usage data file in the **Usage Data Processing** screen. The approver can review, and accordingly approve or reject the usage record based on the observations.

Note: The system will not allow you to approve or reject a usage record submitted by you.

Procedure

To approve a valid record:

1. Do either of the following:

If you want to...	Then...
Approve the usage record from the Usage Data Processing screen	<ol style="list-style-type: none"> 1. Search for the usage data file in the Usage Data Processing screen. 2. In the Search Results section, click the Approve (☑) icon corresponding to the usage data file whose records you want to review.
Approve the usage record from the To Do List screen	<ol style="list-style-type: none"> 1. From the Main Menu, select To Do and then click To Do List. The To Do Type for User Search window appears. 2. Select the type of To Do entries you want to view. The To Do List screen appears. 3. Select Open from the Filter by list to view all unassigned To Dos. 4. Click the Submitted Message link corresponding to the To Do entry whose records you want to review.

The **Usage Data** screen appears.

2. Review the usage records which you want approve or reject.
3. Do either of the following:

If you want to...	Then...
Approve one or more usage records	<ol style="list-style-type: none"> 1. If the usage record is accurate, then select the check box corresponding to the usage record. 2. Click Approve. The system behaves in the following manner when: <ul style="list-style-type: none"> • Billing Method — Adhoc Billing and Bill After Date — Current or Future Date: A billable charge is created for each valid record which is approved. The Adhoc Bill flag is set to Y and

If you want to...	Then...
	<p>the Bill After Date is stamped on the billable charge. The status of the usage record is changed to Processed.</p> <ul style="list-style-type: none"> • Billing Method — Regular Billing and Bill After Date — Specified: A billable charge is created for each valid record which is approved. The Adhoc Bill flag is set to N and the Bill After Date is stamped on the billable charge. The status of the usage record is changed to Processed. The bills will be generated for the account in the bill cycle in which the bill after date falls. • Billing Method — Regular Billing and Bill After Date — Not Specified: A billable charge is created for each valid record which is approved. The Adhoc Bill flag is set to N in the billable charge. The status of the usage record is changed to Processed. The bills will be generated for the account based on the bill cycle defined for the account.
Approve all usage records	<p>1. Click Approve All.</p> <p>The system behaves in the following manner when:</p> <ul style="list-style-type: none"> • Billing Method — Adhoc Billing and Bill After Date — Current or Future Date: A billable charge is created for each valid record which is approved. The Adhoc Bill flag is set to Y and the Bill After Date is stamped on the billable charge. If the total number of records that you want to approve exceeds the transaction limit, a batch job is created using the Billable Charge Creation (C1-ODBCH) batch. A message appears indicating the batch job ID. This batch job creates a billable charge for each valid usage record. The status of the usage record is changed to Processed. • Billing Method — Regular Billing and Bill After Date — Specified: A billable charge is created for each valid record which is approved. The Adhoc Bill flag is set to N and the Bill After Date is stamped on the billable charge. If the total number of records that you want to approve exceeds the transaction limit, a batch job is created using the Billable Charge Creation (C1-ODBCH) batch. A message appears indicating the batch job ID. This batch job creates a billable charge for each valid usage record. The status of the usage record is changed to Processed. The bills will be generated for the account in the bill cycle in which the bill after date falls. • Billing Method — Regular Billing and Bill After Date — Not Specified: A billable charge is created for each valid record which is approved. The

If you want to...	Then...
	<p>Adhoc Bill flag is set to N in the billable charge. If the total number of records that you want to approve exceeds the transaction limit, a batch job is created using the Billable Charge Creation (C1-ODBCH) batch. A message appears indicating the batch job ID. This batch job creates a billable charge for each valid usage record. The status of the usage record is changed to Processed. The bills will be generated for the account based on the bill cycle defined for the account.</p>

Note:

You can change the transaction limit, whenever required, using the **On Demand Billing (C1-ODBFC)** feature configuration. For more information on the **Billable Charge Creation (C1-ODBCH)** batch, see *Oracle Revenue Management and Billing Batch Execution Guide*.

If you want to create billable charges for approved records where start date is a future date, then ensure that the **Use Calendar Billing** option is set to **Allow Advanced Billing** in the respective contract type.

If a batch job is created automatically, the number of approved records for which billable charges are created in each work unit depends on the value defined for the **Billable Charge Chunk Size** option type in the **On Demand Billing (C1-ODBFC)** feature configuration.

In case an account belongs to an invoicing group, the billable charge is created for the member account and the bill is generated for the master account.

On successful completion of the **Billable Charge Creation (C1-ODBCH)** batch, a To Do entry is created using the **C1-ODBCH To Do** type. You can view this To Do entry when you are assigned a To Do role which is mapped to the **C1-ODBCH To Do** type. This To Do indicates whether the batch was successfully executed or not. If the batch was successfully executed, it indicates the following:

- Number of records for which billable charges were created
- Number of records for which billable charges could not be created successfully

4. If a batch job is created automatically, click **OK** in the message box.

Related Topics

For more information on...	See...
How to search for a usage data file	Searching for a Usage Data File on page 1210
How to set the On Demand Billing (C1-ODBFC) feature configuration	Setting the C1-ODBFC Feature Configuration on page 4333

Rejecting a Valid Record

You can view the number of records which are pending for approval in the **Submitted** column corresponding to the usage data file in the **Usage Data Processing** screen. The approver can review, and accordingly approve or reject the usage record based on the observations.

Note: The system will not allow you to approve or reject a usage record submitted by you.

Procedure

To reject a valid record:

1. Do either of the following:

If you want to...	Then...
Reject the usage record from the Usage Data Processing screen	<ol style="list-style-type: none"> 1. Search for the usage data file in the Usage Data Processing screen. 2. In the Search Results section, click the Approve (☑) icon corresponding to the usage data file whose records you want to review.
Reject the usage record from the To Do List screen	<ol style="list-style-type: none"> 1. From the Main Menu, select To Do and then click To Do List. The To Do Type for User Search window appears. 2. Select the type of To Do entries you want to view. The To Do List screen appears. 3. Select Open from the Filter by list to view all unassigned To Dos. 4. Click the Submitted Message link corresponding to the To Do entry whose records you want to review.

The **Usage Data** screen appears.

2. Review the usage records which you want approve or reject.
3. Do either of the following:

If you want to...	Then...
Reject one or more usage records	<ol style="list-style-type: none"> 1. If the usage record is not appropriate, then select the check box corresponding to the usage record. 2. Click Reject.
Reject all usage records	<ol style="list-style-type: none"> 1. Click Reject All.

The **Rejection Reason** screen appears. It contains the following fields:

Field Name	Field Description	Mandatory (Yes or No)
Reason	Used to indicate the reason why you want to reject the usage record.	Yes
Comments	Used to specify additional information while rejecting the usage record.	Yes

4. Select the reason for rejecting the usage record and enter the comments in the respective field.

Note: The **ODB_REJ_RSN_FLG** lookup field values appear in the **Reason** list.

5. Click **OK**.

The status of the usage record is changed to **Rejected**. A To Do entry is created for the submitter to include correct or missing data.

Related Topics

For more information on...	See...
How to search for a usage data file	Searching for a Usage Data File on page 1210

Canceling a Usage Data File

There might be situations when incorrect usage data file is uploaded in the system. In such case, the system provides you with an ability to cancel the file. Once the usage data file is cancelled, the status of the file and all usage records in the file is changed to **Cancelled**. However, note that you can cancel a usage data file when there are no records (in other words, zero records) in the **Processed** and **Submitted** statuses.

Procedure

To cancel a usage data file:

1. Do either of the following:

If you want to...	Then...
Cancel the usage data file from the Usage Data Processing screen	<ol style="list-style-type: none"> 1. Search for the usage data file in the Usage Data Processing screen. 2. In the Search Results section, click the Cancel (🚫) icon corresponding to the usage data file that you want to cancel.
Cancel the usage data file from the On Demand Billing screen	<ol style="list-style-type: none"> 1. From the Main Menu, select Billing Management and then click On Demand Billing. The On Demand Billing screen appears. 2. Search for the file group whose usage data file you want to cancel. The search results appears. 3. Click the Broadcast (📡) icon corresponding to the required file group. The Group Files zone appears. The Group Files zone lists the usage data files that are uploaded using the file group. 4. Click the Cancel (🚫) icon corresponding to the usage data file that you want to cancel.

A message appears confirming whether you want to cancel the usage data file.

2. Click **OK**.

The **Cancel Reason** screen appears. It contains the following fields:

Field Name	Field Description	Mandatory (Yes or No)
Reason	Used to indicate the reason why you want to cancel the usage data file.	Yes
Comments	Used to specify additional information while cancelling the usage data file.	Yes

3. Select the reason for cancelling the usage data file and enter the comments in the respective field.

Note: The ODB_CAN_RSN_FLG lookup field values appear in the **Reason** list.

4. Click **OK**.

The status of the usage data file is changed to **Cancelled**.

Related Topics

For more information on...	See...
How to search for a file group	Searching for a File Group on page 1197
How to search for a usage data file	Searching for a Usage Data File on page 1210
Group Files zone	Group Files on page 1196

Revalidating a Usage Data File

There might be situations when you want to execute the validation process once again on the usage data file. For example, initially when the usage data file was uploaded, accounts didn't have an active contract and therefore the status of the usage records was set to **Invalid**. Later, a contract was created and activated for each account (whose usage records are available in the usage data file). In such case, you need to execute the validation process once again on the usage data file. However, note that when you revalidate a usage data file, only the records in the **Valid** and **Invalid** status are revalidated.

Procedure

To revalidate a usage data file:

1. Search for the usage data file in the **Usage Data Processing** screen.
2. Click the **Revalidate** () icon corresponding to the usage data file on which you want to execute the validation process once again.

The valid and invalid records are revalidated, and accordingly the status of records is changed. A message appears indicating that the validation process has completed successfully.

Note:

If the usage data file size exceeds the file size limit set in the **On Demand Billing (C1-ODBFC)** feature configuration, a batch job is created using the **Upload and Validate Usage Data File (C1-ODFU)** batch. A message appears indicating the batch job ID. This batch job revalidates the usage data file. For more information on the **Upload and Validate Usage Data File (C1-ODFU)** batch, see *Oracle Revenue Management and Billing Batch Execution Guide*.

If a batch job is created automatically, the number of usage records that are revalidated in each work unit depends on the value defined for the **Validation Chunk Size** option type in the **On Demand Billing (C1-ODBFC)** feature configuration.

On successful completion of the **Upload and Validate Usage Data File (C1-ODFU)** batch, a To Do entry is created using the **C1-ODFU To Do** type. You can view this To Do entry when you are assigned a To Do role which is mapped to the **C1-ODFU To Do** type. This To Do indicates whether the batch was successfully executed or not. If the batch was successfully executed, it indicates the following:

- Number of records which were successfully validated
- Number of records which could not pass through the validation process
- Number of records which failed to validate due to some technical reasons

3. Click **OK** in the message box.

Once a usage record is successfully validated, the status of the usage record is changed to **Valid**. And, if a usage record could not pass through the validation process, the status of the usage record is changed to **Invalid**.

Related Topics

For more information on...	See...
How to search for a usage data file	Searching for a Usage Data File on page 1210
How to set the On Demand Billing (C1-ODBFC) feature configuration	Setting the C1-ODBFC Feature Configuration on page 4333

Editing a Valid, Invalid, or Rejected Usage Record

If the usage record validation fails or the approver rejects the usage record due to some reason, the status of the record is changed to **Invalid** or **Rejected**, respectively. You need to then correct the existing data or add the missing data. The system allows you to edit the valid, invalid, and rejected usage records.

Procedure

To edit a valid, invalid or rejected usage record:

1. Search for the usage data file in the **Usage Data Processing** screen.
2. Depending on whether you want to edit a valid, invalid, or rejected record, click the link in the **Valid**, **Invalid**, or **Rejected** column corresponding to the usage data file whose records you want to edit.

The **Usage Data** screen appears. The columns in the **Search Results** section are editable.

Note:

In case of rejected records, all columns except the **Reason** and **Comments** columns are editable.

In case of invalid record, the field with incorrect or missing data is highlighted with the red color. This helps to easily identify the reason why the validation process failed.

3. Enter the correct or missing data in the respective field.
4. Click **Save**.

All valid, invalid, or rejected usage records are validated once again. Once the validation process has completed successfully, the status of the records is changed accordingly.

Related Topics

For more information on...	See...
How to search for a usage data file	Searching for a Usage Data File on page 1210

Exporting Usage Data into CSV file

Oracle Revenue Management and Billing provides you the facility to export the usage data into a CSV file. However, you can download the usage data in a CSV file only if the billable charges are not yet created. In other words, you can download the usage data only when all the records of a usage data file are in the valid and/or invalid status. Once the usage data is downloaded, you can edit the usage records and reupload the usage data file.

Note: When you download the usage data file using the **Export To Excel** option, the downloaded file is saved on your system with a unique ID. Once you make the required changes in the downloaded usage data file, you need to save the modified file with the same name as it exists in Oracle Revenue Management and Billing, and then upload the file into the system to replace the existing file.

Procedure

To export usage data into CSV file:

1. Search for the usage data file in the **Usage Data Processing** screen.
2. In the **Search Results** section, click the link in the **Total** column corresponding to the usage data file whose usage records you want to export.
The **Usage Data** screen appears.
3. Click the **Export TO Excel** link in the **Search** section to download details of all the valid and/or invalid records of a usage data file in a CSV file format.
A message appears indicating that all valid and invalid records will be exported.
4. Click **OK**.

The system prompts you to save the file.

Related Topics

For more information on...	See...
How to search for a usage data file	Searching for a Usage Data File on page 1210

Filtering Usage Records

Procedure

To filter records of a usage data file:

1. Search for the usage data file in the **Usage Data Processing** screen.

- Depending on whether you want to filter total, valid, invalid, submitted, processed, rejected, cancelled, billed, or unbilled usage records, click the link in the respective column corresponding to the usage data file.

The **Usage Data** screen appears.

- Enter the search criteria based on which you want to filter the records.

Note: ORMB search engine supports wildcard search, where you can substitute the percentage (%) symbol as a stand in for any word or letter in a search criteria. You can use the ‘%’ wildcard character in all input fields except the date and ID fields. The ‘%’ wildcard character is suffixed automatically at the end of the partial search criteria. Therefore, you may or may not specify the wildcard character at the end of the partial search criteria. However, you have to prefix the wildcard character manually wherever required.

- Click **Search**.

The search results are filtered based on the specified criteria.

Related Topics

For more information on...	See...
How to view all records of a usage data file	Viewing All Records of a Usage Data File on page 1217
How to view valid records of a usage data file	Viewing Valid Records of a Usage Data File on page 1221
How to view invalid records of a usage data file	Viewing Invalid Records of a Usage Data File on page 1224
How to view submitted records of a usage data file	Viewing Submitted Records of a Usage Data File on page 1227
How to view processed records of a usage data file	Viewing Processed Records of a Usage Data File on page 1231
How to view rejected records of a usage data file	Viewing Rejected Records of a Usage Data File on page 1238
How to view cancelled records of a usage data file	Viewing Cancelled Records of a Usage Data File on page 1234
How to view billed records of a usage data file	Viewing Billed Records of a Usage Data File on page 1241
How to view unbilled records of a usage data file	Viewing Unbilled Records of a Usage Data File on page 1245

Chapter 13

Upload Validated Payment Data

Topics:

- [Payment Upload Process](#)
- [Prerequisites](#)
- [CSV File Format](#)
- [Sample CSV](#)
- [Payment Data File Status Transition](#)
- [Payment Record Status Transition](#)
- [Error Messages](#)
- [Payment Upload](#)

Oracle Revenue Management and Billing until now provided you with an ability to interface payments from an external source, such as remittance processor. The system supported two mechanisms to upload payment data - one using which you can populate payment upload staging records and another using which you can populate payment event upload staging records. The system now enables you to validate the payment records before you move them to the staging area. The system provides the pre-staging area where you can upload and validate the payment records. The system provides a user interface which helps you to upload a payment data file in the pre-staging area. It also helps you to perform various tasks, such as:

- Track the status of the payment records and the payment data file
- Move the payment records to the staging area
- Cancel a payment data file
- View the log of a payment data file
- Apply payments on the unpaid bills of an account or a statement

You can upload a payment data file in the CSV format. You need to ensure that the CSV file is in the required format; otherwise the file will not be uploaded in the system. For more information about the CSV file format, see [CSV File Format](#) on page 1263. At present, the system supports only the CSV file format. This is because the payment data mapping algorithm type shipped with the product is designed to support the CSV format. If you want to use any other file format, you need to define custom mapping algorithm type that supports the required file format.

The file type using which you upload a payment data file indicates the mapping and validation algorithms that you want to use for the payment data file. On uploading a payment data file, the mapping algorithm parses the CSV file and uploads the payments records in the pre-staging area. The validation process starts immediately after the file is uploaded in the system. During the validation process, the system and custom validations (if any) are executed. Once the validation process is complete, you can move the payment records from the pre-staging to staging area. Once the payment records are moved to the staging area, the system creates payment events, tenders, payments and payment segments through a batch process. For more information about the payment upload process, see [Payment Upload Process](#) on page 1260.

During the payment upload process, a payment data file and each record of the file goes through various statuses until the payment events and payments are created. For more information about the payment data file and payment record statuses, see [Payment Data File Status Transition](#) on page 1265 and [Payment Record Status Transition](#) on page 1266, respectively.

Payment Upload Process

The payment upload process includes the following sub-processes:

- [Upload Payment Records in the Pre-Staging Area](#) on page 1260
- [Move Payment Records to the Staging Area](#) on page 1261
- [Create Payment Events and Payments](#) on page 1261

Upload Payment Records in the Pre-Staging Area

Oracle Revenue Management and Billing allows you to validate the payment records before you move them to the staging area. You can upload and validate the payment records in the pre-staging area. You can upload a payment data file in the CSV format. You need to ensure that the CSV file is in the required format; otherwise the file will not be uploaded in the system. For more information about the CSV file format, see [CSV File Format](#) on page 1263.

While uploading a payment data file, you need to specify the file type using which you want to upload the payment data file. The file type indicates the mapping and validation algorithms that you want to use for the payment data file. Therefore, while defining a file type using which you want to upload a payment data file, you need to:

- Set the feed type to **Payment Upload Data**
- Attach mapping algorithm which is created using the **C1-CSVUPLPAY** algorithm type
- Attach validation algorithm which is created using the **C1-PUPLVALID** algorithm type

On uploading a payment data file, the mapping algorithm does the following:

1. Validates whether the file is in the CSV format
2. Validates whether at least one payment record is available in the CSV file
3. Parses the flat file in the CSV format and maps the columns in the CSV file to various tables in the database
4. Uploads the payments records in the pre-staging area

The validation process starts immediately after the payment data file is uploaded in the system. During the validation process, the system and custom validations (if any) are executed. The system checks whether:

- The data is available in the **Tender ID, Tender Amount, Payment Amount, Date Received, Bank Account, and Payment Type** columns in the CSV file.
- The data is available in the **Match Type** and **Match Value** columns in the CSV file.

Note: This validation is done when the **Is Match Type Validation Required (Y/N)** parameter is set to **Y** in the validation algorithm.

- The payee and payor accounts specified in the payment record exists in the system.
- The payee account with the specified account identifier type and account identifier combination exists in the system.
- A valid currency code is specified in the payment record.

Note: If the currency code is not specified, the currency is set to the payor account's invoice currency.

- The payment type (i.e. tender type) specified in the payment record exists in the system.
- The account identifier type specified in the payment record exists in the system.

Note: This validation is done when the payee account ID is not specified in the payment record.

- The match type specified in the payment record exists in the system.

Note: This validation is done when the **Is Match Type Validation Required (Y/N)** parameter is set to **Y** in the validation algorithm.

- The characteristic type specified in the payment record exists in the system.
- The characteristic value matches any predefined value when the characteristic value type is set to **Predefined Value**.
- The characteristic value is specified in the payment record when the characteristic type is specified and vice-versa.

You can upload a file by clicking the **Upload** link in the **Payment Upload** screen. On uploading a payment data file, the payment records are copied to the pre-staging area and the status of the payment data file is set to **Pending**. The validation process starts immediately after the payment data file is uploaded in the system. If a payment record is successfully validated, the status of the payment record is set to **Valid**. If a payment record contains incorrect or missing data, the status of the payment record is set to either **Invalid** or **Error** depending on the scenario. For more information about the scenarios when a payment record is set to the **Invalid** or **Error** status, see [Payment Record Status Transition](#) on page 1266.



Once the validation process is completed, the status of the payment data file is changed to **Validated**. Once the payment records are uploaded and validated in the pre-staging area, you can do either of the following:

- Move the payment records to the staging area
- Cancel a payment data file
- Replace the existing payment data file

Note: If a payment data file contains an invalid record, you need to correct or add missing data in the CSV file and then upload the file once again. Unless, a payment data file has no invalid records, you cannot move any record of the payment data file to the staging area.

Move Payment Records to the Staging Area

Once the payment records are uploaded and validated in the pre-staging area, you can move the records to the staging area. The system allows you to move only valid and error records of a payment data file to the staging area. If a payment data file contains an invalid record, you cannot move any record of the payment data file to the staging area. In such scenario, you need to correct the invalid payment records and upload the same file once again in the system. In addition, if you have cancelled a payment data file, you cannot move any records (including valid and error records) of the payment data file to the staging area.

You can move the payment records to the staging area by clicking the **Move to Staging**  icon corresponding to the payment data file in the **Payment Upload** screen. The **Move to Staging**  icon appears when:

- The status of the payment data file is **Validated**.
- There are no invalid records in the payment data file.
- The **Disable Move to Staging** check box is not selected in the respective file type.

On clicking the **Move to Staging**  icon, the payment records are copied (and not moved) from the pre-staging to staging area and the status of the payment data file is changed to **In Staging**. In addition, the status of the payment records in the pre-staging area is changed to **In Staging** and the status of the deposit control, tender control, and payment tender staging records is set to **Pending**. Once you move the payment records to the staging area, you can edit the payment staging records, if required.

Create Payment Events and Payments

Once the payment records are moved to the staging area, the system creates payment events for the payment data file in the background when the **Payment Upload (PUPL)** batch is invoked. You can configure the **Payment Upload (PUPL)** batch such that it is executed at regular intervals. When the **Payment Upload (PUPL)** batch is invoked, the

system checks whether there are any deposit control, tender control, payment tender, and payment staging records in the **Pending** status. If there are staging records in the **Pending** status, the system creates the following entities:

- Deposit Control
- Tender Control
- Payment Events
- Payment Tenders
- Payments
- Payment Segments
- Financial Transactions (when the payments are frozen)

The status of the deposit control, tender control, payment tender, and payment staging records is changed to **Complete**. If any error occurs while creating payment event for a payment record, the status of the deposit control, tender control, payment tender, and payment staging records is changed to **Error**. In addition, the status of the payment record in the pre-staging area is changed to **Error in Staging**.

Traditionally, the **Payment Upload (PUPL)** batch considered staging records which are in the **Error** or **Pending** status. If a staging record is in the **Error** status, the system used to reset the status to **Pending** and then further processed the staging record. This system behavior still exists for staging records which are not uploaded through the **Payment Upload** process. If the staging records are uploaded through the **Payment Upload** process, you need to manually correct the staging records and change the status of deposit control, tender control, payment tender, and payment staging records to **Pending**. The corrected staging records will then be processed when the **Payment Upload (PUPL)** batch is invoked at subsequent interval.

Prerequisites

To setup the payment upload process, you need to do the following:

- Define the required match types with the appropriate payment distribution override and manual distribution algorithms.
- Define the required tender types in the system.
- Define the required currency codes in the system.
- Define the required tender sources in the system.
- Define the required characteristic types where the characteristic entity is set to **Payment**.
- Create a mapping algorithm using the **C1-CSVUPLPAY** algorithm type.
- Create a validation algorithm using the **C1-PUPLVALID** algorithm type.
- Define the required file types where the feed type is set to **Payment Upload Data**.
- Assign the **PUPL To Do** type to a To Do role whose users must receive the To Do generated while executing the **Payment Upload (PUPL)** batch.
- Set the batch control type of the **Payment Upload (PUPL)** batch to **Timed** and define the following attributes:
 - Time Interval
 - Timer Active
 - User ID
 - Batch Language
 - Email Address

Note: If you want to use the **Payment Upload** feature in an ORMB Cloud Service Premium Edition environment, you need to set the **Payment Upload Extendable Lookup and Bucket** option type of the **C1-CFS** feature configuration.

Related Topics

For more information on...	See...
How to set the C1-CFS feature configuration	Setting the C1-CFS Feature Configuration on page 4349

CSV File Format

Before uploading a payment data file, you need to ensure that the CSV file contains the following columns:

Column Name	Column Description	Mandatory (Yes or No)
Account ID	Used to specify the payee account ID.	Yes
Match Type	Used to specify the match type using which you want to match the payment.	Yes (Conditional) Note: This data is required when the match value is specified.
Match Value	Used to specify the entity (such as bill, contract, and so on) against which you want to match the payment. Note: If you specify a match type where the entity type is set to Account , the match value should not be provided. The payee account ID is derived from the payment data record. If the payee account ID is not available in the payment data record, it is derived using the payee account identifier type and identifier value. The system then derives the unpaid bills of the payee account using the manual distribution algorithm attached to the respective match type. If you specify a match type where the entity type is set to Statement , the match value should not be provided. The statement ID is derived from the payment data record. The system then derives the unpaid bills of the statement using the manual distribution algorithm attached to the respective match type.	Yes (Conditional) Note: This data is required when the match type is specified.
Tender ID	Used to specify the payment tender ID. Note: If the tender ID is same for two or more payment records, the system will create multiple payments against one tender. In other words, there will be multiple payments which are created through the payment event.	Yes
Tender Amount	Used to specify the tender amount.	Yes

Column Name	Column Description	Mandatory (Yes or No)
	<p>Note:</p> <p>You must not specify the value less than or equal to 0.</p> <p>The precision specified for the tender amount must not exceed the decimal places defined for the currency in the system.</p>	
Payment Amount	<p>Used to specify the amount paid through the tender.</p> <p>Note:</p> <p>You must not specify the value less than or equal to 0.</p> <p>The precision specified for the payment amount must not exceed the decimal places defined for the currency in the system.</p>	Yes
Date Received	<p>Used to specify the date when the payment is made.</p> <p>Note: You must specify the date in the MM/DD/YYYY format.</p>	Yes
Bank Account	Used to specify the external source ID which is associated with the tender source.	Yes
Payment Type	Used to specify the type of tender through which the payment is made.	Yes
Check Number	Used to specify the check number if the payment is made through check.	No
Currency	<p>Used to specify the currency in which the payment is made.</p> <p>Note: If the currency is not specified, it is set to the payor account's invoice currency.</p>	No
External Reference Id	Used to specify the external reference ID which is associated with the tender source.	No
Account ID Type	Used to specify the account identifier type.	Yes (Conditional)
		<p>Note: This data is required when the account identifier is specified.</p>
Account Identifier	Used to specify the account for which the payment is made.	Yes (Conditional)
		<p>Note: This data is required when the account identifier type is specified.</p>
Payment Char Type1, Payment Char	Used to indicate the characteristic that must be defined for the payment.	Yes (Conditional)

Column Name	Column Description	Mandatory (Yes or No)
Type2,, Payment Char Type5		Note: This data is required when the characteristic value is specified.
Payment Char Value1, Payment Char Value2,, Payment Char Value5	Used to specify the value for the characteristic type.	Yes (Conditional) Note: This data is required when the characteristic type is specified.
MICR ID	Used to specify the MICR code.	No
Payor ID	Used to specify the payor account ID. Note: If the payor account ID is not specified, the payor account ID is set to the payee account ID assuming that the payor and payee are the same.	No
Statement ID	Used to specify the statement ID for applying payments at the statement level.	Yes (Conditional) Note: This data is required when the Statement ID is specified.

Note:

If a payment data file contains column names other than those mentioned in the above table, the system will not upload the payment data file.

The system considers the payment data file for upload only when the payment data file is parsed without any errors and contains less than 1000 payment records.

Sample CSV

```
1640731871,STMTPAY,344749531005,0100232,500.85,500.85,08/1/2022,TEST_EXT_SRC,CASH,00100,U
```

Payment Data File Status Transition

The following figure graphically indicates how a payment data file moves from one status to another during the payment upload process:

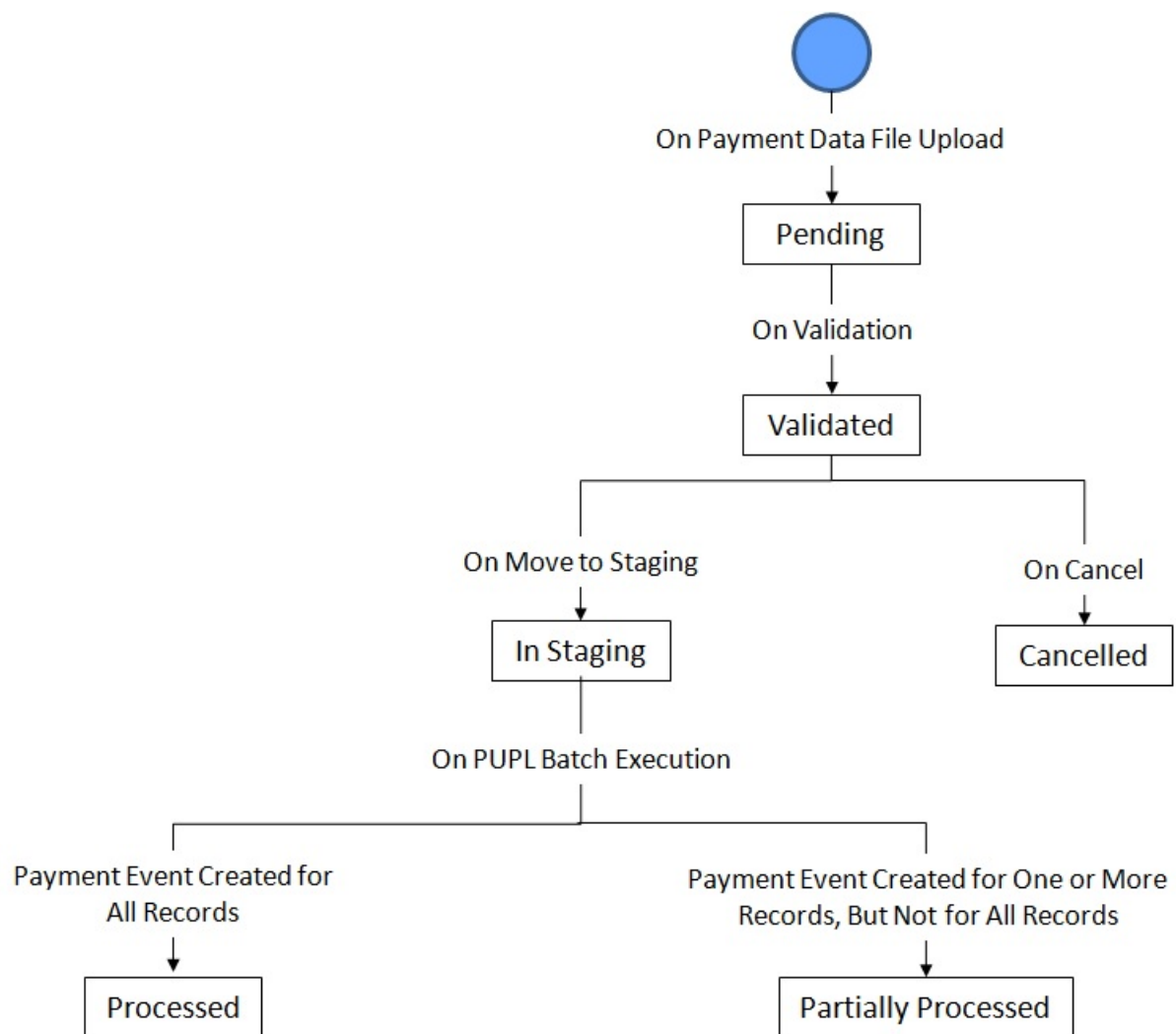

Payment Record Status Transition

The following figure graphically indicates how a payment record moves from one status to another during the payment upload process:

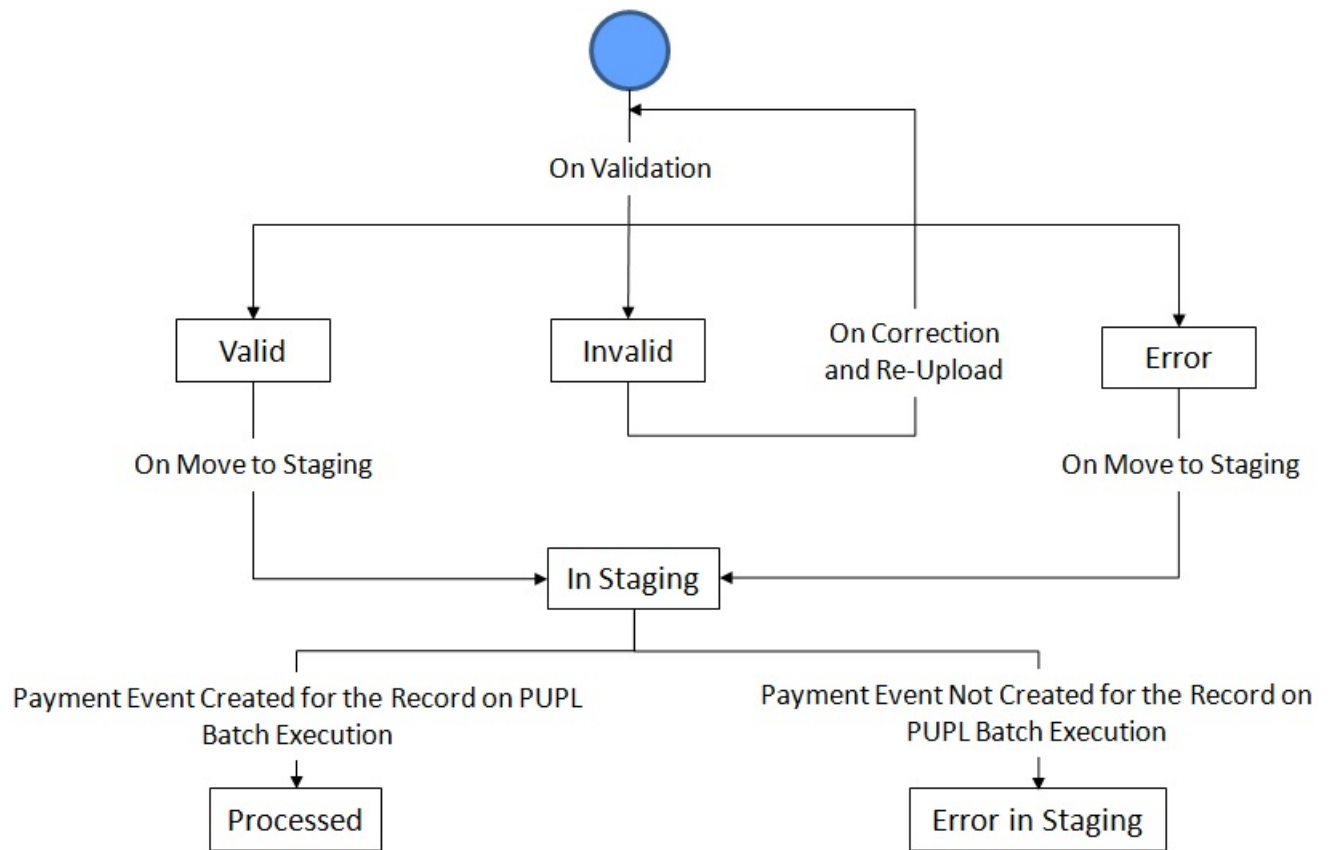

The following table lists the scenarios when a payment record is set to **Invalid** or **Error** status:

Scenario	Payment Record Status
The system could not find the payee account ID for a given account identifier type and account identifier combination when the payee account ID is not specified in the payment record.	Invalid
The payee account ID specified in the payment record does not exist in the system.	Invalid
The payee account ID, account identifier type, or account identifier are not specified in the payment record.	Invalid
The match type is not specified in the payment record.	Invalid
The match type specified in the payment record does not exist in the system.	Error
The match value is not specified in the payment record.	Invalid
The currency code does not exist in the system.	Invalid
The tender amount is either zero or not specified in the payment record.	Invalid
The payment amount is either zero or not specified in the payment record.	Invalid
The bank account is not specified in the payment record.	Invalid
The payment type (i.e. tender type) does not exist in the system.	Invalid

Scenario	Payment Record Status
The payment type is not specified in the payment record.	Invalid
The tender ID is not specified in the payment record.	Invalid
The date received is not specified in the payment record.	Invalid
The payor account ID specified in the payment record does not exist in the system.	Invalid
The characteristic type specified in the payment record does not exist in the system.	Invalid
If a characteristic type is specified, but the characteristic value is not specified in the payment record.	Invalid
If a characteristic value is specified, but the characteristic type is not specified in the payment record.	Invalid
The characteristic value does not match any predefined value when the characteristic value type is set to Predefined Value .	Invalid

Note: The system does the match type and match value related validations when the **Is Match Type Validation Required (Y/N)** parameter is set to **Y** in the validation algorithm.

Error Messages

The following table lists the errors that may occur during the payment upload process. It also indicates how you can resolve these errors.

Message Number	Error Message	Message Category	Possible Issues
80110	File cannot be reuploaded as some records have already been processed.	11111	The possible issues could be: <ul style="list-style-type: none"> You are trying to replace an existing file whose payment records are already moved to the staging area and/or for which payment events are already created.
1463	This file already exists in the system. Please check.	17000	The possible issues could be: <ul style="list-style-type: none"> You are trying to upload a file which is already uploaded in the system without selecting the Replace Existing File check box.
1465	Please upload a file in the CSV format.	17000	The possible issues could be: <ul style="list-style-type: none"> You are trying to upload a file which is not in the CSV format.
80113	Duplicate Header for column %1 in file.	11111	The possible issues could be: <ul style="list-style-type: none"> The file has two or more columns with the same header.

Message Number	Error Message	Message Category	Possible Issues																																				
80111	Length of value %1 too long for Field %2. Maximum length: %3 Found %4.	11111	<p>The possible issues could be:</p> <ul style="list-style-type: none"> The length of value specified in the column exceeds the maximum field length. The following table lists the maximum length of each field: <table border="1" data-bbox="1019 436 1463 1566"> <thead> <tr> <th data-bbox="1019 436 1317 520">Column Name</th> <th data-bbox="1317 436 1463 520">Maximum Length</th> </tr> </thead> <tbody> <tr> <td data-bbox="1019 520 1317 569">Account ID</td> <td data-bbox="1317 520 1463 569">10</td> </tr> <tr> <td data-bbox="1019 569 1317 617">Match Type</td> <td data-bbox="1317 569 1463 617">8</td> </tr> <tr> <td data-bbox="1019 617 1317 665">Match Value</td> <td data-bbox="1317 617 1463 665">30</td> </tr> <tr> <td data-bbox="1019 665 1317 714">Tender ID</td> <td data-bbox="1317 665 1463 714">12</td> </tr> <tr> <td data-bbox="1019 714 1317 762">Tender Amount</td> <td data-bbox="1317 714 1463 762">15</td> </tr> <tr> <td data-bbox="1019 762 1317 810">Payment Amount</td> <td data-bbox="1317 762 1463 810">15</td> </tr> <tr> <td data-bbox="1019 810 1317 858">Date Received</td> <td data-bbox="1317 810 1463 858">10</td> </tr> <tr> <td data-bbox="1019 858 1317 907">Bank Account</td> <td data-bbox="1317 858 1463 907">30</td> </tr> <tr> <td data-bbox="1019 907 1317 955">Payment Type</td> <td data-bbox="1317 907 1463 955">4</td> </tr> <tr> <td data-bbox="1019 955 1317 1003">Check Number</td> <td data-bbox="1317 955 1463 1003">10</td> </tr> <tr> <td data-bbox="1019 1003 1317 1052">Currency</td> <td data-bbox="1317 1003 1463 1052">3</td> </tr> <tr> <td data-bbox="1019 1052 1317 1100">Account ID Type</td> <td data-bbox="1317 1052 1463 1100">8</td> </tr> <tr> <td data-bbox="1019 1100 1317 1148">Account Identifier</td> <td data-bbox="1317 1100 1463 1148">30</td> </tr> <tr> <td data-bbox="1019 1148 1317 1318">Payment Char Type1, Payment Char Type2,, Payment Char Type5</td> <td data-bbox="1317 1148 1463 1318">8</td> </tr> <tr> <td data-bbox="1019 1318 1317 1465">Payment Char Value1, Payment Char Value2,, Payment Char Value5</td> <td data-bbox="1317 1318 1463 1465">254</td> </tr> <tr> <td data-bbox="1019 1465 1317 1514">MICR ID</td> <td data-bbox="1317 1465 1463 1514">30</td> </tr> <tr> <td data-bbox="1019 1514 1317 1562">Payor ID</td> <td data-bbox="1317 1514 1463 1562">10</td> </tr> </tbody> </table>	Column Name	Maximum Length	Account ID	10	Match Type	8	Match Value	30	Tender ID	12	Tender Amount	15	Payment Amount	15	Date Received	10	Bank Account	30	Payment Type	4	Check Number	10	Currency	3	Account ID Type	8	Account Identifier	30	Payment Char Type1, Payment Char Type2,, Payment Char Type5	8	Payment Char Value1, Payment Char Value2,, Payment Char Value5	254	MICR ID	30	Payor ID	10
Column Name	Maximum Length																																						
Account ID	10																																						
Match Type	8																																						
Match Value	30																																						
Tender ID	12																																						
Tender Amount	15																																						
Payment Amount	15																																						
Date Received	10																																						
Bank Account	30																																						
Payment Type	4																																						
Check Number	10																																						
Currency	3																																						
Account ID Type	8																																						
Account Identifier	30																																						
Payment Char Type1, Payment Char Type2,, Payment Char Type5	8																																						
Payment Char Value1, Payment Char Value2,, Payment Char Value5	254																																						
MICR ID	30																																						
Payor ID	10																																						
80085	Invalid value for column: %1.	11111	<p>The possible issues could be:</p> <ul style="list-style-type: none"> The payee account ID specified in the payment record does not exist in the system. The match type specified in the payment record does not exist in the system. The currency code does not exist in the system. 																																				

Message Number	Error Message	Message Category	Possible Issues
			<ul style="list-style-type: none"> The account identifier type specified in the payment record does not exist in the system. The tender amount is either zero or not specified in the payment record. The payment amount is either zero or not specified in the payment record. The bank account is not specified in the payment record. The payment type (i.e. tender type) does not exist in the system. The tender ID is not specified in the payment record. The date received is not specified in the payment record. The characteristic type specified in the payment record does not exist in the system. The payor account ID specified in the payment record does not exist in the system.
80100	Invalid Account Identifier and Account Identifier Type code combination.	11111	<p>The possible issues could be:</p> <ul style="list-style-type: none"> The system could not find the payee account ID for a given account identifier type and account identifier combination when the payee account ID is not specified in the payment record.
80086	%1 has more decimal positions than currency code %2 supports (%3).	11111	<p>The possible issues could be:</p> <ul style="list-style-type: none"> The precision specified for the tender amount exceeds the decimal places defined for the currency in the system. The precision specified for the payment amount exceeds the decimal places defined for the currency in the system.
13601	Tender Source does not exist for External Source ID (%1)	11	<p>The possible issues could be:</p> <ul style="list-style-type: none"> The tender source does not exist for the external source ID in the system.
13603	Deposit control (%1/%2) Deposit Amount is not equal to sum of Tender Amounts	11	<p>The possible issues could be:</p> <ul style="list-style-type: none"> The sum of tender control staging amount does not match the deposit control staging amount.

Message Number	Error Message	Message Category	Possible Issues
13604	Deposit Control (%1/%2) Tender count does not equal the number of Tender controls	11	The possible issues could be: <ul style="list-style-type: none"> The number of tender control staging records does not match the total tender controls specified in the deposit control staging record.
13605	Tender control (%1/%2/%3) Total Tender Amount not equal to sum of Tender Amounts	11	The possible issues could be: <ul style="list-style-type: none"> The sum of payment tender staging amount does not match the total tender amount specified in tender control staging record.
13606	Tender control (%1/%2/%3) tender count does not equal the number of Tenders	11	The possible issues could be: <ul style="list-style-type: none"> The number of payment tender staging records does not match the total number of tenders specified in the tender control staging record.
13607	Suspense Contract does not exist for External Source ID (%1)	11	The possible issues could be: <ul style="list-style-type: none"> The suspense contract is not defined for the tender source.
13608	Many Tender Sources found for External Source ID (%1)	11	The possible issues could be: <ul style="list-style-type: none"> There are multiple tender sources in the system with the same external source ID.
13701	Pay Tender (%1/%2/%3/%4) Amount not equal to sum of Pay Amounts	11	The possible issues could be: <ul style="list-style-type: none"> The sum of payment staging amount does not match the total amount specified in payment tender staging record.
13705	Payment (%1/%2/%3/%4) Person ID (%5) exists on multiple accounts.	11	The possible issues could be: <ul style="list-style-type: none"> There are multiple payment records having contracts with the same old account ID but their payee account ID is different.
80194	File has no records to upload	11111	The possible issues could be: <ul style="list-style-type: none"> You are trying to upload a file without any payment records.
80195	Incorrect header: %1	11111	The possible issues could be: <ul style="list-style-type: none"> One or more column names in the payment data file are incorrect.
80196	Maximum file name size allowed is 60 characters	11111	The possible issues could be: <ul style="list-style-type: none"> The file name contains more than 60 characters.
80199	Missing value for column %1	11111	The possible issues could be:

Message Number	Error Message	Message Category	Possible Issues
			<ul style="list-style-type: none"> The match type is not specified in the payment record. The match value is not specified in the payment record. The payment type is not specified in the payment record.

Payment Upload

The **Payment Upload** screen allows you to search for a payment data file using various search criteria. Through this screen, you can:

- Upload a payment data file
- Cancel a payment data file
- View the records uploaded through a payment data file
- View the staging records of a payment data record
- View the log of a payment data file
- Move the payment records to the staging area
- Edit a payment staging record
- Replace an existing payment data file
- View the reasons why the payment record is in the **Error** or **Invalid** status

This screen consists of the following zones:

- [Search Payment Data File](#) on page 1272
- [Payment Data Records](#) on page 1275
- [Payment Staging Records](#) on page 1276
- [Payment Data File Log](#) on page 1277

Search Payment Data File

The **Search Payment Data File** zone allows you to search for a payment data file which is uploaded and/or processed in the system. This zone contains the following two sections:

- **Search Criteria** - The **Search Criteria** section contains the following fields:

Field Name	Field Description	Mandatory (Yes or No)
File Name	Used to search a particular payment data file.	No
User ID	Used to search payment data files which are uploaded by a particular user.	No
File Type	Used to search payment data files which are uploaded using a particular file type.	No
Upload From Date	Used to search payment data files which are uploaded from a particular date onwards.	No

Field Name	Field Description	Mandatory (Yes or No)
	Note: By default, the date is set to the current date minus 7 days. You can change the date, if required.	
File Status	Used to search payment data files with a particular status. The valid values are: <ul style="list-style-type: none"> Cancelled In Staging Partially Processed Pending Processed Validated 	No
Upload To Date	Used to search payment data files which are uploaded till a particular date. <p>Note: By default, the date is set to the current date. You can change the date, if required.</p>	No

Note: You must specify at least one search criterion while searching for a payment data file.

- **Search Results** - On clicking the **Search** button, the search results appear based on the specified search criteria. The **Search Results** section contains the following columns:

Column Name	Column Description
File Name	Displays the name of the payment data file.
File Type	Indicates the type of the payment data file.
Upload Date	Displays the date and time when the payment data file was uploaded in the system.
Status	Indicates the status of the payment data file. The valid values are: <ul style="list-style-type: none"> Cancelled In Staging Partially Processed Pending Processed Validated
Total	Displays the total number of records that are uploaded through the payment data file.
Valid	Displays the number of records which are successfully validated in the system.
Invalid	Displays the number of records which could not pass through the validation process in the system.
Error	Displays the number of records where the data is incorrect.

Column Name	Column Description
In Staging	Displays the number of records which are copied from the pre-staging to staging area.
Processed	Displays the number of records for which payment events are created.
Staging Error	Displays the number of records for which payment events could not be created.
Cancel	<p>On clicking the Cancel (🚫) icon, you can cancel the payment data file.</p> <p>Note: The Cancel icon appears when the status of the payment data file is Validated. In other words, you cannot cancel a payment data file when its records are moved to the staging area or when the payment events are created for the payment data file.</p>
Move to Staging	<p>On clicking the Move to Staging (📁) icon, you can move the valid and error records of the payment data file to the staging area.</p> <p>Note:</p> <p>The Move to Staging icon appears when:</p> <ul style="list-style-type: none"> • The status of the payment data file is Validated. • There are no invalid records in the payment data file. • The Disable Move to Staging check box is not selected in the respective file type.

Note:

Pagination is used to display limited number of records in the **Search Results** section. You can use the navigation links, such as **Previous** and **Next** to navigate between pages.

You can view the **Filter** area by clicking the **Filters** (🔍) icon in the upper right corner of this zone.

You can upload a payment data file by clicking the **Upload** button in the **Page Title** area of the **Payment Upload** screen. On clicking the **Broadcast** (📡) icon corresponding to the payment data file, the **Payment Data Records** and **Payment Data File Log** zones appear.

Related Topics

For more information on...	See...
Payment Upload screen	Payment Upload on page 1272
How to upload a payment data file	Uploading a Payment Data File on page 1278
How to search for a payment data file	Searching for a Payment Data File on page 1277
How to cancel a payment data file	Cancelling a Payment Data File on page 1281
How to replace an existing payment data file	Replacing an Existing File on page 1279

For more information on...	See...
How to move the payment records to the staging area	Moving the Payment Records to the Staging Area on page 1281
How to edit a payment staging record	Editing a Payment Staging Record on page 1282
How to view the records of a payment data file	Viewing the Records of a Payment Data File on page 1283
How to view the log of a payment data file	Viewing the Log of a Payment Data File on page 1284

Payment Data Records

The **Payment Data Records** zone lists the records of the payment data file. This zone contains the following columns:

Column Name	Column Description
Payor Account ID	Indicates the account through which the payment is made.
Payee Account ID	Indicates the account for which the payment is made.
Statement ID	Indicates the statement for which the payment is made.
Match Type	Indicates the match type using which the payment must be matched.
Match Value	Indicates the entity (such as bill, contract, and so on) against which the payment must be matched.
Entity Type	Indicates the entity type.
Pay Tender ID	Displays the payment tender ID.
Tender Amount	Displays the tender amount.
Payment Amount	Displays the amount paid through the tender.
Currency	Indicates the currency in which the payment is made.
Date Received	Displays the date when the payment is made.
Bank Account	Displays the bank account from which the payment is made.
Tender Type	Indicates the type of tender through which the payment is made.
Check Number	Displays the check number if the payment is made through check.
MICR ID	Displays the MICR code.
Status	Indicates the status of the payment record. The valid values are: <ul style="list-style-type: none"> • Valid • Invalid • Error • In Staging • Processed • Error in Staging
Payment Event Information	Displays information about the payment event which is created for the payment record.

Column Name	Column Description
	<p>Note:</p> <p>It has a link. On clicking the link, the Payment Event screen appears with the details of the respective payment event.</p> <p>The data appears in this column when the status of the payment record is Processed.</p>
Messages	<p>On clicking the View () icon, the Error Messages window appears where you can view the reasons why the status of the payment record is Invalid or Error.</p> <p>Note: The View icon appears when the payment data record is in the Error or Invalid status.</p>

Note:

Pagination is used to display limited number of records in the **Payment Data Records** zone. By default, 20 records are displayed in this zone. You can use the navigation links, such as **Previous** and **Next** to navigate between pages.

You can filter the list using various search criteria (such as, **Status** and **Check Number**) available in the **Filter** area. By default, the **Filter** area is hidden. You can view the **Filter** area by clicking the **Filters** () icon in the upper right corner of this zone.

By default, the **Payment Data Records** zone does not appear in the **Payment Upload** screen. It appears when you click the **Broadcast** () icon corresponding to the payment data file in the **Search Payment Data File** zone.

Related Topics

For more information on...	See...
How to view the records of a payment data file	Viewing the Records of a Payment Data File on page 1283
How to viewing the staging records of a payment data record	Viewing the Staging Records of a Payment Data Record on page 1283
How to view the error messages of a payment data file	Viewing the Errors of a Payment Data Record on page 1284

Payment Staging Records

The **Payment Staging Records** zone lists the staging records of the payment data file. This zone contains the following columns:

Column Name	Column Description
View	On clicking the View () icon, you can view the payment upload staging details.
External Source ID	Displays the external source ID which is associated with the tender source.
External Reference ID	Displays the external reference ID which is associated with the tender source.
External Transmission ID	Displays the external transmission ID which is associated with the tender source.
External Batch ID	Displays the batch of payments in a transmission.
Payee Account ID	Indicates the account for which the payment is made.

Column Name	Column Description
Match Type	Indicates the match type using which the payment is matched.
Match Value	Indicates the entity (such as bill, contract, and so on) against which the payment is matched.
Payment Amount	Displays the amount paid through the tender source.

By default, the **Payment Staging Records** zone does not appear in the **Payment Upload** screen. It appears when you click the **Broadcast** () icon corresponding to the payment data record in the **Payment Data Records** zone.

Related Topics

For more information on...	See...
How to view the staging records of a payment data record	Viewing the Staging Records of a Payment Data Record on page 1283

Payment Data File Log

The **Payment Data File Log** zone lists the complete trail of actions performed on the payment data file. This zone contains the following columns:

Column Name	Column Description
Creation Date Time	Displays the date and time when the action is performed on the payment data file.
Log Details	Displays the details of the action performed on the payment data file.
User	Indicates the user who performed the action on the payment data file.

By default, the **Payment Data File Log** zone does not appear in the **Payment Upload** screen. It appears when you click the **Broadcast** () icon corresponding to the payment data file in the **Search Payment Data File** zone.

Related Topics

For more information on...	See...
How to view the log of a payment data file	Viewing the Log of a Payment Data File on page 1284

Searching for a Payment Data File

Prerequisites

To search for a payment data file, you should have:

- File types defined in the application (where the feed type is set to Payment Upload Data)

Procedure

To search for a payment data file:

1. Click the **Menu** link in the **Application** toolbar.
A list appears.
2. From the **Main** menu, select **Payments** and then click **Payment Upload**.
The **Payment Upload** screen appears.
3. Enter the search criteria in the **Search Payment Data File** zone.

Note: ORMB search engine supports wildcard search, where you can substitute the percentage (%) symbol as a stand in for any word or letter in a search criteria. You can use the ‘%’ wildcard character in all input fields except the date and ID fields. The ‘%’ wildcard character is suffixed automatically at the end of the partial search criteria. Therefore, you may or may not specify the wildcard character at the end of the partial search criteria. However, you have to prefix the wildcard character manually wherever required.

4. Click **Search**.

A list of payment data files that meet the search criteria appears in the **Search Results** section.

Related Topics

For more information on...	See...
Payment Upload screen	Payment Upload on page 1272
Search Payment Data File zone	Search Payment Data File on page 1272

Uploading a Payment Data File

Prerequisites

To upload a payment data file, you should have:

- File types defined in the application (where the feed type is set to **Payment Upload Data**)
- Payment data in the required CSV file format

Procedure

To upload a payment data file:

1. Click the **Menu** link in the **Application** toolbar.
A list appears.
2. From the **Main** menu, select **Payments** and then click **Payment Upload**.
The **Payment Upload** screen appears.
3. Click the **Upload** button in the **Page Title** area of the **Payment Upload** screen.

The **Upload Payment Data File** screen appears. It contains the following fields:

Field Name	Field Description	Mandatory (Yes or No)
File Type	Used to indicate the type of payment data file.	Yes
	Note: The list includes only those file types where the feed type is set to Payment Upload Data .	
File Name	Used to specify the name and path of the payment data file that you want to upload.	Yes
	Note: You can also click the Browse button corresponding to this field to browse to the location where the payment data file is available in the system.	

Field Name	Field Description	Mandatory (Yes or No)
Replace Existing File	Used to indicate whether you want to replace any existing file in the system. You must select this check box when you want to upload the same file once again.	No

4. Select the type of payment data file from the **File Type** list.

5. Click the **Browse** button corresponding to the **File Name** field.

The **Choose File to Upload** dialog box appears.

6. Browse to the location where the payment data file that you want to upload is available.

7. Click **Open**.

The payment data file name and path appears in the **File Name** field.

8. Click **Upload**.

A message appears indicating that the payment data file is uploaded successfully. If an error occurs while parsing, the payment data file is not uploaded in the system.

Note: The system considers the payment data file for upload only when the payment data file is parsed without any errors and contains less than 1000 payment records.

9. Click **OK**.

Once the payment data file is successfully uploaded, the status of the payment data file is changed to **Pending**. The system changes the status of the payment data file based on the following conditions:

- If a payment record is successfully validated, the status of the payment record is changed to **Valid**.
- If a payment record is incorrect or contains missing information, the status of the payment record is either changed to **Invalid** or **Error**. For more information on various payment record statuses, see the [Payment Record Status Transition](#) on page 1266.

Once the validation process is completed, the payment records are copied to the pre-staging area and the status of the payment data file is changed to **Validated**. If a payment data file contains an invalid record, you need to correct or add missing information in the CSV file and then re-upload the file once again. Unless and until, a payment data file has no invalid records, you cannot move any record to the staging area. You can view the details of the payment data file in the **Payment Upload** screen.

Related Topics

For more information on...	See...
Payment Upload screen	Payment Upload on page 1272
Search Payment Data File zone	Search Payment Data File on page 1272

Replacing an Existing File

Prerequisites

To replace an existing payment data file, you should have:

- File types defined in the application (where the feed type is set to **Payment Upload Data**)
- Payment data in the required CSV file format

Procedure

To replace an existing payment data file:

1. Click the **Menu** link in the **Application** toolbar.

A list appears.

2. From the **Main** menu, select **Payments** and then click **Payment Upload**.

The **Payment Upload** screen appears.

3. Click the **Upload** button in the **Page Title** area of the **Payment Upload** screen.

The **Upload Payment Data File** screen appears. It contains the following fields:

Field Name	Field Description	Mandatory (Yes or No)
File Type	Used to indicate the file type for uploading the payment data file.	Yes
	Note: The list includes only those file types where the feed type is set to Payment Upload Data .	
File Name	Used to indicate the name and path of the payment data file that you want to upload.	Yes
	Note: You can also click the Browse button corresponding to this field to browse the location of the payment data file available in the system.	
Replace Existing File	Used to indicate whether you want to replace any existing file in the system.	No
	Note: You must select this check box only when you want to upload the same file once again. You can replace an existing file when the payment data file is in the Validated status. In other words, you cannot replace a file whose payment records are already moved to the staging area and/or for which payment events are already created.	

4. Select the type of payment data file from the **File Type** list.

5. Click the **Browse** button corresponding to the **File Name** field.

The **Choose File to Upload** dialog box appears.

6. Browse to the location where the payment data file that you want to replace is available.

7. Click **Open**.

The payment data file name and path appears in the **File Name** field.

8. Click **Upload**.

A message appears indicating that the payment data file is uploaded successfully.

Note: The system considers the payment data file for upload only when the payment data file is parsed without any errors and contains less than 1000 payment records.

9. Click **OK**

Once the payment data file is successfully uploaded, the status of the payment data file is changed to **Pending**. The system changes the status of the payment data file based on the following conditions:

- If a payment record is successfully validated, the status of the payment record is changed to **Valid**.
- If a payment record is incorrect or contains missing information, the status of the payment record is either changed to **Invalid** or **Error**. For more information on various payment record statuses, see the [Payment Record Status Transition](#) on page 1266.

Once the validation process is completed, the payment records are copied to the pre-staging area and the status of the payment data file is changed to **Validated**. If a payment data file contains an invalid record, you need to correct or add missing information in the CSV file and then re-upload the file once again. Unless and until, a payment data file has no invalid records, you cannot move any record to the staging area. You can view the details of the payment data file in the **Payment Upload** screen.

Related Topics

For more information on...	See...
Payment Upload screen	Payment Upload on page 1272
Search Payment Data File zone	Search Payment Data File on page 1272

Cancelling a Payment Data File

There might be situations when incorrect payment data file is uploaded in the system. In such case, the system provides you with an ability to cancel the file. However, note that you can cancel a payment data file when it is in the **Validated** status. In other words, you cannot cancel a payment data file when its records are moved to the staging area or when the payment events are created for the payment data file.

Procedure

To cancel a payment data file:

1. Search for the payment data file in the **Payment Upload** screen.
2. In the **Search Results** section, click the **Cancel** () icon in the **Cancel** column corresponding to the payment data file that you want to cancel.

A message appears confirming whether you want to cancel the payment data file.

Note: The **Cancel** icon appears when the status of the payment data file is **Validated**.

3. Click **OK**.

The status of the payment data file is changed to **Cancelled**.

Related Topics

For more information on...	See...
How to search for a payment data file	Searching for a Payment Data File on page 1277

Moving the Payment Records to the Staging Area

Procedure

To move the payment records to the staging area:

1. Search for the payment data file in the **Payment Upload** screen.

2. In the **Search Results** section, click the **Move to Staging** () icon in the **Move to Staging** column corresponding to the payment data file whose records you want to move to the staging area.

A message appears confirming whether you want to move all payment records to the payment upload staging area.

Note:

The **Move to Staging** icon appears when:

- The status of the payment data file is **Validated**.
- There are no invalid records in the payment data file.
- The **Disable Move to Staging** check box is not selected in the respective file type.

The system allows you to move only valid and error records of a payment data file to the staging area. If a payment data file contains an invalid record, you cannot move any record of the payment data file to the staging area.

3. Click **OK** in the message box.

A message appears indicating that the payment records are successfully copied from the pre-staging to staging area.

4. Click **OK** in the message box.

The status of the payment data file is changed to **In Staging**. In addition, the status of the payment records in the pre-staging area is changed to **In Staging** and the status of the deposit control, tender control, and payment tender staging records is set to **Pending**.

Related Topics

For more information on...	See...
How to search for a payment data file	Searching for a Payment Data File on page 1277

Editing a Payment Staging Record

You can edit a payment record when it is moved from the pre-staging to staging area. On editing a payment record in the staging area, the system does not reflect the changes in the pre-staging area. It only reflects the changes in the staging area.

Procedure

To edit a payment staging record:

1. Search for the payment data file in the **Payment Upload** screen.
2. In the **Search Results** section, click the **Broadcast** () icon corresponding to the payment data file whose staging records you want to edit.

The **Payment Data Records** and **Payment Data File Log** zones appear.

3. In the **Payment Data Records** section, click the **Broadcast** () icon corresponding to the payment data file whose staging records you want to edit.

The **Payment Staging Records** zone appear.

4. In the **Payment Staging Records** zone, click the **View** () icon in the **Payment Staging Record** column corresponding to the payment staging record whose details you want to edit.

The **Payment Upload Staging** screen appears. It contains the following tabs:

- **Tender Details** - Enables you to view and edit the tender control staging details.
- **Payment Advice** - Enables you to view and edit the payment staging details.

- **Payment Characteristics** - Enables you to view and edit the payment characteristic staging details.
5. Edit or remove the tender details, if required.
 6. Edit or remove the payment advice details, if required.
 7. Edit or remove the payment characteristics, if required.
 8. Click the **Save** button in the **Page Title** area of the **Payment Upload Staging** screen.

The changes made to the payment staging record are saved.

Related Topics

For more information on...	See...
How to search for a payment data file	Searching for a Payment Data File on page 1277
Payment Data Records zone	Payment Data Records on page 1275
Payment Staging Records zone	Payment Staging Records on page 1276
Payment Data File Log zone	Payment Data File Log on page 1277

Viewing the Records of a Payment Data File

Procedure

To view the records of a payment data file:

1. Search for the payment data file in the **Payment Upload** screen.
2. In the **Search Results** section, click the **Broadcast** () icon corresponding to the payment data file whose records you want to view.

The **Payment Data Records** and **Payment Data File Log** zones appear.

3. View the details of the payment records uploaded through the payment data file in the **Payment Data Records** zone.

Related Topics

For more information on...	See...
How to search for a payment data file	Searching for a Payment Data File on page 1277
Payment Data Records zone	Payment Data Records on page 1275

Viewing the Staging Records of a Payment Data Record

Procedure

To view the staging records of a payment data record:

1. Search for the payment data file in the **Payment Upload** screen.
2. In the **Search Results** section, click the **Broadcast** () icon corresponding to the payment data file whose records you want to view.

The **Payment Data Records** and **Payment Data File Log** zones appear.

3. In the **Payment Data Records** zone, click the **Broadcast** () icon corresponding to the payment data file whose staging records you want to view.

- View the details of the staging records in the **Payment Staging Records** zone.

Related Topics

For more information on...	See...
How to search for a payment data file	Searching for a Payment Data File on page 1277
Payment Data Records zone	Payment Data Records on page 1275
Payment Staging Records zone	Payment Staging Records on page 1276
Payment Data File Log zone	Payment Data File Log on page 1277

Viewing the Log of a Payment Data File

Procedure

To view the log of a payment data file:

- Search for the payment data file in the **Payment Upload** screen.
- In the **Search Results** section, click the **Broadcast** () icon corresponding to the payment data file whose log you want to view.

The **Payment Data Records** and **Payment Data File Log** zones appear.

- View the actions performed on the payment data file in the **Payment Data File Log** zone.

Related Topics

For more information on...	See...
How to search for a payment data file	Searching for a Payment Data File on page 1277
Payment Data File Log zone	Payment Data File Log on page 1277

Viewing the Errors of a Payment Data Record

The system allows you to view the reasons why the payment record in a payment data file is in the **Error** or **Invalid** status.

Procedure

To view the errors of a payment data record:

- Search for the payment data file in the **Payment Upload** screen.
- In the **Search Results** section, click the **Broadcast** () icon corresponding to the payment data file whose payment records are in the **Error** or **Invalid** status.

The **Payment Data Records** and **Payment Data File Log** zones appear.

- In the **Payment Data Records** zone, click the **View** () icon in the **Message** column corresponding to the payment record which is in the **Error** or **Invalid** status.

The **Error Messages** window appears.

- View the error messages of the payment data record in the **Error Messages** window.

Note:

The error messages window lists the reasons why the payment data record is in the **Error** or **Invalid** status. If the payment record is in the **Invalid** status, you need to correct or add the missing information in the CSV file and then re-upload the CSV file once again. Unless, a payment data file has no invalid records, you cannot move any record of the payment data file to staging area.

The **View** icon appears when the payment data record is in the **Error** or **Invalid** status.

5. Click **OK**.

Related Topics

For more information on...	See...
How to search for a payment data file	Searching for a Payment Data File on page 1277
Payment Data Records zone	Payment Data Records on page 1275

Chapter 14

Freeze Payments on Notification

Topics:

- [Freeze Payments on Notification Process](#)
- [Prerequisites](#)
- [Automatic Payment or Refund Clearing Staging Record Status Transition](#)
- [EDI 824 File Format](#)
- [Sample EDI 824 File Format](#)
- [Automatic Payment and Refund Upload Reason](#)
- [Automatic Payment and Refund Clearing Staging](#)

Oracle Revenue Management and Billing facilitates you to create automatic payments and refunds when the automatic payment option is enabled for an account. A clearing record is created for each automatic payment and refund in the system. You can then send the automatic payment and refund clearing records to the auto clearing house for verification. The system provides the mechanism to extract the automatic payment clearing records in a flat file. You can then send the flat file to the auto clearing house for verification. However, the implementation team will have to write the custom logic to extract the automatic refund clearing records in a file which you can then send to the auto clearing house for verification.

Once the auto clearing house reviews the automatic payment clearing records, the system allows you to upload review comments received in the EDI 824 file format. On uploading an EDI 824 file, an automatic payment clearing staging record is created for each valid automatic payment clearing ID. The data received from the auto clearing house is stored in the following staging tables:

- CI_APAY_STAGE_UP
- CI_APAY_STAGE_UP_REM
- CI_APAY_STGUP_CHAR

The implementation team will have to write the custom logic to upload review comments for automatic refund clearing records in the above mentioned staging tables. The review comments for automatic payment clearing records can be received in the form of reason (i.e. upload reason) and error codes (i.e. payment cancelation reason or NOC reason) which will help you to determine whether the automatic payment must be frozen or cancelled in the system. Similarly, the review comments for automatic refund clearing records can be received in the form of reason (i.e. upload reason) and error codes (i.e. void status reason) which will help you to determine whether the refund request must be voided and refund adjustments must be cancelled in the system.

Once the review comments are received from the auto clearing house, you can do the following:

- Freeze or cancel the automatic payments
- Void the refund requests and cancel the refund adjustments

For more detailed information about the freeze payments on notification process, see [Freeze Payments on Notification Process](#) on page 1289.

The system allows you to define upload reasons, payment cancelation reasons, NOC reasons, and void status reasons. The system also allows you to edit and delete the automatic payment and refund clearing staging records through the user interface. However, you can edit an automatic payment or refund clearing staging record when it is in the **Pending** or **Error** status, and you

can delete an automatic payment or refund clearing staging record when it is in the **Pending** status. During the freeze payments on notification process, the automatic payment and refund clearing staging records go through various statuses in its lifecycle. For more information about the statuses, see [Automatic Payment or Refund Clearing Staging Record Status Transition](#) on page 1293.

For more information on how to setup the freeze payments on notification process, see [Prerequisites](#) on page 1292.

Freeze Payments on Notification Process

The Freeze Payments on Notification process includes the following sub-processes:

1. [Creating Automatic Payments and Refunds](#) on page 1289
2. [Generating a Flat File](#) on page 1289
3. [Uploading Response from Auto Clearing House \(ACH\)](#) on page 1289
4. [Retry Automatic Payment](#) on page 1290
5. [Freezing or Canceling Automatic Payments](#) on page 1291
6. [Voiding Refund Requests and Canceling Refund Adjustments](#) on page 1291
7. [Generating To Do Entries](#) on page 1292
8. [Creating Tender Controls](#) on page 1292

Note that during the freeze payments on notification process, you need to execute the following batches in the specified order:

1. Create Automatic Payments and Refunds (APAYCRET)
2. Activate Automatic Payments (ACTVTAPY)
3. Extract Automatic Payments (APAYACH)
4. Maintain Additional Information for Staging Record (C1-APRCH)
5. Upload Response from Auto Clearing House (C1-APACK)
6. Freeze or Cancel Automatic Payments (APAYRA)
7. Cancel Automatic Refunds (AREFRA)
8. To Do Creation for Automatic Payment Exception Records (APAYUPTD)
9. Create Tender Controls for Automatic Payments (BALAPY)

For more information about these batches, see *Oracle Revenue Management and Billing Batch Guide*.

Creating Automatic Payments and Refunds

If you have configured the automatic payment option for an account, the system calculates the automatic payment amount and extract date during the bill completion and stamps these details against the bill in the **CI_BILL_ACH** table. The **Create Automatic Payments and Refunds (APAYCRET)** batch allows you to create automatic payment and refund request depending on whether the automatic payment amount is in debit or credit. It also creates a clearing record for each automatic payment and refund in the **CI_APAY_CLR_STG** and **CI_ADJ_CLR_STG** tables, respectively. For more information about the batch, see *Oracle Revenue Management and Billing Batch Guide*.

Generating a Flat File

Unless you activate a clearing record, you cannot extract the clearing record in a flat file. The **Activate Automatic Payments (ACTVTAPY)** batch allows you to activate a clearing record. It stamps the **APAYACH** batch control and incremental batch run number on the clearing record.

Once the clearing records are activated, you can extract the clearing records in a flat file. The **Extract Automatic Payments (APAYACH)** batch allows you to extract the clearing records with the latest batch run number in a flat file. The flat file is then sent to the auto clearing house for review. For more information about these batches, see *Oracle Revenue Management and Billing Batch Guide*.

Note: At present, you cannot activate and extract the automatic refund clearing records using the **Activate Automatic Payments (ACTVTAPY)** and **Extract Automatic Payments (APAYACH)** batches, respectively. The implementation team will have to write the custom logic to activate and extract automatic refund clearing records in a flat file.

Uploading Response from Auto Clearing House (ACH)

Once the auto clearing house reviews the automatic payment clearing records, the review comments can be shared in the EDI 824 file format. An EDI 824 file may contain the review comments for one or more automatic payment clearing records. You can upload these EDI 824 files and store the review comments in the staging area using the **Upload Response from Auto Clearing House (C1-APACK)** batch.

On uploading an EDI 824 file, the system checks whether the automatic payment clearing ID specified in each record exists in the system. If so, it creates an automatic payment clearing staging record for the automatic payment clearing ID in the **CI_APAY_STAGE_UP** table. If the acknowledgement code in the record is set to **TE** or **TR**, the system considers that the auto clearing house has rejected the automatic payment clearing record. The reason code (i.e. upload reason) specified in the **Reject Upload Reason** parameter of the **C1-APAY** algorithm is stored corresponding to the automatic payment clearing staging record in the **CI_APAY_STAGE_UP_REM** table. In addition, the error code (i.e. payment cancellation reason) is stored corresponding to the automatic payment clearing staging record in the **CI_APAY_STAGE_UP_REM** table.

However, if the acknowledgement code is blank or if the acknowledgement code is set to a value other than **TE** or **TR**, the system considers that the auto clearing house has accepted the automatic payment clearing record. The reason code (i.e. upload reason) specified in the **Success Upload Reason** parameter of the **C1-APAY** algorithm is stored corresponding to the automatic payment clearing staging record in the **CI_APAY_STAGE_UP_REM** table. In addition, the error code (i.e. NOC reason) is stored corresponding to the automatic payment clearing staging record in the **CI_APAY_STAGE_UP_REM** table. In this case, the record may contain more than one error code.

The status of the automatic payment clearing staging record is set to **Pending**. If the error code (i.e. payment cancellation reason or NOC reason) is invalid, the status of the automatic payment clearing staging record is set to **Error**. An exception is logged in the **CI_APAY_STGUP_EXC** table. In addition, if the status of the NOC reason is **Inactive** in the system, the status of the automatic payment clearing staging record is set to **Error** and an exception is logged in the **CI_APAY_STGUP_EXC** table.

The system sets the automatic payment distribution and freeze date (i.e. **APAY_DIST_FRZ_DT**) for each automatic payment clearing record (for which automatic payment clearing staging record is added in the system) to the payment date (which is stored on the payment event). For more information about the batch, see *Oracle Revenue Management and Billing Batch Guide*.

Note: An additional table named **CI_APAY_STGUP_CHAR** is available which the implementation team can use to store additional information about the automatic payment clearing staging record in the form of characteristics.

To ensure that the EDI 824 files are uploaded successfully, you need to set the following parameters in an algorithm which is created using the **C1-APAY** algorithm type:

- **Line Separator** - Used to indicate the character specified in the EDI 824 files to represent the end of line.
- **Field Separator** - Used to indicate the character specified in the EDI 824 files to represent the end of data record.
- **Reject Upload Reason** - Used to indicate the upload reason which you want to use when the auto clearing house has rejected the automatic payment clearing record.
- **Success Upload Reason** - Used to indicate the upload reason which you want to use when the auto clearing house has accepted the automatic payment clearing record with or without Notice to Change (NOC).

Note: You must specify an upload reason which is already defined in the system.

For more information about the EDI 824 file format, see [EDI 824 File Format](#) on page 1294.

Retry Automatic Payment

In the Freeze Payments on Notification feature, the system enables you to freeze or cancel the automatic payment based on the review comments received from the auto clearing house. Until now, the system did not allow to resend the automatic payment clearing records to the auto clearing house for review in case of rejection. Now, the system enables you to resend the rejected automatic payment clearing records to the auto clearing house for review.

To enable this feature, you need to set the **C1-APMSG** characteristic type for the required divisions. Here, you must set the maximum automatic payment reattempts allowed while using the Freeze Payments on Notification feature.

A new batch named **C1-APRCH** is introduced in this release. You need to execute this batch in between the following two batches - **C1-APACK** and **APAYRA**. The **C1-APRCH** batch considers the automatic payment clearing staging records which are in the **Pending** status from the **CI_APAY_STAGE_UP** table. The system then checks whether the **APAY_UPL_RSN_TYPE** column corresponding to the automatic payment clearing staging record is set to **SUCC** or **CANC**. If the **APAY_UPL_RSN_TYPE** column corresponding to the automatic payment clearing staging record is

set to **SUCC**, the system updates the last extract date of the automatic payment clearing staging record to the extract date which is available corresponding to the clearing record in the **CI_APAY_CLR_STG** table. However, if the **APAY_UPL_RSN_TYPE** column corresponding to the automatic payment clearing staging record is set to **CANC**, the system checks whether the number of automatic payment clearing staging records for the clearing record is equal to or greater than one. If the number of automatic payment clearing staging records for the clearing record is equal to or greater than one, the system increments the retry count of the clearing ID. If the retry count is greater than zero and less than the maximum automatic payment reattempt limit defined for the division, the system does the following:

- Recalculates the extract date and stamps it against the corresponding clearing record in the **SCHED_EXTRACT_DT** column of the **CI_APAY_CLR_STG** table
- Clears the **BATCH_NBR** column of the corresponding clearing record in the **CI_APAY_CLR_STG** table
- Clears the **APAY_DIST_FRZ_DT** column of the corresponding clearing record in the **CI_APAY_CLR_STG** table

Finally, the status of the automatic payment clearing staging record is set to **RETR**. A To Do is created using the **CI-APRET** To Do type to notify that the status of an automatic payment clearing staging record is changed to **RETR**.

Freezing or Canceling Automatic Payments

Once the review comments are received in the form of reason and error codes for an automatic payment clearing record, you need to freeze or cancel the automatic payment based on the reason code. You can freeze or cancel automatic payments through the **Freeze or Cancel Automatic Payments (APAYRA)** batch.

On executing the **Freeze or Cancel Automatic Payments (APAYRA)** batch, the system checks whether the reason code (i.e. upload reason) and error code (i.e. payment cancellation reason or NOC reason) specified in the automatic payment clearing staging record exist in the system. This batch considers only those automatic payment clearing staging records which are in the **Pending** status and for which payment freeze date is specified in the automatic payment clearing record. If the reason code and error code exist in the system, the system executes the algorithms attached to the reason code in the specified sequence. If the type of reason code is **Cancel**, the attached algorithm cancels the automatic payment and payment event. If the type of reason code is **Success**, the attached algorithm freezes the automatic payment on the payment freeze date. However, if the type of reason code is **Success** and the error code is specified along with the reason code, the attached algorithm freezes the automatic payment on the payment freeze date, stores error codes (i.e. NOC reasons) as payment tender characteristics and then creates a To Do entry to notify user about these NOC reasons. Finally, the status of the automatic payment clearing staging record is changed to **Complete**.

If the reason code and/or error code (i.e. upload reason, payment cancellation reason, or NOC reason) specified in the automatic payment clearing staging record does not exist in the system, the status of the automatic payment clearing staging record is changed to **Error**. In addition, if the status of the NOC reason is **Inactive** in the system, the status of the automatic payment clearing staging record is changed to **Error**. For more information about the batch, see *Oracle Revenue Management and Billing Batch Guide*.

Voiding Refund Requests and Canceling Refund Adjustments

Once the auto clearing house reviews the automatic refund clearing records and shares the review comments, the implementation team will have to store the review comments in the following staging tables:

- **CI_APAY_STAGE_UP** – Used to store the automatic payment or refund clearing staging record for an automatic payment or refund clearing record, respectively. The status of the automatic payment or refund clearing staging record must be set to **Pending**.
- **CI_APAY_STAGE_UP_REM** – Used to store the reason and error codes of each automatic payment or refund clearing staging record.
- **CI_APAY_STGUP_CHAR** – Used to store additional information about the automatic payment or refund clearing staging record in the form of characteristics.

The review comments must be received in the form of reason (i.e. upload reason) and error codes (i.e. void status reason) for an automatic refund clearing record. On executing the **Cancel Automatic Refunds (AREFRA)** batch, it checks whether the reason and error codes specified in the automatic refund clearing staging record exist in the system. If

the reason and error codes exist in the system, the system executes the algorithms attached to the reason code in the specified sequence. If the type of reason code is **Cancel**, the attached algorithm changes the status of the refund request to **Voided** and the corresponding refund adjustments are canceled. If the type of reason code is **Success**, no changes are made to the refund request and refund adjustments. Finally, the status of the automatic refund clearing staging record is changed to **Complete**.

If the reason code and/or error code (i.e. upload reason, void status reason) specified in the automatic refund clearing staging record does not exist in the system, the status of the automatic refund clearing staging record is changed to **Error**.

Generating To Do Entries

If an exception occurs while executing the **Freeze or Cancel Automatic Payments (APAYRA)** batch, you can notify the user about such exception. The **To Do Creation for Automatic Payment Exception Records (APAYUPTD)** batch allows you to create a To Do using the **APAYUPTD** To Do type when an exception is logged for an automatic payment clearing staging record in the **CI_APAY_STGUP_EXC** table. The system creates one To Do entry for all exceptions that have occurred for an automatic payment clearing staging record. For more information about these batches, see *Oracle Revenue Management and Billing Batch Guide*.

Note: At present, a To Do is not created when an exception is logged for an automatic refund clearing staging record in the **CI_APAY_STGUP_EXC** table while executing the **Cancel Automatic Refunds (AREFRA)** batch.

Creating Tender Controls

Once you freeze the automatic payments, you need to create tender and deposit controls. The **Create Tender Controls for Automatic Payments (BALAPY)** batch allows you to create tender and deposit controls for each automatic payment which is frozen, but not yet linked to any tender control. One tender control is created for the **APAYACH** batch control and batch run number combination. The payment tenders of these automatic payments are then linked to the tender control.

This batch also balances the open tender control records and changes the status of the tender and deposit controls, accordingly. For more information about the batch, see *Oracle Revenue Management and Billing Batch Guide*.

Prerequisites

To setup the freeze payments on notification process, you need to do the following:

- Define the automatic payment instructions for the account for which you want to enable the automatic payment option.

Note: You can either define non-rule based effective dated automatic payment instructions in the **Auto Pay** tab of the **Account** screen or define rule based effective dated automatic payment instructions through the **Auto Pay Rule** screen.

- Set the **Autopay Creation Option** field to **Freeze Payment on Notification** in the **Billing** tab of the **Installation Options** screen.
- Create an automatic payment creation algorithm using the **APAY-CREATE** algorithm type and attach it to the **Automatic Payment Creation** system event in the **Algorithms** tab of the **Installation Options - Framework** screen.
- Create an automatic refund creation algorithm using the **C1-AREF-CRET** algorithm type and attach it to the **Automatic Adjustment Creation** system event in the **Algorithms** tab of the **Installation Options - Framework** screen.
- Create a date calculation algorithm using the **APAY-DTCALC** algorithm type and attach it to the **Autopay Date Calculation Alg** spot of the auto pay route type which is specified on the account's automatic payment instruction.
- Define the required upload reasons in the system.

- Define the required payment cancelation reasons in the system.
- Define values for the **APAY_UPL_NOC_LOOKUP** lookup field.

Note: The **APAY_UPL_NOC_LOOKUP** lookup field is used to define NOC reasons. The NOC reason specified in the automatic payment clearing staging record must exist in this lookup field and its status must be **Active**. Otherwise, the status of the automatic payment clearing staging record is changed to **Error**.

- Define voided status reasons for the **C1-RefundReq** business object.
- Create an automatic payment success algorithm using the **C1-APAY-SUCC** algorithm type and attach it to the reason code where the reason type is set to **Success**.

Note: You must attach the automatic payment success algorithm to an upload reason which you want to use while freezing automatic payments.

- Create an automatic payment cancel algorithm using the **C1-APAY-CAN** algorithm type and attach it to the reason code where the reason type is set to **Cancel**.

Note: You must attach the automatic payment cancel algorithm to an upload reason which you want to use while canceling automatic payments.

- Create a void automatic refund algorithm using the **C1-AREF-VOID** algorithm type and attach it to the reason code where the reason type is set to **Cancel**.

Note: You must attach the void automatic refund algorithm to an upload reason which you want to use while voiding automatic refunds.

- Create a characteristic type where the characteristic entity is set to **Payment Tender**. And, then specify this characteristic type as the value for the **Tender Characteristic Type** parameter in an algorithm which is created using the **C1-APAY-SUCC** algorithm type.
- Assign the **C1-ACH To Do** type to a To Do role whose users must receive the To Do entries generated when automatic payments are frozen with a Notice to Change (NOC).
- Assign the **APAYUPTD To Do** type to a To Do role whose users must receive the To Do entries generated when exceptions have occurred while executing the **Freeze or Cancel Automatic Payments (APAYRA)** batch.
- Define values for the following parameters in an algorithm which is created using the **C1-APAY** algorithm type:
 - Line Separator
 - Field Separator
 - Reject Upload Reason
 - Success Upload Reason

Automatic Payment or Refund Clearing Staging Record Status Transition

The following figure graphically indicates how an automatic payment or refund clearing staging record moves from one status to another during the freeze payments on notification process:

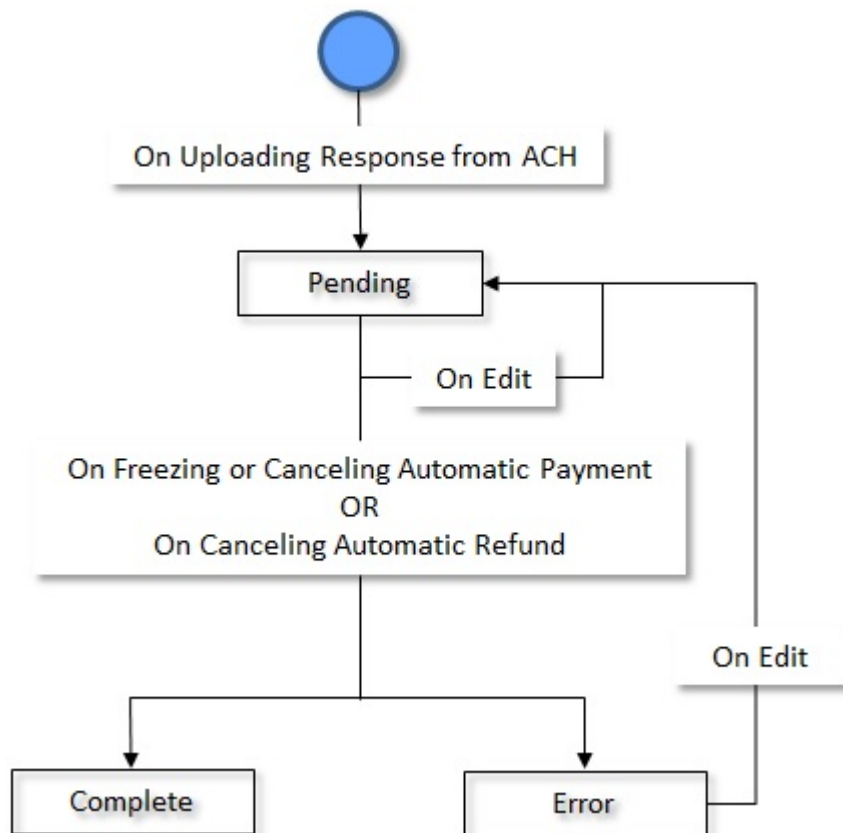

EDI 824 File Format

Before uploading the EDI 824 file, you need to ensure that the file contains the following tags and attributes:

Tag	Attribute	Description	Mandatory (Yes or No)
OTI	Reference Number	Used to specify the automatic payment clearing ID. It indicates the automatic payment clearing record for which the review comments are received from the auto clearing house.	Yes
OTI	Acknowledgement Code	Used to indicate whether the automatic payment clearing record is accepted or rejected by the auto clearing house. If you want to reject the automatic payment clearing record, you must specify TE or TR as the acknowledgement code. However, if you want to approve the automatic payment clearing record, you can either specify any value other than TE or TR or leave this attribute blank.	No
TED	Error Code	Used to indicate either of the following: <ul style="list-style-type: none"> The payment cancellation reason when the automatic payment clearing record is rejected by the auto clearing house. 	Yes (Conditional)

Tag	Attribute	Description	Mandatory (Yes or No)
		<p>Note: You must specify a payment cancellation reason which is already defined in the system.</p> <ul style="list-style-type: none"> The Notice to Change (NOC) reason when the automatic payment clearing record is accepted by the auto clearing house with a Notice to Change (NOC). <p>Note: You must specify a NOC reason which is already defined in the APAY_UPL_NOC_LOOKUP lookup field.</p>	<p>Note: This attribute is required when the automatic payment clearing record is rejected by the auto clearing house.</p>
TED	Error Description	Used to specify the reason why the automatic payment clearing record is either rejected or accepted with a Notice to Change (NOC).	No

Sample EDI 824 File Format

```

OTI*TR*TN*411302586842\
TED*WA01*WRONG ACCOUNT\
OTI*TF*TN*411302525641\
OTI*TO*TN*806152348038\
TED*BR01*Bill Reopened\
OTI*TO*TN*806152307159\
OTI*TE*TN*806152307229\
TED*WA01*WRONG ACCOUNT\

```

Here, TR, TF, TO, and TE are acknowledgement codes. TR and TE indicate that the automatic payment clearing records are rejected. And, TF and TO indicate that the automatic payment clearing records are accepted with or without a Notice to Change (NOC).

Here, 411302586842, 411302525641, 806152348038, 806152307159, and 806152307229 are automatic payment clearing records, and WA01 and BR01 are error codes. WA01 is a payment cancellation reason and BR01 is a NOC reason. The string “WRONG ACCOUNT” and “Bill Reopened” are error descriptions.

For more information about the EDI 824 file format, see [EDI 824 File Format](#) on page 1294.

Automatic Payment and Refund Upload Reason

Once the auto clearing house reviews the automatic payment and refund clearing records, an appropriate upload reason must be received for each clearing record. The upload reason indicates the following:



- Whether the automatic payment must be frozen or cancelled in the system
- Whether the automatic refund must be canceled in the system (i.e. the refund request must be voided and refund adjustments must be canceled)

The **Automatic Payment and Refund Upload Reason** screen allows you to define, edit, and delete an upload reason. It contains the following zone:

- [Upload Reasons](#) on page 1296

Upload Reasons

The **Upload Reasons** zone lists upload reasons that are already defined in the system. It contains the following columns:

Column Name	Column Description
Upload Reason	Displays the upload reason.
Reason Type	Indicates the type of upload reason. The valid values are: <ul style="list-style-type: none"> • Cancel • Success
Eligible for Processing	Indicates whether the algorithms attached to the upload reason must be triggered while executing the Freeze or Cancel Automatic Payments (APAYRA) or Cancel Automatic Refunds (AREFRA) batch. The valid values are: <ul style="list-style-type: none"> • Y • N
Description	Displays the description of the upload reason.
Edit	On clicking the Edit () icon, the Automatic Payment and Refund Upload Reason screen appears where you can edit the details of the upload reason.
Delete	On clicking the Delete () icon, you can delete the upload reason.

You can define an upload reason by clicking the **Add** link in the upper right corner of this zone.

Related Topics

For more information on...	See...
How to define an upload reason	Defining an Upload Reason on page 1296
How to edit an upload reason	Editing an Upload Reason on page 1298
How to delete an upload reason	Deleting an Upload Reason on page 1300

Defining an Upload Reason

Prerequisites

To define an upload reason, you should have:

- Automatic payment success algorithm defined using the **C1-APAY-SUCC** algorithm type
- Automatic payment cancel algorithm defined using the **C1-APAY-CAN** algorithm type
- Void automatic refund algorithm defined using the **C1-AREF-VOID** algorithm type

Procedure

To define an upload reason:

1. Click the **Admin** link in the **Application** toolbar.
A list appears.
2. From the **Admin** menu, select **A** and then click **Automatic Payment and Refund Upload Reason**.
The **Automatic Payment and Refund Upload Reason** screen appears.
3. Click the **Add** link in the upper right corner of the **Upload Reasons** zone.

The **Automatic Payment and Refund Upload Reason** screen appears. It contains the following fields:

Field Name	Field Description	Mandatory (Yes or No)
Upload Reason	Used to specify the upload reason.	Yes
Description	Used to specify the description for the upload reason.	Yes
Reason Type	Used to indicate the type of upload reason. The valid values are: <ul style="list-style-type: none"> • Cancel — This type of upload reason indicates that you must cancel the automatic payment or refund in the system. In this case, the error code indicates the reason why the automatic payment is cancelled or the refund request is voided. • Success — This type of upload reason indicates that you must freeze the automatic payment on the payment freeze date. If the error code is specified, it indicates that you must freeze the automatic payment, and at the same time notify user that the automatic payment is accepted with a Notice to Change (NOC). The NOC reason is stored as payment tender characteristic in the system. You can specify more than one error code (i.e. NOC reasons) with this type of upload reason. On freezing an automatic payment, the user is notified about these NOC reasons through a To Do entry. The system creates one To Do entry using the C1-ACH To Do type for all NOC reasons specified in the automatic payment clearing staging record. 	Yes
Eligible for Processing	Used to indicate whether the algorithms attached to the upload reason must be triggered while executing the Freeze or Cancel Automatic Payments (APAYRA) or Cancel Automatic Refunds (AREFRA) batch.	No

In addition, this screen contains a grid where you can attach algorithms to the upload reason. It contains the following columns:

Column Name	Column Description	Mandatory (Yes or No)
Sequence	Used to indicate the order in which the algorithm must be triggered.	Yes (Conditional) Note: This field is required when you are attaching an algorithm to the upload reason.
Algorithm	Used to attach an algorithm to the upload reason. If the type of the upload reason is set to Success , you must attach the automatic payment success algorithm. However, if the type of the upload reason is set to Cancel , you must attach either automatic payment cancel or void automatic refund algorithm	Yes (Conditional) Note: This field is required when you are attaching an algorithm to the upload reason.

Column Name	Column Description	Mandatory (Yes or No)
	depending on whether the upload reason will be used for automatic payment or automatic refund cancelation.	
	<p>Note:</p> <p>The Search (🔍) icon appears corresponding to this field. On clicking the Search icon, the Algorithm Code Search window appears.</p> <p>On specifying the algorithm code, the description of the algorithm appears corresponding to the Algorithm field.</p>	

- Enter the required details in the **Automatic Payment and Refund Upload Reason** screen.

Note: If you want to attach more than one algorithm to the upload reason, click the **Add** (+) icon and then specify the details. However, if you want to remove an algorithm from the upload reason, click the **Delete** (🗑️) icon corresponding to the algorithm.

- Click **Save**.

The upload reason is defined.

Related Topics

For more information on...	See...
Automatic Payment and Refund Upload Reason screen	Automatic Payment and Refund Upload Reason on page 1295
Upload Reasons zone	Upload Reasons on page 1296

Editing an Upload Reason

Prerequisites

To edit an upload reason, you should have:

- Automatic payment success algorithm defined using the **C1-APAY-SUCC** algorithm type
- Automatic payment cancel algorithm defined using the **C1-APAY-CAN** algorithm type
- Void automatic refund algorithm defined using the **C1-AREF-VOID** algorithm type

Procedure

To edit an upload reason:

- Click the **Admin** link in the **Application** toolbar.
A list appears.
- From the **Admin** menu, select **A** and then click **Automatic Payment and Refund Upload Reason**.
The **Automatic Payment and Refund Upload Reason** screen appears.
- In the **Upload Reasons** zone, click the **Edit** (✎) icon in the **Edit** column corresponding to the upload reason whose details you want to edit.

The **Automatic Payment and Refund Upload Reason** screen appears. It contains the following fields:

Field Name	Field Description	Mandatory (Yes or No)
Upload Reason	Displays the upload reason.	Not applicable
Description	Used to specify the description for the upload reason.	Yes
Reason Type	Used to indicate the type of upload reason. The valid values are: <ul style="list-style-type: none"> • Cancel — This type of upload reason indicates that you must cancel the automatic payment or refund in the system. In this case, the error code indicates the reason why the automatic payment is cancelled or the refund request is voided. • Success — This type of upload reason indicates that you must freeze the automatic payment on the payment freeze date. If the error code is specified, it indicates that you must freeze the automatic payment, and at the same time notify user that the automatic payment is accepted with a Notice to Change (NOC). The NOC reason is stored as payment tender characteristic in the system. You can specify more than one error code (i.e. NOC reasons) with this type of upload reason. On freezing an automatic payment, the user is notified about these NOC reasons through a To Do entry. The system creates one To Do entry using the C1-ACH To Do type for all NOC reasons specified in the automatic payment clearing staging record. 	Yes
Eligible for Processing	Used to indicate whether the algorithms attached to the upload reason must be triggered while executing the Freeze or Cancel Automatic Payments (APAYRA) or Cancel Automatic Refunds (AREFRA) batch.	No

In addition, this screen contains a grid where you can attach algorithms to the upload reason. It contains the following columns:

Column Name	Column Description	Mandatory (Yes or No)
Sequence	Used to indicate the order in which the algorithm must be triggered.	Yes (Conditional) Note: This field is required when you are attaching an algorithm to the upload reason.
Algorithm	Used to attach an algorithm to the upload reason. If the type of the upload reason is set to Success , you must attach the automatic payment success algorithm. However, if the type of the upload reason is set to Cancel , you must attach either automatic payment cancel or void automatic refund algorithm depending on whether the upload reason will be	Yes (Conditional) Note: This field is required when you are attaching an algorithm to the upload reason.

Column Name	Column Description	Mandatory (Yes or No)
	used for automatic payment or automatic refund cancelation.	
	<p>Note:</p> <p>The Search (🔍) icon appears corresponding to this field. On clicking the Search icon, the Algorithm Code Search window appears.</p> <p>On specifying the algorithm code, the description of the algorithm appears corresponding to the Algorithm field.</p>	

4. Modify the required details in the **Automatic Payment and Refund Upload Reason** screen.

Note: If you want to attach more than one algorithm to the upload reason, click the **Add** (+) icon and then specify the details. However, if you want to remove an algorithm from the upload reason, click the **Delete** (🗑️) icon corresponding to the algorithm.

5. Click **Save**.

The changes made to the upload reason are saved.

Related Topics

For more information on...	See...
Automatic Payment and Refund Upload Reason screen	Automatic Payment and Refund Upload Reason on page 1295
Upload Reasons zone	Upload Reasons on page 1296

Deleting an Upload Reason

Procedure

To delete an upload reason:

1. Click the **Admin** link in the **Application** toolbar.
A list appears.
2. From the **Admin** menu, select **A** and then click **Automatic Payment and Refund Upload Reason**.
The **Automatic Payment and Refund Upload Reason** screen appears.
3. In the **Upload Reasons** zone, click the **Delete** (🗑️) icon in the **Delete** column corresponding to the upload reason that you want to delete.
A message appears confirming whether you want to delete the upload reason.
4. Click **OK**.
The upload reason is deleted.

Related Topics

For more information on...	See...
Automatic Payment and Refund Upload Reason screen	Automatic Payment and Refund Upload Reason on page 1295
Upload Reasons zone	Upload Reasons on page 1296

Automatic Payment and Refund Clearing Staging

The **Automatic Payment and Refund Clearing Staging** screen allows you to search for automatic payment or refund clearing records using various search criteria. In addition, you can:

- View the automatic payment or refund clearing staging records associated to a clearing record
- View the upload reason and payment cancelation reason or NOC reason specified in the automatic payment clearing staging record
- View the upload reason and void status reason specified in the automatic refund clearing staging record
- View the characteristics of the automatic payment or refund clearing staging record
- Edit an automatic payment or refund clearing staging record
- Delete an automatic payment or refund clearing staging record

This screen contains the following zones:

- [Search Clearing Record](#) on page 1301
- [Associated Clearing Staging Records](#) on page 1303
- [Clearing Staging Upload Reasons](#) on page 1304
- [Clearing Staging Characteristics](#) on page 1305

Search Clearing Record

The **Search Clearing Record** zone allows you to search for automatic payment and refund clearing records using various search criteria. It contains the following two sections:

- **Search Criteria** — the **Search Criteria** section contains the following fields:

Field Name	Field Description	Mandatory (Yes or No)
Search By	Used to indicate whether you want to search for the automatic payment or refund clearing records. The valid values are: <ul style="list-style-type: none"> • Automatic Payment • Automatic Refund 	Yes
Clearing ID	Used to search a particular clearing record.	No
Account ID	Used to search clearing records which are created for a particular account. <p>Note: The Search (🔍) icon appears corresponding to this field. On clicking the Search icon, the Account Search window appears.</p>	No

Field Name	Field Description	Mandatory (Yes or No)
Person Name	Used to search clearing records which are created for accounts of a particular person.	No
Extract From Date	Used to search clearing records that are extracted on or after a particular date.	No
Extract To Date	Used to search clearing records that are extracted on or before a particular date.	No
Bill ID	Used to search clearing records which are created against a bill.	No
Alternate Bill ID	Used to search clearing records which are created against a bill with the specified alternate bill ID.	No
Batch Control	Used to search clearing records where the APAYACH batch control is stamped. The valid value is APAYACH .	No
Batch Run Number	Used to search clearing records which are activated in a particular batch run.	No

Note: You must specify at least one search criterion while searching for a clearing record.

- **Search Results** — On clicking the **Search** button, the search results appear based on the specified search criteria. The **Search Results** section contains the following columns:

Column Name	Column Description
Clearing ID	Displays the clearing ID.
Account Information	Indicates the account for which the clearing record is created. In addition, this column has a context menu which helps in navigating to other screens in the application. Note: It has a link. On clicking the link, the Account screen appears with the details of the respective account.
Bill Information	Indicates the bill against which the clearing record is created. In addition, this column has a context menu which helps in navigating to other screens in the application. Note: It has a link. On clicking the link, the Bill screen appears with the details of the respective bill.
Payment Amount	Displays the payment amount. Note: This column appears only when you select the Automatic Payment option from the Search By list.
Pay Tender ID	Displays the payment tender ID. Note: It has a link. On clicking the link, the Payment Event screen appears where you can view the details of the respective tender. This column appears when you select the Automatic Payment option from the Search By list.

Column Name	Column Description
Tender Status	Indicates the current status of the payment tender. The valid values are: <ul style="list-style-type: none"> Valid Canceled
	Note: This column appears when you select the Automatic Payment option from the Search By list.
Extract Date	Displays the date when the clearing record is extracted in a flat file.
Payment Freeze Date	Displays the date when the automatic payment must be frozen in the system.
	Note: This column appears when you select the Automatic Payment option from the Search By list.
External Source ID	Indicates the tender source through which the payment was remitted.
Entity Type	Indicates the type of entity which is created for automatic refund. The valid value is: <ul style="list-style-type: none"> Refund Request
	Note: This column appears when you select the Automatic Refund option from the Search By list.
Entity ID	Displays the entity ID.
	Note: This column appears when you select the Automatic Refund option from the Search By list.
Account Number	Indicates the bank account through which the automatic payment is made.
Batch Control	Indicates the batch control which is stamped on the clearing record.
Batch Run Number	Indicates the batch run in which the clearing record was activated.
Alternate Bill ID	Indicates the bill against which the clearing record is created.

Related Topics

For more information on...	See...
How to search for a clearing record	Searching for a Clearing Record on page 1305

Associated Clearing Staging Records

The **Associated Clearing Staging Records** zone lists the automatic payment or refund clearing staging records which are added corresponding to the clearing record. You can edit and delete an automatic payment or refund clearing staging record through this zone. It contains the following columns:

Column Name	Column Description
Clearing Staging ID	Displays the clearing staging ID.
Clearing ID	Indicates the clearing record against which the clearing staging record is added.
Status	Indicates the status of the clearing staging record. The valid values are: <ul style="list-style-type: none"> Pending Complete

Column Name	Column Description
	<ul style="list-style-type: none"> Error
Edit	<p>On clicking the Edit (✎) icon, the Edit Clearing Staging Record screen appears where you can edit the details of the clearing staging record.</p> <p>Note: You can edit a clearing staging record when it is in the Pending or Error status.</p>
Delete	<p>On clicking the Delete (🗑) icon, you can delete the clearing staging record.</p> <p>Note: You can delete a clearing staging record when it is in the Pending status.</p>

By default, the **Associated Clearing Staging Records** zone does not appear in the **Automatic Payment and Refund Clearing Staging** screen. It appears when you click the **Broadcast** (📡) icon corresponding to the clearing record in the **Search Clearing Record** zone.

Related Topics

For more information on...	See...
How to view the clearing staging records associated to a clearing record	Viewing the Clearing Staging Records Associated to a Clearing Record on page 1306
How to edit a clearing staging record	Editing a Clearing Staging Record on page 1307
How to delete a clearing staging record	Deleting a Clearing Staging Record on page 1310

Clearing Staging Upload Reasons

The **Clearing Staging Upload Reasons** zone lists the reason code (i.e. upload reason) and error code (i.e. payment cancellation reason, Notice to Change (NOC) reasons, or void status reason) specified in the automatic payment or refund clearing staging record. It contains the following columns:

Column Name	Column Description
Sequence	Indicates the sequence in which the upload reason should be considered while freezing or canceling the automatic payment or while canceling the automatic refund.
Clearing Staging ID	Displays the clearing staging ID.
Clearing ID	Indicates the clearing record against which the clearing staging record is added.
Upload Reason	Indicates whether the auto clearing house has accepted or rejected the clearing record.
Cancel Reason	Indicates the reason why the auto clearing house has rejected the clearing record. If the clearing record is created for an automatic payment, the payment cancellation reason appears in this column. However, if the clearing record is created for an automatic refund, the void status reason appears in this column.
NOC Reason	Indicates the reason why the auto clearing house has accepted the clearing record with a Notice to Change (NOC).
NOC Reason Description	Displays the description of the NOC reason.

By default, the **Clearing Staging Upload Reasons** zone does not appear in the **Automatic Payment and Refund Clearing Staging** screen. It appears when you click the **Broadcast** (📡) icon corresponding to the clearing staging record in the **Associated Clearing Staging Records** zone.

Related Topics

For more information on...	See...
How to view the upload reason specified in the clearing staging record	Viewing the Upload Reason Specified in the Clearing Staging Record on page 1306

Clearing Staging Characteristics

The **Clearing Staging Characteristics** zone lists the characteristics of the automatic payment or refund clearing staging record. It contains the following columns:

Column Name	Column Description
Clearing Staging ID	Displays the clearing staging ID.
Clearing ID	Indicates the clearing record against which the clearing staging record is added.
Characteristic Type	Indicates the characteristic type.
Characteristic Value	Displays the characteristic value.

By default, the **Clearing Staging Characteristics** zone does not appear in the **Automatic Payment and Refund Clearing Staging** screen. It appears when you click the **Broadcast** () icon corresponding to the clearing staging record in the **Associated Clearing Staging Records** zone.

Related Topics

For more information on...	See...
How to view the characteristics of the clearing staging record	Viewing the Characteristics of the Clearing Staging Record on page 1307

Searching for a Clearing Record

Procedure

To search for a clearing record:

1. Click the **Menu** link in the **Application** toolbar.
A list appears.
2. From the **Main** menu, select **Payments** and then click **Automatic Payment and Refund Clearing Staging**.
The **Automatic Payment and Refund Clearing Staging** screen appears.
3. Enter the search criteria in the **Search Clearing Record** zone depending on whether you want to search for automatic payment or refund clearing records.

Note: ORMB search engine supports wildcard search, where you can substitute the percentage (%) symbol as a stand in for any word or letter in a search criteria. You can use the ‘%’ wildcard character in all input fields except the date and ID fields. The ‘%’ wildcard character is suffixed automatically at the end of the partial search criteria. Therefore, you may or may not specify the wildcard character at the end of the partial search criteria. However, you have to prefix the wildcard character manually wherever required.

4. Click **Search**.
A list of clearing records that meet the search criteria appears in the **Search Results** section.

Related Topics

For more information on...	See...
Automatic Payment and Refund Clearing Staging screen	Automatic Payment and Refund Clearing Staging on page 1301
Search Clearing Record zone	Search Clearing Record on page 1301

Viewing the Clearing Staging Records Associated to a Clearing Record

Procedure

To view the clearing staging records associated to a clearing record:

1. Search for the clearing record in the **Automatic Payment and Refund Clearing Staging** screen.
2. In the **Search Results** section, click the **Broadcast** () icon corresponding to the clearing record whose associated clearing staging records you want to view.
The **Associated Clearing Staging Records** zone appears.
3. View the details of the clearing staging records in the **Associated Clearing Staging Records** zone.



Related Topics

For more information on...	See...
How to search for a clearing record	Searching for a Clearing Record on page 1305
Associated Clearing Staging Records zone	Associated Clearing Staging Records on page 1303

Viewing the Upload Reason Specified in the Clearing Staging Record

Procedure

To view the upload reason specified in the clearing staging record:

1. Search for the clearing record in the **Automatic Payment and Refund Clearing Staging** screen.
2. In the **Search Results** section, click the **Broadcast** () icon corresponding to the clearing record whose associated clearing staging records you want to view.
The **Associated Clearing Staging Records** zone appears.
3. In the **Associated Clearing Staging Records** zone, click the **Broadcast** () icon corresponding to the clearing staging record whose details you want to view.
The **Clearing Staging Upload Reasons** and **Clearing Staging Characteristics** zones appear.
4. View the reason and error codes specified in the clearing staging record in the **Clearing Staging Upload Reasons** zone.

Related Topics

For more information on...	See...
How to search for a clearing record	Searching for a Clearing Record on page 1305
Associated Clearing Staging Records zone	Associated Clearing Staging Records on page 1303

For more information on...	See...
Clearing Staging Upload Reasons zone	Clearing Staging Upload Reasons on page 1304

Viewing the Characteristics of the Clearing Staging Record

Procedure

To view the characteristics of the clearing staging record:

1. Search for the clearing record in the **Automatic Payment and Refund Clearing Staging** screen.
2. In the **Search Results** section, click the **Broadcast** (📡) icon corresponding to the clearing record whose associated clearing staging records you want to view.

The **Associated Clearing Staging Records** zone appears.

3. In the **Associated Clearing Staging Records** zone, click the **Broadcast** (📡) icon corresponding to the clearing staging record whose details you want to view.

The **Clearing Staging Upload Reasons** and **Clearing Staging Characteristics** zones appear.

4. View the characteristics of the clearing staging record in the **Clearing Staging Characteristics** zone.

Related Topics

For more information on...	See...
How to search for a clearing record	Searching for a Clearing Record on page 1305
Associated Clearing Staging Records zone	Associated Clearing Staging Records on page 1303
Clearing Staging Characteristics zone	Clearing Staging Characteristics on page 1305

Editing a Clearing Staging Record

Prerequisites

To edit a clearing staging record, you should have:

- Upload reasons defined in the application
- NOC reasons defined in the **APAY_UPL_NOC_LOOKUP** lookup field.
- Payment cancelation reasons defined in the application
- Reasons defined for the **Voided** status of the **C1-RefundReq** business object in the **Status Reason** screen

Note: You can edit a clearing staging record when it is in the **Pending** or **Error** status. On editing a clearing staging record which is in the **Error** status, the status of the clearing staging record is changed to **Pending**. Also, the exceptions logged for the clearing staging record are deleted from the **CI_APAY_STGUP_EXC** table.

Procedure

To edit a clearing staging record:

1. Search for the clearing record in the **Automatic Payment and Refund Clearing Staging** screen.
2. In the **Search Results** section, click the **Broadcast** (📡) icon corresponding to the clearing record whose associated clearing staging record you want to edit.

The **Associated Clearing Staging Records** zone appears.

- In the **Associated Clearing Staging Records** zone, click the **Edit** (✎) icon in the **Edit** column corresponding to the clearing staging record whose details you want to edit.

The **Edit Clearing Staging Record** screen appears. It contains the following fields:

Field Name	Field Description	Mandatory (Yes or No)
Clearing Staging ID	Displays the clearing staging ID.	Not applicable
Clearing ID	Indicates the clearing record against which the clearing staging record is added.	Not applicable
Status	Indicates the status of the clearing staging record. The valid values are: <ul style="list-style-type: none"> Pending Complete Error 	Not applicable
Upload Date	Used to specify the date when the clearing staging record was uploaded or added in the system.	Yes

In addition, this screen contains the following two sections:

- Upload Reasons** — Used to add, edit, or remove the reason code (i.e. upload reason) and error (sub reason) codes from the clearing staging record. It contains the following fields in a grid:

Field Name	Field Description	Mandatory (Yes or No)
Upload Reason	Used to specify the upload reason. It indicates whether the auto clearing house has accepted or rejected the clearing record.	Yes
Reason Type	Used to indicate the type of upload reason. The valid values are: <ul style="list-style-type: none"> Cancel Success 	Yes
Sub Reason Code	Used to specify either of the following: <ul style="list-style-type: none"> Payment cancelation reason or void status reason (for automatic refund) when the reason type is set to Cancel Notice to Change (NOC) reason when the reason type is set to Success 	No
Sub Reason Description	Used to specify the description of the NOC reason.	No

Note: The upload reason, payment cancelation reason, void status reason, and NOC reasons must be already defined in the system. If you specify an invalid reason and sub reason codes, the status of the clearing staging record is changed to **Error** when you execute the **Freeze or Cancel Automatic Payments (APAYRA)** or **Cancel Automatic Refunds (AREFRA)** batch.

- Characteristics** — Used to define the characteristics for the clearing staging record.

4. Modify the required details in the **Edit Clearing Staging Record** screen.

Note: If you want to add more than one reason or sub reason code, click the **Add (+)** icon in the **Upload Reasons** section and then specify the required details. However, if you want to remove a reason or sub reason code, click the **Delete (🗑)** icon corresponding to the reason.

5. Define characteristics for the clearing staging record, if required.

6. Click **Save**.

The changes made to the clearing staging record are saved.

Related Topics

For more information on...	See...
How to search for a clearing record	Searching for a Clearing Record on page 1305
Associated Clearing Staging Records zone	Associated Clearing Staging Records on page 1303
How to define a characteristic for a clearing staging record	Defining a Characteristic for a Clearing Staging Record on page 1309

Defining a Characteristic for a Clearing Staging Record

Prerequisites

To define a characteristic for a clearing staging record, you should have:

- Characteristic types defined in the application (where the characteristic entity is set to **Auto Payment Upload**)

Procedure

To define a characteristic for a clearing staging record:

1. Ensure that the **Characteristics** section is expanded when you are editing a clearing staging record.

The **Characteristics** section contains the following fields in a grid:

Field Name	Field Description	Mandatory (Yes or No)
Effective Date	Used to specify the date from when the characteristic is effective for the clearing staging record.	Yes (Conditional)
		Note: This field is required when you are defining a characteristic for the clearing staging record.
Characteristic Type	Used to indicate the characteristic type. Note: The list includes only those characteristic types where the characteristic entity is set to Auto Payment Upload .	Yes (Conditional)
		Note: This field is required when you are defining a characteristic for the clearing staging record.
Characteristic Value	Used to specify the value for the characteristic type. Note: On specifying the value for a predefined characteristic type, the description of the characteristic value appears corresponding to the Characteristic Value field.	Yes (Conditional)
		Note: This field is required when you are defining a characteristic for the clearing staging record.

2. Enter the required details in the **Characteristics** section.

Note: If you select a predefined characteristic type, the **Search** (🔍) icon appears corresponding to the **Characteristic Value** field. On clicking the **Search** icon, you can search for a predefined characteristic value.

- If you want to define more than one characteristic for the clearing staging record, click the **Add** (+) icon and then repeat step 2.

Note: However, if you want to remove a characteristic from the clearing staging record, click the **Delete** (🗑️) icon corresponding to the characteristic.

Related Topics

For more information on...	See...
How to edit a clearing staging record	Editing a Clearing Staging Record on page 1307

Deleting a Clearing Staging Record

Procedure

To delete a clearing staging record:

- Search for the clearing record in the **Automatic Payment and Refund Clearing Staging** screen.
- In the **Search Results** section, click the **Broadcast** (📡) icon corresponding to the clearing record whose associated clearing staging record you want to delete.

The **Associated Clearing Staging Records** zone appears.

- In the **Associated Clearing Staging Records** zone, click the **Delete** (🗑️) icon in the **Delete** column corresponding to the clearing staging record that you want to delete.

A message appears confirming whether you want to delete the clearing staging record.

Note: You can delete a clearing staging record when it is in the **Pending** status.

- Click **OK**.

The clearing staging record is deleted.

Related Topics

For more information on...	See...
How to search for a clearing record	Searching for a Clearing Record on page 1305
Associated Clearing Staging Records zone	Associated Clearing Staging Records on page 1303

Chapter 15

Construct

Topics:

- [Prerequisites](#)
- [Construct Status Transition](#)
- [Template](#)
- [Construct \(Used for Searching\)](#)
- [Construct \(Used for Viewing\)](#)
- [Billing and Settlement Hierarchy](#)

Oracle Revenue Management and Billing provides you with a flexible way to define the billing hierarchy using the construct based billing feature. In a construct, you can include:

- **Usage Accounts** - A set of usage accounts of different persons whose charges and/or adjustments must be billed through an invoice account. These persons need not belong to the same person hierarchy. The system allows you to select a set of usage accounts based on the criteria using the account selection template. The persons' and their child persons' usage accounts that meet the specified criteria are included in the construct.
- **Billable Charges** - A set of billable charges that you want to bill through an invoice account. The system will only consider billable charges of those usage accounts for which the construct is defined. The system allows you to select a set of billable charges based on the criteria using the billable charge selection template.
- **Adjustments** - A set of adjustments that you want to bill through an invoice account. The system will only consider adjustments of those usage accounts for which the construct is defined. The system allows you to select a set of adjustments based on the criteria using the adjustment selection template.

You can bill the charges and adjustments of usage accounts on the same invoice account. Or, you can bill the charges of usage accounts on one invoice account and the adjustments on another invoice account. Or, you can bill the charges or adjustments of the usage accounts on more than one invoice account. You can define different types of constructs. At present, the system supports only invoice and settlement construct. Here, settlement includes receivables and payables.

One usage account can belong to only one active construct and not to multiple active constructs at the same time. The system also allows you to exclude some usage accounts when you do not want to include all usage accounts that satisfy the criteria in the construct. While defining a construct, you can use an existing invoice account. The contracts for the invoice account are created when you activate the construct. One contract is created for every target contract type set on usage accounts' contracts' contract type.

You can use a construct during the construct based billing process when the construct is in the **Active** status. The following batches are designed to support the construct based billing process:

- **Construct Based - Pending Bill Generation (BILLOPEN)** – This batch is used to generate pending bills for accounts that meet the criteria.
- **Construct Based - Bill Segment Generation (BSGENREG)** – This batch is used to generate the bill segments on the pending bills.

- **Construct Based - Bill Completion (POSTPROC)** – This batch is used to generate post processing bill segments during the bill completion process. It changes the status of the bill to **Complete**.

During the bill generation process, all accounts that meet the criteria are considered for billing. These accounts may be usage or invoice accounts. All billable charges (with the **Adhoc** flag set to **No**) whose start date is earlier than or equal to the batch business date are considered during bill segment generation. If a billable charge satisfies the rule defined on any active construct, the bill segment is generated on the respective invoice account. And, if a billable charge does not satisfy the rule defined on any active construct, the bill segment is generated on the usage account. The post-processing bill segments, if any, are generated on the invoice or usage account depending on the type of price assignment.

Note: The construct based billing batches are currently not designed to consider billable charges whose end date is earlier than or equal to the batch business date.

For more information on how to setup the construct based billing process, refer to [Prerequisites](#) on page 1313.

Prerequisites

To setup the construct based billing process, you need to do the following:

- Define the Target Contract Type characteristic for usage accounts' contracts' contract type.
- Set the **C1-INCT** feature configuration.
- Create a default account creation algorithm using the C1-ACTCR-IC algorithm type.
- Create a default contract creation algorithm using the C1-CTMP-IC algorithm type.
- Create a usage account construct mapping algorithm using the C1-UACM-IC algorithm type.
- Associate the usage account construct mapping algorithm to a division whose usage accounts you want to include in any existing active construct.

Note: There might be situations when a usage account is created after the construct is activated. If you want to include such usage account in any existing active construct, you need to associate the usage account construct mapping algorithm to a division in which you are creating the usage account. If the usage account satisfies the criteria specified in any active construct, it is included in the construct once the usage account is created.

- Define the required templates, profiles and constructs in the application.
- Define values for the PAGE_NUMBER lookup field.
- Define approval workflow group, approval workflow chain, approval workflow criteria, and approval workflow group chain linkage for construct.
- Configure the approval workflow settings for construct.
- Define approval workflow reasons which are required while rejecting a construct.
- Assign the **C1-IC_AC** To Do type to a To Do role whose users must receive the To Do entries generated when the new invoice account is created while activating a construct.
- Transfer adjustments algorithm defined using the **C1-IC-AD-XFR** algorithm type.
- Define an algorithm of the BS-CRE-INVCN algorithm type and attach it on the **Create Algorithm** spot of the bill segment type.

Note: If you want to use the regular billing process, you need to attach an algorithm of the BS-CRE-PRICE algorithm type on the **Create Algorithm** spot of the bill segment type. However, if you want to use the construct based billing process, you need to attach an algorithm of the BS-CRE-INVCN algorithm type on **Create Algorithm** spot of the bill segment type.

Related Topics

For more information on...	See...
How to set the C1-INCT feature configuration	Setting the C1-INCT Feature Configuration on page 4329

Construct Status Transition

The following figure graphically indicates how a construct moves from one status to another during its lifecycle:

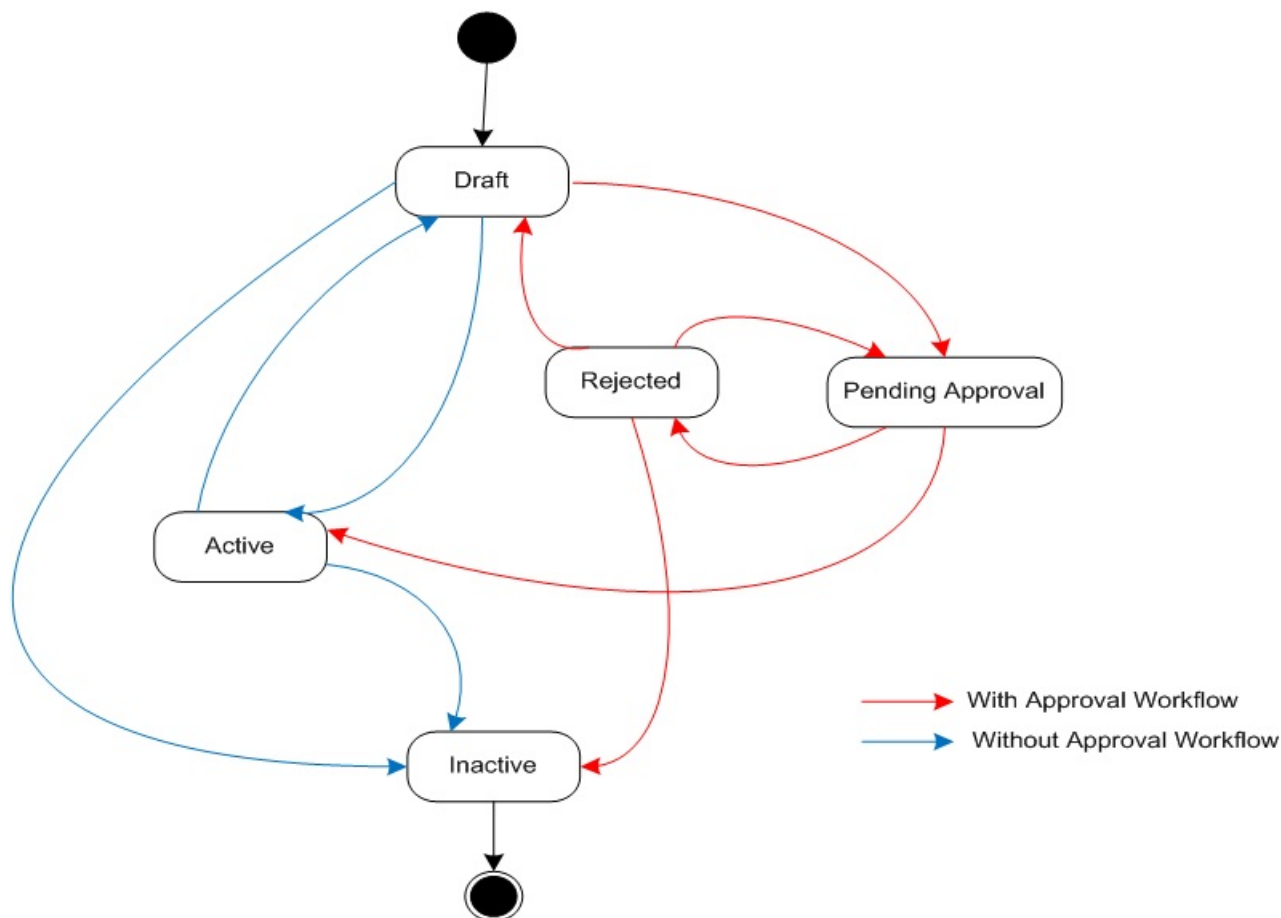

Template

Template is used to select a set of usage accounts, billable charges, or adjustments based on the criteria. In a template, you can define a SELECT statement to retrieve data from a table or view based on a condition. You can use the bind variables in the where clause (condition). The bind variables must be alphanumeric and prefixed with the colon (:). The values for these bind variables are specified while defining a construct.

You can validate the syntax of the SELECT statement. If the syntax of the SELECT statement is correct, a message appears indicating that the SQL statement was validated successfully. However, if the syntax of the SELECT statement is incorrect, an error message occurs. You need to then correct the SELECT statement accordingly. Otherwise, the system will not allow you to save the template.

You can define the following three types of templates:

- **Account Selection** - Used for selecting a set of usage accounts based on the criteria.
- **Adjustment Selection** - Used for selecting a set of adjustments based on the criteria.
- **Billable Charge Selection** - Used for selecting a set of billable charges based on the criteria.

You can only use templates which are active while defining or editing a construct. The **Template** screen allows you to define, edit, and delete a template. You can edit a template even if it is used in any construct. However, any changes made to a template will not be reflected in a construct where the template is already used unless you use the latest template in the construct. This screen consists of the following zones:

- [Search Template](#) on page 1315

Search Template

The **Search Template** zone allows you to search for a template using various search criteria. This zone contains the following two sections:

- **Search Criteria** - Used to search by different search criteria. It contains the following fields:

Field Name	Field Description	Mandatory (Yes or No)
Template	Used to specify the template name.	No
Description	Used to specify the description for the template.	No
Purpose	Used to indicate the purpose of the template. The valid values are: <ul style="list-style-type: none"> • Adjustment Selection - Used for selecting a set of adjustments based on the criteria. • Bill Segment Selection - Used for selecting a set of bill segments based on the criteria. • Billable Charge Selection - Used for selecting a set of billable charges based on the criteria. • Usage Account Selection - Used for selecting a set of usage accounts based on the criteria. • Usage and Invoice Account Selection - Used for selecting a set of usage and invoice accounts based on the criteria. 	No
Status	Used to indicate the status of the template. The valid values are: <ul style="list-style-type: none"> • Active • Inactive 	No

Note: You must specify at least one search criterion while searching for a template.

- **Search Results** - On clicking the **Search** button, the search results appear based on the specified search criteria. The **Search Results** section contains the following columns:

Column Name	Column Description
Template	Displays the name of the template.
Description	Displays the description of the template.
Purpose	Indicates the purpose of the template. The valid values are: <ul style="list-style-type: none"> • Adjustment Selection • Billable Segment Selection • Billable Charge Selection • Usage Account Selection • Usage and Invoice Account Selection
Status	Indicates the status of the template. The valid values are: <ul style="list-style-type: none"> • Active

Column Name	Column Description
	<ul style="list-style-type: none"> Inactive
View	On clicking the View (🔗) icon, the View Template screen appears where you can view the details of the template.
Edit	On clicking the Edit (✎) icon, the Template screen appears where you can edit the details of the template.
	Note: If a template is used in any construct, a message appears confirming whether you want to edit the template.

You can create a new template by clicking the **Add** button in the upper right corner of this zone.

Related Topics

For more information on...	See...
How to search for a template	Searching for a Template on page 1316
How to define a template	Defining a Template on page 1317
How to edit a template	Editing a Template on page 1319
How to view the details of a template	Viewing the Template Details on page 1322
How to delete a template	Deleting a Template on page 1322

Searching for a Template

Procedure

To search for a template:

1. Click the **Admin** link in the **Application** toolbar.
A list appears.
2. From the **Admin** menu, select **T** and then click **Template**.
The **Template** screen appears.
3. Enter the search criteria in the **Search Template** zone.

Note: ORMB search engine supports wildcard search, where you can substitute the percentage (%) symbol as a stand in for any word or letter in a search criteria. You can use the ‘%’ wildcard character in all input fields except the date and ID fields. The ‘%’ wildcard character is suffixed automatically at the end of the partial search criteria. Therefore, you may or may not specify the wildcard character at the end of the partial search criteria. However, you have to prefix the wildcard character manually wherever required.

4. Click **Search**.
A list of templates that meet the search criteria appears in the **Search Results** section.

Related Topics

For more information on...	See...
Template screen	Template on page 1314
Search Template zone	Search Template on page 1315

Defining a Template

Procedure

To define a template:

1. Click the **Admin** link in the **Application** toolbar.
A list appears.
2. From the **Admin** menu, select **T** and then click **Template**.
A sub-menu appears.
3. Click the **Add** option from the **Template** sub-menu.

The **Template** screen appears. It consists of the following zone:

- **Search Template** — Used to specify basic details about the template. It consists of the following fields:

Field Name	Field Description	Mandatory (Yes or No)
Template	Used to specify the template name.	Yes
Description	Used to search for a template by it's description.	Yes
Purpose	Used to indicate the purpose of the template. The valid values are: <ul style="list-style-type: none"> • Adjustment Selection - Used for selecting a set of adjustments based on the criteria. • Bill Segment Selection - Used for selecting a set of bill segments based on the criteria. • Billable Charge Selection - Used for selecting a set of billable charges based on the criteria. • Usage Account Selection - Used for selecting a set of usage accounts based on the criteria. • Usage and Invoice Account Selection - Used for selecting a set of usage and invoice accounts based on the criteria. 	Yes
Status	Used to specify additional information about the template.	Yes

In addition, this tab contains the **Bind Variables** section where you can define the bind variables which are used in the where clause. The **Bind Variables** section contains the following fields:

Field Name	Field Description	Mandatory (Yes or No)
Bind Variable	Used to specify the bind variable (which is used in the where clause).	Yes (Conditional) Note: This field is required when you are defining a bind variable.
Data Type	Used to indicate the type of data that you want to store in the bind variable. The valid values are: <ul style="list-style-type: none"> • Date • Numeric 	Yes (Conditional) Note: This field is required when you are defining a bind variable.

Field Name	Field Description	Mandatory (Yes or No)
	<ul style="list-style-type: none"> String 	
Label	Used to specify the business label for the bind variable. The business label appears when you define and edit the criteria for selecting a set of usage accounts, adjustments, or billable charges.	Yes (Conditional) Note: This field is required when you are defining a bind variable.
Zone	Used to specify the zone for the template. Note: The Search (🔍) icon appears corresponding to this field. On clicking the Search icon, the Zone/Code Description window appears.	Yes (Conditional) Note: This field is required when you are defining a bind variable.

- Enter the required details in the **Main** tab.
- If you want to define more than one bind variable, click the **Add** (+) icon in the **Bind Variables** section and then enter the required details.

Note: However, if you want to remove a bind variable from the **Bind Variables** section, click the **Delete** (🗑️) icon corresponding to the bind variable.

- If required, click **Validate** to validate the syntax of the SELECT statement.

Note: If the syntax of the SELECT statement is correct, a message appears indicating that the SQL statement was validated successfully. However, if the syntax of the SELECT statement is incorrect, an error message occurs. You need to then correct the SELECT statement accordingly. Otherwise, the system will not allow you to save the template.

- Define characteristics for the template, if required.
- Click **Validate and Save**.

The system validates the syntax of the SELECT statement and then accordingly saves the template.

Related Topics

For more information on...	See...
Template screen	Template on page 1314
Search Template zone	Search Template on page 1315
How to define a characteristic for a template	Defining a Characteristic for a Template on page 1318

Defining a Characteristic for a Template

Prerequisites

To define a characteristic for a template, you should have:

- Characteristic types defined in the application (where the characteristic entity is set to Template)

Procedure

To define a characteristic for a template:

- Click the **Characteristics** tab in the **Template** screen when you are creating or editing a template.

The **Characteristics** tab appears. It contains the following fields:

Field Name	Field Description	Mandatory (Yes or No)
Effective Date	Used to specify the date from when the characteristic is effective for the template.	Yes (Conditional) Note: This field is required when you are defining a characteristic for the template.
Characteristic Type	Used to indicate the characteristic type.	Yes (Conditional) Note: This field is required when you are defining a characteristic for the template.
Characteristic Value	Used to specify the value for the characteristic type. Note: On specifying the value for a predefined characteristic type, the description of the characteristic value appears corresponding to the Characteristic Value field.	Yes (Conditional) Note: This field is required when you are defining a characteristic for the template.

- Enter the required details.
- If you want to define more than one characteristic for the template, click the **Add (+)** icon and then repeat step 2.

Note: However, if you want to remove a characteristic from the template, click the **Delete** (🗑️) icon corresponding to the characteristic.

- Click **Validate and Save**.

The characteristics are defined for the template.

Related Topics

For more information on...	See...
How to define a template	Defining a Template on page 1317
How to edit a template	Editing a Template on page 1319

Editing a Template

Procedure

To edit a template:

- Click the **Admin** link in the **Application** toolbar.
A list appears.
- From the **Admin** menu, select **T** and then click **Template**.
The **Template** screen appears.
- In the **Search Results** section, click the **Edit** (✎) icon in the **Edit** column corresponding to the template whose details you want to edit.

Note: If a template is used in any construct, a message appears confirming whether you want to edit the template. You must click **OK** if you want to edit the template. Any changes made to a template will not be reflected in any construct where the template is already used unless you use the latest template in the construct.

The **Template** screen appears. It consists of the following tabs:

- **Main** - Used to specify basic details about the template.
- **Characteristics** - Used to define the characteristics for the template.

The **Main** tab contains the following fields:

Field Name	Field Description	Mandatory (Yes or No)								
Template	Used to indicate the template name.	Not applicable								
Description	Used to specify the description for the template.	Yes								
Detailed Description	Used to specify additional information about the template.	No								
Purpose	Used to indicate the purpose of the template. The valid values are: <ul style="list-style-type: none"> • Account Selection - Used for selecting a set of usage accounts based on the criteria. • Adjustment Selection - Used for selecting a set of adjustments based on the criteria. • Billable Charge Selection - Used for selecting a set of billable charges based on the criteria. • Usage Account Selection - Used for selecting a set of usage accounts based on the criteria. • Usage and Invoice Account Selection - Used for selecting a set of usage and invoice accounts based on the criteria. 	Yes								
Status	Used to indicate the status of the template. The valid values are: <ul style="list-style-type: none"> • Active • Inactive 	Yes								
Select	Used to specify the column name. It indicates the data that you want to retrieve using the SELECT statement. The default value appears in this field when you select the purpose of the template. However, the default value changes depending on the purpose of template. You can edit the column name whenever required. <table border="1" data-bbox="548 1621 1156 1885"> <thead> <tr> <th>If you have set the purpose of the template to....</th> <th>Then, the default value is...</th> </tr> </thead> <tbody> <tr> <td>Account Selection</td> <td>ACCT_ID</td> </tr> <tr> <td>Adjustment Selection</td> <td>ADJ_ID</td> </tr> <tr> <td>Billable Charge Selection</td> <td>BILLABLE_CHG_ID</td> </tr> </tbody> </table>	If you have set the purpose of the template to....	Then, the default value is...	Account Selection	ACCT_ID	Adjustment Selection	ADJ_ID	Billable Charge Selection	BILLABLE_CHG_ID	Yes
If you have set the purpose of the template to....	Then, the default value is...									
Account Selection	ACCT_ID									
Adjustment Selection	ADJ_ID									
Billable Charge Selection	BILLABLE_CHG_ID									

Field Name	Field Description	Mandatory (Yes or No)
From	Used to specify the table or view name. It indicates the table or view from which you want to retrieve the data.	Yes
Where	Used to specify the condition based on which you want to retrieve the data from the table or view. You can use the bind variables in the where clause using the following syntax: <pre>{column_name} {operator} : {bind_variable}</pre> <p>The bind variables must be alphanumeric and prefixed with the colon (:). There should not be any space between the column name, operator, and the bind variable. For example, CURRENCY_CD=:CURRENCY. All bind variables used in the where clause must be defined in the Bind Variables section.</p>	No

In addition, this tab contains the **Bind Variables** section where you can define the bind variables which are used in the where clause. The **Bind Variables** section contains the following fields:

Field Name	Field Description	Mandatory (Yes or No)
Bind Variable	Used to specify the bind variable (which is used in the where clause).	Yes (Conditional)
		Note: This field is required when you are defining a bind variable.
Data Type	Used to indicate the type of data that you want to store in the bind variable. The valid values are: <ul style="list-style-type: none"> • Date • Numeric • String 	Yes (Conditional)
		Note: This field is required when you are defining a bind variable.
Label	Used to specify the business label for the bind variable. The business label appears when you define and edit the criteria for selecting a set of usage accounts, adjustments, or billable charges.	Yes (Conditional)
		Note: This field is required when you are defining a bind variable.
Zone	Used to indicate a zone for the template.	Yes (Conditional)
	Note: The Search (🔍) icon appears corresponding to this field. On clicking the Search icon, the Zone/Code Description window appears.	Note: This field is required when you are defining a bind variable.

4. Modify the details in the **Main** tab, if required.
5. If you want to define more than one bind variable, click the **Add** (+) icon in the **Bind Variables** section and then enter the required details.

Note: However, if you want to remove a bind variable from the **Bind Variables** section, click the **Delete** (🗑️) icon corresponding to the bind variable.

- If required, click **Validate** to validate the syntax of the SELECT statement.

Note: If the syntax of the SELECT statement is correct, a message appears indicating that the SQL statement was validated successfully. However, if the syntax of the SELECT statement is incorrect, an error message occurs. You need to then correct the SELECT statement accordingly. Otherwise, the system will not allow you to save the template.

- Define, edit or remove characteristics of the template, if required.
- Click **Validate and Save**.

The system validates the syntax of the SELECT statement and then accordingly saves the changes [Defining a Characteristic for a Template](#) on page 1318 made to the template.

Related Topics

For more information on...	See...
How to search for a template	Searching for a Template on page 1316
How to define a characteristic for a template	Defining a Characteristic for a Template on page 1318

Deleting a Template

Procedure

To delete a template:

- Click the **Admin** link in the **Application** toolbar.
A list appears.
- From the **Admin** menu, select **T** and then click **Template**.
The **Template** screen appears.
- In the **Search Results** section, click the **Delete** (🗑️) icon in the **Delete** column corresponding to the template that you want to delete.
A message appears confirming whether you want to delete the template.

Note: You can only delete a template which is not yet used in any construct.

- Click **OK**.
The template is deleted.

Related Topics

For more information on...	See...
How to search for a template	Searching for a Template on page 1316

Viewing the Template Details

Procedure

To view the details of a template:

- Search for the template in the **Template** screen.
- In the **Search Results** section, click the **View** (🔗) icon in the **View** column corresponding to the template whose details you want to view.

The **View Template** screen appears.

3. View the basic details of the template in the **Main** tab.
4. View the characteristics of the template in the **Characteristics** tab.

Related Topics

For more information on...	See...
How to search for a template	Searching for a Template on page 1316

Construct (Used for Searching)

The **Construct** screen allows you to search for a construct using various search criteria. Through this screen, you can define, edit, view, copy, inactivate a construct. It contains the following zones:

- [Search Construct](#) on page 1323

Search Construct

The **Search Construct** zone allows you to search for a construct using various search criteria. It contains the following two sections:





- **Search Criteria** - The **Search Criteria** section contains the following fields:

Field Name	Field Description	Mandatory (Yes or No)
Construct ID	Used to specify the construct ID.	No
Description	Used to specify the description for the construct.	No
Construct Type	Used to indicate the type of the construct. The valid values are: <ul style="list-style-type: none"> • Invoice Only • Invoice and Settlement • Settlement Only 	No
Status	Used to indicate the status of the construct. The valid values are: <ul style="list-style-type: none"> • Active • Draft • Inactive • Pending Approval • Rejected 	No
Effective Start Date	Used to specify the date from when the construct is effective.	No
Effective End Date	Used to specify the date till when the construct is effective.	No
Usage Account Identifier Type	Used to indicate the usage account's identifier type based on which you want to search for a construct.	No

Field Name	Field Description	Mandatory (Yes or No)
	Note: This field appears when you select the Invoice Only or Invoice and Settlement option from the Construct Type list.	
Usage or Invoice Account Identifier Type	Used to indicate the usage or invoice account's identifier type based on which you want to search for a construct. Note: This field appears when you select the Settlement Only option from the Construct Type list.	No
Usage Account Identifier	Used to indicate the usage account which belongs to the construct. Note: This field appears when you select the Invoice Only or Invoice and Settlement option from the Construct Type list.	No
Usage or Invoice Account Identifier	Used to indicate the usage or invoice account which belongs to the construct. Note: This field appears when you select the Settlement Only option from the Construct Type list.	No
Invoice Account Identifier Type	Used to indicate the invoice account's identifier type based on which you want to search for a construct. Note: This field appears when you select the Invoice Only or Invoice and Settlement option from the Construct Type list.	No
Settlement Account Identifier Type	Used to indicate the settlement account's identifier type based on which you want to search for a construct. Note: This field appears when you select the Settlement Only option from the Purpose list.	No
Invoice Account Identifier	Used to indicate the invoice account which is used in the construct. Note: This field appears when you select the Invoice Only or Invoice and Settlement option from the Construct Type list.	No
Settlement Account Identifier	Used to indicate the settlement account which is used in the construct. Note: This field appears when you select the Settlement Only option from the Construct Type list.	No

Note: You must specify at least one search criterion while searching for a construct.

- **Search Results** — On clicking the **Search** button, the search results appear based on the specified search criteria. The **Search Results** section contains the following columns:

Column Name	Column Description
Construct ID	Displays the construct ID.
Description	Displays the description of the construct.
Construct Type	Indicates the purpose of the construct. The valid values are: <ul style="list-style-type: none"> • Invoice Only • Invoice and Settlement • Settlement Only
Effective Start Date	Displays the date from when the construct is effective.
Effective End Date	Displays the date till when the construct is effective.
Status	Indicates the status of the construct. The valid values are: <ul style="list-style-type: none"> • Active • Draft • Inactive • Pending Approval • Rejected
Copy	On clicking the Copy () icon, the Construct screen appears where you can create a construct using an existing construct.
View	On clicking the View () icon, the Construct screen appears where you can view the details of the construct.
Edit	On clicking the Edit () icon, the Construct screen appears where you can edit the details of the construct.
Inactivate	On clicking the Inactivate icon () in the Inactivate column, the Inactivate window appears confirming whether you want to inactivate the selected construct. <p>Note: You can only inactivate the construct which is in Active status. The Inactivate icon appears in the Inactivate column, only in front of the construct which is in Active status.</p>

You can create a new construct by clicking the **Add** button in the upper right corner of the **Construct** screen.

Related Topics

For more information on...	See...
How to search for a construct	Searching for a Construct on page 1325
How to define a construct	Defining a Construct on page 1326
How to edit a construct	Editing a Construct on page 1329
How to copy a construct	Copying a Construct on page 1332
How to view the details of a construct	Viewing the Construct Details on page 1333

Searching for a Construct

Procedure

To search for a construct:

1. Click the **Menu** link in the **Application** toolbar.
A list appears.
2. From the **Main** menu, select the **Billing Management** and then click **Construct**.
A sub-menu appears.
3. Click the **Search** option from the **Construct** sub-menu.
The **Construct** screen appears.
4. Enter the search criteria in the **Search Construct** zone.

Note: ORMB search engine supports wildcard search, where you can substitute the percentage (%) symbol as a stand in for any word or letter in a search criteria. You can use the ‘%’ wildcard character in all input fields except the date and ID fields. The ‘%’ wildcard character is suffixed automatically at the end of the partial search criteria. Therefore, you may or may not specify the wildcard character at the end of the partial search criteria. However, you have to prefix the wildcard character manually wherever required.

5. Click **Search**.
A list of constructs that meet the search criteria appears in the **Search Results** section.

Related Topics

For more information on...	See...
Construct screen	Construct (Used for Viewing) on page 1334
Search Construct zone	Search Construct on page 1323

Defining a Construct**Procedure**

To define a construct:

1. Click the **Menu** link in the **Application** toolbar.
A list appears.
2. From the **Main** menu, select **Billing Management** and then click **Construct**.
A sub-menu appears.
3. Click the **Add** option from the **Construct** sub-menu.

The **Construct** screen appears. It consists of the following sections:

- **Main** — Used to specify basic details about the construct.
- **Characteristics** — Used to define the characteristics for the construct.

The **Main** section contains the following fields:

Field Name	Field Description	Mandatory (Yes or No)
Construct Description	Used to specify the description for the construct.	Yes

Field Name	Field Description	Mandatory (Yes or No)
Construct Type	Used to indicate the type of the construct. The valid values are: <ul style="list-style-type: none"> • Invoice — Indicates that you want to use the construct for billing. • Invoice and Settlement — Indicates that you want to use the construct for billing and settlement. • Settlement — Indicates that you want to use the construct for settlement. 	Yes
	Note: Here, settlement includes receivables and payables	
Status	Used to indicate the status of the construct. By default, the Draft option is selected from the list.	Not applicable
Effective Start Date	Used to specify the date from when the construct is effective.	Yes
	Note: The effective from date cannot be later than the effective end date.	
Effective End Date	Used to specify the date till when the construct is effective.	No
	Note: The effective to date cannot be earlier than the effective start date.	

Tip: Alternatively, you can access the **Construct** screen by clicking the **Add** button on the top-right of the **Construct** screen.

4. Enter the required details in the **Main** section.
5. Define characteristics for the construct, if required.
6. Do either of the following:

If you want to...	Then...
Save the construct in the draft version	<ol style="list-style-type: none"> 1. Click Save as Draft. <p>The construct is created and the status of the construct is set to Draft. The construct ID is generated automatically when the construct is created.</p>
Activate the construct	<ol style="list-style-type: none"> 1. Click Activate. <p>The construct is created and the status of the construct is set to Active. The construct ID is generated automatically when the construct is created.</p> <p>Note: The Activate button appears while defining a construct when the approval workflow process is not configured for construct.</p>

If you want to...	Then...
Send the construct for approval	<p>1. Click Send for Approval.</p> <p>The construct is created and the approval workflow request is raised for the construct. The status of the construct is set to Pending Approval. In addition, the construct ID is generated automatically when the construct is created.</p>
	<p>Note: The Send for Approval button appears while defining a construct when the approval workflow process is configured for construct.</p>

Related Topics

For more information on...	See...
Construct (Used for Viewing) screen	Construct (Used for Viewing) on page 1334
Search Construct zone	Search Construct on page 1323
How to include usage accounts in a construct	Including Usage Accounts in a Construct on page 1340
How to exclude usage accounts from a construct	Excluding Usage Accounts from a Construct on page 1342
How to include billable charges in a construct	Including Billable Charges in a Construct on page 1344
How to include adjustments in a construct	Including Billable Charges in a Construct on page 1344
How to define a characteristic for a construct	Defining a Characteristic for a Construct on page 1328

Defining a Characteristic for a Construct

Prerequisites

To define a characteristic for a construct, you should have:

- Characteristic types defined in the application (where the characteristic entity is set to Construct)

Procedure

To define a characteristic for a construct:

1. Ensure that the **Characteristics** section is expanded in the **Construct** screen when you are creating or editing a construct. It contains the following fields:

Field Name	Field Description	Mandatory (Yes or No)
Effective Date	Used to specify the date from when the characteristic is effective for the construct.	Yes (Conditional)
		Note: This field is required when you are defining a characteristic for the construct.
Characteristic Type	Used to indicate the characteristic type.	Yes (Conditional)
		Note: This field is required when you are defining a characteristic for the construct.

Field Name	Field Description	Mandatory (Yes or No)
Characteristic Value	Used to specify the value for the characteristic type.	Yes (Conditional)
	<p>Note: On specifying the value for a predefined characteristic type, the description of the characteristic value appears corresponding to the Characteristic Value field.</p> <p>The Search (🔍) icon appears corresponding to this field. On clicking the Search icon, the Predefined Characteristic Search window appears.</p>	<p>Note: This field is required when you are defining a characteristic for the construct.</p>

- Enter the required details.

Note: If you select a predefined characteristic type, the **Search** (🔍) icon appears corresponding to the **Characteristic Value** field. On clicking the **Search** icon, you can search for a predefined characteristic value.

- If you want to define more than one characteristic for the construct, click the **Add** (+) icon and then repeat step 2.

Note: However, if you want to remove a characteristic from the construct, click the **Delete** (🗑️) icon corresponding to the characteristic.

Related Topics

For more information on...	See...
How to define a construct	Defining a Construct on page 1326
How to edit a construct	Editing a Construct on page 1329

Editing a Construct

You can only edit a construct in the **Draft**, **Active**, or **Rejected** status. If a bill is already generated through a construct and it is in the **Pending** status, you cannot edit the details of the construct. You can only edit the effective to date of a construct when all bills generated through the construct are in the **Completed** status. The effective to date must be later than the last completed bill's bill date. Otherwise, the system will not allow you to edit the effective to date of the construct.

Procedure

To edit a template:

- Click the **Menu** link in the **Application** toolbar.
A list appears.
- From the **Main** menu, select **Billing Management** and then click **Construct**.
A sub-menu appears.
- Click on **Search**.
The **Construct** screen appears.
- In the **Search Results** section, click the **Edit** (✎) icon in the **Edit** column corresponding to the **Construct ID** whose details you want to edit.

Note: If a template is used in any construct, a message appears confirming whether you want to edit the template. You must click **OK** if you want to edit the template. Any changes made to a template will not be reflected in any construct where the template is already used unless you use the latest template in the construct.

The **Template** screen appears. It consists of the following tabs:

- **Main** - Used to specify basic details about the template.
- **Characteristics** - Used to define the characteristics for the template.

The **Main** tab contains the following fields:

Field Name	Field Description	Mandatory (Yes or No)								
Template	Used to indicate the template name.	Not applicable								
Description	Used to specify the description for the template.	Yes								
Detailed Description	Used to specify additional information about the template.	No								
Purpose	Used to indicate the purpose of the template. The valid values are: <ul style="list-style-type: none"> • Account Selection - Used for selecting a set of usage accounts based on the criteria. • Adjustment Selection - Used for selecting a set of adjustments based on the criteria. • Billable Charge Selection - Used for selecting a set of billable charges based on the criteria. • Usage Account Selection - Used for selecting a set of usage accounts based on the criteria. • Usage and Invoice Account Selection - Used for selecting a set of usage and invoice accounts based on the criteria. 	Yes								
Status	Used to indicate the status of the template. The valid values are: <ul style="list-style-type: none"> • Active • Inactive 	Yes								
Select	Used to specify the column name. It indicates the data that you want to retrieve using the SELECT statement. The default value appears in this field when you select the purpose of the template. However, the default value changes depending on the purpose of template. You can edit the column name whenever required. <table border="1" data-bbox="548 1621 1156 1885"> <thead> <tr> <th>If you have set the purpose of the template to....</th> <th>Then, the default value is...</th> </tr> </thead> <tbody> <tr> <td>Account Selection</td> <td>ACCT_ID</td> </tr> <tr> <td>Adjustment Selection</td> <td>ADJ_ID</td> </tr> <tr> <td>Billable Charge Selection</td> <td>BILLABLE_CHG_ID</td> </tr> </tbody> </table>	If you have set the purpose of the template to....	Then, the default value is...	Account Selection	ACCT_ID	Adjustment Selection	ADJ_ID	Billable Charge Selection	BILLABLE_CHG_ID	Yes
If you have set the purpose of the template to....	Then, the default value is...									
Account Selection	ACCT_ID									
Adjustment Selection	ADJ_ID									
Billable Charge Selection	BILLABLE_CHG_ID									

Field Name	Field Description	Mandatory (Yes or No)
From	Used to specify the table or view name. It indicates the table or view from which you want to retrieve the data.	Yes
Where	Used to specify the condition based on which you want to retrieve the data from the table or view. You can use the bind variables in the where clause using the following syntax: <pre>{column_name} {operator} : {bind_variable}</pre> <p>The bind variables must be alphanumeric and prefixed with the colon (:). There should not be any space between the column name, operator, and the bind variable. For example, CURRENCY_CD=:CURRENCY. All bind variables used in the where clause must be defined in the Bind Variables section.</p>	No

In addition, this tab contains the **Bind Variables** section where you can define the bind variables which are used in the where clause. The **Bind Variables** section contains the following fields:

Field Name	Field Description	Mandatory (Yes or No)
Bind Variable	Used to specify the bind variable (which is used in the where clause).	Yes (Conditional)
		Note: This field is required when you are defining a bind variable.
Data Type	Used to indicate the type of data that you want to store in the bind variable. The valid values are: <ul style="list-style-type: none"> • Date • Numeric • String 	Yes (Conditional)
		Note: This field is required when you are defining a bind variable.
Label	Used to specify the business label for the bind variable. The business label appears when you define and edit the criteria for selecting a set of usage accounts, adjustments, or billable charges.	Yes (Conditional)
		Note: This field is required when you are defining a bind variable.
Zone	Used to indicate a zone for the template.	Yes (Conditional)
	Note: The Search (🔍) icon appears corresponding to this field. On clicking the Search icon, the Zone/Code Description window appears.	Note: This field is required when you are defining a bind variable.

5. Modify the details in the **Main** tab, if required.

Note: If you want to define more than one bind variable, click the **Add** (+) icon in the **Bind Variables** section and then enter the required details. However, if you want to remove a bind variable from the **Bind Variables** section, click the **Delete** (🗑️) icon corresponding to the bind variable.

6. If required, click **Validate** to validate the syntax of the SELECT statement.

Note: If the syntax of the SELECT statement is correct, a message appears indicating that the SQL statement was validated successfully. However, if the syntax of the SELECT statement is incorrect, an error message occurs. You need to then correct the SELECT statement accordingly. Otherwise, the system will not allow you to save the template.

7. Define, edit or remove characteristics of the template, if required.
8. Click **Validate and Save**.

The system validates the syntax of the SELECT statement and then accordingly saves the changes made to the template.

Related Topics

For more information on...	See...
How to search for a construct	Searching for a Construct on page 1325
How to include usage accounts in a construct	Including Usage Accounts in a Construct on page 1340
How to exclude usage accounts from a construct	Excluding Usage Accounts from a Construct on page 1342
How to include billable charges in a construct	Including Bill Segments in a Construct on page 1345
How to include adjustments in a construct	Including Adjustments in a Construct on page 1346

Copying a Construct

Instead of creating a construct from scratch, you can create a new construct using an existing construct. This is possible through copying a construct. On copying a construct, the usage accounts, billable charges, and adjustments' selection criteria and characteristics are copied to the new construct. You can then edit the details, if required.

Prerequisites

To copy a construct, you should have:

- Construct (whose copy you want to create) defined in the application

Procedure

To copy a construct:

1. Click the **Menu** link in the **Application** toolbar.
A list appears.
2. From the **Main** menu, select **Billing Management** and then click **Construct**.
A sub-menu appears.
3. Click on **Search**.
The **Construct** screen appears.
4. In the **Search Results** section, click the **Copy** () icon in the **Copy** column corresponding to the construct whose copy you want to create.
The **Construct** window appears. It contains the following fields:

Field Name	Field Description	Mandatory (Yes or No)
Construct Description	Used to specify the description for the new construct.	Yes
Effective From	Used to specify the date from when the new construct is effective.	Yes
	Note: The effective from date cannot be later than the effective to date.	
Effective To	Used to specify the date till when the new construct is effective.	No
	Note: The effective to date cannot be earlier than the effective from date.	

5. Enter the required details in the **Main** section and the **Characteristics** section.

6. Click **Save and Next**.

The **Construct** screen appears.

7. Edit the details of the new construct, if required.

Related Topics

For more information on...	See...
How to search for a construct	Searching for a Construct on page 1325
How to edit a construct	Editing a Construct on page 1329

Viewing the Construct Details

Procedure

To view the details of a construct:

1. Search for the construct in the **Construct** screen.
2. In the **Search Results** section, click the **View** () icon in the **View** column corresponding to the construct whose details you want to view.

The **Construct** screen appears. It contains the following sections:

- **Construct Information** — Displays basic details about the construct.
- **Include Usage/Invoice Accounts** — Indicates the persons and their usage accounts or the Invoice accounts for which the construct is defined.
- **Include Bill Segments** — Indicates the bill segments of the usage accounts
- **Include Billable Charges** — Indicates the billable charges of the usage accounts which are billed through a settlement account.
- **Exclude Usage/Invoice Accounts** — Indicates the usage accounts of the persons to which this construct is not applicable.
- **Include Adjustments** — Indicates the adjustments of the usage accounts which are billed through an invoice account.
- **Linked Accounts** — Indicates the linked accounts which are included in the construct.

- View the basic details of the construct in the **Construct Information** section.

Related Topics

For more information on...	See...
Construct screen	Construct (Used for Searching) on page 1323
How to search for a construct	Searching for a Construct on page 1325

Construct (Used for Viewing)

The **Construct** screen allows you to view the details of the construct as well as the log entries. Through this screen, you can define, edit, delete various details of a construct and add log entries. It consists of the following tabs:

- [Construct - Main](#) on page 1334
- [Construct - Log](#) on page 1339

Construct - Main

The **Main** tab displays the details of the construct. It contains the following zones:

- [Construct Information](#) on page 1334
- [Include Usage/Invoice Accounts](#) on page 1335
- [Include Billable Charges](#) on page 1336
- [Include Adjustments](#) on page 1337
- [Include Bill Segments](#) on page 1337
- [Linked Accounts](#) on page 1338
- [Exclude Usage/Invoice Accounts](#) on page 1339

Construct Information

The **Construct Information** zone displays the basic details of the construct. It contains the following sections:

- Main** - The **Main** section contains the following fields:

Field Name	Field Description
Construct ID	Displays the construct ID.
Description	Displays the description of the construct.
Construct Type	Displays the type of the construct.
Status	Displays the status of the construct.
Effective Start Date	Displays the date from when the construct is effective.
Effective End Date	Displays date till when the construct is effective.

- Characteristics** - The **Characteristics** section contains the following columns:

Column Name	Column Description
Effective Date	Displays the date from when the characteristic is effective for the construct.
Characteristic Type	Displays the characteristic type.

Column Name	Column Description
Characteristic Value	Displays the value of the characteristic type.

- **Record Actions** - The **Record Actions** section contains the following buttons:

Button Name	Button Description
Edit	Used to edit the details of the construct.
	Note: The Edit button appears when the construct is in the Draft status.
Delete	Used to delete the construct.
	Note: The Delete button appears when the construct is in the Draft status.
Submit	Used to submit the details of the construct.
	Note: The Submit button appears when the construct is in the Draft status.

- **Record Information** - The **Record Information** section contains the following fields:

Field Name	Field Description
Business Object	Indicates the business object using which the construct is created. In addition, a context menu appears corresponding to this field which helps in navigating to other screens in the application.
	Note: It has a link. On clicking the link, the Business Object screen appears where you can view the details of the construct business object.
Status Date Time	Displays the date and time when the construct status is updated
Create Date Time	Displays the date and time when the construct is created.

Related Topics

For more information on...	See...
How to view the details of person billing hierarchy	Viewing Person Billing Hierarchy Details on page 1351
How to view the details of person settlement hierarchy	Viewing Person Settlement Hierarchy Details on page 1352

Include Usage/Invoice Accounts

The **Include Usage/Invoice Accounts** zone displays the details of usage and invoice accounts. It contains the following columns:

Column Name	Column Description
Effective Start Date	Displays the date from when the construct is effective.
Effective End Date	Displays the date till when the construct is effective.
Priority	Displays the priority of an account.
Template	Displays the name of the template.
Criteria Description	Displays the description of the criteria.

Column Name	Column Description
Criteria	Indicates the bind variable for which you need to define the value.
	Note: The bind variables change depending on the account selection template that you have selected. If a business label is defined for the bind variable, the business label appears in this field.
Edit	On clicking the Edit (✎) icon in the Edit column, the Selection Criteria screen appears where you can edit the details of the usage and invoice accounts.
Delete	On clicking the Delete (🗑) icon in the Delete column, you can delete the usage and invoice accounts.

Related Topics

For more information on...	See...
How to include usage accounts in a construct	Including Usage Accounts in a Construct on page 1340
How to include usage and invoice accounts in a construct	Including Usage and Invoice Accounts in a Construct on page 1341

Include Billable Charges

The **Include Billable Charges** zone displays the details of the billable charges which should be included in the construct. It contains the following columns:

Field Name	Field Description
Effective Start Date	Displays the date from when the construct is effective.
Effective End Date	Displays the date till when the construct is effective.
Priority	Displays the priority of an account.
Template	Displays the name of the template.
Criteria	Indicates the bind variable for which you need to define the value.
	Note: The bind variables change depending on the account selection template that you have selected. If a business label is defined for the bind variable, the business label appears in this field.
Invoice Account Information	Displays the information of the account. In addition, a Context Menu (▼) appears corresponding to this field which helps in navigating to other screens in the application.
	Note: It has a link. On clicking the link, the Account screen appears where you can view the details of the respective account.
Edit	On clicking the Edit (✎) icon in the Edit column, the Selection Criteria screen appears where you can edit the construct.
Delete	On clicking the Delete (🗑) icon in the Delete column, you can delete the construct.

Related Topics

For more information on...	See...
How to view the details person billing hierarchy	Viewing Person Billing Hierarchy Details on page 1351
How to view the details person settlement hierarchy	Viewing Person Settlement Hierarchy Details on page 1352

Include Adjustments

The **Include Adjustments** zone displays the details of the adjustments which should be included in the construct. It contains the following columns:

Column Name	Column Description
Effective Start Date	Displays the date from when the construct is effective.
Effective End Date	Displays the date till when the construct is effective.
Priority	Displays the priority of an account.
Template	Displays the name of the template.
Criteria	Indicates the bind variable for which you need to define the value. Note: The bind variables change depending on the account selection template that you have selected. If a business label is defined for the bind variable, the business label appears in this field.
Invoice Account Information	Displays the information of the account. In addition, a Context Menu (▼) appears corresponding to this field which helps in navigating to other screens in the application. Note: It has a link. On clicking the link, the Account screen appears where you can view the details of the respective account.
Edit	On clicking the Edit (✎) icon in the Edit column, the Selection Criteria screen appears where you can edit the construct.
Delete	On clicking the Delete (🗑) icon in the Delete column, you can delete the construct.

Related Topics

For more information on...	See...
How to view the details of person billing hierarchy	Viewing Person Billing Hierarchy Details on page 1351
How to view the details of person settlement hierarchy	Viewing Person Settlement Hierarchy Details on page 1352

Include Bill Segments

The **Include Bill Segments** zone displays the details of the bill segments which should be included in the construct. It contains the following columns:

Field Name	Field Description
Effective Start Date	Displays the date from when the construct is effective.
Effective End Date	Displays the date till when the construct is effective.
Priority	Displays the priority of an account.

Field Name	Field Description
Template	Displays the name of the template.
Criteria	Indicates the bind variable for which you need to define the value. Note: The bind variables change depending on the account selection template that you have selected. If a business label is defined for the bind variable, the business label appears in this field.
Settlement Account Information	Displays the information of the settlement account. In addition, a Context Menu (▼) appears corresponding to this field which helps in navigating to other screens in the application. Note: It has a link. On clicking the link, the Account screen appears where you can view the details of the respective account.
Edit	On clicking the Edit (✎) icon in the Edit column, the Selection Criteria screen appears where you can edit the construct.
Delete	On clicking the Delete (🗑) icon in the Delete column, you can delete the construct.

Note: The **Include Bill Segments** zone appears when you select **Settlement** from the **Construct Type** field drop-down list while searching for a construct.

Related Topics

For more information on...	See...
How to view the details person billing hierarchy	Viewing Person Billing Hierarchy Details on page 1351
How to view the details person settlement hierarchy	Viewing Person Settlement Hierarchy Details on page 1352

Linked Accounts

The **Linked Accounts** zone displays the details of all the linked account details of a particular person/account hierarchy. It contains the following columns:

Column Name	Column Description
Effective Start Date	Displays the date from when the construct is effective.
Effective End Date	Displays the date till when the construct is effective.
Account ID	Displays the account ID.
Account Information	Displays the information of the account. In addition, a Context Menu (▼) appears corresponding to this field which helps in navigating to other screens in the application. Note: It has a link. On clicking the link, the Account screen appears where you can view the details of the respective account.

Related Topics

For more information on...	See...
How to view the details of person billing hierarchy	Viewing Person Billing Hierarchy Details on page 1351
How to view the details of person settlement hierarchy	Viewing Person Settlement Hierarchy Details on page 1352

Exclude Usage/Invoice Accounts

The **Exclude Usage/Invoice Accounts** zone displays the details of usage and invoice accounts which you want to exclude from the construct. It contains the following columns:

Field Name	Field Description
Effective Start Date	Displays the date from when the construct is effective.
Effective End Date	Displays the date till when the construct is effective.
Account ID	Displays the account ID.
Account Information	Displays the information of the account. In addition, a Context Menu (▼) appears corresponding to this field which helps in navigating to other screens in the application. Note: It has a link. On clicking the link, the Account screen appears where you can view the details of the respective account.
Edit	On clicking the Edit (✎) icon in the Edit column, the Selection Criteria screen appears where you can edit the construct.
Delete	On clicking the Delete (🗑) icon in the Delete column, you can delete the construct.

Related Topics

For more information on...	See...
How to view the details person billing hierarchy	Viewing Person Billing Hierarchy Details on page 1351
How to view the details person settlement hierarchy	Viewing Person Settlement Hierarchy Details on page 1352

Construct - Log

The **Log** tab contains the following zone:

- [Construct Log](#) on page 1339

Construct Log

The **Construct Log** zone lists the complete trail of actions performed on the construct. It contains the following columns:

Column Name	Column Description
Date/Time	Displays the date and time when the action was performed on the construct.
Details	Displays the details about the action performed on the construct..
User	Indicates the user who has performed the action on the construct..
Log Type	Indicates the type of log.

Column Name	Column Description
Related Object	Indicates the object or entity which is created when the action is performed on the construct..
	Note: At present, no data appears in this column. The implementation team can build the custom logic to meet the business requirements.
Status Reason	Indicates the reason why the status of the construct. is changed.
	Note: At present, no data appears in this column. The implementation team can build the custom logic to meet the business requirements.

Note: You can manually add a log entry for the construct by clicking the **Add Log Entry** link in the upper right corner of the **Construct Log** zone.

Related Topics

For more information on...	See...
How to view the log of an construct.	
How to add a log entry for an construct.	

Including Usage Accounts in a Construct

While defining a construct, you need to indicate the persons and their usage accounts for which you want to define the construct. The system allows you to select a set of usage accounts based on the criteria using the account selection template. You need to ensure that all usage and invoice accounts in the construct should have the same bill cycle. Otherwise, erroneous results might occur.

Note: One usage account can belong to only one active construct and not to multiple active constructs at the same time.

Prerequisites

To include usage accounts in a construct, you should have:

- Persons, usage accounts, and account selection templates defined in the application

Procedure

To include usage accounts in a construct:

1. Ensure that **Include Usage/Invoice Accounts** zone is expanded while defining, editing, viewing or copying a construct on the **Construct** screen. It contains the following fields:

Field Name	Field Description
Effective Start Date	Displays the date from when the construct is effective.
Effective End Date	Displays the date till when the construct is effective.
Priority	Displays the priority of an account.
Template	Displays the name of the template.
Criteria Description	Displays the description of the criteria.
Criteria	Indicates the bind variable for which you need to define the value.

Field Name	Field Description
	Note: The bind variables change depending on the account selection template that you have selected. If a business label is defined for the bind variable, the business label appears in this field.
Edit	On clicking the Edit (✎) icon in the Edit column, the Payment Request Type screen appears where you can edit the details of the payment request type.
Delete	On clicking the Delete (🗑) icon in the Delete column, you can delete the payment request type.

- Click the **Add** link at the top—right side of the **Include Usage/Invoice Accounts** zone.
The **Selection Criteria** screen appears.
- Enter the required details and click **Save**.
- If you want to include more than one usage accounts, click **Save and Add New** button in the **Selection Criteria** screen and repeat step 3.
- The **Usage Accounts** are included in the construct.

Related Topics

For more information on...	See...
How to define a construct	Defining a Construct on page 1326
How to edit a construct	Editing a Construct on page 1329

Including Usage and Invoice Accounts in a Construct

While defining a construct, you need to indicate the persons and their usage and invoice accounts for which you want to define the construct. The system allows you to select a set of usage and invoice accounts based on the criteria using the usage and invoice account selection template. You need to ensure that all usage and invoice accounts in the construct should have the same bill cycle. Otherwise, erroneous results might occur.

Note: One usage and invoice account can belong to only one active construct and not to multiple active constructs at the same time.

Prerequisites

To include usage and invoice accounts in a construct, you should have:

- Persons, usage and invoice accounts, and account selection templates defined in the application

Procedure

To include usage and invoice accounts in a construct:

- Ensure that **Include Usage/Invoice Accounts** zone is expanded while defining, editing, viewing or copying a construct on the **Construct** screen. It contains the following fields:

Field Name	Field Description
Effective Start Date	Displays the date from when the construct is effective.
Effective End Date	Displays the date till when the construct is effective.
Priority	Displays the priority of an account.

Field Name	Field Description
Template	Displays the name of the template.
Criteria Description	Displays the description of the criteria.
Criteria	Indicates the bind variable for which you need to define the value.
	Note: The bind variables change depending on the account selection template that you have selected. If a business label is defined for the bind variable, the business label appears in this field.
Edit	On clicking the Edit (✎) icon in the Edit column, the Selection Criteria screen appears where you can edit the construct.
Delete	On clicking the Delete (🗑) icon in the Delete column, you can delete the construct.

- Click the **Add** link at the top—right side of the **Include Usage/Invoice Accounts** zone.
The **Selection Criteria** screen appears.
- Enter the required details and click **Save**.
- If you want to include more than one usage accounts, click **Save and Add New** button in the **Selection Criteria** screen and repeat step 3.

The **Usage and Invoice Accounts** are included in the construct.

Related Topics

For more information on...	See...
How to define a construct	Defining a Construct on page 1326
How to edit a construct	Editing a Construct on page 1329

Excluding Usage Accounts from a Construct

The system will determine the usage accounts based on the criteria defined in the **Exclude Usage Accounts** section. There might be situations when you do not want to include all usage accounts that satisfy the criteria in the construct. In such cases, you can list the usage accounts that should be excluded from the construct.

Procedure

To exclude usage accounts from a construct:

- Ensure that **Exclude Usage/Invoice Accounts** zone is expanded while defining, editing, viewing or copying a construct on the **Construct** screen. It contains the following fields:

Field Name	Field Description
Effective Start Date	Displays the date from when the construct is effective.
Effective End Date	Displays the date till when the construct is effective.
Effective End Date	Displays the date till when the construct is effective.
Account ID	Displays the account ID.
Account Information	Displays the information of the account. In addition, this column has a Context Menu (▼) which helps in navigating to other screens in the application.

Field Name	Field Description
	Note: It has a link. On clicking the link, the Account screen appears where you can view the details of the respective account.
Edit	On clicking the Edit (✎) icon in the Edit column, the Selection Criteria screen appears where you can edit the construct.
Delete	On clicking the Delete (🗑) icon in the Delete column, you can delete the construct.

- Click the **Add** link at the top—right side of the **Exclude Usage/Invoice Accounts** zone.

The **Exclude Usage Accounts** screen appears.

- Search for the usage account that you want to exclude from the construct.

Note: The **Search** (🔍) icon appears corresponding to this field. On clicking the **Search** icon, the **Account Search** window appears.

- If you want to exclude more than one usage account, click the **Add** (+) icon and then repeat the step 3.

Note: However, if you do not want a usage account to be excluded from the construct, click the **Delete** (🗑) icon corresponding to the excluded usage account.

- Enter the required details and click **Save**.

The **Usage Accounts** are excluded from the construct.

Related Topics

For more information on...	See...
How to define a construct	Defining a Construct on page 1326
How to edit a construct	Editing a Construct on page 1329

Excluding Usage and Invoice Accounts from a Construct

The system will determine the usage and invoice accounts based on the criteria defined in the **Exclude Usage/Invoice Accounts** section. There might be situations when you do not want to include all usage and invoice accounts that satisfy the criteria in the construct. In such cases, you can list the usage and invoice accounts that should be excluded from the construct.

Procedure

To exclude usage and invoice accounts from a construct:

- Ensure that **Exclude Usage/Invoice Accounts** zone is expanded while defining, editing, viewing or copying a construct on the **Construct** screen. It contains the following fields:

Field Name	Field Description
Effective Start Date	Displays the date from when the construct is effective.
Effective End Date	Displays the date till when the construct is effective.
Effective End Date	Displays the date till when the construct is effective.
Account ID	Displays the account ID.

Field Name	Field Description
Account Information	Displays the information of the account. In addition, this column has a Context Menu (▼) which helps in navigating to other screens in the application. Note: It has a link. On clicking the link, the Account screen appears where you can view the details of the respective account.
Edit	On clicking the Edit (✎) icon in the Edit column, the Selection Criteria screen appears where you can edit the construct.
Delete	On clicking the Delete (🗑) icon in the Delete column, you can delete the construct.

- Click the **Add** link at the top—right side of the **Exclude Usage/Invoice Accounts** zone.

The **Exclude Usage/Invoice Accounts** screen appears.

- Search for the usage and invoice account that you want to exclude from the construct.

Note: The **Search** (🔍) icon appears corresponding to this field. On clicking the **Search** icon, the **Account Search** window appears.

- If you want to exclude more than one usage and invoice account, click the **Add** (+) icon and then repeat the step 3.

Note: However, if you do not want a usage and invoice account to be excluded from the construct, click the **Delete** (🗑) icon corresponding to the excluded usage and invoice account.

- Enter the required details and click **Save**.

The **Usage And Invoice Accounts** are excluded from the construct.

Related Topics

For more information on...	See...
How to define a construct	Defining a Construct on page 1326
How to edit a construct	Editing a Construct on page 1329

Including Billable Charges in a Construct

While defining a construct, you need to indicate the billable charges that you want to bill through an invoice account. You can use an existing invoice account. The system allows you to select a set of billable charges based on the criteria using the billable charge selection template.

Prerequisites



To include billable charges in a construct, you should have:

- Billable charge selection templates defined in the application
- Invoice account defined in the application (in case you want to use an existing invoice account)

Procedure

To include billable charges in a construct:

- Ensure that **Include Billable Charges** zone is expanded while defining, editing, viewing or copying a construct on the **Construct** screen. It contains the following fields:

Field Name	Field Description
Effective Start Date	Displays the date from when the construct is effective.
Effective End Date	Displays the date till when the construct is effective.
Priority	Displays the priority of an account.
Template	Displays the name of the template.
Criteria	Indicates the bind variable for which you need to define the value. Note: The bind variables change depending on the account selection template that you have selected. If a business label is defined for the bind variable, the business label appears in this field.
Invoice Account Information	Displays the information of the account. In addition, this column has a Context Menu () which helps in navigating to other screens in the application. Note: It has a link. On clicking the link, the Account screen appears where you can view the details of the respective account.
Edit	On clicking the Edit () icon in the Edit column, the Selection Criteria screen appears where you can edit the construct.
Delete	On clicking the Delete () icon in the Delete column, you can delete the construct.

- Click the **Add** link at the top—right side of the **Include Billable Charges** zone.
The **Selection Criteria** screen appears.
- Search for the billable charge selection template that you want to use for selecting a set of billable charges.
- Enter the required details and click **Save**.
- If you want to include more than one usage accounts, click **Save and Add New** button in the **Selection Criteria** screen and repeat step 4.

The **Usage And Invoice Accounts** are included in the construct.

Related Topics

For more information on...	See...
How to define a construct	Defining a Construct on page 1326
How to edit a construct	Editing a Construct on page 1329

Including Bill Segments in a Construct

While defining a construct, you need to indicate the bill segments that you want to bill through a settlement account. You can use an existing settlement account. The system allows you to select multiple bill segments based on the criteria using the bill segment selection template.

Prerequisites

To include bill segments in a construct, you should have:

- Bill segment selection templates defined in the application
- Settlement account defined in the application (in case you want to use an existing settlement account)

Procedure

To include bill segments in a construct:

1. Ensure that **Include Bill Segments** zone is expanded while defining, editing, viewing or copying a construct on the **Construct** screen. It contains the following fields:

Field Name	Field Description
Effective Start Date	Displays the date from when the construct is effective.
Effective End Date	Displays the date till when the construct is effective.
Priority	Displays the priority of an account.
Template	Displays the name of the template.
Criteria	Indicates the bind variable for which you need to define the value. Note: The bind variables change depending on the account selection template that you have selected. If a business label is defined for the bind variable, the business label appears in this field.
Settlement Account Information	Displays the information of the settlement account. In addition, this column has a context menu (▼) which helps in navigating to other screens in the application. Note: It has a link. On clicking the link, the Account screen appears where you can view the details of the respective account.
Edit	On clicking the Edit (✎) icon in the Edit column, the Selection Criteria screen appears where you can edit the construct.
Delete	On clicking the Delete (🗑) icon in the Delete column, you can delete the construct.

2. Click the **Add** link at the top—right side of the **Include Bill Segments** zone.

The **Selection Criteria** screen appears.

3. Search for the bill segment selection template that you want to use for selecting bill segments.
4. Enter the required details and click **Save**.
5. If you want to include more than one bill segments, click **Save and Add New** button in the **Selection Criteria** screen and repeat step 4.

The bill segments are included from the construct.

Related Topics

For more information on...	See...
How to define a construct	Defining a Construct on page 1326
How to edit a construct	Editing a Construct on page 1329

Including Adjustments in a Construct

While defining a construct, you need to indicate the adjustments that you want to bill through an invoice or settlement account. You can use an existing invoice or settlement account. The system allows you to select a set of adjustments based on the criteria using the adjustment selection template.

Prerequisites



To include adjustments in a construct, you should have:

- Adjustment selection templates defined in the application
- Invoice or settlement account defined in the application (in case you want to use an existing invoice account)

Procedure

To include adjustments in a construct:

1. Ensure that **Include Adjustments** zone is expanded while defining, editing, viewing or copying a construct in the **Construct** screen. It contains the following fields:

Column Name	Column Description
Effective Start Date	Displays the date from when the construct is effective.
Effective End Date	Displays the date till when the construct is effective.
Priority	Displays the priority of an account.
Template	Displays the name of the template.
Criteria	Indicates the bind variable for which you need to define the value. Note: The bind variables change depending on the account selection template that you have selected. If a business label is defined for the bind variable, the business label appears in this field.
Invoice Account Information	Displays the information of the invoice account. In addition, this column has a context menu () which helps in navigating to other screens in the application. Note: It has a link. On clicking the link, the Account screen appears where you can view the details of the respective account.
Edit	On clicking the Edit () icon in the Edit column, the Selection Criteria screen appears where you can edit the construct.
Delete	On clicking the Delete () icon in the Delete column, you can delete the construct.

2. Click the **Add** link at the top-right side of the **Include Adjustments** zone.
The **Selection Criteria** screen appears.
3. Search for the adjustment selection template that you want to use for selecting a set of adjustments.
4. Enter the required details and click **Save**.
5. If you want to include more than one usage adjustments, click **Save and Add New** button in the **Selection Criteria** screen and repeat step 4.

The **Adjustments** are included in the construct.

Related Topics

For more information on...	See...
Construct screen	Construct (Used for Searching) on page 1323
Include Adjustments zone	Include Adjustments on page 1337

Activating a Construct

Only active constructs which are effective are used during the construct based billing process. Therefore, you need to activate a construct.

Prerequisites

To activate a construct, you should have:

- Target contract type (characteristic type) defined on usage accounts' contracts' contract type
- Default account creation algorithm defined using the C1-ACTCR-IC algorithm type
- Default contract creation algorithm defined using the C1-CTMP-IC algorithm type
- Assign the **C1-IC_AC** To Do type to a To Do role whose users must receive the To Do entries generated when the new invoice account is created while activating a construct

Procedure

To activate a construct:

1. Search for the draft construct in the **Construct** screen.
2. In the **Search Results** section, click **View** () icon in the **View** column corresponding to the construct that you want to activate.

The **Construct** screen appears.

3. Click **Submit** button in the **Construct Information** zone.

A message appears confirming whether you want to activate a construct.

Note: If you click on **Edit** () icon or **Copy** icon () in the respective columns while searching for a construct, click on **Save and Next** button and then click **Submit** button in the **Construct Information** zone.

4. Click **OK**.

The construct is activated.

Related Topics

For more information on...	See...
Construct screen	Construct (Used for Searching) on page 1323
How to search for a construct	Searching for a Construct on page 1325

Billing and Settlement Hierarchy

The **Billing and Settlement Hierarchy** screen allows you to search for a person/account hierarchy using various search criteria. Through this screen, you can search and view person/account hierarchy. It contains the following zones:

- [Search Hierarchy](#) on page 1348
- [Linked Accounts](#) on page 1338
- [Criteria](#) on page 1351

Search Hierarchy

The **Search Hierarchy** zone allows you to search for a person or an account with its billing/settlement hierarchy using various search criteria. It contains the following two sections:

- **Search Criteria** — The **Search Criteria** section contains the following fields:

Field Name	Field Description	Mandatory (Yes or No)
Search By	Used to indicate whether you want to search for an account with person's billing or settlement hierarchy or account's billing or settlement hierarchy. The valid values are: <ul style="list-style-type: none"> • Person-Billing Hierarchy • Person-Settlement Hierarchy • Account-Billing Hierarchy • Account-Settlement Hierarchy 	Yes
Person ID	Used to search for accounts which belong to a particular person. Note: This field appears when you select the Person-Billing Hierarchy and Person-Settlement Hierarchy option from the Search By list. The Search (🔍) icon appears corresponding to this field. On clicking the Search icon, the Person Search window appears.	Yes
As on Date	Used to search for billing information which is effective on the specified date.	No
Person Name	Used to search for accounts which belong to a particular person. Note: This field appears when you select the Person-Billing Hierarchy and Person-Settlement Hierarchy option from the Search By list.	Yes
View Option	Used to indicate whether you want to view invoice or usage account billing details. The valid values are: <ul style="list-style-type: none"> • Invoice Account — Used when you want to view the usage accounts billed through an invoice account. • Usage Account — Used when you want to view the invoice accounts through which a usage account is billed. Note: This field appears when you select the Account-Billing Hierarchy and Account-Settlement Hierarchy option from the Search By list.	No
Account ID	Used to specify the invoice or usage account ID. Note: This field appears when you select the Account-Billing Hierarchy and Account-Settlement Hierarchy option from the Search By list.	No

Note: You must specify at least one search criterion while searching for a person or an account.

- **Search Results** — On clicking the **Search** button, the search results appear based on the specified search criteria. The **Search Results** section contains the following columns:

Column Name	Column Description
Invoice Account Information	<p>Displays the information of the invoice account.</p> <p>Note: It has a link. On clicking the link, the Account screen appears where you can view the details of the respective account. This field appears when you select the Person-Billing Hierarchy and Account-Billing Hierarchy (if View Option is selected as Settlement Account) option from the Search By list.</p>
Settlement Account Information	<p>Displays the information of the settlement account.</p> <p>Note: It has a link. On clicking the link, the Account screen appears where you can view the details of the respective account. This field appears when you select the Account-Billing Hierarchy and Account-Settlement Hierarchy option from the Search By list.</p>
Construct Information	<p>Displays additional information about the construct.</p> <p>Note: It has a link. On clicking the link, the Construct screen appears where you can view the details of the respective construct.</p>
Effective Start Date	Displays the date from when the construct is effective.
Effective End Date	Displays the date till when the construct is effective.

On clicking the **Broadcast** icon () corresponding to the account, **Linked Accounts** zone and **Criteria** zone appears with the details of the respective account.

Related Topics

For more information on...	See...
Billing and Settlement Hierarchy zone	Billing and Settlement Hierarchy on page 1348

Linked Accounts

The **Linked Accounts** zone displays various accounts linked to a person. It contains the following columns:

Field Name	Field Description
Account ID	<p>Displays the account IDs of all the accounts linked to a person.</p> <p>Note: It has a link. On clicking the link, the Account screen appears where you can view the details of the respective account.</p>
Account Category	Displays the category of an account.
Person Name	Displays the name of a particular person.

Field Name	Field Description
	Note: It has a link. On clicking the link, the Person screen appears where you can view the details of the respective person.

Note:

The **Linked Accounts** zone does not appear automatically. It appears when you click the **Broadcast** () icon in the search results section of the **Search Hierarchy** zone.

Related Topics

For more information on...	See...
Billing and Settlement Hierarchy screen	Billing and Settlement Hierarchy on page 1348
Search Hierarchy zone	Search Hierarchy on page 1348

Criteria

The **Criteria** zone displays the details of all the criteria of a particular person/account hierarchy. It contains the following columns:

Column Name	Column Description
Criteria Type	Displays the criteria type for billing to the account.
Priority	Displays the order in which the bill segments must be generated for a set of billable charges or adjustments on the invoice account.
Selection Criteria	Displays the selection criteria for the construct

Related Topics

For more information on...	See...
How to view the details of the construct	Viewing the Construct Details on page 1333

Viewing Person Billing Hierarchy Details**Procedure**

To view the details of a construct with person billing hierarchy:

1. Search for the hierarchy in the **Billing and Settlement Hierarchy** screen.
2. Select **Account-Billing Hierarchy** option from the **Search By** list and **Usage Account** option from the **View Option** list in the **Search Hierarchy** zone.
3. Enter **Person Name** or **Person ID** and click **Search** button.

Note: ORMB search engine supports wildcard search, where you can substitute the percentage (%) symbol as a stand in for any word or letter in a search criteria. You can use the '%' wildcard character in all input fields except the date and ID fields. The '%' wildcard character is suffixed automatically at the end of the partial search criteria. Therefore, you may or may not specify the wildcard character at the end of the partial search criteria. However, you have to prefix the wildcard character manually wherever required.

4. In the **Search Results** section, click the **Broadcast** () icon corresponding to the construct whose details you want to view. The **Linked Accounts** and **Criteria** zones appear.

The details of all the active constructs with invoice only or invoice and settlement purposes are displayed.

5. View the details of the construct in the **Linked Accounts** zone and **Criteria** zone.

Related Topics

For more information on...	See...
Billing and Settlement Hierarchy screen	Billing and Settlement Hierarchy on page 1348
Linked Accounts zone	Linked Accounts on page 1350
Criteria zone	Criteria on page 1351

Viewing Person Settlement Hierarchy Details

Procedure

To view the details of a construct with person settlement hierarchy:

1. Search for the construct in the **Billing and Settlement Hierarchy** screen.
2. Select **Person-Settlement Hierarchy** option from the **Search By** list in the **Search Hierarchy** zone.
3. Enter **Person Name** or **Person ID** and click **Search** button.

Note: ORMB search engine supports wildcard search, where you can substitute the percentage (%) symbol as a stand in for any word or letter in a search criteria. You can use the ‘%’ wildcard character in all input fields except the date and ID fields. The ‘%’ wildcard character is suffixed automatically at the end of the partial search criteria. Therefore, you may or may not specify the wildcard character at the end of the partial search criteria. However, you have to prefix the wildcard character manually wherever required.

4. In the **Search Results** section, click the **Broadcast** (📡) icon corresponding to the construct whose details you want to view. The **Linked Accounts** and **Criteria** zones appear.

The details of all the active constructs with settlement only types of construct are displayed.

5. View the details of the construct in the **Linked Accounts** zone and **Criteria** zone.

Related Topics

For more information on...	See...
Billing and Settlement Hierarchy screen	Billing and Settlement Hierarchy on page 1348
Linked Accounts zone	Linked Accounts on page 1350
Criteria zone	Criteria on page 1351

Viewing Usage Accounts Billed through an Invoice Account

Procedure

To view the usage accounts billed through an invoice account:

1. Click the **Menu** link in the **Actions/Navigation** area.
A list appears.
2. Select the **Main Menu** option from the list.
3. From the **Main Menu**, select **Billing Management** and then click **Billing and Settlement Hierarchy**.

The **Billing and Settlement Hierarchy** screen appears. It contains the following fields:

Field Name	Field Description	Mandatory (Yes or No)
Search By	Used to indicate whether you want to search for an account with person's billing or settlement hierarchy or account's billing or settlement hierarchy. The valid values are: <ul style="list-style-type: none"> • Person-Billing Hierarchy • Person-Settlement Hierarchy • Account-Billing Hierarchy • Account-Settlement Hierarchy 	Yes
Person ID	Used to search for accounts which belong to a particular person. <p>Note: This field appears when you select the Person-Billing Hierarchy and Person-Settlement Hierarchy option from the Search By list.</p> <p>The Search (🔍) icon appears corresponding to this field. On clicking the Search icon, the Person Search window appears.</p>	Yes
As on Date	Used to search for billing information which is effective on the specified date.	No
Person Name	Used to search for accounts which belong to a particular person. <p>Note: This field appears when you select the Person-Billing Hierarchy and Person-Settlement Hierarchy option from the Search By list.</p>	Yes
View Option	Used to indicate whether you want to view invoice or usage account billing details. The valid values are: <ul style="list-style-type: none"> • Invoice Account — Used when you want to view the usage accounts billed through an invoice account. • Usage Account — Used when you want to view the invoice accounts through which a usage account is billed. <p>Note: This field appears when you select the Account-Billing Hierarchy and Account-Settlement Hierarchy option from the Search By list.</p>	No
Account ID	Used to specify the invoice or usage account ID. <p>Note: This field appears when you select the Account-Billing Hierarchy and Account-Settlement Hierarchy option from the Search By list.</p>	No

4. Select the **Invoice Account** option from the **View Option** list.
5. Enter the date and invoice account ID in the respective fields.
6. Click **Search**.

A list of usage accounts which are billed through the invoice account appears in the search results. The **Search Results** section contains the following columns:

Column Name	Column Description
Usage Account	Indicates the usage account which is billed through the invoice account.
	Note: It has a link. On clicking the link, the Account screen appears where you can view the details of the respective account.
Construct Description	Indicates the construct in which the usage account is included.
	Note: It has a link. On clicking the link, the Construct screen appears where you can view the details of the respective construct.
Selection Criteria	Indicates the criteria used to select a set of usage account's charges or adjustments.

Related Topics

For more information on...	See...
Billing and Settlement Hierarchy screen	Billing and Settlement Hierarchy on page 1348

Viewing Invoice Accounts through which a Usage Account is Billed

Procedure

To view the invoice accounts through which a usage account is billed:

1. Search for the hierarchy in the **Billing and Settlement Hierarchy** screen.
2. Select **Account-Billing Hierarchy** option from the **Search By** list and **Usage Account** option from the **View Option** list in the **Search Hierarchy** zone.
3. Enter the **Account ID** and click **Search** button.

Note: ORMB search engine supports wildcard search, where you can substitute the percentage (%) symbol as a stand in for any word or letter in a search criteria. You can use the '%' wildcard character in all input fields except the date and ID fields. The '%' wildcard character is suffixed automatically at the end of the partial search criteria. Therefore, you may or may not specify the wildcard character at the end of the partial search criteria. However, you have to prefix the wildcard character manually wherever required.

4. Click **Search**.

A list of invoice accounts through which the usage account's charges or adjustments are billed appears in the search results. The **Search Results** section contains the following fields:

Field Name	Field Description
Construct Description	Indicates the construct in which the usage account is included.
	Note: It has a link. On clicking the link, the Construct screen appears where you can view the details of the respective construct.

In addition, this section contains the following columns:

Column Name	Column Description
Invoice Account	Indicates the invoice account through which the usage account's charges or adjustments are billed.
	Note: It has a link. On clicking the link, the Account screen appears with the details of the respective account.
Priority	Indicates the order in which the bill segments must be generated for a set of billable charges or adjustments on the invoice account.
Selection Criteria	Indicates the criteria used to select a set of billable charges or adjustments.

Related Topics

For more information on...	See...
Billing and Settlement Hierarchy screen	Billing and Settlement Hierarchy on page 1348

Viewing Settlement Accounts through which a Usage or Invoice Account is Settled

Procedure

To view construct in which a settlement account is used:

1. Search for the hierarchy in the **Billing and Settlement Hierarchy** screen.
2. Select **Account-Settlement Hierarchy** option from the **Search By** list and **Settlement Account** option from the **View Option** list in the **Search Hierarchy** zone.
3. In the **Search Results** section, click the **Broadcast** (📡) icon corresponding to the construct whose details you want to view. The **Linked Accounts** and **Criteria** zones appear.

The details of all the active constructs linked with the settlement accounts are displayed.

4. View the details of the construct in the **Linked Accounts** zone and **Criteria** zone.

Related Topics

For more information on...	See...
Billing and Settlement Hierarchy screen	Billing and Settlement Hierarchy on page 1348
Linked Accounts zone	Linked Accounts on page 1350
Criteria zone	Criteria on page 1351

Viewing Settlement Hierarchy of a Invoice or Usage Account

Procedure

To view the settlement hierarchy details of a invoice or usage account:

1. Search for the construct in the **Billing and Settlement Hierarchy** screen.
2. Select **Account Settlement Hierarchy** option from the **Search By** list and **Usage or Invoice Account** option from the **View Option** list in the **Search Hierarchy** zone.
3. In the **Search Results** section, click the **Broadcast** (📡) icon corresponding to the construct whose details you want to view. The **Linked Accounts** and **Criteria** zones appear.

The details of all the active constructs linked with the invoice or usage accounts are displayed.

4. View the details of the construct in the **Linked Accounts** zone and **Criteria** zone.

Related Topics

For more information on...	See...
Billing and Settlement Hierarchy screen	Billing and Settlement Hierarchy on page 1348
Linked Accounts zone	Linked Accounts on page 1350
Criteria zone	Criteria on page 1351

Chapter 16

Trial Billing

Topics:

- [Prerequisites](#)
- [Trial Bill \(Used for Searching\)](#)
- [Trial Bill \(Used for Viewing\)](#)

Oracle Revenue Management and Billing facilitates you to generate trial bills before actual bill is generated for an account. This helps to review the trial bill and make the required corrections before the actual bill is generated. The Trial Billing feature is currently designed and developed for open item accounting and not for balance forward accounting.

The process of trial and actual billing is identical. The only difference is that you cannot freeze and complete the trial bills. Also, during trial billing, the account balance is not updated. It is updated when the actual bill is generated. You can generate trial bill only in case of regular billing, and not in case of adhoc billing. The trial bills can be generated only through the batch process. To generate trial bills, you need to execute the following batches in the specified order:

1. **Pending Bill Generation (C1-PNDBL)** – This batch is used to generate pending trial or actual bills for accounts that meet the criteria.
2. **Bill Segment Generation (C1-BLGEN)** – This batch is used to generate bill segments for pending trial or actual bills.
3. **Bill Completion (C1-BLPPR)** – This batch is used to generate post-processing bill segments in the pending trial or actual bills during the bill completion process. The adjustments, if any, created on the accounts are swept onto the pending trial or actual bills. In addition, the bill routing information and bill messages are stamped on the pending trial or actual bills. If the adjustment currency is different from the account's invoice currency, the transfer adjustment is created on the pending actual bill. However, in case of pending trial bill, the currency conversion for adjustments is done, but the transfer adjustments are not created. Finally, the status of the actual bill is set to **Complete**, whereas the status of the trial bill remains as **Pending**.

Note: The adjustments which are in the **Freezable** status are not swept onto the trial bills. Only adjustments which are in the **Frozen** status are swept onto the trial bills.

The **Trial Bill** check box is added in the **Main** tab of the **Account** screen. If you leave the **Process All or Selected Accounts** parameter blank while executing the above batches, all accounts (that meet the criteria) irrespective of whether the **Trial Bill** check box is selected or not are considered for generating the trial bills. However, if the **Process All or Selected Accounts** parameter is set to **Y**, then only those accounts that meet the criteria and where the **Trial Bill** check box is selected are considered for generating the trial bills.

You can create an actual bill using a trial bill. While creating actual bills using trial bills, you need to specify the trial billing batch run number whose trial bills

you want to convert to the actual bills. To create actual bills using trial bills, you need to execute the following batches in the specified order:

1. **Pending Bill Generation (C1-PNDBL)** - This batch generates pending actual bill for accounts that meet the criteria.
2. **Bill Segment Generation (C1-BLGEN)** – This batch copies regular bill segments which are generated for the trial bill and stamps them onto the pending actual bill. It also copies the corresponding financial transactions (FTs).
3. **Bill Completion (C1-BLPPR)** – This batch copies post-processing bill segments which are generated for the trial bill and stamps them onto the pending actual bill. The bill routing information and bill messages are copied from the trial bill to the pending actual bill. The adjustment, if any, created on the account are swept onto the pending actual bill. They are not copied from the respective trial bill. If the adjustment currency is different from the account’s invoice currency, the transfer adjustment is created on the pending actual bill. Finally, the status of the actual bill is set to **Complete**.

The actual bill ID, bill segment ID and FT ID are different from the trial bill ID, bill segment ID and FT ID, respectively. If an actual bill is created using a trial bill, the system will stamp the trial bill ID on the actual bill. This helps you to track the trial bill of an actual bill.

The system allows you to view a trial bill through a user interface. It also allows you to print the trial bill in the PDF format. You can print a trial bill when Oracle Documaker is integrated with Oracle Revenue Management and Billing. For more information about the batches, see *Oracle Revenue Management and Billing Batch Guide*.

Prerequisites

To setup the trial billing feature, you need to do the following:

- Set the **Trial Bill Characteristics Conversion** option type of the **C1_FINTRANOP** feature configuration.

Related Topics

For more information on...	See...
How to setup the C1_FINTRANOP feature configuration	Setting the C1_FINTRANOP Feature Configuration on page 4319

Trial Bill (Used for Searching)

The **Trial Bill** screen allows you to search for a trial bill using various search criteria. It contains the following zone:

- [Search Trial Bill](#) on page 1359

Through this screen, you can navigate to the following screen:

- [Trial Bill \(Used for Viewing\)](#) on page 1362

Search Trial Bill

The **Search Trial Bill** zone allows you to search for trial bills using various search criteria. It contains the following two sections:

- **Search Criteria** — The criteria are grouped as indicated by line separators between the criteria. Each group is independent from the other, and only one group is used at a time for searching. If you enter criteria in more than one group, the criteria from the first group is used for searching. For example, if you enter the criteria in the Account ID and Trial Bill Description fields (which are in different criteria groups), the system searches for trial bills using the account ID. The **Search Criteria** section contains the following fields:

Field Name	Field Description	Mandatory (Yes or No)
Search By	Used to indicate whether you want to search for a trial bill using the trial bill details. The valid value is: <ul style="list-style-type: none"> • Trial Bill Details <p>Note: By default, the Trial Bill Details option is selected.</p>	Yes
Person ID	Used to search trial bills which are generated for a particular person. <p>Note: The Search (🔍) icon appears corresponding to this field. On clicking the Search icon, the Person Search window appears.</p>	No
Trial Bill ID	Used to search for a particular trial bill.	No
Account ID	Used to search trial bills which are generated for a particular account.	No

Field Name	Field Description	Mandatory (Yes or No)
	Note: The Search (🔍) icon appears corresponding to this field. On clicking the Search icon, the Account Search window appears.	
Division	Used to search trial bills which are generated for accounts belonging to a particular division.	No
From Trial Bill Date	Used to search trial bills which are generated from a particular date onwards.	No
Invoice Currency	Used to search trial bills which are generated in a particular invoice currency.	No
To Trial Bill Date	Used to search trial bills which are generated till a particular date.	No
Batch Run Date	Used to search trial bills which are generated on a particular batch run date.	No
Trial Bill Description	Used to search trial bills which are generated in a particular batch run.	Yes (Conditional)
		Note: This field is required when you are searching for trial bills using the batch run date.

Note: You must specify at least one search criterion while searching for a trial bill.

- **Search Results** — On clicking the **Search** button, the search results appear based on the specified search criteria. The **Search Results** section contains the following columns:

Column Name	Column Description
Trial Bill Information	Displays additional information about the trial bill. Note: It has a link. On clicking the link, the Trial Bill screen appears where you can view the details of the respective trial bill.
Current Charges	Displays the trial bill amount.
Account Information	Indicates the account for which the trial bill is generated. In addition, this column has a context menu which helps in navigating to other screens in the application. Note: It has a link. On clicking the link, the Account screen appears with the details of the respective account.
Person Name	Indicates the person for whom the trial bill is generated.
Division	Indicates the division to which the account belongs.
Batch Run Date	Displays the date when the batch is executed to generate the trial bill.
Batch Run Number	Indicates the batch run in which the trial bill is generated.

Related Topics

For more information on...	See...
How to search for a trial bill	Searching for a Trial Bill on page 1361
How to view the details of a trial bill	Viewing the Trial Bill Details on page 1361

Searching for a Trial Bill

Prerequisites

To search for a trial bill, you should have:

- Divisions and currencies defined in the application

Procedure

To search for a trial bill:

1. Click the **Menu** link in the **Application** toolbar.
A list appears.
2. From the **Main** menu, select **Billing Management** and then click **Trial Bill**.
The **Trial Bill** screen appears.
3. Enter the search criteria in the **Search Trial Bill** zone.

Note: ORMB search engine supports wildcard search, where you can substitute the percentage (%) symbol as a stand in for any word or letter in a search criteria. You can use the ‘%’ wildcard character in all input fields except the date and ID fields. The ‘%’ wildcard character is suffixed automatically at the end of the partial search criteria. Therefore, you may or may not specify the wildcard character at the end of the partial search criteria. However, you have to prefix the wildcard character manually wherever required.

4. Click **Search**.
A list of trial bills that meet the search criteria appears in the **Search Results** section.

Related Topics

For more information on...	See...
Trial Bill screen	Trial Bill (Used for Searching) on page 1359
Search Trial Bill zone	Search Trial Bill on page 1359

Viewing the Trial Bill Details

Procedure

To view the details of a trial bill:

1. Search for the trial bill in the **Trial Bill** screen.
2. In the **Search Results** section, click the link in the **Trial Bill Information** column corresponding to the trial bill whose details you want to view.
The **Trial Bill** screen appears.
3. View the basic details of the trial bill in the **Trial Bill** zone.
4. View the segments of the trial bill in the **Trial Bill Segments** zone.
5. View the calc lines of a trial bill segment in the **Trial Bill Segment Calc Lines** zone.
6. View the service quantity details of a trial bill segment in the **Trial Bill Segment SQ Details** zone.

7. View the financial details of a trial bill segment in the **Trial Bill Segment Financial Details** zone.

Related Topics

For more information on...	See...
How to search for a trial bill	Searching for a Trial Bill on page 1361
Trial Bill screen	Trial Bill (Used for Viewing) on page 1362
Trial Bill zone	Trial Bill on page 1362
Trial Bill Segments zone	Trial Bill Segments on page 1363
Trial Bill Segment Calc Lines zone	Trial Bill Segment Calc Lines on page 1365
Trial Bill Segment SQ Details zone	Trial Bill Segment SQ Details on page 1366
Trial Bill Segment Financial Details zone	Trial Bill Segment Financial Details on page 1367
How to view the segments of a trial bill	Viewing the Segments of a Trial Bill on page 1368
How to view the calc lines of a trial bill segment	Viewing the Calc Lines of a Trial Bill Segment on page 1369
How to view the service quantity details of a trial bill segment	Viewing the SQ Details of a Trial Bill Segment on page 1370
How to view the financial details of a trial bill segment	Viewing the Financial Details of a Trial Bill Segment on page 1370

Trial Bill (Used for Viewing)

The **Trial Bill** screen allows you to:

- View the details of a trial bill, such as the trial bill summary, trial bill messages, and trial bill characteristics
- View the segments of a trial bill
- View the calculation lines, service quantity details, and financial details of a trial bill segment
- View the details of the policy, plan, and membership for which a trial bill segment is created

It contains the following zones:

- [Trial Bill](#) on page 1362
- [Trial Bill Segments](#) on page 1363
- [Trial Bill Segment Calc Lines](#) on page 1365
- [Trial Bill Segment SQ Details](#) on page 1366
- [Trial Bill Segment Financial Details](#) on page 1367
- [Policy Details](#) on page 1367

Trial Bill

The **Trial Bill** zone displays the details of the trial bill. It contains the following sections:

- **Main** — This section provides basic information about the trial bill. It contains the following fields:

Field Name	Field Description
Trial Bill ID	Displays the trial bill ID.

Field Name	Field Description
Trial Bill Information	Displays additional information about the trial bill.
Trial Bill Description	Displays the description of the batch run in which the trial bill is generated.
Account Information	Indicates the account for which the trial bill is generated. In addition, a context menu appears corresponding to this field which helps in navigating to other screens in the application.
	Note: It has a link. On clicking the link, the Account screen appears where you can view the details of the respective account.

- **Trial Bill Summary** — This section summarizes the financial impact of the bill. It contains the following fields:

Field Name	Field Description
New Charges	Displays the total amount of frozen bill segment financial transactions which are linked to the trial bill.
Adjustments	Displays the total amount of frozen and/or canceled adjustment financial transactions which are linked to the trial bill.
Corrections	Displays the total amount of canceled and/or rebilled bill segment financial transactions which are linked to the trial bill.
Total	Displays the sum of new charges, adjustments, and corrections.
No. of Bill Segments in Error	Indicates the number of bill segments in the trial bill which are in the Error status.

- **Trial Bill Messages** — This section lists the bill messages that are stamped on the trial bill. It contains the following columns:

Column Name	Column Description
Message Code	Displays the code that uniquely identifies the bill message.
Message on Bill	Displays the bill message.
Priority	Indicates the priority which determines the order in which the bill message must be printed on the trial bill.
Insert Code	Indicates whether the bill message must be sent separately along with the trial bill.

- **Characteristics** — This section lists characteristics of the trial bill. It contains the following columns:

Column Name	Column Description
Characteristic Type	Indicates the characteristic type.
Characteristic Value	Displays the value of the characteristic type.

In addition, this zone contains a button named **Display Trial Bill** which allows you to print a trial bill in the PDF format.

Related Topics

For more information on...	See...
How to print a trial bill in the PDF format	Printing a Trial Bill in the PDF Format on page 1368

Trial Bill Segments

The **Trial Bill Segments** zone lists the segments of the trial bill. You can filter the trial bill segments using various search criteria. This zone contains the following two sections:

- **Search Criteria** - The **Search Criteria** section contains the following fields:

Field Name	Field Description	Mandatory (Yes or No)
Account ID	Used to search trial bill segments which are generated for a particular usage account.	No
	Note: The Search (🔍) icon appears corresponding to this field. On clicking the Search icon, the Account Search window appears.	
Contract Type	Used to search trial bill segments which are generated against a particular type of contract.	No
	Note: The Search (🔍) icon appears corresponding to this field. On clicking the Search icon, the Contract Type Search window appears.	
Trial Bill Segment Type	Used to search for a particular type of trial bill segments. The valid values are: <ul style="list-style-type: none"> • Post Processing • Regular 	No
Price Item	Used to search trial bill segments which are generated for a particular price item.	No
	Note: The Search (🔍) icon appears corresponding to this field. On clicking the Search icon, the Price Item Search window appears.	
Trial Bill Segment Status	Used to search trial bill segments in a particular status. The valid values are: <ul style="list-style-type: none"> • Error • Freezable 	No

- **Search Results** - On clicking the **Search** button, the search results are filtered based on the specified search criteria. The **Search Results** section contains the following columns:

Column Name	Column Description
Trial Bill Segment ID	Displays the trial bill segment ID.
Status	Indicates the status of the trial bill segment. The valid values are: <ul style="list-style-type: none"> • Error • Freezable
Start Date	Displays the start date of the trial bill segment.
End Date	Displays the end date of the trial bill segment.

Column Name	Column Description
Calculated Amount (Pricing Currency)	Displays the trial bill segment amount in the pricing currency.
Price Item	Indicates the price item for which the trial bill segment is generated.
Pricing Parameters	Indicates the price item parameters which are used along with the price item for determining the price item pricing.
Rate Schedule	Indicates the rate schedule which is used for defining the price item pricing.
Price Assignment ID	Indicates the price item pricing which is used during calculation.
Billable Charge ID	Indicates the billable charge for which the trial bill segment is generated.
	Note: It has a link. On clicking the link, the Billable Charge screen appears where you can view the details of the respective billable charge.
Construct ID	Indicates the construct through which the trial bill segment is generated.
	Note: It has a link. On clicking the link, the Construct screen appears where you can view the details of the respective construct.

On clicking the **Broadcast** (📡) icon corresponding to the trial bill segment, the **Trial Bill Segment Calc Lines**, **Trial Bill Segment SQ Details**, **Trial Bill Segment Financial Details**, and **Policy Details** zones appear with the details of the respective trial bill segment.

Related Topics

For more information on...	See...
How to view the segments of a trial bill	Viewing the Segments of a Trial Bill on page 1368
Trial Bill Segment Calc Lines zone	Trial Bill Segment Calc Lines on page 1365
Trial Bill Segment SQ Details zone	Trial Bill Segment SQ Details on page 1366
Trial Bill Segment Financial Details zone	Trial Bill Segment Financial Details on page 1367
Policy Details zone	

Trial Bill Segment Calc Lines

The **Trial Bill Segment Calc Lines** zone lists the calculation lines which indicate how the system calculated the trial bill segment amount. It contains the following columns:

Column Name	Column Description
Sequence No.	Indicates the sequence in which the calculation line is created while calculating the trial bill segment amount.
Description on Bill	Displays the summarized information about the calculation line that will be printed on the trial bill.
Calculated Amount (Pricing Currency)	Displays the calculated charge amount associated with the calculation line in the pricing currency.
Calculated Amount (Invoice Currency)	Displays the calculated charge amount associated with the calculation line in the invoice currency.

Column Name	Column Description
Print	Indicates whether information about the calculation line will be printed on the person's trial bill. The valid values are: <ul style="list-style-type: none"> • Yes • No
Appears in Summary	Indicates whether the calculation line amount will appear in the summary of the trial bill. The valid values are: <ul style="list-style-type: none"> • Yes • No
Exchange Rate	Indicates the exchange rate which is used when the invoice currency is different from the pricing currency.
Price Component ID	Indicates the price component which is used during calculation.
Service Quantity Identifier	Indicates the service quantity identifier (SQI) of the service quantity which is priced on the calculation line.
Billable Service Quantity	Displays the SQI value used by the rates engine for calculation.
Base Amount	Displays the total amount derived from the cross-referenced lines that the current line then used to calculate the charge amount.
Rate Component Sequence	Indicates the sequence of the rate component on the effective rate version which is used while calculating the line.
Exempt Amount	Displays the amount of the calculated charge that the person does not have to pay due to tax exemption.
Distribution Code	Indicates the distribution code associated with the rate component.

By default, the **Trial Bill Segment Calc Lines** zone does not appear in the **Trial Bill** screen. It appears when you click the **Broadcast** (🔊) icon corresponding to the trial bill segment in the **Trial Bill Segment** zone.

Related Topics

For more information on...	See...
How to view the calc lines of a trial bill segment	Viewing the Calc Lines of a Trial Bill Segment on page 1369

Trial Bill Segment SQ Details

The **Trial Bill Segment SQ Details** zone lists the service quantity identifiers associated with the contract against which the trial bill segment is created. It contains the following columns:

Column Name	Column Description
SQI	Indicates the service quantity identifier.
Billable Service Quantity	Displays the SQI value used by the rates engine for calculation.

By default, the **Trial Bill Segment SQ Details** zone does not appear in the **Trial Bill** screen. It appears when you click the **Broadcast** (🔊) icon corresponding to the trial bill segment in the **Trial Bill Segment** zone.

Related Topics

For more information on...	See...
How to view the service quantity details of a trial bill segment	Viewing the SQ Details of a Trial Bill Segment on page 1370

Trial Bill Segment Financial Details

The **Trial Bill Segment Financial Details** zone lists the distribution codes which indicate the GL accounts that will be affected by the trial bill segment financial transaction. It contains the following columns:

Column Name	Column Description
Sequence No.	Indicates the sequence in which the distribution code will be considered for deriving the GL account.
Distribution Code	Indicates the distribution code associated with the rate component used for calculating the trial bill segment amount.
Amount	Displays the amount that will be debited or credited to the GL account.

By default, the **Trial Bill Segment Financial Details** zone does not appear in the **Trial Bill** screen. It appears when you click the **Broadcast** (📡) icon corresponding to the trial bill segment in the **Trial Bill Segment** zone.

Related Topics

For more information on...	See...
How to view the financial details of a trial bill segment	Viewing the Financial Details of a Trial Bill Segment on page 1370

Policy Details

The **Policy Details** zone lists the policy, plan, and membership for which the trial bill segment is created. It contains the following columns:

Column Name	Column Description
Policy Information	Displays the information about the policy. Note: It has a link. On clicking the link, the Policy screen appears where you can view the details of the respective policy.
External Membership ID	Indicates the membership in which the member is included.
Member's Primary Identifier	Displays the concatenated string consisting of primary identifier type and primary identifier of the member which are separated by a colon (:).
Member Name	Indicates the member for whom the trial bill segment is generated.
Plan Information	Displays information about the policy plan. Note: It has a link. On clicking the link, the Policy Plan screen appears where you can view the details of the respective policy plan.

By default, the **Policy Details** zone does not appear in the **Trial Bill** screen. It appears when you click the **Broadcast** (📡) icon corresponding to the trial bill segment in the **Trial Bill Segment** zone.

Related Topics

For more information on...	See...
How to view the policy details of a trial bill segment	Viewing the Policy Details of a Trial Bill Segment on page 1371

Printing a Trial Bill in the PDF Format

Prerequisites

To print a trial bill in the PDF format, you should have:

- Oracle Documaker integrated with Oracle Revenue Management and Billing

Procedure

To print a trial bill in the PDF format:

1. Search for the trial bill in the **Trial Bill** screen.
2. In the **Search Results** section, click the link in the **Trial Bill Information** column corresponding to the trial bill that you want to print in the PDF format.

The **Trial Bill** screen appears.

3. Click the **Display Trial Bill** button in the **Trial Bill** zone.

The trial bill is printed in the PDF format.

Related Topics

For more information on...	See...
How to search for a trial bill	Searching for a Trial Bill on page 1361
Trial Bill screen	Trial Bill (Used for Viewing) on page 1362
Trial Bill zone	Trial Bill on page 1362

Viewing the Segments of a Trial Bill

Procedure

To view the segments of a trial bill:

1. Search for the trial bill in the **Trial Bill** screen.
2. In the **Search Results** section, click the link in the **Trial Bill Information** column corresponding to the trial bill whose details you want to view.

The **Trial Bill** screen appears.

3. View the segments of the trial bill in the **Trial Bill Segments** zone.
4. If required, you can filter the trial bill segments using various search criteria.

Related Topics

For more information on...	See...
How to search for a trial bill	Searching for a Trial Bill on page 1361
Trial Bill screen	Trial Bill (Used for Viewing) on page 1362
Trial Bill Segments zone	Trial Bill Segments on page 1363

For more information on...	See...
How to filter the trial bill segments	Filtering the Trial Bill Segments on page 1369

Filtering the Trial Bill Segments

Prerequisites

To filter the trial bill segments, you should have:

- Usage accounts, contract types, and price items defined in the application

Procedure

To filter the trial bill segments:

1. Search for the trial bill in the **Trial Bill** screen.
2. In the **Search Results** section, click the link in the **Trial Bill Information** column corresponding to the trial bill whose details you want to view.

The **Trial Bill** screen appears.

3. Enter the search criteria in the **Trial Bill Segments** zone.

Note: ORMB search engine supports wildcard search, where you can substitute the percentage (%) symbol as a stand in for any word or letter in a search criteria. You can use the ‘%’ wildcard character in all input fields except the date and ID fields. The ‘%’ wildcard character is suffixed automatically at the end of the partial search criteria. Therefore, you may or may not specify the wildcard character at the end of the partial search criteria. However, you have to prefix the wildcard character manually wherever required.

4. Click **Search**.

The search results are filtered based on the specified criteria.

Related Topics

For more information on...	See...
How to search for a trial bill	Searching for a Trial Bill on page 1361
Trial Bill screen	Trial Bill (Used for Viewing) on page 1362
Trial Bill Segments zone	Trial Bill Segments on page 1363

Viewing the Calc Lines of a Trial Bill Segment

Procedure

To view the calc lines of a trial bill segment:

1. Search for the trial bill in the **Trial Bill** screen.
2. In the **Search Results** section, click the link in the **Trial Bill Information** column corresponding to the trial bill whose details you want to view.

The **Trial Bill** screen appears.

3. If required, you can filter the trial bill segments in the **Trial Bill Segments** zone.
4. In the **Search Results** section, click the **Broadcast** () icon corresponding to the trial bill segment whose details you want to view.

The **Trial Bill Segment Calc Lines**, **Trial Bill Segment SQ Details**, and **Trial Bill Segment Financial Details** zones appear.

5. View the calc lines of the trial bill segment in the **Trial Bill Segment Calc Lines** zone.

Related Topics

For more information on...	See...
How to search for a trial bill	Searching for a Trial Bill on page 1361
Trial Bill screen	Trial Bill (Used for Viewing) on page 1362
How to filter the trial bill segments	Filtering the Trial Bill Segments on page 1369
Trial Bill Segment Calc Lines zone	Trial Bill Segment Calc Lines on page 1365

Viewing the SQ Details of a Trial Bill Segment

Procedure

To view the service quantity details of a trial bill segment:

1. Search for the trial bill in the **Trial Bill** screen.
2. In the **Search Results** section, click the link in the **Trial Bill Information** column corresponding to the trial bill whose details you want to view.

The **Trial Bill** screen appears.

3. If required, you can filter the trial bill segments in the **Trial Bill Segments** zone.
4. In the **Search Results** section, click the **Broadcast** (📡) icon corresponding to the trial bill segment whose details you want to view.

The **Trial Bill Segment Calc Lines**, **Trial Bill Segment SQ Details**, and **Trial Bill Segment Financial Details** zones appear.

5. View the service quantity details of the trial bill segment in the **Trial Bill Segment SQ Details** zone.

Related Topics

For more information on...	See...
How to search for a trial bill	Searching for a Trial Bill on page 1361
Trial Bill screen	Trial Bill (Used for Viewing) on page 1362
How to filter the trial bill segments	Filtering the Trial Bill Segments on page 1369
Trial Bill Segment SQ Details zone	Trial Bill Segment SQ Details on page 1366

Viewing the Financial Details of a Trial Bill Segment

Procedure

To view the financial details of a trial bill segment:

1. Search for the trial bill in the **Trial Bill** screen.

- In the **Search Results** section, click the link in the **Trial Bill Information** column corresponding to the trial bill whose details you want to view.

The **Trial Bill** screen appears.

- If required, you can filter the trial bill segments in the **Trial Bill Segments** zone.

- In the **Search Results** section, click the **Broadcast** () icon corresponding to the trial bill segment whose details you want to view.

The **Trial Bill Segment Calc Lines**, **Trial Bill Segment SQ Details**, and **Trial Bill Segment Financial Details** zones appear.

- View the financial details of the trial bill segment in the **Trial Bill Segment Financial Details** zone.

Related Topics

For more information on...	See...
How to search for a trial bill	Searching for a Trial Bill on page 1361
Trial Bill screen	Trial Bill (Used for Viewing) on page 1362
How to filter the trial bill segments	Filtering the Trial Bill Segments on page 1369
Trial Bill Segment Financial Details zone	Trial Bill Segment Financial Details on page 1367

Viewing the Policy Details of a Trial Bill Segment

Procedure

To view the policy details of a trial bill:

- Search for the trial bill in the **Trial Bill** screen.
- In the **Search Results** section, click the link in the **Trial Bill Information** column corresponding to the trial bill whose details you want to view.

The **Trial Bill** screen appears.

- If required, you can filter the trial bill segments in the **Trial Bill Segments** zone.

- In the **Trial Bill Segments** zone, click the **Broadcast** () icon corresponding to the trial bill segment whose policy details you want to view.

The **Trial Bill Segment Calc Lines**, **Trial Bill Segment SQ Details**, **Trial Bill Segment Financial Details**, and **Policy Details** zones appear.

- View the policy details of the trial bill segment in the **Policy Details** zone.

Related Topics

For more information on...	See...
How to search for a trial bill	Searching for a Trial Bill on page 1361
Trial Bill screen	Trial Bill (Used for Viewing) on page 1362
Trial Bill Segments zone	Trial Bill Segments on page 1363
How to filter the trial bill segments	Filtering the Trial Bill Segments on page 1369
Trial Bill Calc Lines zone	Trial Bill Segment Calc Lines on page 1365

For more information on...	See...
Trial Bill SQ Details zone	<i>Trial Bill Segment SQ Details</i> on page 1366
Trial Bill Segment Financial Details zone	<i>Trial Bill Segment Financial Details</i> on page 1367
Policy Details zone	<i>Policy Details</i> on page 1367

Chapter 17

Bill Tolerance

Topics:

- [Prerequisites](#)

Oracle Revenue Management and Billing allows you to define tolerance limit for the bill amount. If the difference between the previous and current bill amount exceeds either positive or negative tolerance limit, a To Do entry is generated when you initiate the bill completion process. In addition, a To Do entry is generated for the first bill of an account during the bill completion process. Until you review and close the To Do entry, you cannot complete the bill. After you close the To Do entry, you need to initiate the bill completion process once again to freeze and complete the bill. Note that the To Do entries are generated only for regular bills and not for adhoc bills.

The **Bill Tolerance** feature is supported when you freeze and complete the regular bills through the user interface and through the charge based billing batch named **Bill Completion (C1-BLPPR)**. It is not yet supported when you freeze and complete the bill through the **BILLING** batch. In addition, this feature is not yet designed to work when bills are generated through the construct based billing batches.

For more information on how to setup the bill tolerance feature, refer to [Prerequisites](#) on page 1374.

Prerequisites

To setup the bill tolerance feature, you need to do the following:

- Define an algorithm of the C1-BILL_TOLR algorithm type and attach it to the **Pre-Bill Completion Review** system event on the respective customer class. This algorithm type has the following parameters:
 - Positive Tolerance Percentage** – Used to specify the positive tolerance limit in percentage.
 - Negative Tolerance Percentage** – Used to specify the negative tolerance limit in percentage.
 - Positive Tolerance Amount** - Used to specify the positive tolerance limit in amount.
 - Negative Tolerance Amount** - Used to specify the negative tolerance limit in amount.
 - Tolerance To Do Type** – Used to indicate that To Do entry of the specified To Do type must be created when the bill amount difference exceeds either positive or negative tolerance limit. This parameter is mandatory.
 - First Bill To Do Type** – Used to indicate that To Do entry of the specified To Do type must be created when the first bill is generated for an account. This parameter is mandatory.
 - Tolerance To Do Role** - Used to indicate that users with the specified To Do role can only view the “%1 Bill Tolerance Limit Exceeded” To Do entry. This parameter is mandatory.
 - First Bill To Do Role** - Used to indicate that users with the specified To Do role can only view the “%1 To-do generated for First Bill” To Do entry. This parameter is mandatory.

For example, if you set the **Positive Tolerance Percentage** parameter to 10 and the **Negative Tolerance Percentage** parameter to 15 in the algorithm, then in the following scenarios:

Current Bill Amount (USD)	Previous Bill Amount (USD)	Tolerance Calculation	Amount	To Do Entry Generated (Yes or No)	Reason
120	100	$100+(100*10)/100=110$		Yes	Current Bill Amount is above Positive Tolerance Limit
115	105	$105+(105*10)/100=115.5$		No	Current Bill Amount is within Positive Tolerance Limit
80	100	$100-(100*15)/100=85$		Yes	Current Bill Amount is below Negative Tolerance Limit
95	110	$110-(110*15)/100=93.5$		No	Current Bill Amount is within Negative Tolerance Limit

If the tolerance limit is specified in both percentage and amount, the system calculates the tolerance amount using percentage and amount, considers the minimum value, and then creates the To Do entry accordingly. For example, if you set the **Positive Tolerance Percentage** parameter to 10, the **Positive Tolerance Amount** parameter to 15, the **Negative Tolerance Percentage** parameter to 5, and the **Negative Tolerance Amount** parameter to 25 in the algorithm, then in the following scenarios:

Current Bill Amount (USD)	Previous Bill Amount (USD)	Tolerance Calculation	Amount	To Do Entry Generated (Yes or No)	Reason
120	100	$100+(100*10)/100=110$ (Derived using positive tolerance percentage)	$100+15=115$	Yes	Current Bill Amount is above Positive Tolerance Limit

Current Bill Amount (USD)	Previous Bill Amount (USD)	Tolerance Amount Calculation	To Do Entry Generated (Yes or No)	Reason
		(Derived using positive tolerance amount) Minimum Value is 110 in Positive Scenario		
180	200	200-(200*5)/100=190 (Derived using negative tolerance percentage) 200-25=175 (Derived using negative tolerance amount) Minimum Value is 190 in Negative Scenario	Yes	Current Bill Amount is below Negative Tolerance Limit

During the tolerance amount calculation, the system checks whether the **Multi-Currency Accounts** feature is enabled or disabled. If the **Multi-Currency Accounts** feature is enabled, the system converts the previous and current bill amount in the division's base currency when the invoice currency is different from the division's base currency. Once the currency conversion is done, the tolerance amount is calculated and To Do entry is generated accordingly.

- Set the **Multi Price Parameter** option type of the **Multi Parameter Based Pricing (C1_PPARM_FLG)** feature configuration to **True** if you want to enable the currency conversion feature during tolerance amount calculation
- Define the Tolerance and First Bill To Do types using the following information:
 - **Navigation Option** - billMaint
 - **Priority** – Priority 10 – Highest
 - **Message Category** - 11105
 - **Message Number** – 11009
 - **Sort Keys** — Define the following sort keys for the To Do type:

Sort Key	Use as Default	Sort Order
Bill ID	Yes	Ascending

- **Drill Keys** — Define the following drill keys for the To Do type:

Table Name	Field Name
CI_BILL	BILL_ID

Related Topics

For more information on...	See...
How to set the Multi Parameter Based Pricing (C1_PPARM_FLG) feature configuration	Setting the C1_PPARM_FLG Feature Configuration on page 4340

Chapter 18

GL Account Validation

Topics:

- [Static GL Account Validation](#)
- [Dynamic GL Account Validation](#)

Oracle Revenue Management and Billing allows you to validate the GL account statically and dynamically. The static GL account validation means you can validate the GL account while creating or editing a distribution code. And, the dynamic GL account validation means you can validate the GL account while assigning it to trial and actual financial transactions through the batch process.

For more information about static GL account validation and dynamic GL account validation, refer to [Static GL Account Validation](#) on page 1378 and [Dynamic GL Account Validation](#) on page 1378, respectively.

Static GL Account Validation

If you want to validate the GL account while creating or editing a distribution code, you need to select the **Validate GL Account** check box in the **Distribution Code** screen. If the GL account is valid, the following string appears below the check box while saving the distribution code:

“GL Account is validated on YYYY-MM-DD”

And, if the GL account is invalid, the following string appears below the check box while saving the distribution code:

“GL Account is invalid”

If you want to enable the static GL account validation feature on the **Distribution Code** screen, you need to define an algorithm of the **C1-GLVAL** or **C1-GLVAL-COB** algorithm type and attach the algorithm to the **GL Account Validation** system event in the **Algorithms** tab of the **Installation Options – Framework** screen. Both these algorithm types have one parameter named **GL Account Length**. You need to set the value of this parameter while creating the algorithm using the **C1-GLVAL** or **C1-GLVAL-COB** algorithm type. If you attach an algorithm of the **C1-GLVAL** algorithm type, the system checks whether the length of GL account is greater than or equal to the value defined in the **GL Account Length** parameter. If the length is greater than or equal to the specified length, the GL account is considered as valid. And, if the length is less than the specified length, the GL account is considered as invalid.

And, if you attach an algorithm of the **C1-GLVAL-COB** algorithm type, the system checks whether the length of GL account is equal to the value defined in the **GL Account Length** parameter. If the length is equal to the specified length, the GL account is considered as valid. And, if the length is less than or greater than the specified length, the GL account is considered as invalid.

Dynamic GL Account Validation

If you want to validate GL account while assigning it to trial and actual financial transactions, you need to set the **Validate GL Account** parameter to **Y** while executing the batch. If the GL account is valid, the date when the GL account is validated is added in the **GLA_VAL_DT** column of the **CI_TRL_FT_GL** or **CI_FT_GL** table, respectively, depending on whether the GL account is assigned to a trial or actual financial transaction.

If you want to enable the dynamic GL account validation feature in the **C1-GLASN** or **GLASSGN2** batch, you need to define an algorithm of the **C1-GLVAL** or **C1-GLVAL-COB** algorithm type and attach the algorithm to either of the following:

- The **GL Account Validation** algorithm entity in the **Algorithms** tab of the **Division** screen
- The **GL Account Validation** system event in the **Algorithms** tab of the **Installation Options – Framework** screen

If the GL account validation algorithm is defined at both these algorithm spots, the algorithm defined at the division level always takes precedence over the algorithm defined in the installation options during dynamic GL account validation.

Chapter 19

Upload Validated Adjustment Data

Topics:

- [Prerequisites](#)
- [CSV File Format](#)
- [Adjustment Upload Request \(Without Approval\) Status Transition](#)
- [Adjustment Upload Request \(With Approval\) Status Transition](#)
- [Algorithms Used in C1-ADJUPLD](#)
- [Upload Request Type](#)
- [Adjustment Upload Request \(Used for Searching\)](#)
- [Adjustment Upload Request \(Used for Viewing\)](#)

Oracle Revenue Management and Billing until now provided you with an ability to upload adjustment data received from an external source system and create adjustments using the **C1-ADUP1** and **C1-ADUP2** batches. However, there was no user interface available through which you can upload an adjustment data file and create adjustments from the adjustment records. Now, the system provides a user interface which helps you to upload an adjustment data file.

You can upload an adjustment data file in the CSV format. You need to ensure that the CSV file is in the required format; otherwise the file will not be uploaded in the system. At present, the system supports only the CSV file format. For more information about the CSV file format, see [CSV File Format](#) on page 1381.

While uploading an adjustment data file, you need to specify the upload request type using which you want to upload the adjustment data file. It is the upload request type which helps the system to determine:

- Whether adjustments must be created in the real time (i.e. immediately) or in the deferred mode (i.e. in the background)
- Whether the size of the adjustment data file exceeds the maximum file size defined in the upload request type
- Whether the adjustment data file must be approved by the approver before creating adjustments

All records are validated before uploading an adjustment data file. During the validation process, the system and custom validations (if any) are executed. If there is any invalid record, the system does not allow you to upload the adjustment data file. The system indicates the reason why the adjustment record could not pass through the validation process. You need to first correct the adjustment record in the CSV file and then upload the adjustment data file.

An upload request of the specified upload request type is created when an adjustment data file is successfully uploaded in the system. You can track an adjustment data file through an upload request. During the adjustment upload process, an adjustment upload request goes through various statuses in its lifecycle. For more information about the adjustment upload request statuses, see [Adjustment Upload Request \(Without Approval\) Status Transition](#) on page 1382 and [Adjustment Upload Request \(With Approval\) Status Transition](#) on page 1383.

Note that the lifecycle of an adjustment upload request is driven by the business object using which the adjustment upload request is created. An adjustment upload request business object named **C1-ADJUPLD** is shipped with the product. The adjustment upload feature explained in this section is documented based on the lifecycle and logic defined in the **C1-ADJUPLD** business object.

If required, the implementation team can create a custom adjustment upload request business object.

Once the adjustment upload request is created, you can perform various tasks, such as:

- Track the status of an adjustment upload request
- View the details of an adjustment upload request
- View all records of an adjustment data file
- Cancel an adjustment data file
- Create adjustments for an adjustment data file
- Submit the adjustment data file for approval
- Approve or reject an adjustment data file based on the observations

Prerequisites

To setup the adjustment upload process, you need to do the following:

- Define the required upload request types in the system
- Create a defer algorithm using the **C1-UPLDEFEVL** algorithm type
- Create an algorithm using the **C1-MTCIALG** algorithm type if you want to create adjustments using the Contract match type
- Create an algorithm using the **C1-MTCTALG** algorithm type if you want to create adjustments using the Contract Type match type
- Define the required characteristic types where the characteristic entity is set to Upload Request Type
- Define cancellation and rejection reasons for the **C1-ADJUPLD** business object
- Assign the **C1-ADJUP** To Do type to a To Do role whose users must receive To Do entries generated while submitting an upload request (i.e. an adjustment data file) for approval
- Set the batch control type of the **Upload Request Periodic Monitor (C1-UPLRQ)** batch to **Timed** and define the following attributes:
 - Time Interval
 - Timer Active
 - User ID
 - Batch Language
 - Email Address

CSV File Format

Before uploading an adjustment data file, you need to ensure that the CSV file contains the following columns:

Column Name	Description	Mandatory (Yes or No)
Account Identifier Type	Used to specify the account identifier type.	Yes (Conditional) Note: This data is required when the match type is Contract Type and account ID is not specified.
Account Identifier	Used to specify the account identifier.	Yes (Conditional) Note: This data is required when the match type is Contract Type and account ID is not specified.
Account ID	Used to indicate the account for which the adjustment must be created.	Yes (Conditional)

Column Name	Description	Mandatory (Yes or No)
		Note: This data is required when the match type is Contract Type and the account identifier type and account identifier are not specified.
Match Type	Used to indicate the match type using which the adjustment must be created.	Yes
Match Value	Used to indicate the entity (such as contract, contract type, and so on) against which the adjustment must be created.	Yes
Adjustment Type	Used to indicate the adjustment type using which the adjustment must be created.	Yes
	Note: The adjustment type must be included in the adjustment type profile which is attached to the contract type.	
Adjustment Amount	Used to specify the adjustment amount.	Yes
	Note: The adjustment amount precision must match the precision (decimal positions) defined for the currency.	
Currency Code	Used to indicate the currency in which the adjustment must be created.	Yes
Comments	Used to specify additional information about the adjustment.	No
Bill ID	Used to indicate the bill on which the adjustment must be created.	No
Arrears Date	Used to specify the date from when the amount is outstanding on the bill.	No
Char Type 1, Char Type 2,, Char Type 5	Used to indicate the characteristic that must be defined for the adjustment.	Yes (Conditional)
		Note: This data is required if the characteristic value is specified.
Char Value 1, Char Value 2,, Char Value 5	Used to specify the value for the characteristic type.	Yes (Conditional)
		Note: This data is required if the characteristic type is specified.

Note: If an adjustment data file contains column names other than those mentioned in the above table, the system will not upload the adjustment data file.

Adjustment Upload Request (Without Approval) Status Transition

The following figure graphically indicates how an adjustment upload request moves from one status to another when approval workflow is off:

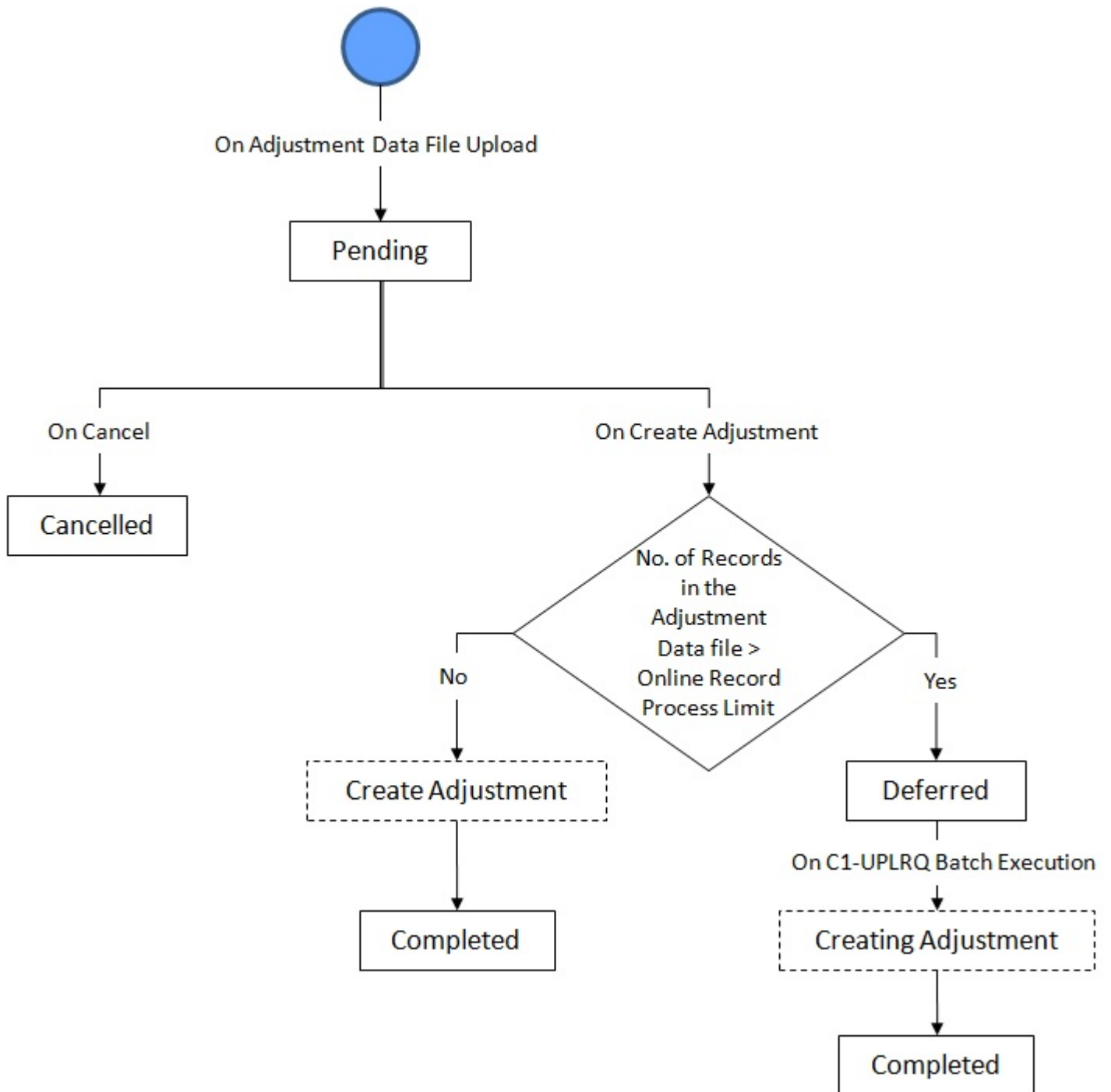

Adjustment Upload Request (With Approval) Status Transition

The following figure graphically indicates how an adjustment upload request moves from one status to another when approval workflow is on:

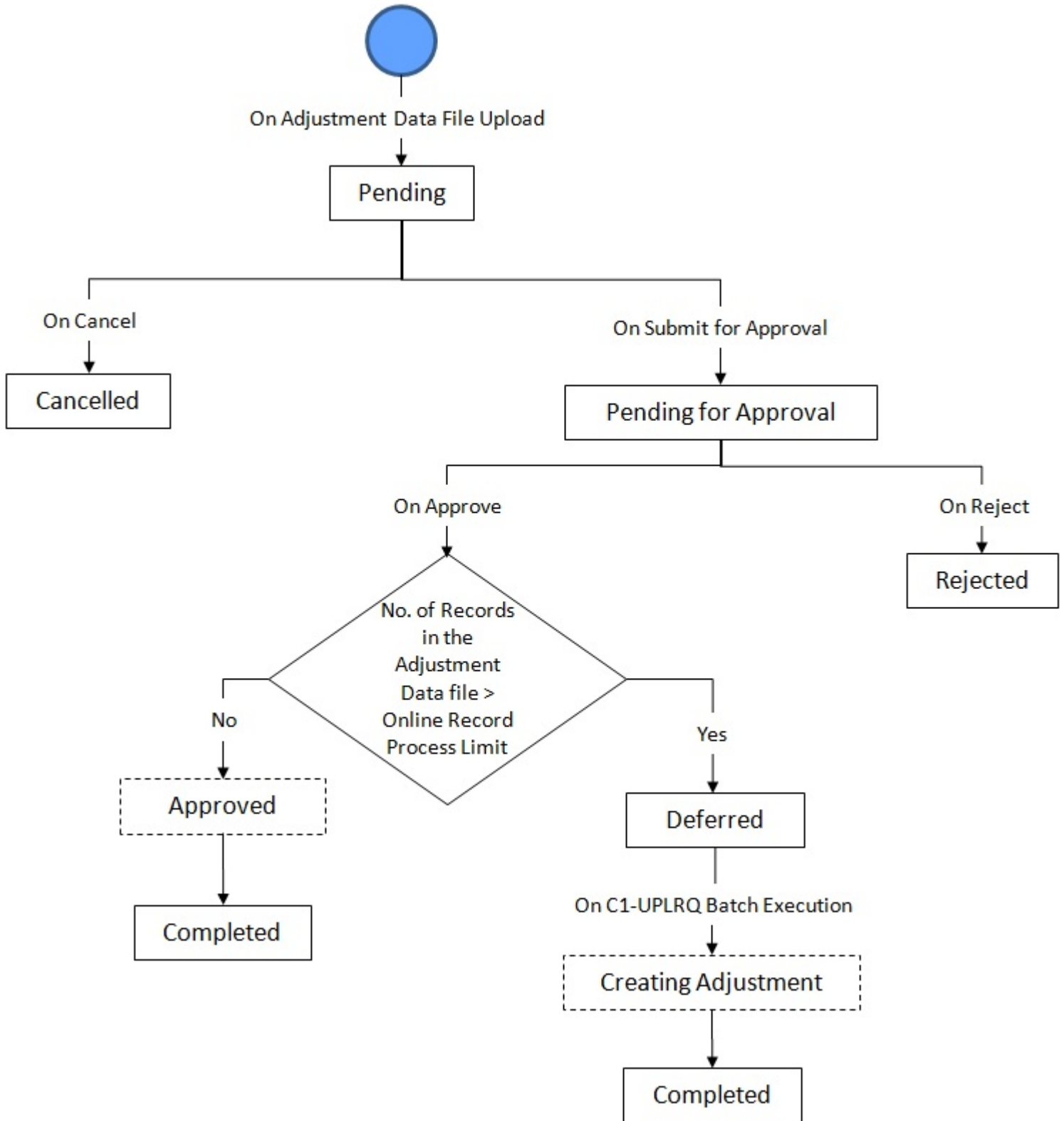

Algorithms Used in C1-ADJUPLD

The following table lists the algorithms which are attached to the **C1-ADJUPLD** business object:

System Event	Algorithm	Algorithm Type	Description
Information	C1-FLREQ-INF	C1-FLREQ-INF	<p>This algorithm formats the upload request information that appears throughout the system for the BO. The algorithm formats the information as follows: Upload Request type description, Status description, ID. This algorithm generates the upload request information string which appears throughout the application. This algorithm concatenates the following fields:</p> <ul style="list-style-type: none"> • Upload Request Type Description • Upload Request Description • Upload Request ID
Validation	C1-ADVALREQ	C1-ADVALREQ	<p>This algorithm will be called from a business service and is responsible for validating the uploaded CSV file and identify if any records are invalid. The validations to be performed are mentioned below:</p> <ol style="list-style-type: none"> 1. Mandatory column data checks 2. Check for valid values for account, match type, match value, adjustment type, adjustment characteristics type, currency and amount. 3. This algorithm will also call the match type algorithm linked to the request type to derive and validate the value for contract ID. This algorithm validates the uploaded CSV file and identifies invalid records, if any. The validations performed are as follows: <ul style="list-style-type: none"> • Validating mandatory column data • Validating values for account, match type, match value, adjustment type, adjustment characteristics type, currency and amount. • Invoke the match type algorithm linked to the request type to derive and validate the value for contract ID.

The following table lists the algorithms which are used in the lifecycle of the **C1-ADJUPLD** business object:

Status	System Event	Algorithm	Algorithm Type	Description
Draft	-	-	-	-
Cancelled	-	-	-	-
Create Adjustment	Enter	C1-ADJUPLDEF	C1-ADJUPLDEF	<p>This algorithm will evaluate if request processing should be done in real time or deferred for offline processing. This will be invoked by the Enter Status algorithm when the Request object enters 'CREATE' or 'APPROVED' status. This algorithm evaluates and creates adjustment. It evaluates, if request should be processed in real time or deferred for offline processing.</p>

Status	System Event	Algorithm	Algorithm Type	Description
				This algorithm is triggered by the Enter status algorithm when the request object is changed to Create or Approved status.
Deferred	Monitor	C1-ADJ-MNTR	C1-ADJ-MNTR	This algorithm will be invoked from the Upload Request Monitor batch. This will be responsible for BO transition from 'Deferred' to 'Creating' status. This algorithm is triggered from the Upload Request Monitor batch. This algorithm transitions the business object status from Deferred to Creating .
Pending for Approval	Enter	C1-ADJUPAPVL	C1-ADJUPAPVL	This algorithm will be responsible of creating To Do for the approver to approve or reject the uploaded file data. To Do will be created using the To Do Type linked to the request type to the approver(s) who are associated with the To Do Role linked to the request type. This will be invoked by the Enter Status algorithm when the Request object enters 'SUBMITTED - Pending For Approver' status. This algorithm creates the To Do using the To Do Type for the approver to approve or reject the uploaded file data. This To Do Type is linked to the request type to the approver(s) associated with the To Do Role linked to the request type. This algorithm is triggered by the Enter status algorithm when the request object enters Submitted - Pending For Approver status.
Approved	Enter	C1-ADJUPLDEF	C1-ADJUPLDEF	This algorithm will evaluate if request processing should be done in real time or deferred for offline processing. This will be invoked by the Enter Status algorithm when the Request object enters 'CREATE' or 'APPROVED' status. This algorithm evaluates if request should be processed in real time or deferred for offline processing. This algorithm is triggered by the Enter status algorithm when the request object is changed to Create or Approved status.
Rejected	-	-	-	-
Completed	-	-	-	-
Creating Adjustment	Enter	C1-ADJCRTION	C1-ADJCRTION	This algorithm is responsible for creating Adjustment for the uploaded

Status	System Event	Algorithm	Algorithm Type	Description
				file. The adjustment ID will be updated back in the request table to link the request with the adjustments. This algorithm creates an adjustment for the uploaded file. In addition, the adjustment ID is stamped on the adjustment and on the corresponding financial transaction.

Upload Request Type

Oracle Revenue Management and Billing allows you to define an upload request type using which you can upload a file. An upload request of the specified upload request type is created on uploading the file. It is the upload request type which helps the system to understand how to process the file. If you upload a file which exceeds the maximum file size, the system will not allow you to upload the file.

The **Adjustment Upload Request Type (C1-AdjRequestType)** business object is used for the maintenance of upload request types for uploading CSV data. Configurations like upload file size, approval workflow can be configured using this object. If you are going to upload adjustment data files using an upload request type, you need to specify the match types (using which the adjustments must be created) in the upload request type. At present, the following two match types are shipped with the product:

- Contract
- Contract Type

You can also define custom match types, if required. You must use the **ADJ_MATCH_TYPE** lookup field to add a new match type. You need to attach an algorithm to each match type to determine the contract against which the adjustment must be created. At present, the following algorithm types and sample algorithms are shipped with the product:

Match Type	Algorithm Type	Sample Algorithm	Algorithm Description
Contract	C1-MTCIALG	C1-MTCIALG	This algorithm fetches contract ID for each adjustment record where the match type is set to Contract (CONT) .
Contract Type	C1-MTCTALG	C1-MTCTALG	This algorithm fetches contract ID based on the contract type and account ID for each adjustment record where the match type is set to Contract Type (CNTY) . If there are multiple active contracts of the specified contract type on the account, the contract ID with the latest start date will be fetched.

The **Upload Request Type (C1-UplRequestType)** business object will be used for the maintenance of upload request types for uploading CSV data. Configurations like upload file size, approval workflow can be configured using this object. The system enables you to upload data for the following using the **Upload Request** feature:

- Billable Charge (Adhoc and Regular)
- Hold Request
- Refund Request
- Write Off Request
- Policy Reinstatement
- Bill Group Sort ID

- Derivation and Pricing Parameters for a Bill Group and Sort ID Combination

It also enables you to update the following information:

- Contract rider of a contract
- Bill cycle of an account

It is the upload request type which helps the system to determine:

- Whether the file must be approved by the approver before creating or updating the entities
- Which business object must be used for creating the upload request
- Which business object must be used for creating or updating entities through an upload request
- Which foreign key reference must be used for generating information string for the entity
- A set of fields using which you can search records uploaded through an upload request

You can also define custom algorithm types and algorithms, if required. The **Upload Request Type** screen allows you to define, edit, copy, and delete an upload request type. This screen consists of the following zones:

- [Upload Request Type List](#) on page 1388
- [Upload Request Type](#) on page 1389

Upload Request Type List

The **Upload Request Type List** zone lists upload request types that are already defined in the system. It contains the following columns:

Column Name	Column Description
Upload Request Type	Displays the upload request type.
Description	Displays the description of the upload request type.
Edit	On clicking the Edit (✎) icon, the Upload Request Type screen appears where you can edit the details of the upload request type.
Duplicate	On clicking the Duplicate (📄) icon, the Upload Request Type screen appears where you can define an upload request type using an existing upload request type.
Delete	On clicking the Delete (🗑) icon, you can delete the upload request type.
	Note: You can delete an upload request type when you have not uploaded a file (i.e. created an upload request) using the upload request type.
Mapping	On clicking the Mapping (🔗) icon, the mapping screen appears where you can map the columns of CSV file with the upload request type.

On clicking the **Broadcast** (📡) icon corresponding to an upload request type, the **Upload Request Type** zone appears with the details of the respective upload request type.

Related Topics

For more information on...	See...
How to define an upload request type	Defining an Upload Request Type on page 1392
How to define a characteristic for an upload request type	Defining a Characteristic for an Upload Request Type on page 1397

For more information on...	See...
How to edit an upload request type	Editing an Upload Request Type on page 1398
How to copy an upload request type	Copying an Upload Request Type on page 1401
How to delete an upload request type	Deleting an Upload Request Type on page 1406
How to map an upload request type	Mapping an Upload Request Type on page 1405
How to view the details of an upload request type	Viewing the Upload Request Type Details on page 1407

Upload Request Type

The **Upload Request Type** zone displays the details of the upload request type. This zone contains the following sections:

- **Main** – This section provides basic information about the upload request type. It contains the following fields:

Field Name	Field Description
Upload Request Type	Displays the upload request type.
Upload Request Business Object	Indicates the business object that will be used to create the upload request. In addition, a context menu appears corresponding to this field which helps in navigating to other screens in the application. Note: It has a link. On clicking the link, the Business Object screen appears where you can view the details of the respective business object.
Description	Displays the description of the upload request type.
Detailed Description	Displays additional information about the upload request type.
Status	Indicates the status of the upload request type. The valid values are: <ul style="list-style-type: none"> • Active • Inactive
File Size (KB)	Displays the maximum size of file (in kilobytes) that you can upload using the upload request type. If you upload a file which exceeds the maximum file size, the system will not allow you to upload the file. Note: This field appears when you create upload request type using Adjustment Upload Request Type business object.
Defer Algorithm	Indicates the algorithm that will be triggered when you create entities (for example, adjustments) or approve the uploaded file (for example, adjustment data file). This algorithm checks whether the number of records in the uploaded file exceeds the online record process limit. If the number of records in the uploaded file does not exceed the online record process limit, the system creates the entities in the real time (i.e. immediately). However, if the number of records in the uploaded file exceeds the online record process limit, the system creates the entities (for example, adjustments) in the real time (i.e. immediately). However, if the number of records in the uploaded file exceeds the online record

Field Name	Field Description
	<p>process limit, the system creates the entities (for example, adjustments) in the deferred mode.</p> <p>Note: This field appears when you create upload request type using Adjustment Upload Request Type business object. It has a link. On clicking the link, the Algorithm screen appears where you can view the details of the respective algorithm. In Upload Request Type, online and deferred mode is used for processing the file if approval is not required. The defer algorithm is invoked if the number of records to be processed on the respective business object is more than the count specified on the algorithm then the status for number of records is changed from Validated to Deferred Processing else the status is changed to Processed.</p>
Approval Required	Indicates whether approval is required for a file which is uploaded using the upload request type.
Approval To Do Type	<p>Indicates that the To Do entry of the specified To Do type must be created when you submit the upload request for approval.</p> <p>Note: This field appears when the Approval Required check box is selected. It has a link. On clicking the link, the To Do Type screen appears with the details of the respective To Do type.</p>
Approval To Do Role	<p>Indicates that users with the specified To Do role can only approve or reject the upload request submitted for approval.</p> <p>Note: This field appears when the Approval Required check box is selected. On selecting the To Do Type, the To Do Roles configured on the To Do Type is populated. It has a link. On clicking the link, the To Do Role screen appears with the details of the respective To Do role.</p>
FK Reference	<p>Indicates the foreign key reference which specifies the created upload request type.</p> <p>Note: This field appears when you create upload request type using Upload Request Type business object. It has a link. On clicking the link, the Foreign Key Reference screen appears with the details of the respective foreign key.</p>

In addition, this section has the following columns:

Column Name	Column Description
Match Type	Indicates the match type using which the adjustments must be created when you upload a file using the upload request type. The valid values are: <ul style="list-style-type: none"> Contract Contract Type
	Note: The Match Type column is displayed for Adjustment Upload Request Business Object.
Algorithm	Indicates the algorithm that will be triggered when you upload an adjustment data file. This algorithm determines the contract against which the adjustment must be created.
	Note: It has a link. On clicking the link, the Algorithm screen appears with the details of the respective algorithm. The Algorithm column is displayed for Adjustment Upload Request Business Object.

- **Characteristics** – This section lists the characteristics of the upload request type. It contains the following columns:

Column Name	Column Description
Characteristic Type	Indicates the characteristic type.
Characteristic Value	Displays the value of the characteristic type.

- **Record Actions** – This section contains the following buttons:

Button Name	Button Description
Edit	Used to edit the details of the upload request type.
Delete	Used to delete the upload request type.
	Note: You can delete an upload request type when you have not uploaded a file (i.e. created an upload request) using the upload request type.
Duplicate	Used to create a new upload request type using an existing upload request type.

- **Record Information** – This section contains the following fields:

Field Name	Field Description
Business Object	Indicates the business object using which the upload request type is created. In addition, a context menu appears corresponding to this field which helps in navigating to other screens in the application.
	Note: It has a link. On clicking the link, the Business Object screen appears where you can view the details of the respective business object.

By default, the **Upload Request Type** zone does not appear in the **Upload Request Type** screen. It appears when you click the **Broadcast** (📡) icon corresponding to an upload request type in the **Upload Request Type List** zone.

Related Topics

For more information on...	See...
How to define an upload request type	Defining an Upload Request Type on page 1392
How to define a characteristic for an upload request type	Defining a Characteristic for an Upload Request Type on page 1397
How to edit an upload request type	Editing an Upload Request Type on page 1398
How to copy an upload request type	Copying an Upload Request Type on page 1401
How to delete an upload request type	Deleting an Upload Request Type on page 1406
How to map an upload request type	Mapping an Upload Request Type on page 1405
How to view the details of an upload request type	Viewing the Upload Request Type Details on page 1407

Defining an Upload Request Type

Prerequisites

To define an upload request type, you should have:

- Upload request business objects defined in the application
- Defer algorithm for adjustment is defined using the **C1-UPLDEFEVL** algorithm type
- Defer algorithm for upload is defined using the **C1-DEFERUPLD** algorithm type
- Algorithm defined using the **C1-MTCIALG** algorithm type when you want to create adjustment using the **Contract** match type
- **C1-ADJUP** To Do type assigned to a To Do role whose users must receive To Do while submitting an adjustment upload request for approval
- **C1-BCUUR** To Do type assigned to a To Do role whose users must receive To Do while submitting a bill cycle update upload request for approval
- **C1-CRUUR** To Do type assigned to a To Do role whose users must receive To Do while submitting a contract rider update upload request for approval
- **C1-HLDUR** To Do type assigned to a To Do role whose users must receive To Do while submitting a hold upload request for approval
- **C1-REFUR** To Do type assigned to a To Do role whose users must receive To Do while submitting a refund upload request for approval
- **C1-WOUR** To Do type assigned to a To Do role whose users must receive To Do while submitting a write off upload request for approval
- **C1-BCUR** To Do type assigned to a To Do role whose users must receive To Do while submitting a billable charge upload request for approval
- **C1-RPUR** To Do type assigned to a To Do role whose users must receive To Do while submitting a reinstatement upload request for approval
- **C1-BGSRT** To Do type assigned to a To Do role whose users must receive To Do while submitting a bill group sorting upload request for approval
- **C1-BGDVP** To Do type assigned to a To Do role whose users must receive To Do while submitting a bill group derivation and pricing parameters upload request for approval

Procedure

To define an upload request type:

1. Click the **Admin** link in the **Application** toolbar.
A list appears.
2. From the **Admin** menu, select **U** and then click **Upload Request Type**.
A sub-menu appears.
3. Click the **Add** option from the **Upload Request Type** sub-menu.

The **Select Business Object** screen appears. It contains the following field:

Field Name	Field Description	Mandatory (Yes or No)
Upload Request Type Business Object	Used to indicate the business object that you want to use to create the upload request type.	Yes

Tip: Alternatively, you can access the **Select Business Object** screen by clicking the **Add** button in the **Page Title** area of the **Upload Request Type** screen.

Note: The **Select Business Object** screen appears when there are multiple upload request type business objects defined in the application. If there is only one upload request type business object defined in the application, the **Upload Request Type** screen appears.

4. Select the required upload request type business object from the respective field.
5. Click **OK**.

The **Upload Request Type** screen appears. It contains the following sections:

- **Main** – Used to specify basic details about the upload request type.
- **Characteristics** – Used to define the characteristics for the upload request type.

The **Main** section contains the following fields:

Field Name	Field Description	Mandatory (Yes or No)
Upload Request Type	Used to specify the upload request type.	Yes
Upload Request Type Business Object	Indicates the upload request type business object used while defining the upload request type.	Not applicable
Upload Request Business Object	Used to indicate the business object that you want to use while creating the upload request.	Yes
Description	Used to specify the description for the upload request type.	Yes
Detailed Description	Used to specify additional information about the upload request type.	No
Status	Used to indicate the status of the upload request type. The valid values are: <ul style="list-style-type: none"> • Active • Inactive 	Yes
File Size (KB)	Used to specify the maximum size of file (in kilobytes) that you can upload using the upload request type. If	Yes

Field Name	Field Description	Mandatory (Yes or No)
	<p>you upload a file which exceeds the maximum file size, the system will not allow you to upload the file.</p> <p>Note: This field appears when Adjustment Upload Request Type business object is selected.</p>	
Defer Algorithm	<p>Used to attach an algorithm that will be triggered when you create entities (for example, adjustments) or approve the uploaded file (for example, adjustment data file). This algorithm checks whether the number of records in the uploaded file exceeds the online record process limit (defined in the Defer algorithm). If the number of records in the uploaded file does not exceed the online record process limit, the system creates the entities (for example, adjustments) in the real time (i.e. immediately). However, if the number of records in the uploaded file exceeds the online record process limit, the system creates the entities (for example, adjustments) in the deferred mode.</p> <p>Note:</p> <p>Deferred mode means in the background when the Upload Request Periodic Monitor (C1-UPLRQ) batch is invoked. You can configure the Upload Request Periodic Monitor (C1-UPLRQ) batch such that it is executed at regular intervals. When the Upload Request Periodic Monitor (C1-UPLRQ) batch is invoked, the system checks whether there are any upload requests in the Deferred status. If there is an upload request in the Deferred status, the system creates the entities (for example, adjustments).</p> <p>This field appears when Adjustment Upload Request Type business object is selected.</p> <p>In Upload Request Type, online and deferred mode is used for processing the file if approval is not required. The defer algorithm is invoked if the number of records to be processed on the respective business object is more than the count specified on the algorithm then the status for number of records is changed from Validated to Deferred Processing else the status is changed to Processed.</p> <p>Note: The Search (🔍) icon appears corresponding to this field. On clicking the Search icon, the Algorithm Search window appears.</p>	Yes
Entity Business Object	Used to indicate for creating Business Object of the entity using the upload request type.	No

Field Name	Field Description	Mandatory (Yes or No)																						
	<p>Note:</p> <p>The Search (🔍) icon appears corresponding to this field. On clicking the Search icon, the Business Object Search window appears.</p> <p>This field appears when Upload Request Type business object is selected.</p>																							
Approval Required	Used to indicate whether approval is required for a file which is uploaded using the upload request type.	No																						
Approval To Do Type	<p>Used to indicate that To Do entry of the specified To Do type must be created when you submit the upload request for approval.</p> <p>Note:</p> <p>The Search (🔍) icon appears corresponding to this field. On clicking the Search icon, the To Do Type Search window appears.</p> <p>The following table lists the To Do type using which the To Do must be generated for the different upload requests:</p> <table border="1" data-bbox="602 989 1179 1577"> <thead> <tr> <th>Upload Request</th> <th>To Do Type</th> </tr> </thead> <tbody> <tr> <td>Adjustment</td> <td>C1-ADJUP</td> </tr> <tr> <td>Bill Cycle Update</td> <td>C1-BCUUR</td> </tr> <tr> <td>Billable Charge</td> <td>C1-BCUR</td> </tr> <tr> <td>Contract Rider Update</td> <td>C1-CRUUR</td> </tr> <tr> <td>Hold Request</td> <td>C1-HLDUR</td> </tr> <tr> <td>Refund Request</td> <td>C1-REFUR</td> </tr> <tr> <td>Write Off Request</td> <td>C1-WOUR</td> </tr> <tr> <td>Policy Reinstatement</td> <td>C1-RPUR</td> </tr> <tr> <td>Bill Group Sorting</td> <td>C1-BGSRT</td> </tr> <tr> <td>Bill Group Derivation and Pricing Parameters</td> <td>C1-BGDVP</td> </tr> </tbody> </table>	Upload Request	To Do Type	Adjustment	C1-ADJUP	Bill Cycle Update	C1-BCUUR	Billable Charge	C1-BCUR	Contract Rider Update	C1-CRUUR	Hold Request	C1-HLDUR	Refund Request	C1-REFUR	Write Off Request	C1-WOUR	Policy Reinstatement	C1-RPUR	Bill Group Sorting	C1-BGSRT	Bill Group Derivation and Pricing Parameters	C1-BGDVP	<p>Yes (Conditional)</p> <p>Note: This field is required when the Approval Required check box is selected.</p>
Upload Request	To Do Type																							
Adjustment	C1-ADJUP																							
Bill Cycle Update	C1-BCUUR																							
Billable Charge	C1-BCUR																							
Contract Rider Update	C1-CRUUR																							
Hold Request	C1-HLDUR																							
Refund Request	C1-REFUR																							
Write Off Request	C1-WOUR																							
Policy Reinstatement	C1-RPUR																							
Bill Group Sorting	C1-BGSRT																							
Bill Group Derivation and Pricing Parameters	C1-BGDVP																							
Approval To Do Role	Used to indicate that users with the specified To Do role can only approve the upload request submitted for approval.	<p>Yes (Conditional)</p> <p>Note: This field is required when the Approval Required check box is selected.</p>																						
FK Reference	Used to indicate the FK Reference code to display the entity information.	No																						

Field Name	Field Description	Mandatory (Yes or No)
	<p>Note:</p> <p>The Search (🔍) icon appears corresponding to this field. On clicking the Search icon, the Foreign Key Search window appears.</p> <p>This field appears when Upload Request Type business object is selected.</p>	

In addition, this section contains the following fields in the grid:

Note: This field appears when **Adjustment Upload Request Type** business object is selected.

Field Name	Field Description	Mandatory (Yes or No)
Match Type	<p>Used to indicate the match type using which you want to create adjustments when you upload a file using the upload request type. The valid values are:</p> <ul style="list-style-type: none"> • Contract • Contract Type 	<p>Yes (Conditional)</p> <p>Note: This field is required when you select the Adjustment Upload Request option from the Upload Request Business Object list.</p>
Algorithm	<p>Used to attach an algorithm that will be triggered when you upload an adjustment data file. This algorithm determines the contract against which the adjustment must be created.</p> <p>Note: The Search (🔍) icon appears corresponding to this field. On clicking the Search icon, the Algorithm Search window appears.</p>	<p>Yes (Conditional)</p> <p>Note: This field is required when you select the match type from the respective field.</p>

6. Enter the required details.

Note:

You can search for an algorithm by clicking the **Search** (🔍) icon corresponding to the respective field.

If you want to associate more than one match type with the upload request type, click the **Add** (+) icon and then specify the details. However, if you want to remove a match type from the upload request type, click the **Delete** (🗑️) icon corresponding to the match type.

7. Define characteristics for the upload request type, if required.

8. Click **Save**.

The upload request type is defined.

Related Topics

For more information on...	See...
Upload Request Type screen	Upload Request Type on page 1387
Upload Request Type List zone	Upload Request Type List on page 1388

For more information on...	See...
How to define a characteristic for an upload request type	Defining a Characteristic for an Upload Request Type on page 1397

Defining a Characteristic for an Upload Request Type

Prerequisites

To define a characteristic for an upload request type, you should have:

- Characteristic types defined in the application (where the characteristic entity is set to Upload Request Type)

Procedure

To define a characteristic for an upload request type:

1. Ensure that the **Characteristics** section is expanded when you are defining, editing, or copying an upload request type.

The **Characteristics** section contains the following fields:

Field Name	Field Description	Mandatory (Yes or No)
Characteristic Type	Used to indicate the characteristic type.	Yes (Conditional)
	Note: The list includes only those characteristic types where the characteristic entity is set to Upload Request Type.	Note: This field is required when you are defining a characteristic for the upload request type.
Characteristic Value	Used to specify the value for the characteristic type.	Yes (Conditional)
	Note: On specifying the value for a predefined characteristic type, the description of the characteristic value appears corresponding to the Characteristic Value field.	Note: This field is required when you are defining a characteristic for the upload request type.

2. Enter the required details.

Note: If you select a predefined characteristic type, the **Search** (🔍) icon appears corresponding to the **Characteristic Value** field. On clicking the **Search** icon, you can search for a predefined characteristic value.

3. If you want to define more than one characteristic for the upload request type, click the **Add** (+) icon and then repeat step 2.

Note: However, if you want to remove a characteristic from the upload request type, click the **Delete** (🗑️) icon corresponding to the characteristic.

Related Topics

For more information on...	See...
How to define an upload request type	Defining an Upload Request Type on page 1392
How to edit an upload request type	Editing an Upload Request Type on page 1398

For more information on...	See...
How to copy an upload request type	Copying an Upload Request Type on page 1401

Editing an Upload Request Type

Prerequisites

To edit an upload request type, you should have:

- Upload request business objects defined in the application
- Defer algorithm for adjustment is defined using the **C1-UPLDEFEVL** algorithm type
- Defer algorithm for upload is defined using the **C1-DEFERUPLD** algorithm type
- Algorithm defined using the **C1-MTCIALG** algorithm type when you want to create adjustment using the Contract match type
- Algorithm defined using the **C1-MTCTALG** algorithm type when you want to create adjustment using the Contract Type match type
- **C1-ADJUP** To Do type assigned to a To Do role whose users must receive To Do entries generated while submitting an adjustment upload request for approval
- **C1-UPLAPPENT** To Do type assigned to a To Do role whose users must receive To Do generated while submitting an upload request for approval

Procedure

To edit an upload request type:

1. Click the **Admin** link in the **Application** toolbar.
A list appears.
2. From the **Admin** menu, select **U** and then click **Upload Request Type**.
A sub-menu appears.
3. In the **Upload Request Type List** zone, click the **Edit**  icon in the **Edit** column corresponding to the upload request type whose details you want to edit.

The **Upload Request Type** screen appears. It contains the following sections:

- **Main** – Used to specify basic details about the upload request type.
- **Characteristics** – Used to define the characteristics for the upload request type.

The **Main** section contains the following fields:

Field Name	Field Description	Mandatory (Yes or No)
Upload Request Type	Displays the upload request type.	Not applicable
Upload Request Type Business Object	Indicates the upload request type business object used while defining the upload request type.	Not applicable
Upload Request Business Object	Used to specify the business object that you want to use while creating the upload request.	Yes
Description	Used to specify the description for the upload request type.	Yes
Detailed Description	Used to specify additional information about the upload request type.	No

Field Name	Field Description	Mandatory (Yes or No)
Status	<p>Used to indicate the status of the upload request type. The valid values are:</p> <ul style="list-style-type: none"> • Active • Inactive 	Yes
File Size (KB)	<p>Used to specify the maximum size of file (in kilobytes) that you can upload using the upload request type. If you upload a file which exceeds the maximum file size, the system will not allow you to upload the file.</p> <p>Note: This field appears when the business object is Adjustment Upload Request Type.</p>	Yes
Defer Algorithm	<p>Used to attach an algorithm that will be triggered when you create entities (for example, adjustments) or approve the uploaded file (for example, adjustment data file). This algorithm checks whether the number of records in the uploaded file exceeds the online record process limit (defined in the Defer algorithm). If the number of records in the uploaded file does not exceed the online record process limit, the system creates the entities (for example, adjustments) in the real time (i.e. immediately). However, if the number of records in the uploaded file exceeds the online record process limit, the system creates the entities (for example, adjustments) in the deferred mode.</p> <p>Note:</p> <p>Deferred mode means in the background when the Upload Request Periodic Monitor (C1-UPLRQ) batch is invoked. You can configure the Upload Request Periodic Monitor (C1-UPLRQ) batch such that it is executed at regular intervals. When the Upload Request Periodic Monitor (C1-UPLRQ) batch is invoked, the system checks whether there are any upload requests in the Deferred status. If there is an upload request in the Deferred status, the system creates the entities (for example, adjustments).</p> <p>This field appears when the business object is Adjustment Upload Request Type.</p>	Yes
Entity Business Object	Used to indicate for creating Business Object of the entity using the upload request type.	No

Field Name	Field Description	Mandatory (Yes or No)
	<p>Note: The Search (🔍) icon appears corresponding to this field. On clicking the Search icon, the Business Object Search window appears.</p>	
Approval Required	Used to indicate whether approval is required for a file which is uploaded using the upload request type.	No
Approval To Do Type	<p>Used to indicate that To Do entry of the specified To Do type must be created when you submit the upload request for approval.</p> <p>Note: The Search (🔍) icon appears corresponding to this field. On clicking the Search icon, the To Do Type Search window appears.</p>	<p>Yes (Conditional)</p> <p>Note: This field is required when the Approval Required check box is selected.</p>
Approval To Do Role	Used to indicate that users with the specified To Do role can only approve the upload request submitted for approval.	<p>Yes (Conditional)</p> <p>Note: This field is required when the Approval Required check box is selected.</p>
FK Reference	<p>Used to indicate the FK Reference code to display the entity information.</p> <p>Note:</p> <p>The Search (🔍) icon appears corresponding to this field. On clicking the Search icon, the Foreign Key Search window appears.</p> <p>This field appears when the business object is Upload Request Type.</p>	No

In addition, this section contains the following fields in the grid:

Note: The below section appears when the business object is **Adjustment Upload Request Type**.

Field Name	Field Description	Mandatory (Yes or No)
Match Type	<p>Used to indicate the match type using which you want to create adjustments when you upload a file using the upload request type. The valid values are:</p> <ul style="list-style-type: none"> Contract Contract Type 	<p>Yes (Conditional)</p> <p>Note: This field is required when you select the Adjustment Upload Request option from the Upload Request Business Object list.</p>
Algorithm	Used to attach an algorithm that will be triggered when you upload an adjustment data file. This	Yes (Conditional)

Field Name	Field Description	Mandatory (Yes or No)
	algorithm determines the contract against which the adjustment must be created.	Note: This field is required when you select the match type from the respective field.

Tip: Alternatively, you can click the **Edit** button in the **Upload Request Type** zone to edit the details of the upload request type.

4. Modify the required details.

Note:

You can search for an algorithm by clicking the **Search** (🔍) icon corresponding to the respective field.

If you want to associate more than one match type with the upload request type, click the **Add** (+) icon and then specify the details. However, if you want to remove a match type from the upload request type, click the **Delete** (🗑️) icon corresponding to the match type.

5. Define, edit, or remove characteristics of the upload request type, if required.

6. Click **Save**.

The changes made to the upload request type are saved.

Related Topics

For more information on...	See...
Upload Request Type screen	Upload Request Type on page 1387
Upload Request Type List zone	Upload Request Type List on page 1388
Upload Request Type zone	Upload Request Type on page 1389
How to define a characteristic for an upload request type	Defining a Characteristic for an Upload Request Type on page 1397

Copying an Upload Request Type

Instead of creating an upload request type from scratch, you can create a new upload request type using an existing upload request type. This is possible through copying an upload request type. On copying an upload request type, the details including the match types (only for adjustments) and characteristics are copied to the new upload request type. You can then edit the details, if required.

Prerequisites

To copy an upload request type, you should have:

- Upload request type (whose copy you want to create) defined in the application
- Upload request business objects defined in the application
- Defer algorithm defined using the **C1-UPLDEFEV** algorithm type
- Defer algorithm for upload is defined using the **C1-DEFERUPLD** algorithm type
- Algorithm defined using the **C1-MTCIALG** algorithm type when you want to create adjustment using the Contract match type
- Algorithm defined using the **C1-MTCTALG** algorithm type when you want to create adjustment using the Contract Type match type

- **C1-ADJUP** To Do type assigned to a To Do role whose users must receive To Do entries generated while submitting an upload request for approval
- **C1-UPLAPPENT** To Do type assigned to a To Do role whose users must receive To Do generated while submitting an upload request for approval

Procedure

To copy an upload request type:

1. Click the **Admin** link in the **Application** toolbar.
A list appears.
2. From the **Admin** menu, select **U** and then click **Upload Request Type**.
A sub-menu appears.
3. In the **Upload Request Type List** zone, click the **Duplicate** (📄) icon in the **Duplicate** column corresponding to the upload request type whose copy you want to create.

The **Upload Request Type** screen appears. It contains the following sections:

- **Main** – Used to specify basic details about the upload request type.
- **Characteristics** – Used to define the characteristics for the upload request type.

The **Main** section contains the following fields:

Field Name	Field Description	Mandatory (Yes or No)
Upload Request Type	Used to specify the upload request type.	Yes
Upload Request Type Business Object	Indicates the upload request type business object used while defining the upload request type (whose copy you want to create).	Not applicable
Upload Request Business Object	Used to specify the business object that you want to use while creating the upload request.	Yes
Description	Used to specify the description for the upload request type.	Yes
Detailed Description	Used to specify additional information about the upload request type.	No
Status	Used to indicate the status of the upload request type. The valid values are: <ul style="list-style-type: none"> • Active • Inactive 	Yes
File Size (KB)	Used to specify the maximum size of file (in kilobytes) that you can upload using the upload request type. If you upload a file which exceeds the maximum file size, the system will not allow you to upload the file.	Yes
	Note: This field appears when the business object is Adjustment Upload Request Type .	
Defer Algorithm	Used to attach an algorithm that will be triggered when you create entities (for example, adjustments) or approve the uploaded file (for	Yes

Field Name	Field Description	Mandatory (Yes or No)
	<p>example, adjustment data file). This algorithm checks whether the number of records in the uploaded file exceeds the online record process limit (defined in the Defer algorithm). If the number of records in the uploaded file does not exceed the online record process limit, the system creates the entities (for example, adjustments) in the real time (i.e. immediately). However, if the number of records in the uploaded file exceeds the online record process limit, the system creates the entities (for example, adjustments) in the deferred mode.</p> <p>Note: Deferred mode means in the background when the Upload Request Periodic Monitor (C1-UPLRQ) batch is invoked. You can configure the Upload Request Periodic Monitor (C1-UPLRQ) batch such that it is executed at regular intervals. When the Upload Request Periodic Monitor (C1-UPLRQ) batch is invoked, the system checks whether there are any upload requests in the Deferred status. If there is an upload request in the Deferred status, the system creates the entities (for example, adjustments). This field appears when the business object is Adjustment Upload Request Type.</p>	
Entity Business Object	<p>Used to indicate to create the copy of Business Object of the entity using the upload request type.</p> <p>Note: The Search (🔍) icon appears corresponding to this field. On clicking the Search icon, the Business Object Search window appears. This field appears when the business object is Upload Request Type.</p>	No
Approval Required	Used to indicate whether approval is required for a file which is uploaded using the upload request type.	No
Approval To Do Type	<p>Used to indicate that To Do entry of the specified To Do type must be created when you submit the upload request for approval.</p> <p>Note: The Search (🔍) icon appears corresponding to this field. On clicking the Search icon, the To Do Type Search window appears.</p>	<p>Yes (Conditional)</p> <p>Note: This field is required when the Approval Required check box is selected.</p>

Field Name	Field Description	Mandatory (Yes or No)
Approval To Do Role	Used to indicate that users with the specified To Do role can only approve the upload request submitted for approval.	Yes (Conditional) Note: This field is required when the Approval Required check box is selected.
FK Reference	Used to indicate the FK Reference code to display the entity information. Note: The Search (🔍) icon appears corresponding to this field. On clicking the Search icon, the Foreign Key Search window appears. This field appears when the business object is Upload Request Type .	No

In addition, this section contains the following fields in the grid:

Note: The below section appears when the business object is **Adjustment Upload Request Type**.

Field Name	Field Description	Mandatory (Yes or No)
Match Type	Used to indicate the match type using which you want to create adjustments when you upload a file using the upload request type. The valid values are: <ul style="list-style-type: none"> Contract Contract Type 	Yes (Conditional) Note: This field is required when you select the Adjustment Upload Request option from the Upload Request Business Object list.
Algorithm	Used to attach an algorithm that will be triggered when you upload an adjustment data file. This algorithm determines the contract against which the adjustment must be created.	Yes (Conditional) Note: This field is required when you select the match type from the respective field.

Tip: Alternatively, you can click the **Duplicate** button in the **Upload Request Type** zone to create a copy of the upload request type.

4. Enter the required details.

Note:

You can search for an algorithm by clicking the **Search** (🔍) icon corresponding to the respective field.

If you want to associate more than one match type with the upload request type, click the **Add** (+) icon and then specify the details. However, if you want to remove a match type from the upload request type, click the **Delete** (🗑️) icon corresponding to the match type.

5. Define, edit, or remove characteristics of the upload request type, if required.

6. Click **Save**.

The new upload request type is defined.

Related Topics

For more information on...	See...
Upload Request Type screen	Upload Request Type on page 1387
Upload Request Type List zone	Upload Request Type List on page 1388
Upload Request Type zone	Upload Request Type on page 1389
How to define a characteristic for an upload request type	Defining a Characteristic for an Upload Request Type on page 1397

Mapping an Upload Request Type

Prerequisites

To map an upload request type, you should have:

- Upload request type (whose columns you want to map with the CSV file) defined in the application
- Upload request business objects defined in the application

Note: Once an upload request type is used for creating an upload request, then mapping for the same cannot be edited. Duplicating the upload request type will not duplicate the mapping data. You have to add the mapping details manually after duplicating an upload request type.

Procedure

To map an upload request type:

1. Click the **Admin** link in the **Application** toolbar.
A list appears.
2. From the **Admin** menu, select **U** and then click **Upload Request Type**.
A sub-menu appears.
3. In the **Upload Request Type List** zone, click the **Mapping** () icon in the **Mapping** column corresponding to the upload request type whose columns you want to map with the CSV file.

The **Upload Request Type Mapping** screen appears. It contains the following field:

Note: The **Mapping** icon is applicable only for upload request type created using **Upload Request Type (C1-UplRequestType)** business object, and it is not applicable for upload request type created using **Adjustment Upload Request Type (C1-AdjRequestType)** business object.

Field Name	Field Description	Mandatory (Yes or No)
Upload Request Type	Indicates the upload request type.	Not applicable

The **Upload Request Type Mapping** screen also contains the following columns:

Column Name	Column Description	Mandatory (Yes or No)
CSV Column Header	Used to specify the rows correspond to the columns in CSV file.	Yes (Conditional)

Column Name	Column Description	Mandatory (Yes or No)
		Note: This column is required when you search the Data Records zone in the Upload Request screen.
Use for Searching	Used to indicate whether the defined CSV Column Header is searchable or not.	Yes (Conditional)
	Note: Upto 10 rows can be selected as searchable rows.	Note: This column is required to be selected to be shown in the Data Records zone in the Upload Request screen
Sequence Number	Used to specify the sequence of the searchable fields.	Yes (Conditional)
	Note: Searchable rows should have sequence less than or equal to 10.	Note: This column is required to be selected to be shown sequentially in the Data Records zone in the Upload Request screen

4. Enter the required details.

Note: If you want to add more than one column names mapped to the upload request type, click the **Add (+)** icon and then specify the details. However, if you want to remove a column name mapped to the upload request type, click the **Delete (🗑)** icon corresponding to the column header.

5. Click **Save**.

The columns are mapped to the CSV files for upload request type.

Related Topics

For more information on...	See...
Upload Request Type screen	Upload Request Type on page 1387
Upload Request Type List zone	Upload Request Type List on page 1388
Upload Request Type zone	Upload Request Type on page 1389

Deleting an Upload Request Type

Procedure

To delete an upload request type:

- Click the **Admin** link in the **Application** toolbar.
A list appears.
- From the **Admin** menu, select **U** and then click **Upload Request Type**.
A sub-menu appears.
- In the **Upload Request Type List** zone, click the **Delete (🗑)** icon in the **Delete** column corresponding to the upload request type that you want to delete.
A message appears confirming whether you want to delete the upload request type.

Note: You can delete an upload request type when you have not uploaded a file (i.e. created an upload request) using the upload request type.

Tip: Alternatively, you can click the **Delete** button in the **Upload Request Type** zone to delete the upload request type.

4. Click **OK**.

The upload request type is deleted.

Related Topics

For more information on...	See...
Upload Request Type screen	Upload Request Type on page 1387
Upload Request Type List zone	Upload Request Type List on page 1388
Upload Request Type zone	Upload Request Type on page 1389

Viewing the Upload Request Type Details

Procedure

To view the details of an upload request type:

1. Click the **Admin** link in the **Application** toolbar.
A list appears.
2. From the **Admin** menu, select **U** and then click **Upload Request Type**.
A sub-menu appears.
3. Click the **Search** option from the **Upload Request Type** sub-menu.
The **Upload Request Type** screen appears.
4. In the **Upload Request Type List** zone, click the **Broadcast** () icon corresponding to the upload request type whose details you want to view.
The **Upload Request Type** zone appears.
5. View the details of the upload request type in the **Upload Request Type** zone.

Related Topics

For more information on...	See...
Upload Request Type screen	Upload Request Type on page 1387
Upload Request Type List zone	Upload Request Type List on page 1388
Upload Request Type zone	Upload Request Type on page 1389

Adjustment Upload Request (Used for Searching)

The **Adjustment Upload Request** screen allows you to search for an adjustment upload request using various search criteria. Through this screen, you can:

- Upload an adjustment data file
- Cancel an adjustment data file
- View the details of an adjustment upload request
- View all adjustment records which are uploaded through an adjustment data file
- Create adjustments for an adjustment data file
- Submit an adjustment data file for approval
- Approve or reject an adjustment data file
- View the log of an adjustment upload request
- Add a log entry for an adjustment upload request

This screen consists of the following zones:

- [Search Adjustment Upload Request](#) on page 1408
- [Adjustment Upload Request](#) on page 1416
- [Adjustment Data Records](#) on page 1419

Search Adjustment Upload Request

The **Search Adjustment Upload Request** zone allows you to search for an adjustment upload request using various search criteria. This zone contains the following two sections:

- **Search Criteria** — The fields in the **Search Criteria** section change depending on the query option selected. At present, there is only one query option named **Upload Request**. On selecting the **Upload Request** query option, the **Search Criteria** section contains the following fields:

Field Name	Field Description	Mandatory (Yes or No)
Upload Request Type	Used to search adjustment upload requests which are created using a particular upload request type.	No
Status	Used to search adjustment upload requests with a particular status. The valid values are: <ul style="list-style-type: none"> • Approved • Cancelled • Completed • Create Adjustment • Creating Adjustment • Deferred • Pending • Rejected • Pending For Approval 	No
Upload From Date	Used to search adjustment upload requests which are created from a particular date onwards.	No
	Note: By default, the current date appears in this field.	

Field Name	Field Description	Mandatory (Yes or No)
To	Used to search adjustment upload requests which are created till a particular date.	No
	Note: By default, the current date appears in this field.	
File Name	Used to search an adjustment upload request which is created while uploading an adjustment data file.	No

Note: You must specify at least one search criterion while searching for an adjustment upload request.

- **Search Results** — On clicking the **Refresh** button, the search results appear based on the specified search criteria. The **Search Results** section contains the following columns:

Column Name	Column Description
Upload Date	Displays the date and time when the adjustment data file is uploaded in the system.
Upload Request Information	Displays information about the adjustment upload request.
	Note: It has a link. On clicking the link, the Adjustment Upload Request screen appears where you can view the details of the respective upload request.
Status	Indicates the status of the adjustment upload request.
Upload Request Type	Indicates the upload request type using which the adjustment data file is uploaded in the system.
File Name	Displays the name of the adjustment data file.

You can upload an adjustment data file by clicking the **Upload** link in the upper right corner of this zone.

Related Topics

For more information on...	See...
How to search for an adjustment upload request	Searching for an Adjustment Upload Request on page 1409
How to upload an adjustment data file	Uploading an Adjustment Data File on page 1410
How to view the details of an adjustment upload request	Viewing the Adjustment Upload Request Details on page 1415

Searching for an Adjustment Upload Request

Prerequisites

To search for an adjustment upload request, you should have:

- Upload request types defined in the application

Procedure

To search for an adjustment upload request:

1. Click the **Menu** link in the **Actions/Navigation** area.
A list appears.
2. Select the **Main Menu** option from the list.

- From the **Main Menu**, select **Billing Management** and then click **Adjustment Upload Request**.

The **Adjustment Upload Request** screen appears.

- Enter the search criteria in the **Search Adjustment Upload Request** zone.

Note: ORMB search engine supports wildcard search, where you can substitute the percentage (%) symbol as a stand in for any word or letter in a search criteria. You can use the ‘%’ wildcard character in all input fields except the date and ID fields. The ‘%’ wildcard character is suffixed automatically at the end of the partial search criteria. Therefore, you may or may not specify the wildcard character at the end of the partial search criteria. However, you have to prefix the wildcard character manually wherever required.

- Click **Search**.

A list of adjustment upload requests that meet the search criteria appears in the **Search Results** section.

Related Topics

For more information on...	See...
Adjustment Upload Request screen	Adjustment Upload Request (Used for Searching) on page 1407
Search Adjustment Upload Request zone	Search Adjustment Upload Request on page 1408

Uploading an Adjustment Data File

Prerequisites

To upload an adjustment data file, you should have:

- Upload request types defined in the application
- Adjustment data in the required CSV file format

Procedure

To upload an adjustment data file:

- Click the **Menu** link in the **Actions/Navigation** area.

A list appears.

- Select the **Main Menu** option from the list.
- From the **Main Menu**, select **Billing Management** and then click **Adjustment Upload Request**.

The **Adjustment Upload Request** screen appears.

- Click the **Upload** link in the upper right corner of the **Search Adjustment Upload Request** zone.

The **Upload Adjustment Data File** screen appears. It contains the following fields:

Field Name	Field Description	Mandatory (Yes or No)
Upload Request Type	Used to indicate the upload request type using which you want to upload the adjustment data file.	Yes
	Note: The list includes only those upload request types which are in the Active status.	

Field Name	Field Description	Mandatory (Yes or No)
Replace Existing File	Used to indicate whether you want to replace any existing file in the system. You must select this check box when you want to upload the same file once again.	No
	Note: You can replace an existing file when the adjustment upload request is in the Pending or Cancelled status.	
File Name	Used to specify the name and path of the adjustment data file that you want to upload.	Yes
	Note: You can also click the Browse button corresponding to this field to browse to the location where the adjustment data file is available in the system.	

5. Select the upload request type using which you want to upload the adjustment data file.

6. Click the **Browse** button corresponding to the **File Name** field.

The **Choose File to Upload** dialog box appears.

7. Browse to the location where the adjustment data file that you want to upload is available.

8. Click **Open**.

The adjustment data file name and path appears in the **File Name** field.

9. Click **Submit**.

A grid appears which helps you to preview all records in the adjustment data file. It contains the following columns:

Column Name	Column Description
Errors	Indicates the reason why the adjustment record is invalid. If there are multiple reasons, the comma-separated list of error messages appears in this column.
	Note: This column appears when you click the Save button.
Account Identifier Type	Indicates the account identifier type.
Account Identifier	Displays the value of the account identifier type.
Account ID	Indicates the account for which the adjustment must be created.
Match Type	Indicates the match type using which the adjustment must be created.
Match Value	Indicates the entity (such as contract, contract type, and so on) against which the adjustment must be created.
Adjustment Type	Indicates the adjustment type using which the adjustment must be created.
Adjustment Amount	Displays the adjustment amount.
Currency Code	Indicates the currency in which the adjustment must be created.
Comments	Displays additional information about the adjustment.
Bill ID	Indicates the bill on which the adjustment must be created.
Arrears Date	Displays the date from when the amount is outstanding on the bill.
Char Type 1	Indicates the characteristic that must be defined for the adjustment.

Column Name	Column Description
Char Value 1	Displays the value of the characteristic type.
Char Type 2	Indicates the characteristic that must be defined for the adjustment.
Char Value 2	Displays the value of the characteristic type.
Char Type 3	Indicates the characteristic that must be defined for the adjustment.
Char Value 3	Displays the value of the characteristic type.
Char Type 4	Indicates the characteristic that must be defined for the adjustment.
Char Value 4	Displays the value of the characteristic type.
Char Type 5	Indicates the characteristic that must be defined for the adjustment.
Char Value 5	Displays the value of the characteristic type.

Note: If you upload an adjustment data file which exceeds the maximum file size defined in the upload request type, the system will not allow you to upload the file.

10. Click **Save**.

The validation process starts immediately. The adjustment record is considered as invalid when:

- Account ID, Account Identifier Type, Account Identifier, Adjustment Type, Currency, Bill ID, Characteristic Type, Characteristic Value, or Match Type is invalid.
- Match Type, Match Value, Adjustment Type, Adjustment Amount, Currency, or Characteristic Value is missing.
- Contract ID does not exist in the system.
- The contract is in the **Cancelled** status.
- Contract type does not exist in the system.
- Account Identifier Type, Account Identifier, or Account ID is missing when the match type is Contract Type.
- No active contract of the specified contract type is available.
- Adjustment amount precision does not match the precision (decimal positions) defined for the currency.
- The adjustment type is not included in the adjustment type profile which is attached to the contract type.
- The characteristic type is not associated with the adjustment type.

If there is an invalid record in the adjustment data file, you will not be able to upload the file.

Related Topics

For more information on...	See...
Adjustment Upload Request screen	Adjustment Upload Request (Used for Searching) on page 1407
Search Adjustment Upload Request zone	Search Adjustment Upload Request on page 1408

Replacing an Adjustment Data File

Prerequisites

To replace an existing adjustment data file, you should have:

- Upload request types defined in the application

- Adjustment data in the required CSV file format

Procedure

To replace an existing adjustment data file:

1. Click the **Menu** link in the **Actions/Navigation** area.
A list appears.
2. Select the **Main Menu** option from the list.
3. From the **Main Menu**, select **Billing Management** and then click **Adjustment Upload Request**.
The **Adjustment Upload Request** screen appears.
4. Click the **Upload** link in the upper right corner of the **Search Adjustment Upload Request** zone.

The **Adjustment Upload Data File** screen appears. It contains the following fields:

Field Name	Field Description	Mandatory (Yes or No)
Upload Request Type	Used to indicate the upload request type using which you want to upload the adjustment data file.	Yes
	Note: The list includes only those upload request types which are in the Active status.	
Replace Existing File	Used to indicate whether you want to replace any existing file in the system. You must select this check box when you want to upload the same file once again.	No
	Note: You can replace an existing file when the adjustment upload request is in the Pending or Cancelled status.	
File Name	Used to specify the name and path of the adjustment data file that you want to upload.	Yes
	Note: You can also click the Browse button corresponding to this field to browse to the location where the adjustment data file is available in the system.	

5. Select the upload request type using which you want to upload the adjustment data file.
6. Select the **Replace Existing File** check box to indicate that you want to replace an existing adjustment data file.
7. Click the **Browse** button corresponding to the **File Name** field.
The **Choose File to Upload** dialog box appears.
8. Browse to the location where the adjustment data file that you want to upload is available.
9. Click **Open**.
The adjustment data file name and path appears in the **File Name** field.
10. Click **Submit**.

A grid appears which helps you to preview all records in the adjustment data file. It contains the following columns:

Column Name	Column Description
Errors	Indicates the reason why the adjustment record is invalid. If there are multiple reasons, the comma-separated list of error messages appears in this column.

Column Name	Column Description
	Note: This column appears when you click the Save button.
Account Identifier Type	Indicates the account identifier type.
Account Identifier	Displays the value of the account identifier type.
Account ID	Indicates the account for which the adjustment must be created.
Match Type	Indicates the match type using which the adjustment must be created.
Match Value	Indicates the entity (such as contract, contract type, and so on) against which the adjustment must be created.
Adjustment Type	Indicates the adjustment type using which the adjustment must be created.
Adjustment Amount	Displays the adjustment amount.
Currency Code	Indicates the currency in which the adjustment must be created.
Comments	Displays additional information about the adjustment.
Bill ID	Indicates the bill on which the adjustment must be created.
Arrears Date	Displays the date from when the amount is outstanding on the bill.
Char Type 1	Indicates the characteristic that must be defined for the adjustment.
Char Value 1	Displays the value of the characteristic type.
Char Type 2	Indicates the characteristic that must be defined for the adjustment.
Char Value 2	Displays the value of the characteristic type.
Char Type 3	Indicates the characteristic that must be defined for the adjustment.
Char Value 3	Displays the value of the characteristic type.
Char Type 4	Indicates the characteristic that must be defined for the adjustment.
Char Value 4	Displays the value of the characteristic type.
Char Type 5	Indicates the characteristic that must be defined for the adjustment.
Char Value 5	Displays the value of the characteristic type.

Note: If you upload an adjustment data file which exceeds the maximum file size defined in the upload request type, the system will not allow you to upload the file.

11. Click **Save**.

The validation process starts immediately. The adjustment record is considered as invalid when:

- Account ID, Account Identifier Type, Account Identifier, Adjustment Type, Currency, Bill ID, Characteristic Type, Characteristic Value, or Match Type is invalid.
- Match Type, Match Value, Adjustment Type, Adjustment Amount, Currency, or Characteristic Value is missing.
- Contract ID does not exist in the system.
- The contract is in the **Cancelled** status.
- Contract type does not exist in the system.
- Account Identifier Type, Account Identifier, or Account ID is missing when the match type is Contract Type.

- No active contract of the specified contract type is available.
- Adjustment amount precision does not match the precision (decimal positions) defined for the currency.
- The adjustment type is not included in the adjustment type profile which is attached to the contract type.
- The characteristic type is not associated with the adjustment type.

If there is an invalid record in the adjustment data file, you will not be able to upload the file.

Related Topics

For more information on...	See...
Adjustment Upload Request screen	Adjustment Upload Request (Used for Searching) on page 1407
Search Adjustment Upload Request zone	Search Adjustment Upload Request on page 1408

Viewing the Adjustment Upload Request Details

Procedure

To view the details of an adjustment upload request:

1. Search for an adjustment upload request in the **Adjustment Upload Request** screen.
2. In the **Search Results** section, click the link in the **Upload Request Information** column corresponding to the adjustment upload request whose details you want to view.

The **Adjustment Upload Request** screen appears. It contains the following two tabs:

- **Main** – This tab contains the following two zones:
 - **Adjustment Upload Request** – Displays the details of the adjustment upload request.
 - **Adjustment Data Records** – Lists the adjustment records which are uploaded through the adjustment data file.
 - **Log** – This tab lists the complete trail of actions performed on the adjustment upload request.
3. View the details of the adjustment upload request in the **Adjustment Upload Request** zone.

Related Topics

For more information on...	See...
How to search for an adjustment upload request	Searching for an Adjustment Upload Request on page 1409
Adjustment Upload Request zone	Adjustment Upload Request on page 1416
Adjustment Data Records zone	Adjustment Data Records on page 1419

Viewing All Records of an Adjustment Data File

Procedure

To view all records of an adjustment data file:

1. Search for the adjustment upload request (which is created while uploading the file whose records you want to view) in the **Adjustment Upload Request** screen.

- In the **Search Results** section, click the link in the **Upload Request Information** column corresponding to the adjustment data file whose records you want to view.

The **Adjustment Upload Request** screen appears. It contains the following two tabs:

- Main** – This tab contains the following two zones:
 - Adjustment Upload Request** – Displays the details of the adjustment upload request.
 - Adjustment Data Records** – Lists the adjustment records which are uploaded through the adjustment data file.
 - Log** – This tab lists the complete trail of actions performed on the adjustment upload request.
- View the list of adjustment records which are uploaded through the adjustment data file in the **Adjustment Data Records** zone.

Related Topics

For more information on...	See...
How to search for an adjustment upload request	Searching for an Adjustment Upload Request on page 1409
Adjustment Data Records zone	Adjustment Data Records on page 1419

Adjustment Upload Request (Used for Viewing)

The **Adjustment Upload Request** screen allows you to:

- Edit the details of an adjustment upload request
- Delete or cancel an adjustment upload request
- View the details of an adjustment upload request
- Submit an adjustment upload request for processing
- Approve or reject an adjustment upload request
- Request the submitter to resubmit an adjustment upload request for approval
- Withdraw an adjustment upload request
- View the log of an adjustment upload request
- Add a log entry for an adjustment upload request

It consists of the following tabs:

- [Adjustment Upload Request - Main](#) on page 1416
-

Adjustment Upload Request - Main

The **Main** tab displays information about the adjustment upload request. It contains the following zones:

- [Adjustment Upload Request](#) on page 1416
- [Adjustment Data Records](#) on page 1419

Adjustment Upload Request

The **Adjustment Upload Request** zone displays the details of the adjustment upload request. This zone contains the following sections:

- **Header** — This section provides basic information about the upload request. It contains the following fields:

Field Name	Field Description
Upload Request Information	<p>Displays information about the adjustment upload request. The information string contains the following comma-separated values:</p> <ul style="list-style-type: none"> • Upload Request Type Description • Status Description • Upload Request ID <p>Note: This information string is generated using the C1-FLREQ-INF algorithm which is attached to the Information system event in the adjustment upload request business object. If you want to display a different information string, you need to define a custom algorithm type and attach the algorithm in the adjustment upload request business object.</p>
Status	<p>Indicates the status of the adjustment upload request. The valid values are:</p> <ul style="list-style-type: none"> • Approved • Cancelled • Completed • Create Adjustment • Creating Adjustment • Deferred • Pending • Rejected • Pending for Approval
Status Reason	<p>Indicates the reason why the adjustment data file is cancelled or rejected.</p> <p>Note: This field appears when the adjustment upload request is in the Cancelled or Rejected status.</p>
File Name	<p>Displays the name of the adjustment data file for which the adjustment upload request is created.</p>

- **Record Actions** — This section contains the following buttons:

Button Name	Button Description
Cancel File	<p>Used to cancel an adjustment data file.</p> <p>Note: The Cancel File button appears when the adjustment upload request is in the Pending status.</p>
Create Adjustment	<p>Used to create adjustments for the records which are uploaded through the adjustment data file.</p>

Button Name	Button Description
	<p>Note: The Create Adjustment button appears when:</p> <ul style="list-style-type: none"> The adjustment upload request is in the Pending status. The approval workflow process is not configured for the upload request type using which the adjustment data file is uploaded.
Submit for Approval	<p>Used to submit the adjustment data file for approval.</p> <p>Note: The Submit for Approval button appears only when:</p> <ul style="list-style-type: none"> The adjustment upload request is in the Pending status. The approval workflow process is configured for the upload request type using which the adjustment data file is uploaded.
Approve	<p>Used to approve the adjustment data file.</p> <p>Note: The Approve button appears when:</p> <ul style="list-style-type: none"> The adjustment upload request is in the Pending for Approval status. A user with the approval To Do role is reviewing the adjustment data file.
Reject	<p>Used to reject the adjustment data file.</p> <p>Note: The Reject button appears when:</p> <ul style="list-style-type: none"> The adjustment upload request is in the Pending for Approval status. A user with the approval To Do role is reviewing the adjustment data file.

Note: The **Record Actions** section does not contain buttons when the status of the adjustment upload request is **Cancelled, Completed, Deferred, or Rejected**.

- Record Information** — This section contains the following fields:

Field Name	Field Description
Business Object	<p>Indicates the business object using which the adjustment upload request is created.</p> <p>Note: It has a link. On clicking the link, the Business Object screen appears with the details of the respective business object.</p>
Status Date/Time	Displays the date and time when the adjustment upload request status is updated.
Create Date/Time	Displays the date and time when the adjustment upload request is created.

Related Topics

For more information on...	See...
How to view the details of an adjustment upload request	Viewing the Adjustment Upload Request Details on page 1415
How to cancel an adjustment data file	Cancelling an Adjustment Data File on page 1420

For more information on...	See...
How to create adjustments for an adjustment data file	Creating Adjustments for an Adjustment Data File on page 1421
How to submit an adjustment data file for approval	Submitting an Adjustment Data File for Approval on page 1422
How to approve an adjustment data file	Approving an Adjustment Data File on page 1423
How to reject an adjustment data file	Rejecting an Adjustment Data File on page 1424

Adjustment Data Records

The **Adjustment Data Records** zone lists the adjustment records which are uploaded through the adjustment data file. This zone contains the following columns:

Column Name	Column Description
Adjustment Information	<p>Displays information about the adjustment that is created using the adjustment record.</p> <p>Note:</p> <p>The data appears in this column when the status of the adjustment upload request is Completed.</p> <p>It has a link. On clicking the link, the Adjustment screen appears with the details of the respective adjustment.</p> <p>The information string appears when an algorithm of the C1-ADI-INFO algorithm type is attached to the Adjustment Information system event in the Algorithms tab of the Installation Options — Framework screen.</p>
Account Identifier Type	Indicates the account identifier type.
Account Identifier	Displays the value of the account identifier type.
Account ID	Indicates the account for which the adjustment must be created.
Adjustment Match Value	Indicates the contract against which the adjustment must be created.
Adjustment Type	Indicates the adjustment type using which the adjustment must be created.
Adjustment Amount	Displays the adjustment amount.
Comments	Displays additional information about the adjustment.
Bill ID	Indicates the bill on which the adjustment must be created.
Arrears Date	Displays the date from when the amount is outstanding on the bill.
Char Type 1, Char Type 2,, Char Type 5	Indicates the characteristic that must be defined for the adjustment.
Char Value 1, Char Value 2,, Char Value 5	Displays the value of the characteristic type.

Related Topics

For more information on...	See...
How to view the details of an adjustment upload request	Viewing the Adjustment Upload Request Details on page 1415
How to view the adjustment records uploaded through an adjustment data file	Viewing All Records of an Adjustment Data File on page 1415

Adjustment Upload Request - Log

The **Log** tab contains the following zone:

- [Adjustment Upload Request - Log](#) on page 1420

Adjustment Upload Request Log

The **Upload Request Log** zone lists the complete trail of actions performed on the adjustment upload request. It contains the following columns:

Column Name	Column Description
Date/Time	Displays the date and time when the action was performed on the funding request.
Details	Displays the details of the action performed on the funding request.
User	Indicates the user who has performed the action on the funding request.
Log Type	Indicates the type of log.
Related Object	Indicates the object or entity which is created when the action is performed on the funding request.
	Note: At present, no data appears in this column. The implementation team can build the custom logic to meet the business requirements.
Status Reason	Indicates the reason why the funding request was rejected by the approver.
	Note: The data appears in this column when the funding request is in the Rejected status.

Note: You can manually add a log entry for the adjustment upload request by clicking the **Add Log Entry** link in the upper right corner of the **Adjustment Upload Request Log** zone.

Related Topics

For more information on...	See...
How to view the log of an adjustment upload request	Viewing the Log of an Adjustment Upload Request on page 1425
How to add a log entry for an adjustment upload request	Adding a Log Entry for an Adjustment Upload Request on page 1426

Cancelling an Adjustment Data File

There might be situations when incorrect adjustment data file is uploaded in the system. In such case, the system provides you with an ability to cancel the file. However, note that you can cancel an adjustment data file when the adjustment upload request is in the **Pending** status.

Prerequisites

To cancel an adjustment data file, you should have:

- Cancellation reasons defined in the application

Note: While cancelling an adjustment data file, you need to specify the reason why you want to cancel the adjustment data file. You can select the appropriate cancellation reason when you have defined the reasons for the **Cancelled** status of the **C1-ADJUPLD** business object in the **Status Reason** screen.

Procedure

To cancel an adjustment data file:

1. Search for the adjustment upload request (which is created while uploading the file that you want to cancel) in the **Adjustment Upload Request** screen.
2. In the **Search Results** section, click the link in the **Upload Request Information** column corresponding to the adjustment data file that you want to cancel.

The **Adjustment Upload Request** screen appears. It contains the following two tabs:

- **Main** – This tab contains the following two zones:
 - **Adjustment Upload Request** – Displays the details of the adjustment upload request.
 - **Adjustment Data Records** – Lists the adjustment records which are uploaded through the adjustment data file.
 - **Log** – This tab lists the complete trail of actions performed on the adjustment upload request.
3. Click **Cancel File** in the **Adjustment Upload Request** zone.

The **Cancellation Information** window appears. It contains the following fields:

Field Name	Field Description	Mandatory (Yes or No)
Cancellation Reason	Used to indicate the reason why you want to cancel the adjustment data file.	Yes

Note: The **Cancel File** button appears when the adjustment upload request is in the **Pending** status.

4. Select the cancellation reason from the list.
5. Click **Save**.

The adjustment data file is cancelled. In addition, the status of the adjustment upload request is changed to **Cancelled**.

Related Topics

For more information on...	See...
How to search for an adjustment upload request	Searching for an Adjustment Upload Request on page 1409
Adjustment Upload Request zone	Adjustment Upload Request on page 1416

Creating Adjustments for an Adjustment Data File

Procedure

To create adjustments for an adjustment data file:

1. Search for the adjustment upload request (which is created while uploading the file for which you want to create adjustments) in the **Adjustment Upload Request** screen.

- In the **Search Results** section, click the link in the **Upload Request Information** column corresponding to the adjustment data file for which you want to create adjustments.

The **Adjustment Upload Request** screen appears. It contains the following two tabs:

- **Main** – This tab contains the following two zones:
 - **Adjustment Upload Request** – Displays the details of the adjustment upload request.
 - **Adjustment Data Records** – Lists the adjustment records which are uploaded through the adjustment data file.
 - **Log** – This tab lists the complete trail of actions performed on the adjustment upload request.
- Click **Create Adjustment** in the **Adjustment Upload Request** zone.

The Defer algorithm attached to the upload request type using which you have uploaded the adjustment data file is triggered. If the number of records in the adjustment data file does not exceed the online record process limit (defined in the Defer algorithm), the system creates adjustments in the real time (i.e. immediately). In addition, the adjustment information string appears corresponding to each adjustment record in the **Adjustment Data Records** zone and the status of the adjustment upload request is changed to **Completed**. However, if the number of records in the adjustment data file exceeds the online record process limit, the system creates adjustments in the deferred mode and the status of the adjustment upload request is changed to **Deferred**.

Note:

Deferred mode means in the background when the **Upload Request Periodic Monitor (C1-UPLRQ)** batch is invoked. You can configure the **Upload Request Periodic Monitor (C1-UPLRQ)** batch such that it is executed at regular intervals. When the **Upload Request Periodic Monitor (C1-UPLRQ)** batch is invoked, the system checks whether there are any adjustment upload requests in the **Deferred** status. If there is an adjustment upload request in the **Deferred** status, the system creates adjustments for the adjustment data file. Once the adjustments are created, the adjustment information string appears corresponding to each adjustment record in the **Adjustment Data Records** zone and the status of the adjustment upload request is changed to **Completed**.

The **Create Adjustment** button appears when:

- The adjustment upload request is in the **Pending** status.
- The approval workflow process is not configured for the upload request type using which the adjustment data file is uploaded.

Related Topics

For more information on...	See...
How to search for an adjustment upload request	Searching for an Adjustment Upload Request on page 1409
Adjustment Upload Request zone	Adjustment Upload Request on page 1416
Adjustment Data Records zone	Adjustment Data Records on page 1419



Submitting an Adjustment Data File for Approval

Procedure

To submit an adjustment data file for approval:

- Search for the adjustment upload request (which is created while uploading the file that you want to submit for approval) in the **Adjustment Upload Request** screen.

2. In the **Search Results** section, click the link in the **Upload Request Information** column corresponding to the adjustment data file that you want to submit for approval.

The **Adjustment Upload Request** screen appears. It contains the following two tabs:

- **Main** – This tab contains the following two zones:
 - **Adjustment Upload Request** – Displays the details of the adjustment upload request.
 - **Adjustment Data Records** – Lists the adjustment records which are uploaded through the adjustment data file.
- **Log** – This tab lists the complete trail of actions performed on the adjustment upload request.

3. Click **Submit for Approval** in the **Adjustment Upload Request** zone.

The status of the adjustment upload request is changed to **Pending for Approval**. A To Do is created using the **C1-ADJUP** To Do type. Users having a To Do role to which the **C1-ADJUP** To Do type is associated can view the To Do from the **To Do List** screen. On clicking the **Submitted Message** link corresponding to the To Do, the **Adjustment Upload Request** screen appears where you can review the records of the adjustment data file.

Note:

The **Submit for Approval** button appears when:

- The adjustment upload request is in the **Pending** status.
- The approval workflow process is configured for the upload request type using which the adjustment data file is uploaded.

Related Topics

For more information on...	See...
Adjustment Upload Request zone	Adjustment Upload Request on page 1416
How to search for an adjustment upload request	Searching for an Adjustment Upload Request on page 1409

Approving an Adjustment Data File

Procedure

To approve an adjustment data file:

1. Search for the adjustment upload request (which is created while uploading the file that you want to review) in the **Adjustment Upload Request** screen.
2. In the **Search Results** section, click the link in the **Upload Request Information** column corresponding to the adjustment data file that you want to review.

The **Adjustment Upload Request** screen appears. It contains the following two tabs:

- **Main** – This tab contains the following two zones:
 - **Adjustment Upload Request** – Displays the details of the adjustment upload request.
 - **Adjustment Data Records** – Lists the adjustment records which are uploaded through the adjustment data file.
- **Log** – This tab lists the complete trail of actions performed on the adjustment upload request.

3. Review the records of the adjustment data file in the **Adjustment Data Records** zone.
4. If the adjustment data file is appropriate, then click **Approve** in the **Adjustment Upload Request** zone.

The Defer algorithm attached to the upload request type using which you have uploaded the adjustment data file is triggered. If the number of records in the adjustment data file does not exceed the online record process limit (defined in the Defer algorithm), the system creates adjustments in the real time (i.e. immediately). In addition, the adjustment information string appears corresponding to each adjustment record in the **Adjustment Data Records** zone and the status of the adjustment upload request is changed to **Completed**. However, if the number of records in the adjustment data file exceeds the online record process limit, the system creates adjustments in the deferred mode and the status of the adjustment upload request is changed to **Deferred**.

Note:

Deferred mode means in the background when the **Upload Request Periodic Monitor (C1-UPLRQ)** batch is invoked. You can configure the **Upload Request Periodic Monitor (C1-UPLRQ)** batch such that it is executed at regular intervals. When the **Upload Request Periodic Monitor (C1-UPLRQ)** batch is invoked, the system checks whether there are any adjustment upload requests in the **Deferred** status. If there is an adjustment upload request in the **Deferred** status, the system creates adjustments for the adjustment data file. Once the adjustments are created, the adjustment information string appears corresponding to each adjustment record in the **Adjustment Data Records** zone and the status of the adjustment upload request is changed to **Completed**.

The **Approve** button appears when:

- The adjustment upload request is in the **Pending for Approval** status.
- A user with the approval To Do role is reviewing the adjustment data file.

Related Topics

For more information on...	See...
How to search for an adjustment upload request	Searching for an Adjustment Upload Request on page 1409
Adjustment Upload Request zone	Adjustment Upload Request on page 1416
Adjustment Data Records zone	Adjustment Data Records on page 1419

Rejecting an Adjustment Data File**Prerequisites**

To reject an adjustment data file, you should have:

- Rejection reasons defined in the application

Note:

While rejecting an adjustment data file, you need to specify the reason why you want to reject the adjustment data file. You can select the appropriate rejection reason when you have defined the reasons for the **Rejected** status of the **C1-ADJUPLD** business object in the **Status Reason** screen.

The system does not allow the submitter to approve or reject the adjustment data file.

Procedure

To reject an adjustment data file:

1. Search for the adjustment upload request (which is created while uploading the file that you want to review) in the **Adjustment Upload Request** screen.
2. In the **Search Results** section, click the link in the **Upload Request Information** column corresponding to the adjustment data file that you want to review.

The **Adjustment Upload Request** screen appears. It contains the following two tabs:

- **Main** – This tab contains the following two zones:
 - **Adjustment Upload Request** – Displays the details of the adjustment upload request.
 - **Adjustment Data Records** – Lists the adjustment records which are uploaded through the adjustment data file.
 - **Log** – This tab lists the complete trail of actions performed on the adjustment upload request.
3. Review the records of the adjustment data file in the **Adjustment Data Records** zone.
 4. If the adjustment data file is not appropriate, then click **Reject** in the **Adjustment Upload Request** zone.

The **Rejection Information** window appears. It contains the following fields:

Field Name	Field Description	Mandatory (Yes or No)
Rejection Reason	Used to indicate the reason why you want to reject the adjustment data file.	Yes

Note:

The **Reject** button appears when:

- The adjustment upload request is in the **Pending for Approval** status.
- A user with the approval To Do role is reviewing the adjustment data file.

5. Select the rejection reason from the list.
6. Click **Save**.

The adjustment data file is rejected. In addition, the status of the adjustment upload request is changed to **Rejected**.

Related Topics

For more information on...	See...
Adjustment Upload Request zone	Adjustment Upload Request on page 1416
Adjustment Data Records zone	Adjustment Data Records on page 1419
How to search for an adjustment upload request	Searching for an Adjustment Upload Request on page 1409

Viewing the Log of an Adjustment Upload Request

Procedure

To view the log of an adjustment upload request:

1. Search for the adjustment upload request in the **Adjustment Upload Request** screen.
2. In the **Search Results** section, click the link in the **Upload Request Information** column corresponding to the adjustment upload request whose log you want to view.

The **Adjustment Upload Request** screen appears. It contains the following two tabs:

- **Main** – This tab contains the following two zones:
 - **Adjustment Upload Request** – Displays the details of the adjustment upload request.

- **Adjustment Data Records** – Lists the adjustment records which are uploaded through the adjustment data file.
 - **Log** – This tab lists the complete trail of actions performed on the adjustment upload request.
3. Click the **Log** tab.

The **Upload Request Log** zone in the **Log** tab contains the following columns:

Column Name	Column Description
Date/Time	Displays the date and time when the action was performed on the adjustment upload request.
Details	Displays the details about the action performed on the adjustment upload request.
User	Indicates the user who has performed the action on the adjustment upload request.
Log Type	Indicates the type of log.
Related Object	Indicates the object or entity which is generated when the action is performed on the adjustment upload request.
Status Reason	Indicates the reason why the adjustment upload request was rejected or cancelled.

Note: You can manually add a log entry for the adjustment upload request by clicking the **Add Log Entry** link in the upper right corner of the **Upload Request Log** zone.

Related Topics

For more information on...	See...
How to search for an adjustment upload request	Searching for an Adjustment Upload Request on page 1409
How to add a log entry for an adjustment upload request	Adding a Log Entry for an Adjustment Upload Request on page 1426

Adding a Log Entry for an Adjustment Upload Request

Procedure

To add a log entry for an adjustment upload request:

1. Search for the adjustment upload request in the **Adjustment Upload Request** screen.
2. In the **Search Results** section, click the link in the **Upload Request Information** column corresponding to the adjustment upload request whose log you want to edit.

The **Adjustment Upload Request** screen appears. It contains the following two tabs:

- **Main** – This tab contains the following two zones:
 - **Adjustment Upload Request** – Displays the details of the adjustment upload request.
 - **Adjustment Data Records** – Lists the adjustment records which are uploaded through the adjustment data file.
- **Log** – This tab lists the complete trail of actions performed on the adjustment upload request.

3. Click the **Log** tab.

The **Log** tab appears.

4. Click the **Add Log Entry** link in the upper right corner of the **Upload Request Log** zone.

The **Add Request Log** window appears. It contains the following fields:

Field Name	Field Description	Mandatory (Yes or No)
Request Information	Displays information about the adjustment upload request.	Not applicable
Log Details	Used to specify additional comments for the adjustment upload request.	Yes

5. Enter the comments in the **Log Details** field.

6. Click **Save**.

The log entry is added in the **Upload Request Log** zone.

Related Topics

For more information on...	See...
How to search for an adjustment upload request	Searching for an Adjustment Upload Request on page 1409

Chapter 20

Foreign Exchange Gain Loss

Topics:

- [Foreign Exchange Gain Loss Calculation](#)
- [Prerequisites](#)
- [Foreign Exchange Gain Loss Scenarios](#)

In a multi-currency environment, financial transactions such as payments and adjustments created for an account can result in loss or gain due to fluctuations in the exchange rate at different point in time. This loss or gain is booked under the Foreign Exchange Gain Loss in the General Ledger and does not impact the account balance of the person.

The Foreign Exchange Gain or Loss might occur when:

- Exchange Rate for Invoice Currency to Division' Base Currency is different on Bill Completion Date and Payment Freeze Date

Assumption: In this case, the Invoice Currency and Payment Currency are same.

- Exchange Rate for Adjustment Currency to Division's Base Currency is different on Bill Completion Date and Adjustment Freeze Date

Assumption: In this case, the Adjustment Currency and Invoice Currency are same, but they are different from the Division's Base Currency.

- Exchange Rate for Adjustment Currency to Division's Base Currency is different on Bill Completion Date and Payment Freeze Date

Assumption: In this case, the Adjustment Currency, Payment Currency, and Invoice Currency are same, but they are different from the Division's Base Currency.

Oracle Revenue Management and Billing facilitates you to calculate the foreign exchange gain or loss and book it against an FXLG distribution code. However, you can calculate the foreign exchange gain or loss when you have enabled the FT GL Extension feature. For more information on how the system calculates the foreign exchange gain loss, see [Foreign Exchange Gain Loss Calculation](#) on page 1430. For more information on how to setup the Foreign Exchange Gain Loss feature, see [Prerequisites](#) on page 1430.

Note: The system can calculate the foreign exchange gain or loss appropriately when the Division's Base Currency is same on Bill Completion Date and Adjustment/Payment Freeze Date. Otherwise, erroneous results might occur.

Foreign Exchange Gain Loss Calculation

During the Foreign Exchange Gain Loss calculation, the system considers the following types of financial transactions:

- Payments (i.e. Pay Segments)
- Credit adjustments which are created against a bill after the bill completion
- Write-off adjustments which are created against a bill
- Write Up adjustments which are automatically created when you match a payment against a bill using the Bill Weighted match type
- Write Down adjustments which are automatically created when you match a payment against a bill using the Bill Weighted match type

Note: The system does not consider financial transactions which are created due to payment and adjustment cancellation.

To understand how foreign exchange gain or loss is calculated, see [Foreign Exchange Gain Loss Scenarios](#) on page 1431.

You can calculate the foreign exchange gain loss when you have enabled the FT GL Extension feature. Oracle Revenue Management and Billing provides you a batch named **Foreign Exchange Loss Gain (C1-FXLG)** which calculates the foreign exchange gain loss. This batch considers payment and adjustment FTs when:

- Division's Base Currency is different from the Payment or Adjustment Currency
- Payment or Adjustment Freeze Date is different from the Bill Completion Date
- Match Event ID exists in the financial transaction
- FXLG_CALC_STATUS column corresponding to the financial transaction in the CI_FT table is set to N or NULL

Once the foreign exchange gain or loss is calculated, two entries are added corresponding to each financial transaction in the CI_FT_GL and CI_FT_GL_EXT tables. One entry for foreign exchange gain loss is booked against the distribution code for FXLG and another entry for foreign exchange gain loss is booked against the distribution code which is used for contract balancing. The foreign exchange loss is recorded as positive entry and the foreign exchange gain is recorded as negative entry. In the CI_FT_GL table, the foreign exchange gain loss is recorded in the financial transaction currency. And, in the CI_FT_GL_EXT table, the foreign exchange gain loss is recorded in the division's base currency.

You must execute the **Foreign Exchange Loss Gain (C1-FXLG)** batch prior to the **Assign GL Account to Financial Transaction (C1-GLASN)** or **Insert Records in CI_FTTEMP (GLASSGN1)** batch. For more information about these batches, refer to *Oracle Revenue Management and Billing Batch Guide*.

Prerequisites

To setup the Foreign Exchange Gain Loss feature, you need to do the following:

- Create an algorithm of the **FTFREZGLEXTN** algorithm type and attach it on the **FT Freeze** system event of the customer class for which you want to enable FT GL extension feature
- Set the following parameters of an algorithm which is created using the **FTFREZGLEXTN** algorithm type to **R** (i.e. arrears date):
 - Exchange Rate Date Type for Adjustments with Freeze At Will Option (Valid Values: A, R, F, C)
 - Exchange Rate Date Type for Adjustments with Freeze At Bill Completion Option (Valid Values: A, R, F, C, E)
 - Exchange Rate Date Type for Payments (Valid Values: A, R, F, C)

- Exchange Rate Date Type for Bill Segments (Valid Values: A, R, F, C)
- Create an algorithm of the **C1_CURALGBS** algorithm type and attach it to the **Currency Conversion For Bill Segments** algorithm spot of the division for which you want to enable the currency conversion feature
- Create an algorithm of the **C1_CURALGAD** algorithm type and attach it to the **Currency Conversion For Adjustments** algorithm spot of the division for which you want to enable the currency conversion feature
- Create an algorithm of the **C1_CURALGPY** algorithm type and attach it to the **Currency Conversion For Payments** algorithm spot of the division for which you want to enable the currency conversion feature
- Set the **Bill Segment Freeze Option** to **Freeze At Bill Completion** in the **Billing** tab of the **Installation Options** screen
- Define the required exchange rates for currency conversion
- Define the distribution code against which you want to book the foreign exchange gain loss
- Set the **Adjustment Freeze Option** to **Freeze At Bill Completion** for adjustment types whose adjustments are presented and impacts the next bill of an account

Related Topics

For more information on...	See...
FTFREZGLEXTN algorithm type	FTFREZGLEXTN on page 964
C1_CURALGBS algorithm type	C1_CURALGBS on page 949
C1_CURALGAD algorithm type	C1_CURALGAD on page 951
C1_CURALGPY algorithm type	C1_CURALGPY on page 953

Foreign Exchange Gain Loss Scenarios

To understand how foreign exchange gain loss is calculated, refer to the following different scenarios:

- [Payment Scenarios](#) on page 1431
- [Credit Adjustment Scenarios](#) on page 1435
- [Write Off Adjustment Scenarios](#) on page 1436
- [Write Up/Down Adjustment Scenarios](#) on page 1438

Payment Scenarios

The following scenarios indicate how foreign exchange gain or loss is calculated for payments which are matched against bills:

- Scenario 1 — Payment Freeze Date = Bill Completion Date; Payment Amount = Invoice Amount

	Bill Completion Date (01-01-2001)	Payment Freeze Date (01-01-2001)
Exchange Rate From	USD	USD
Exchange Rate To	INR	INR
Exchange Rate	50	50
Invoice/Payment Currency	USD	USD
Invoice Amount	1000	-

	Bill Completion Date (01-01-2001)	Payment Freeze Date (01-01-2001)
Base Currency	INR	INR
Booked Revenue in Base Currency	1000*50 = 50000	-
Payment Amount	-	1000
Payment Amount in Base Currency on Bill Completion Date	-	1000*50 = 50000
Realized Revenue (Payment Amount) in Base Currency on Payment Freeze Date	-	1000*50 = 50000
Foreign Exchange Gain or Loss	-	Not applicable

Observation: In the Scenario 1, the foreign exchange gain or loss is not applicable because Bill Completion Date and Payment Freeze Date are same.

- Scenario 2 — Payment Freeze Date Not Equal to Bill Completion Date; Exchange Rate is Same; Payment Amount = Invoice Amount

	Bill Completion Date (01-01-2001)	Payment Freeze Date (01-02-2001)
Exchange Rate From	USD	USD
Exchange Rate To	INR	INR
Exchange Rate	50	50
Invoice/Payment Currency	USD	USD
Invoice Amount	1000	-
Base Currency	INR	INR
Booked Revenue in Base Currency	1000*50 = 50000	-
Payment Amount	-	1000
Payment Amount in Base Currency on Bill Completion Date	-	1000*50 = 50000
Realized Revenue (Payment Amount) in Base Currency on Payment Freeze Date	-	1000*50 = 50000
Foreign Exchange Gain or Loss	-	50000-50000 = 0

Observation: In the Scenario 2, there is no foreign exchange gain or loss because the exchange rate is same on the Bill Completion Date and Payment Freeze Date.

- Scenario 3 — Payment Freeze Date Not Equal to Bill Completion Date; Exchange Rate is Different; Payment Amount = Invoice Amount

	Bill Completion Date (01-01-2001)	Payment Freeze Date (01-02-2001)
Exchange Rate From	USD	USD
Exchange Rate To	INR	INR
Exchange Rate	50	51

	Bill Completion Date (01-01-2001)	Payment Freeze Date (01-02-2001)
Invoice/Payment Currency	USD	USD
Invoice Amount	1000	-
Base Currency	INR	INR
Booked Revenue in Base Currency	$1000 * 50 = 50000$	-
Payment Amount	-	1000
Payment Amount in Base Currency on Bill Completion Date	-	$1000 * 50 = 50000$
Realized Revenue (Payment Amount) in Base Currency on Payment Freeze Date	-	$1000 * 51 = 51000$
Foreign Exchange Gain or Loss	-	$50000 - 51000 = -1000$

Observation: In the Scenario 3, there is foreign exchange gain of 1000 INR on 01-02-2001 because of difference in exchange rate.

- Scenario 4 — Payment Freeze Date Not Equal to Bill Completion Date; Exchange Rate is Same; Partial Payments; Total Payment Amount = Invoice Amount

	Bill Completion Date (01-01-2001)	First Partial Payment Freeze Date (01-02-2001)	Second Partial Payment Freeze Date (01-03-2001)
Exchange Rate From	USD	USD	USD
Exchange Rate To	INR	INR	INR
Exchange Rate	50	50	50
Invoice/Payment Currency	USD	USD	USD
Invoice Amount	1000	-	-
Base Currency	INR	INR	INR
Booked Revenue in Base Currency	$1000 * 50 = 50000$	-	-
Payment Amount	-	500	500
Payment Amount in Base Currency on Bill Completion Date	-	$500 * 50 = 25000$	$500 * 50 = 25000$
Realized Revenue (Payment Amount) in Base Currency on Payment Freeze Date	-	$500 * 50 = 25000$	$500 * 50 = 25000$
Foreign Exchange Gain or Loss	-	$25000 - 25000 = 0$	$25000 - 25000 = 0$

Observation: In the Scenario 4, there is no foreign exchange gain or loss because the exchange rate is same on the Bill Completion Date and Payment Freeze Date.

- Scenario 5 — Payment Freeze Date Not Equal to Bill Completion Date; Exchange Rate is Different; Partial Payments; Total Payment Amount = Invoice Amount

	Bill Completion Date (01-01-2001)	First Payment Date (01-02-2001)	Partial Freeze Date (01-03-2001)
Exchange Rate From	USD	USD	USD
Exchange Rate To	INR	INR	INR
Exchange Rate	50	51	48
Invoice/Payment Currency	USD	USD	USD
Invoice Amount	1000	-	-
Base Currency	INR	INR	INR
Booked Revenue in Base Currency	$1000 * 50 = 50000$	-	-
Payment Amount	-	800	200
Payment Amount in Base Currency on Bill Completion Date	-	$800 * 50 = 40000$	$200 * 50 = 10000$
Realized Revenue (Payment Amount) in Base Currency on Payment Freeze Date	-	$800 * 51 = 40800$	$200 * 48 = 9600$
Foreign Exchange Gain or Loss	-	$40000 - 40800 = -800$	$10000 - 9600 = 400$

Observation: In the Scenario 5, there is foreign exchange gain of 800 INR on 01-02-2001 and foreign exchange loss of 400 INR on 01-03-2001.

- Scenario 6 — Payment Freeze Date Not Equal to Bill Completion Date; Exchange Rate is Different; Payment Amount > Invoice Amount (i.e. Overpayment)

	Bill Completion Date (01-01-2001)	Payment Freeze Date (01-02-2001)
Exchange Rate From	USD	USD
Exchange Rate To	INR	INR
Exchange Rate	50	49
Invoice/Payment Currency	USD	USD
Invoice Amount	1000	-
Base Currency	INR	INR
Booked Revenue in Base Currency	$1000 * 50 = 50000$	-
Payment Amount	-	1200
Payment Amount in Base Currency on Bill Completion Date	-	$1000 * 50 = 50000$
Realized Revenue (Payment Amount) in Base Currency on Payment Freeze Date	-	$1000 * 49 = 49000$
Foreign Exchange Gain or Loss	-	$50000 - 49000 = 1000$

Observation: In the Scenario 6, there is foreign exchange loss of 1000 INR on 01-02-2001 because of difference in exchange rate. Note that the foreign exchange gain or loss is not calculated on the overpayment amount (i.e. 200 USD).

- Scenario 7 — Payment Freeze Date Not Equal to Bill Completion Date; Exchange Rate is Different; Partial Payments; Total Payment Amount > Invoice Amount (i.e. Overpayment)

	Bill Completion Date (01-01-2001)	First Partial Payment Freeze Date (01-02-2001)	Second Partial Payment Freeze Date (01-03-2001)
Exchange Rate From	USD	USD	USD
Exchange Rate To	INR	INR	INR
Exchange Rate	50	49	52
Invoice/Payment Currency	USD	USD	USD
Invoice Amount	1000	-	-
Base Currency	INR	INR	INR
Booked Revenue in Base Currency	$1000 * 50 = 50000$	-	-
Payment Amount	-	800	400
Payment Amount in Base Currency on Bill Completion Date	-	$800 * 50 = 40000$	$200 * 50 = 10000$
Realized Revenue (Payment Amount) in Base Currency on Payment Freeze Date	-	$800 * 49 = 39200$	$200 * 52 = 10400$
Foreign Exchange Gain or Loss	-	$40000 - 39200 = 800$	$10000 - 10400 = -400$

Observation: In the Scenario 7, there is foreign exchange loss of 800 INR on 01-02-2001 and foreign exchange gain of 400 INR on 01-03-2001. Note that the foreign exchange gain or loss is not calculated on the overpayment amount (i.e. 200 USD).

Note: If a payment is cancelled, reverse financial transactions are created. These financial transactions are not considered during the foreign exchange gain loss calculation.

Credit Adjustment Scenarios

An adjustment which is posted against a bill after the bill completion is treated as payment towards the bill. The following scenarios indicate how foreign exchange gain or loss is calculated for credit adjustments which are created against a bill after the bill completion:

- Scenario 1 — Adjustment Freeze Date Not Equal to Bill Completion Date; Exchange Rate is Different

	Bill Completion Date (04-30-2015)	Adjustment Freeze Date (05-10-2015)
Exchange Rate From	USD	USD
Exchange Rate To	INR	INR
Exchange Rate	50	40
Invoice/Adjustment Currency	INR	INR
Invoice Amount	1000	-
Base Currency	USD	USD
Booked Revenue in Base Currency	$1000 / 50 = 20$	-

	Bill Completion Date (04–30–2015)	Adjustment Freeze Date (05–10–2015)
Adjustment Amount	-	400
Adjustment Amount in Base Currency on Bill Completion Date	-	$400/50 = 8$
Realized Revenue (Adjustment Amount) in Base Currency on Adjustment Freeze Date	-	$400/40 = 10$
Foreign Exchange Gain or Loss	-	$8-10 = -2$

Observation: In the Scenario 1, there is foreign exchange gain of 2 USD on 05–10–2015 because of difference in exchange rate.

- Scenario 2 — Adjustment Freeze Date Not Equal to Bill Completion Date; Exchange Rate is Different

	Bill Completion Date (04–11–2014)	Adjustment Freeze Date (04–30–2014)
Exchange Rate From	USD	USD
Exchange Rate To	INR	INR
Exchange Rate	55	60
Invoice/Adjustment Currency	INR	INR
Invoice Amount	2000	-
Base Currency	USD	USD
Booked Revenue in Base Currency	$2000/55 = 36.36$	-
Adjustment Amount	-	200
Adjustment Amount in Base Currency on Bill Completion Date	-	$200/55 = 3.63$
Realized Revenue (Adjustment Amount) in Base Currency on Adjustment Freeze Date	-	$200/60 = 3.33$
Foreign Exchange Gain or Loss	-	$3.63-3.33 = 0.30$

Observation: In the Scenario 2, there is foreign exchange loss of 0.30 USD on 04–30–2014 because of difference in exchange rate.

Note:

Multi-currency is not supported while creating credit adjustments against a bill after the bill completion. Therefore, the credit adjustment's currency must be same as the invoice currency.

If the amount of credit adjustment exceeds the bill amount, you need to match the excess amount against another bill while freezing the adjustment. Otherwise, the adjustment is not considered during foreign exchange gain loss calculation.

If a credit adjustment is cancelled, reverse financial transactions are created. These financial transactions are not considered during the foreign exchange gain loss calculation.

Write Off Adjustment Scenarios

The following scenarios indicate how foreign exchange gain or loss is calculated for write off adjustments which are created against a bill:

- Scenario 1 — Adjustment Freeze Date Not Equal to Bill Completion Date; Exchange Rate is Different; Full Bill Amount is Written Off

	Bill Completion Date (04-30-2015)	Adjustment Freeze Date (05-10-2015)
Exchange Rate From	USD	USD
Exchange Rate To	INR	INR
Exchange Rate	50	60
Invoice/Adjustment Currency	INR	INR
Invoice Amount	1000	-
Base Currency	USD	USD
Booked Revenue in Base Currency	$1000/50 = 20$	-
Adjustment Amount	-	1000
Adjustment Amount in Base Currency on Bill Completion Date	-	$1000/50 = 20$
Realized Revenue (Adjustment Amount) in Base Currency on Adjustment Freeze Date	-	$1000/60 = 16.67$
Foreign Exchange Gain or Loss	-	$20 - 16.67 = 3.33$

Observation: In the Scenario 1, there is foreign exchange loss of 3.33 USD on 05-10-2015 because of difference in exchange rate.

- Scenario 2 — Adjustment Freeze Date Not Equal to Bill Completion Date; Exchange Rate is Different; Partial Bill Amount is Written Off

	Bill Completion Date (01-30-2014)	Adjustment Freeze Date (03-03-2015)
Exchange Rate From	USD	USD
Exchange Rate To	INR	INR
Exchange Rate	60	55
Invoice/Adjustment Currency	INR	INR
Invoice Amount	1000	-
Base Currency	USD	USD
Booked Revenue in Base Currency	$1000/60 = 16.67$	-
Adjustment Amount	-	600
Adjustment Amount in Base Currency on Bill Completion Date	-	$600/60 = 10$
Realized Revenue (Adjustment Amount) in Base Currency on Adjustment Freeze Date	-	$600/55 = 10.91$
Foreign Exchange Gain or Loss	-	$10 - 10.91 = -0.91$

Observation: In the Scenario 2, there is foreign exchange gain of 0.91 USD on 03-03-2015 because of difference in exchange rate.

Note: If a write off adjustment is cancelled, reverse financial transactions are created. These financial transactions are not considered during the foreign exchange gain loss calculation.

Write Up/Down Adjustment Scenarios

If the lower or upper tolerance limit defined in the Bill Weighted Payment Distribution algorithm is met when a payment is matched against a bill using the Bill Weighted match type, the Write Up or Write Down adjustment is automatically created. The following scenarios indicate how foreign exchange gain or loss is calculated for write up or write down adjustments:

- Scenario 1 — Payment/Adjustment Freeze Date Not Equal to Bill Completion Date; Exchange Rate is Different; Payment Matched against a Bill with Two Bill Segments (BS1 — 50 INR; BS2 — 50 INR)

	Bill Completion Date (04–30–2015)	Payment Freeze Date (05–14–2015)	Write Up/Down Adjustment (Against BS1) Freeze Date (05–14–2015)	Write Up/Down Adjustment (Against BS2) Freeze Date (05–14–2015)
Exchange Rate From	USD	USD	USD	USD
Exchange Rate To	INR	INR	INR	INR
Exchange Rate	50	45	45	45
Invoice/Payment/Adjustment Currency	INR	INR	INR	INR
Invoice Amount	100	-	-	-
Base Currency	USD	USD	USD	USD
Booked Revenue in Base Currency	$100/50 = 2$	-	-	-
Payment/Adjustment Amount	-	95	2.5	2.5
Payment/Adjustment Amount in Base Currency on Bill Completion Date	-	$95/50 = 1.9$	$2.5/50 = 0.05$	$2.5/50 = 0.05$
Realized Revenue (Payment/Adjustment Amount) in Base Currency on Payment/Adjustment Freeze Date	-	$95/45 = 2.11$	$2.5/45 = 0.056$	$2.5/45 = 0.056$
Foreign Exchange Gain or Loss	-	$1.9 - 2.11 = -0.21$	$0.05 - 0.056 = -0.006$	$0.05 - 0.056 = -0.006$

Observation: In the Scenario 1, two Write Up adjustments are created — one against BS1 and another against BS2. While freezing the payment which is matched against the bill, there is foreign exchange gain of 0.21 USD

on 05-14-2015. However, while freezing the Write Up adjustments which are created against BS1 and BS2, there is foreign exchange gain of 0.006 and 0.006 USD, respectively, on 05-14-2015.

Note: If a write up or write down adjustment is cancelled, reverse financial transactions are created. These financial transactions are not considered during the foreign exchange gain loss calculation.

Chapter 21

Payment Request

Topics:

- [Prerequisites](#)
- [Payment Creation Request \(Without Approval\) Status Transition](#)
- [Payment Creation Request \(With Approval\) Status Transition](#)
- [Payment Transfer Request \(Without Approval\) Status Transition](#)
- [Payment Transfer Request \(With Approval\) Status Transition](#)
- [Algorithms Used in C1-PaymentRequest](#)
- [Algorithms Used in C1-PaymentTransferRequest](#)
- [Payment Request Type](#)
- [Payment Request \(Used for Searching\)](#)
- [Payment Request \(Used for Viewing\)](#)
- [Payment Event Summary](#)

Oracle Revenue Management and Billing facilitates you to create and transfer payments through a payment request. While creating a payment creation or transfer request, you need to specify the payment request type using which you want to create the payment request. It is the payment request type which helps the system to determine:

- Whether to create payment transfer or payment creation request
- Whether payment events and payments must be created in real time (i.e. immediately) or in the deferred mode
- Whether payment creation or transfer instructions must be approved by the approver before freezing the payments

While creating a payment creation request, you need to specify the tender amount and match type details. However, while creating a payment transfer request, you need to specify the transfer amount and match type details. The **Payment Request** feature supports the following match types :

- By Bill Regular (Match Entity: Account)
- By Bill (Match Entity: Bill)
- By Bill Weighted (Match Entity: Account)
- By Bill Segments (Match Entity: Account)
- By Suspense Contract (Match Entity: Account)
- By Settlement ID (Match Entity: Account)

You can specify multiple match types along with the entity (such as account or bill) in the payment request. Depending on the match type and match entity selected, the entities (such as unpaid bills, bill segments, or contracts) of the account are considered against which you can match the tender or transfer (payment) amount. Once you update the payment amount against the required entities, you can distribute the tender or payment amount.

On distributing the tender amount, the payment event, payments, payment segments, and payment tender are created. The payments are created in the **Freezable** status. If any error occurs while creating a payment, the payment is created in the **Error** status. If all payments of a payment event are in the **Freezable** status, the status of the payment event is set to **Balanced**. However, if any payment of a payment event is in the **Error** status, the status of the payment event is set to **Unbalanced**. On distributing the payment amount (during transfer), the new payments are created in the **Freezable** status. If any error occurs while creating a new payment, the payment is created in the **Error** status. The status of the payment event is set to **Unbalanced**. The old payments in the payment event that you want to transfer remains in the **Frozen** or **Error** status.

The system allows you to view the pay segments of a payment and edit the pay segment amount, if required. You can edit the pay segment amount before submitting the payment request for approval or before freezing the payments. If the approval is not required for the payment request, you can directly freeze the payments created through the payment request. However, if the approval is required for the payment request, you need to submit the payment request for approval. Based on the observations, the approver might approve or reject the payment request. On approving a payment creation request or freezing the payments, the status of the payments is changed from **Freezable** to **Frozen**. However, on approving a payment transfer request or freezing the payments, the system does the following:

- Changes the status of the old payments which are in the **Frozen** status to **Cancelled**
- Deletes the old payments which are in the **Error** status
- Changes the status of the new payments which are in the **Freezable** status to **Frozen**
- Changes the status of the payment event to **Balanced** when there are no payments in the **Error** status

On rejecting a payment creation request, the payment event, payments, payment segments, and payment tender which are created through the payment creation request are deleted. However, on rejecting a payment transfer request, the new payments which are created through the payment transfer request are deleted.

During the payment request process, a payment creation or transfer request goes through various statuses in its lifecycle. For more information about the payment request statuses, see [Payment Creation Request \(Without Approval\) Status Transition](#) on page 1444 and [Payment Creation Request \(With Approval\) Status Transition](#) on page 1445.

Note that the lifecycle of a payment creation and transfer requests is driven by the respective business object using which the payment creation and transfer requests are created. The **C1-PaymentRequest** and **C1-PaymentTransferRequest** business objects are shipped with the product. The payment request feature explained in this document is articulated based on the lifecycle and logic defined in the **C1-PaymentRequest** and **C1-PaymentTransferRequest** business objects.

For more information on how to setup the payment request process, see [Prerequisites](#) on page 1443.

Prerequisites

To setup the payment request process, you need to do the following:

- Define the following match types:

Match Type	Description	Payment Distribution Override Algorithm	Manual Distribution Algorithm	Entity Type	Match Type Search Zone	Entity Flag
BILLR	By Bill Regular	C1-PDOV-PYBL	C1-MD-BILL	Account	C1_ACCTSRCH	Bill
BILLW	By Bill Weighted	C1-PDOV-WTBS	C1-MD-BILL	Account	C1_ACCTSRCH	Bill
BILL-WO	By Bill Weighted Outstanding Amount	C1-PDOV-WTOA		Account	C1_ACCT_SRCH	Bill
BILLSEG	By Bill Segment	C1-PDOV-PYBS	C1-MD-BSEG	Account	C1_ACCTSRCH	Bill Segment
BYSATY	By Suspense Contract	C1-PDOV-SATY	C1-MD-ONSA	Account	C1_ACCTSRCH	Contract
SETT-ID	By Settlement ID	C1-PDOV-PYSL	C1-MD-SID	Account	C1_ACCTSRCH	Settlement
BYBILL	By Bill	C1-PDOV-PYBL or C1-PDOV-WTBS	C1-MDBYBILL	Bill	CI_BILL	Bill
BILL-BS	By Bill - Pay By Bill Segment Oldest	C1-PDOV-BSDT		Account	C1_ACCT_SRCH	Bill

Note: The **C1-PDOV-BSDT** algorithm for the bill match type BILL-BS is used to distribute the amount among the bill segments of the bill in the order of bill segment start date.

Note: The **C1-PDOV-WTOA** algorithm for the bill match type BILL-WOA performs the bill weighted calculation based on the unpaid amount on the bill segment.

- Create a defer algorithm using the **C1-PAY-COUNT** algorithm type
- Define the required payment request types in the system
- Define the required characteristic types where the characteristic entity is set to **Payment Request Type**
- Define the required characteristic types where the characteristic entity is set to **Payment Tender**
- Define rejected status reasons for the **C1-PaymentRequest** business object
- Define rejected status reasons for the **C1-PaymentTransferRequest** business object
- Define payment cancelation or transfer reasons through the **Payment Cancel Reason** screen

- Assign the **C1-PAYRQ** To Do type to a To Do role whose users must receive To Do generated while submitting a payment request for approval
- Set the **Payment Portal Configuration (C1-PAYPORTAL)** feature configuration
- Set the **Payment Request-Sort Distribution data (C1-PYREQSRT)** feature configuration
- Set the batch control type of the **Payment Request Periodic Monitor (C1-PAYRQ)** batch to **Timed** and define the following attributes:
 - Time Interval
 - Timer Active
 - User ID
 - Batch Language
 - Email Address

Related Topics

For more information on...	See...
How to set the C1-PAYPORTAL feature configuration	Setting the C1-PAYPORTAL Feature Configuration on page 4336
How to set the C1-PYREQSRT feature configuration	Setting the C1-PYREQSRT Feature Configuration on page 4345

Payment Creation Request (Without Approval) Status Transition

The following figure graphically indicates how a payment creation or transfer request moves from one status to another when the approval workflow is off:

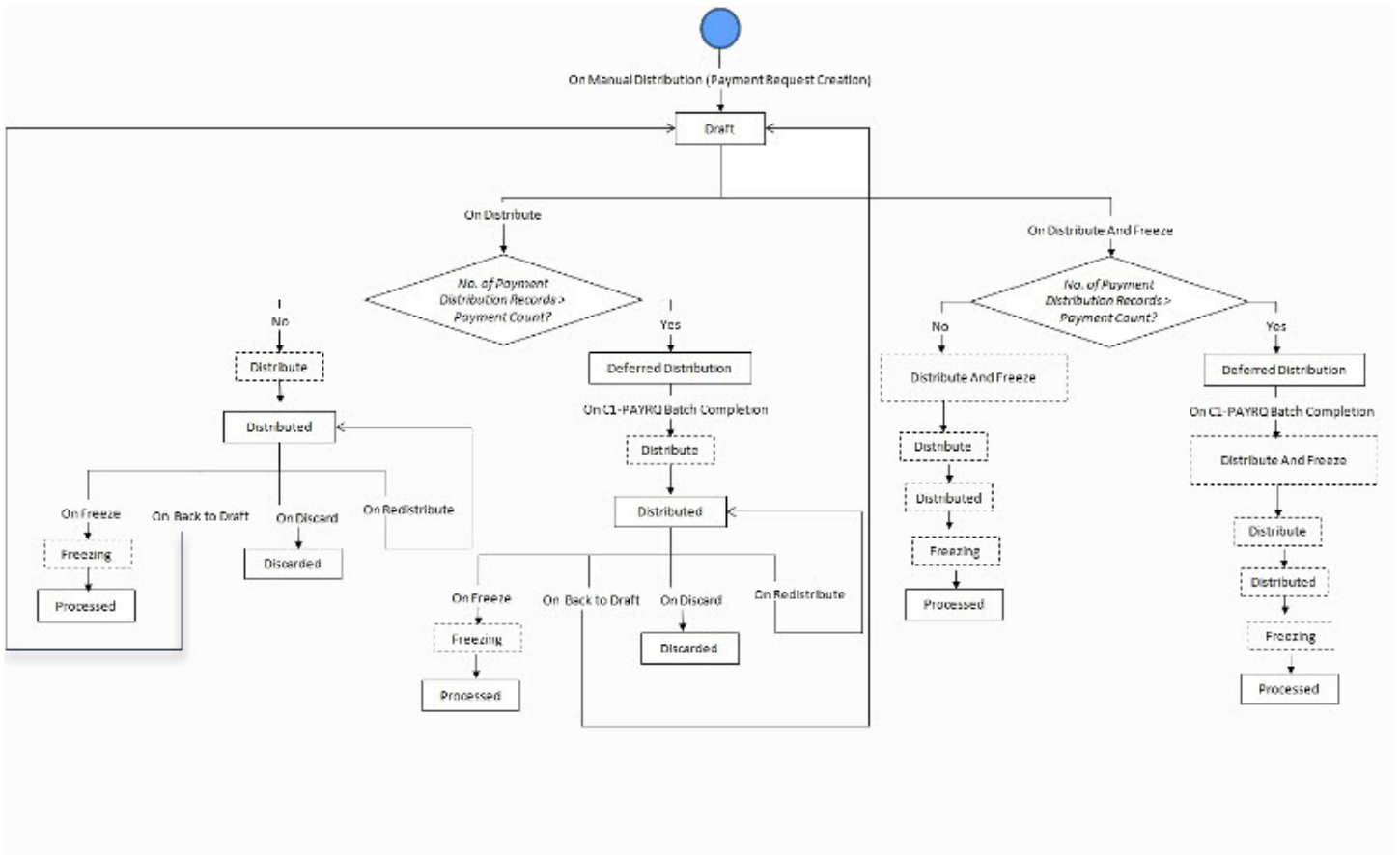

Payment Creation Request (With Approval) Status Transition

The following figure graphically indicates how a payment creation or transfer request moves from one status to another when approval workflow is on:

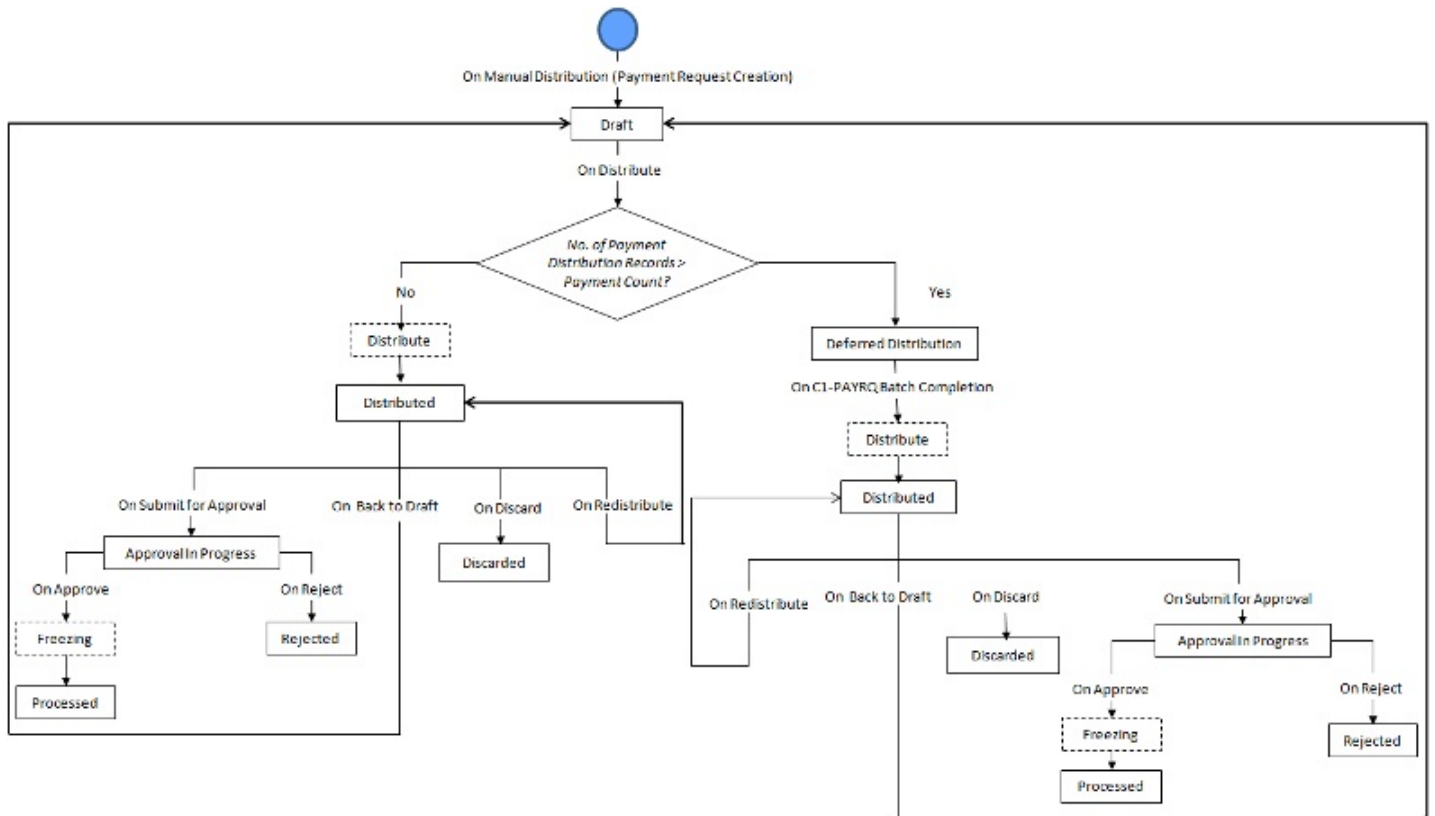

Payment Transfer Request (Without Approval) Status Transition

The following figure graphically indicates how a payment transfer request moves from one status to another when the approval workflow is off:

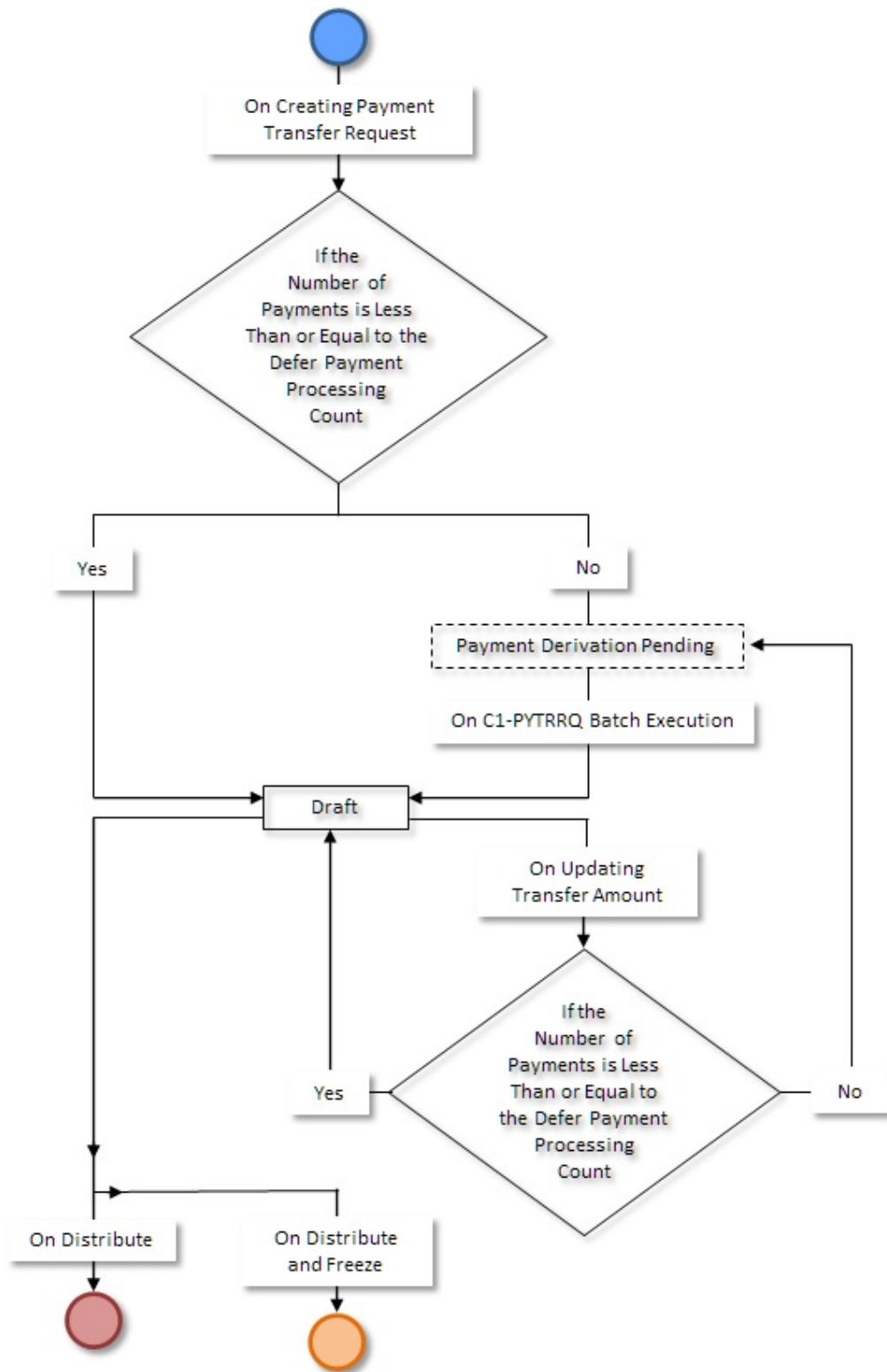

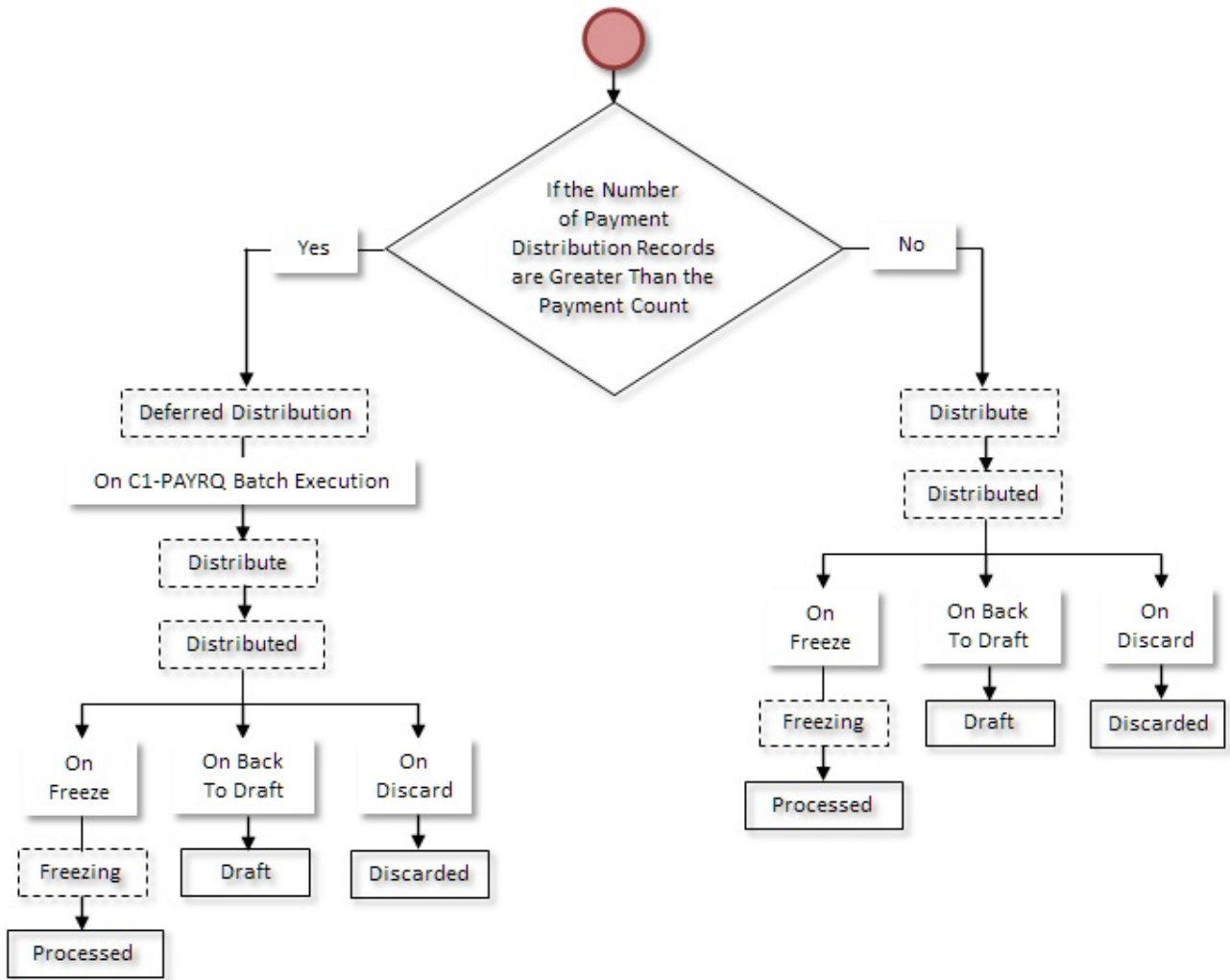

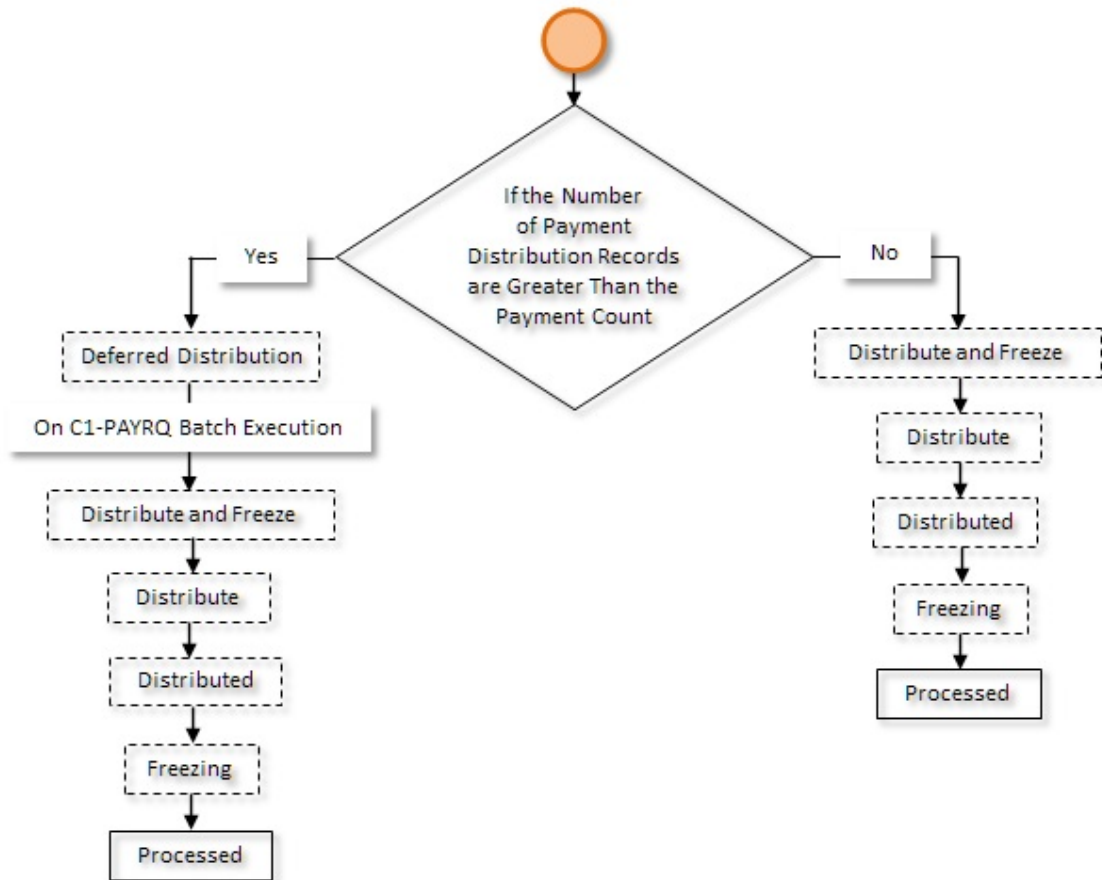

Payment Transfer Request (With Approval) Status Transition

The following figure graphically indicates how a payment transfer request moves from one status to another when the approval workflow is on:

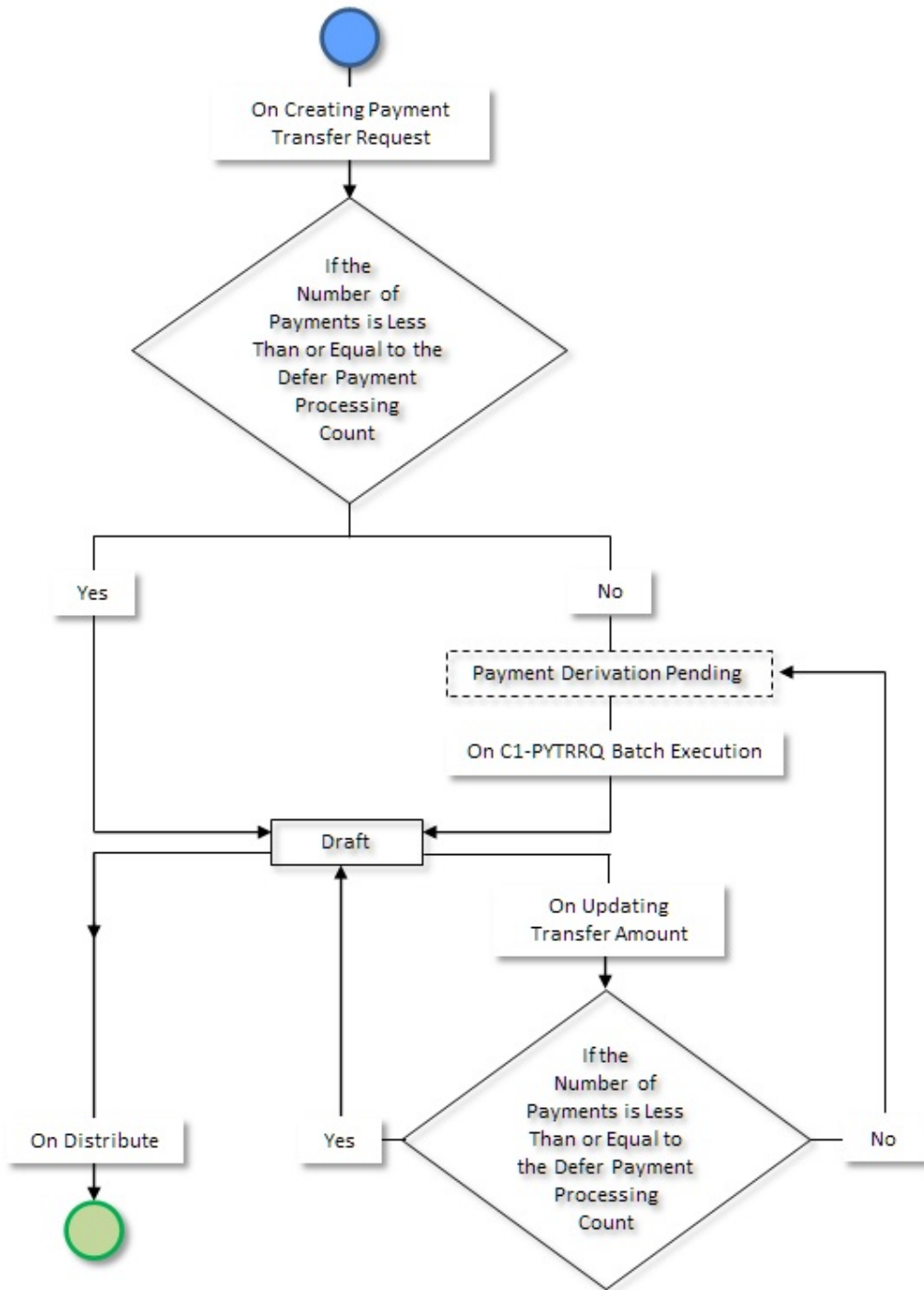

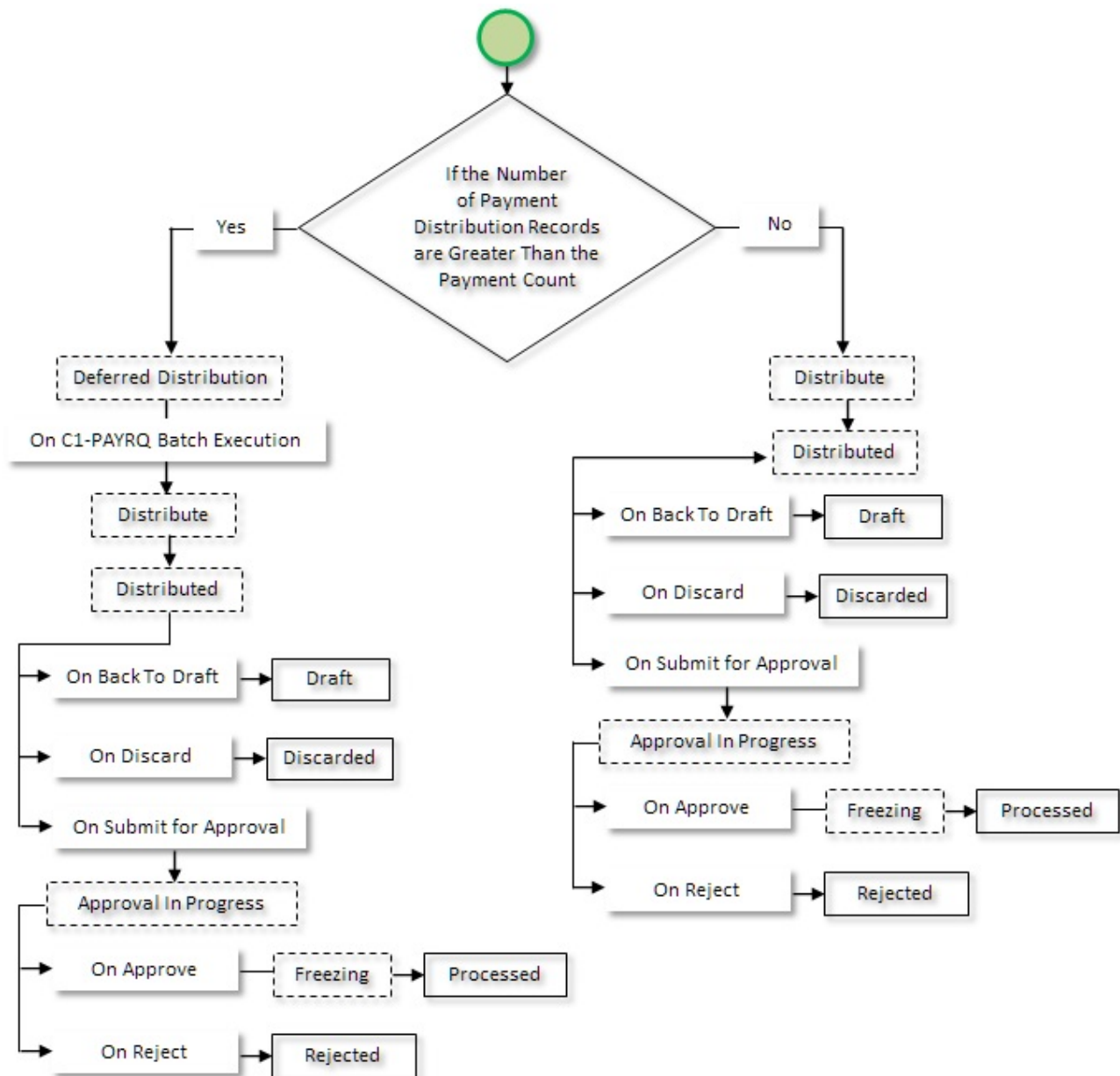

Algorithms Used in C1-PaymentRequest

The following table lists the algorithms which are attached to the **C1-PaymentRequest** business object:

System Event	Algorithm	Algorithm Type	Description
Information	C1-PAYRQ-INF	C1-PAYRQ-INF	Refer to C1-PAYRQ-INF on page 1452
Post-Processing	C1-PAYREQPOS	C1-PAYREQPOS	Refer to C1-PAYREQPOS on page 1452
Validation	C1-PAYREQVAL	C1-PAYREQVAL	Refer to C1-PAYREQVAL on page 1453

The following table lists the algorithms which are used in the lifecycle of the **C1-PaymentRequest** business object:

Status	System Event	Algorithm	Algorithm Type	Description
Draft	Enter	C1-PAY-DFT	C1-PAY-DFT	Refer to C1-PAY-DFT on page 1453
Draft	Exit	C1-PAYDFTEXT	C1-PAYDFTEXT	Refer to C1-PAYDFTEXT on page 1453
Approval Progress	In Enter	C1-PAY-PFA	C1-PAY-PFA	Refer to C1-PAY-PFA on page 1453
Approval Progress	In Exit	C1-PAYPFAEXT	C1-PAYPFAEXT	Refer to C1-PAYPFAEXT on page 1453
Approval Progress	In Exit	F1-TODOCOMPL	F1-TODOCOMPL	Refer to F1-TODOCOMPL on page 1453
Approved	Enter	C1-PAY-APP	C1-PAY-APP	Refer to C1-PAY-APP on page 1453
Distribute	Enter	C1-PAY-DIST	C1-PAY-DIST	Refer to C1-PAY-DIST on page 1453
Deferred Distribution	Monitor	C1-PAY-MONT	C1-PAY-MONT	Refer to C1-PAY-MONT on page 1453
Distributed	Enter	C1-PAYCREATE	C1-PAYCREATE	Refer to C1-PAYCREATE on page 1453
Distributed	Exit	C1-FRZ-VALID	C1-FRZ-VALID	Refer to C1-FRZ-VALID on page 1454
Distributed	Exit	F1-TODOCOMPL	F1-TODOCOMPL	Refer to F1-TODOCOMPL on page 1453
Freezing	Enter	C1-PAY-V-FRZ	C1-PAY-V-FRZ	Refer to C1-PAY-V-FRZ on page 1454
Freezing	Enter	C1-PAY-FRZ	C1-PAY-FRZ	Refer to C1-PAY-FRZ on page 1454
Processed	-	-	-	-
Rejected	Enter	C1-PAY-RJT	C1-PAY-RJT	Refer to C1-PAY-RJT on page 1454
Discarded	Enter	C1-PAY-RJT	C1-PAY-RJT	Refer to C1-PAY-RJT on page 1454
Distribute And Freeze	Enter	C1-ISFREEZE	C1-ISFREEZE	Refer to C1-ISFREEZE on page 1454

C1-PAYRQ-INF

This algorithm generates the payment request information string which appears throughout the application. This algorithm concatenates the following fields:

- Payment Request Type Description
- Payment Request Status Description
- Payment Request ID

C1-PAYREQPOS

This algorithm invokes the manual distribution algorithm of the match types that are newly added while editing a payment request. It also deletes the respective match type entities from the **C1_PAY_DISTRIBUTION** table when you remove a match type while editing a payment request.

C1-PAYREQVAL

This algorithm checks whether the mandatory data (such as payment date, payor account, tender type, tender amount, currency, match type, and match entity) is specified while creating a payment request. It also checks whether auto pay source, auto pay route type, and account number are specified when you select a tender type where the **Generate Auto Pay** option is selected. This algorithm is triggered when you click the **Manual Distribution** button.

Note: You do not specify the tender and auto pay details while creating a payment transfer request.

C1-PAY-DFT

This algorithm invokes the manual distribution algorithm of the match types that you have selected while creating a payment request.

C1-PAYDFTEXT

This algorithm checks whether the sum of the distributed payment amount is equal to the tender or transfer amount. This algorithm is triggered when you click the **Distribute** button.

C1-PAY-PFA

This algorithm creates the To Do using the To Do type specified in the payment request type using which the payment request is created. The To Do is sent to the users with the approval To Do role specified in the payment request type.

C1-PAYPFAEXT

This algorithm checks whether the approver is associated with the approval To Do role specified in the payment request type. It does not allow the submitter to approve or reject the payment request.

F1-TODOCOMPL

This algorithm type completes the To Do entries that are linked to an object when the object exits the given status.

It finds and completes all open To Do entries where the business object's primary key is defined as a drill key. However, if the **Exclude To Do Entries From Auto Completion** characteristic is set to **Y** for the business object, the system does not automatically complete the respective To Do entry.

C1-PAY-APP

This algorithm changes the status of the payment request to **Freezing** when the approver clicks the **Approve** button.

C1-PAY-DIST

This algorithm invokes the defer algorithm specified in the payment request type using which the payment request is created. The defer algorithm checks whether the tender or transfer amount must be distributed in the real time (i.e. immediately) or in the deferred mode. If the tender or transfer amount must be distributed in the real time, the status of the payment request is changed to **Distributed**. However., if the tender or transfer amount must be distributed in the deferred mode, the status of the payment request is changed to **Deferred Distribution**.

C1-PAY-MONT

This algorithm is invoked from the **Payment Request Periodic Monitor (C1-PAYRQ)** batch. It changes the status of the payment request from **Deferred Distribution** to **Distributed**.

C1-PAYCREATE

This algorithm creates the payment event, payments, payment segments, and payment tender. A payment is created for each record in the **C1_PAY_DISTRIBUTION** table where the payment amount is greater than or less than zero. The status of the payments is set to **Freezable**. If any error occurs while creating a payment, the status of the payment is set to **Error**. The payment event ID is updated corresponding to the payment request in the **C1_PAY_REQ** table. Finally, the status of the payment request is changed to **Distributed**.

C1-FRZ-VALID

This algorithm is triggered when you click the **Submit for Approval** or **Freeze** button. It checks whether the sum of payment segment amount is equal to the payment amount for each payment.

C1-PAY-V-FRZ

This algorithm validates whether payment already exists on the entity. It checks the unpaid amount of the entity.

C1-PAY-FRZ

This algorithm fetches the payment event created through the payment request. If you are freezing the payments of a payment creation request, this algorithm does the following:

- Changes the status of the payments which are in the **Freezable** status to **Frozen**
- Changes the status of the payment event to **Balanced** when there are no payments in the **Error** status

However, if you are freezing the payments of a payment transfer request, this algorithm does the following:

- Changes the status of the old payments which are in the **Frozen** status to **Cancelled**
- Deletes the old payments which are in the **Error** status
- Changes the status of the new payments which are in the **Freezable** status to **Frozen**
- Changes the status of the payment event to **Balanced** when there are no payments in the **Error** status

C1-PAY-RJT

This algorithm is triggered when the approver clicks the **Reject** button. If you are rejecting a payment creation request, this algorithm deletes the payment event, payments, payment segments, and payment tender which are created through the payment creation request. However, if you are rejecting a payment transfer request, this algorithm deletes the new payments which are created through the payment transfer request.

C1-ISFREEZE

This algorithm invokes the distribute algorithm and set Flag in the payment request clob.

Algorithms Used in C1-PaymentTransferRequest

The following table lists the algorithms which are attached to the **C1-PaymentTransferRequest** business object:

System Event	Algorithm	Algorithm Type	Description
Information	C1-PAYRQ-INF	C1-PAYRQ-INF	Refer to C1-PAYRQ-INF on page 1452
Post-Processing	C1-PAYREQPOS	C1-PAYREQPOS	Refer to C1-PAYREQPOS on page 1452
Validation	C1-PAYREQVAL	C1-PAYREQVAL	Refer to C1-PAYREQVAL on page 1453

The following table lists the algorithms which are used in the lifecycle of the **C1-PaymentTransferRequest** business object:

Status	System Event	Algorithm	Algorithm Type	Description
Draft	Enter	C1-PYTRDF	C1-PYTRDF	Refer to C1-PYTRDF on page 1455
Draft	Enter	C1-PAY-DFT	C1-PAY-DFT	Refer to C1-PAY-DFT on page 1453
Draft	Exit	C1-PAYDFTEXT	C1-PAYDFTEXT	Refer to C1-PAYDFTEXT on page 1453
Payment Derivation Pending	Monitor	C1-PYTR-MONT	C1-PYTR-MONT	Refer to C1-PYTR-MONT on page 1456
Update Transfer Amount	Enter	C1-PYTR-UPDT	C1-PYTR-UPDT	Refer to C1-PYTR-UPDT on page 1456
Approval In Progress	Enter	C1-PAY-PFA	C1-PAY-PFA	Refer to C1-PAY-PFA on page 1453
Approval In Progress	Exit	C1-PAYPFAEXT	C1-PAYPFAEXT	Refer to C1-PAYPFAEXT on page 1453
Approval In Progress	Exit	F1-TODOCOMPL	F1-TODOCOMPL	Refer to F1-TODOCOMPL on page 1453
Approved	Enter	C1-PAY-APP	C1-PAY-APP	Refer to C1-PAY-APP on page 1453
Distribute	Enter	C1-PAY-DIST	C1-PAY-DIST	Refer to C1-PAY-DIST on page 1453
Deferred Distribution	Monitor	C1-PAY-MONT	C1-PAY-MONT	Refer to C1-PAY-MONT on page 1453
Distributed	Enter	C1-PAYCREATE	C1-PAYCREATE	Refer to C1-PAYCREATE on page 1453
Distributed	Exit	C1-FRZ-VALID	C1-FRZ-VALID	Refer to C1-FRZ-VALID on page 1454
Distributed	Exit	F1-TODOCOMPL	F1-TODOCOMPL	Refer to F1-TODOCOMPL on page 1453
Freezing	Enter	C1-PAY-V-FRZ	C1-PAY-V-FRZ	Refer to C1-PAY-V-FRZ on page 1454
Freezing	Enter	C1-PAY-FRZ	C1-PAY-FRZ	Refer to C1-PAY-FRZ on page 1454
Processed	-	-	-	-
Rejected	Enter	C1-PAY-RJT	C1-PAY-RJT	Refer to C1-PAY-RJT on page 1454
Discarded	Enter	C1-PAY-RJT	C1-PAY-RJT	Refer to C1-PAY-RJT on page 1454
Distribute And Freeze	Enter	C1-ISFREEZE	C1-ISFREEZE	Refer to C1-ISFREEZE on page 1454
Cancel	-	-	-	-

C1-PYTRDF

This algorithm invokes manual distribution algorithm of the match types that you have selected while creating a payment transfer request. It checks whether the payment transfer count exceeds the defer processing count. If the payment transfer count exceeds the defer processing count, the system changes the status of the payment transfer request to **Payment Derivation Pending**.

C1-PAY-DFT

This algorithm invokes the manual distribution algorithm of the match types that you have selected while creating a payment request.

C1-PAYDFTEXT

This algorithm checks whether the sum of the distributed payment amount is equal to the tender or transfer amount. This algorithm is triggered when you click the **Distribute** button.

C1-PYTR-MONT

This algorithm is invoked from the **Payment Transfer Deferred Periodic Monitor (C1-PAYTR)** monitor batch. The system fetches the list of payments depending on whether payment transfer is done at the payment event or payment level. It then considers the payments which are eligible for transfer from the payment list based on the following transfer priority:

1. Payments created on the suspense contract (if any)
2. Payments created on the on account contract (if any)
3. Payments created on the excess credit contract (if any)
4. Payments created against bills in the descending order of bill date followed by the descending order of payment amount (when there two or more bills with the same bill date)

Once the system identifies the payments for transfer from the payment list, the payment transfer request is created and the status is changed from **Payment Derivation Pending** to **Draft**. A payment transfer record is created in the **C1_PAY_DETAILS** table along with the transfer priority and cancel switch.

C1-PYTR-UPDT

This algorithm is invoked when you click the **Update Transfer Amount** button. The system allows you to change the transfer amount, if required. On changing the transfer amount, system determines the payments which are eligible for transfer and changes the status of the payment transfer request to **Payment Derivation Pending** or **Draft**.

C1-PAY-PFA

This algorithm creates the To Do using the To Do type specified in the payment request type using which the payment request is created. The To Do is sent to the users with the approval To Do role specified in the payment request type.

C1-PAYPFAEXT

This algorithm checks whether the approver is associated with the approval To Do role specified in the payment request type. It does not allow the submitter to approve or reject the payment request.

F1-TODOCOMPL

This algorithm type completes the To Do entries that are linked to an object when the object exits the given status.

It finds and completes all open To Do entries where the business object's primary key is defined as a drill key. However, if the **Exclude To Do Entries From Auto Completion** characteristic is set to **Y** for the business object, the system does not automatically complete the respective To Do entry.

C1-PAY-APP

This algorithm changes the status of the payment request to **Freezing** when the approver clicks the **Approve** button.

C1-PAY-DIST

This algorithm invokes the defer algorithm specified in the payment request type using which the payment request is created. The defer algorithm checks whether the tender or transfer amount must be distributed in the real time (i.e. immediately) or in the deferred mode. If the tender or transfer amount must be distributed in the real time, the status of the payment request is changed to **Distributed**. However., if the tender or transfer amount must be distributed in the deferred mode, the status of the payment request is changed to **Deferred Distribution**.

C1-PAY-MONT

This algorithm is invoked from the **Payment Request Periodic Monitor (C1-PAYRQ)** batch. It changes the status of the payment request from **Deferred Distribution** to **Distributed**.

C1-PAYCREATE

This algorithm creates the payment event, payments, payment segments, and payment tender. A payment is created for each record in the **C1_PAY_DISTRIBUTION** table where the payment amount is greater than or less than zero. The status of the payments is set to **Freezable**. If any error occurs while creating a payment, the status of the payment is set to **Error**. The payment event ID is updated corresponding to the payment request in the **C1_PAY_REQ** table. Finally, the status of the payment request is changed to **Distributed**.

C1-FRZ-VALID

This algorithm is triggered when you click the **Submit for Approval** or **Freeze** button. It checks whether the sum of payment segment amount is equal to the payment amount for each payment.

C1-PAY-V-FRZ

This algorithm validates whether payment already exists on the entity. It checks the unpaid amount of the entity.

C1-PAY-FRZ

This algorithm fetches the payment event created through the payment request. If you are freezing the payments of a payment creation request, this algorithm does the following:

- Changes the status of the payments which are in the **Freezable** status to **Frozen**
- Changes the status of the payment event to **Balanced** when there are no payments in the **Error** status

However, if you are freezing the payments of a payment transfer request, this algorithm does the following:

- Changes the status of the old payments which are in the **Frozen** status to **Cancelled**
- Deletes the old payments which are in the **Error** status
- Changes the status of the new payments which are in the **Freezable** status to **Frozen**
- Changes the status of the payment event to **Balanced** when there are no payments in the **Error** status

C1-PAY-RJT

This algorithm is triggered when the approver clicks the **Reject** button. If you are rejecting a payment creation request, this algorithm deletes the payment event, payments, payment segments, and payment tender which are created through the payment creation request. However, if you are rejecting a payment transfer request, this algorithm deletes the new payments which are created through the payment transfer request.

C1-ISFREEZE

This algorithm invokes the distribute algorithm and set Flag in the payment request clob.

Payment Request Type

Oracle Revenue Management and Billing allows you to define a payment request type using which you can create a payment request. A payment request of the specified payment request type is created when you manually distribute the tender or payment amount. It is the payment request type which helps the system to determine:

- Whether to create payment transfer or payment creation request
- Whether payment events and payments must be created in real time (i.e. immediately) or in the deferred mode
- Whether payment creation or transfer instructions must be approved by the approver before freezing payments

The **Payment Request Type** screen allows you to define, edit, copy, and delete a payment request type. This screen consists of the following zones:

- [Payment Request Type List](#) on page 1458
- [Payment Request Type](#) on page 1459

Payment Request Type List

The **Payment Request Type List** zone lists payment request types that are already defined in the system. It contains the following columns:

Column Name	Column Description
Payment Request Type	Displays the payment request type.
Description	Displays the description of the payment request type.
Edit	On clicking the Edit (✎) icon, the Payment Request Type screen appears where you can edit the details of the payment request type.
Duplicate	On clicking the Duplicate (📄) icon, the Payment Request Type screen appears where you can define a payment request type using an existing payment request type.
Delete	On clicking the Delete (🗑) icon, you can delete the payment request type.
	Note: You can delete a payment request type when you have not created a payment request using the payment request type.

On clicking the **Broadcast** (📡) icon corresponding to a payment request type, the **Payment Request Type** zone appears with the details of the respective payment request type.

Related Topics

For more information on...	See...
How to define a payment request type	Defining a Payment Request Type on page 1461
How to edit a payment request type	Editing a Payment Creation Request on page 1497
How to copy a payment request type	Copying a Payment Request Type on page 1468

For more information on...	See...
How to delete a payment request type	Deleting a Payment Request Type on page 1472
How to view the details of a payment request type	Viewing the Payment Request Type Details on page 1472

Payment Request Type

The **Payment Request Type** zone displays the details of the payment request type. This zone contains the following sections:

- **Main** - This section provides basic information about the payment request type. It contains the following fields:

Field Name	Field Description
Payment Request Type	Displays the payment request type.
Payment Request Business Object	Indicates the business object that will be used to create the payment request. Note: It has a link. On clicking the link, the Business Object screen appears where you can view the details of the respective business object.
Description	Displays the description of the payment request type.
Detailed Description	Displays additional information about the payment request type.
Status	Indicates the status of the payment request type. The valid values are: <ul style="list-style-type: none"> • Active • Inactive
Defer Algorithm	Indicates the algorithm that will be triggered when you distribute tender or payment amount. This algorithm checks whether the number of payment distribution records in the payment request exceeds the payment count (defined in the Defer algorithm). If the number of payment distribution records in the payment request does not exceed the payment count, the system distributes tender or payment amount and accordingly creates payment event and payments in real time (i.e. immediately). However, if the number of payment distribution records in the payment request exceeds the payment count, the system distributes tender or payment amount in the deferred mode. Note: Number of payment distribution records = (Number of bill segments present in each bill fetched using the Bill Weighted, Bill Regular, and Bill match type algorithm) + (Number of bill segments fetched using the Bill Segment match type algorithm) + (Number of contracts fetched using the Suspense Contract match type algorithm) + (Number of settlements fetched using the Settlement match type algorithm) It has a link. On clicking the link, the Algorithm screen appears where you can view the details of the respective algorithm.
Approval Required	Indicates whether approval is required while freezing payments of the payment requests which are created using the payment request type.
Approval To Do Type	Indicates that To Do of the specified To Do type must be created when you submit the payment request for approval.

Field Name	Field Description
	<p>Note:</p> <p>This field appears when the Approval Required check box is selected.</p> <p>It has a link. On clicking the link, the To Do Type screen appears with the details of the respective To Do type.</p>
Approval To Do Role	<p>Indicates that users with the specified To Do role can only approve the payment request submitted for approval.</p> <p>Note:</p> <p>This field appears when the Approval Required check box is selected.</p> <p>It has a link. On clicking the link, the To Do Role screen appears where you can view the details of the respective To Do role.</p>
Transfer	Indicates whether the payment request type will be used to create payment transfer or payment creation request.
Defer Payment Processing Count	<p>Indicates whether a payment request must be processed in the deferred mode (i.e. in the background) when the number of payments in the payment request exceed the defer processing count.</p> <p>Note: This field appears when the Transfer option is selected.</p>

- **Characteristics** - This section lists the characteristics of the payment request type. It contains the following columns:

Column Name	Column Description
Characteristic Type	Indicates the characteristic type.
Characteristic Value	Displays the value of the characteristic type.

- **Record Actions** - This section contains the following buttons:

Button Name	Button Description
Edit	Used to edit the details of the payment request type.
Delete	<p>Used to delete the payment request type.</p> <p>Note: You can delete a payment request type when you have not created a payment request using the payment request type.</p>
Duplicate	Used to create a new payment request type using an existing payment request type.

- **Record Information** - This section contains the following fields:

Field Name	Field Description
Business Object	Indicates the business object using which the payment request type is created. In addition, a context menu appears corresponding to this field which helps in navigating to other screens in the application.

Field Name	Field Description
	Note: It has a link. On clicking the link, the Business Object screen appears where you can view the details of the respective business object.

By default, the **Payment Request Type** zone does not appear in the **Payment Request Type** screen. It appears when you click the **Broadcast** () icon corresponding to a payment request type in the **Payment Request Type List** zone.

Related Topics

For more information on...	See...
How to define a payment request type	Defining a Payment Request Type on page 1461
How to edit a payment request type	Editing a Payment Creation Request on page 1497
How to copy a payment request type	Copying a Payment Request Type on page 1468
How to delete a payment request type	Deleting a Payment Request Type on page 1472
How to view the details of a payment request type	Viewing the Payment Request Type Details on page 1472

Defining a Payment Request Type

Prerequisites

To define a payment request type, you should have:

- Payment request business objects defined in the application
- Defer algorithm defined using the **C1-PAY-COUNT** algorithm type
- **C1-PAYRQ** To Do type assigned to a To Do role whose users must receive To Do generated while submitting a payment request for approval

Procedure

To define a payment request type:

1. Click the **Admin** link in the **Application** toolbar.
A list appears.
2. From the **Admin** menu, select **P** and then click **Payment Request Type**.
A sub-menu appears.
3. Click the **Add** option from the **Payment Request Type** sub-menu.

The **Select Business Object** screen appears. It contains the following fields:

Field Name	Field Description	Mandatory (Yes or No)
Payment Request Type Business Object	Used to indicate the business object that you want to use to create the payment request type.	Yes

Tip: Alternatively, you can access the **Select Business Object** screen by clicking the **Add** button in the **Page Title** area of the **Payment Request Type** screen.

Note: The **Select Business Object** screen appears when there are multiple payment request type business objects defined in the application. If there is only one payment request type business object defined in the application, the **Payment Request Type** screen appears.

4. Select the required payment request type business object from the respective field.
5. Click **OK**.

The **Payment Request Type** screen appears. It contains the following sections:

- **Main** - Used to specify basic details about the payment request type.
- **Characteristics** - Used to define the characteristics for the payment request type.

The **Main** section contains the following fields:

Field Name	Field Description	Mandatory (Yes or No)
Payment Request Type	Used to specify the payment request type.	Yes
Business Object	Indicates the payment request type business object used while defining the payment request type.	Not applicable
Payment Request Business Object	Used to indicate the business object that you want to use while creating the payment request.	Yes
Description	Used to specify the description for the payment request type.	Yes
Detailed Description	Used to specify additional information about the payment request type.	No
Status	Used to indicate the status of the payment request type. The valid values are: <ul style="list-style-type: none"> • Active • Inactive 	Yes
Defer Algorithm	Used to attach an algorithm that will be triggered when you distribute tender or payment amount. This algorithm checks whether the number of payment distribution records in the payment request exceeds the payment count (defined in the Defer algorithm). If the number of payment distribution records in the payment request does not exceed the payment count, the system distributes tender or payment amount and accordingly creates payment event and payments in real time (i.e. immediately). However, if the number of payment distribution records in the payment request exceeds the payment count, the system distributes tender or payment amount in the deferred mode.	Yes

Field Name	Field Description	Mandatory (Yes or No)
	<p>Note:</p> <p>Number of payment distribution records = (Number of bill segments present in each bill fetched using the Bill Weighted, Bill Regular, and Bill match type algorithm) + (Number of bill segments fetched using the Bill Segment match type algorithm) + (Number of contracts fetched using the Suspense Contract match type algorithm) + (Number of settlements fetched using the Settlement match type algorithm)</p> <p>Deferred mode means in the background when the Payment Request Periodic Monitor (C1-PAYRQ) batch is invoked. You can configure the Payment Request Periodic Monitor (C1-PAYRQ) batch such that it is executed at regular intervals. When the Payment Request Periodic Monitor (C1-PAYRQ) batch is invoked, the system checks whether there are any payment requests in the Deferred Distribution status. If there is a payment request in the Deferred Distribution status, the system distributes tender or payment amount and accordingly creates payment event and payments.</p> <p>Note:</p> <p>The Search (🔍) icon appears corresponding to this field. On clicking the Search icon, the Algorithm Search window appears.</p>	
Approval Required	Used to indicate whether approval is required while freezing payments of the payment requests which are created using the payment request type.	No
Approval To Do Type	Used to indicate that To Do of the specified To Do type must be created when you submit the payment request for approval.	Yes (Conditional)
	Note: This field appears when the Approval Required check box is selected.	Note: This field is required when the Approval Required check box is selected.
Approval To Do Role	Used to indicate that users with the specified To Do role can only approve the payment request submitted for approval.	Yes (Conditional)
	Note: This field appears when the Approval Required check box is selected.	Note: This field is required when the Approval Required check box is selected.
Transfer	Used to indicate whether the payment request type will be used to create payment transfer or payment creation request.	No
Defer Payment Processing Count	Used to indicate whether a payment request must be processed in the deferred mode (i.e. in the background) when	No

Field Name	Field Description	Mandatory (Yes or No)
	<p>the number of payments in the payment request exceed the defer processing count.</p> <p>Note:</p> <p>This field appears when the Transfer option is selected.</p> <p>You cannot specify a negative value in the Defer Payment Processing Count field. If you do not specify the defer payment processing count, by default, it is set to zero (0).</p> <p>Deferred mode means in the background when the Payment Request Periodic Monitor (C1-PAYRQ) batch is invoked. You can configure the Payment Request Periodic Monitor (C1-PAYRQ) batch such that it is executed at regular intervals. For more information about the Payment Request Periodic Monitor (C1-PAYRQ) batch, refer to <i>Oracle Revenue Management and Billing Batch Guide</i>.</p> <p>If the number of bills in a payment request does not exceed the defer processing count, the system will process the payment request in real time (i.e. immediately).</p>	

6. Enter the required details.

Note: You can search for an algorithm and To Do type by clicking the **Search** (🔍) icon corresponding to the respective field.

7. Define characteristics for the payment request type, if required.
8. Click **Save**.

The payment request type is defined.

Related Topics

For more information on...	See...
Payment Request Type screen	Payment Request Type on page 1458
Payment Request Type List zone	Payment Request Type List on page 1458
How to define a characteristic for a payment request type	Defining a Characteristic for a Payment Request Type on page 1464

Defining a Characteristic for a Payment Request Type

Prerequisites

To define a characteristic for a payment request type, you should have:

- Characteristic types defined in the application (where the characteristic entity is set to **Payment Request Type**)

Procedure

To define a characteristic for a payment request type:

1. Ensure that the **Characteristics** section is expanded when you are defining, editing, or copying a payment request type.

The **Characteristics** section contains the following fields:

Field Name	Field Description	Mandatory (Yes or No)
Characteristic Type	Used to indicate the characteristic type.	Yes (Conditional)
	Note: The list includes only those characteristic types where the characteristic entity is set to Payment Request Type .	Note: This field is required when you are defining a characteristic for the payment request type.
Characteristic Value	Used to specify the value for the characteristic type.	Yes (Conditional)
	Note: On specifying the value for a predefined characteristic type, the description of the characteristic value appears corresponding to the Characteristic Value field.	Note: This field is required when you are defining a characteristic for the payment request type.

- Enter the required details.

Note: If you select a predefined characteristic type, the **Search** (🔍) icon appears corresponding to the **Characteristic Value** field. On clicking the **Search** icon, you can search for a predefined characteristic value.

- If you want to define more than one characteristic for the payment request type, click the **Add** (+) icon and then repeat step 2.

Note: However, if you want to remove a characteristic from the payment request type, click the **Delete** (🗑️) icon corresponding to the characteristic.

Related Topics

For more information on...	See...
How to define a payment request type	Defining a Payment Request Type on page 1461
How to edit a payment request type	Editing a Payment Creation Request on page 1497
How to copy a payment request type	Copying a Payment Request Type on page 1468

Editing a Payment Request Type

Prerequisites

To edit a payment request type, you should have:

- Payment request business objects defined in the application
- Defer algorithm defined using the **C1-PAY-COUNT** algorithm type
- C1-PAYRQ** To Do type assigned to a To Do role whose users must receive To Do generated while submitting a payment request for approval

Procedure

To edit a payment request type:

- Click the **Admin** link in the **Application** toolbar.

A list appears.

- From the **Admin** menu, select **P** and then click **Payment Request Type**.

A sub-menu appears.

- Click the **Search** option from the **Payment Request Type** sub-menu.

The **Payment Request Type** screen appears.

- In the **Payment Request Type List** zone, click the **Edit**  icon in the **Edit** column corresponding to the payment request type whose details you want to edit.

The **Payment Request Type** screen appears. It contains the following sections:

- **Main** - Used to specify basic details about the payment request type.
- **Characteristics** - Used to define the characteristics for the payment request type.

The **Main** section contains the following fields:

Field Name	Field Description	Mandatory (Yes or No)
Payment Request Type	Displays the payment request type.	Not applicable
Business Object	Indicates the payment request type business object used while defining the payment request type.	Not applicable
Payment Request Business Object	Used to indicate the business object that you want to use while creating the payment request.	Yes
Description	Used to specify the description for the payment request type.	Yes
Detailed Description	Used to specify additional information about the payment request type.	No
Status	Used to indicate the status of the payment request type. The valid values are: <ul style="list-style-type: none"> • Active • Inactive 	Yes
Defer Algorithm	Used to attach an algorithm that will be triggered when you distribute tender or payment amount. This algorithm checks whether the number of payment distribution records in the payment request exceeds the payment count (defined in the Defer algorithm). If the number of payment distribution records in the payment request does not exceed the payment count, the system distributes tender or payment amount and accordingly creates payment event and payments in real time (i.e. immediately). However, if the number of payment distribution records in the payment request exceeds the payment count, the system distributes tender or payment amount in the deferred mode.	Yes

Field Name	Field Description	Mandatory (Yes or No)
	<p>Note:</p> <p>Number of payment distribution records = (Number of bill segments present in each bill fetched using the Bill Weighted, Bill Regular, and Bill match type algorithm) + (Number of bill segments fetched using the Bill Segment match type algorithm) + (Number of contracts fetched using the Suspense Contract match type algorithm) + (Number of settlements fetched using the Settlement match type algorithm)</p> <p>Deferred mode means in the background when the Payment Request Periodic Monitor (C1-PAYRQ) batch is invoked. You can configure the Payment Request Periodic Monitor (C1-PAYRQ) batch such that it is executed at regular intervals. When the Payment Request Periodic Monitor (C1-PAYRQ) batch is invoked, the system checks whether there are any payment requests in the Deferred Distribution status. If there is a payment request in the Deferred Distribution status, the system distributes tender or payment amount and accordingly creates payment event and payments.</p> <p>Note:</p> <p>The Search (🔍) icon appears corresponding to this field. On clicking the Search icon, the Algorithm Search window appears.</p>	
Approval Required	Used to indicate whether approval is required while freezing payments of the payment requests which are created using the payment request type.	No
Approval To Do Type	Used to indicate that To Do of the specified To Do type must be created when you submit the payment request for approval.	Yes (Conditional)
	Note: This field appears when the Approval Required check box is selected.	Note: This field is required when the Approval Required check box is selected.
Approval To Do Role	Used to indicate that users with the specified To Do role can only approve the payment request submitted for approval.	Yes (Conditional)
	Note: This field appears when the Approval Required check box is selected.	Note: This field is required when the Approval Required check box is selected.
Transfer	Used to indicate whether the payment request type will be used to create payment transfer or payment creation request.	No
Defer Payment Processing Count	Used to indicate whether a payment request must be processed in the deferred mode (i.e. in the background)	No

Field Name	Field Description	Mandatory (Yes or No)
	<p>when the number of payments in the payment request exceeds the defer processing count.</p> <p>Note:</p> <p>This field appears when the Transfer option is selected.</p> <p>You cannot specify a negative value in the Defer Payment Processing Count field. If you do not specify the defer payment processing count, by default, it is set to zero (0).</p> <p>Deferred mode means in the background when the Payment Request Periodic Monitor (C1-PAYRQ) batch is invoked. You can configure the Payment Request Periodic Monitor (C1-PAYRQ) batch such that it is executed at regular intervals. For more information about the Payment Request Periodic Monitor (C1-PAYRQ) batch, refer to <i>Oracle Revenue Management and Billing Batch Guide</i>.</p> <p>If the number of bills in a payment request does not exceed the defer processing count, the system will process the payment request in real time (i.e. immediately).</p>	

Tip: Alternatively, you can click the **Edit** button in the **Payment Request Type** zone to edit the details of the payment request type.

5. Modify the required details.

Note: You can search for an algorithm and To Do type by clicking the **Search** (🔍) icon corresponding to the respective field.

6. Define, edit, or remove characteristics of the payment request type, if required.

7. Click **Save**.

The changes made to the payment request type are saved.

Related Topics

For more information on...	See...
Payment Request Type screen	Payment Request Type on page 1458
Payment Request Type List zone	Payment Request Type List on page 1458
Payment Request Type zone	Payment Request Type on page 1459
How to define a characteristic for a payment request type	Defining a Characteristic for a Payment Request Type on page 1464

Copying a Payment Request Type

Instead of creating a payment request type from scratch, you can create a new payment request type using an existing payment request type. This is possible through copying a payment request type. On copying a payment request type, the details including the characteristics are copied to the new payment request type. You can then edit the details, if required.

Prerequisites

To copy a payment request type, you should have:

- Payment request type (whose copy you want to create) defined in the application
- Payment request business objects defined in the application
- Defer algorithm defined using the **C1-PAY-COUNT** algorithm type
- **C1-PAYRQ** To Do type assigned to a To Do role whose users must receive To Do generated while submitting a payment request for approval

Procedure

To copy a payment request type:

1. Click the **Admin** link in the **Application** toolbar.
A list appears.
2. From the **Admin** menu, select **P** and then click **Payment Request Type**.
A sub-menu appears.
3. Click the **Search** option from the **Payment Request Type** sub-menu.
The **Payment Request Type** screen appears.
4. In the **Payment Request Type List** zone, click the **Duplicate**  icon in the **Duplicate** column corresponding to the payment request type whose copy you want to create.

The **Payment Request Type** screen appears. It contains the following sections:

- **Main** - Used to specify basic details about the payment request type.
- **Characteristics** - Used to define the characteristics for the payment request type.

The **Main** section contains the following fields:

Field Name	Field Description	Mandatory (Yes or No)
Payment Request Type	Used to specify the payment request type.	Yes
Business Object	Indicates the payment request type business object used while defining the payment request type.	Not applicable
Payment Request Business Object	Used to indicate the business object that you want to use while creating the payment request.	Yes
Description	Used to specify the description for the payment request type.	Yes
Detailed Description	Used to specify additional information about the payment request type.	No
Status	Used to indicate the status of the payment request type. The valid values are: <ul style="list-style-type: none"> • Active • Inactive 	Yes
Defer Algorithm	Used to attach an algorithm that will be triggered when you distribute tender or payment amount. This algorithm checks whether the number of payment distribution records in the payment request exceeds the payment count (defined in the Defer algorithm).	Yes

Field Name	Field Description	Mandatory (Yes or No)
	<p>If the number of payment distribution records in the payment request does not exceed the payment count, the system distributes tender or payment amount and accordingly creates payment event and payments in real time (i.e. immediately). However, if the number of payment distribution records in the payment request exceeds the payment count, the system distributes tender or payment amount in the deferred mode.</p> <p>Note:</p> <p>Number of payment distribution records = (Number of bill segments present in each bill fetched using the Bill Weighted, Bill Regular, and Bill match type algorithm) + (Number of bill segments fetched using the Bill Segment match type algorithm) + (Number of contracts fetched using the Suspense Contract match type algorithm) + (Number of settlements fetched using the Settlement match type algorithm)</p> <p>Deferred mode means in the background when the Payment Request Periodic Monitor (C1-PAYRQ) batch is invoked. You can configure the Payment Request Periodic Monitor (C1-PAYRQ) batch such that it is executed at regular intervals. When the Payment Request Periodic Monitor (C1-PAYRQ) batch is invoked, the system checks whether there are any payment requests in the Deferred Distribution status. If there is a payment request in the Deferred Distribution status, the system distributes tender or payment amount and accordingly creates payment event and payments.</p> <p>Note:</p> <p>The Search (🔍) icon appears corresponding to this field. On clicking the Search icon, the Algorithm Search window appears.</p>	
Approval Required	Used to indicate whether approval is required while freezing payments of the payment requests which are created using the payment request type.	No
Approval To Do Type	<p>Used to indicate that To Do of the specified To Do type must be created when you submit the payment request for approval.</p> <p>Note: This field appears when the Approval Required check box is selected.</p>	<p>Yes (Conditional)</p> <p>Note: This field is required when the Approval Required check box is selected.</p>
Approval To Do Role	Used to indicate that users with the specified To Do role can only approve the payment request submitted for approval.	Yes (Conditional)

Field Name	Field Description	Mandatory (Yes or No)
	Note: This field appears when the Approval Required check box is selected.	Note: This field is required when the Approval Required check box is selected.
Transfer	Used to indicate whether the payment request type will be used to create payment transfer or payment creation request.	No
Defer Payment Processing Count	<p>Used to indicate whether a payment request must be processed in the deferred mode (i.e. in the background) when the number of payments in the payment request exceeds the defer processing count.</p> <p>Note: This field appears when the Transfer option is selected. You cannot specify a negative value in the Defer Payment Processing Count field. If you do not specify the defer payment processing count, by default, it is set to zero (0). Deferred mode means in the background when the Payment Request Periodic Monitor (C1-PAYRQ) batch is invoked. You can configure the Payment Request Periodic Monitor (C1-PAYRQ) batch such that it is executed at regular intervals. For more information about the Payment Request Periodic Monitor (C1-PAYRQ) batch, refer to <i>Oracle Revenue Management and Billing Batch Guide</i>. If the number of bills in a payment request does not exceed the defer processing count, the system will process the payment request in real time (i.e. immediately).</p>	No

Tip: Alternatively, you can click the **Duplicate** button in the **Payment Request Type** zone to create a copy of the payment request type.

- Enter the required details.

Note: You can search for an algorithm and To Do type by clicking the **Search**  icon corresponding to the respective field.

- Define, edit, or remove characteristics of the payment request type, if required.
- Click **Save**.

The new payment request type is defined.

Related Topics

For more information on...	See...
Payment Request Type screen	Payment Request Type on page 1458

For more information on...	See...
Payment Request Type List zone	Payment Request Type List on page 1458
Payment Request Type zone	Payment Request Type on page 1459
How to define a characteristic for a payment request type	Defining a Characteristic for a Payment Request Type on page 1464

Deleting a Payment Request Type

Procedure

To delete a payment request type:

1. Click the **Admin** link in the **Application** toolbar.
A list appears.
2. From the **Admin** menu, select **P** and then click **Payment Request Type**.
A sub-menu appears.
3. Click the **Search** option from the **Payment Request Type** sub-menu.
The **Payment Request Type** screen appears.
4. In the **Payment Request Type List** zone, click the **Delete** (🗑️) icon in the **Delete** column corresponding to the payment request type that you want to delete.
A message appears confirming whether you want to delete the payment request type.

Note: You can delete a payment request type when you have not created a payment request using the payment request type.

Tip: Alternatively, you can click the **Delete** button in the **Payment Request Type** zone to delete the payment request type.

5. Click **OK**.
The payment request type is deleted.

Related Topics

For more information on...	See...
Payment Request Type screen	Payment Request Type on page 1458
Payment Request Type List zone	Payment Request Type List on page 1458
Payment Request Type zone	Payment Request Type on page 1459

Viewing the Payment Request Type Details

Procedure

To view the details of a payment request type:

1. Click the **Admin** link in the **Application** toolbar.
A list appears.
2. From the **Admin** menu, select **P** and then click **Payment Request Type**.
A sub-menu appears.

- Click the **Search** option from the **Payment Request Type** sub-menu.

The **Payment Request Type** screen appears.

- In the **Payment Request Type List** zone, click the **Broadcast** (📡) icon corresponding to the payment request type whose details you want to view.

The **Payment Request Type** zone appears.

- View the details of the payment request type in the **Payment Request Type** zone.

Related Topics

For more information on...	See...
Payment Request Type screen	Payment Request Type on page 1458
Payment Request Type List zone	Payment Request Type List on page 1458
Payment Request Type zone	Payment Request Type on page 1459

Payment Request (Used for Searching)

The **Payment Request** screen allows you to search for a payment creation or transfer request using various search criteria. It also allows you to create payment creation and transfer requests. It contains the following zone:

- [Search Payment Request](#) on page 1473

Through this screen, you can navigate to the following screen:

- [Payment Request \(Used for Viewing\)](#) on page 1477

Search Payment Request

The **Search Payment Request** zone allows you to search for a payment request using various search criteria. This zone contains the following two sections:

- Search Criteria** - The **Search Criteria** section contains the following fields:

Field Name	Field Description	Mandatory (Yes or No)
Search By	Used to indicate whether you want to search for a payment request using request or payment details. The valid values are: <ul style="list-style-type: none"> Request Details Payment Details 	Yes
	Note: By default, the Request Details option is selected.	
Created From	Used to search payment requests which are created from a particular date and time onwards.	No
	Note: This field appears when you select the Request Details option from the Search By list.	
Payment Request Status	Used to search payment requests with a particular status. The valid values are: <ul style="list-style-type: none"> Approval In Progress 	No

Field Name	Field Description	Mandatory (Yes or No)
	<ul style="list-style-type: none"> • Deferred Distribution • Discarded • Distribute And Freeze • Distributed • Draft • Processed • Rejected <p>Note: This field appears when you select the Request Details option from the Search By list.</p>	
Created To	<p>Used to search payment requests which are created till a particular date and time.</p> <p>Note: This field appears when you select the Request Details option from the Search By list.</p>	No
User ID	<p>Used to search payment requests which are created by a particular user.</p> <p>Note: This field appears when you select the Request Details option from the Search By list.</p> <p>The Search (🔍) icon appears corresponding to this field. On clicking the Search icon, the User Search window appears.</p>	No
Payment Request Type	<p>Used to search payment requests which are created using a particular payment request type.</p> <p>Note: This field appears when you select the Request Details option from the Search By list.</p>	No
Payment Request ID	<p>Used to search a particular payment request.</p> <p>Note: This field appears when you select the Request Details option from the Search By list.</p>	No
Payment Event ID	<p>Used to search a payment request through which a payment event is created.</p> <p>Note: This field appears when you select the Payment Details option from the Search By list.</p> <p>The Search (🔍) icon appears corresponding to this field. On clicking the Search icon, the Payment Event Search window appears.</p>	No

Field Name	Field Description	Mandatory (Yes or No)
Payor Account ID	Used to search payment requests which are created for a particular payor account.	No
	<p>Note:</p> <p>This field appears when you select the Payment Details option from the Search By list.</p> <p>The Search (🔍) icon appears corresponding to this field. On clicking the Search icon, the Account Search window appears.</p>	
Payment Date	Used to search payment requests through which payments are created on a particular date.	No
	<p>Note: This field appears when you select the Payment Details option from the Search By list.</p>	
Payor Name	Used to search payment requests which are created for a particular payor.	No
	<p>Note: This field appears when you select the Payment Details option from the Search By list.</p>	

Note: You must specify at least one search criterion while searching for a payment request.

- **Search Results** - On clicking the **Search** button, the search results appear based on the specified search criteria. The **Search Results** section contains the following columns:

Column Name	Column Description
Create Date/Time	Displays the date and time when the payment request was created in the system.
Payment Request Information	<p>Displays information about the payment request.</p> <p>Note: It has a link. On clicking the link, the Payment Request screen appears where you can view the details of the respective payment request.</p>
Status	<p>Indicates the status of the payment request. The valid values are:</p> <ul style="list-style-type: none"> • Approval In Progress • Deferred Distribution • Distributed • Draft • Processed • Rejected
Payment Event Information	Displays information about the payment event which is created through the payment request.

Column Name	Column Description
	Note: It has a link. On clicking the link, the Payment Event screen appears with the details of the respective payment event.
Created By	Indicates the user who has created the payment request.
Payor Account Information	Displays information about the payor's account for which the payment request is created. In addition, this column has a context menu which helps in navigating to other screens in the application. Note: It has a link. On clicking the link, the Account screen appears where you can view the details of the respective account.

Note: Pagination is used to display limited number of records in the **Search Results** section. You can use the navigation links, such as **Previous** and **Next** to navigate between pages.

Related Topics

For more information on...	See...
How to search for a payment request	Searching for a Payment Request on page 1476
How to create a payment request	Creating a Payment Creation Request on page 1487
How to view the details of a payment request	Viewing the Payment Request Details on page 1477

Searching for a Payment Request

Prerequisites

To search for a payment request, you should have:

- Payment request types defined in the application

Procedure

To search for a payment request:

1. Click the **Menu** link in the **Application** toolbar.
A list appears.
2. From the **Main** menu, select **Payments** and then click **Payment Request**.
A sub-menu appears.
3. Click the **Search** option from the **Payment Request** sub-menu.
The **Payment Request** screen appears.
4. Enter the search criteria in the **Search Payment Request** zone.

Note: ORMB search engine supports wildcard search, where you can substitute the percentage (%) symbol as a stand in for any word or letter in a search criteria. You can use the '%' wildcard character in all input fields except the date and ID fields. The '%' wildcard character is suffixed automatically at the end of the partial search criteria. Therefore, you may or may not specify the wildcard character at the end of the partial search criteria. However, you have to prefix the wildcard character manually wherever required.

5. Click **Search**.

A list of payment requests that meet the search criteria appears in the **Search Results** section.

Related Topics

For more information on...	See...
Payment Request screen	Payment Request (Used for Searching) on page 1473
Search Payment Request zone	Search Payment Request on page 1473

Viewing the Payment Request Details

Procedure

To view the details of a payment request:

1. Search for the payment request in the **Payment Request** screen.
2. In the **Search Results** section, click the link in the **Payment Request Information** column corresponding to the payment request whose details you want to view.

The **Payment Request** screen appears. It consists of the following tabs:

- **Main** – This tab contains the following three zones:
 - **Payment Request** – Displays the details of the payment request.
 - **Payment Details** – Displays the payments transferred through the payment request.
 - **Payment Distribution** – Lists the payment distribution records of the payment request.
 - **Log** – This tab lists the complete trail of actions performed on the payment request.
3. View the details of the payment request in the **Payment Request** zone.
 4. View the payments transferred through the payment request in the **Payment Details** zone.
 5. View the payment distribution records of the payment request in the **Payment Distribution** zone.

Related Topics

For more information on...	See...
How to search for a payment request	Searching for a Payment Request on page 1476
Payment Request screen	Payment Request (Used for Viewing) on page 1477
Payment Request zone	Payment Request on page 1478
Payment Details zone	Payment Details on page 1483
Payment Distribution zone	Payment Distribution on page 1484

Payment Request (Used for Viewing)

Once you create a payment creation or transfer request, the **Payment Request** screen allows you to:

- Edit the details of a payment request
- Edit the payment amount against each entity
- Delete a payment request
- View the details of a payment request
- Distribute the tender or payment amount

- Edit the amount of a payment segment
- Freeze the payments created through a payment request
- Submit a payment request for approval before freezing payments
- Approve or reject a payment request
- View the log of a payment request
- Add a log entry for a payment request
- View the payments transferred through a payment request
- Update the transfer amount against each entity
- Redistribute the tender or payment amount of a payment segment

It consists of the following tabs:

- [Payment Request - Main](#) on page 1478
- [Payment Request - Log](#) on page 1486

Payment Request - Main

The **Main** tab displays information about the payment request. It contains the following zones:

- [Payment Request](#) on page 1478
- [Payment Details](#) on page 1483
- [Payment Distribution](#) on page 1484

Payment Request

The **Payment Request** zone displays the details of the payment request. This zone contains the following sections:

- **Main** – This section provides basic information about the payment request. It contains the following fields:

Field Name	Field Description
Payment Request Information	Displays information about the payment request.
Payment Request Type	Indicates the payment request type using which the payment request is created. Note: It has a link. On clicking the link, the Payment Request Type screen appears where you can view the details of the payment request type.
Payment Request Status	Indicates the status of the payment request. The valid values are: <ul style="list-style-type: none"> • Approval In Progress • Deferred Distribution • Distributed • Draft • Processed • Rejected
Status Reason	Indicates the reason why the payment request is rejected.

Field Name	Field Description
	<p>Note:</p> <p>This field appears when the payment request is in the Rejected status.</p> <p>It has a link. On clicking the link, the Status Reason screen appears where you can view the details of the rejected reason.</p>
Payor Account Information	<p>Displays information about the payor's account for which the payment request is created.</p> <p>Note:</p> <p>This field appears when you are viewing the details of a payment creation request.</p> <p>It has a link. On clicking the link, the Account screen appears where you can view the details of the respective account.</p>
Payment Date	Displays the date when the payment event and payments are created.
Payment Event Information	<p>Displays information about the payment event. If you are viewing the details of a payment creation request, this field displays information about the payment event which is created through the payment creation request. However, if you are viewing the details of a payment transfer request, this field displays information about the payment event whose payments you want to transfer.</p> <p>Note:</p> <p>This field does not appear when the payment request is in the Rejected status.</p> <p>If you are viewing the details of a payment creation request, this field does not appear when the payment creation request is in the Draft status.</p> <p>It has a link. On clicking the link, the Payment Event screen appears where you can view the details of the respective payment event.</p>
Maximum Transfer Amount	<p>Displays the maximum amount which can be transferred.</p> <p>Note: This field appears when you are viewing the details of a payment transfer request.</p>
Transfer Amount	<p>Displays the total payment amount which you want to transfer.</p> <p>Note: This field appears when you are viewing the details of a payment transfer request.</p>
Transfer Reason	<p>Indicates the reason why you want to transfer the payment amount.</p> <p>Note: This field appears when you are viewing the details of a payment transfer request.</p>

- **Tender Details** – This section provides details about the tender used in the payment request. This section appears when you are viewing the details of a payment creation request. It contains the following fields:

Field Name	Field Description
Tender Type	Indicates the type of tender through which the payment was made.

Field Name	Field Description
Tender Amount	Displays the tender amount.
Currency	Indicates the currency in which the payment was made.
Check Number	Displays the cheque number if the payment is made through the cheque.
Auto Pay Route Type Code	Indicates when and how automatic payment request of the account is routed to a financial institution. Note: This field appears when you select a tender type where the Generate Auto Pay checkbox is selected in the Tender Type screen.
Schedule Extract Date	Displays the date when the automatic payment request is scheduled to be sent to a financial institution. Note: This field appears when you select a tender type where the Generate Auto Pay checkbox is selected in the Tender Type screen.
Auto Pay Source Code	Indicates the financial institution that receives the automatic payment request. Note: This field appears when you select a tender type where the Generate Auto Pay checkbox is selected in the Tender Type screen.
Distribution and Freeze Date	Displays the date when the automatic payment must be distributed and frozen in the system. Note: This field appears when you select a tender type where the Generate Auto Pay checkbox is selected in the Tender Type screen.
Account Number	Indicates the bank account number through which the automatic payment was made. Note: This field appears when you select a tender type where the Generate Auto Pay checkbox is selected in the Tender Type screen.
Expires On	Displays the date when the tender type will expire. Note: This field appears when you select a tender type where the Generate Auto Pay checkbox is selected in the Tender Type screen.
Name	Displays the name of the person as maintained in the financial institution's system. Note: This field appears when you select a tender type where the Generate Auto Pay checkbox is selected in the Tender Type screen.
Tender Control Information	Displays information about the tender control which is created when the payment event and payments are created. In addition, a context menu appears corresponding to this field which helps in navigating to other screens in the application.

Field Name	Field Description
	<p>Note:</p> <p>This field appears only when the payment request is in the Distributed, Approval In Progress, Processed , or Rejected status.</p> <p>It has a link. On clicking the link, the Tender Control screen appears where you can view the details of the respective tender control.</p>
Deposit Control Information	<p>Displays information about the deposit control which is created when the payment event and payments are created. In addition, a context menu appears corresponding to this field which helps in navigating to other screens in the application.</p> <p>Note:</p> <p>This field appears only when the payment request is in the Distributed, Approval In Progress, Processed, or Rejected status.</p> <p>It has a link. On clicking the link, the Deposit Control screen appears where you can view the details of the respective deposit control.</p>
Pay Tender ID	<p>Displays the payment tender ID.</p> <p>Note: This field appears only when the payment request is in the Processed status.</p>
Tender Status	<p>Indicates the current status of the tender. The valid values are:</p> <ul style="list-style-type: none"> • Valid • Cancelled <p>Note: This field appears when the payment request is in the Processed status.</p>
MICR ID	Displays the MICR code on the payment.
Ext. Reference ID	Displays the external reference number of the payment as it appears in the payment upload interface record.
Person ID	Indicates the person's account ID as it appears in the payment upload interface record.
Name	Indicates the person name as it appears in the payment upload interface record.

- **Characteristics** – This section lists the characteristics of the payment tender. It appears only when you are viewing the details of a payment creation request. It contains the following columns:

Column Name	Column Description
Characteristic Type	Indicates the characteristic type.
Characteristic Value	Displays the value of the characteristic type.

- **Record Actions** – This section contains the following buttons:

Column Name	Column Description
Edit	Used to edit the details of the payment request.

Column Name	Column Description
	Note: The Edit button appears when the payment request is in the Draft status.
Delete	Used to delete the payment request. Note: The Delete button appears when the payment request is in the Draft status.
Update Transfer Amount	Used to update the transfer amount. Note: The Update Transfer Amount button appears when the payment transfer request is in the Draft status. It is used for changing the transfer process from full to partial payment.
Update Tender Details	Used to update the tender details. Note: The Update Tender Details button appears when the payment transfer request is in the Processed status.
Distribute	Used to distribute the tender or payment amount. Note: The Distribute button appears when the payment request is in the Draft status.
Submit for Approval	Used to submit the payment request for approval. Note: The Submit for Approval button appears when: <ul style="list-style-type: none"> The payment request is in the Distributed status. The Approval Required check box is selected in the payment request type using which the payment request is created.
Freeze	Used to freeze the payments which are created through the payment request. Note: The Freeze button appears when: <ul style="list-style-type: none"> The payment request is in the Distributed status. The Approval Required check box is not selected in the payment request type using which the payment request is created.
Approve	Used to approve the payment request. Note: The Approve button appears when: <ul style="list-style-type: none"> The payment request is in the Approval In Progress status. A user with the approval To Do role is reviewing the payment request.
Reject	Used to reject the payment request. Note: The Reject button appears when: <ul style="list-style-type: none"> The payment request is in the Approval In Progress status. A user with the approval To Do role is reviewing the payment request.

Column Name	Column Description
Back to Draft	Used to change the status of the payment request to Draft .
	Note: The Back to Draft button appears when the payment request is in the Distributed status.
Discard	Used to discard the payment creation or transfer request.
	Note: The Discard button appears when the payment request is in the Distributed status.
Distribute And Freeze	Used to distribute and freeze the payments at the same time.
	Note: The Distribute And Freeze button appears only when the payment request is in the Draft status.

- **Record Information** – This section contains the following fields:

Field Name	Field Description
Business Object	Indicates the business object using which the payment request is created. In addition, a context menu appears corresponding to this field which helps in navigating to other screens in the application.
	Note: It has a link. On clicking the link, the Business Object screen appears where you can view the details of the respective business object.
Status Date/Time	Displays the date and time when the payment request status is updated
Create Date/Time	Displays the date and time when the payment request is created.

- **Match Types** – This section lists the match type details of the payment request. This section appears only when you are viewing the details of a payment creation request. It contains the following columns:

Column Name	Column Description
Match Type	Indicates the match type using which you want to match the payment.
Match By	Indicates the bill or account (whose entities, such as unpaid bills, unpaid bill segments, settlement IDs, or contracts) must be considered while matching the payment.

Payment Details

The **Payment Details** zone lists the payments which are transferred through the payment request. This zone contains the following column:

Column Name	Column Description
Payment Information	Displays the concatenated string consisting of payment information which is separated by a comma (.). In addition, a context menu appears corresponding to this field which helps in navigating to other screens in the application.

Column Name	Column Description
	<p>Note:</p> <p>It has a link. On clicking the link, the Payment screen appears where you can view the details of the respective payment.</p> <p>This zone appears only when the following conditions are met:</p> <ul style="list-style-type: none"> • Partial payment transfer is done at the payment event level • Full or partial payment transfer is done at the payment level

Related Topics

For more information on...	See...
How to view the payment details of a payment transfer request	

Payment Distribution

The **Payment Distribution** zone lists the payment distribution records of the payment request. This zone contains the following columns:

Column Name	Column Description
Match Type	Indicates the match type using which the payment was matched.
Payee Account ID	Indicates the account for which the payment was made. Note: It has a link. On clicking the link, the Account screen appears where you can view the details of the respective account.
Match Value	Indicates the entity (such as bill ID, bill segment ID, contract ID, or settlement ID) against which the payment was matched.
Match Entity	Indicates the type of entity against which the payment was matched. The valid values are: <ul style="list-style-type: none"> • Bill • Bill Segment • Contract • Settlement
Original Bill Amount	Displays the entity amount. Note: In case of contract, the original bill amount would be zero (0).
Write Off Adjustment Amount	Indicates the amount which is either write up or down when the payment against the bill is within the tolerance limit. Note: The data appears in this column when the match type is Bill Weighted and the payment amount is within the underpayment or overpayment tolerance limit. This column does not appear when the payment request is in the Draft or Rejected status.
Paid Amount	Displays the amount which is already paid against the entity.

Column Name	Column Description
	Note: This column appears when the payment request is in the Draft or Rejected status.
Unpaid Amount	Displays the amount which is eligible for payment against the entity. Note: This column appears when the payment request is in the Draft or Rejected status.
Payment Amount	Displays the payment amount. If the Show Default check box is not selected against a match type while creating the payment request, the payment amount against the respective match type entities is set to zero. However, if the Show Default check box is selected against a match type while creating the payment request, the payment amount appears against the respective match type entities. The tender amount is divided among the entities in the sequence of match types (where Show Default check box is selected) followed by the sequence of bill, bill segment, or contract start date. You can edit the payment amount, if required.
Payment Currency	Indicates the currency in which the payment was made.
Payment ID	Displays the payment ID. Note: It has a link. On clicking the link, the Payment screen appears with the details of the respective payment. This column does not appear when the payment request is in the Draft or Rejected status.
Payment Status	Indicates the status of the payment. The valid values are: <ul style="list-style-type: none"> • Canceled • Error • Freezable • Frozen • Incomplete Note: This column does not appear when the payment request is in the Draft or Rejected status.
Error Message	Indicates the reason why the payment is in the Error status. Note: This column does not appear when the payment request is in the Draft or Rejected status.
Detail	On clicking the Detail button, the Edit Payment Segment Amount screen appears where you can edit the payment segment amount.

Column Name	Column Description
	<p>Note:</p> <p>This column does not appear when the payment request is in the Draft or Rejected status.</p> <p>The Detail button appears in the Detail column when:</p> <ul style="list-style-type: none"> • The payment request is in the Distributed or Approval In Progress status • The payment is in the Freezable status. <p>However, a user with the approval To Do role will not be able to edit the payment segment amount.</p>
Redistribute	<p>On clicking the Redistribute button, you can redistribute the payment amount among the payment segments.</p> <p>Note:</p> <p>This column appears when the payment request is in the Distributed or Distribute and Freeze status.</p> <p>The Redistribute button appears in the Redistribute column when:</p> <ul style="list-style-type: none"> • The payment request is in the Distributed or Approval In Progress status

You can edit the payment amount by clicking the **Update Payment Amount** link in the upper right corner of this zone.

<p>Note: The Update Payment Amount link appears when the payment creation or transfer request is in the following status:</p> <ul style="list-style-type: none"> • Differed Distribution • Discarded • Distribute And Freeze • Draft • Rejected
--

Related Topics

For more information on...	See...
How to edit the payment amount against each entity	Editing the Payment Amount on page 1495

Payment Request - Log

The **Log** tab contains the following zone:

- [Payment Request Log](#) on page 1486

Payment Request Log

The **Payment Request Log** zone lists the complete trail of actions performed on the payment request. It contains the following columns:

Column Name	Column Description
Creation Date Time	Displays the date and time when the action was performed on the payment request.

Column Name	Column Description
Details	Displays the details about the action performed on the payment request.
User	Indicates the user who has performed the action on the payment request.
Log Type	Indicates the type of log.
Related Object	Indicates the object or entity which is created when the action is performed on the payment request.
	Note: At present, no data appears in this column. The implementation team can build the custom logic to meet the business requirements.
Status Reason	Indicates the reason why the status of the payment request is changed.
	Note: At present, no data appears in this column. The implementation team can build the custom logic to meet the business requirements.

Note: You can manually add a log entry for the payment request by clicking the **Add Log Entry** link in the upper right corner of the **Payment Request Log** zone.

Related Topics

For more information on...	See...
How to view the log of a payment request	Viewing the Log of a Payment Creation or Transfer Request on page 1512
How to add a log entry for a payment request	Adding a Log Entry for a Payment Creation or Transfer Request on page 1513

Creating a Payment Creation Request

Prerequisites

To create a payment creation request, you should have:

- Payment request types defined in the application (where the **Transfer** check box is not selected)

Procedure

To create a payment creation request:

1. Click the **Menu** link in the **Application** toolbar.
A list appears.
2. From the **Main** menu, select **Payments** and then click **Payment Request**.
A sub-menu appears.
3. Click the **Add** option from the **Payment Request** sub-menu.

The **Select Payment Request Type** screen appears. It contains the following fields:

Field Name	Field Description	Mandatory (Yes or No)
Payment Request Type	Used to indicate the payment request type using which you want to create the payment creation request.	Yes

Field Name	Field Description	Mandatory (Yes or No)
	Note: The list includes only those payment request types where the Transfer check box is not selected.	

Tip: Alternatively, you can access the **Select Payment Request Type** screen by clicking the **Add** button in the **Page Title** area of the **Payment Request** screen.

4. Select the required payment request type from the respective field.
5. Click **OK**.

The **Payment Request** screen appears. It contains the following sections:

- **Main** - Used to specify basic details about the payment creation request. This section contains the following fields:

Field Name	Field Description	Mandatory (Yes or No)
Payment Request Type	Indicates the payment request type using which you want to create the payment request.	Not applicable
Payor Account Information	Used to indicate the payor account for which you want to create the payment request. Note: The Search (🔍) icon appears corresponding to this field. On clicking the Search icon, the Account Search window appears. On specifying the account ID, the information about the account appears corresponding to the Payor Account Information field.	Yes
Payment Date	Used to specify the date when the payment was made. Note: By default, the current date appears in this field.	Yes

- **Tender Details** - Used to specify the tender details in the payment creation request. This section contains the following fields:

Field Name	Field Description	Mandatory (Yes or No)
Tender Type	Used to indicate the type of tender through which the payment is made.	Yes
Tender Amount	Used to specify the tender amount.	Yes

Field Name	Field Description	Mandatory (Yes or No)
	<p>Note:</p> <p>By default, this field is disabled. It is enabled when you specify the payor account information.</p> <p>You must not specify the value less than or equal to 0.</p> <p>The precision specified for the tender amount must not exceed the decimal places defined for the currency in the system.</p>	
Currency	<p>Used to indicate the currency in which the payment is made.</p> <p>Note: By default, this field is disabled. It is enabled when you specify the payor account information.</p>	Yes
Check Number	Used to specify the check number if the payment is made through check.	No
Auto Pay Route Type Code	<p>Used to indicate when and how automatic payment request of the account is routed to a financial institution.</p> <p>Note:</p> <p>This field appears only when you select a tender type where the Generate Auto Pay check box is selected.</p> <p>The Search (🔍) icon appears corresponding to this field. On clicking the Search icon, the Auto Pay Route Type Search window appears.</p> <p>On specifying the auto pay route type, the description of the auto pay route type appears corresponding to the Auto Pay Route Type Code field.</p>	<p>Yes (Conditional)</p> <p>Note: This field appears only when you select a tender type where the Generate Auto Pay check box is selected.</p>
Schedule Extract Date	<p>Displays the date when the automatic payment request is scheduled to be sent to a financial institution.</p> <p>Note:</p> <p>The data appears only when you:</p> <ul style="list-style-type: none"> Select a tender type where the Generate Auto Pay check box is selected. Specify the values for Auto Pay Route Type Code and Auto Pay Source Code fields. 	Not applicable
Auto Pay Source Code	Used to indicate the financial institution that receives the automatic payment request.	Yes (Conditional)

Field Name	Field Description	Mandatory (Yes or No)
	<p>Note: This field appears only when you select a tender type where the Generate Auto Pay check box is selected.</p> <p>The Search (🔍) icon appears corresponding to this field. On clicking the Search icon, the Auto Pay Source Search window appears.</p> <p>On specifying the auto pay source code, the description of the auto pay source code appears corresponding to the Auto Pay Source Code field.</p>	<p>Note: This field appears only when you select a tender type where the Generate Auto Pay check box is selected.</p>
Distribution and Freeze Date	<p>Displays the date when the automatic payment must be distributed and frozen in the system.</p> <p>Note: The data appears only when you:</p> <ul style="list-style-type: none"> • Select a tender type where the Generate Auto Pay check box is selected. • Specify the values for Auto Pay Route Type Code and Auto Pay Source Code fields. 	Not applicable
Account Number	<p>Used to indicate the bank account number through which the automatic payment is made.</p> <p>Note: This field appears only when you select a tender type where the Generate Auto Pay check box is selected.</p>	<p>Yes (Conditional)</p> <p>Note: This field appears only when you select a tender type where the Generate Auto Pay check box is selected.</p>
Expires On	<p>Used to specify the date till when the tender is effective.</p> <p>Note: This field appears only when you select a tender type where the Generate Auto Pay check box is selected.</p>	No
Name	<p>Used to specify the name of the person as maintained in the financial institution's system.</p> <p>Note: This field appears only when you select a tender type where the Generate Auto Pay check box is selected. By default, the payor name appears in this field.</p>	No
MICR ID	Used to specify the MICR code on the payment.	No
Ext. Reference ID	Used to specify the external reference number of the payment on the payment upload interface record.	No

Field Name	Field Description	Mandatory (Yes or No)
Person ID	Used to specify the person's account ID mentioned in the payment upload interface record.	No
Name	Used to specify the name of the person as it appears in the payment upload interface record.	No
Tender Control ID	Used to indicate the tender control ID. Note: The Search (🔍) icon appears corresponding to this field. On clicking the Search icon, the Tender Control Search window appears. On specifying the tender control ID, the description of the tender control ID appears corresponding to the Tender Control ID field.	No
Deposit Control Information	Used to indicate the deposit control ID. Note: It is a read-only field. The data appears in this field when the tender control ID is specified.	No

Note: If the auto pay instructions are defined for the payor account, by default, the auto pay data appears in the **Auto Pay Route Type Code**, **Auto Pay Source Code**, **Account Number**, **Expires On**, and **Name** fields.

- **Characteristics** - Used to define the characteristics for the payment tender. This section contains the following fields:

Field Name	Field Description	Mandatory (Yes or No)
Characteristic Type	Used to indicate the characteristic type.	Yes (Conditional)
	Note: The list includes only those characteristic types where the characteristic entity is set to Payment Tender .	Note: This field is required when you are defining a characteristic for the payment tender.
Characteristic Value	Used to specify the value for the characteristic type.	Yes (Conditional)
		Note: This field is required when you are defining a characteristic for the payment tender.

Field Name	Field Description	Mandatory (Yes or No)
	<p>Note:</p> <p>If you select a predefined characteristic type, the Search (🔍) icon appears corresponding to this field. On clicking the Search icon, the Business Object Search window appears.</p> <p>On specifying the business object, the description of the business object appears corresponding to the Characteristic Value field.</p>	

- **Match Types** - Used to define match types for the payment creation request. This section contains the following fields:

Field Name	Field Description	Mandatory (Yes or No)
Match Type	Used to indicate the match type using which you want to match the payment.	Yes
Show Default	<p>Used to indicate whether the default payment amount should be displayed against the match type entities.</p> <p>Note: By default, the Show Default check box is selected when you select the match type.</p>	No
Entity	<p>Indicates the match type entity. The valid values are:</p> <ul style="list-style-type: none"> • Account - Enables you to select the account whose unpaid bills, unpaid bill segments, settlement IDs, or contracts must be considered while matching the payment. • Bill - Enables you to select the unpaid bill against which you want to match the payment. • Statement - Enables you to select the statement against which you want to match the payment. 	Not applicable
Entity ID	<p>Used to specify the account, bill ID, or statement ID depending on the match type entity.</p> <p>Note:</p> <p>The Search (🔍) icon appears corresponding to this field. On clicking the Search icon, based on the selected match type, the relevant entity Search window appears.</p> <p>On specifying the entity, the description of the entity appears corresponding to the Entity ID field.</p>	Yes

6. Enter the required details.

Note:

You can search for a payor account, auto pay route type, auto pay source, and entity by clicking the **Search** (🔍) icon corresponding to the respective field.

If you want to specify more than one match type within the payment request, click the **Add** (+) icon in the **Match Types** section and then specify the details. However, if you want to remove a match type from the payment request, click the **Delete** (🗑️) icon corresponding to the match type.

7. Define characteristics for the payment tender, if required.
8. Click **Manual Distribution**.

The payment request is created and the status of the payment request is set to **Draft**. The **Payment Request** screen appears. Depending on the match type and match entity specified while creating the payment request, the following entities are listed in the **Payment Distribution** zone:

Match Type	Match Entity	Entities
By Bill Regular	Account	Unpaid bills of the account
By Bill Weighted	Account	Unpaid bills of the account
By Bill	Bill	Unpaid bill
By Bill Segments	Account	Unpaid bill segments
By Suspense Contract	Account	Contracts of the account Note: Only contracts of the contract type where the Eligible for Billing flag is set to No and Special Role flag is set to Suspense are listed in the Payment Distribution zone. If no contracts with this specification exist for the account, the system checks whether there is any such contract type (where the Eligible for Billing flag is set to No and Special Role flag is set to Suspense) defined for the division to which the account belongs. If there is any such contract type defined for the division, the system creates the contract for the account using the respective contract type and the same is listed in Payment Distribution zone.
By Settlement	Account	Unpaid bill segments where the settlement account is stamped
By Statement	Statement	Unpaid bills of the statement

If the **Show Default** check box is not selected against a match type while creating the payment request, the payment amount against the respective match type entities is set to zero. However, if the **Show Default** check box is selected against a match type, the payment amount appears against the respective match type entities. The tender amount is divided among the entities in the sequence of match types (where **Show Default** check box is selected) followed by the sequence of bill, bill segment, or contract start date. You can then edit the payment amount, if required.

Note:

If a payment request is already created for a payee account and is currently in progress, the system will not allow you to create another payment request for the payee account until the previous payment request is in the **Processed** or **Rejected** status.

The system does not allow you to create a payment request for a payee account when the respective match type entities (such as unpaid bills, unpaid bill segments, contracts, or settlement IDs do not exists for the payee account.

Related Topics

For more information on...	See...
Search Payment Request zone	Search Payment Request on page 1473
How to define a characteristic for a payment tender	Defining a Characteristic for a Payment Tender on page 1494
Payment Request screen	Payment Request (Used for Viewing) on page 1477
Payment Details screen	Payment Details on page 1483
Payment Distribution zone	Payment Distribution on page 1484

Defining a Characteristic for a Payment Tender**Prerequisites**

To define a characteristic for a payment tender, you should have:

- Characteristic types defined in the application (where the characteristic entity is set to **Payment Tender**)

Procedure

To define a characteristic for a payment tender:

1. Ensure that the **Characteristics** section is expanded when you are defining or editing a payment request.

The **Characteristics** section contains the following fields:

Field Name	Field Description	Mandatory (Yes or No)
Characteristic Type	Used to indicate the characteristic type.	Yes (Conditional)
	Note: The list includes only those characteristic types where the characteristic entity is set to Payment Tender .	Note: This field is required when you are defining a characteristic for the payment tender.
Characteristic Value	Used to specify the value for the characteristic type.	Yes (Conditional)
	Note: On specifying the value for a predefined characteristic type, the description of the characteristic value appears corresponding to the Characteristic Value field.	Note: This field is required when you are defining a characteristic for the payment tender.

2. Enter the required details.

Note: If you select a predefined characteristic type, the **Search** (🔍) icon appears corresponding to the **Characteristic Value** field. On clicking the **Search** icon, you can search for a predefined characteristic value.

- If you want to define more than one characteristic for the payment tender, click the **Add** (+) icon and then repeat step 2.

Note: However, if you want to remove a characteristic from the payment tender, click the **Delete** (🗑️) icon corresponding to the characteristic.

Related Topics

For more information on...	See...
How to create a payment creation request	Creating a Payment Creation Request on page 1487
How to edit a payment request	Editing a Payment Creation Request on page 1497

Editing the Payment Amount

Procedure

To edit the payment amount against each entity:

- Search for the payment creation or transfer request in the **Payment Request** screen.
- In the **Search Results** section, click the link in the **Payment Request Information** column corresponding to the payment creation or transfer request whose details you want to edit.

The **Payment Request** screen appears.

- Ensure that the **Main** tab is selected.
- Click the **Update Payment Amount** link in the upper right corner of the **Payment Distribution** zone.

The **Payment Request - Edit Payment Amount** screen appears. It contains the following sections:

- Search Criteria** - The **Search Criteria** section contains the following fields:

Field Name	Field Description
Match Type	Used to search the entities which are considered using a particular match type. Note: By default, the All option is selected.
Sort By	Used to indicate the entity based on which the search result is sorted. Note: By default, the All option is selected.
Sort By	Used to indicate the entity fields based on which the search result is sorted. Note: By default, the All option is selected. The data in this field appears when the match type is selected.
Match Value	Used to search for a particular entity (such as bill, bill segment, contract, or settlement ID).
Order	Used to indicate the sequence for the search result. The valid values are:

Field Name	Field Description
	<ul style="list-style-type: none"> Ascending Descending

- **Search Results** - On clicking the **Search** button, the search results are filtered based on the specified search criteria. The **Search Results** section contains the following columns:

Column Name	Column Description
Match Type	Indicates the match type using which the entity is considered.
Payee Information	Displays information about the account for which the payment was made.
Entity Information	Displays information about the entity against which the payment was matched.
Original Bill Amount	Displays the entity amount.
	Note: In case of contract, the entity amount would be zero (0).
Paid Amount	Displays the amount which is already paid against the entity.
Unpaid Amount	Displays the amount which is eligible for payment against the entity.
Payment Amount	Used to specify the payment amount.
	Note: If the Allow Overpayment option type of the C1-PAYPORTAL feature configuration is set to true , you can specify the payment amount greater than the unpaid amount. In other words, you can make overpayment against an entity.
Payment Currency	Indicates the currency in which the payment is made.

In addition, the **Search Results** section contains the following fields:

Field Name	Field Description
Total Amount	Displays the tender or transfer amount.
Running Total	Displays the total payment amount which is specified against each entity.
Running Balance	Displays the difference between the total amount and running total.
	Note: The running balance is highlighted in the red color when the difference amount is non-zero.

Note: Pagination is used to display limited number of records in the **Edit Payment Amount** screen. You can change the number of records displayed per page, if required. You can use the navigation buttons, such as **First** (<<), **Previous** (), **Next** (), and **Last** () to navigate between pages. You can also select the page to which you want to navigate from the **Go To** list.

5. Modify the payment amount against an entity, if required.

Note: The sum of payment amount should be equal to the tender or transfer (payment) amount.

6. Click **Save**.

The changes made in the payment amount are saved.

7. Click **Close**.

The payment amount is updated in the **Payment Distribution** zone.

Related Topics

For more information on...	See...
How to search for a payment request	Searching for a Payment Request on page 1476
Payment Request screen	Payment Request (Used for Viewing) on page 1477
Payment Distribution zone	Payment Distribution on page 1484

Editing a Payment Creation Request

Procedure

To edit a payment creation request:

1. Search for the payment creation request in the **Payment Request** screen.
2. In the **Search Results** section, click the link in the **Payment Request Information** column corresponding to the payment creation request whose details you want to edit.

The **Payment Request** screen appears.

3. Click the **Edit** button in the **Payment Request** zone.

The **Payment Request** screen appears. It contains the following sections:

- **Main** - Used to specify basic details about the payment creation request. This section contains the following fields:

Field Name	Field Description	Mandatory (Yes or No)
Payment Request Information	Displays information about the payment creation request.	Not applicable
Payment Request Type	Indicates the payment request type using which the payment creation request is created.	Not applicable
Payor Account Information	Used to indicate the payor account for which you want to create the payment creation request. Note: The Search (🔍) icon appears corresponding to this field. On clicking the Search icon, the Account Search screen appears. On specifying the payor account, the description of the payor account appears corresponding to the Payor Account Information field.	Yes
Payment Date	Used to specify the date when the payment is made.	Yes

- **Tender Details** - Used to specify the tender details in the payment creation request. This section contains the following fields:

Field Name	Field Description	Mandatory (Yes or No)
Tender Type	Used to indicate the type of tender through which the payment is made.	Yes
Tender Amount	Used to specify the tender amount. Note: You must not specify the value less than or equal to 0. The precision specified for the tender amount must not exceed the decimal places defined for the currency in the system.	Yes
Currency	Used to indicate the currency in which the payment is made.	Yes
Check Number	Used to specify the check number if the payment is made through check.	No
Auto Pay Route Type Code	Used to indicate when and how automatic payment request of the account is routed to a financial institution. Note: This field appears only when you select a tender type where the Generate Auto Pay check box is selected. The Search (🔍) icon appears corresponding to this field. On clicking the Search icon, the Auto Pay Route Type Search window appears. On specifying the auto pay route type, the description of the auto pay route type appears corresponding to the Auto Pay Route Type Code field.	Yes (Conditional) Note: This field appears only when you select a tender type where the Generate Auto Pay check box is selected.
Schedule Extract Date	Displays the date when the automatic payment request is scheduled to be sent to a financial institution. Note: The data appears only when you: <ul style="list-style-type: none"> Select a tender type where the Generate Auto Pay check box is selected. Specify the values for Auto Pay Route Type Code and Auto Pay Source Code fields. 	Not applicable
Auto Pay Source Code	Used to indicate the financial institution that receives the automatic payment request.	Yes (Conditional)

Field Name	Field Description	Mandatory (Yes or No)
	<p>Note: This field appears only when you select a tender type where the Generate Auto Pay check box is selected.</p> <p>The Search (🔍) icon appears corresponding to this field. On clicking the Search icon, the Auto Pay Source Search window appears.</p> <p>On specifying the auto pay source code, the description of the auto pay source code appears corresponding to the Auto Pay Source Code field.</p>	<p>Note: This field appears only when you select a tender type where the Generate Auto Pay check box is selected.</p>
Distribution and Freeze Date	<p>Displays the date when the automatic payment must be distributed and frozen in the system.</p> <p>Note: The data appears only when you:</p> <ul style="list-style-type: none"> • Select a tender type where the Generate Auto Pay checkbox is selected in the Tender Type screen. • Specify the values for Auto Pay Route Type Code and Auto Pay Source Code fields. 	Not applicable
Account Number	<p>Used to indicate the bank account number through which the automatic payment is made.</p> <p>Note: This field appears only when you select a tender type where the Generate Auto Pay check box is selected.</p>	<p>Yes (Conditional)</p> <p>Note: This field appears only when you select a tender type where the Generate Auto Pay check box is selected.</p>
Expires On	<p>Used to specify the date till when the tender is effective.</p> <p>Note: This field appears only when you select a tender type where the Generate Auto Pay check box is selected.</p>	No
Name	<p>Used to specify the name of the person as it appears in the financial institution's system.</p> <p>Note: This field appears only when you select a tender type where the Generate Auto Pay check box is selected.</p>	No
MICR ID	Used to specify the MICR code on the payment.	No
Ext. Reference ID	Used to specify the external reference number of the payment on the payment upload interface record.	No
Person ID	Used to specify the person's account ID mentioned in the payment upload interface record.	No

Field Name	Field Description	Mandatory (Yes or No)
Name	Used to specify the name of the person as it appears in the payment upload interface record.	No
Tender Control ID	Used to indicate the payment tender ID. Note: The Search (🔍) icon appears corresponding to this field. On clicking the Search icon, the Tender Control Search window appears. On specifying the tender control ID, the description of the tender control ID appears corresponding to the Tender Control ID field.	No
Deposit Control Information	Used to indicate the deposit control ID. Note: It is a read-only field. The data appears in this field when the tender control ID is specified.	No

Note: If the auto pay instructions are defined for the payor account, by default, the auto pay data appears in the **Auto Pay Route Type Code**, **Auto Pay Source Code**, **Account Number**, **Expires On**, and **Name** fields.

- **Characteristics** - Used to edit the characteristics for the payment tender. This section contains the following fields:

Field Name	Field Description	Mandatory (Yes or No)
Characteristic Type	Used to indicate the characteristic type.	Yes (Conditional)
	Note: The list includes only those characteristic types where the characteristic entity is set to Payment Tender .	Note: This field is required when you are defining a characteristic for the payment tender.
Characteristic Value	Used to specify the value for the characteristic type.	Yes (Conditional)
	Note: If you select a predefined characteristic type, the Search (🔍) icon appears corresponding to this field. On clicking the Search icon, the Business Object Search window appears. On specifying the business object, the description of the business object appears corresponding to the Characteristic Value field.	Note: This field is required when you are defining a characteristic for the payment tender.

- **Match Types** - Used to edit match types for the payment creation request. This section contains the following fields:



Field Name	Field Description	Mandatory (Yes or No)
Match Type	Used to indicate the match type using which you want to match the payment.	Yes
Show Default	Used to indicate whether the default payment amount should be displayed against the match type entities.	No
	Note: By default, the Show Default check box is selected when you select the match type.	
Entity	<p>Indicates the match type entity. The valid values are:</p> <ul style="list-style-type: none"> • Account - Enables you to select the account whose unpaid bills, unpaid bill segments, settlement IDs, or contracts must be considered while matching the payment. • Bill - Enables you to select the unpaid bill against which you want to match the payment. • Statement - Enables you to select the statement against which you want to match the payment. 	Not applicable
Entity ID	Used to specify the account or bill ID depending on the match type entity.	Yes
	<p>Note:</p> <p>This field appears as read-only while you are viewing the match types which are added for the payment creation request.</p> <p>If you want to edit the entity ID, you need to first remove the row and then add it again with the updated information.</p> <p>In that case, the Search (🔍) icon appears corresponding to this field. On clicking the Search icon, based on the selected match type, the relevant entity Search window appears. On specifying the entity, the description of the entity appears corresponding to the Entity ID field.</p>	

Note: The **Edit** button appears when the payment creation request is in the **Draft** status.

4. Modify the details of the payment creation request, if required.

Note:

You can search for a payor account, auto pay route type, auto pay source, and entity by clicking the **Search**  icon corresponding to the respective field.

If you want to specify more than one match type within the payment request, click the **Add**  icon in the **Match Types** section and then specify the details. However, if you want to remove a match type from the payment request, click the **Delete**  icon corresponding to the match type.

You cannot edit an existing row in the **Match Types** section. If you want to edit the details of an existing row, you need to first remove the row and then add it again with the updated information.

5. Define, edit, or remove characteristics of the payment request, if required.

6. Click **Manual Distribution**.

The changes made to the payment request are saved. Depending on the information specified in the **Match Types** section, the entities are listed in the **Payment Distribution** zone. You can edit the payment amount against each entity, if required.

Related Topics

For more information on...	See...
How to search for a payment request	Searching for a Payment Request on page 1476
Payment Request screen	Payment Request (Used for Viewing) on page 1477
Payment Request zone	Payment Request on page 1478
Payment Details zone	Payment Details on page 1483
Payment Distribution zone	Payment Distribution on page 1484
How to define a characteristic for a payment tender	Defining a Characteristic for a Payment Tender on page 1494

Deleting a Payment Creation or Transfer Request**Procedure**

To delete a payment creation or transfer request:

1. Search for the payment creation or transfer request in the **Payment Request** screen.
2. In the **Search Results** section, click the link in the **Payment Request Information** column corresponding to the payment creation or transfer request that you want to delete.

The **Payment Request** screen appears.

3. Click the **Delete** button in the **Payment Request** zone.

A message appears confirming whether you want to delete the payment creation or transfer request.

Note: The **Delete** button appears when the payment creation or transfer request is in the **Draft** status.

4. Click **OK**.

The payment creation or transfer request is deleted.

Related Topics

For more information on...	See...
How to search for a payment request	Searching for a Payment Request on page 1476
Payment Request screen	Payment Request (Used for Viewing) on page 1477
Payment Request zone	Payment Request on page 1478

Distributing the Tender or Payment Amount

Procedure

To distribute the tender or payment amount:

1. Search for the payment request in the **Payment Request** screen.
2. In the **Search Results** section, click the link in the **Payment Request Information** column corresponding to the payment request whose tender or payment amount you want to distribute.

The **Payment Request** screen appears.

3. Click the **Distribute** button in the **Payment Request** zone.

The Defer algorithm attached to the payment request type using which you have created the payment request is triggered. This algorithm checks whether the number of payment distribution records in the payment request exceeds the payment count defined in the Defer algorithm. If the number of payment distribution records in the payment request does not exceed the payment count, the system distributes the tender or payment amount in real time (i.e. immediately). However, if the number of payment distribution records in the payment request exceeds the payment count, the system distributes the tender or payment amount in the deferred mode.

Note:

Number of payment distribution records = (Number of bill segments present in each bill fetched using the Bill Weighted, Bill Regular, and Bill match type algorithm) + (Number of bill segments fetched using the Bill Segment match type algorithm) + (Number of contracts fetched using the Suspense Contract match type algorithm) + (Number of settlements fetched using the Settlement match type algorithm)

Deferred mode means in the background when the **Payment Request Periodic Monitor (C1-PAYRQ)** batch is invoked. You can configure the **Payment Request Periodic Monitor (C1-PAYRQ)** batch such that it is executed at regular intervals. When the **Payment Request Periodic Monitor (C1-PAYRQ)** batch is invoked, the system checks whether there are any payment requests in the **Deferred Distribution** status. If there is a payment request in the **Deferred Distribution** status, the system distributes the tender or payment amount.

On distributing the tender amount, the payment event, payments, payment segments, and payment tenders are created. The payments are created in the **Freezable** status. If any error occurs while creating the payment, the payment is created in the **Error** status. If all payments of a payment event are in the **Freezable** status, the status of the payment event is set to **Balanced**. However, if any payment of a payment event is in the **Error** status, the status of the payment event is set to **Unbalanced**. On distributing the payment amount (during transfer), the new payments are created in the **Freezable** status. If any error occurs while creating the new payment, the payment is created in the **Error** status. The status of the payment event is set to **Unbalanced**. The old payments in the payment event that you want to transfer remains in the **Frozen** or **Error** status.

Once the tender or payment amount is successfully distributed, the status of the payment request is changed to **Distributed**.

Note:

The **Distribute** button appears when the payment request is in the **Draft** status.

The sum of payment amount should be equal to the tender or transfer (payment) amount. Otherwise, the system will not allow you to distribute the tender or payment amount.

Related Topics

For more information on...	See...
How to search for a payment request	Searching for a Payment Request on page 1476
Payment Request screen	Payment Request (Used for Viewing) on page 1477
Payment Request zone	Payment Request on page 1478
How to edit the payment amount against each entity	Editing the Payment Amount on page 1495

Distributing and Freezing the Tender or Payment Amount**Procedure**

To distribute and freeze the tender or payment amount:

1. Search for the payment request in the **Payment Request** screen.
2. In the **Search Results** section, click the link in the **Payment Request Information** column corresponding to the payment request whose tender or payment amount you want to distribute and freeze.

The **Payment Request** screen appears.

3. Click the **Distribute And Freeze** button in the **Payment Request** zone.

The Defer algorithm attached to the payment request type using which you have created the payment request is triggered. This algorithm checks whether the number of payment distribution records in the payment request exceeds the payment count defined in the Defer algorithm. If the number of payment distribution records in the payment request does not exceed the payment count, the system distributes and freezes the tender or payment amount in real time (i.e. immediately). However, if the number of payment distribution records in the payment request exceeds the payment count, the system distributes and freezes the tender or payment amount in the deferred mode.

Note:

Number of payment distribution records = (Number of bill segments present in each bill fetched using the Bill Weighted, Bill Regular, and Bill match type algorithm) + (Number of bill segments fetched using the Bill Segment match type algorithm) + (Number of contracts fetched using the Suspense Contract match type algorithm) + (Number of settlements fetched using the Settlement match type algorithm)

Deferred mode means in the background when the **Payment Request Periodic Monitor (C1-PAYRQ)** batch is invoked. You can configure the **Payment Request Periodic Monitor (C1-PAYRQ)** batch such that it is executed at regular intervals. When the **Payment Request Periodic Monitor (C1-PAYRQ)** batch is invoked, the system checks whether there are any payment requests in the **Deferred Distribution** status. If there is a payment request in the **Deferred Distribution** status, the system distributes the tender or payment amount.

On distributing and freezing the tender amount, the payment event, payments, payment segments, and payment tenders are created. The payments are created in the **Frozen** status. If any error occurs while creating the payment, the payment is created in the **Error** status. If all payments of a payment event are in the **Frozen** status, the status of the payment event is set to **Balanced**. However, if any payment of a payment event is in the **Error** status,

the status of the payment event is set to **Unbalanced**. On distributing the payment amount (during transfer), the new payments are created in the **Frozen** status. If any error occurs while creating the new payment, the payment is created in the **Error** status. The status of the payment event is set to **Unbalanced**. The old payments in the payment event that you want to transfer remains in the **Frozen** or **Error** status.

Once the tender or payment amount is successfully distributed and frozen, the status of the payment request is changed to **Processed**.

Note:

The **Distribute And Freeze** button appears when the payment request is in the **Draft** status.

The sum of payment amount should be equal to the tender or transfer (payment) amount. Otherwise, the system will not allow you to distribute the tender or payment amount.

Related Topics

For more information on...	See...
How to search for a payment request	Searching for a Payment Request on page 1476
Payment Request screen	Payment Request (Used for Viewing) on page 1477
Payment Request zone	Payment Request on page 1478
How to edit the payment amount against each entity	Editing the Payment Amount on page 1495

Redistributing the Tender or Payment Amount

Procedure

To redistribute the tender or payment amount:

1. Search for the payment request in the **Payment Request** screen.
2. In the **Search Results** section, click the link in the **Payment Request Information** column corresponding to the payment request whose tender or payment amount you want to redistribute.

The **Payment Request** screen appears.

3. In the **Payment Distribution** zone, click the **Redistribute** button in the **Redistribute** column corresponding to the payment distribution whose tender or payment amount you want to redistribute.

The required payment gets redistributed among the account's contracts.

Note: The **Redistribute** button appears when the payment status is in **Incomplete**, **Error**, or **Freezable** status.

Related Topics

For more information on...	See...
How to search for a payment request	Searching for a Payment Request on page 1476
Payment Request screen	Payment Request (Used for Viewing) on page 1477
Payment Request zone	Payment Request on page 1478
How to edit the payment amount against each entity	Editing the Payment Amount on page 1495

Editing the Payment Segment Amount

Before you freeze the payments, the system allows you to edit the pay segment amount of the payments which are in the **Freezable** status. You can edit the amount when there are multiple pay segments in a payment.

Procedure

To edit the payment segment amount:

1. Search for the payment request in the **Payment Request** screen.
2. In the **Search Results** section, click the link in the **Payment Request Information** column corresponding to the payment request whose details you want to edit.

The **Payment Request** screen appears.

3. Click the **Detail** button in the **Payment Distribution** zone.

The **Edit Payment Segment Amount** screen appears. It contains the following fields:

Field Name	Field Description
Payment Event Information	Displays information about the payment event which is created through the payment request.
Payment Information	Displays information about the payment which is created through the payment event.
Payee Account Information	Displays information about the account for which the payment is made.
Match Value	Displays information about the entity against which the payment is matched.
Payment Amount	Displays the total payment amount.
Running Total	Displays the sum of payment amount specified against each pay segment.
Running Balance	Displays the difference between total payment amount and running total. The running balance is highlighted in the red color when the difference amount is non-zero.

In addition, this section contains the following columns:

Column Name	Column Description	Mandatory (Yes or No)
Sr No	Indicates the sequence number of the pay segment.	Not applicable
Entity Information	Displays information about the entity (such as bill segment or contract) against which the pay segment is created.	Not applicable
Total Amount	Displays the entity amount. If the pay segment is created against a contract, the system considers all bill segments of the bill which are created against the contract and calculates the total bill segment amount.	Not applicable
Unpaid Amount	Displays the amount which is eligible for payment. If the pay segment is created against a contract, the system considers all bill segments of the bill which are created against the contract and calculates the total unpaid bill segment amount.	Not applicable
Payment Amount	Used to specify the payment amount that you want to distribute against the pay segment.	Yes

Column Name	Column Description	Mandatory (Yes or No)
	<p>Note: This field is non-editable when:</p> <ul style="list-style-type: none"> • There is only one pay segment in a payment. • A user with the approval To Do role is reviewing the pay segment amount. 	
Payment Currency	Indicates the currency in which the payment was made.	Not applicable
Pay Segment ID	Displays the pay segment ID.	Not applicable

Note:

The **Detail** button appears in the **Detail** column when:

- The payment request is in the **Distributed** or **Approval In Progress** status
- The payment is in the **Freezable** status.

Pagination is used to display limited number of records in the **Edit Payment Segment Amount** screen. You can change the number of records displayed per page, if required. You can use the navigation buttons, such as **First** (<<), **Previous** (<), **Next** (>), and **Last** (>>) to navigate between pages. You can also select the page to which you want to navigate from the **Go To** list.

4. Modify the payment amount against a pay segment, if required.

Note: The sum of payment segment amount should be equal to the payment amount.

5. Click **Redistribute**.

The payment amount is redistributed among the pay segments.

Note: The **Redistribute** button is disabled when the **Payment Amount** field is non-editable.

6. Click **Close**.

Related Topics

For more information on...	See...
How to search for a payment request	Searching for a Payment Request on page 1476
Payment Request screen	Payment Request (Used for Viewing) on page 1477
Payment Distribution zone	Payment Distribution on page 1484

Freezing Payments Created Through a Payment Request**Procedure**

To freeze the payments created through a payment request:

1. Search for the payment request in the **Payment Request** screen.
2. In the **Search Results** section, click the link in the **Payment Request Information** column corresponding to the payment request whose payments you want to freeze.

The **Payment Request** screen appears.

3. If required, you can edit the amount of a payment segment before freezing the payments.
4. Click the **Freeze** button in the **Payment Request** zone.

The system behaves in the following manner:

If you are...	Then
Freezing the payments created through a payment creation request	The status of the payments which are in the Freezable status is changed to Frozen . In addition, the status of the payment request is changed to Processed .
Freezing the payments created through a payment transfer request	The status of the old payments which are in the Frozen status is changed to Cancelled . The old payments which are in the Error status are deleted. The status of the new payments which are in the Freezable status is changed to Frozen . The status of the payment event is changed to Balanced when there are no new payments in the Error status. In addition, the status of the payment request is changed to Processed .

Note:

The **Freeze** button appears when:

- The payment request is in the **Distributed** status.
- The **Approval Required** check box is not selected in the payment request type using which the payment request is created.

For each payment, ensure that the sum of payment segment amount is equal to the payment amount. Otherwise, the system will not allow you to freeze the payments created through the payment request.

Related Topics

For more information on...	See...
How to search for a payment request	Searching for a Payment Request on page 1476
Payment Request screen	Payment Request (Used for Viewing) on page 1477
Payment Request zone	Payment Request on page 1478
How to edit the amount of a payment segment	Editing the Payment Segment Amount on page 1506

Submitting a Payment Creation or Transfer Request for Approval

Procedure

To submit a payment creation or transfer request for approval:

1. Search for the payment creation or transfer request in the **Payment Request** screen.
2. In the **Search Results** section, click the link in the **Payment Request Information** column corresponding to the payment creation or transfer request that you want to submit for approval.

The **Payment Request** screen appears.

3. If required, you can edit the amount of a payment segment before submitting the payment creation or transfer request for approval.

4. Click the **Submit for Approval** button in the **Payment Request** zone.

The status of the payment creation or transfer request is changed to **Approval In Progress**. A To Do is created using the **C1-PAYRQ** To Do type. Users having a To Do role to which the **C1-PAYRQ** To Do type is associated can view the To Do from the **To Do List** screen.

Note:

The **Submit for Approval** button appears when:

- The payment creation or transfer request is in the **Distributed** status.
- The **Approval Required** check box is selected in the payment request type using which the payment creation or transfer request is created.

For each payment, ensure that the sum of payment segment amount is equal to the payment amount. Otherwise, the system will not allow you to submit the payment creation or transfer request for approval.

Related Topics

For more information on...	See...
How to search for a payment request	Searching for a Payment Request on page 1476
Payment Request screen	Payment Request (Used for Viewing) on page 1477
Payment Request zone	Payment Request on page 1478
How to edit the amount of a payment segment	Editing the Payment Segment Amount on page 1506

Approving a Payment Creation or Transfer Request

You can view the number of payment creation or transfer requests which are pending for approval in the **Payment Request** screen. The approver can review, and accordingly approve or reject the payment creation or transfer request based on the observations.

Note: The system will not allow you to approve or reject a payment creation or transfer request submitted by you.

Procedure

To approve a payment creation or transfer request:

1. Do either of the following:

If you want to	Then
Approve a payment creation or transfer request through the Payment Request screen	<ol style="list-style-type: none"> 1. Search for the payment creation or transfer request in the Payment Request screen. 2. In the Search Results section, click the link in the Payment Request Information column corresponding to the payment creation or transfer request which you want to review.
Approve a payment creation or transfer request from the To Do List screen	<ol style="list-style-type: none"> 1. Click the Menu link in the Application toolbar. A list appears. 2. From the Main menu, select To Do and then click To Do List.

If you want to	Then
	<p>The To Do Type for User Search window appears.</p> <ol style="list-style-type: none"> Enter C1-PAYRQ in the To Do Type field. Click the Search button corresponding to the To Do Type field. <p>The To Do List screen appears.</p> <ol style="list-style-type: none"> Select the Open option from the Filter by list to view all unassigned To Dos. Click the link in the Message column corresponding to the To Do of the payment creation or transfer request that you want to review.

The **Payment Request** screen appears.

- Review the payment creation or transfer request details.
- Click the **Approve** button in the **Payment Request** zone.

The system behaves in the following manner:

If you are...	Then
Approving a payment creation request	The status of the payments which are in the Freezable status is changed to Frozen . In addition, the status of the payment creation request is changed to Processed .
Approving a payment transfer request	The status of the old payments which are in the Frozen status is changed to Cancelled . The old payments which are in the Error status are deleted. The status of the new payments which are in the Freezable status is changed to Frozen . The status of the payment event is changed to Balanced when there are no new payments in the Error status. In addition, the status of the payment transfer request is changed to Processed .

Note: The **Approve** button appears when:

- The payment creation or transfer request is in the **Approval In Progress** status.
- A user with the approval To Do role is reviewing the payment creation or transfer request.

Related Topics

For more information on...	See...
How to search for a payment request	Searching for a Payment Request on page 1476
Payment Request screen	Payment Request (Used for Viewing) on page 1477
Payment Request zone	Payment Request on page 1478

Rejecting a Payment Creation or Transfer Request

Prerequisites

To reject a payment creation or transfer request, you should have:

- Rejection reasons defined in the application

Note:

While rejecting a payment creation or transfer request, you need to specify the reason why you want to reject the payment creation or transfer request. If you are rejecting a payment creation request, you can select the appropriate rejection reason when you have defined the reasons for the **Rejected** status of the **C1-PaymentRequest** business object in the **Status Reason** screen. However, if you are rejecting a payment transfer request, you can select the appropriate rejection reason when you have defined the reasons for the **Rejected** status of the **C1-PaymentTransferRequest** business object in the **Status Reason** screen.

The system will not allow you to approve or reject a payment creation or transfer request submitted by you.

Procedure

To reject a payment creation or transfer request:

1. Do either of the following:

If you want to...	Then...
Reject a payment creation or transfer request through the Payment Request screen	<ol style="list-style-type: none"> 1. Search for the payment creation or transfer request in the Payment Request screen. 2. In the Search Results section, click the link in the Payment Request Information column corresponding to the payment creation or transfer request which you want to review.
Reject a payment creation or transfer request from the To Do List screen	<ol style="list-style-type: none"> 1. Click the Menu link in the Application toolbar. A list appears. 2. From the Main menu, select To Do and then click To Do List. The To Do Type for User Search window appears. 3. Enter C1-PAYRQ in the To Do Type field. 4. Click the Search button corresponding to the To Do Type field. The To Do List screen appears. 5. Select the Open option from the Filter by list to view all unassigned To Dos. 6. Click the link in the Message column corresponding to the To Do of the payment creation or transfer request that you want to review.

The **Payment Request** screen appears.

2. Review the payment creation or transfer request details.
3. If required, you can review the payment segment amount of each payment by clicking the **Detail** button in the **Detail** column corresponding to the payment in the **Payment Distribution** zone.
4. Click the **Reject** button in the **Payment Request** zone.

The **Status Reason** window appears. It contains following fields:

Field Name	Field Description	Mandatory (Yes or No)
Status Reason	Used to indicate the reason why you want to reject the payment creation or transfer request.	Yes

Note: The **Reject** button appears when:

- The payment creation or transfer request is in the **Approval In Progress** status.
- A user with the approval To Do role is reviewing the payment creation or transfer request.

5. Select the rejection reason from the **Status Reason** list.
6. Click **Save**.

If the approver rejects a payment creation request, the payment event, payments, payment segments, and payment tender which are created through the payment creation request are deleted. However, if the approver rejects a payment transfer request, the new payments which are created through the payment transfer request are deleted. In addition, the status of the payment creation or transfer request is changed to **Rejected**.

Related Topics

For more information on...	See...
How to search for a payment request	Searching for a Payment Request on page 1476
Payment Request screen	Payment Request (Used for Viewing) on page 1477
Payment Request zone	Payment Request on page 1478

Discarding a Payment Creation or Transfer Request

1. Search for the payment creation or transfer request in the **Payment Request** screen.
2. In the **Search Results** section, click the link in the **Payment Request Information** column corresponding to the payment creation or transfer request which you want to discard.
3. Click the **Discard** button in the **Payment Request** zone.

Note:

The **Discard** button appears only when the payment creation or transfer request is in **Distributed** status.

If the approver discards a payment creation request, the payment event, payments, payment segments, and payment tender which are created through the payment creation request are deleted. However, if the approver discards a payment transfer request, the new payments which are created through the payment transfer request are deleted. In addition, the status of the payment creation or transfer request is changed to **Discarded**.

Discarding a payment creation or transfer request is similar to rejecting a payment creation or transfer request. However, you can only reject a payment creation or transfer request, when the approval workflow is on while creating a payment creation or transfer request but discarding a payment creation or transfer request can be done in both the cases, when the approval workflow is on or off.

Related Topics

For more information on...	See...
How to search for a payment request	Searching for a Payment Request on page 1476
Payment Request screen	Payment Request (Used for Viewing) on page 1477
Payment Request zone	Payment Request on page 1478

Viewing the Log of a Payment Creation or Transfer Request

Procedure

To view the log of a payment creation or transfer request:

1. Search for the payment creation or transfer request in the **Payment Request** screen.
2. In the **Search Results** section, click the link in the **Payment Request Information** column corresponding to the payment creation or transfer request whose log you want to view.

The **Payment Request** screen appears. It consists of the following tabs:

- **Main** – This tab contains the following two zones:
 - **Payment Request** – Displays the details of the payment creation or transfer request.
 - **Payment Distribution** – Lists the payment distribution records of the payment creation or transfer request.
 - **Log** – This tab lists the complete trail of actions performed on the payment creation or transfer request.
3. Click the **Log** tab.

The **Payment Request Log** zone in the **Log** tab contains the following columns:

Column Name	Column Description
Date/Time	Displays the date and time when the action was performed on the payment creation or transfer request.
Details	Displays the details about the action performed on the payment creation or transfer request.
User	Indicates the user who has performed the action on the payment creation or transfer request.
Log Type	Indicates the type of log.
Related Object	Indicates the object or entity which is generated when the action is performed on the payment creation or transfer request.
Status Reason	Indicates the reason why the payment creation or transfer request was rejected.

Note: You can manually add a log entry for the payment creation or transfer request by clicking the **Add Log Entry** link in the upper right corner of the **Payment Request Log** zone.

Related Topics

For more information on...	See...
How to search for a payment request	Searching for a Payment Request on page 1476
How to add a log entry for a payment request	Adding a Log Entry for a Payment Creation or Transfer Request on page 1513

Adding a Log Entry for a Payment Creation or Transfer Request

Procedure

To add a log entry for a payment creation or transfer request:

1. Search for the payment creation or transfer request in the **Payment Request** screen.
2. In the **Search Results** section, click the link in the **Payment Request Information** column corresponding to the payment creation or transfer request whose log you want to edit.

The **Payment Request** screen appears. It consists of the following tabs:

- **Main** – This tab contains the following two zones:

- **Payment Request** – Displays the details of the payment creation or transfer request.
 - **Payment Distribution** – Lists the payment distribution records of the payment creation or transfer request.
 - **Log** – This tab lists the complete trail of actions performed on the payment creation or transfer request.
3. Click the **Log** tab.
- The **Log** tab appears.

4. Click the **Add Log Entry** link in the upper right corner of the **Payment Request Log** zone.

The **Add Payment Request Log** window appears. It contains the following fields:

Field Name	Field Description	Mandatory (Yes or No)
Payment Request Information	Displays information about the payment creation or transfer request.	Not applicable
Log Details	Used to specify additional comments for the payment creation or transfer request.	Yes

5. Enter the comments in the **Log Details** field.
6. Click **Save**.

The log entry is added in the **Payment Request Log** zone.

Related Topics

For more information on...	See...
How to search for a payment request	Searching for a Payment Request on page 1476

Payment Event Summary

The **Payment Event Summary** screen allows you to search for a payment event using various search criteria. Through this screen, you can:

- View the payments created through a payment event
- View payment segments of a payment
- Transfer one or more payments of a payment event to another payee account
- Cancel a payment event
- Delete a payment event
- Cancel a payment of a payment event
- Delete a payment of a payment event
- Refund a payment which is matched against the suspense or excess credit contract

This screen consists of following zones:

- [Search Payment Event](#) on page 1514
- [Payments](#) on page 1517
- [Payment Segments](#) on page 1519

Search Payment Event

The **Search Payment Event** zone allows you to search for a payment event using various search criteria. This zone contains the following two sections:

- **Search Criteria** — The **Search Criteria** section contains the following fields:

Field Name	Field Description	Mandatory (Yes or No)
Search By	<p>Used to indicate whether you want to search for a payment event using the payor, payment event, tender, or contract details. The valid values are:</p> <ul style="list-style-type: none"> • Payor Account/Payment Event • Tender Details • Suspense/Excess Credit Contract <p>Note: By default, the Payor Account/Payment Event option is selected.</p>	Yes
Payment Event ID	<p>Used to search a particular payment event.</p> <p>Note: This field appears when you select the Payor Account/Payment Event option from the Search By list. The Search (🔍) icon appears corresponding to this field. On clicking the Search icon, the Payment Event Search window appears.</p>	No
Payor Account ID	<p>Used to search payment events which are created for a particular payor account.</p> <p>Note: This field appears when you select the Payor Account/Payment Event option from the Search By list. The Search (🔍) icon appears corresponding to this field. On clicking the Search icon, the Account Search window appears.</p>	No
Payor Name	<p>Used to search payment events which are created for a particular payor.</p> <p>Note: This field appears when you select the Payor Account/Payment Event option from the Search By list.</p>	No
Payment Date	<p>Used to search payment events which are created on a particular date.</p> <p>Note: This field appears when you select the Payor Account/Payment Event option from the Search By list.</p>	No
Tender Type	Used to search payment events where a particular tender type is used.	No

Field Name	Field Description	Mandatory (Yes or No)
	Note: This field appears when you select the Tender Details option from the Search By list.	
Check Number	Used to search a payment event which includes payments made through a particular check. Note: This field appears when you select the Tender Details option from the Search By list.	No
MICR ID	Used to search payment events which include payments made with a particular MICR code. Note: This field appears when you select the Tender Details option from the Search By list.	No
Contract ID	Used to search payment events which include payments made against a particular suspense or excess credit contract. Note: This field appears when you select the Suspense/Excess Credit Contract option from the Search By list. The Search (🔍) icon appears corresponding to this field. On clicking the Search icon, the Contract Search window appears.	No

Note: You must specify at least one search criterion while searching for a payment event.

- **Search Results** — On clicking the **Search** button, the search results appear based on the specified search criteria. The **Search Results** section contains the following columns:

Column Name	Column Description
Payment Event Information	Displays additional information about the payment event. Note: It has a link. On clicking the link, the Payment Event screen appears where you can view the details of the respective payment event.
Transfer	On clicking the Transfer button, you can transfer all payments (which are in either Frozen and Error status) of the payment event to another payee account. Note: The Transfer button appears when: <ul style="list-style-type: none"> • One or more payments of the payment event are in the Frozen or Error status. • There is no payment transfer request which is currently in progress for the payment event.
Cancel	On clicking the Cancel button, you can cancel all payments (which are in the Frozen status) of the payment event.

Column Name	Column Description
	<p>Note: The Cancel button appears when:</p> <ul style="list-style-type: none"> • One or more payments of the payment event are in the Frozen status. • One or more payments of the payment event are not in the Freezable or Error status. • There is no payment transfer request which is currently in progress for the payment event.
Delete	<p>On clicking the Delete button, you can delete the payment event.</p> <p>Note: The Delete button appears when the payments of a payment event are in the Freezable, Error or Incomplete status.</p>
Additional Information	Displays information about the status of the payment event.
Payment Date	Displays the date when the payment was made.
Payor Name	<p>Indicates the person who has made the payment.</p> <p>Note: It has a link. On clicking the link, the Person screen appears where you can view the details of the respective person.</p>
Payor Account ID	<p>Indicates the account which made the payment.</p> <p>Note: It has a link. On clicking the link, the Account screen appears where you can view the details of the respective account.</p>
Tender Amount	Displays the tender amount.
Payment Event ID	Displays the payment event ID.

Related Topics

For more information on...	See...
How to search for a payment event	Searching for a Payment Event on page 1519
How to transfer payments of a payment event	Creating a Payment Transfer Request on page 1520
How to cancel a payment event	Cancelling a Payment Tender on page 1527
How to delete a payment event	Deleting a Payment Event on page 1528

Payments

The **Payments** zone lists all payments created through the payment event. This zone contains the following columns:

Column Name	Column Description
Payment ID	<p>Displays the payment ID.</p> <p>Note: It has a link. On clicking the link, the Payment screen appears with the details of the respective payment.</p>

Column Name	Column Description
Payee Account Information	Displays information about the account for which the payment was made. In addition, this column has a context menu which helps in navigating to other screens in the application.
	Note: It has a link. On clicking the link, the Account screen appears with the details of the respective account.
Payment Amount	Displays the amount paid through the tender.
Payment Currency	Indicates the currency in which the payment was made.
Payment Status	Indicates the status of the payment. The valid values are: <ul style="list-style-type: none"> • Incomplete • Error • Freezable • Frozen • Canceled
Match Type	Indicates the match type using which the payment was matched.
Match Value	Indicates the entity (such as bill, bill segment, or contract) against which the payment was matched.
Error Message	Indicates the reason why the payment is in the Error status.
Payor Account ID	Indicates the account which made the payment.
Refund Amount	Displays the amount which is already refunded to the payor account.

In addition, this zone contains the following buttons:

Button Name	Button Description
Transfer	Used to transfer the payment to another payee account.
	Note: You can transfer a payment when it is in the Frozen or Error status.
Cancel	Used to cancel the payment.
	Note: You can cancel a payment when it is in the Frozen status.
Delete	Used to delete the payment.
	Note: You can delete a payment when it is in the Freezable or Error status.
Refund	Used to refund the payment amount to the payor account.
	Note: You can refund the payment amount to the payor account when: <ul style="list-style-type: none"> • The payment is matched against the suspense or excess credit contract. • The payment is in the Frozen status.

Related Topics

For more information on...	See...
How to view payments created through a payment event	Viewing Payments Created Through a Payment Event on page 1529
How to cancel a payment	Cancelling a Payment on page 1529
How to delete a payment	Deleting a Payment on page 1530
How to transfer a payment	Creating a Payment Transfer Request on page 1520
How to refund a payment	Creating a Refund Request on page 2538

Payment Segments

The **Payment Segments** zone lists payment segments of a payment. This zone contains the following columns:

Column Name	Column Description
Pay Segment ID	Displays the payment segment ID.
	Note: It has a link. On clicking the link, the Pay Segments tab of the Payment screen appears where you view the details of the payment segment.
Contract Information	Displays information about the contract against which the payment segment is created. In addition, this column has a context menu which helps in navigating to other screens in the application.
	Note: It has a link. On clicking the link, the Contract screen appears where you can view the details of the respective contract.
Payment Amount	Displays the payment segment amount.
Match Event ID	Indicates the match event which is created for the payment segment.
	Note: It has a link. On clicking the link, the Match Event screen appears where you can view the details of the respective match event.

Related Topics

For more information on...	See...
How to view payment segments of a payment	Viewing the Payment Segments of a Payment on page 1531

Searching for a Payment Event

Prerequisites

To search for a payment event, you should have:

- Tender types defined in the application

Procedure

To search for a payment event:

1. Click the **Menu** link in the **Actions/Navigation** area.
A list appears.
2. Select the **Main Menu** option from the list.

- From the **Main Menu**, select **Payments** and then click **Payment Event Summary**.

The **Payment Event Summary** screen appears.

- Enter the search criteria in the **Search Payment Event** zone.

Note:

You can search for a payment event and payor account by clicking the **Search** (🔍) icon corresponding to the respective field.

ORMB search engine supports wildcard search, where you can substitute the percentage (%) symbol as a stand in for any word or letter in a search criteria. You can use the ‘%’ wildcard character in all input fields except the date and ID fields. The ‘%’ wildcard character is suffixed automatically at the end of the partial search criteria. Therefore, you may or may not specify the wildcard character at the end of the partial search criteria. However, you have to prefix the wildcard character manually wherever required.

- Click **Search**.

A list of payment events that meet the search criteria appears in the **Search Results** section.

Related Topics

For more information on...	See...
Payment Event Summary screen	Payment Event Summary on page 1514
Search Payment Event zone	Search Payment Event on page 1514

Creating a Payment Transfer Request

The system allows you to transfer payments through a payment request. You can transfer all payments or individual payment of a payment event. You can only transfer payments which are in the **Frozen** or **Error** status.

Prerequisites

To create a payment transfer request, you should have:

- Payment request types defined in the application (where the **Transfer** check box is selected)
- Payment cancel reasons defined in the application (where the **Payment Transfer** check box is selected)

Procedure

To create a payment transfer request:

- Search for the payment event (whose payments you want to transfer) in the **Payment Event Summary** screen.
- Do either of the following:

If you want to...	Then...
Transfer all payments of a payment event	<ol style="list-style-type: none"> In the Search Results section, click the Transfer button in the Transfer column corresponding to the payment event whose payments you want to transfer. <p>Note: The Transfer button appears only when:</p> <ul style="list-style-type: none"> One or more payments of the payment event are in the Frozen or Error status. There is no payment transfer request which is currently in progress for the payment event.

If you want to...	Then...
Transfer one or more payments of a payment event	<ol style="list-style-type: none"> 1. In the Search Results section, click the Broadcast () icon corresponding to the payment event whose payments you want to view. The Payments zone appears. 2. Select the check box corresponding to the payments that you want to transfer. 3. Click the Transfer button in the Payments zone.
	Note: You can transfer a payment when it is in the Frozen or Error status.

The **Select Payment Request Type** screen appears. It contains the following fields:

Field Name	Field Description	Mandatory (Yes or No)
Payment Request Type	Used to indicate the payment request type using which you want to create the payment transfer request. Note: The list includes only those payment request types where the Transfer check box is selected.	Yes

3. Select the required payment request type from the respective field.

4. Click **OK**.

- **Main** - Used to specify basic details about the payment transfer request. This section contains the following fields:

Field Name	Field Description	Mandatory (Yes or No)
Payment Request Type	Indicates the payment request type using which you want to create the payment transfer request.	Not applicable
Payment Event Information	Displays information about the payment event whose payments you want to transfer.	Not applicable
Maximum Transfer Amount	Displays the maximum payment amount which you can transfer. Note: This is a read-only field.	Not applicable
Transfer Amount	Used to specify the total payment amount which you want to transfer. Note: By default, the maximum transfer amount appears in this field.	Yes
Payment Date	Used to specify the date when the payment is transferred.	Yes

Field Name	Field Description	Mandatory (Yes or No)
	<p>Note:</p> <p>By default, the current date appears in this field.</p> <p>This field appears when you want to transfer all the payments of a payment event.</p>	
Transfer Reason	<p>Used to indicate the reason why you want to transfer the payments.</p> <p>Note: The list includes only those payment cancel reasons where the Payment Transfer check box is selected.</p>	Yes

- **Match Types** - Used to define match types for the payment transfer request. This section contains the following fields:

Field Name	Field Description	Mandatory (Yes or No)
Match Type	Used to indicate the match type using which you want to match the payment.	Yes
Show Default	<p>Used to indicate whether the default payment amount should be displayed against the match type entities.</p> <p>Note: The Show Default check box is selected when you select the match type.</p>	No
Entity	<p>Indicates the match type entity. The valid values are:</p> <ul style="list-style-type: none"> • Account - Enables you to select the account whose unpaid bills, unpaid bill segments, settlement IDs, or contracts must be considered while matching the payment. • Bill - Enables you to select the unpaid bill against which you want to match the payment. • Statement - Enables you to select the statement against which you want to match the payment. <p>Note: By default, this is a read-only field.</p>	Not applicable
Entity ID	<p>Used to indicate the account, bill ID, or statement ID depending on the match type entity.</p> <p>Note: The Search (🔍) icon appears corresponding to this field. On clicking the Search icon, based on the selected match type, the relevant entity Search window appears.</p>	Yes

5. Enter the required details.

Note: If you want to specify more than one match type within the payment transfer request, click the **Add (+)** icon in the **Match Types** section and then specify the details. However, if you want to remove a match type from the payment transfer request, click the **Delete (🗑)** icon corresponding to the match type.

6. Click **Manual Distribution**.

The payment transfer request is created and the status of the payment transfer request is set to **Draft**. The **Payment Request** screen appears. Depending on the match type and match entity specified while creating the payment transfer request, the following entities are listed in the **Payment Distribution** zone:

Match Type	Match Entity	Entities
By Bill Regular	Account	Unpaid bills of the account
By Bill Weighted	Account	Unpaid bills of the account
By Bill	Bill	Unpaid bill
By Bill Segments	Account	Unpaid bill segments
By Suspense Contract	Account	Contracts of the account
		<p>Note: Only contracts of the contract type where the Eligible for Billing flag is set to No and Special Role flag is set to Suspense are listed in the Payment Distribution zone. If no contracts with this specification exist for the account, the system checks whether there is any such contract type (where the Eligible for Billing flag is set to No and Special Role flag is set to Suspense) defined for the division to which the account belongs. If there is any such contract type defined for the division, the system creates the contract for the account using the respective contract type and the same is listed in Payment Distribution zone.</p>
By Settlement	Account	Unpaid bill segments where the settlement account is stamped
By Statement	Statement	Unpaid bills of the statement

If the **Show Default** check box is not selected against a match type while creating the payment transfer request, the payment amount against the respective match type entities is set to zero. However, if the **Show Default** check box is selected against a match type, the payment amount appears against the respective match type entities. The transfer amount is divided among the entities in the sequence of match types (where **Show Default** check box is selected) followed by the sequence of bill, bill segment, or contract start date. You can then edit the payment amount, if required.

Note:

If a payment transfer request is already created for a payee account and is currently in progress, the system will not allow you to create another payment transfer request for the payee account until the previous payment transfer request is in the **Processed** or **Rejected** status.

The system does not allow you to create a payment transfer request for a payee account when the respective match type entities (such as unpaid bills, unpaid bill segments, contracts, or settlement IDs do not exists for the payee account.

If the entire refund amount is already processed for the payee account, the system will not allow you to create a payment transfer request.

Related Topics

For more information on...	See...
How to search for a payment event	Searching for a Payment Event on page 1519
Payment Request screen	Payment Request (Used for Viewing) on page 1477
Payment Distribution zone	Payment Distribution on page 1484
How to view the details of a payment transfer request	Viewing the Payment Request Details on page 1477
How to edit a payment transfer request	Editing a Payment Transfer Request on page 1524
How to delete a payment transfer request	Deleting a Payment Creation or Transfer Request on page 1502
How to edit the payment amount against each entity	Editing the Payment Amount on page 1495
How to distribute the tender or payment amount	Distributing the Tender or Payment Amount on page 1503
How to freeze the payments created through a payment transfer request	Freezing Payments Created Through a Payment Request on page 1507
How to approve a payment transfer request	Approving a Payment Creation or Transfer Request on page 1509
How to reject a payment transfer request	Rejecting a Payment Creation or Transfer Request on page 1510
How to edit the amount of a payment segment	Editing the Payment Segment Amount on page 1506
How to submit a payment transfer request for approval	Submitting a Payment Creation or Transfer Request for Approval on page 1508

Editing a Payment Transfer Request**Procedure**

To edit a payment transfer request:

1. Search for the payment transfer request in the **Payment Request** screen.
2. In the **Search Results** section, click the link in the **Payment Request Information** column corresponding to the payment transfer request whose details you want to edit.

The **Payment Request** screen appears.

- Click the **Edit** button in the **Payment Request** zone.

The **Payment Request** screen appears. It contains the following sections:

- Main** - Used to specify basic details about the payment transfer request. This section contains the following fields:

Field Name	Field Description	Mandatory (Yes or No)
Payment Request Information	Displays information about the payment transfer request.	Not applicable
Payment Request Type	Indicates the payment request type using which the payment transfer request is created.	Not applicable
Payment Event Information	Displays information about the payment event.	Not applicable
Maximum Transfer Amount	Displays the maximum payment amount which you can transfer.	Not applicable
Transfer Amount	Displays the total payment amount which can be transferred.	Not applicable
	Note: This is a read-only field.	
Transfer Reason	Used to indicate the reason why you want to transfer the payments.	Yes
	Note: The list includes only those payment cancel reasons where the Payment Transfer check box is selected.	
Payment Date	Displays the date when the payment is made.	Yes

- Match Types** - Used to edit match types for the payment transfer request. This section contains the following fields:

Field Name	Field Description	Mandatory (Yes or No)
Match Type	Indicates the match type using which you want to match the payment.	Yes
	Note: This field appears as read-only while you are viewing the match types which are added for the payment transfer request.	
Show Default	Indicates whether the default payment amount should be displayed against the match type entities.	No

Field Name	Field Description	Mandatory (Yes or No)
	<p>Note:</p> <p>This field appears as read-only while you are viewing the match types which are added for the payment transfer request.</p> <p>The Show Default check box is selected when you select the match type.</p>	
Entity	<p>Indicates the match type entity. The valid values are:</p> <ul style="list-style-type: none"> • Account - Enables you to select the account whose unpaid bills, unpaid bill segments, settlement IDs, or contracts must be considered while matching the payment. • Bill - Enables you to select the unpaid bill against which you want to match the payment. • Statement - Enables you to select the statement against which you want to match the payment. <p>Note: By default, this is a read-only field.</p>	Not applicable
Entity ID	<p>Used to indicate the account or bill ID depending on the match type entity.</p> <p>Note:</p> <p>This field appears as read-only while you are viewing the match types which are added for the payment transfer request.</p> <p>If you want to edit the entity ID, you need to first remove the row and then add it again with the updated information. In that case, the Search (🔍) icon appears corresponding to this field. On clicking the Search icon, based on the selected match type, the relevant entity Search window appears. On specifying the entity, the description of the entity appears corresponding to the Entity ID field.</p>	Yes

4. Modify the details of the payment transfer request, if required.

Note:

If you want to specify more than one match type within the payment transfer request, click the **Add** (+) icon in the **Match Types** section and then specify the details. However, if you want to remove a match type from the payment transfer request, click the **Delete** (🗑️) icon corresponding to the match type.

You cannot edit an existing row in the **Match Types** section. If you want to edit the details of an existing row, you need to first remove the row and then add it again with the updated information.

5. Click **Manual Distribution**.

The changes made to the payment transfer request are saved. The **Payment Request** screen appears. Depending on the information specified in the **Match Types** section, the following entities are listed in the **Payment Distribution** zone.

Match Type	Match Entity	Entities
By Bill Regular	Account	Unpaid bills of the account
By Bill Weighted	Account	Unpaid bills of the account
By Bill	Bill	Unpaid bill
By Bill Segments	Account	Unpaid bill segments
By Suspense Contract	Account	Contracts of the account Note: Only contracts of the contract type where the Eligible for Billing flag is set to No and Special Role flag is set to Suspense are listed in the Payment Distribution zone. If no contracts with this specification exist for the account, the system checks whether there is any such contract type (where the Eligible for Billing flag is set to No and Special Role flag is set to Suspense) defined for the division to which the account belongs. If there is any such contract type defined for the division, the system creates the contract for the account using the respective contract type and the same is listed in Payment Distribution zone.
By Settlement	Account	Unpaid bill segments where the settlement account is stamped
By Statement	Statement	Unpaid bills of the statement

If the **Show Default** check box is not selected against a match type while creating the payment transfer request, the payment amount against the respective match type entities is set to zero. However, if the **Show Default** check box is selected against a match type, the payment amount appears against the respective match type entities. The transfer amount is divided among the entities in the sequence of match types (where **Show Default** check box is selected) followed by the sequence of bill, bill segment, or contract start date. You can then edit the payment amount, if required.

Related Topics

For more information on...	See...
How to search for a payment request	Searching for a Payment Request on page 1476
Payment Request screen	Payment Request (Used for Viewing) on page 1477
Payment Request zone	Payment Request on page 1478
Payment Details zone	Payment Details on page 1483
Payment Distribution zone	Payment Distribution on page 1484

Canceling a Payment Tender

Prerequisites

To cancel a payment tender, you should have:

- Payment cancel reasons defined in the application

Procedure

To cancel a payment tender:

1. Search for the payment tender in the **Payment Event Summary** screen.
2. In the **Search Results** section, click the **Tender Cancel** link in the **Cancel** column corresponding to the payment tender that you want to cancel.

The **Payment Event** screen appears.

Note: The **Tender Cancel** link appears when:

- One or more payments of the payment event are in the **Frozen** status.
- One or more payments of the payment event are not in the **Freezable** or **Error** status.
- There is no payment transfer request which is currently in progress for the payment event.

3. Ensure that the **Tenders** tab is selected.
4. Click the **Cancel** button in the **Tender Cancel** row.

The **Tender Cancel** window appears. It contains the following fields:

Field Name	Field Description	Mandatory (Yes or No)						
Cancel Reason	Used to indicate the reason why you want to cancel the payment tender.	Yes						
Bank Account To Charge	Used to specify the bank details for cancellation charge purposes. <table border="1" data-bbox="527 1119 1218 1333"> <thead> <tr> <th>Field Name</th> <th>Field Description</th> </tr> </thead> <tbody> <tr> <td>Bank Code</td> <td>Used to indicate the bank code which should be charged for cancellation.</td> </tr> <tr> <td>Bank Account Key</td> <td>Used to indicate the bank account which should be charged for cancellation.</td> </tr> </tbody> </table>	Field Name	Field Description	Bank Code	Used to indicate the bank code which should be charged for cancellation.	Bank Account Key	Used to indicate the bank account which should be charged for cancellation.	Yes
Field Name	Field Description							
Bank Code	Used to indicate the bank code which should be charged for cancellation.							
Bank Account Key	Used to indicate the bank account which should be charged for cancellation.							

5. Click **OK**.

The payment tender and all payments in the payment event are cancelled.

Related Topics

For more information on...	See...
How to search for a payment event	Searching for a Payment Event on page 1519

Deleting a Payment Event

You can delete a payment event when the payment(s) of the payment event are in the **Freezable**, **Error**, or **Incomplete** status. On deleting a payment event, the payment event, payments, payment segments, and payment tender are deleted.

Procedure

To delete a payment event:

1. Search for the payment event in the **Payment Event Summary** screen.
2. In the **Search Results** section, click the **Delete** button in the **Delete** column corresponding to the payment event that you want to delete.

A message appears confirming whether you want to delete the payment event.

Note: The **Delete** button appears when the payments of a payment event are in the **Freezable, Error, or Incomplete** status.

3. Click **OK**.

The payment event is deleted.

Related Topics

For more information on...	See...
How to search for a payment event	Searching for a Payment Event on page 1519

Viewing Payments Created Through a Payment Event

Procedure

To view payments created through a payment event:

1. Search for the payment event in the **Payment Event Summary** screen.
2. In the **Search Results** section, click the **Broadcast** () icon corresponding to the payment event whose payments you want to view.

The **Payments** zone appears.

3. View all payments created through the payment event in the **Payments** zone.

Related Topics

For more information on...	See...
How to search for a payment event	Searching for a Payment Event on page 1519
Payments zone	Payments on page 1517

Cancelling a Payment

Prerequisites

To cancel a payment of a payment event, you should have:

- Payment cancel reasons defined in the application

Procedure

To cancel a payment of a payment event:

1. Search for the payment event in the **Payment Event Summary** screen.
2. In the **Search Results** section, click the **Broadcast** () icon corresponding to the payment event whose payment you want to cancel.

The **Payments** zone appears.

3. Select the check box corresponding to the payment that you want to cancel.

- Click **Cancel** in the **Payments** zone.

The **Payment Cancel** window appears. It contains the following fields:

Field Name	Field Description	Mandatory (Yes or No)
Cancel Reason	Used to indicate the reason why you want to cancel the payment.	Yes

Note: You can cancel a payment when it is in the **Frozen** status.

- Select the cancel reason from the respective list.
- Click **OK**.

The status of the payment is changed to **Canceled**.

Related Topics

For more information on...	See...
How to search for a payment event	Searching for a Payment Event on page 1519
Payments zone	Payments on page 1517

Deleting a Payment

Procedure

To delete a payment of a payment event:

- Search for the payment event in the **Payment Event Summary** screen.
- In the **Search Results** section, click the **Broadcast** () icon corresponding to the payment event whose payment you want to delete.

The **Payments** zone appears.

- Select the check box corresponding to the payment that you want to delete.
- Click **Delete** in the **Payments** zone.

A message appears confirming whether you want to delete the payment.

Note: You can delete a payment when it is in the **Freezable** or **Error** status.

- Click **OK**.

The payment is deleted.

Related Topics

For more information on...	See...
How to search for a payment event	Searching for a Payment Event on page 1519
Payments zone	Payments on page 1517

Creating a Refund Request for a Payment

The system allows you to create a refund request for a payment. You can refund an individual payment of a payment event. You can only refund payments which are in the **Frozen** status and matched against the suspense or excess credit contracts. For more information, refer to [Creating a Refund Request](#) on page 2538

Related Topics

For more information on...	See...
How to search for a payment event	Searching for a Payment Event on page 1519

Viewing the Payment Segments of a Payment

Procedure

To view the payment segments of a payment:

1. Search for the payment event (whose payment details you want to view) in the **Payment Event Summary** screen.
2. In the **Search Results** section, click the **Broadcast** (📡) icon corresponding to the payment event whose payment segments you want to view.
The **Payments** zone appears.
3. Click the **Broadcast** (📡) icon corresponding to the payment whose payment segments you want to view.
The **Payment Segments** zone appears.
4. View the payment segments of the payment in the **Payment Segments** zone.

Related Topics

For more information on...	See...
How to search for a payment event	Searching for a Payment Event on page 1519
Payment Segments zone	Payment Segments on page 1519

Updating the Transfer Amount in a Payment Transfer Request

Procedure

To update the transfer amount in a payment transfer request:

1. Search for the payment transfer request in the **Payment Request** screen.
2. In the **Search Results** section, click the link in the **Payment Request Information** column corresponding to the payment transfer request whose transfer amount you want to change.
The **Payment Request** screen appears.
3. Click the **Update Transfer Amount** button in the **Payment Request** zone.

The **Update Transfer Amount** screen appears. It contains the following fields:

Field Name	Field Description	Mandatory (Yes or No)
Maximum Transfer Amount	Displays the maximum payment amount which you can transfer.	Not applicable
	Note: This is a read-only field.	

Field Name	Field Description	Mandatory (Yes or No)
Transfer Amount	Used to specify the total payment amount which you want to transfer.	Yes
	Note: By default, the maximum transfer amount appears in this field.	

Note: The **Update Transfer Amount** button appears when the payment transfer request is in the **Draft** status.

- Update the transfer amount, if required.
- Click **Save**

The transfer amount in the payment transfer request is updated.

Note: By clicking the **Update Transfer Amount** button you can convert a full payment transfer into partial payment transfer.

Related Topics

For more information on...	See...
How to search for a payment request	Searching for a Payment Request on page 1476
Payment Request screen	Payment Request (Used for Viewing) on page 1477

Updating the Tender Details in a Payment Transfer Request

Procedure

To update the tender details in a payment transfer request:

- Search for the payment transfer request in the **Payment Request** screen.
- In the **Search Results** section, click the link in the **Payment Request Information** column corresponding to the payment transfer request whose details you want to view.

The **Payment Request** screen appears.

- Click the **Update Tender Details** button in the **Payment Request** zone.

The **Update Tender Details** screen appears. It contains the following fields:

Field Name	Field Description	Mandatory (Yes or No)
Tender Type	Indicates the type of tender through which the payment is made.	Not applicable
Tender Amount	Displays the tender amount.	Not applicable
Currency	Indicates the currency in which the payment is made.	Not applicable
Pay Tender ID	Indicates the payment tender ID.	Not applicable
Tender Status	Indicates the status of the tender. The valid values are: <ul style="list-style-type: none"> Valid 	Not applicable
Tender Control ID	Used to indicate the tender control ID.	Yes

Field Name	Field Description	Mandatory (Yes or No)
	<p>Note:</p> <p>The Search (🔍) icon appears corresponding to this field. On clicking the Search icon, the Tender Control Search window appears.</p> <p>On specifying the tender control ID, the description of the tender control ID appears corresponding to the Tender Control ID field.</p>	
Deposit Control Information	<p>Used to indicate the deposit control ID.</p> <p>Note:</p> <p>It is a read-only field.</p> <p>The data appears in this field when the tender control ID is specified.</p>	No
MICR ID	Used to specify the MICR code on the payment.	No
Ext. Reference ID	Used to specify the external reference number of the payment on the payment upload interface record.	No
Person ID	Used to specify the person's account ID mentioned in the payment upload interface record.	No
Name	Used to specify the name of the person as it appears in the payment upload interface record.	No

In addition to the above fields, this screen contains the following section:

Characteristics - Used to define the characteristics for the payment tender. This section contains the following fields:

Field Name	Field Description	Mandatory (Yes or No)
Characteristic Type	Used to indicate the characteristic type.	Yes (Conditional)
	<p>Note: The list includes only those characteristic types where the characteristic entity is set to Payment Tender.</p>	<p>Note: This field is required when you are defining a characteristic for the payment tender.</p>
Characteristic Value	Used to specify the value for the characteristic type.	Yes (Conditional)
	<p>Note:</p> <p>If you select a predefined characteristic type, the Search (🔍) icon appears corresponding to this field. On clicking the Search icon, the Business Object Search window appears.</p> <p>On specifying the business object, the description of the business object appears corresponding to the Characteristic Value field.</p>	<p>Note: This field is required when you are defining a characteristic for the payment tender.</p>

4. Enter the required details.
5. Define characteristics for the payment tender, if required.
6. Click **Save**.

Related Topics

For more information on...	See...
How to search for a payment request	Searching for a Payment Request on page 1476
Payment Request screen	Payment Request (Used for Viewing) on page 1477
How to define a characteristic for a payment tender	Defining a Characteristic for a Payment Tender on page 1494
Payment Request zone	Payment Request on page 1478
Payment Details zone	Payment Details on page 1483
Payment Distribution zone	Payment Distribution on page 1484

Chapter 22

Account Receivable Central

Topics:

- [Single Offset](#)
- [Mass Offset](#)
- [Cross Currency Offset](#)
- [Hold](#)
- [Refund](#)
- [Write Off](#)
- [Dispute](#)
- [Account Receivable Central](#)

The Account Receivable Central is a portal which facilitates user to perform Single/Mass/Cross Currency offset operation for a bill's outstanding amount with another bill or multiple bills. You can also refund/write off amount to the account using refund requests and write off requests respectively.

Account Receivable Central also enables to put bill(s) on hold for the funding purpose. It allows you to have a complete overview of the bills. Based on the search criteria, the system returns a list of bills that meet the search criteria.

Account Receivable Central is used for:

- **Single Offset** - Enables single debit bill to be offset against multiple credit bills in the same currency and vice versa.
- **Mass Offset** - Enables credit/debit bills to be offset against multiple debit and credit bills in the same currency.
- **Cross Currency Offset** - Enables single debit bills to be offset against multiple credit bills in currencies other than the bill selected for offset and vice versa.
- **Hold** - Enables bill(s) to be put on hold fully (the bill outstanding amount) or partially (the bill outstanding amount in partial) for a specific period for funding.
- **Refund** - Enables you to refund amount of credit bill or bill line item (credit bill segment or adjustment) to the account through a refund request.
- **Write Off** - Enables you to write off amount to the account through a write off request.
- **Dispute** - Enables you to dispute amount of credit/debit bill or bill item (credit/debit bill segment or adjustment) to the account through a dispute request.

The bill(s) for offsetting can belong to the same person or multiple persons depending upon the option **Allow Offsetting across Persons** set in the feature configuration **C1-OFFSETREQ** which allows offsetting in the system.

Single Offset

Single Offset enables you to search and add bill to an offset request from the **Account Receivable Central** screen. Single Offset enables single debit bill to be offset against multiple credit bills in the same currency and vice versa. The offset request is created and an offset request ID is generated for the request.

You can search and select credit/debit bills (with outstanding amount) for offsetting belonging to the same or different person. All the selected bills with their outstanding balance are displayed. The display of bills is controlled by **C1-OFFSETREQ** feature configuration. The feature configuration identifies whether offsetting is allowed for bills across persons. To offset bills belonging to different persons, set the **Allow Offsetting Across Persons** option type to **Y**. The bills are displayed having same currency with the default offset amount on the offset request after adding the bills. You can select one or multiple or all the bills displayed and add to the offset request. After you add a debit bill from **Account Receivable Central**, you cannot add more debit bills to the offset request.

Upon adding a bill to the offset request, the default offset amount algorithm **C1-OFST-AMT** configured in the offset request type is invoked. The bills in the offset request are processed based on the logic of oldest bill first. The default offset amount is populated against the selected debit and credit bills. You can also edit the offset amount from the offset request, if required. The offset adjustments for offset requests are created and distributed based on the match type set in the offset distribution algorithm.

You can configure the offset request type to be submitted for offset distribution with or without approval. Upon submitting the offset request for approval, a To Do type is created and sent to the approver for offset request approval. The status of the offset request changes from **Submitted** to **Approval In Progress** in case of offset request with approval and in case of offset request without approval it changes to **Processed**. The approver can either approve or reject the offset request. Once the approver approves the offset request, selected bills are offset and adjustments are created for the bills. The status of the offset request changes from **Approval In Progress** to **Processed**. You can also view the details of the adjustment(s) created. However, if the approver rejects an offset request, a rejection reason should be provided.

A log maintained for offset requests logs complete trail of actions performed on offset request except the actions performed while editing the offset request. On submitting, the offset request status changes to **Processed** or **Approval In Progress** depending on the configuration of the offset request type and the **Unapply** button is enabled which cancels the adjustments. Upon cancelling the adjustments, the enter status algorithm cancels the offset adjustments and the status of the request changes to **Unapplied Offset**.

Note: The **Unapply** button appears when the offset request is in the **Processed** status

Bill Information	Original Outstanding Amount	Offset Amount	Remaining Bill Balance	Comments
Bill 1	\$1200	—\$800	\$400	Bill 1 amount \$1200 is offset against Bill 2.
Bill 2	—\$1000	\$500	—\$500	From Bill 2, \$500 is offset against from Bill 1.
Bill 3	—\$300	\$300	0	From Bill 3, \$300 is offset against from Bill 1.

Mass Offset

Mass offset functions is similar to single offset, the only difference is that mass offset enables credit/debit bills to be offset against multiple debit and credit bills in the same currency.

Upon selection of a debit/credit bill from **Account Receivable Central**, you can add more credit/debit bill(s) from the search bills result in offset request. You can filter the bills using the **Bill Type** filter on the bill search zone to select debit/credit bills to be added to the offset request. While offsetting the credit/debit amount across multiple bills, the oldest bill is offset first.

A log maintained for offset requests logs complete trail of actions performed on offset request. Once you submit the offset request, the offset request status changes to **Processed** or **Approval In Progress** depending on the configuration of the offset request type. When the offset request status changes to **Processed** adjustments are created and the **Unapply** button is enabled which cancels the adjustments. Upon unapplying the offset request, the enter status algorithm cancels the offset adjustments and the status of the request changes to **Unapplied Offset**.

Bill Information	Original Outstanding Amount	Offset Amount	Remaining Bill Balance	Comments
Bill 1	\$2000	—\$700	\$1300	The Offset amount \$400 is offset against Bill 2.
Bill 2	—\$400	\$400	0	Bill 2 is offset against \$400 from Bill Outstanding amount of Bill 1 i.e. \$2000.
Bill 3	—\$300	\$300	0	Bill 3 is offset against \$300 from Bill Outstanding amount of Bill 1 i.e. \$1600.

Cross Currency Offset

Enables single debit bills to be offset against multiple credit bills in currencies other than the bill selected for offset and vice versa. Cross-currency offset enables you to offset credit/debit bills with different currencies. You can add credit/debit bills to the debit/credit bill added from **Account Receivable Central**. After you add a debit bill from **Account Receivable Central**, you cannot add more debit bills to the offset request. While offsetting the credit/debit amount across multiple bills, the oldest bill is offset first.

The **C1-OFFSUBENT** algorithm validates whether the sum of debit offset amount is equal to sum of credit offset amount for all bills selected in the offset request. After validation, status of the offset request changes to **Processed** or **Approval In Progress** depending on the configuration of the offset request type.

Bill Information	Outstanding Amount	Outstanding Amount (in Offset currency)	Offset Amount	Remaining Bill Balance	Comments
Bill 1	\$300	\$300	—\$130.1	\$169.9	Outstanding amount \$300 is offset against \$130.1 (£100). (Exchange rate: 1£=1.3\$)
Bill 2	—£100	—\$130.1	\$130.1	0	Outstanding amount £100 (\$130.1) of Bill 2 is offset against \$300 from Bill 1.

Note: In case of multiple exchange rates with same date and different timestamps, the latest timestamp is considered.

Note: The adjustments are created in the currency of the bill.

Hold

Account Receivable Central enables bill(s) to be put on hold which belongs to a person's account or all accounts of a particular person. When a bill is put on hold, specific reason must be specified; no funding related activities can be performed for the specified period.

Funding related activities are put on hold from the start date of the hold request. The hold exists till the hold request release date; however you can also release individual bills.

You can only put bills on hold which has **Completed** status. When a person/account is on hold, all the subsequent bills under them are also on hold irrespective of bill status. You can select the bill amount in a bill to be put on hold i.e. you can put the particular bill on hold with partial or full bill amount.

Hold request type is used to define the hold request. In the hold request type, the **Hold Process** is set to **Funding**, which puts hold on only the funding activities of the selected bill belonging to a person or account.

Refund

Enables you to refund amount of credit bill to account through a refund request. For creating a refund request you need to specify the refund request type using which you want to create the refund request. The refund request can be defined with (single level/multi-level) or without approval workflow. An approval profile should be defined for the approval workflow. While defining the refund request type, the adjustment type should be defined for creating refund adjustments.

Write Off

Enables you to write off the amount to the account through a write off request. For creating a write off request you need to specify the write off request type. The write off request can be defined with (single level/multi-level) or without approval workflow. An approval profile should be defined for the approval workflow. While defining the write off request type, the adjustment type should be defined for creating write off adjustments.

Dispute

Enables you to dispute amount of credit/debit bill to an account through a dispute request. For creating a dispute request you need to specify the dispute request type using which you want to create the dispute request. The dispute request can be defined with (single level/multi-level) or without approval workflow. An approval profile should be defined for the approval workflow. While defining the dispute request type, the adjustment type should be defined for creating dispute adjustments.

Account Receivable Central

The **Account Receivable Central** screen allows you to search for bills using various search criteria. This screen consists of the following zones:

- [Search Bill](#) on page 1538

Through the **Account Receivable Central** screen, you can navigate to the following screens:

- [Offset Request \(Used for Viewing\)](#) on page 1589
- [Hold Request \(Used for Viewing\)](#) on page 1720
- [Refund Request](#) on page 2545
- [Write Off Request](#) on page 2578
- [Dispute Request \(Used for Viewing\)](#) on page 2042

Search Bill

The **Search Bill** zone allows you to search for bills in the **Accounts Receivable Central** screen using various search criteria. This zone contains the following two sections:

- **Search Criteria** — The **Search Criteria** section contains the following fields:

Field Name	Field Description	Mandatory (Yes or No)
Search By	Used to indicate whether you want to search bills using bill details, using account details or using person details whose account is linked to a particular bill. The valid values are: <ul style="list-style-type: none"> • Person Details • Account Details • Bill Details 	Yes
	Note: By default, the Person Details option is selected.	
Person ID	Used to select the person ID based on which you want to search for bills of a person.	No
	Note: This field appears when you select the Person Details option from the Search By list. The Search (🔍) icon appears corresponding to this field. On clicking the Search icon, the Account Search window appears.	
Person Hierarchy	Used to indicate whether to display hierarchy of the person linked to a particular bill.	No
	Note: This field appears when you select the Person Details option from the Search By list.	
Person Identifier Type	Used to select the identifier type based on which you want to search for bills of a person.	Yes (Conditional)
	Note: This field appears when you select the Person Details option from the Search By list.	
Person Identifier	Used to specify the value of the person identifier type.	Yes (Conditional)
	Note: This field appears when you select the Person Details option from the Search By list.	
Bills on Hold	Used to indicate whether the bill is on hold. The valid values are: <ul style="list-style-type: none"> • No • Yes 	No
Bill Balance	Used to search bills with a particular balance amount. The valid values are: <ul style="list-style-type: none"> • Equal to Zero 	No

Field Name	Field Description	Mandatory (Yes or No)
	<ul style="list-style-type: none"> • Greater Than Zero • Less Than Zero • Not Equal to Zero 	
Pending Bills	Used to indicate whether the bill is pending.	No
Account ID	Used to search for bills of a particular account. Note: This field appears when you select the Account Details option from the Search By list.	No
Account Identifier Type	Used to specify the account identifier type of the account whose bill you want to search. Note: This field appears when you select the Account Details option from the Search By list.	No
Account Identifier	Used to select the account identifier based on which you want to search for bills of a particular account. Note: This field appears when you select the Account Details option from the Search By list.	No
Bill ID	Used to search a particular bill. Note: This field appears when you select the Bill Details option from the Search By list.	No
Alternate Bill ID	Used to search a particular bill using the alternate bill ID. Note: This field appears when you select the Bill Details option from the Search By list.	No
Invoice Currency	Used to search for bills which are billed in a particular currency. Note: This field appears when you select the Bill Details option from the Search By list.	No
Bill Date From	Used to search bills which are created from a particular date onwards.	No
To	Used to search bills which are created till a particular date.	No
Bill Outstanding Amount From	Used to search bills with a particular minimum outstanding amount.	
To	Used to search bills with a particular maximum outstanding amount.	

Note: You must specify at least one search criterion while searching for a bill when you select the **Person Details** or **Account Details** option from the **Search By** list.

- **Search Results** — On clicking the **Search** button, the search results appear based on the specified search criteria. The **Search Results** section contains the following columns:

Column Name	Column Description
Bill Information	Displays additional information about the bill. In addition, this column has a context menu which helps in navigating to other screens in the application. Note: It has a link. On clicking the link, the Bill screen appears with the details of the respective bill.
Original Bill Amount	Displays the bill amount when the bill was generated.
Outstanding Amount	Displays the current bill balance amount.
Bill Date	Used to specify the date on which the bill was generated.
Hold Amount	Displays the amount from the bill that is on hold.
Account Information	Displays additional information about the account. In addition, this column has a context menu which helps in navigating to other screens in the application. A tool tip appears when you hover over this column corresponding to the bill. It indicates the Current Balance, Excess Payment and Unapplied Payments and their values. Note: It has a link. On clicking the link, the Account screen appears where you can view the details of the respective bill.
Person Information	Displays additional information about the person. In addition, this column has a context menu which helps in navigating to other screens in the application. Note: It has a link. On clicking the link, the Person screen appears with the details of the respective bill.

This zone contains following buttons:

Button Name	Button Description
Single Offset	Used to add the selected bill with same currency to an offset request.
Mass Offset	Used to add the selected bills with same currency to an offset request.
Cross Currency Offset	Used to add the selected bills with different currency to an offset request.
Hold	Used to add the selected bill to hold request to be put on hold.
Write Off	Used to add the selected bill to a write off request.
Refund	Used to add the selected bill to a refund request.
Dispute	Used to add the selected bill to a dispute request.

Related Topics

For more information on...	See...
How to search for bill	Searching for a Bill on page 1543
How to view the details of a bill	Viewing the Bill Details on page 1544

Bill Information

The **Bill Information** screen allows you to view detail information of a particular bill.

This screen consists of the following zones:

- [Hold Details](#) on page 1542
- [Offset Details](#) on page 1542
- [Garnishment Details](#) on page 1542
- [Bill Line Items](#) on page 1543

Offset Details

The **Offset Details** zone displays details of the offset request. This zone contains following columns:

Column Name	Column Description
Offset Request Information	Displays additional information about the offset request.
	Note: It has a link. On clicking the link, the Offset Request screen appears where you can view the details of the respective offset request.
Offset Amount	Displays the total offset amount.
Creation Mode	Displays the mode of creation for offset request . The valid values are: <ul style="list-style-type: none"> • Automatic • Manual

Hold Details

The **Hold Details** zone displays details of the hold request on a bill. This zone contains following columns:

Column Name	Column Description
Hold Request Information	Displays additional information about the hold request.
	Note: It has a link. On clicking the link, the Hold Request screen appears where you can view the details of the respective hold request.
Status	Indicates the status of the hold request.
Entity	Displays the type of entity.
Hold Entity	Displays additional information about the bill which is put on hold.
	Note: It has a link. On clicking the link, the Bill screen appears where you can view the details of the respective bill.
Start Date	Displays the start date of the hold request.
End Date	Displays the end date of the hold request.

Garnishment Details

The **Garnishment Details** zone displays details garnishment details of the offset request. This zone contains following columns:

Column Name	Column Description
Garnishment Contract	Displays additional information about the contract created against the garnishment adjustments. In addition, this column has a context menu which helps in navigating to other screens in the application.
	Note: It has a link. On clicking the link, the Contract screen appears where you can view the details of the respective contract.
Garnishment Amount	Displays the total garnishment amount.

Bill Line Items

The **Bill Line Items** zone displays information about the selected bill's bill line item. This zone contains the following fields:

Field Name	Field Description
Bill Line Item	Displays the bill line item (bill segment/adjustment) of the selected bills.
Bill Line Item Information	Displays the information about the bill line item.
	Note: It has a link. On clicking the link, the Bill Segment screen or Adjustments screen appears with the details of the respective bill line item or adjustments.
Amount	Displays the amount of the bill line item.
Contract Information	Displays additional information about the contract against which the bill segment or adjustment is created. In addition, this column has a context menu which helps in navigating to other screens in the application.
	Note: It has a link. On clicking the link, the Contract screen appears where you can view the details of the respective contract.

Related Topics

For more information on...	See...
How to view the details of a bill	Viewing the Bill Details on page 1544

Searching for a Bill

Procedure

To search for a bill:

1. Click the **Menu** link in the **Application** toolbar.
A list appears.
2. From the **Main** menu, select **Accounting and Receivable** and then click **Account Receivable Central**.
The **Account Receivable Central** screen appears.
3. Enter the search criteria in the **Search Bill** zone.

Note: ORMB search engine supports wildcard search, where you can substitute the percentage (%) symbol as a stand in for any word or letter in a search criteria. You can use the ‘%’ wildcard character in all input fields except the date and ID fields. The ‘%’ wildcard character is suffixed automatically at the end of the partial search criteria. Therefore, you may or may not specify the wildcard character at the end of the partial search criteria. However, you have to prefix the wildcard character manually wherever required.

Note: The wild card search for searching bill in the **Search Bill** zone is applicable when you select the **Bill Details** option from the **Search By** list.

4. Click **Search**.

A list of bills that meet the search criteria appears in the **Search Results** section.

Related Topics

For more information on...	See...
Account Receivable Central screen	Account Receivable Central on page 1538
Search Bill zone	Search Bill on page 1538

Viewing the Bill Details

Procedure

To view the details of a bill:

1. Search for the bill in the **Account Receivable Central** screen.
2. In the **Search Results** section, click the **Show Context Menu** (▼) icon corresponding to the bill whose details you want to view.
A menu appears.
3. Click the **Go To Bill Information** menu option.
The **Bill Information** screen appears.
4. View the details of the bills in the **Bill Information** screen.

Related Topics

For more information on...	See...
Account Receivable Central screen	Account Receivable Central on page 1538
Bill Information screen	Bill Information on page 1542
How to search for a bill	Searching for a Bill on page 1543

Chapter 23

Offset Request

Topics:

- [Single Offset](#)
- [Mass Offset](#)
- [Cross Currency Offset](#)
- [Prerequisites](#)
- [Offset Request \(Without Approval\) Status Transition](#)
- [Offset Request \(With Approval\) Status Transition](#)
- [Bill Line Items Level Offset](#)
- [Internal Offsetting of Zero Balance Bill](#)
- [Algorithms Used in C1-OffsetRequest](#)
- [Additional Algorithms Used in Offset Request](#)
- [Offset Request Type](#)
- [Offset Request \(Used for Searching\)](#)
- [Offset Request \(Used for Viewing\)](#)

Oracle Revenue Management and Billing allows you to offset the credit and debit bills across accounts of the person and/or its hierarchy. However, you can offset bills across person's hierarchy when the **Allow Offsetting Across Persons** option type of the **C1-OFFSETREQ** feature configuration is set to **Y**.

You can offset a credit bill with a debit bill and vice-versa. You can offset one or more credit bills with one or more debit bills and vice-versa. You can offset the credit and debit bills in the same currency or in the different currencies. The system enables you to offset bills through an offset request. You can create an offset request from the following screens:

- [Account Receivable Central](#) on page 1538
- [Offset Request \(Used for Searching\)](#) on page 1583

You can create the following types of offset request from both the above screens:

- [Single Offset](#) on page 1547
- [Mass Offset](#) on page 1548
- [Cross Currency Offset](#) on page 1551

While creating an offset request, you need to specify an offset request type using which you want to create the offset request. It is the offset request type which helps the system to determine:

- The business object using which the offset request should be created in the system.
- The default adjustment type using which the transfer or offset adjustment should be created in the system.
- The algorithm which helps to calculate default offset amount when a bill is added to the offset request.
- Whether approval is required while offsetting bills through an offset request.
- Whether an offset request must be processed in the deferred mode or in real time (i.e. immediately)
- The maximum search period (in days) that you want to allow while searching bills in an offset request.
- Whether the transfer or offset adjustments should be created while offsetting bills through an offset request.

In addition, while creating an offset request, you need to specify a primary bill for which you want to create the offset request. A primary bill can be a debit

or credit bill. Once the primary bill is added to an offset request, you can never remove it from the offset request.

Once you specify an offset request type and primary bill, the offset request is created in the **Draft** status. You can then add one or more debit or credit bills in the same or different currencies to the offset request depending on whether you want to create single, mass, or cross currency offset request. These bills are called as secondary bills. You can remove a secondary bill from the offset request when it is in the **Draft** status.

Once both the debit and credit bills are added to an offset request, the default offset amount is calculated for each bill. You can then update the offset amount of a bill, if required. Once the offset amount is specified for each bill, you can submit the offset request. On submitting an offset request, the system checks whether the number of financial transactions created for the bills (which are selected in the offset request) exceeds the defer processing count (defined in the respective offset request type). If the number of financial transactions does not exceed the defer processing count, the system creates the transfer or offset adjustments in the **Frozen** status. However, if the number of financial transactions exceeds the defer processing count, the system changes the status of the offset request to **Deferred Processing**. On executing the **Offset Request Periodic Monitor (C1-OFSRQ)** batch, the system considers the offset requests which are in the **Deferred Processing** status. The batch then creates the transfer or offset adjustments for these offset requests in the **Frozen** status.

You can optionally configure the approval process for the offset request. The approver can either approve or reject an offset request based on the observations. The system also enables you to unapply (i.e. cancel) an offset request. On canceling an offset request, the transfer or offset adjustments created for bills through the offset request are canceled.

An offset request goes through various statuses in its lifecycle. For more information about the offset request statuses, see [Offset Request \(Without Approval\) Status Transition](#) on page 1554 and [Offset Request \(With Approval\) Status Transition](#) on page 1555. Note that the lifecycle of an offset request is driven by business object using which the offset request is created. An offset request business object named **C1-OffsetRequest** is shipped with the product. The offset request feature explained in this document is articulated based on the lifecycle and logic defined in the **C1-OffsetRequest** business object.

For more information on how to setup the offset request feature, see [Prerequisites](#) on page 1553.

Single Offset

Single offset means you can offset one credit bill against multiple debit bills and vice-versa in the same currency. Let us understand this with the help of an example.

The following table lists the bills of a customer which are available for single offset:

Account	Bill	Due Date	Bill Segment	Contract Type Priority	Bill Segment Amount	Outstanding Bill Amount	Hold Amount
A1	Bill 1	06-18-2018	BS1	10	-\$100	-\$100	-\$20
	Bill 2	06-12-2018	BS2	10	\$30	\$30 (This is because \$20 is already paid.)	\$10
			BS3	20	\$20		
	Bill 3	06-22-2018	BS4	10	\$30	\$30	\$10
	Bill 4	06-28-2018	BS5	20	\$30	\$40	-
			BS6	30	\$10		

The system enables you to offset these bills through a single offset request. While creating a single offset request, you can add the Bill 1 as the primary bill against which you can offset the debit bills – Bill 2, Bill 3, and Bill 4. Note that you can only add completed bills to an offset request. The system then calculates the total credit and debit bill amount which is available for offsetting, as shown below:

Sum of credit bills' amount which is available for offsetting:

$$(-\$100 - (-\$20)) = (-\$100 + \$20) = -\$80$$

Sum of debit bills' amount which is available for offsetting:

$$((\$30 - \$10) + (\$30 - \$10) + (\$40)) = \$80$$

The system considers the credit or debit bills' total whichever is less as the default offset amount. You can change the offset amount of a bill, if required. However, you need to ensure the following:

- Offset amount of the selected bill is not equal to zero
- Total debit offset amount is equal to total credit offset amount in the offset request
- Negative offset amount is specified for the debit bill and positive offset amount is specified for the credit bill
- Offset amount is less than or equal to the current outstanding amount of the bill

Note: If you add or remove a bill from the offset request after updating the offset amount, the system overrides the offset amount with the default offset amount. In such scenarios, you have to update the offset amount of the bills once again.

On submitting or approving a single offset request, the system creates the transfer or offset adjustments using the adjustment type which is specified in the offset request. If the **Transfer Adjustment** option is selected in the respective offset request type, the system creates the transfer adjustments in the **Frozen** status.

The following table lists the transfer adjustments that are created during the single offset with respect to the above example:

Transfer	Transfer Adjustments
1	<ul style="list-style-type: none"> \$20 transfer adjustment is created for Bill 1 and matched to -\$100 bill segment cancellation (BS1) FT 1 -\$20 transfer adjustment is created for Bill 2 and matched to \$30 bill segment (BS2) FT 2
2	<ul style="list-style-type: none"> \$20 transfer adjustment is created for Bill 1 and matched to -\$100 bill segment cancellation (BS1) FT 1 -\$20 transfer adjustment is created for Bill 3 and matched to \$30 bill segment (BS4) FT 4
3	<ul style="list-style-type: none"> \$30 transfer adjustment is created for Bill 1 and matched to -\$100 bill segment cancellation (BS1) FT 1 -\$30 transfer adjustment is created for Bill 4 and matched to \$30 bill segment (BS5) FT 5
4	<ul style="list-style-type: none"> \$10 transfer adjustment is created for Bill 1 and matched to -\$100 bill segment cancellation (BS1) FT 1 -\$10 transfer adjustment is created for Bill 4 and matched to \$10 bill segment (BS6) FT 6

However, if the **Transfer Adjustment** option is not selected in the respective offset request type, the system creates the offset adjustments in the **Frozen** status. Considering the above example, the system will create the following offset adjustments for the offset request:

- \$80 offset adjustment is created for Bill 1 and matched to -\$100 Bill Segment Cancellation (BS1) FT 1
- \$20 offset adjustment is created for Bill 2 and matched to \$30 bill segment (BS2) FT 2
- \$20 offset adjustment is created for Bill 3 and matched to \$30 bill segment (BS4) FT 4
- \$30 offset adjustment is created for Bill 4 and matched to \$30 bill segment (BS5) FT 5
- \$10 offset adjustment is created for Bill 4 and matched to \$10 bill segment (BS6) FT 6

Similarly, the transfer or offset adjustments are created when the bills are offset across accounts of the person and its hierarchy. The system distributes the amount from the credit bill starting with the oldest due date. For more information on how the offset amount is distributed, see [CI-OFST-DIST](#) on page 1560.

You can create a single offset request through the **Account Receivables Central** and **Offset Request** screens. For more information on how to create a single offset request, see [Creating an Offset Request](#) on page 1587.

Mass Offset

Mass offset means you can offset one or more credit bills against one or more debit bills and vice-versa in the same currency. Let us understand this with the help of an example.

The following table lists the bills of a customer which are available for mass offset:

Account	Bill	Due Date	Bill Segment	Contract Type Priority	Bill Segment Amount	Outstanding Bill Amount	Hold Amount
A11	Bill 1	01-15-2019	BS1	10	-\$50	-\$100	-
			BS2	20	-\$50		

Account	Bill	Due Date	Bill Segment	Contract Type Priority	Bill Segment Amount	Outstanding Bill Amount	Hold Amount
	Bill 2	01-20-2019	BS3	10	-\$50	-\$50	-
	Bill 3	01-18-2019	BS4	10	\$30	\$50	-
			BS5	10	\$20		
A12	Bill 4	01-21-2019	BS6	10	\$30	\$30	-
	Bill 5	01-25-2019	BS7	20	\$30	\$40	-
			BS8	30	\$10		
A13	Bill 6	01-29-2019	BS9	10	\$20	\$20	-

The system enables you to offset these bills through a mass offset request. While creating a mass offset request, you can add the Bill 1 as the primary bill. Once the offset request is created, you can add another credit bill (i.e. Bill 2) and the debit bills – Bill 3, Bill 4, Bill 5, and Bill 6. Note that you can only add completed bills to an offset request. The system then calculates the total credit and debit bill amount which is available for offsetting, as shown below:

Sum of credit bills' amount which is available for offsetting:

$$(-\$100 + (-\$50)) = (-\$100 - \$50) = -\$150$$

Sum of debit bills' amount which is available for offsetting:

$$(\$50 + \$30 + \$40 + \$20) = \$140$$

The system considers the credit or debit bills' total whichever is less as the default offset amount. In this case, the default offset amount is set to \$140. You can change the offset amount of a bill, if required. However, you need to ensure the following:

- Offset amount of the selected bill is not equal to zero
- Total debit offset amount is equal to total credit offset amount in the offset request
- Negative offset amount is specified for the debit bill and positive offset amount is specified for the credit bill
- Offset amount is less than or equal to the current outstanding amount of the bill

Note: If you add or remove a bill from the offset request after updating the offset amount, the system overrides the offset amount with the default offset amount. In such scenarios, you have to update the offset amount of the bills once again.

On submitting or approving a mass offset request, the system creates the transfer or offset adjustments using the adjustment type which is specified in the offset request. If the **Transfer Adjustment** option is selected in the respective offset request type, the system creates the transfer adjustments in the **Frozen** status.

The following table lists the transfer adjustments that are created during the mass offset with respect to the above example:

Transfer	Transfer Adjustments
1	<ul style="list-style-type: none"> • \$30 transfer adjustment is created for Bill 1 and matched to -\$50 bill segment cancellation (BS1) FT 1 • -\$30 transfer adjustment is created for Bill 3 and matched to \$30 bill segment (BS4) FT 4

Transfer	Transfer Adjustments
2	<ul style="list-style-type: none"> • \$20 transfer adjustment is created for Bill 1 and matched to -\$50 bill segment cancellation (BS1) FT 1 • -\$20 transfer adjustment is created for Bill 3 and matched to \$20 bill segment (BS5) FT 5
3	<ul style="list-style-type: none"> • \$30 transfer adjustment is created for Bill 1 and matched to -\$50 bill segment cancellation (BS2) FT 2 • -\$30 transfer adjustment is created for Bill 4 and matched to \$30 bill segment (BS6) FT 6
4	<ul style="list-style-type: none"> • \$20 transfer adjustment is created for Bill 1 and matched to -\$50 bill segment cancellation (BS2) FT 2 • -\$20 transfer adjustment is created for Bill 5 and matched to \$30 bill segment (BS7) FT 7
5	<ul style="list-style-type: none"> • \$10 transfer adjustment is created for Bill 2 and matched to -\$50 bill segment cancellation (BS3) FT 3 • -\$10 transfer adjustment is created for Bill 5 and matched to \$30 bill segment (BS7) FT 7
6	<ul style="list-style-type: none"> • \$10 transfer adjustment is created for Bill 2 and matched to -\$50 bill segment cancellation (BS3) FT 3 • -\$10 transfer adjustment is created for Bill 5 and matched to \$10 bill segment (BS8) FT 8
7	<ul style="list-style-type: none"> • \$20 transfer adjustment is created for Bill 2 and matched to -\$50 bill segment cancellation (BS3) FT 3 • -\$20 transfer adjustment is created for Bill 6 and matched to \$20 bill segment (BS9) FT 9

However, if the **Transfer Adjustment** option is not selected in the respective offset request type, the system creates the offset adjustments in the **Frozen** status. Considering the above example, the system will create the following offset adjustments for the offset request:

- \$50 offset adjustment is created for Bill 1 and matched to -\$50 Bill Segment Cancellation (BS1) FT 1
- \$50 offset adjustment is created for Bill 1 and matched to -\$50 Bill Segment Cancellation (BS2) FT 2
- \$40 offset adjustment is created for Bill 2 and matched to -\$50 Bill Segment Cancellation (BS3) FT 3
- -\$30 offset adjustment is created for Bill 3 and matched to \$30 bill segment (BS4) FT 4
- -\$20 offset adjustment is created for Bill 3 and matched to \$20 bill segment (BS5) FT 5
- -\$30 offset adjustment is created for Bill 4 and matched to \$30 bill segment (BS6) FT 6
- -\$30 offset adjustment is created for Bill 5 and matched to \$30 bill segment (BS7) FT 7
- -\$10 offset adjustment is created for Bill 5 and matched to \$10 bill segment (BS8) FT 8
- -\$20 offset adjustment is created for Bill 6 and matched to \$20 bill segment (BS9) FT 9

Similarly, the transfer or offset adjustments are created when the bills are offset across accounts of the person hierarchy. The system distributes the amount from the credit bill starting with the oldest due date. For more information on how the offset amount is distributed, see [CI-OFST-DIST](#) on page 1560.

You can create a mass offset request through the **Account Receivables Central** and **Offset Request** screens. For more information on how to create a mass offset request, see [Creating an Offset Request](#) on page 1587.

Cross Currency Offset

Cross currency offset means you can offset one credit bill against multiple debit bills and vice-versa in the different currencies. Let us understand this with the help of an example.

The following table lists the bills of a customer which are available for cross currency offset:

Account	Bill	Due Date	Bill Segment	Contract Type Priority	Bill Segment Amount	Outstanding Bill Amount	Hold Amount
A1	Bill 1	09-18-2018	BS1	10	-\$250	-\$250	-
	Bill 2	09-12-2018	BS2	10	€10	€30	-
			BS3	20	€20		
	Bill 3	09-22-2018	BS4	10	€50	€50	-
	Bill 4	09-28-2018	BS5	20	€30	€70	-
			BS6	30	€40		

The system enables you to offset these bills through a cross currency offset request. While creating a cross currency offset request, you can add the Bill 1 as the primary bill against which you can offset the debit bills – Bill 2, Bill 3, and Bill 4. Note that you can only add completed bills to an offset request. In a cross currency offset request, you can offset the bills which are in the currency different from the primary bill. For example, if you have added a primary bill with credit balance in USD, you can only add the debit bills in the currency other than USD. The system then calculates the total credit and debit bill amount which is available for offsetting, as shown below:

Sum of credit bills' amount which is available for offsetting:

-\$250

Sum of credit bills' amount which is available for offsetting (in offset currency):

-€227

Sum of debit bills' amount which is available for offsetting:

(30€+50€+70€) =€150

Sum of debit bills' amount which is available for offsetting (in offset currency):

\$33+\$55+\$77=\$165

The system considers the credit or debit bills' total (in the primary bill's currency) whichever is less as the default offset amount. In this case, the default offset amount is set to \$165. You can change the offset amount of a bill, if required. However, you need to ensure the following:

- Offset amount of the selected bill is not equal to zero
- Total debit offset amount is equal to total credit offset amount in the offset request
- Negative offset amount is specified for the debit bill and positive offset amount is specified for the credit bill
- Offset amount is less than or equal to the current outstanding amount of the bill

Note: If you add or remove a bill from the offset request after updating the offset amount, the system overrides the offset amount with the default offset amount. In such scenarios, you have to update the offset amount of the bills once again.

On submitting or approving a cross currency offset request, the system creates the transfer or offset adjustments using the adjustment type which is specified in the offset request. If the **Transfer Adjustment** option is selected in the respective offset request type, the system creates the transfer adjustments in the **Frozen** status.

The following table lists the transfer adjustments that are created during the cross currency offset with respect to the above example:

Transfer	Transfer Adjustments
1	<ul style="list-style-type: none"> \$11 transfer adjustment is created for Bill 1 and matched to -\$250 bill segment cancellation (BS1) FT 1 -€10 transfer adjustment is created for Bill 2 and matched to €10 bill segment (BS2) FT 2
2	<ul style="list-style-type: none"> \$22 transfer adjustment is created for Bill 1 and matched to -\$250 bill segment cancellation (BS1) FT 1 -€20 transfer adjustment is created for Bill 2 and matched to €20 bill segment (BS3) FT 3
3	<ul style="list-style-type: none"> \$55 transfer adjustment is created for Bill 1 and matched to -\$250 bill segment cancellation (BS1) FT 1 -€50 transfer adjustment is created for Bill 3 and matched to €50 bill segment (BS4) FT 4
4	<ul style="list-style-type: none"> \$33 transfer adjustment is created for Bill 1 and matched to -\$250 bill segment cancellation (BS1) FT 1 -€30 transfer adjustment is created for Bill 4 and matched to €30 bill segment (BS5) FT 5
5	<ul style="list-style-type: none"> \$44 transfer adjustment is created for Bill 1 and matched to -\$250 bill segment cancellation (BS1) FT 1 -€40 transfer adjustment is created for Bill 4 and matched to €40 bill segment (BS6) FT 6

However, if the **Transfer Adjustment** option is not selected in the respective offset request type, the system creates the offset adjustments in the **Frozen** status. Considering the above example, the system will create the following offset adjustments for the offset request:

- \$165 offset adjustment is created for Bill 1 and matched to -\$250 Bill Segment Cancellation (BS1) FT 1
- €10 offset adjustment is created for Bill 2 and matched to €10 bill segment (BS2) FT 2
- €20 offset adjustment is created for Bill 2 and matched to €20 bill segment (BS3) FT 3
- €50 offset adjustment is created for Bill 3 and matched to €50 bill segment (BS4) FT 4
- €30 offset adjustment is created for Bill 4 and matched to €30 bill segment (BS5) FT 5
- €40 offset adjustment is created for Bill 4 and matched to €40 bill segment (BS6) FT 6

Similarly, the transfer or offset adjustments are created when the bills are offset across accounts of the person and its hierarchy. The system distributes the amount from the credit bill starting with the oldest due date. For more information on how the offset amount is distributed, see [CI-OFST-DIST](#) on page 1560.

To use the cross currency offset request feature, you need to do the following:

- Define the required exchange rates in the system.
- Define a currency conversion algorithm for bill segments using the **C1_CURALGBS** or **C1_EXCRTBS** algorithm type and attach it to the **Currency Conversion For Bill Segments** algorithm spot of the required divisions.

- Define a currency conversion algorithm for adjustments using the **C1_CURALGAD** or **C1_EXCRTAD** algorithm type and attach it to the **Currency Conversion For Adjustments** algorithm spot of the required divisions.

You can create a cross currency offset request through the **Account Receivables Central** and **Offset Request** screens. For more information on how to create a cross currency offset request, see [Creating an Offset Request](#) on page 1587.

Prerequisites

To setup the offset request feature, you need to do the following:

- Define the required offset adjustment types where the **A/P Request Type Code** field is not set to **REFUND**.
- Define a default offset amount algorithm using the **C1-OFST-AMT** algorithm type.
- Assign the **C1-OFSRQ** To Do type to a To Do role whose users must receive a To Do while submitting an offset request for approval.
- Assign the **C1-OFSSB** To Do type to a To Do role whose users must not approve an offset request.
- Define the required offset request types in the system.
- Define the required characteristic types where the characteristic entity is set to **Offset Request Type**.
- Define the required characteristic types where the characteristic entity is set to **Offset Request**.
- Define the values for the **CAN_RSN_CD_FLG** lookup field.
- Set the parameters of the **C1-UPD-FUND**, **C1-DFRUNAPLY**, **C1-WTBS-CRBL**, and **C1-OFST-DIST** algorithms.
- Define the status reasons for the **Rejected** and **Unapplied Offset** statuses of the **C1-OffsetRequest** business object in the **Status Reason** screen.
- Set the **Allow Offsetting Across Persons** option type of the **C1-OFFSETREQ** feature configuration.
- Define the required exchange rates in the system.
- Define a currency conversion algorithm for bill segments using the **C1_CURALGBS** or **C1_EXCRTBS** algorithm type.
- Attach a currency conversion algorithm to the **Currency Conversion For Bill Segments** algorithm spot of the required divisions.
- Define a currency conversion algorithm for adjustments using the **C1_CURALGAD** or **C1_EXCRTAD** algorithm type.
- Attach a currency conversion algorithm to the **Currency Conversion For Adjustments** algorithm spot of the required divisions.
- Set the batch control type of the **Offset Request Periodic Monitor (C1-OFSRQ)** batch to **Timed** and define the following attributes:
 - Time Interval
 - Timer Active
 - User ID
 - Batch Language
 - Email Address

For more information about the **Offset Request Periodic Monitor (C1-OFSRQ)** batch, see *Oracle Revenue Management and Billing Batch Guide*.

Related Topics

For more information on...	See...
How to setup the C1-OFFSETREQ feature configuration	Setting the C1-OFFSETREQ Feature Configuration on page 4335
C1-OFST-AMT algorithm	C1-OFST-AMT on page 1563
C1-UPD-FUND algorithm	C1-UPD-FUND on page 1562
C1-DFRUNAPLY algorithm	C1-DFRUNAPLY on page 1562
C1-WTBS-CRBL algorithm	C1-WTBS-CRBL on page 1562
C1-OFST-DIST algorithm	C1-OFST-DIST on page 1560
C1_CURALGBS algorithm	C1_CURALGBS on page 949
C1_EXCRTBS algorithm	C1_EXCRTBS on page 957
C1_CURALGAD algorithm	C1_CURALGAD on page 951
C1_EXCRTAD algorithm	C1_EXCRTAD on page 958

Offset Request (Without Approval) Status Transition

The following figure graphically indicates how an offset request moves from one status to another when the approval process is not configured in the offset request type:

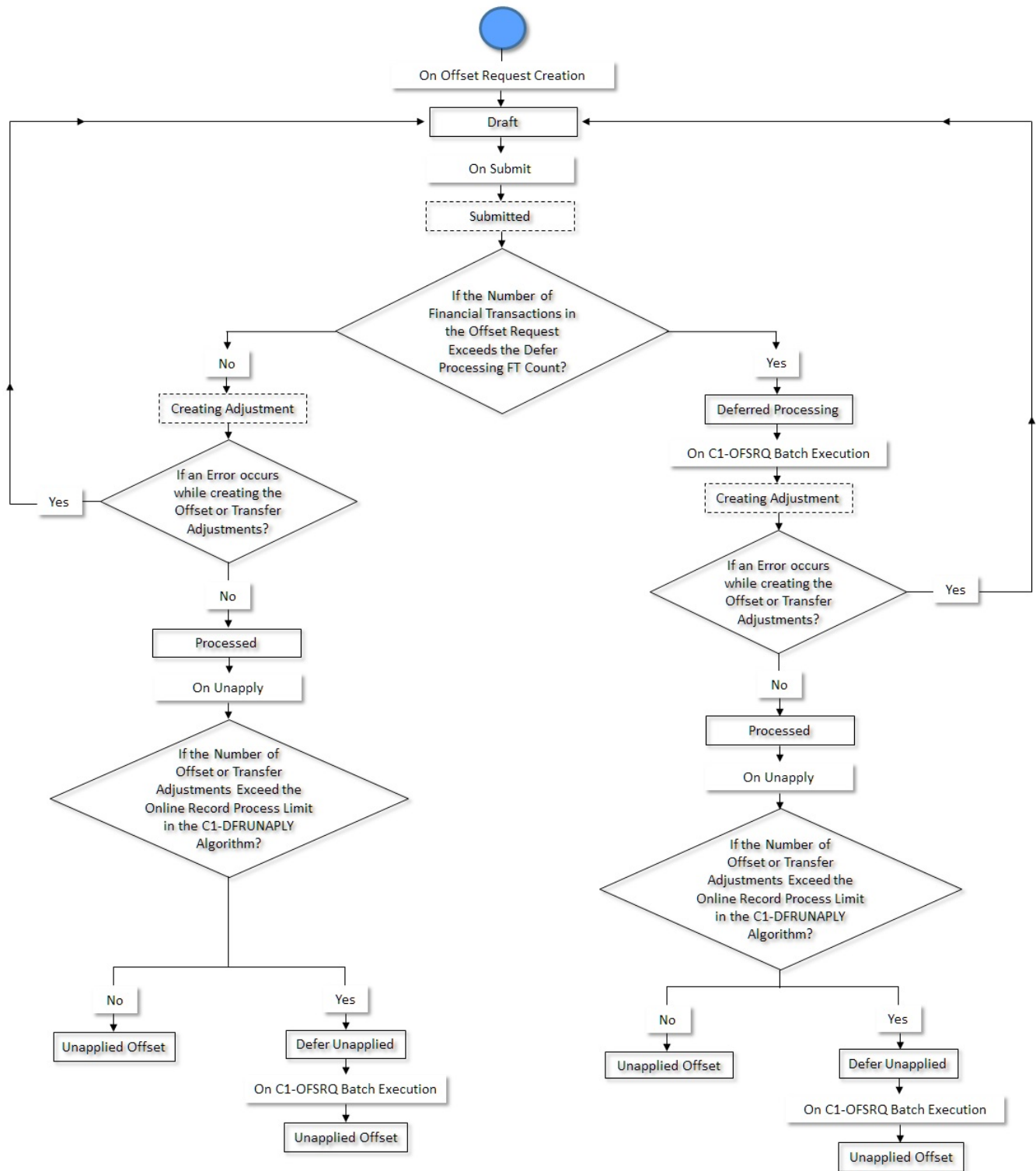

Offset Request (With Approval) Status Transition

The following figure graphically indicates how an offset request moves from one status to another when the approval process is configured in the offset request type:

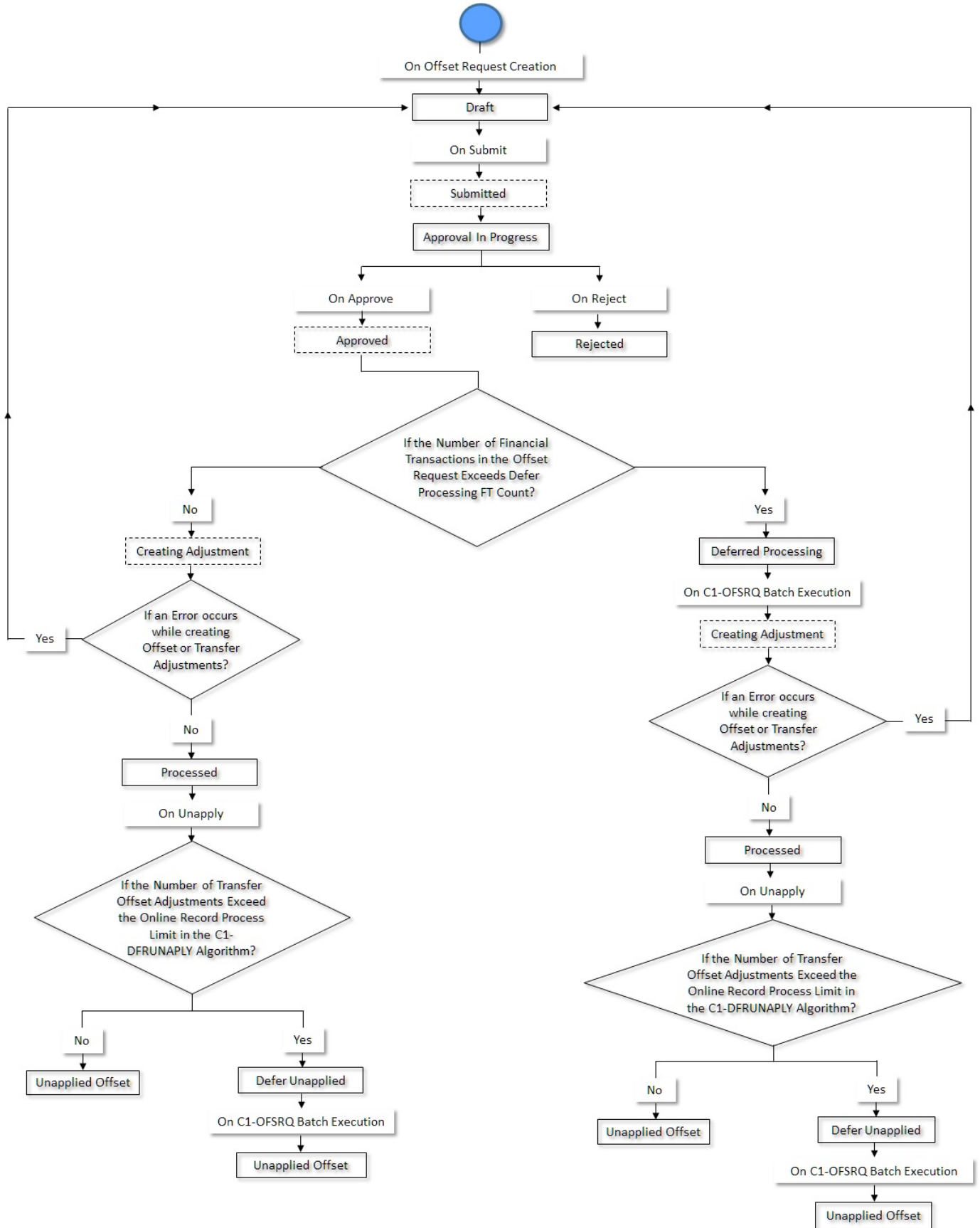

Bill Line Items Level Offset

Until now, while offsetting two or more bills through an offset request, the system did not allow to consider a debit bill with a credit line item as a credit bill while offsetting. In addition, the system did not allow to add a bill with zero balance having debit and credit line items in an offset request.

Now, a new option named **Bill Line Items Level Offset** is available while defining an offset request type. If you select the **Bill Line Items Level Offset** option in an offset request type, the system allows you to do the following:

- Consider a debit bill with a credit line item as a credit bill while offsetting through an offset request
- Add a bill with zero balance having debit and credit line items in an offset request

For example, if you include a debit bill (BILL1) with the following line items in an offset request which is created using an offset request type where the **Bill Line Items Level Offset** option is selected:

Bill Line Item	Amount
BS1	100\$
BS2	100\$
BS3	200\$
AD1	-200\$

The system allows you add BILL1 as a credit bill in the offset request. Earlier, the system used to internally offset the bill and the outstanding bill amount was then available for offsetting with another bills in an offset request. Now, if you consider a debit bill with a credit line item as a credit bill for offsetting in an offset request, the system will not internally offset the bill and the credit line items would be available for offsetting with another bills in the offset request. However, if you do not consider a debit bill with a credit line item as a credit bill for offsetting in an offset request, the system will first internally offset the bill and then outstanding amount would be available for offsetting against another bills in the offset request.

If you select the **Bill Line Items Level Offset** option in an offset request type, you need to ensure that **Match Type Entity (Valid Values: BILL, BSEG, SA)** parameter in the **C1-OFST-DIST** algorithm (which is attached to the **Creating Adjustment** status in the lifecycle of the **C1-OffsetRequest** business object) is set to **BSEG**. Otherwise, erroneous results might occur.

If you create an offset request using an offset request type where the **Bill Line Items Level Offset** option is selected, then:

- The following columns are additionally available in the **Offset Details** section while editing the offset request:
 - **Debit Balance** – Displays the sum of the unpaid debit line items of a bill
 - **Credit Balance** – Displays the sum of the open credit line items of a bill
 - **Credit Bill** – Used to indicate whether you want to consider a debit bill with a credit line item as a credit bill in the offset request. By default, this option is selected for a bill with the credit or zero balance and it is not editable. Note that you cannot select this option for a debit bill which no credit line item and therefore, in such case, this option is disabled.
- The default offset amount is set either to the sum of open credit balance of all credit bills in the offset request or to the sum of outstanding amount of all debit bills in the offset request whichever is less. While editing the offset amount, the system validates the following:
 - Offset amount is not greater than the outstanding amount of the debit bill
 - Offset amount is not greater than the open credit balance of the credit bill

- The **Debit Balance**, **Credit Balance**, and **Credit Bill** columns appear in the **Selected Bills** zone of the **Offset Request** screen.

As mentioned earlier, the system now allows you to add a bill with zero balance having debit and credit line items in an offset request. You can add a bill with zero balance from the following screens:

- Offset Request
- Account Receivable Central

While creating an offset request for a zero balance bill from the **Account Receivable Central** screen or while adding a zero balance bill to an offset request, the system validates the following:

- The **Bill Line Items Level Offset** option is selected the respective offset request type.
- The selected bill with zero balance is not fully matched.

We recommend you to add maximum 4 to 5 bills while offsetting the bills through an offset request using the **Bill Line Items Level Offset** feature.

Internal Offsetting of Zero Balance Bill

Oracle Revenue Management and Billing provides a new option type named **Avoid internal match event creation for zero dollar bill** in the **C1_FINTRANOP** feature configuration. You can set the value of this option type to:

- **Y** – Used when you do not want the system to internally match the debit and credit line items of a zero balance bill on the bill completion.
- **N** – Used when you want the system to internally match the debit and credit line items of a zero balance bill on the bill completion.

If you want to consider a zero balance bill for offsetting against another bills in an offset request, you should set the **Avoid internal match event creation for zero dollar bill** option type of the **C1_FINTRANOP** feature configuration to **Y**.

Algorithms Used in C1-OffsetRequest

The following table lists the algorithm which is attached to the **C1-OffsetRequest** business object:

System Event	Algorithm	Algorithm Type	Description
Information	C1-OFFST-INF	C1-OFFST-INF	Refer to C1-OFFST-INF on page 1559.

The following table lists the algorithms which are used in the lifecycle of the **C1-OffsetRequest** business object:

Status	System Event	Algorithm	Algorithm Type	Description
Draft	Exit	F1-TODOCOMPL	F1-TODOCOMPL	Refer to F1-TODOCOMPL on page 1453.
Submitted	Enter	C1-OFFSUBENT	C1-OFFSUBENT	Refer to C1-OFFSUBENT on page 1559.
Approval In Progress	Enter	C1-OFFAPPENT	C1-OFFAPPENT	Refer to C1-OFFAPPENT on page 1560.
	Exit	C1-OFFAPPEXT	C1-OFFAPPEXT	Refer to C1-OFFAPPEXT on page 1560.

Status	System Event	Algorithm	Algorithm Type	Description
	Exit	F1-TODOCOMPL	F1-TODOCOMPL	Refer to F1-TODOCOMPL on page 1453.
Approved	Enter	C1-OFSAPRENT	C1-OFSAPRENT	Refer to C1-OFSAPRENT on page 1560.
Rejected	-	-	-	-
Deferred Processing	Monitor	F1-AT-RQJ	F1-GEN-BOMNJ	Refer to F1-AT-RQJ on page 1560.
Creating Adjustment	Monitor	F1-AT-RQJ	F1-GEN-BOMNJ	Refer to F1-AT-RQJ on page 1560.
	Enter	C1-OFST-DIST	C1-OFST-DIST	Refer to C1-OFST-DIST on page 1560.
	Enter	C1-UPD-HOLD	C1-UPD-HOLD	Refer to C1-UPD-HOLD on page 1561.
	Enter	C1-UPD-FUND	C1-UPD-FUND	Refer to C1-UPD-FUND on page 1562.
Processed	-	-	-	-
Defer Unapplied	Monitor	F1-AT-RQJ	F1-GEN-BOMNJ	Refer to F1-AT-RQJ on page 1560.
	Enter	C1-DFRUNAPLY	C1-DFRUNAPLY	Refer to C1-DFRUNAPLY on page 1562.
Unapplied Offset	Enter	C1-UNAPOFST	C1-UNAPOFST	Refer to C1-UNAPOFST on page 1562.
	Enter	C1-UPDT-FUND	C1-UPDT-FUND	Refer to C1-UPDT-FUND on page 1562.

C1-OFFST-INF

This algorithm generates the offset request information string which appears throughout the application. It concatenates the following fields separated by a comma in the specified order:

1. Offset Request Type Description
2. Offset Request Status Description
3. Offset Request ID

F1-TODOCOMPL

This algorithm type completes the To Do entries that are linked to an object when the object exits the given status.

It finds and completes all open To Do entries where the business object's primary key is defined as a drill key. However, if the **Exclude To Do Entries From Auto Completion** characteristic is set to **Y** for the business object, the system does not automatically complete the respective To Do entry.

C1-OFFSUBENT

This algorithm is invoked when you click the **Submit** button. It validates the following:

- Whether the outstanding amount of the selected bills is not zero
- Whether the selected bills are in the **Complete** status
- Whether the overridden offset amount of a bill is not zero
- Whether the sum of the debit bills' offset amount is equal to the sum of the credit bills' offset amount
- Whether at least one debit and credit bills are selected in the offset request

If the validation is successful, it checks whether the **Approval Required** option is selected in the respective offset request type. If the **Approval Required** option is selected in the respective offset request type, it changes the status of the offset request to **Approval In Progress**. However, if the **Approval Required** option is not selected in the respective offset request type, it checks whether the number of financial transactions created for the bills, which are selected in the offset request, exceeds the defer processing count. If the number of financial transactions does not exceed the defer processing count, the system changes the status of the offset request to **Creating Adjustment**. However, if the number of financial transactions exceeds the defer processing count, the system changes the status of the offset request to **Deferred Processing**.

C1-OFFAPPENT

This algorithm is invoked when the status of the offset request is changed to **Approval In Progress**. It creates a To Do using the approval To Do type which is specified in the respective offset request type. Once a To Do is created, it is assigned to all users with the approval To Do role which is specified in the respective offset request type. In addition, it creates a log entry for the offset request when the To Do is created.

C1-OFFAPPEXT

This algorithm checks whether the approver is associated with the approval To Do role which is specified in the respective offset request type. If so, it allows the approver to approve or reject the offset request. It also ensures that the submitter does not approve or reject the offset request.

C1-OFSAPRENT

This algorithm is invoked when you click the **Approve** button. It checks whether the number of financial transactions created for the bills, which are selected in the offset request, exceeds the defer processing count. If the number of financial transactions does not exceed the defer processing count, the system changes the status of the offset request to **Creating Adjustment**. However, if the number of financial transactions exceeds the defer processing count, the system changes the status of the offset request to **Deferred Processing**.

F1-AT-RQJ

This algorithm transitions the current status of the business object to the specified status. It contains the following parameters:

- **Next Status** – Used when you want to override the default next status specified in the lifecycle.
- **Next Transition Condition** – Used when you want to override the default next transition condition specified in the lifecycle.

At a time, you can specify value for either the **Next Status** or **Next Transition Condition** parameter. If you don't specify any value for these parameters, the system will transition the business object to the default next status specified in its lifecycle.

C1-OFST-DIST

This algorithm is invoked when the status of the offset request is changed to **Creating Adjustment**. It creates offset adjustments using the adjustment type specified in the offset request and sets the status of the offset adjustments to **Frozen**. If the **Transfer Adjustment** option is selected in the respective offset request type, it creates transfer adjustments in the **Frozen** status.

This algorithm distributes the offset amount of a bill in the following manner:

1. **Internal Offsetting Within Each Bill** - This happens when a bill contains both debit and credit line items. The internal offsetting happens either at the bill segment or contract level depending on the value specified in the **Match Type Entity (Valid Values: BILL, BSEG, SA)** parameter. If the **Match Type Entity (Valid Values: BILL, BSEG, SA)** parameter is set to **BILL** or **SA**, the internal offsetting happens at the contract level. However, if the **Match Type Entity (Valid Values: BILL, BSEG, SA)** parameter is set to **BSEG**, the internal offsetting happens at the bill segment level. In the bill, the internal offsetting is done starting from a credit contract with highest payment priority against a debit contract with highest payment priority by creating transfer adjustments. This continues until the sum of credit or debit amount within a bill is exhausted.
2. **Offsetting Across Debit and Credit Bills** - This offsetting is always done from the credit bills to the debit bills with the objective to reduce the debit bill balance. This algorithm checks whether any match event is created for the bill. If so, it creates the offset adjustments against the bill using the existing match event. If there are no match events created for the bill, this algorithm creates match events using the value specified in the **Match Type Entity (Valid Values: BILL, BSEG, SA)** parameter. It distributes the amount from the credit bill starting with the oldest due date. This continues until the credit bill balance is exhausted.

It contains the following parameters:

- **Match Type** - Used to specify the match type using which you want to distribute the offset amount. You must specify a match type where the payment distribution override algorithm is attached.

Note: If a bill which is offset is partially paid using a match type, this algorithm uses the same match type for offset distribution. However, if no payment is received for a bill which is offset, this algorithm uses the match type which is specified in the **Match Type** parameter for offset distribution.

- **Match Type Entity (Valid Values: BILL, BSEG, SA)** - Used to indicate the entity, such as bill, bill segment, or contract, against which you want to create match event. It is used to create match events for bills which are unpaid. The valid values are:
 - **BILL** - Used when you want to stamp same match event on all financial transactions of the bill.
 - **BSEG** - Used when you want to stamp unique match event on each bill segment or adjustment financial transaction.
 - **SA** - Used when you want to stamp same match event on all financial transactions which are created for the same contract.
- **Credit Bill Distribution Algorithm** - Used to specify an algorithm which helps to create offset adjustments for a credit bill at the bill segment level. This parameter is required when the **Transfer Adjustment** option is not selected in the respective offset request type.

Note: The **C1-WTBS-CRBL** algorithm type is shipped with the product. You can attach an algorithm created using the **C1-WTBS-CRBL** algorithm type to the **Credit Bill Distribution Algorithm** parameter. For more information, see [C1-WTBS-CRBL](#) on page 1562.

C1-UPD-HOLD

This algorithm updates the hold request whenever a bill on hold is offset through an offset request. If the remaining outstanding amount of a bill after offsetting is not zero and is less than the current hold amount, this algorithm updates the hold amount to the current hold amount plus remaining outstanding bill balance. For example, if the original outstanding amount is 80\$, hold amount is 40\$, offset amount is 20\$, then the remaining outstanding amount (i.e. $80\$ - 40\$ - 20\$ = 20\$$) is less than the current hold amount (i.e. 40\$). Therefore, this algorithm updates the hold amount of the bill in the hold request to 60\$ (i.e. $40\$ + 20\$$).

However, if the remaining outstanding amount of a bill after offsetting is zero and the bill is included in any active hold request, the hold end date of the bill in the hold request is changed to the system date.

In both the above scenarios, this algorithm creates a log entry for the offset and hold requests. The bill whose hold details (i.e. either hold amount or hold end date) are updated through the offset request is maintained in its log. Similarly, the old and updated hold amount and hold end date of the bill are maintained in the respective hold request log.

C1-UPD-FUND

If a bill which is offset through an offset request is present in a funding request which is in the **Draft** status, this algorithm updates the funding amount of the bill in the funding request. If entire sum of the funding and garnishment amount of a bill is offset through the offset request, the bill is excluded from the funding request.

It contains the following parameter:

- **Funding Exclusion Reason Code** - Used to indicate the reason why you want to exclude the bill from the funding request. This parameter is mandatory while excluding a bill from a funding request. You must specify a value which is already defined in the **CAN_RSN_CD_FLG** lookup field.

C1-DFRUNAPLY

This algorithm is invoked when you click the **Unapply** button. It checks whether the number of transfer or offset adjustments created through the offset request exceeds the online record process limit defined in this algorithm. If the number of transfer or offset adjustments does not exceed the online record process limit, the system cancels the frozen transfer or offset adjustments immediately and then changes the status of the offset request to **Unapplied Offset**. However, if the number of transfer or offset adjustments exceeds the online record process limit, the system changes the status of the offset request to **Defer Unapplied**.

It contains the following parameter:

- **Online Record Process Limit** - Used to indicate the maximum number of transfer or offset adjustments you can process in the real time (i.e. immediately).

C1-UNAPOFST

This algorithm is invoked when the **Offset Request Periodic Monitor (C1-OFSRQ)** batch is executed. It cancels all transfer or offset adjustments created through the offset request and then changes the status of the offset request to **Unapplied Offset**.

C1-UPDT-FUND

Once the transfer or offset adjustments of a bill are canceled, it checks whether the bill is included in any funding request which is in the **Draft** status. If so, it updates the funding amount of the bill in the respective funding request.

C1-WTBS-CRBL

THIS ALGORITHM IS ONLY USED IF YOU PRACTICE OPEN-ITEM ACCOUNTING AND THE ACCOUNT'S CUSTOMER CLASS INDICATES OPEN-ITEM ACCOUNTING IS PRACTICED.

This algorithm is used to offset the bill segments of a credit bill. It considers the bill segments of a credit bill for offsetting based on the following parameter:

- **Bill Segment Date Type** – Used to indicate whether the system should consider the bill segments of a credit bill based on the freeze date or coverage start date. The valid values are:
 - **F** – Used when you want to consider the bill segments of a credit bill based on the order of the freeze date.
 - **C** – Used when you want to consider the bill segments of a credit bill based on the order of the coverage start date. Note that you can use this option when the coverage start date is stamped corresponding to the financial transactions in the **C1_FT_EXT** table.

It creates a unique match event for each bill segment and adjustment financial transaction.

Additional Algorithms Used in Offset Request

Besides using the algorithms attached to the lifecycle, the system uses the following algorithms for the **Offset Request** feature:

- [C1-OFST-AMT](#) on page 1563
- [C1-WTBS-CRBL](#) on page 1562

C1-OFST-AMT

This algorithm calculates the default offset amount whenever a bill is added to the offset request. The default offset amount is equal to the sum of outstanding amount of the debit or credit bills whichever is less. For example, if the following bills are added to the offset request:

- Bill 1 (-100\$) where due date is set to 01-01-2018
- Bill 2 (-100\$) where due date is set to 01-01-2019
- Bill 3 (25\$) where due date is set to 01-01-2018
- Bill 4 (25\$) where due date is set to 06-01-2018

In such case, the system sets the default offset amount of Bill 1 to 50\$.

Note: This algorithm does not calculate the default offset amount until both the debit and credit bills are added to the offset request.

C1-WTBS-CRBL

THIS ALGORITHM IS ONLY USED IF YOU PRACTICE OPEN-ITEM ACCOUNTING AND THE ACCOUNT'S CUSTOMER CLASS INDICATES OPEN-ITEM ACCOUNTING IS PRACTICED.

This algorithm is used to offset the bill segments of a credit bill. It considers the bill segments of a credit bill for offsetting based on the following parameter:

- **Bill Segment Date Type** – Used to indicate whether the system should consider the bill segments of a credit bill based on the freeze date or coverage start date. The valid values are:
 - **F** – Used when you want to consider the bill segments of a credit bill based on the order of the freeze date.
 - **C** – Used when you want to consider the bill segments of a credit bill based on the order of the coverage start date. Note that you can use this option when the coverage start date is stamped corresponding to the financial transactions in the **C1_FT_EXT** table.

It creates a unique match event for each bill segment and adjustment financial transaction.

Offset Request Type

Oracle Revenue Management and Billing allows you to define an offset request type using which you can create an offset request. It is the offset request type which helps the system to determine the following:

- The business object using which the offset request should be created in the system.
- The default adjustment type using which the transfer or offset adjustments should be created in the system.
- The algorithm which helps to calculate default offset amount when a bill is added to the offset request.
- Whether approval is required while offsetting bills through an offset request.
- Whether an offset request must be processed in the deferred mode or in real time (i.e. immediately)
- The maximum search period (in days) that you want to allow while searching bills in an offset request.
- Whether transfer or offset adjustments should be created while offsetting bills through an offset request.
- Whether a debit bill with credit line item as a credit bill should be created in an offset request

The **Offset Request Type** screen allows you to define, edit, delete, and copy an offset request type. It contains the following zones:

- [Offset Request Type List](#) on page 1564
- [Offset Request Type](#) on page 1564

Offset Request Type List

The **Offset Request Type List** zone lists the offset request types that are already defined in the system. It contains the following columns:

Column Name	Column Description
Offset Request Type	Displays the offset request type.
Description	Displays the description of the offset request type.
Edit	On clicking the Edit (✎) icon, the Offset Request Type screen appears where you can edit the details of the offset request type.
Duplicate	On clicking the Duplicate (📄) icon, the Offset Request Type screen appears where you can define a new offset request type using an existing offset request type.
Delete	On clicking the Delete (🗑) icon, you can delete the offset request type. Note: You can delete an offset request type when an offset request is not created using the offset request type.

On clicking the **Broadcast** (📡) icon corresponding to an offset request type, the **Offset Request Type** zone appears with the details of the respective offset request type.

Related Topics

For more information on...	See...
How to edit an offset request type	Editing an Offset Request Type on page 1572
How to copy an offset request type	Copying an Offset Request Type on page 1577
How to delete an offset request type	Deleting an Offset Request Type on page 1577
How to view the details of an offset request type	Viewing the Offset Request Type Details on page 1582

Offset Request Type

The **Offset Request Type** zone displays the details of the offset request type. It contains the following sections:

- **Main** - Displays basic information about the offset request type. It contains the following fields:

Field Name	Field Description
Offset Request Type	Displays the offset request type.
Description	Displays the description of the offset request type.
Offset Request Business Object	Indicates the business object using which an offset request should be created. In addition, a context menu appears corresponding to this field which helps in navigating to other screens in the application. Note: It has a link. On clicking the link, the Business Object screen appears where you can view the details of the respective business object.
Detailed Description	Displays additional information about the offset request type.

Field Name	Field Description
Status	<p>Indicates the status of the offset request type. The valid values are:</p> <ul style="list-style-type: none"> • Active • Inactive
Adjustment Type	<p>Indicates the adjustment type using which the transfer or offset adjustments should be created.</p> <p>Note: It has a link. On clicking the link, the Adjustment Type screen appears where you can view the details of the respective adjustment type.</p>
Default Offset Amount Algorithm	<p>Indicates the algorithm using which the default offset amount should be calculated while adding a bill in an offset request.</p> <p>Note: It has a link. On clicking the link, the Algorithm screen appears where you can view the details of the respective algorithm.</p>
Defer Processing Count	<p>Displays the count which helps to determine whether an offset request must be processed in the deferred mode (i.e. in the background) or in real time (i.e. immediately).</p>
Approval Required	<p>Indicates whether approval is required while offsetting bills through an offset request.</p>
Approval To Do Type	<p>Indicates that the To Do entry of the specified To Do type must be created when an offset request is submitted for approval.</p> <p>Note:</p> <p>It has a link. On clicking the link, the To Do Type screen appears where you can view the details of the respective To Do Type.</p> <p>This field appears when the Approval Required option is selected.</p>
Approval To Do Role	<p>Indicates that users with the specified To Do role can only approve an offset request which is submitted for approval.</p> <p>Note:</p> <p>It has a link. On clicking the link, the To Do Role screen appears where you can view the details of the respective To Do Role.</p> <p>This field appears when the Approval Required option is selected.</p>
Submitter To Do Type	<p>Indicates the submitter To Do type. At present, the submitter To Do type is not used to create To Do entry when the approver rejects an offset request. It is only used to fetch the roles associated with the submitter To Do type while defining or editing the offset request type.</p> <p>Note: It has a link. On clicking the link, the To Do Type screen appears where you can view the details of the respective To Do type.</p>
Submitter To Do Role	<p>Indicates that users with the specified To Do role cannot approve an offset request which is submitted for approval.</p>

Field Name	Field Description
	Note: It has a link. On clicking the link, the To Do Role screen appears where you can view the details of the respective To Do role.
Bill Search Period	Displays the maximum search period (in days) which is allowed while searching bills in an offset request.
Transfer Adjustment	Indicates whether transfer adjustments should be created while offsetting bills through an offset request.
Bill Line Items Level Offset	Indicates the following: <ul style="list-style-type: none"> Whether a debit bill with a credit line item as a credit bill should be considered while offsetting through an offset request Whether a bill with zero balance having debit and credit line items should be created in an offset request

- **Characteristics** - Lists the characteristics defined for the offset request type. It contains the following columns:

Column Name	Column Description
Characteristic Type	Indicates the characteristic type.
Characteristic Value	Displays the value of the characteristic type.

- **Record Actions** - This section contains the following buttons:

Button Name	Button Description
Edit	Used to edit the details of the offset request type.
Delete	Used to delete the offset request type.
	Note: You can delete an offset request type when an offset request is not created using the offset request type.
Duplicate	Used to create a new offset request type using an existing offset request type.

- **Record Information** - This section contains the following field:

Field Name	Field Description
Business Object	Indicates the business object using which the offset request type is created. In addition, a context menu appears corresponding to this field which helps in navigating to other screens in the application. <p>Note: It has a link. On clicking the link, the Business Object screen appears where you can view the details of the respective business object.</p>

By default, the **Offset Request Type** zone does not appear in the **Offset Request Type** screen. It appears when you click the **Broadcast** () icon corresponding to an offset request type in the **Offset Request Type List** zone.

Related Topics

For more information on...	See...
How to edit an offset request type	Editing an Offset Request Type on page 1572

For more information on...	See...
How to copy an offset request type	Copying an Offset Request Type on page 1577
How to delete an offset request type	Deleting an Offset Request Type on page 1577
How to view the details of an offset request type	Viewing the Offset Request Type Details on page 1582

Defining an Offset Request Type

Prerequisites

To define an offset request type, you should have:

- Offset request type business objects defined in the application
- Offset request business objects defined in the application
- Adjustment types defined in the application (where the **A/P Request Type Code** field is not set to **REFUND**)
- Default offset amount algorithm defined using the **C1-OFST-AMT** algorithm type
- Required To Do role assigned to the **C1-OFSRQ** and **C1-OFSSB** To Do types in the application
- Required match type entity specified in the **Match Type Entity (Valid Values: BILL, BSEG, SA)** parameter of the **C1-OFST-DIST** algorithm

Procedure

To define an offset request type:

1. Click the **Admin** link in the **Application** toolbar.
A list appears.
2. From the **Admin** menu, select **O** and then click **Offset Request Type**.
A sub-menu appears.
3. Click the **Add** option from the **Offset Request Type** sub-menu.

The **Offset Request Type** screen appears. It contains the following sections:

- **Main** - Used to specify basic details about the offset request type.
- **Characteristics** - Used to define the characteristics for the offset request type.

The **Main** section contains the following fields:

Field Name	Field Description	Mandatory (Yes or No)
Offset Request Type	Used to specify the offset request type.	Yes
Business Object	Indicates the business object using which you are defining the offset request type.	Not applicable
Description	Used to specify the description for the offset request type.	Yes
Offset Request Business Object	Used to indicate the business object using which you want to create the respective offset request.	Yes
Detailed Description	Used to specify additional information about the offset request type.	No

Field Name	Field Description	Mandatory (Yes or No)
Status	<p>Used to indicate the status of the offset request type. The valid values are:</p> <ul style="list-style-type: none"> • Active • Inactive <p>Note: You cannot change the status of an offset request type to Inactive when the corresponding offset request is in a status other than Processed, Rejected, or Unapplied Offset.</p>	Yes
Adjustment Type	<p>Used to indicate the adjustment type using which transfer or offset adjustments should be created. By default, the specified adjustment type appears when you create an offset request. You can then change the adjustment type, if required, while editing an offset request.</p> <p>Note:</p> <p>The Search (🔍) icon appears corresponding to the Adjustment Type field. On clicking the Search icon, the Adjustment Type Search window appears.</p> <p>On specifying the adjustment type, the description of the adjustment type appears corresponding to the Adjustment Type field.</p> <p>You can only specify an adjustment type where the A/P Request Type Code field is not set to REFUND.</p>	Yes
Default Offset Amount Algorithm	<p>Used to attach an algorithm using which you want to calculate default offset amount while adding a bill in an offset request.</p> <p>Note:</p> <p>The Search (🔍) icon appears corresponding to the Default Offset Amount Algorithm field. On clicking the Search icon, the Algorithm Search window appears.</p> <p>On specifying the algorithm, the description of the algorithm appears corresponding to the Default Offset Amount Algorithm field.</p> <p>You must specify an algorithm which is created using the C1-OFST-AMT algorithm type in the Default Offset Amount Algorithm field.</p>	Yes
Defer Processing FT Count	<p>Used to indicate whether an offset request must be processed in the deferred mode or in real time (i.e. immediately). If the number of financial transactions created for the bills which are selected in the offset request exceeds the defer processing count, the system will process the offset request in the deferred mode. However, if the number of financial transactions created for the bills which are selected in the offset request does not exceed the defer processing count,</p>	No

Field Name	Field Description	Mandatory (Yes or No)
	<p>the system will process the offset request in real time (i.e. immediately).</p> <p>Note: You cannot specify a negative value in this field.</p> <p>Deferred mode means in the background when the Offset Request Periodic Monitor (C1-OFSRQ) batch is invoked. You can configure the Offset Request Periodic Monitor (C1-OFSRQ) batch such that it is executed at regular intervals. For more information about the Offset Request Periodic Monitor (C1-OFSRQ) batch, refer to <i>Oracle Revenue Management and Billing Batch Guide</i>.</p> <p>If you set the defer processing count to zero (0), the system resets the default value to 50.</p>	
Approval Required	Used to indicate whether approval is required while offsetting bills through an offset request.	No
Approval To Do Type	<p>Used to indicate that To Do entry of the specified To Do type must be created when you submit an offset request for approval.</p> <p>Note: The Search (🔍) icon appears corresponding to the Approval To Do Type field. On clicking the Search icon, the To Do Type Search window appears.</p> <p>On specifying the To Do type, the description of the To Do type appears corresponding to the Approval To Do Type field.</p> <p>This field appears when the Approval Required option is selected.</p> <p>The C1-OFSRQ To Do type is shipped with the product. You can use the C1-OFSRQ To Do type or a custom To Do type, if required.</p>	<p>Yes (Conditional)</p> <p>Note: This field is required when the Approval Required option is selected.</p>
Approval To Do Role	<p>Used to indicate that users with the specified To Do role can only approve an offset request submitted for approval.</p> <p>Note: The list includes only those To Do roles which are associated with the approval To Do type.</p> <p>This field appears when the Approval Required option is selected.</p>	<p>Yes (Conditional)</p> <p>Note: This field is required when the Approval Required option is selected.</p>
Submitter To Do Type	At present, the submitter To Do type is not used to create To Do entry when the approver rejects an offset request. It is only used to fetch the roles associated with the submitter To Do type.	Yes (Conditional)

Field Name	Field Description	Mandatory (Yes or No)
	<p>Note:</p> <p>The Search (🔍) icon appears corresponding to the Submitter To Do Type field. On clicking the Search icon, the To Do Type Search window appears.</p> <p>On specifying the To Do type, the description of the To Do type appears corresponding to the Submitter To Do Type field.</p> <p>The C1-OFSSB To Do type is shipped with the product. You can use the C1-OFSSB To Do type or a custom To Do type, if required.</p>	<p>Note: This field is required when the Approval Required option is selected.</p>
Submitter To Do Role	<p>Used to indicate that users with the specified To Do role cannot approve an offset request submitted for approval.</p> <p>Note: The list includes only those To Do roles which are associated with the submitter To Do type.</p>	<p>Yes (Conditional)</p> <p>Note: This field is required when the Approval Required option is selected.</p>
Bill Search Period	<p>Used to specify the maximum search period (in days) that you want to allow while searching bills in an offset request.</p> <p>Note: If you do not specify any value, by default, it is set to 30.</p>	No
Transfer Adjustment	<p>Used to indicate whether transfer adjustments should be created while offsetting bills through an offset request.</p> <p>Note:</p> <p>By default, the Transfer Adjustment option is selected.</p> <p>This impacts the system performance when the match type entity is set to BSEG and volume of bill segments in the selected bills is high. Alternatively, the system enables you to create offset adjustments while offsetting bills through an offset request whenever the volume of bill segments in the selected bills is high. To create the offset adjustments while offsetting bills through an offset request, you need to ensure that the Transfer Adjustment option is not selected in the respective offset request type.</p>	No
Bill Line Items Level Offset	<p>Used to indicate the following:</p> <ul style="list-style-type: none"> • Whether a debit bill with a credit line item as a credit bill should be considered while offsetting through an offset request • Whether a bill with zero balance having debit and credit line items should be created in an offset request 	No

Field Name	Field Description	Mandatory (Yes or No)
	Note: If you select the Bill Line Items Level Offset option, you need to ensure that Match Type Entity (Valid Values: BILL, BSEG, SA) parameter in the C1-OFST-DIST algorithm (which is attached to the Creating Adjustment status in the lifecycle of the C1-OffsetRequest business object) is set to BSEG .	

Tip: Alternatively, you can access the **Select Business Object** screen by clicking the **Add** button in the **Page Title** area of the **Offset Request Type** screen.

4. Enter the required details in the **Main** section.
5. Define characteristics for the offset request type, if required.
6. Click **Save**.

The offset request type is defined.

Related Topics

For more information on...	See...
Offset Request Type screen	Offset Request Type on page 1563
How to define a characteristic for an offset request type	Defining a Characteristic for an Offset Request Type on page 1571
C1-OFST-AMT algorithm	C1-OFST-AMT on page 1563

Defining a Characteristic for an Offset Request Type

Prerequisites

To define a characteristic for an offset request type, you should have:

- Characteristic types defined in the application (where the characteristic entity is set to **Offset Request Type**).

Procedure

To define a characteristic for an offset request type:

1. Ensure that the **Characteristics** section is expanded when you are defining, editing, or copying an offset request type.

The **Characteristics** section contains the following fields in a grid:

Field Name	Field Description	Mandatory (Yes or No)
Characteristic Type	Used to indicate the characteristic type.	Yes (Conditional)
	Note: The list includes only those characteristic types where the characteristic entity is set to Offset Request Type .	Note: This field is required when you are defining a characteristic for the offset request type.
Characteristic Value	Used to specify the value for the characteristic type.	Yes (Conditional)

Field Name	Field Description	Mandatory (Yes or No)
	<p>Note:</p> <p>If you select a predefined characteristic type, the Search (🔍) icon appears corresponding to the Characteristic Value field. On clicking the Search icon, the Predefined Characteristic Search window appears.</p> <p>On specifying the value for a predefined characteristic type, the description of the characteristic value appears corresponding to the Characteristic Value field.</p>	<p>Note: This field is required when you are defining a characteristic for the offset request type.</p>

- Enter the required details in the **Characteristics** section.
- If you want to define more than one characteristic for the offset request type, click the **Add** (+) icon and then repeat step 2.

Note: However, if you want to remove a characteristic from the offset request type, click the **Delete** (🗑️) icon corresponding to the characteristic.

Related Topics

For more information on...	See...
How to define an offset request type	Defining an Offset Request Type on page 1567
How to edit an offset request type	Editing an Offset Request Type on page 1572
How to copy an offset request type	Copying an Offset Request Type on page 1577

Editing an Offset Request Type

Prerequisites

To edit an offset request type, you should have:

- Offset request business objects defined in the application
- Adjustment types defined in the application (where the **A/P Request Type Code** field is not set to **REFUND**)
- Default offset amount algorithm defined using the **C1-OFST-AMT** algorithm type
- Required To Do role assigned to the **C1-OFSRQ** and **C1-OFSSB** To Do types in the application
- Required match type entity specified in the **Match Type Entity (Valid Values: BILL, BSEG, SA)** parameter of the **C1-OFST-DIST** algorithm

Procedure

To edit an offset request type:

- Click the **Admin** link in the **Application** toolbar.
A list appears.
- From the **Admin** menu, select **O** and then click **Offset Request Type**.
A sub-menu appears.
- Click the **Search** option from the **Offset Request Type** sub-menu.
The **Offset Request Type** screen appears.

4. In the **Offset Request Type List** zone, click the **Edit**  icon in the **Edit** column corresponding to the offset request type whose details you want to edit.

The **Offset Request Type** screen appears. It contains the following sections:

- **Main** - Used to specify basic details about the offset request type.
- **Characteristics** - Used to define the characteristics for the offset request type.

The **Main** section contains the following fields:

Field Name	Field Description	Mandatory (Yes or No)
Offset Request Type	Displays the offset request type.	Not applicable
Business Object	Indicates the business object which is used while defining the offset request type.	Not applicable
Description	Used to specify the description for the offset request type.	Yes
Offset Request Business Object	Used to indicate the business object using which you want to create the respective offset request.	Yes
Detailed Description	Used to specify additional information about the offset request type.	No
Status	Used to indicate the status of the offset request type. The valid values are: <ul style="list-style-type: none"> • Active • Inactive 	Yes
	Note: You cannot change the status of an offset request type to Inactive when the corresponding offset request is in a status other than Processed, Rejected, or Unapplied Offset .	
Adjustment Type	Used to indicate the adjustment type using which transfer or offset adjustments should be created. By default, the specified adjustment type appears when you create an offset request. You can then change the adjustment type, if required, while editing an offset request. <p>Note:</p> <p>The Search  icon appears corresponding to the Adjustment Type field. On clicking the Search icon, the Adjustment Type Search window appears.</p> <p>On specifying the adjustment type, the description of the adjustment type appears corresponding to the Adjustment Type field.</p> <p>You can only specify an adjustment type where the A/P Request Type Code field is not set to REFUND.</p>	Yes
Default Offset Amount Algorithm	Used to attach an algorithm using which you want to calculate default offset amount while adding a bill in an offset request.	Yes

Field Name	Field Description	Mandatory (Yes or No)
	<p>Note:</p> <p>The Search (🔍) icon appears corresponding to the Default Offset Amount Algorithm field. On clicking the Search icon, the Algorithm Search window appears.</p> <p>On specifying the algorithm, the description of the algorithm appears corresponding to the Default Offset Amount Algorithm field.</p> <p>You must specify an algorithm which is created using the C1-OFST-AMT algorithm type in the Default Offset Amount Algorithm field.</p>	
Defer Processing FT Count	<p>Used to indicate whether an offset request must be processed in the deferred mode or in real time (i.e. immediately). If the number of financial transactions created for the bills which are selected in the offset request exceeds the defer processing count, the system will process the offset request in the deferred mode. However, if the number of financial transactions created for the bills which are selected in the offset request does not exceed the defer processing count, the system will process the offset request in real time (i.e. immediately).</p> <p>Note:</p> <p>You cannot specify a negative value in this field.</p> <p>Deferred mode means in the background when the Offset Request Periodic Monitor (C1-OFSRQ) batch is invoked. You can configure the Offset Request Periodic Monitor (C1-OFSRQ) batch such that it is executed at regular intervals. For more information about the Offset Request Periodic Monitor (C1-OFSRQ) batch, refer to <i>Oracle Revenue Management and Billing Batch Guide</i>.</p> <p>If you set the defer processing count to zero (0), the system resets the default value to 50.</p>	No
Approval Required	Used to indicate whether approval is required while offsetting bills through an offset request.	No
Approval To Do Type	Used to indicate that To Do entry of the specified To Do type must be created when you submit an offset request for approval.	<p>Yes (Conditional)</p> <p>Note: This field is required when the Approval Required option is selected.</p>

Field Name	Field Description	Mandatory (Yes or No)
	<p>Note:</p> <p>The Search (🔍) icon appears corresponding to the Approval To Do Type field. On clicking the Search icon, the To Do Type Search window appears.</p> <p>On specifying the To Do type, the description of the To Do type appears corresponding to the Approval To Do Type field.</p> <p>This field appears when the Approval Required option is selected.</p> <p>The C1-OFSRQ To Do type is shipped with the product. You can use the C1-OFSRQ To Do type or a custom To Do type, if required.</p>	
Approval To Do Role	<p>Used to indicate that users with the specified To Do role can only approve an offset request submitted for approval.</p> <p>Note:</p> <p>The list includes only those To Do roles which are associated with the approval To Do type.</p> <p>This field appears when the Approval Required option is selected.</p>	<p>Yes (Conditional)</p> <p>Note: This field is required when the Approval Required option is selected.</p>
Submitter To Do Type	<p>At present, the submitter To Do type is not used to create To Do entry when the approver rejects an offset request. It is only used to fetch the roles associated with the submitter To Do type.</p> <p>Note:</p> <p>The Search (🔍) icon appears corresponding to the Submitter To Do Type field. On clicking the Search icon, the To Do Type Search window appears.</p> <p>On specifying the To Do type, the description of the To Do type appears corresponding to the Submitter To Do Type field.</p> <p>The C1-OFSSB To Do type is shipped with the product. You can use the C1-OFSSB To Do type or a custom To Do type, if required.</p>	<p>Yes (Conditional)</p> <p>Note: This field is required when the Approval Required option is selected.</p>
Submitter To Do Role	<p>Used to indicate that users with the specified To Do role cannot approve an offset request submitted for approval.</p> <p>Note: The list includes only those To Do roles which are associated with the submitter To Do type.</p>	<p>Yes (Conditional)</p> <p>Note: This field is required when the Approval Required option is selected.</p>

Field Name	Field Description	Mandatory (Yes or No)
Bill Search Period	Used to specify the maximum search period (in days) that you want to allow while searching bills in an offset request.	No
	Note: If you do not specify any value, by default, it is set to 30 .	
Transfer Adjustment	Used to indicate whether transfer adjustments should be created while offsetting bills through an offset request.	No
	Note: This impacts the system performance when the match type entity is set to BSEG and volume of bill segments in the selected bills is high. Alternatively, the system enables you to create offset adjustments while offsetting bills through an offset request whenever the volume of bill segments in the selected bills is high. To create the offset adjustments while offsetting bills through an offset request, you need to ensure that the Transfer Adjustment option is not selected in the respective offset request type.	
Bill Line Items Level Offset	Used to indicate the following: <ul style="list-style-type: none"> Whether a debit bill with a credit line item as a credit bill should be considered while offsetting through an offset request Whether a bill with zero balance having debit and credit line items should be created in an offset request 	No
	Note: If you select the Bill Line Items Level Offset option, you need to ensure that Match Type Entity (Valid Values: BILL, BSEG, SA) parameter in the C1-OFST-DIST algorithm (which is attached to the Creating Adjustment status in the lifecycle of the C1-OffsetRequest business object) is set to BSEG .	

Tip: Alternatively, you can access this screen by clicking the **Edit** button in the **Offset Request Type** zone.

5. Modify the required details in the **Main** section.
6. Define, edit, or remove characteristics of the offset request type, if required.
7. Click **Save**.

The changes made to the offset request type are saved.

Related Topics

For more information on...	See...
Offset Request Type screen	Offset Request Type on page 1563
Offset Request Type List zone	Offset Request Type List on page 1564
Offset Request Type zone	Offset Request Type on page 1564

For more information on...	See...
How to define a characteristic for an offset request type	Defining a Characteristic for an Offset Request Type on page 1571
C1-OFST-AMT algorithm	C1-OFST-AMT on page 1563

Deleting an Offset Request Type

Procedure

To delete an offset request type:

1. Click the **Admin** link in the **Application** toolbar.
A list appears.
2. From the **Admin** menu, select **O** and then click **Offset Request Type**.
A sub-menu appears.
3. Click the **Search** option from the **Offset Request Type** sub-menu.
The **Offset Request Type** screen appears.
4. In the **Offset Request Type List** zone, click the **Delete** (🗑️) icon in the **Delete** column corresponding to the offset request type that you want to delete.
A message appears confirming whether you want to delete the offset request type.

Note: You can delete an offset request type when an offset request is not created using the offset request type.

Tip: Alternatively, you can delete an offset request type by clicking the **Delete** button in the **Offset Request Type** zone.

5. Click **OK**.
The offset request type is deleted.

Related Topics

For more information on...	See...
Offset Request Type screen	Offset Request Type on page 1563
Offset Request Type List zone	Offset Request Type List on page 1564
Offset Request Type zone	Offset Request Type on page 1564

Copying an Offset Request Type

Instead of creating an offset request type from scratch, you can create a new offset request type using an existing offset request type. This is possible through copying an offset request type. On copying an offset request type, the details including the characteristics are copied to the new offset request type. You can then edit the details, if required.

Prerequisites

To copy an offset request type, you should have:

- Offset request type (whose copy you want to create) defined in the application
- Offset request business objects defined in the application
- Adjustment types defined in the application (where the **A/P Request Type Code** field is not set to **REFUND**)
- Default offset amount algorithm defined using the **C1-OFST-AMT** algorithm type

- Required To Do role assigned to the **C1-OFSRQ** and **C1-OFSSB** To Do types in the application
- Required match type entity specified in the **Match Type Entity (Valid Values: BILL, BSEG, SA)** parameter of the **C1-OFST-DIST** algorithm

Procedure

To copy an offset request type:

1. Click the **Admin** link in the **Application** toolbar.
A list appears.
2. From the **Admin** menu, select **O** and then click **Offset Request Type**.
A sub-menu appears.
3. Click the **Search** option from the **Offset Request Type** sub-menu.
The **Offset Request Type** screen appears.
4. In the **Offset Request Type List** zone, click the **Duplicate** () icon in the **Duplicate** column corresponding to the offset request type whose copy you want to create.

The **Offset Request Type** screen appears. It contains the following sections:

- **Main** - Used to specify basic details about the offset request type.
- **Characteristics** - Used to define the characteristics for the offset request type.

The **Main** section contains the following fields:

Field Name	Field Description	Mandatory (Yes or No)
Offset Request Type	Used to specify the offset request type.	Yes
Business Object	Indicates the business object which is used while defining the offset request type.	Not applicable
Description	Used to specify the description for the offset request type.	Yes
Offset Request Business Object	Used to indicate the business object using which you want to create the respective offset request.	Yes
Detailed Description	Used to specify additional information about the offset request type.	No
Status	Used to indicate the status of the offset request type. The valid values are: <ul style="list-style-type: none"> • Active • Inactive <div style="border: 1px solid black; padding: 5px; margin-top: 5px;"> Note: You cannot change the status of an offset request type to Inactive when the corresponding offset request is in a status other than Processed, Rejected, or Unapplied Offset. </div>	Yes
Adjustment Type	Used to indicate the adjustment type using which transfer or offset adjustments should be created. By default, the specified adjustment type appears when you create an offset request. You can then change the adjustment type, if required, while editing an offset request.	Yes

Field Name	Field Description	Mandatory (Yes or No)
	<p>Note:</p> <p>The Search (🔍) icon appears corresponding to the Adjustment Type field. On clicking the Search icon, the Adjustment Type Search window appears.</p> <p>On specifying the adjustment type, the description of the adjustment type appears corresponding to the Adjustment Type field.</p> <p>You can only specify an adjustment type where the A/P Request Type Code field is not set to REFUND.</p>	
Default Offset Amount Algorithm	<p>Used to attach an algorithm using which you want to calculate default offset amount while adding a bill in an offset request.</p> <p>Note:</p> <p>The Search (🔍) icon appears corresponding to the Default Offset Amount Algorithm field. On clicking the Search icon, the Algorithm Search window appears.</p> <p>On specifying the algorithm, the description of the algorithm appears corresponding to the Default Offset Amount Algorithm field.</p> <p>You must specify an algorithm which is created using the C1-OFST-AMT algorithm type in the Default Offset Amount Algorithm field.</p>	Yes
Defer Processing FT Count	<p>Used to indicate whether an offset request must be processed in the deferred mode or in real time (i.e. immediately). If the number of financial transactions created for the bills which are selected in the offset request exceeds the defer processing count, the system will process the offset request in the deferred mode. However, if the number of financial transactions created for the bills which are selected in the offset request does not exceed the defer processing count, the system will process the offset request in real time (i.e. immediately).</p>	No

Field Name	Field Description	Mandatory (Yes or No)
	<p>Note:</p> <p>You cannot specify a negative value in this field.</p> <p>Deferred mode means in the background when the Offset Request Periodic Monitor (C1-OFSRQ) batch is invoked. You can configure the Offset Request Periodic Monitor (C1-OFSRQ) batch such that it is executed at regular intervals. For more information about the Offset Request Periodic Monitor (C1-OFSRQ) batch, refer to <i>Oracle Revenue Management and Billing Batch Guide</i>.</p> <p>If you set the defer processing count to zero (0), the system resets the default value to 50.</p>	
Approval Required	Used to indicate whether approval is required while offsetting bills through an offset request.	No
Approval To Do Type	<p>Used to indicate that To Do entry of the specified To Do type must be created when you submit an offset request for approval.</p> <p>Note:</p> <p>The Search  icon appears corresponding to the Approval To Do Type field. On clicking the Search icon, the To Do Type Search window appears.</p> <p>On specifying the To Do type, the description of the To Do type appears corresponding to the Approval To Do Type field.</p> <p>This field appears when the Approval Required option is selected.</p> <p>The C1-OFSRQ To Do type is shipped with the product. You can use the C1-OFSRQ To Do type or a custom To Do type, if required.</p>	<p>Yes (Conditional)</p> <p>Note: This field is required when the Approval Required option is selected.</p>
Approval To Do Role	<p>Used to indicate that users with the specified To Do role can only approve an offset request submitted for approval.</p> <p>Note:</p> <p>The list includes only those To Do roles which are associated with the approval To Do type.</p> <p>This field appears when the Approval Required option is selected.</p>	<p>Yes (Conditional)</p> <p>Note: This field is required when the Approval Required option is selected.</p>
Submitter To Do Type	At present, the submitter To Do type is not used to create To Do entry when the approver rejects an offset request. It is only used to fetch the roles associated with the submitter To Do type.	Yes (Conditional)

Field Name	Field Description	Mandatory (Yes or No)
	<p>Note:</p> <p>The Search (🔍) icon appears corresponding to the Submitter To Do Type field. On clicking the Search icon, the To Do Type Search window appears.</p> <p>On specifying the To Do type, the description of the To Do type appears corresponding to the Submitter To Do Type field.</p> <p>The C1-OFSSB To Do type is shipped with the product. You can use the C1-OFSSB To Do type or a custom To Do type, if required.</p>	<p>Note: This field is required when the Approval Required option is selected.</p>
Submitter To Do Role	<p>Used to indicate that users with the specified To Do role cannot approve an offset request submitted for approval.</p> <p>Note: The list includes only those To Do roles which are associated with the submitter To Do type.</p>	<p>Yes (Conditional)</p> <p>Note: This field is required when the Approval Required option is selected.</p>
Bill Search Period	<p>Used to specify the maximum search period (in days) that you want to allow while searching bills in an offset request.</p> <p>Note: If you do not specify any value, by default, it is set to 30.</p>	No
Transfer Adjustment	<p>Used to indicate whether transfer adjustments should be created while offsetting bills through an offset request.</p> <p>Note: This impacts the system performance when the match type entity is set to BSEG and volume of bill segments in the selected bills is high. Alternatively, the system enables you to create offset adjustments while offsetting bills through an offset request whenever the volume of bill segments in the selected bills is high. To create the offset adjustments while offsetting bills through an offset request, you need to ensure that the Transfer Adjustment option is not selected in the respective offset request type.</p>	No
Bill Line Items Level Offset	<p>Used to indicate the following:</p> <ul style="list-style-type: none"> • Whether a debit bill with a credit line item as a credit bill should be considered while offsetting through an offset request • Whether a bill with zero balance having debit and credit line items should be created in an offset request 	No

Field Name	Field Description	Mandatory (Yes or No)
	Note: If you select the Bill Line Items Level Offset option, you need to ensure that Match Type Entity (Valid Values: BILL, BSEG, SA) parameter in the C1-OFST-DIST algorithm (which is attached to the Creating Adjustment status in the lifecycle of the C1-OffsetRequest business object) is set to BSEG .	

Tip: Alternatively, you can copy an offset request type by clicking the **Duplicate** button in the **Offset Request Type** zone.

5. Enter the required details in the **Main** section.
6. Define, edit, or remove characteristics of the offset request type, if required.
7. Click **Save**.

The new offset request type is defined.

Related Topics

For more information on...	See...
Offset Request Type screen	Offset Request Type on page 1563
Offset Request Type List zone	Offset Request Type List on page 1564
Offset Request Type zone	Offset Request Type on page 1564
How to define a characteristic for an offset request type	Defining a Characteristic for an Offset Request Type on page 1571
C1-OFST-AMT algorithm	C1-OFST-AMT on page 1563

Viewing the Offset Request Type Details

Procedure

To view the details of an offset request type:

1. Click the **Admin** link in the **Application** toolbar.
A list appears.
2. From the **Admin** menu, select **O** and then click **Offset Request Type**.
A sub-menu appears.
3. Click the **Search** option from the **Offset Request Type** sub-menu.
The **Offset Request Type** screen appears.
4. In the **Offset Request Type List** zone, click the **Broadcast** () icon corresponding to the offset request type whose details you want to view.
The **Offset Request Type** zone appears.
5. View the details of the offset request type in the **Offset Request Type** zone.

Related Topics

For more information on...	See...
Offset Request Type screen	Offset Request Type on page 1563
Offset Request Type List zone	Offset Request Type List on page 1564
Offset Request Type zone	Offset Request Type on page 1564

Offset Request (Used for Searching)

The **Offset Request** screen allows you to search for an offset request using various search criteria. It also allows you to define an offset request. It contains the following zone:

- [Search Offset Request](#) on page 1583

Through this screen, you can navigate to the following screen:

- [Offset Request \(Used for Viewing\)](#) on page 1589

Search Offset Request

The **Search Offset Request** zone allows you to search for an offset request using various search criteria. It contains the following two sections:

- **Search Criteria** - The **Search Criteria** section contains the following fields:

Field Name	Field Description	Mandatory (Yes or No)
Search By	Used to indicate whether you want to search for an offset request using the offset request or bill details. The valid values are: <ul style="list-style-type: none"> • Request Details • Bill Details <p>Note: By default, the Request Details option is selected.</p>	Yes
Offset Request ID	Used to search a particular offset request. <p>Note: This field appears when the Request Details option is selected from the Search By list.</p>	No
Created From	Used to search offset requests which are created from a particular date onwards. <p>Note: This field appears when the Request Details option is selected from the Search By list.</p>	No
User ID	Used to search offset requests which are created by a particular user. <p>Note: This field appears when the Request Details option is selected from the Search By list.</p>	No
Created To	Used to search offset requests which are created till a particular date.	No

Field Name	Field Description	Mandatory (Yes or No)
	Note: This field appears when the Request Details option is selected from the Search By list.	
Status	Used to search offset requests with a particular status. The valid values are: <ul style="list-style-type: none"> • Approval In Progress • Defer Unapplied • Deferred Processing • Draft • Processed • Rejected • Unapplied Offset Note: This field appears when the Request Details option is selected from the Search By list.	No
Person ID	Used to search offset requests which include bills of a particular person. <p>Note: This field appears when the Request Details option is selected from the Search By list.</p> <p>The Search (🔍) icon appears corresponding to the Person ID field. On clicking the Search icon, the Person Search window appears.</p>	No
Offset Request Type	Used to search offset requests which are created using a particular offset request type. <p>Note: This field appears when the Request Details option is selected from the Search By list.</p>	No
Account ID	Used to search offset requests which include bills of a particular account. <p>Note: This field appears when the Request Details option is selected from the Search By list.</p> <p>The Search (🔍) icon appears corresponding to the Account ID field. On clicking the Search icon, the Account Search window appears.</p>	No
Bill ID	Used to search offset requests which include a particular bill.	No

Field Name	Field Description	Mandatory (Yes or No)
	<p>Note:</p> <p>This field appears when the Bill Details option is selected from the Search By list.</p> <p>The Search (🔍) icon appears corresponding to the Bill ID field. On clicking the Search icon, the Bill Search window appears.</p>	
Bill Date From	<p>Used to search offset requests which include bills created from a particular date onwards.</p> <p>Note: This field appears when the Bill Details option is selected from the Search By list.</p>	No
Alternate Bill ID	<p>Used to search offset requests which include a particular bill.</p> <p>Note: This field appears when the Bill Details option is selected from the Search By list.</p>	No
Bill Date To	<p>Used to search offset requests which include bills created till a particular date.</p> <p>Note: This field appears when the Bill Details option is selected from the Search By list.</p>	No

Note: You must specify at least one search criterion while searching for an offset request.

- **Search Results** - On clicking the **Search** button, the search results appear based on the specified search criteria. The **Search Results** section contains the following columns:

Column Name	Column Description
Creation Date Time	Displays the date and time when the offset request is created.
Offset Request Information	<p>Displays information about the offset request.</p> <p>Note: It has a link. On clicking the link, the Offset Request screen appears where you can view the details of the respective offset request.</p>
Offset Amount	Displays the total amount which is offset through the offset request.
Status	<p>Indicates the status of the offset request. The valid values are:</p> <ul style="list-style-type: none"> • Approval In Progress • Defer Unapplied • Deferred Processing • Draft • Processed • Rejected

Column Name	Column Description
	<ul style="list-style-type: none"> Unapplied Offset
Created By	Indicates the user who has created the offset request.
Creation Mode	Indicates whether the offset request is created manually or automatically. The valid values are: <ul style="list-style-type: none"> Automatic Manual
Primary Bill	Indicates the bill for which the offset request is created. In addition, this column has a context menu which helps in navigating to other screens in the application. <p>Note: It has a link. On clicking the link, the Bill screen appears where you can view the details of the respective bill.</p>

Note: Pagination is used to display limited number of records in the **Search Results** section. You can use the navigation links, such as **Previous** and **Next** to navigate between pages.

Related Topics

For more information on...	See...
How to search for an offset request	Searching for an Offset Request on page 1586
How to view the details of an offset request	Viewing the Offset Request Details on page 1589
How to create an offset request	Creating an Offset Request on page 1587

Searching for an Offset Request

Prerequisites

To search for an offset request, you should have:

- Offset request types defined in the application

Procedure

To search for an offset request:

- Click the **Menu** link in the **Application** toolbar.
A list appears.
- From the **Main** menu, select **Accounting and Receivable** and then click **Offset Request**.
A sub-menu appears.
- Click the **Search** option from the **Offset Request** sub-menu.
The **Offset Request** screen appears.
- Enter the search criteria in the **Search Offset Request** zone.

Note: ORMB search engine supports wildcard search, where you can substitute the percentage (%) symbol as a stand in for any word or letter in a search criteria. You can use the '%' wildcard character in all input fields except the date and ID fields. The '%' wildcard character is suffixed automatically at the end of the partial search criteria. Therefore, you may or may not specify the wildcard character at the end of the partial search criteria. However, you have to prefix the wildcard character manually wherever required.

5. Click **Search**.

A list of offset requests that meet the search criteria appears in the **Search Results** section.

Related Topics

For more information on...	See...
Offset Request screen	Offset Request (Used for Searching) on page 1583
Search Offset Request zone	Search Offset Request on page 1583

Creating an Offset Request

Prerequisites

To create an offset request, you should have:

- Offset request types defined in the application
- Bills created in the application

Procedure

To create an offset request:

1. Do either of the following:

If you want to...	Then...
Create a single offset request from the Account Receivable Central screen	<ol style="list-style-type: none"> 1. Click the Menu link in the Application toolbar. A list appears. 2. From the Main menu, select Accounting and Receivable and then click Account Receivable Central. The Account Receivable Central screen appears. 3. Search for the required bill in the Search Bill zone. 4. In the Search Results section, select the check box corresponding to the bill which you want to offset through a single offset request. 5. Click Single Offset.
Create a mass offset request from the Account Receivable Central screen	<ol style="list-style-type: none"> 1. Click the Menu link in the Application toolbar. A list appears. 2. From the Main menu, select Accounting and Receivable and then click Account Receivable Central. The Account Receivable Central screen appears. 3. Search for the required bill in the Search Bill zone. 4. In the Search Results section, select the check box corresponding to the bill which you want to offset through a mass offset request.

If you want to...	Then...
	5. Click Mass Offset .
Create a cross currency offset request from the Account Receivable Central screen	<ol style="list-style-type: none"> 1. Click the Menu link in the Application toolbar. A list appears. 2. From the Main menu, select Accounting and Receivable and then click Account Receivable Central. The Account Receivable Central screen appears. 3. Search for the required bill in the Search Bill zone. 4. In the Search Results section, select the check box corresponding to the bill which you want to offset through a cross currency offset request. 5. Click Cross Currency Offset.
Create a single, mass, or cross currency offset request from the Offset Request screen	<ol style="list-style-type: none"> 1. Click the Menu link in the Application toolbar. A list appears. 2. From the Main menu, select Accounting and Receivable and then click Offset Request. A sub-menu appears. 3. Click the Add option from the Offset Request sub-menu.

The **Add Offset Request** screen appears. It contains the following fields:

Field Name	Field Description	Mandatory (Yes or No)
Offset Request Type	Used to indicate the offset request type using which you want to create the offset request.	Yes
Bill	<p>Used to indicate the bill which you want to offset through the offset request.</p> <p>Note:</p> <p>The Search (🔍) icon appears corresponding to the Bill field. On clicking the Search icon, the Bill Search window appears.</p> <p>On specifying the bill, the information about the bill appears corresponding to the Bill field.</p>	Yes

Tip: Alternatively, you can access this screen by clicking the **Add** button in the **Page Title** area of the **Offset Request** screen.

2. Enter the required details in the **Add Offset Request** screen.
3. Click **Save**.

The offset request is created in the **Draft** status. The **Offset Request** screen appears where you can view the details of the offset request. By default, the adjustment type specified in the respective offset request type is used while creating the offset request. You can then change the adjustment type, if required.

4. Add debit and/or credit bills in the offset request.
5. Define characteristics for the offset request, if required.

Related Topics

For more information on...	See...
Single Offset Request	Single Offset on page 1547
Mass Offset Request	Mass Offset on page 1548
Cross Currency Offset Request	Cross Currency Offset on page 1551
Offset Request screen	Offset Request (Used for Searching) on page 1583
How to add a debit or credit bill to an offset request	Adding a Debit or Credit Bill to an Offset Request on page 1600
How to define a characteristic for an offset request	Defining a Characteristic for an Offset Request on page 1603

Viewing the Offset Request Details

Procedure

To view the details of an offset request:

1. Search for the offset request in the **Offset Request** screen.
2. In the **Search Results** section, click the link in the **Offset Request Information** column corresponding to the offset request whose details you want to view.

The **Offset Request** screen appears.

3. Ensure that the **Main** tab is selected.
4. View the details of the offset request in the **Offset Request** zone.

Related Topics

For more information on...	See...
How to search for an offset request	Searching for an Offset Request on page 1586
Offset Request screen	Offset Request (Used for Viewing) on page 1589
Offset Request zone	Offset Request on page 1590

Offset Request (Used for Viewing)

The **Offset Request** screen allows you to:

- View the details of the offset request
- Search for a debit or credit bill based on bill, account, or person details
- View the debit and credit bills which are added to the offset request
- View the offset or transfer adjustments which are created through the offset request

- Add a debit or credit bill to the offset request
- Edit the details of the offset request
- Define, edit, or remove the characteristics from the offset request
- Edit the offset amount for each debit and credit bill
- Remove a debit or credit bill from the offset request
- Delete the offset request
- Submit the offset request for approval
- Approve or reject the offset request
- Unapply (i.e. cancel) the offset request
- View the log of the offset request
- Add a log entry for the offset request

It consists of the following tabs:

- [Offset Request - Main](#) on page 1590
- [Offset Request - Log](#) on page 1599

Offset Request - Main

The **Main** tab displays information about the offset request. It contains the following zones:

- [Offset Request](#) on page 1590
- [Selected Bills](#) on page 1592
- [Search Bill](#) on page 1594
- [Offset Request Adjustments](#) on page 1598

Offset Request

The **Offset Request** zone displays the details of the offset request. It contains the following sections:

- **Main** - Displays basic information about the offset request. It contains the following fields:

Field Name	Field Description
Offset Request Information	Displays information about the offset request.
Offset Request Type	Indicates the offset request type using which the offset request is created. Note: It has a link. On clicking the link, the Offset Request Type screen appears where you can view the details of the respective offset request type.
Status	Indicates the status of the offset request. The valid values are: <ul style="list-style-type: none"> • Approval In Progress • Defer Unapplied • Deferred Processing • Draft • Rejected • Processed

Field Name	Field Description
	<ul style="list-style-type: none"> Unapplied Offset
Status Reason	<p>Indicates the reason why the offset request is rejected or unapplied (i.e. canceled).</p> <p>Note: It has a link. On clicking the link, the Status Reason screen appears where you can view the details of the respective status reason. This field appears when the offset request is in the Rejected, Defer Unapplied, or Unapplied Offset status.</p>
Adjustment Type	<p>Indicates the adjustment type using which the offset or transfer adjustments should be created through the offset request.</p> <p>Note: It has a link. On clicking the link, the Adjustment Type screen appears where you can view the details of the respective adjustment type.</p>
Offset Amount	Displays the total amount which is offset through the offset request.
Comments	<p>Displays additional details specified while rejecting or unapplying (i.e. canceling) the offset request.</p> <p>Note: This field appears when the offset request is in the Rejected, Defer Unapplied, or Unapplied Offset status.</p>

- Characteristics** - Lists the characteristics defined for the offset request. It contains the following columns:

Column Name	Column Description
Effective Date	Displays the date from when the characteristic is effective for the offset request.
Characteristic Type	Indicates the characteristic type.
Characteristic Value	Displays the value of the characteristic type.

- Record Actions** - This section contains the following buttons:

Button Name	Button Description
Edit	Used to edit the details of the offset request.
	Note: The Edit button appears when the offset request is in the Draft status.
Delete	Used to delete the offset request.
	Note: The Delete button appears when the offset request is in the Draft status.
Submit	Used to submit the offset request.
	Note: The Submit button appears when the offset request is in the Draft status.
Approve	Used to approve the offset request.

Button Name	Button Description
	<p>Note: The Approve button appears when:</p> <ul style="list-style-type: none"> The offset request is in the Approval In Progress status. A user with the approval To Do role is reviewing the offset request.
Reject	<p>Used to reject the offset request.</p> <p>Note: The Reject button appears when:</p> <ul style="list-style-type: none"> The offset request is in the Approval In Progress status. A user with the approval To Do role is reviewing the offset request.
Unapply	<p>Used to unapply (i.e. cancel) the offset request.</p> <p>Note: The Unapply button appears when the offset request is in the Processed status.</p>

- **Record Information** - This section contains the following fields:

Field Name	Field Description
Business Object	<p>Indicates the business object using which the offset request is created. In addition, a context menu appears corresponding to this field which helps in navigating to other screens in the application.</p> <p>Note: It has a link. On clicking the link, the Business Object screen appears where you can view the details of the respective business object.</p>
Status Date/Time	Displays the date and time when the offset request status is updated
Create Date/Time	Displays the date and time when the offset request is created.

Related Topics

For more information on...	See...
How to edit an offset request	Editing an Offset Request on page 1601
How to delete an offset request	Deleting an Offset Request on page 1606
How to submit an offset request	Submitting an Offset Request on page 1607
How to approve an offset request	Approving an Offset Request on page 1608
How to reject an offset request	Rejecting an Offset Request on page 1611
How to unapply (i.e. cancel) an offset request	Unapplying an Offset Request on page 1612

Selected Bills

The **Selected Bills** zone lists the debit and credit bills which are added to the offset request. It contains the following columns:

Column Name	Column Description
Bill Information	Indicates the debit or credit bill which is added to the offset request. In addition, this column has a context menu which helps in navigating to other screens in the application.

Column Name	Column Description
	Note: It has a link. On clicking the link, the Bill screen appears where you can view the details of the respective bill.
Bill Date	Displays the date when the debit or credit bill is created.
Outstanding Amount	Displays the outstanding amount (i.e. unpaid amount) of the debit or credit bill.
Debit Balance	Displays the sum of unpaid debit line items of a bill.
Credit Balance	Displays the sum of open credit line items of a bill.
Credit Bill	Indicates whether you want to consider a debit bill with a credit line item as a credit bill in the offset request.
Hold Amount	Displays the amount of the debit or credit bill which is kept on hold through an hold request.
Offset Amount	Displays the amount which you want to offset from the debit or credit bill.
Remaining Bill Balance	Displays the remaining outstanding amount of the debit or credit bill (i.e. Outstanding Amount - Hold Amount - Offset Amount). Note: This column does not appear when the offset request is in the Processed or Unapplied Offset status.
Updated Hold Amount	Displays the new hold amount (i.e. Current Hold Amount + Remaining Bill Balance) for the debit or credit bill which is derived when the remaining bill balance is less than the current hold amount. Note: This column does not appear when the offset request is in the Processed or Unapplied Offset status.
Account Information	Indicates the account for which the debit or credit bill is created. In addition, this column has a context menu which helps in navigating to other screens in the application. Note: It has a link. On clicking the link, the Account screen appears where you can view the details of the respective account.
Bill ID	Displays the bill ID.

Note: Pagination is used to display limited number of records in this zone. You can use the navigation links, such as **Previous** and **Next** to navigate between pages.

On clicking the **Broadcast** () icon corresponding to a bill, the **Offset Request Adjustments** zone appears where you can view the offset or transfer adjustments created for the bill through the offset request.

Note: The **Broadcast** () icon appears corresponding to a bill when the offset request is in the **Processed** or **Unapplied Offset** status.

You can filter the list using various search criteria (such as, **Bill Balance**, **Bill ID**, and **Account ID**) available in the **Filter** area. By default, the **Filter** area is hidden. You can view the **Filter** area by clicking the **Filters** () icon in the upper right corner of this zone.

You can change the layout of this zone. For more information on how to change the layout, see [Changing the Layout](#) on page 4300.

Related Topics

For more information on...	See...
How to view the debit or credit bills added to an offset request	Viewing the Debit and Credit Bills Added to an Offset Request on page 1599

Search Bill

The bills listed in the **Search Bill** zone varies depending on the following scenarios:

If...	Then...
The single offset request is created through the Account Receivable Central screen and the Allow Offsetting Across Persons option type of the C1-OFFSETREQ feature configuration is set to Y	The Search Bill zone lists completed bills of all accounts of the main customer (whose bill is added as the primary bill in the offset request) and completed bills of all accounts of its effective child persons. If the primary bill is a debit bill, it lists credit bills of the main customer and its child persons. However, if the primary bill is a credit bill, it lists debit bills of the main customer and its child persons. Note that it lists only those bills which are in the same currency as that of the primary bill. For example, if the primary bill is in USD, then this zone lists all completed bills of the main customer and its child persons which are in USD.
The single offset request is created through the Account Receivable Central screen and the Allow Offsetting Across Persons option type of the C1-OFFSETREQ feature configuration is set to N	The Search Bill zone lists completed bills of all accounts of the main customer (whose bill is added as the primary bill in the offset request). If the primary bill is a debit bill, it lists credit bills of the main customer. However, if the primary bill is a credit bill, it lists debit bills of the main customer. Note that it lists only those bills which are in the same currency as that of the primary bill. For example, if the primary bill is in USD, then this zone lists all completed bills of the main customer which are in USD.
The mass offset request is created through the Account Receivable Central screen and the Allow Offsetting Across Persons option type of the C1-OFFSETREQ feature configuration is set to Y	The Search Bill zone lists completed debit and credit bills of all accounts of the main customer (whose bill is added as the primary bill in the offset request) and completed debit and credit bills of all accounts of its effective child persons. Note that it lists only those debit and credit bills which are in the same currency as that of the primary bill. For example, if the primary bill is in USD, then this zone lists all completed debit and credit bills of the main customer and its child persons which are in USD.
The mass offset request is created through the Account Receivable Central screen and the Allow Offsetting Across Persons option type of the C1-OFFSETREQ feature configuration is set to N	The Search Bill zone lists completed debit and credit bills of all accounts of the main customer (whose bill is added as the primary bill in the offset request). Note that it lists only those debit and credit bills which are in the same currency as that of the primary bill. For example, if the primary bill is in USD, then this zone lists all completed debit and credit bills of the main customer which are in USD.
The cross currency offset request is created through the Account Receivable Central screen and the Allow Offsetting Across Persons option type of the C1-OFFSETREQ feature configuration is set to Y	The Search Bill zone lists completed debit and credit bills of all accounts of the main customer (whose bill is added as the primary bill in the offset request) and completed debit and credit bills of all accounts of its effective child persons. Note that it lists only those debit and credit bills which are in the currency different from the primary bill. For example, if the primary bill is in USD, then this zone lists all completed debit and credit bills of

If...	Then...
	the main customer and its child persons which are in the currency other than USD.
The cross currency offset request is created through the Account Receivable Central screen and the Allow Offsetting Across Persons option type of the C1-OFFSETREQ feature configuration is set to N	The Search Bill zone lists completed debit and credit bills of all accounts of the main customer (whose bill is added as the primary bill in the offset request). Note that it lists only those debit and credit bills which are in the currency different from the primary bill. For example, if the primary bill is in USD, then this zone lists all completed debit and credit bills of the main customer which are in the currency other than USD.
The offset request is created through the Offset Request screen and the Allow Offsetting Across Persons option type of the C1-OFFSETREQ feature configuration is set to Y	<p>The Search Bill zone lists completed debit and credit bills of all accounts of the main customer (whose bill is added as the primary bill in the offset request) and completed debit and credit bills of all accounts of its effective child persons. Note that it lists only those debit and credit bills which are in the same currency as that of the primary bill. For example, if the primary bill is in USD, then this zone lists all completed debit and credit bills of the main customer and its child persons which are in USD.</p> <p>Note: This zone lists the debit and credit bills in the currency different from the primary bill when the Show Cross Currency Bills option is selected.</p>
The offset request is created through the Offset Request screen and the Allow Offsetting Across Persons option type of the C1-OFFSETREQ feature configuration is set to N	<p>The Search Bill zone lists completed debit and credit bills of all accounts of the main customer (whose bill is added as the primary bill in the offset request). Note that it lists only those debit and credit bills which are in the same currency as that of the primary bill. For example, if the primary bill is in USD, then this zone lists all completed debit and credit bills of the main customer which are in USD.</p> <p>Note: This zone lists the debit and credit bills in the currency different from the primary bill only when the Show Cross Currency Bills option is selected.</p>

It also allows you to filter the bills using various search criteria. It contains the following two sections:

- **Search Criteria** - The **Search Criteria** section contains the following fields:

Field Name	Field Description	Mandatory (Yes or No)
Search By	<p>Used to indicate whether you want to search for a completed bill using the person, account, or bill details. The valid values are:</p> <ul style="list-style-type: none"> • Person Details • Account Details • Bill Details <p>Note: By default, the Person Details option is selected.</p>	Yes
Person ID	Used to search completed bills of a particular person.	No

Field Name	Field Description	Mandatory (Yes or No)						
	<p>Note:</p> <p>This field appears when the Person Details option is selected from the Search By list.</p> <p>The Search (🔍) icon appears corresponding to the Person ID field. On clicking the Search icon, the Person Search window appears.</p>							
Bill Date From	<p>Used to search completed bills which are created from a particular date onwards.</p> <p>Note:</p> <p>By default, it is set to a date which is calculated as follows: Bill Date To - Bill Search Period (Specified in Offset Request Type)</p>	Yes						
Bills on Hold	<p>Used to indicate whether you want to search completed bills which are partially kept on hold. The valid values are:</p> <ul style="list-style-type: none"> • No • Yes 	No						
Bill Date To	<p>Used to search completed bills which are created till a particular date.</p> <p>Note: By default, it is set to the current date.</p>	Yes						
Bill Balance	<p>Used to indicate whether you want to search completed bills with a particular balance amount. The valid values are:</p> <ul style="list-style-type: none"> • Equal to Zero • Greater Than Zero • Less Than Zero • Not Equal to Zero <p>Note:</p> <p>If a single or cross currency offset request is created through the Account Receivable Central screen, this field is disabled, and by default, it is set to the following:</p> <table border="1"> <thead> <tr> <th>If the primary bill is a...</th> <th>Then, it is set to...</th> </tr> </thead> <tbody> <tr> <td>Credit Bill</td> <td>Greater Than Zero</td> </tr> <tr> <td>Debit Bill</td> <td>Less Than Zero</td> </tr> </tbody> </table>	If the primary bill is a...	Then, it is set to...	Credit Bill	Greater Than Zero	Debit Bill	Less Than Zero	No
If the primary bill is a...	Then, it is set to...							
Credit Bill	Greater Than Zero							
Debit Bill	Less Than Zero							
Show Cross Currency Bills	Used to indicate whether you want to search completed bills in the currencies different from the primary bill.	No						

Field Name	Field Description	Mandatory (Yes or No)
	<p>Note:</p> <p>This option is disabled when a single or cross currency offset request is created through the Account Receivable Central screen.</p> <p>By default, this option is selected when a cross currency offset request is created through the Account Receivable Central screen.</p>	
Account ID	<p>Used to search completed bills which created for a particular account.</p> <p>Note:</p> <p>This field appears when the Account Details option is selected from the Search By list.</p> <p>The Search (🔍) icon appears corresponding to the Account ID field. On clicking the Search icon, the Account Search window appears.</p>	Yes
Bill ID	<p>Used to search a particular completed bill.</p> <p>Note:</p> <p>This field appears when the Bill Details option is selected from the Search By list.</p> <p>The Search (🔍) icon appears corresponding to the Bill ID field. On clicking the Search icon, the Bill Search window appears.</p>	No

- **Search Results** - On clicking the **Search** button, the search results appear based on the specified search criteria. The **Search Results** section contains the following columns:

Column Name	Column Description
Bill Information	<p>Display information about the completed debit or credit bill. In addition, this column has a context menu which helps in navigating to other screens in the application.</p> <p>Note: It has a link. On clicking the link, the Bill screen appears where you can view the details of the respective bill.</p>
Bill Date	Displays the date when the debit or credit bill is created.
Due Date	Displays the date when the debit or credit bill is due for payment.
Outstanding Amount	Displays the outstanding amount (i.e. unpaid amount) of the debit or credit bill.
Hold Amount	Displays the amount of the debit or credit bill which is kept on hold through an hold request.
Outstanding Amount (Offset Currency)	Displays the outstanding amount (i.e. unpaid amount) of the debit or credit bill in the currency in which the bill amount would be offset.

Column Name	Column Description
	Note: This column appears when the offset request is a cross-currency offset request.
Account Information	Indicates the account for which the debit or credit bill is created. In addition, this column has a context menu which helps in navigating to other screens in the application.
	Note: It has a link. On clicking the link, the Account screen appears where you can view the details of the respective account.

Note: Pagination is used to display limited number of records in the **Search Results** section. You can use the navigation links, such as **Previous** and **Next** to navigate between pages.

In addition, this section contains the following button:

Button Name	Button Description
Add	Used to add a bill to the offset request.

A check box appears corresponding to each bill. On selecting the check box, you can add the bill to the offset request. You can also select multiple bills at the same time. In addition, you can select the check box corresponding to the column header. This allows you to add all bills listed in the respective page to the offset request.

Related Topics

For more information on...	See...
How to add a debit or credit bill to an offset request	Adding a Debit or Credit Bill to an Offset Request on page 1600
How to setup the C1-OFFSETREQ feature configuration	Setting the C1-OFFSETREQ Feature Configuration on page 4335

Offset Request Adjustments

The **Offset Request Adjustments** zone lists the offset or transfer adjustments which are created for the bill through the offset request. It appears when the offset request is in the **Processed** status. It contains the following columns:

Column Name	Column Description
Adjustment Information	Displays information about the offset or transfer adjustment.
	Note: It has a link. On clicking the link, the Adjustment screen appears where you can view the details of the respective adjustment.
From Bill ID	Indicates the bill from where the amount is offset.
To Bill ID	Indicates the bill against which the amount is offset.
Current Amount	Displays the adjustment amount.

Related Topics

For more information on...	See...
How to view the offset or transfer adjustments created through an offset request	Viewing the Adjustments Created Through an Offset Request on page 1600

Offset Request - Log

The **Log** tab contains the following zone:

- [Offset Request Log](#) on page 1599

Offset Request Log

The **Offset Request Log** zone lists the complete trail of actions performed on the offset request. It contains the following columns:

Column Name	Column Description
Creation Date Time	Displays the date and time when the action was performed on the offset request.
Details	Displays the details about the action performed on the offset request.
User	Indicates the user who has performed the action on the offset request.
Log Type	Indicates the type of log.
Related Object	Indicates the object or entity which is created when the action is performed on the offset request. Note: At present, no data appears in this column. The implementation team can build the custom logic to meet the business requirements.
Status Reason	Indicates the reason why the offset request is rejected or unapplied (i.e. canceled).

Note: You can manually add a log entry for the offset request by clicking the **Add Log Entry** link in the upper right corner of the **Offset Request Log** zone.

Related Topics

For more information on...	See...
How to view the log of an offset request	Viewing the Log of an Offset Request on page 1613
How to add a log entry for an offset request	Adding a Log Entry for an Offset Request on page 1614

Viewing the Debit and Credit Bills Added to an Offset Request

Procedure

To view the debit and credit bills which are added to an offset request:

1. Search for the offset request in the **Offset Request** screen.
2. In the **Search Results** section, click the link in the **Offset Request Information** column corresponding to the offset request whose details you want to view.

The **Offset Request** screen appears.

3. Ensure that the **Main** tab is selected.
4. View the debit and credit bills added to the offset request in the **Selected Bills** zone.

Related Topics

For more information on...	See...
How to search for an offset request	Searching for an Offset Request on page 1586
Offset Request screen	Offset Request (Used for Viewing) on page 1589
Selected Bills zone	Selected Bills on page 1592

Viewing the Adjustments Created Through an Offset Request

Procedure

To view the adjustments created through an offset request:

1. Search for the offset request in the **Offset Request** screen.
2. In the **Search Results** section, click the link in the **Offset Request Information** column corresponding to the offset request whose details you want to view.

The **Offset Request** screen appears.

3. Ensure that the **Main** tab is selected.
4. In the **Selected Bills** zone, click the **Broadcast** () icon corresponding to the bill whose offset or transfer adjustments you want to view.

The **Offset Request Adjustments** zone appears.

Note: The **Broadcast** () icon appears corresponding to a bill when the offset request is in the **Processed** or **Unapplied Offset** status.

5. View the offset or transfer adjustments created for the bill through the offset request in the **Offset Request Adjustments** zone.

Related Topics

For more information on...	See...
How to search for an offset request	Searching for an Offset Request on page 1586
Offset Request screen	Offset Request (Used for Viewing) on page 1589
Selected Bills zone	Selected Bills on page 1592
Offset Request Adjustments zone	Offset Request Adjustments on page 1598

Adding a Debit or Credit Bill to an Offset Request

Prerequisites

To add a debit or credit bill to an offset request, you should have:

- Completed bills for accounts of the main customer (whose bill is added as the primary bill in the offset request)
- Completed bills for effective child persons of the main customer (whose bill is added as the primary bill in the offset request)
- The **Allow Offsetting Across Persons** option type of the **C1-OFFSETREQ** feature configuration set to **Y** or **N** based on the business requirements

Procedure

To add a debit or credit bill to an offset request:

1. Search for the offset request in the **Offset Request** screen.
2. In the **Search Results** section, click the link in the **Offset Request Information** column corresponding to the offset request whose details you want to edit.

The **Offset Request** screen appears.

3. Ensure that the **Main** tab is selected.
4. Enter the search criteria in the **Search Bill** zone.

Note:

The **Search Bill** zone appears when the offset request is in the **Draft** status.

The date range specified in the **Bill Date From** and **Bill Date To** fields should not exceed the number of days specified in the **Bill Search Period** field of the respective offset request type.

ORMB search engine supports wildcard search, where you can substitute the percentage (%) symbol as a stand in for any word or letter in a search criteria. You can use the ‘%’ wildcard character in all input fields except the date and ID fields. The ‘%’ wildcard character is suffixed automatically at the end of the partial search criteria. Therefore, you may or may not specify the wildcard character at the end of the partial search criteria. However, you have to prefix the wildcard character manually wherever required.

5. Click **Search**.

A list of completed bills that meet the search criteria appears in the **Search Results** section.

6. Select the check box corresponding to a completed bill that you want to add to the offset request.
7. Click the **Add** button in the **Search Bill** zone.

A message appears indicating that the bill is added to the offset request.

Note: You can only add a completed bill to an offset request when its outstanding amount is not equal to zero.

8. Click **OK**.

The completed bill is added to the offset request. You can view the completed bills which are added to the offset request in the **Selected Bills** zone.

Note: The default offset amount is calculated for each bill using the algorithm which is attached in the respective offset request type. For more information on how the default offset amount is calculated, see [CI-OFST-AMT](#) on page 1563.

Related Topics

For more information on...	See...
How to search for an offset request	Searching for an Offset Request on page 1586
Offset Request screen	Offset Request (Used for Viewing) on page 1589
Search Bill zone	Search Bill on page 1594
Selected Bills zone	Selected Bills on page 1592
How to create an offset request	Creating an Offset Request on page 1587
How to setup the C1-OFFSETREQ feature configuration	Setting the C1-OFFSETREQ Feature Configuration on page 4335

Editing an Offset Request

Prerequisites

To edit an offset request, you should have:

- Adjustment types defined in the application (where the **A/P Request Type Code** field is not set to **REFUND**)

Procedure

To edit an offset request:

1. Search for the offset request in the **Offset Request** screen.
2. In the **Search Results** section, click the link in the **Offset Request Information** column corresponding to the offset request whose details you want to edit.

The **Offset Request** screen appears.

3. Ensure that the **Main** tab is selected.
4. Click the **Edit** button in the **Offset Request** zone.

The **Offset Request** screen appears. It contains the following sections:

- **Main** - Used to specify the basic details about the offset request.
- **Characteristics** - Used to define the characteristics for the offset request.
- **Offset Details** - Used to edit the offset amount of the bills which are added to the offset request. It also allows you to remove a bill from the offset request.

Note: You can only remove secondary debit or credit bills from the offset request. And, you cannot remove a primary debit or credit bill from the offset request throughout its lifecycle.

The **Main** section contains the following fields:

Field Name	Field Description	Mandatory (Yes or No)
Offset Request Information	Displays information about the offset request.	Not applicable
Offset Request Type	Indicates the offset request type using which the offset request is created.	Not applicable
Adjustment Type	Used to indicate the adjustment type using which transfer or offset adjustments must be created through the offset request. <div style="border: 1px solid black; padding: 5px; margin-top: 5px;"> <p>Note:</p> <p>The Search (🔍) icon appears corresponding to the Adjustment Type field. On clicking the Search icon, the Adjustment Type Search window appears.</p> <p>On specifying the adjustment type, the description of the adjustment type appears corresponding to the Adjustment Type field.</p> </div>	Yes
Comments	Used to specify additional information about the offset request.	No

Note: The **Edit** button appears when the offset request is in the **Draft** status.

5. Modify the required details in the **Main** section.

6. Define, edit, or remove characteristics of the offset request, if required.
7. Edit the offset amount of a debit or credit bill, if required.
8. Remove a debit or credit bill from the offset request, if required.
9. Click **Save**.

The changes made to the offset request are saved.

Related Topics

For more information on...	See...
How to search for an offset request	Searching for an Offset Request on page 1586
Offset Request screen	Offset Request (Used for Viewing) on page 1589
Offset Request zone	Offset Request on page 1590
How to define a characteristic for an offset request	Defining a Characteristic for an Offset Request on page 1603
How to edit the offset amount of a debit or credit bill	Editing the Offset Amount of a Debit or Credit Bill on page 1604
How to remove a debit or credit bill from an offset request	Removing a Debit or Credit Bill from an Offset Request on page 1606

Defining a Characteristic for an Offset Request

Prerequisites

To define a characteristic for an offset request, you should have:

- Characteristic types defined in the application (where the characteristic entity is set to **Offset Request**)

Procedure

To define a characteristic for an offset request:

1. Ensure that the **Characteristics** section is expanded when you are editing an offset request.

The **Characteristics** section contains the following fields in a grid:

Field Name	Field Description	Mandatory (Yes or No)
Effective Date	Used to specify the date from when the characteristic is effective for the offset request.	Yes (Conditional) Note: This field is required when you are defining a characteristic for the offset request.
Characteristic Type	Used to indicate the characteristic type. Note: The list includes only those characteristic types where the characteristic entity is set to Offset Request .	Yes (Conditional) Note: This field is required when you are defining a characteristic for the offset request.
Characteristic Value	Used to specify the value for the characteristic type.	Yes (Conditional)

Field Name	Field Description	Mandatory (Yes or No)
	<p>Note:</p> <p>If you select a predefined characteristic type, the Search (🔍) icon appears corresponding to the Characteristic Value field. On clicking the Search icon, the Predefined Characteristic Search window appears.</p> <p>On specifying the value for a predefined characteristic type, the description of the characteristic value appears corresponding to the Characteristic Value field.</p>	<p>Note: This field is required when you are defining a characteristic for the offset request.</p>

- Enter the required details in the **Characteristics** section.
- If you want to define more than one characteristic for the offset request, click the **Add** (+) icon and then repeat step 2.

Note: However, if you want to remove a characteristic from the offset request, click the **Delete** (🗑️) icon corresponding to the characteristic.

- Click **Save**.

The characteristics are defined for the offset request.

Related Topics

For more information on...	See...
How to edit an offset request	Editing an Offset Request on page 1601

Editing the Offset Amount of a Debit or Credit Bill

Prerequisites

To edit the offset amount of a debit or credit bill, you should have:

- Required debit or credit bill added in the offset request

Procedure

To edit the offset amount of a debit or credit bill:

- Ensure that the **Offset Details** section is expanded when you are editing an offset request.

The **Offset Details** section contains the following fields:

Field Name	Field Description	Mandatory (Yes or No)
Total Debit Offset Amount	Displays the total offset amount of all debit bills which are included in the offset request.	Not applicable
Total Credit Offset Amount	Displays the total offset amount of all credit bills which are included in the offset request.	Not applicable
Total Offset Amount	Displays the sum of the total debit and credit offset amount.	Not applicable

In addition, this section contains the following fields in a grid:

Field Name	Field Description	Mandatory (Yes or No)
Bill ID	Indicates the debit or credit bill which is added to the offset request.	Not applicable
Outstanding Amount	Displays the outstanding amount (i.e. unpaid amount) of the debit or credit bill.	Not applicable
Due Date	Displays the date when the debit or credit bill is due for payment.	Not applicable
Debit Balance	Displays the sum of the unpaid debit line items of a bill.	Not applicable
Credit Balance	Displays the sum of the open credit line items of a bill	Not applicable
Credit Bill	Used to indicate whether you want to consider a debit bill with a credit line item as a credit bill in the offset request. By default, this option is selected for a bill with the credit or zero balance and it is not editable. Note: You cannot select this option for a debit bill for which no credit line item exists, and therefore, in such case, this option is disabled.	No
Hold Amount	Displays the amount of the debit or credit bill which is kept on hold through an hold request.	Not applicable
Outstanding Amount (Offset Currency)	Displays the outstanding amount (i.e. unpaid amount) of the debit or credit bill in the currency in which the bill amount would be offset. Note: This field appears when the offset request is a cross-currency offset request.	Not applicable
Offset Amount	Used to specify the amount which you want to offset from the debit or credit bill.	Yes
Remaining Bill Balance	Displays the remaining outstanding amount of the debit or credit bill (i.e. Outstanding Amount - Hold Amount - Offset Amount).	Not applicable
Updated Hold Amount	Displays the new hold amount (i.e. Current Hold Amount + Remaining Bill Balance) for the debit or credit bill which is derived when the remaining bill balance is less than the current hold amount.	Not applicable

The **Delete** (🗑️) icon appears corresponding to the secondary debit or credit bills in the **Offset Details** section. It allows you to remove the respective bill from the offset request.

2. Modify the offset amount of the required debit or credit bill in the **Offset Details** section.
3. Click **Save**.

The changes made to the offset request are saved.

Related Topics

For more information on...	See...
How to edit an offset request	Editing an Offset Request on page 1601

For more information on...	See...
How to remove a debit or credit bill from an offset request	Removing a Debit or Credit Bill from an Offset Request on page 1606

Removing a Debit or Credit Bill from an Offset Request

Procedure

To remove a debit or credit bill from an offset request:

1. Ensure that the **Offset Details** section is expanded when you are editing an offset request.
2. Click the **Delete** (🗑️) icon corresponding to the debit or credit bill that you want to remove from the offset request.

A message appears confirming whether you want to delete the bill.

Note: The **Delete** (🗑️) icon appears corresponding to the secondary debit or credit bills. It does not appear corresponding to the primary debit or credit bill. This is because you cannot remove a primary debit or credit bill from the offset request throughout its lifecycle.

3. Click **OK**.

The debit or credit bill is removed from the offset request.

Related Topics

For more information on...	See...
How to edit an offset request	Editing an Offset Request on page 1601

Deleting an Offset Request

Procedure

To delete an offset request:

1. Search for the offset request in the **Offset Request** screen.
2. In the **Search Results** section, click the link in the **Offset Request Information** column corresponding to the offset request that you want to delete.

The **Offset Request** screen appears.

3. Ensure that the **Main** tab is selected.
4. Click the **Delete** button in the **Offset Request** zone.

A message appears confirming whether you want to delete the offset request.

Note: The **Delete** button appears when the offset request is in the **Draft** status.

5. Click **OK**.

The offset request is deleted.

Related Topics

For more information on...	See...
How to search for an offset request	Searching for an Offset Request on page 1586
Offset Request screen	Offset Request (Used for Viewing) on page 1589

For more information on...	See...
Offset Request zone	Offset Request on page 1590

Submitting an Offset Request

Prerequisites

To submit an offset request, you should have:

- At least one debit and credit bills added to the offset request
- Offset amount of each bill not equal to zero
- Total debit offset amount equal to total credit offset amount in the offset request
- Negative offset amount for each debit bill and positive offset amount for each credit bill
- Offset amount less than or equal to the current outstanding amount of the bill

Procedure

To submit an offset request:

1. Search for the offset request in the **Offset Request** screen.
2. In the **Search Results** section, click the link in the **Offset Request Information** column corresponding to the offset request which you want to submit.

The **Offset Request** screen appears.

3. Ensure that the **Main** tab is selected.
4. Click the **Submit** button in the **Offset Request** zone.

The system behaves in the following manner:

If...	Then
The Approval Required option is selected in the respective offset request type	A To Do of the C1-OFSRQ To Do type is created and sent to the approver. The status of the offset request is then changed to Approval In Progress .
The Approval Required option is not selected in the respective offset request type and the number of financial transactions created for the bills (which are selected in the offset request) exceeds the defer processing count (defined in the respective offset request type)	The status of the offset request is changed to Deferred Processing . On executing the Offset Request Periodic Monitor (C1-OFSRQ) batch, the system considers the offset requests which are in the Deferred Processing status. If the Transfer Adjustment option is selected in the respective offset request type, the system creates the transfer adjustments using the adjustment type which is specified in the offset request. The status of the transfer adjustments is set to Frozen . However, if the Transfer Adjustment option is not selected in the respective offset request type, the system creates the offset adjustments using the adjustment type which is specified in the offset request. The status of the offset adjustments is set to Frozen . Finally, the status of the offset request is changed to Processed .

If...	Then
	<p>Note: If a match event exists for the match type entity (i.e. bill, bill segment, or contract), the existing match event is stamped on the offset or transfer adjustment and on the corresponding bill segment or bill segment cancelation financial transaction. However, if a match event does not exist, a new match event is created and stamped on the offset or transfer adjustment and on the corresponding bill segment or bill segment cancelation financial transaction. In case of partial offset, the status of the corresponding match event is set to Open. However, if the entire match type entity amount is offset, the status of the corresponding match event is set to Balanced. For more information on how the offset amount is distributed, see CI-OFST-DIST on page 1560.</p>
<p>The Approval Required option is not selected in the respective offset request type and the number of financial transactions created for the bills (which are selected in the offset request) does not exceed the defer processing count (defined in the respective offset request type)</p>	<p>If the Transfer Adjustment option is selected in the respective offset request type, the system creates the transfer adjustments using the adjustment type which is specified in the offset request. The status of the transfer adjustments is set to Frozen. However, if the Transfer Adjustment option is not selected in the respective offset request type, the system creates the offset adjustments using the adjustment type which is specified in the offset request. The status of the offset adjustments is set to Frozen. Finally, the status of the offset request is changed to Processed.</p> <p>Note: If a match event exists for the match type entity (i.e. bill, bill segment, or contract), the existing match event is stamped on the offset or transfer adjustment and on the corresponding bill segment or bill segment cancelation financial transaction. However, if a match event does not exist, a new match event is created and stamped on the offset or transfer adjustment and on the corresponding bill segment or bill segment cancelation financial transaction. In case of partial offset, the status of the corresponding match event is set to Open. However, if the entire match type entity amount is offset, the status of the corresponding match event is set to Balanced. For more information on how the offset amount is distributed, see CI-OFST-DIST on page 1560.</p>

Note: The **Submit** button appears when the offset request is in the **Draft** status.

Related Topics

For more information on...	See...
How to search for an offset request	Searching for an Offset Request on page 1586
Offset Request screen	Offset Request (Used for Viewing) on page 1589
Offset Request zone	Offset Request on page 1590

Approving an Offset Request

You can view the number of offset requests which are pending for approval in the **Offset Request** screen. The approver can review, and accordingly approve or reject the offset request based on the observations.

Note: The system will not allow you to approve or reject an offset request submitted by you.

Prerequisites

To approve an offset request, you should have:

- Approval To Do role assigned in the system

Procedure

To approve an offset request:

1. Do either of the following:

If you want to...	Then...
Approve an offset request through the Offset Request screen	<ol style="list-style-type: none"> 1. Search for the offset request in the Offset Request screen. 2. In the Search Results section, click the link in the Offset Request Information column corresponding to the offset request which you want to review.
Approve an offset request through the To Do List screen	<ol style="list-style-type: none"> 1. Click the Menu link in the Application toolbar. A list appears. 2. From the Main menu, select To Do and then click To Do List. The To Do Type for User Search window appears. 3. Enter C1-OFSRQ in the To Do Type field. 4. Click the Search button corresponding to the To Do Type field. The To Do List screen appears. 5. Select the Open option from the Filter by list to view all unassigned To Dos. 6. Click the link in the Message column corresponding to the To Do of the offset request that you want to review.

The **Offset Request** screen appears.

2. Review the details in the **Offset Request** screen.
3. If the information in the offset request is accurate, click the **Approve** button in the **Offset Request** zone.

The system behaves in the following manner:

If...	Then
The number of financial transactions created for the bills (which are selected in the offset request) exceeds the defer processing count (defined in the respective offset request type)	The status of the offset request is changed to Deferred Processing . On executing the Offset Request Periodic Monitor (C1-OFSRQ) batch, the system considers the offset requests which are in the Deferred Processing status. If the Transfer Adjustment option is selected in the respective offset request type, the system creates the transfer adjustments

If...	Then
	<p>using the adjustment type which is specified in the offset request. The status of the transfer adjustments is set to Frozen. However, if the Transfer Adjustment option is not selected in the respective offset request type, the system creates the offset adjustments using the adjustment type which is specified in the offset request. The status of the offset adjustments is set to Frozen. Finally, the status of the offset request is changed to Processed.</p> <p>Note: If a match event exists for the match type entity (i.e. bill, bill segment, or contract), the existing match event is stamped on the offset or transfer adjustment and on the corresponding bill segment or bill segment cancelation financial transaction. However, if a match event does not exist, a new match event is created and stamped on the offset or transfer adjustment and on the corresponding bill segment or bill segment cancelation financial transaction. In case of partial offset, the status of the corresponding match event is set to Open. However, if the entire match type entity amount is offset, the status of the corresponding match event is set to Balanced. For more information on how the offset amount is distributed, see CI-OFST-DIST on page 1560.</p>
<p>The number of financial transactions created for the bills (which are selected in the offset request) does not exceed the defer processing count (defined in the respective offset request type)</p>	<p>If the Transfer Adjustment option is selected in the respective offset request type, the system creates the transfer adjustments using the adjustment type which is specified in the offset request. The status of the transfer adjustments is set to Frozen. However, if the Transfer Adjustment option is not selected in the respective offset request type, the system creates the offset adjustments using the adjustment type which is specified in the offset request. The status of the offset adjustments is set to Frozen. Finally, the status of the offset request is changed to Processed.</p> <p>Note: If a match event exists for the match type entity (i.e. bill, bill segment, or contract), the existing match event is stamped on the offset or transfer adjustment and on the corresponding bill segment or bill segment cancelation financial transaction. However, if a match event does not exist, a new match event is created and stamped on the offset or transfer adjustment and on the corresponding bill segment or bill segment cancelation financial transaction. In case of partial offset, the status of the corresponding match event is set to Open. However, if the entire match type entity amount is offset, the status of the corresponding match event is set to Balanced. For more information on how the offset amount is distributed, see CI-OFST-DIST on page 1560.</p>

Note: The **Approve** button appears when:

- The offset request is in the **Approval In Progress** status.
- A user with the approval To Do role is reviewing the offset request.

Related Topics

For more information on...	See...
How to search for an offset request	Searching for an Offset Request on page 1586
Offset Request screen	Offset Request (Used for Viewing) on page 1589
Offset Request zone	Offset Request on page 1590

Rejecting an Offset Request**Prerequisites**

To reject an offset request, you should have:

- Reasons defined for the **Rejected** status of the **C1-OffsetRequest** business object in the **Status Reason** screen

Note: The system will not allow you to approve or reject an offset request submitted by you.

Procedure

To reject an offset request:

- Do either of the following:

If you want to...	Then...
Reject an offset request through the Offset Request screen	<ol style="list-style-type: none"> Search for the offset request in the Offset Request screen. In the Search Results section, click the link in the Offset Request Information column corresponding to the offset request which you want to review.
Reject an offset request through the To Do List screen	<ol style="list-style-type: none"> Click the Menu link in the Application toolbar. A list appears. From the Main menu, select To Do and then click To Do List. The To Do Type for User Search window appears. Enter C1-OFSRQ in the To Do Type field. Click the Search button corresponding to the To Do Type field. The To Do List screen appears. Select the Open option from the Filter by list to view all unassigned To Dos. Click the link in the Message column corresponding to the To Do of the offset request that you want to review.

The **Offset Request** screen appears.

- Review the details in the **Offset Request** screen.
- If the information in the offset request is incorrect, click the **Reject** button in the **Offset Request** zone.

The **Reject Offset Request** window appears. It contains following fields:

Field Name	Field Description	Mandatory (Yes or No)
Status Reason	Used to indicate the reason why you want to reject the offset request.	Yes
Comments	Used to specify additional information while rejecting the offset request.	No

Note: The **Reject** button appears when:

- The offset request is in the **Approval In Progress** status.
- A user with the approval To Do role is reviewing the offset request.

4. Select the reason for rejecting the offset request from the **Status Reason** list.

5. Click **Save**.

The status of the offset request is changed to **Rejected**.

Related Topics

For more information on...	See...
How to search for an offset request	Searching for an Offset Request on page 1586
Offset Request screen	Offset Request (Used for Viewing) on page 1589
Offset Request zone	Offset Request on page 1590

Unapplying an Offset Request

There might be situations when an incorrect offset request is processed in the system. In such case, the system provides you with an ability to unapply (i.e. cancel) the offset request. However, note that you can cancel an offset request when the offset request is in the **Processed** status.

Prerequisites

To cancel an offset request, you should have:

- Reasons defined for the **Unapplied Offset** status of the **C1-OffsetRequest** business object in the **Status Reason** screen

Procedure

To cancel an offset request:

1. Search for the offset request in the **Offset Request** screen.
2. In the **Search Results** section, click the link in the **Offset Request Information** column corresponding to the offset request that you want to cancel.

The **Offset Request** screen appears.

3. Click the **Unapply** button in the **Offset Request** zone.

The **Unapply Reason** window appears. It contains the following fields:

Field Name	Field Description	Mandatory (Yes or No)
Unapply Reason	Used to indicate the reason why you want to cancel the offset request.	Yes

Field Name	Field Description	Mandatory (Yes or No)
Comments	Used to specify additional information while canceling the offset request.	No

Note: The **Unapply** button appears when the offset request is in the **Processed** status.

- Select the reason for canceling the offset request from the **Unapply Reason** list.
- Click **Save**.

The system behaves in the following manner:

If...	Then...
The number of transfer or offset adjustments does not exceed the online record process limit (which is defined in the C1-DFRUNAPLY algorithm)	The system cancels the frozen transfer or offset adjustments immediately and then changes the status of the offset request to Unapplied Offset .
The number of transfer or offset adjustments exceeds the online record process limit (which is defined in the C1-DFRUNAPLY algorithm)	The system changes the status of the offset request to Defer Unapplied . On executing the Offset Request Periodic Monitor (C1-OFSRQ) batch, the system considers the offset requests which are in the Defer Unapplied status. The system then cancels the frozen transfer or offset adjustments of the offset request and changes the status of the offset request to Unapplied Offset .

Related Topics

For more information on...	See...
How to search for an offset request	Searching for an Offset Request on page 1586
Offset Request screen	Offset Request (Used for Viewing) on page 1589
Offset Request zone	Offset Request on page 1590

Viewing the Log of an Offset Request

Procedure

To view the log of an offset request:

- Search for the offset request in the **Offset Request** screen.
- In the **Search Results** section, click the link in the **Offset Request Information** column corresponding to the offset request whose details you want to view.

The **Offset Request** screen appears.

- Click the **Log** tab.

The **Log** tab appears.

- View the complete trail of actions performed on the offset request in the **Offset Request Log** zone.

Related Topics

For more information on...	See...
How to search for an offset request	Searching for an Offset Request on page 1586

For more information on...	See...
Offset Request screen	Offset Request (Used for Viewing) on page 1589
Offset Request Log zone	Offset Request Log on page 1599
How to add a log entry for an offset request	Adding a Log Entry for an Offset Request on page 1614

Adding a Log Entry for an Offset Request

Procedure

To add a log entry for an offset request:

1. Search for the offset request in the **Offset Request** screen.
2. In the **Search Results** section, click the link in the **Offset Request Information** column corresponding to the offset request for which you want to add a log entry.

The **Offset Request** screen appears.

3. Click the **Log** tab.

The **Log** tab appears.

4. Click the **Add Log Entry** link in the upper right corner of the **Offset Request Log** zone.

The **Add Request Log** window appears. It contains the following fields:

Field Name	Field Description	Mandatory (Yes or No)
Request Information	Displays information about the offset request.	Not applicable
Log Details	Used to specify additional comments for the offset request.	Yes

5. Enter the comments in the **Log Details** field.
6. Click **Save**.

The log entry is added in the **Offset Request Log** zone.

Related Topics

For more information on...	See...
How to search for an offset request	Searching for an Offset Request on page 1586
Offset Request screen	Offset Request (Used for Viewing) on page 1589
Offset Request Log zone	Offset Request Log on page 1599

Chapter 24

Funding Request

Topics:

- [Prerequisites](#)
- [Funding Request \(Without Approval\) Status Transition](#)
- [Funding Request \(With Approval\) Status Transition](#)
- [Algorithms Used in C1-FundingReq](#)
- [Funding Request Type](#)
- [Funding Request \(Used for Searching\)](#)
- [Funding Request \(Used for Viewing\)](#)

Oracle Revenue Management and Billing provides the automatic payment facility for an account. The system automatically calculates the automatic payment amount during the bill completion and stamps these details against the bill in the **CI_BILL_ACH** table. However, there might be situations when you would like to do the following before stamping the automatic payment amount against the bill in the **CI_BILL_ACH** table:

- Hold certain amount on the bill through a hold request
- Offset the bill against another bill through an offset request
- Transfer the amount on the credit bill to one or more garnishment contracts of the account

The system enables you to change the automatic payment amount through the funding process. The funding process supports all three automatic payment creation options (i.e. Create At Bill Completion, Create On Extract Date, and Freeze Payment on Notification).

While creating a funding request, you need to specify a funding request type using which you want to create the funding request. It is the funding request type which helps the system to determine:

- The business object using which the funding request should be created in the system.
- The currency in which the total debit and credit amount should be calculated.
- The account funding currency characteristic type which must be defined on the account. This characteristic indicates that the funding amount of the account's bills should be calculated in the specified currency.
- The default funding adjustment type using which the A/P adjustment should be created against a credit bill.

Note: In the **Default Funding Adjustment Type** field, you can only specify an adjustment type where the **A/P Request Type Code** field is set to **REFUND**.

- The default garnishment adjustment type using which the garnishment adjustment should be created when the amount from the credit bill is transferred to the garnishment contract of the account.

Note: In the **Default Garnishment Adjustment Type** field, you can only specify an adjustment type where the **A/P Request Type Code** field is not set to **REFUND**.

- Whether the approval is required for the funding request.

- An algorithm which helps to calculate the threshold range for a bill based on the number of payments made for the bill in the specified period.
- Whether a funding request must be processed in the deferred mode when the number of bills in the funding request exceeds the defer processing count.
- The currency conversion algorithms which must be used while determining the approval hierarchy for the funding request.

Note: The **Funding Request (C1-FundingReq)** business object is shipped with the product.

Once you specify a funding request type, the funding request is created in the **Draft** status. You can then add one or more debit or credit bills in the funding request. Note that you can only add bills of those accounts for which the **Defer Auto Pay** option is selected on the customer class. Once the bills are added, you can submit a funding request. Before you submit a funding request, you can do the following:

- Hold certain amount on the bill through a hold request
- Offset the bill against another bill through an offset request
- Transfer the amount on the credit bill to one or more garnishment contracts of the account

Note: The garnishment contract is a contract which is created using a contract type where the **Special Role Flag** field is set to **Garnishment**.

The system calculates the funding amount in the following manner:

Bill Type	Funding Amount for the Bill
Debit Bill	Outstanding Bill Amount – Hold Amount (set on the bill in a hold request) – Offset Amount (set on the bill in an offset request)
Credit Bill	Outstanding Bill Amount – Hold Amount (set on the bill in a hold request) – Offset Amount (set on the bill in an offset request) – Garnishment Amount (set on the bill in the funding request)

You can delete, cancel, or submit a funding request which is in the **Draft** status. On canceling a funding request, the status of all records in the funding request is changed to **Excluded** and the status of the funding request is changed to **Canceled**. On submitting a funding request, the status of the funding request is changed to either **Deferred Processing** or **Create Funding** depending on whether the number of bills in the funding request exceeds the defer processing count. Once the **Funding Request Periodic Monitor (C1-FNDRQ)** batch is executed, it checks whether there are any funding requests in the **Deferred Processing** status. If so, it changes the status of the funding request to **Create Funding**.

Once the status of a funding request is changed to **Create Funding**, the system creates the A/P adjustment against a bill when the funding amount of the bill is in credit. It also creates non A/P adjustments using the garnishment adjustment type when the funding amount of a credit bill is transferred to the garnishment contracts of the account. However, if the funding amount of a bill is in debit, the funding amount is stamped as the automatic payment amount against the bill in the **CI_BILL_ACH** table. Then, on executing the **Create Automatic**

Payments and Refunds (APAYCRET) batch, the system creates automatic payment and payment event for such bill.

You can optionally configure the approval process for the funding request. If the **Approval Required** option is selected in the funding request type, the status of the funding request is changed to **Approval In Progress** on submitting the funding request. The system calculates the sum of total debit and credit amount in the funding request. Depending on whether the sum total is debit or credit, the system uses the debit or credit hierarchy in the approval profile (which is specified in the funding request type), respectively. If the sum total is less than the minimum threshold amount, the system automatically approves the funding request and changes the status of the funding request to either **Deferred Processing** or **Create Funding** depending on whether the number of bills in the funding request exceeds the defer processing count. However, if the sum total is equal to or greater than the threshold amount specified at the first level in the approval hierarchy, the system creates a To Do using the To Do type specified in the approval profile and assigns it to the users with the To Do role defined at the first level in the approval hierarchy.

Once the approver at the first level in the approval hierarchy approves the funding request, the system checks whether the sum total of the debit and credit amount is equal to or greater than the threshold amount specified at the next level in the approval hierarchy. If the sum total of the debit and credit amount is equal to or greater than the threshold amount specified at the next level in the approval hierarchy, the system changes the status of the funding request to **Approval In Progress**. However, if the sum total of the debit and credit amount is less than the threshold amount specified at the next level in the approval hierarchy, the system changes the status of the funding request to either **Deferred Processing** or **Create Funding** depending on whether the number of bills in the funding request exceeds the defer processing count.

If an approver rejects a funding request, the status of the funding request is changed to **Rejected**. And, if an approver requests to resubmit a funding request for approval, the status of the funding request is changed to **Draft**. You can then edit the funding request and resubmit it for approval. The system allows the submitter to withdraw the funding request when it is in the **Approval In Progress** status. On withdrawing a funding request, the status of the funding request is changed to **Draft**.

If a funding request is created automatically through a custom batch, the system allows you to manually exclude some bills from the funding request when it is in the **Draft** status. You can exclude a bill from a funding request by changing its status to **Excluded**.

For more information on how to setup the funding request process, see [Prerequisites](#) on page 1618.

Prerequisites

To setup the funding request process, you need to do the following:

- Define the required funding request types in the system
- Define the required funding adjustment types where the **A/P Request Type Code** field is set to **REFUND**
- Define the required garnishment adjustment types where the **A/P Request Type Code** field is not set to **REFUND**
- Define the required characteristic types where the characteristic entity is set to **Funding Request Type**
- Define the required characteristic types where the characteristic entity is set to **Funding Request**
- Define the required approval profiles with the debit and credit approval hierarchy in the system
- Specify the **C1-FNDAP** To Do type in the approval profile which you want to use in the funding request's approval process
- Specify the **C1-FNDSB** as the submitter To Do type in the funding request types
- Define the status reasons for the **Rejected** status of the **C1-FundingRequest** business object in the **Status Reason** screen
- Assign the **C1-FNDAP** To Do type to a To Do role whose users must receive a To Do while submitting a funding request for approval
- Assign the **C1-FNDSB** To Do type to a To Do role whose users must receive a To Do when an approver requests to resubmit the funding request for approval
- Select the **Defer Auto Pay** option on the customer class of the accounts for which you want to use the funding process
- Define the values for the **CAN_RSN_CD_FLG** lookup field
- Define the **Funding Currency** characteristic type where the characteristic entity is set to **Account**
- Define a currency conversion algorithm for payments using the **C1_CURALGPY** algorithm type
- Define a currency conversion algorithm for adjustments using the **C1_CURALGAD** algorithm type
- Attach the currency conversion algorithms to the **Currency Conversion For Adjustments** and **Currency Conversion For Payments** algorithm spots to the required divisions
- Set the batch control type of the **Funding Request Periodic Monitor (C1-FNDRQ)** batch to **Timed** and define the following attributes:
 - Time Interval
 - Timer Active
 - User ID
 - Batch Language
 - Email Address

Funding Request (Without Approval) Status Transition

The following figure graphically indicates how a funding request moves from one status to another when the approval process is not configured in the funding request type:

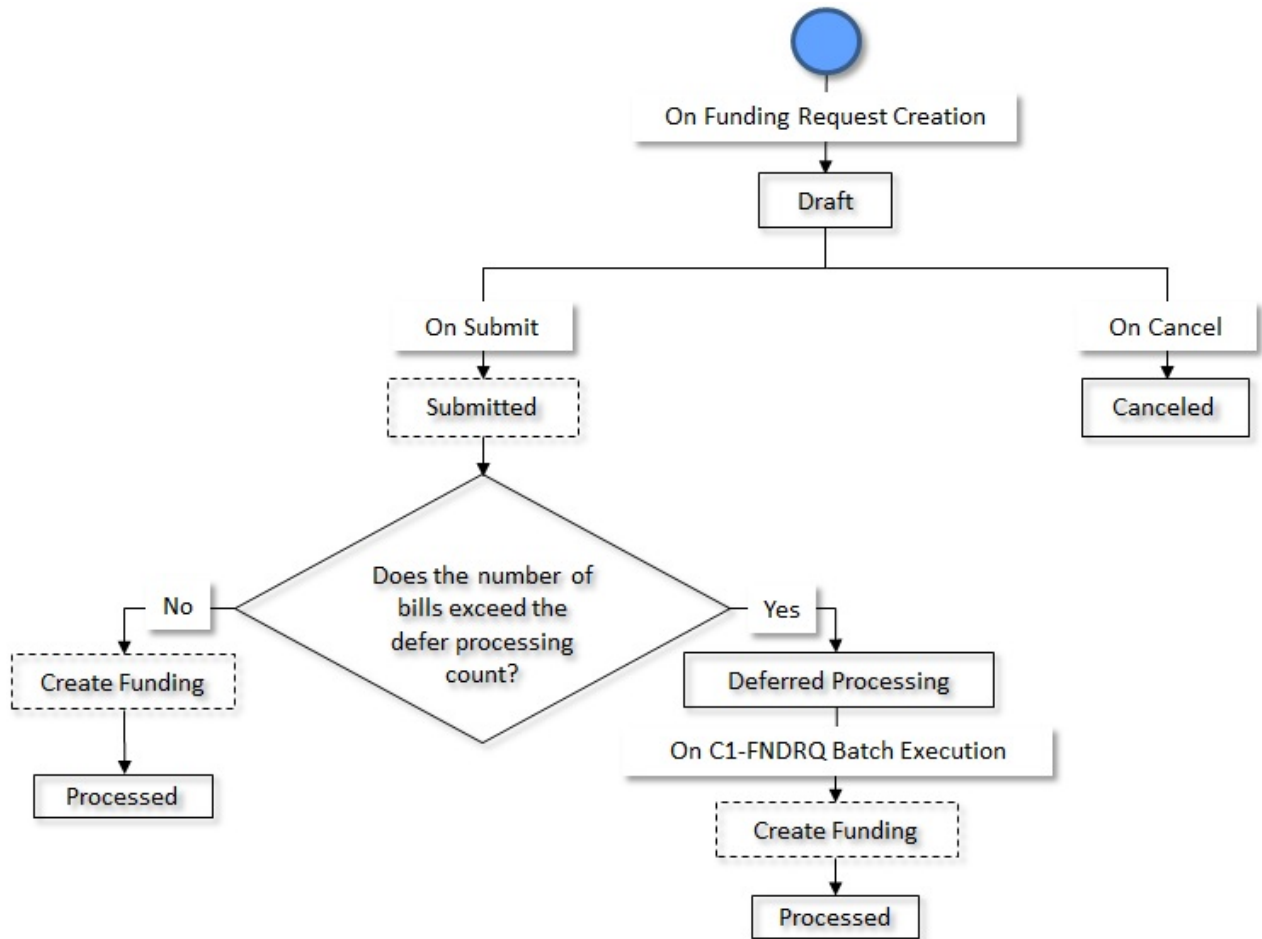

Funding Request (With Approval) Status Transition

The following figure graphically indicates how a funding request moves from one status to another when the approval process is configured in the funding request type:

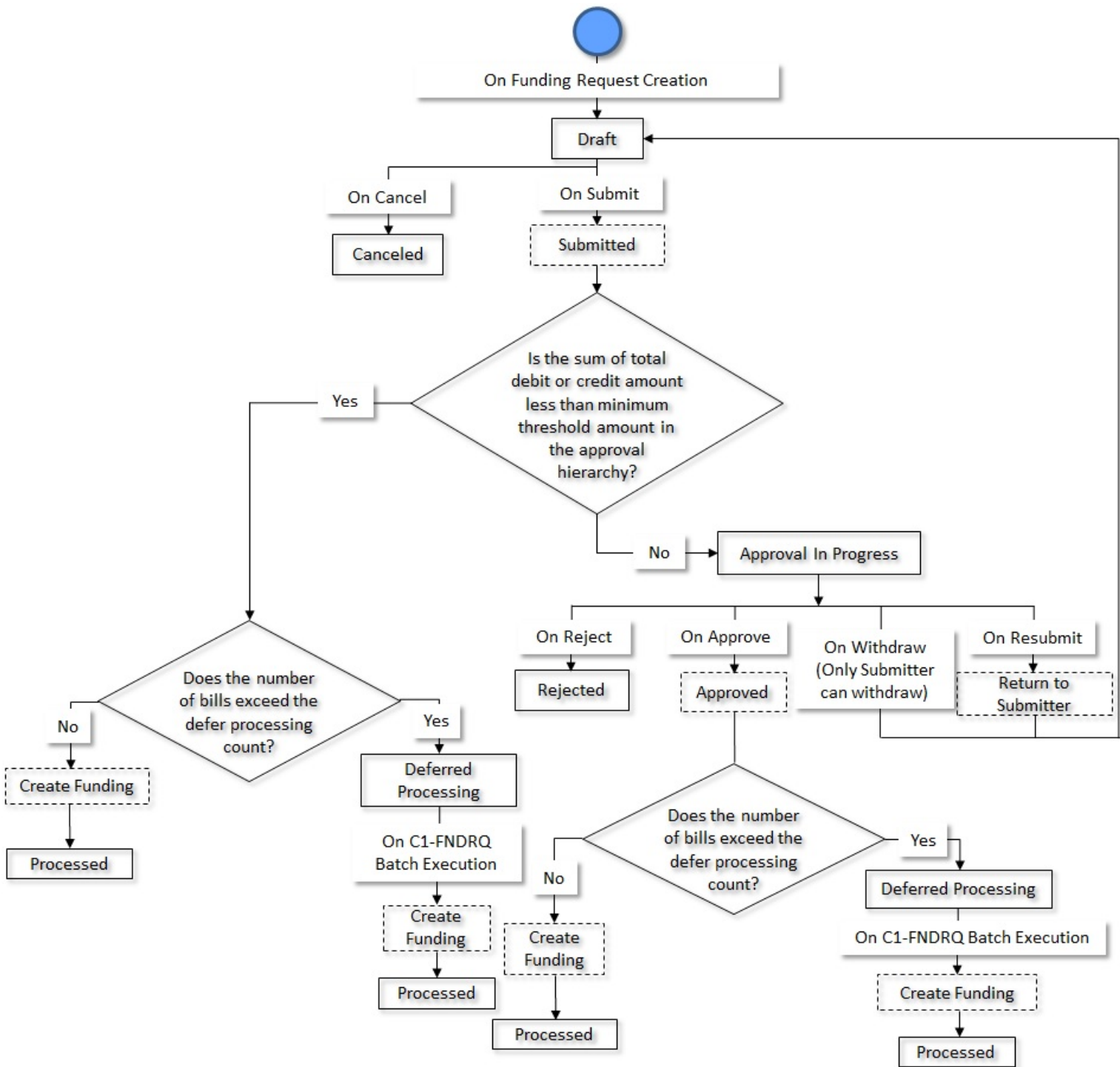

Algorithms Used in C1-FundingReq

The following table lists the algorithm which is attached to the **C1-FundingReq** business object:

System Event	Algorithm	Algorithm Type	Description
Information	C1-FUNDINFO	C1-FUNDINFO	Refer to C1-FUNDINFO on page 1621

The following table lists the algorithms which are used in the lifecycle of the **C1-FundingReq** business object:

Status	System Event	Algorithm	Algorithm Type	Description
Draft	Exit	F1-TODOCOMPL	F1-TODOCOMPL	Refer to F1-TODOCOMPL on page 1453
Submitted	Enter	C1-FUNDSUBMT	C1-FUNDSUBMT	Refer to C1-FUNDSUBMT on page 1621
Approval In Progress	Enter	C1-FUNDAPP	C1-FUNDAPP	Refer to C1-FUNDAPP on page 1622
Approval In Progress	Exit	F1-TODOCOMPL	F1-TODOCOMPL	Refer to F1-TODOCOMPL on page 1453
Approved	Enter	C1-FUNDAPRVD	C1-FUNDAPRVD	Refer to C1-FUNDAPRVD on page 1622
Rejected	-	-	-	-
Deferred Processing	Monitor	F1-AT-RQJ	F1-AT-RQJ	Refer to F1-AT-RQJ on page 1560
Return to Submitter	Enter	C1-FNDRESUBM	C1-FNDRESUBM	Refer to C1-FNDRESUBM on page 1623
Creating Funding	Monitor	F1-AT-RQJ	F1-AT-RQJ	Refer to F1-AT-RQJ on page 1560
Creating Funding	Enter	C1-FUNDVAL	C1-FUNDVAL	Refer to C1-FUNDVAL on page 1623
Creating Funding	Enter	C1-FUNDAPAY	C1-FUNDAPAY	Refer to C1-FUNDAPAY on page 1623
Creating Funding	Enter	C1-FUNDADJCR	C1-FUNDADJCR	Refer to C1-FUNDADJCR on page 1623
Processed	-	-	-	-
Canceled	Enter	C1-FUNDCANCL	C1-FUNDCANCL	Refer to C1-FUNDCANCL on page 1624

C1-FUNDINFO

This algorithm generates the funding request information string which appears throughout the application. It concatenates the following fields separated by a comma in the specified order:

1. Funding Request Type Description
2. Funding Request Status Description
3. Funding Request ID

C1-FUNDSUBMT

This algorithm is invoked when you submit a funding request. If the approval process is not configured in the funding request type, it changes the status of the funding request to either **Deferred Processing** or **Create Funding** depending on whether the number of bills in the funding request exceeds the defer processing count. If the approval process is configured in the funding request type, it calculates the sum of total debit and credit amount in the funding request. Depending on whether the sum total is debit or credit, it uses the debit or credit hierarchy in the approval profile (which is specified in the funding request type), respectively. If the sum total is less than the minimum threshold amount in the approval hierarchy, the funding request is automatically approved by the system and the status of the funding request is changed to either **Deferred Processing** or **Create Funding** depending on whether the number of bills in the funding

request exceeds the defer processing count. However, if the sum total is equal to or greater than the threshold amount specified at the first level in the approval hierarchy, the status of the funding request is changed to **Approval In Progress**.

Note: If the **Currency Conversion Required** option is selected in the approval profile, the system does currency conversion when the sum total of the debit and credit amount is in a currency which is different from the installation options currency. During the currency conversion of the sum total which is in debit, the system uses the currency conversion algorithm specified in the **Currency Conversion Payment Algorithm** field of the funding request type. However, during the currency conversion of the sum total which is in credit, the system uses the currency conversion algorithm specified in the **Currency Conversion Adjustment Algorithm** field of the funding request type.

C1-FUNDAPP

This algorithm is invoked when the status of the funding request is changed to **Approval In Progress**. It creates a To Do using the To Do type specified in the approval profile and assigns it to the users with the To Do role defined at the first level in the approval hierarchy. In addition, a log entry is created for the funding request when the To Do is created.

Note: If a funding request needs approval from the subsequent level in the approval hierarchy, this algorithm creates a To Do and assigns it to the users with the To Do role defined at the subsequent level in the approval hierarchy.

C1-FUNDAPRVD

This algorithm is invoked when you approve a funding request. It checks whether the sum total of the debit and credit amount is equal to or greater than the threshold amount specified at the next level in the approval hierarchy. If the sum total of the debit and credit amount is equal to or greater than the threshold amount specified at the next level in the approval hierarchy, the status of the funding request is changed to **Approval In Progress**. However, if the sum total of the debit and credit amount is less than the threshold amount specified at the next level in the approval hierarchy, the status of the funding request is changed to either **Deferred Processing** or **Create Funding** depending on whether the number of bills in the funding request exceeds the defer processing count.

Note: If the **Currency Conversion Required** option is selected in the approval profile, the system does currency conversion when the sum total of the debit and credit amount is in a currency which is different from the installation options currency. During the currency conversion of the sum total which is in debit, the system uses the currency conversion algorithm specified in the **Currency Conversion Payment Algorithm** field of the funding request type. However, during the currency conversion of the sum total which is in credit, the system uses the currency conversion algorithm specified in the **Currency Conversion Adjustment Algorithm** field of the funding request type.

F1-TODOCOMPL

This algorithm type completes the To Do entries that are linked to an object when the object exits the given status.

It finds and completes all open To Do entries where the business object's primary key is defined as a drill key. However, if the **Exclude To Do Entries From Auto Completion** characteristic is set to **Y** for the business object, the system does not automatically complete the respective To Do entry.

F1-AT-RQJ

This algorithm transitions the current status of the business object to the specified status. It contains the following parameters:

- **Next Status** – Used when you want to override the default next status specified in the lifecycle.
- **Next Transition Condition** – Used when you want to override the default next transition condition specified in the lifecycle.

At a time, you can specify value for either the **Next Status** or **Next Transition Condition** parameter. If you don't specify any value for these parameters, the system will transition the business object to the default next status specified in its lifecycle.

C1-FNDRESUBM

This algorithm is invoked when the status of the funding request is changed to **Return to Submitter**. It changes the status of the funding request to **Draft**. The submitter can then make the required changes and resubmit the funding request for approval. In addition, it creates a To Do using the submitter To Do type which is specified in the funding request type. Once a To Do is created, it is assigned to all users with a submitter To Do role which is specified in the funding request type.

C1-FUNDVAL

This algorithm is invoked when the status of the funding request is changed to **Create Funding**. It checks whether the funding amount of a debit bill is equal to the bill outstanding amount minus hold and offset amount set on the bill (i.e. $\text{Funding Amount} = \text{Outstanding Bill Amount} - \text{Hold Amount} - \text{Offset Amount}$). Similarly, it checks whether the funding amount of a credit bill is equal to the bill outstanding amount minus hold, offset, and garnishment amount set on the bill (i.e. $\text{Funding Amount} = \text{Outstanding Bill Amount} - \text{Hold Amount} - \text{Offset Amount} - \text{Garnishment Amount}$). If so, it executes the next algorithm. However, if the funding amount is incorrect, the status of the record in the funding request is changed to **Error**.

C1-FUNDAPAY

If the funding amount of a bill is in debit, it stamps the funding amount as the automatic payment amount against the bill in the **CI_BILL_ACH** table. Then, on executing the **Create Automatic Payments and Refunds (APAYCRET)** batch, the system creates automatic payment and payment event for such bill.

It considers the records in the funding request which are in the **Pending** status. Once the **CI_BILL_ACH** table is updated, the status of the record in the funding request is changed to **Processed**. If any error occurs while updating the **CI_BILL_ACH** table, the status of the record in the funding request is changed to **Error**.

C1-FUNDADJCR

If the funding amount of a bill is in credit, it creates the A/P adjustments using the funding adjustment type. It also creates non A/P adjustments using the garnishment adjustment type when the funding amount of a credit bill is transferred to the garnishment contracts of the account.

It considers the records in the funding request which are in the **Pending** status. Once the adjustments are created, the status of the record in the funding request is changed to **Processed**. If any error occurs while creating the adjustments, the status of the record in the funding request is changed to **Error**.

Points to Note:

- The system uses the funding and garnishment adjustment types from the funding request.
- The main customer's address is used while creating the A/P adjustment for a credit bill.
- The garnishment adjustments are created against the garnishment contracts of the account. A garnishment contract is a contract which is created using a contract type where the **Special Role Flag** field is set to **Garnishment**.
- The system allows you to transfer funding amount to multiple garnishment contracts of the account. Accordingly, the number of non A/P adjustments will be created using the garnishment adjustment type.

It contains the following parameters:

- **Adjustment Type** - Used to indicate the adjustment type using which the adjustment should be created against the credit bill for internal offsetting.
- **Match Type Entity Flag** - Used to indicate the match type entity on which a new match event must be created when no payment exists for the credit bill. The valid values are:
 - **BILL** - Used when you want to create the same match event on all financial transactions of a bill.
 - **BSEG** - Used when you want to create a unique match event for each bill line item (such as, bill segment or adjustment).

- **SA** - Used when you want to create the same match event on the bill line items which are created against the same contract.

C1-FUNDCANCL

This algorithm is invoked when you cancel a funding request. It excludes all debit and credit bills from the funding request and changes the status of each record in the funding request to **Excluded**. In addition, the status of the funding request is changed to **Canceled**.

Funding Request Type

Oracle Revenue Management and Billing allows you to define a funding request type using which you can create a funding request. It is the funding request type which helps the system to determine the following:

- The business object using which the funding request should be created in the system.
- The currency in which the funding amount should be calculated.
- The default funding adjustment type using which the A/P adjustment should be created against a credit bill on submitting the funding request.

Note: In the **Default Funding Adjustment Type** field, you can only specify an adjustment type where the **A/P Request Type Code** field is set to **REFUND**.

- The default garnishment adjustment type using which the garnishment adjustment should be created when the amount from the credit bill is moved to the garnishment contract of the account.

Note: In the **Default Garnishment Adjustment Type** field, you can only specify an adjustment type where the **A/P Request Type Code** field is not set to **REFUND**.

- Whether the approval is required for the funding request.
- An algorithm which helps to calculate the threshold range for a bill based on the number of payments made for the bill in the specified period.
- Whether a funding request must be processed in the deferred mode when the number of bills in the funding request exceeds the defer processing count.

The **Funding Request Type** screen allows you to define, edit, delete, and copy a funding request type. It contains the following zones:

- [Funding Request Type List](#) on page 1624
- [Funding Request Type](#) on page 1625

Funding Request Type List

The **Funding Request Type List** zone lists the funding request types that are already defined in the system. It contains the following columns:

Column Name	Column Description
Funding Request Type	Displays the funding request type.
Description	Displays the description of the funding request type.
Edit	On clicking the Edit (✎) icon, the Funding Request Type screen appears where you can edit the details of the funding request type.

Column Name	Column Description
Duplicate	On clicking the Duplicate (📄) icon, the Funding Request Type screen appears where you can define a new funding request type using an existing funding request type.
Delete	On clicking the Delete (🗑️) icon, you can delete the funding request type.
	Note: You can delete a funding request type when you have not created a funding request using the funding request type.

On clicking the **Broadcast** (📡) icon corresponding to a funding request type, the **Funding Request Type** zone appears with the details of the respective funding request type.

Related Topics

For more information on...	See...
How to edit a funding request type	Editing a Funding Request Type on page 1636
How to copy a funding request type	Copying a Funding Request Type on page 1643
How to delete a funding request type	Deleting a Funding Request Type on page 1643
How to view the details of a funding request type	Viewing the Funding Request Type Details on page 1650

Funding Request Type

The **Funding Request Type** zone displays the details of the funding request type. It contains of the following sections:

- **Main** - Displays the basic information about the funding request type. It contains the following fields:

Field Name	Field Description
Funding Request Type	Displays the funding request type.
Description	Displays the description of the funding request type.
Funding Request Business Object	Indicates the business object that will be used to create the funding request. In addition, a context menu appears corresponding to this field which helps in navigating to other screens in the application.
	Note: It has a link. On clicking the link, the Business Object screen appears where you can view the details of the respective business object.
Detailed Description	Displays additional information about the funding request type.
Status	Indicates the status of the funding request type. The valid values are: <ul style="list-style-type: none"> • Active • Inactive
Funding Amount Currency	Indicates the currency in which the total debit and credit amount should be calculated in the funding request. The total debit and credit amount appears in the Statistics section of the Funding Request zone.
Account Funding Currency Characteristic Type	Indicates the characteristic type which should be defined on the account. This characteristic indicates that the funding amount of the account's bills should be converted in the specified currency.

Field Name	Field Description
Default Funding Adjustment Type	Indicates the adjustment type using which the funding adjustments must be created.
	Note: It has a link. On clicking the link, the Adjustment Type screen appears where you can view the details of the respective adjustment type.
Default Garnishment Adjustment Type	Indicates the garnishment adjustment type using which the garnishment adjustments must be created.
	Note: It has a link. On clicking the link, the Adjustment Type screen appears with the details of the respective adjustment type.
Threshold Range Algorithm	Indicates the threshold range for a bill based on the payments done for the bill.
	Note: It has a link. On clicking the link, the Algorithm screen appears where you can view the details of the respective algorithm.
Defer Processing Count	Displays the number of bills to determine if the funding request will be processed in deferred mode.
	Note: If the number of bills is less than the Defer Processing Count , the funding request will be processed in real time (i.e. immediately).
Approval Required	Indicates whether approval is required while creating the funding adjustments using the funding request type.
Approval Profile	Indicates the approval profile which must be used to define approval hierarchy for the funding request type.
	Note: The Approval Profile field appears when the Approval Required check box is selected. It has a link. On clicking the link, the Approval Profile screen appears where you can view the details of the respective approval profile.
Submitter To Do Type	Indicates the To Do type for the submitter when the funding request type is resubmitted by the approver.
	Note: The Submitter To Do Type field appears when the Approval Required check box is selected. It has a link. On clicking the link, the To Do Type screen appears where you can view the details of the respective To Do type.
Submitter To Do Role	Indicates the To Do role for the submitter when the funding request type is resubmitted by the approver.

Field Name	Field Description
	<p>Note:</p> <p>The Submitter To Do Role field appears when the Approval Required check box is selected.</p> <p>It has a link. On clicking the link, the To Do Role screen appears where you can view the details of the respective To Do role.</p>
Currency Conversion Adjustment Algorithm	Indicates the currency conversion algorithm. It is used while determining the approval hierarchy for a funding request when the sum total of the debit and credit amount (i.e. which is in credit) is different from the installation options currency.
Currency Conversion Payment Algorithm	Indicates the currency conversion algorithm. It is used while determining the approval hierarchy for a funding request when the sum total of the debit and credit amount (i.e. which is in debit) is different from the installation options currency.

- **Characteristics** - The **Characteristics** section lists the characteristics of the funding request type. It contains the following columns:

Column Name	Column Description
Characteristic Type	Indicates the characteristic type.
Characteristic Value	Displays the value of the characteristic type.

- **Record Actions** - The **Record Actions** section contains the following buttons:

Button Name	Button Description
Edit	Used to edit the details of the funding request type.
Delete	Used to delete the funding request type.
	<p>Note: You can delete a funding request type when you have not created a funding request using the funding request type.</p>
Duplicate	Used to create a new funding request type using an existing funding request type.

- **Record Information** - The **Record Information** section contains the following fields:

Field Name	Field Description
Business Object	Indicates the business object using which the funding request type is created. In addition, a context menu appears corresponding to this field which helps in navigating to other screens in the application.
	<p>Note: It has a link. On clicking the link, the Business Object screen appears where you can view the details of the respective business object.</p>

By default, the **Funding Request Type** zone does not appear in the **Funding Request Type** screen. It appears when you click the **Broadcast** (📡) icon corresponding to the funding request type in the **Funding Request Type List** zone.

Related Topics

For more information on...	See...
How to define a funding request type	Defining a Characteristic for a Funding Request Type on page 1635
How to edit a funding request type	Editing a Funding Request Type on page 1636
How to copy a funding request type	Copying a Funding Request Type on page 1643
How to delete a funding request type	Deleting a Funding Request Type on page 1643
How to view the details of a funding request type	Viewing the Funding Request Type Details on page 1650

Defining a Funding Request Type

Prerequisites

To define a funding request type, you should have:

- Funding request type business objects defined in the application
- Funding request business objects defined in the application
- Currencies defined in the application
- Funding adjustment types defined in the application (where the **A/P Request Type Code** field is set to **REFUND**)
- Garnishment adjustment types defined in the application (where the **A/P Request Type Code** field is not set to **REFUND**)
- A threshold range algorithm defined using the **C1-FDRTTR** algorithm type
- Required approval profiles defined in the application
- A To Do role assigned to the **C1-FNDSB** To Do type in the application
- Funding currency characteristic type defined in the application (where the characteristic entity is set to **Account**)
- A currency conversion algorithm defined for payments and adjustments using the **C1_CURALGPY** and **C1_CURALGAD** algorithm type, respectively

Procedure

To define a funding request type:

1. Click the **Admin** link in the **Application** toolbar.
A list appears.
2. From the **Admin** menu, select **F** and then click **Funding Request Type**.
A sub-menu appears.
3. Click the **Add** option from the **Funding Request Type** sub-menu.

The **Select Business Object** screen appears. It contains the following field:

Field Name	Field Description	Mandatory (Yes or No)
Funding Request Type Business Object	Used to indicate the business object using which you want to create the funding request type.	Yes

Tip: Alternatively, you can access the **Select Business Object** screen by clicking the **Add** button in the **Page Title** area of the **Funding Request Type** screen.

Note: The **Select Business Object** screen appears when there are multiple funding request type business objects defined in the application. If there is only one funding request type business object defined in the application, the **Funding Request Type** screen appears.

4. Select the required funding request type business object from the respective field.
5. Click **OK**.

The **Funding Request Type** screen appears. It contains the following sections:

- **Main** - Used to specify basic details about the funding request type.
- **Characteristics** - Used to define the characteristics for the funding request type.

The **Main** section contains the following fields:



Field Name	Field Description	Mandatory (Yes or No)
Funding Request Type	Used to specify the funding request type.	Yes
Business Object	Indicates the business object using which you are defining the funding request type.	Not applicable
Description	Used to specify the description for the funding request type.	Yes
Funding Request Business Object	Used to indicate the business object using which you want to create the funding request.	Yes
Detailed Description	Used to specify additional information about the funding request type.	No
Status	Used to indicate the status of the funding request type. The valid values are: <ul style="list-style-type: none"> • Active • Inactive 	Yes
	Note: You cannot change the status of a funding request type to Inactive when the corresponding funding request is in a status other than Processed or Rejected .	
Funding Amount Currency	Used to indicate the currency in which the total debit and credit amount should be calculated in the funding request. The total debit and credit amount appears in the Statistics section of the Funding Request zone.	Yes

Field Name	Field Description	Mandatory (Yes or No)
	<p>Note:</p> <p>The list includes only those currencies which are defined in the system.</p> <p>If the currency specified in this field is different from the bill's currency, the system does currency conversion before calculating the total debit and credit amount in the funding request. The total debit amount is the sum of funding amount of all bills whose funding amount is in debit. However, the total credit amount is the sum of funding amount and garnishment amount of all bills whose funding amount is in credit. While calculating the total debit amount, the system uses the currency conversion algorithm attached to the Currency Conversion For Payments algorithm spot of the account's division. However, while calculating the total credit amount, the system uses the currency conversion algorithm attached to the Currency Conversion For Adjustments algorithm spot of the account's division.</p>	
Account Funding Currency Characteristic Type	Used to indicate the characteristic type. This characteristic should be defined on the account. This characteristic indicates that the funding amount of the account's bills should be converted in the specified currency.	Yes

Field Name	Field Description	Mandatory (Yes or No)
	<p>Note:</p> <p>The Search (🔍) icon appears corresponding to the Account Funding Currency Characteristic Type field. On clicking the Search icon, the Characteristic Type Search window appears.</p> <p>You must specify a characteristic type where the characteristic entity is set to Account.</p> <p>The converted amount appears in the Funding Currency Amount column of the Selected Bills zone in the Funding Request screen.</p> <p>If the funding amount is in debit, the system uses the currency conversion algorithm attached to the Currency Conversion For Payments algorithm spot of the account's division. However, if the funding amount is in credit, the system uses the currency conversion algorithm attached to the Currency Conversion For Adjustments algorithm spot of the account's division.</p>	
Default Funding Adjustment Type	<p>Used to indicate the adjustment type using which the A/P adjustment should be created against a credit bill on submitting the funding request.</p> <p>Note:</p> <p>The Search (🔍) icon appears corresponding to the Default Funding Adjustment Type field. On clicking the Search icon, the Adjustment Type Search window appears.</p> <p>In the Default Funding Adjustment Type field, you can only specify an adjustment type where the A/P Request Type Code field is set to REFUND.</p>	Yes
Default Garnishment Adjustment Type	Used to indicate the adjustment type using which the garnishment adjustment should be created when the amount from the credit bill is transferred to the garnishment contract of the account.	Yes

Field Name	Field Description	Mandatory (Yes or No)
	<p>Note:</p> <p>The Search (🔍) icon appears corresponding to the Default Garnishment Adjustment Type field. On clicking the Search icon, the Adjustment Type Search window appears.</p> <p>In the Default Garnishment Adjustment Type field, you can only specify an adjustment type where the A/P Request Type Code field is not set to REFUND.</p>	
Threshold Range Algorithm	<p>Used to attach an algorithm which helps to calculate the threshold range for a bill based on the number of payments made for the bill in the specified period.</p> <p>Note:</p> <p>You must specify an algorithm which is created using the C1-FDRTTR algorithm type in the Threshold Range Algorithm field.</p> <p>The Search (🔍) icon appears corresponding to the Threshold Range Algorithm field. On clicking the Search icon, the Algorithm Search window appears.</p>	No
Defer Processing Count	Used to indicate whether a funding request must be processed in the deferred mode (i.e. in the background) when the number of bills in the funding request exceeds the defer processing count.	No

Field Name	Field Description	Mandatory (Yes or No)
	<p>Note:</p> <p>You cannot specify a negative value in the Defer Processing Count field.</p> <p>Deferred mode means in the background when the Funding Request Periodic Monitor (C1-FNDRQ) batch is invoked. You can configure the Funding Request Periodic Monitor (C1-FNDRQ) batch such that it is executed at regular intervals. For more information about the Funding Request Periodic Monitor (C1-FNDRQ) batch, refer to <i>Oracle Revenue Management and Billing Batch Guide</i>.</p> <p>If the number of bills in a funding request does not exceed the defer processing count, the system will process the funding request in real time (i.e. immediately).</p>	
Approval Required	Used to indicate whether the approval is required before creating payments for debit bills and A/P adjustments for credit bills through the funding request.	No
Approval Profile	<p>Used to indicate the approval profile using which the system should determine the debit or credit hierarchy level from where the approval is required. The system considers the debit or credit hierarchy level where the funding amount of the debit or credit bill falls within the threshold limit.</p> <p>Note: This field appears when the Approval Required option is selected.</p>	<p>Yes (Conditional)</p> <p>Note: This field is required when the Approval Required option is selected.</p>
Submitter To Do Type	<p>Used to indicate that To Do entry of the specified To Do type must be created when the approver rejects the funding request or raises the request for resubmitting the funding request.</p> <p>Note:</p> <p>You must specify the C1-FNDSB To Do type in the Submitter To Do Type field.</p> <p>The Search  icon appears corresponding to the Submitter To Do Type field. On clicking the Search icon, the To Do Type Search window appears.</p> <p>This field appears when the Approval Required option is selected.</p>	<p>Yes (Conditional)</p> <p>Note: This field is required when the Approval Required option is selected.</p>

Field Name	Field Description	Mandatory (Yes or No)
Submitter To Do Role	Used to indicate that the users with the specified To Do role must receive a To Do when the approver rejects the funding request or raises the request for resubmitting the funding request.	Yes (Conditional)
	<p>Note:</p> <p>This field appears when the Approval Required option is selected.</p> <p>The list includes only those To Do roles which are associated to the specified submitter To Do type.</p>	<p>Note: This field is required when the Approval Required option is selected.</p>
Currency Conversion Adjustment Algorithm	Used to indicate the currency conversion algorithm. It is used while determining the approval hierarchy for a funding request when the sum total of the debit and credit amount (i.e. which is in credit) is different from the installation options currency.	Yes (Conditional)
	<p>Note:</p> <p>This field appears when the Approval Required option is selected.</p> <p>The Search  icon appears corresponding to the Currency Conversion Adjustment Algorithm field. On clicking the Search icon, the Algorithm Search window appears.</p>	<p>Note: This field is required when the Currency Conversion Required option is selected in the approval profile.</p>
Currency Conversion Payment Algorithm	Used to indicate the currency conversion algorithm. It is used while determining the approval hierarchy for a funding request when the sum total of the debit and credit amount (i.e. which is in debit) is different from the installation options currency.	Yes (Conditional)
	<p>Note:</p> <p>This field appears when the Approval Required option is selected.</p> <p>The Search  icon appears corresponding to the Currency Conversion Payment Algorithm field. On clicking the Search icon, the Algorithm Search window appears.</p>	<p>Note: This field is required when the Currency Conversion Required option is selected in the approval profile.</p>

6. Enter the required details in the **Main** section.
7. Define characteristics for the funding request type, if required.
8. Click **Save**.

The funding request type is defined.

Related Topics

For more information on...	See...
Funding Request Type screen	Funding Request Type on page 1624
How to define a characteristic for a funding request type	Defining a Characteristic for a Funding Request Type on page 1635

Defining a Characteristic for a Funding Request Type

Prerequisites

To define a characteristic for a funding request type, you should have:

- Characteristic types defined in the application (where the characteristic entity is set to **Funding Request Type**)

Procedure

To define a characteristic for a funding request type:

1. Ensure that the **Characteristics** section is expanded when you are defining, editing, or copying a funding request type.

The **Characteristics** section contains the following fields in a grid:

Field Name	Field Description	Mandatory (Yes or No)
Characteristic Type	Used to indicate the characteristic type.	Yes (Conditional)
	Note: The list includes only those characteristic types where the characteristic entity is set to Funding Request Type .	Note: This field is required when you are defining a characteristic for the funding request type.
Characteristic Value	Used to specify the value for the characteristic type.	Yes (Conditional)
	Note: If you select a predefined characteristic type, the Search (🔍) icon appears corresponding to the Characteristic Value field. On clicking the Search icon, you can search for a predefined characteristic value. On specifying the value for a predefined characteristic type, the description of the characteristic value appears corresponding to the Characteristic Value field.	Note: This field is required when you are defining a characteristic for the funding request type.

2. Enter the required details in the **Characteristics** section.

- If you want to define more than one characteristic for the funding request type, click the **Add (+)** icon and then repeat step 2.

Note: However, if you want to remove a characteristic from the funding request type, click the **Delete (🗑)** icon corresponding to the characteristic.

Related Topics

For more information on...	See...
How to define a funding request type	Defining a Funding Request Type on page 1628
How to edit a funding request type	Editing a Funding Request Type on page 1636
How to copy a funding request type	Copying a Funding Request Type on page 1643

Editing a Funding Request Type

Prerequisites

To edit a funding request type, you should have:

- Funding request business objects defined in the application
- Currencies defined in the application
- Funding adjustment types defined in the application (where the **A/P Request Type Code** field is set to **REFUND**)
- Garnishment adjustment types defined in the application (where the **A/P Request Type Code** field is not set to **REFUND**)
- A threshold range algorithm defined using the **C1-FDRTTR** algorithm type
- Required approval profiles defined in the application
- A To Do role assigned to the **C1-FNDSB** To Do type in the application
- Funding currency characteristic type defined in the application (where the characteristic entity is set to **Account**)
- A currency conversion algorithm defined for payments and adjustments using the **C1_CURALGPY** and **C1_CURALGAD** algorithm type, respectively

Procedure

To edit a funding request type:

- Click the **Admin** link in the **Application** toolbar.
A list appears.
- From the **Admin** menu, select **F** and then click **Funding Request Type**.
A sub-menu appears.
- Click the **Search** option from the **Funding Request Type** sub-menu.
The **Funding Request Type** screen appears.
- In the **Funding Request Type List** zone, click the **Edit (📎)** icon in the **Edit** column corresponding to the funding request type whose details you want to edit.

The **Funding Request Type** screen appears. It contains the following sections:



- Main** - Used to specify basic details about the funding request type.
- Characteristics** - Used to define the characteristics for the funding request type.

The **Main** section contains the following fields:



Field Name	Field Description	Mandatory (Yes or No)
Funding Request Type	Displays the funding request type.	Not applicable
Business Object	Indicates the business object using which you are defining the funding request type.	Not applicable
Description	Used to specify the description for the funding request type.	Yes
Funding Request Business Object	Used to indicate the business object using which you want to create the funding request.	Yes
Detailed Description	Used to specify additional information about the funding request type.	No
Status	Used to indicate the status of the funding request type. The valid values are: <ul style="list-style-type: none"> • Active • Inactive 	Yes
	Note: You cannot change the status of a funding request type to Inactive when the corresponding funding request is in a status other than Processed or Rejected .	
Funding Amount Currency	Used to indicate the currency in which the total debit and credit amount should be calculated in the funding request. The total debit and credit amount appears in the Statistics section of the Funding Request zone.	Yes

Field Name	Field Description	Mandatory (Yes or No)
	<p>Note:</p> <p>The list includes only those currencies which are defined in the system.</p> <p>If the currency specified in this field is different from the bill's currency, the system does currency conversion before calculating the total debit and credit amount in the funding request. The total debit amount is the sum of funding amount of all bills whose funding amount is in debit. However, the total credit amount is the sum of funding amount and garnishment amount of all bills whose funding amount is in credit. While calculating the total debit amount, the system uses the currency conversion algorithm attached to the Currency Conversion For Payments algorithm spot of the account's division. However, while calculating the total credit amount, the system uses the currency conversion algorithm attached to the Currency Conversion For Adjustments algorithm spot of the account's division.</p>	
Account Funding Currency Characteristic Type	Used to indicate the characteristic type. This characteristic should be defined on the account. This characteristic indicates that the funding amount of the account's bills should be converted in the specified currency.	Yes

Field Name	Field Description	Mandatory (Yes or No)
	<p>Note:</p> <p>The Search (🔍) icon appears corresponding to the Account Funding Currency Characteristic Type field. On clicking the Search icon, the Characteristic Type Search window appears.</p> <p>You must specify a characteristic type where the characteristic entity is set to Account.</p> <p>The converted amount appears in the Funding Currency Amount column of the Selected Bills zone in the Funding Request screen.</p> <p>If the funding amount is in debit, the system uses the currency conversion algorithm attached to the Currency Conversion For Payments algorithm spot of the account's division. However, if the funding amount is in credit, the system uses the currency conversion algorithm attached to the Currency Conversion For Adjustments algorithm spot of the account's division.</p>	
Default Funding Adjustment Type	<p>Used to indicate the adjustment type using which the A/P adjustment should be created against a credit bill on submitting the funding request.</p> <p>Note:</p> <p>The Search (🔍) icon appears corresponding to the Default Funding Adjustment Type field. On clicking the Search icon, the Adjustment Type Search window appears.</p> <p>In the Default Funding Adjustment Type field, you can only specify an adjustment type where the A/P Request Type Code field is set to REFUND.</p>	Yes
Default Garnishment Adjustment Type	Used to indicate the adjustment type using which the garnishment adjustment should be created when the amount from the credit bill is transferred to the garnishment contract of the account.	Yes

Field Name	Field Description	Mandatory (Yes or No)
	<p>Note:</p> <p>The Search  icon appears corresponding to the Default Garnishment Adjustment Type field. On clicking the Search icon, the Adjustment Type Search window appears.</p> <p>In the Default Garnishment Adjustment Type field, you can only specify an adjustment type where the A/P Request Type Code field is not set to REFUND.</p>	
Threshold Range Algorithm	<p>Used to attach an algorithm which helps to calculate the threshold range for a bill based on the number of payments made for the bill in the specified period.</p> <p>Note:</p> <p>You must specify an algorithm which is created using the C1-FDRTR algorithm type in the Threshold Range Algorithm field.</p> <p>The Search  icon appears corresponding to the Threshold Range Algorithm field. On clicking the Search icon, the Algorithm Search window appears.</p>	No
Defer Processing Count	Used to indicate whether a funding request must be processed in the deferred mode (i.e. in the background) when the number of bills in the funding request exceeds the defer processing count.	No

Field Name	Field Description	Mandatory (Yes or No)
	<p>Note:</p> <p>You cannot specify a negative value in the Defer Processing Count field.</p> <p>Deferred mode means in the background when the Funding Request Periodic Monitor (C1-FNDRQ) batch is invoked. You can configure the Funding Request Periodic Monitor (C1-FNDRQ) batch such that it is executed at regular intervals. For more information about the Funding Request Periodic Monitor (C1-FNDRQ) batch, refer to <i>Oracle Revenue Management and Billing Batch Guide</i>.</p> <p>If the number of bills in a funding request does not exceed the defer processing count, the system will process the funding request in real time (i.e. immediately).</p>	
Approval Required	Used to indicate whether the approval is required before creating payments for debit bills and A/P adjustments for credit bills through the funding request.	No
Approval Profile	<p>Used to indicate the approval profile using which the system should determine the debit or credit hierarchy level from where the approval is required. The system considers the debit or credit hierarchy level where the funding amount of the debit or credit bill falls within the threshold limit.</p> <p>Note: This field appears when the Approval Required option is selected.</p>	<p>Yes (Conditional)</p> <p>Note: This field is required when the Approval Required option is selected.</p>
Submitter To Do Type	<p>Used to indicate that To Do entry of the specified To Do type must be created when the approver rejects the funding request or raises the request for resubmitting the funding request.</p> <p>Note:</p> <p>You must specify the C1-FNDSB To Do type in the Submitter To Do Type field.</p> <p>The Search  icon appears corresponding to the Submitter To Do Type field. On clicking the Search icon, the To Do Type Search window appears.</p> <p>This field appears when the Approval Required option is selected.</p>	<p>Yes (Conditional)</p> <p>Note: This field is required when the Approval Required option is selected.</p>

Field Name	Field Description	Mandatory (Yes or No)
Submitter To Do Role	Used to indicate that the users with the specified To Do role must receive a To Do when the approver rejects the funding request or raises the request for resubmitting the funding request.	Yes (Conditional)
	<p>Note:</p> <p>This field appears when the Approval Required option is selected.</p> <p>The list includes only those To Do roles which are associated to the specified submitter To Do type.</p>	<p>Note: This field is required when the Approval Required option is selected.</p>
Currency Conversion Adjustment Algorithm	Used to indicate the currency conversion algorithm. It is used while determining the approval hierarchy for a funding request when the sum total of the debit and credit amount (i.e. which is in credit) is different from the installation options currency.	Yes (Conditional)
	<p>Note:</p> <p>This field appears when the Approval Required option is selected.</p> <p>The Search  icon appears corresponding to the Currency Conversion Adjustment Algorithm field. On clicking the Search icon, the Algorithm Search window appears.</p>	<p>Note: This field is required when the Currency Conversion Required option is selected in the approval profile.</p>
Currency Conversion Payment Algorithm	Used to indicate the currency conversion algorithm. It is used while determining the approval hierarchy for a funding request when the sum total of the debit and credit amount (i.e. which is in debit) is different from the installation options currency.	Yes (Conditional)
	<p>Note:</p> <p>This field appears when the Approval Required option is selected.</p> <p>The Search  icon appears corresponding to the Currency Conversion Payment Algorithm field. On clicking the Search icon, the Algorithm Search window appears.</p>	<p>Note: This field is required when the Currency Conversion Required option is selected in the approval profile.</p>

Tip: Alternatively, you can edit the details of a funding request type by clicking the **Edit** button in the **Funding Request Type** zone.

5. Modify the details in the **Main** section, if required.

6. Define, edit, or remove characteristics of the funding request type, if required.
7. Click **Save**.

The changes made to the funding request type are saved.

Related Topics

For more information on...	See...
Funding Request Type screen	Funding Request Type on page 1624
Funding Request Type List zone	Funding Request Type List on page 1624
Funding Request Type zone	Funding Request Type on page 1625
How to define a characteristic for a funding request type	Defining a Characteristic for a Funding Request Type on page 1635

Deleting a Funding Request Type

Procedure

To delete a funding request type:

1. Click the **Admin** link in the **Application** toolbar.
A list appears.
2. From the **Admin** menu, select **F** and then click **Funding Request Type**.
A sub-menu appears.
3. Click the **Search** option from the **Funding Request Type** sub-menu.
The **Funding Request Type** screen appears.
4. In the **Funding Request Type List** zone, click the **Delete** (🗑️) icon in the **Delete** column corresponding to the funding request type that you want to delete.

A message appears confirming whether you want to delete the funding request type.

Note: You can delete a funding request type when you have not created a funding request using the funding request type.

Tip: Alternatively, you can delete a funding request type by clicking the **Delete** button in the **Funding Request Type** zone.

5. Click **OK**.

The funding request type is deleted.

Related Topics

For more information on...	See...
Funding Request Type screen	Funding Request Type on page 1624
Funding Request Type List zone	Funding Request Type List on page 1624
Funding Request Type zone	Funding Request Type on page 1625

Copying a Funding Request Type

Instead of creating a funding request type from scratch, you can create a new funding request type using an existing funding request type. This is possible through copying a funding request type. On copying a funding request type, the details including the characteristics are copied to the new funding request type. You can then edit the details, if required.

Prerequisites

To copy a funding request type, you should have:

- Funding request type (whose copy you want to create) defined in the application
- Funding request business objects defined in the application
- Currencies defined in the application
- Funding adjustment types defined in the application (where the **A/P Request Type Code** field is set to **REFUND**)
- Garnishment adjustment types defined in the application (where the **A/P Request Type Code** field is not set to **REFUND**)
- A threshold range algorithm defined using the **C1-FDRTTR** algorithm type
- Required approval profiles defined in the application
- A To Do role assigned to the **C1-FNDSB** To Do type in the application
- Funding currency characteristic type defined in the application (where the characteristic entity is set to **Account**)
- A currency conversion algorithm defined for payments and adjustments using the **C1_CURALGPY** and **C1_CURALGAD** algorithm type, respectively

Procedure

To copy a funding request type:

1. Click the **Admin** link in the **Application** toolbar.
A list appears.
2. From the **Admin** menu, select **F** and then click **Funding Request Type**.
A sub-menu appears.
3. Click the **Search** option from the **Funding Request Type** sub-menu.
The **Funding Request Type** screen appears.
4. In the **Funding Request Type List** zone, click the **Duplicate**  icon in the **Duplicate** column corresponding to the funding request type whose copy you want to create.

The **Funding Request Type** screen appears. It contains the following sections:

- **Main** - Used to specify basic details about the funding request type.
- **Characteristics** - Used to define the characteristics for the funding request type.

The **Main** section contains the following fields:



Field Name	Field Description	Mandatory (Yes or No)
Funding Request Type	Used to specify the funding request type.	Yes
Business Object	Indicates the business object using which you are defining the funding request type.	Not applicable
Description	Used to specify the description for the funding request type.	Yes

Field Name	Field Description	Mandatory (Yes or No)
Funding Request Business Object	Used to indicate the business object using which you want to create the funding request.	Yes
Detailed Description	Used to specify additional information about the funding request type.	No
Status	<p>Used to indicate the status of the funding request type. The valid values are:</p> <ul style="list-style-type: none"> • Active • Inactive <p>Note: You cannot change the status of a funding request type to Inactive when the corresponding funding request is in a status other than Processed or Rejected.</p>	Yes
Funding Amount Currency	<p>Used to indicate the currency in which the total debit and credit amount should be calculated in the funding request. The total debit and credit amount appears in the Statistics section of the Funding Request zone.</p> <p>Note: The list includes only those currencies which are defined in the system.</p> <p>If the currency specified in this field is different from the bill's currency, the system does currency conversion before calculating the total debit and credit amount in the funding request. The total debit amount is the sum of funding amount of all bills whose funding amount is in debit. However, the total credit amount is the sum of funding amount and garnishment amount of all bills whose funding amount is in credit. While calculating the total debit amount, the system uses the currency conversion algorithm attached to the Currency Conversion For Payments algorithm spot of the account's division. However, while calculating the total credit amount, the system uses the currency conversion algorithm attached to the Currency Conversion For Adjustments algorithm spot of the account's division.</p>	Yes
Account Funding Currency Characteristic Type	Used to indicate the characteristic type. This characteristic should be defined on the account. This characteristic indicates that the funding amount of the account's	Yes

Field Name	Field Description	Mandatory (Yes or No)
	<p>bills should be converted in the specified currency.</p> <p>Note:</p> <p>The Search (🔍) icon appears corresponding to the Account Funding Currency Characteristic Type field. On clicking the Search icon, the Characteristic Type Search window appears.</p> <p>You must specify a characteristic type where the characteristic entity is set to Account.</p> <p>The converted amount appears in the Funding Currency Amount column of the Selected Bills zone in the Funding Request screen.</p> <p>If the funding amount is in debit, the system uses the currency conversion algorithm attached to the Currency Conversion For Payments algorithm spot of the account's division. However, if the funding amount is in credit, the system uses the currency conversion algorithm attached to the Currency Conversion For Adjustments algorithm spot of the account's division.</p>	
Default Funding Adjustment Type	<p>Used to indicate the adjustment type using which the A/P adjustment should be created against a credit bill on submitting the funding request.</p> <p>Note:</p> <p>The Search (🔍) icon appears corresponding to the Default Funding Adjustment Type field. On clicking the Search icon, the Adjustment Type Search window appears.</p> <p>In the Default Funding Adjustment Type field, you can only specify an adjustment type where the A/P Request Type Code field is set to REFUND.</p>	Yes
Default Garnishment Adjustment Type	Used to indicate the adjustment type using which the garnishment adjustment should be created when the amount from the credit bill is transferred to the garnishment contract of the account.	Yes

Field Name	Field Description	Mandatory (Yes or No)
	<p>Note:</p> <p>The Search (🔍) icon appears corresponding to the Default Garnishment Adjustment Type field. On clicking the Search icon, the Adjustment Type Search window appears.</p> <p>In the Default Garnishment Adjustment Type field, you can only specify an adjustment type where the A/P Request Type Code field is not set to REFUND.</p>	
Threshold Range Algorithm	<p>Used to attach an algorithm which helps to calculate the threshold range for a bill based on the number of payments made for the bill in the specified period.</p> <p>Note:</p> <p>You must specify an algorithm which is created using the C1-FDRTTR algorithm type in the Threshold Range Algorithm field.</p> <p>The Search (🔍) icon appears corresponding to the Threshold Range Algorithm field. On clicking the Search icon, the Algorithm Search window appears.</p>	No
Defer Processing Count	Used to indicate whether a funding request must be processed in the deferred mode (i.e. in the background) when the number of bills in the funding request exceeds the defer processing count.	No

Field Name	Field Description	Mandatory (Yes or No)
	<p>Note:</p> <p>You cannot specify a negative value in the Defer Processing Count field.</p> <p>Deferred mode means in the background when the Funding Request Periodic Monitor (C1-FNDRQ) batch is invoked. You can configure the Funding Request Periodic Monitor (C1-FNDRQ) batch such that it is executed at regular intervals. For more information about the Funding Request Periodic Monitor (C1-FNDRQ) batch, refer to <i>Oracle Revenue Management and Billing Batch Guide</i>.</p> <p>If the number of bills in a funding request does not exceed the defer processing count, the system will process the funding request in real time (i.e. immediately).</p>	
Approval Required	Used to indicate whether the approval is required before creating payments for debit bills and A/P adjustments for credit bills through the funding request.	No
Approval Profile	<p>Used to indicate the approval profile using which the system should determine the debit or credit hierarchy level from where the approval is required. The system considers the debit or credit hierarchy level where the funding amount of the debit or credit bill falls within the threshold limit.</p> <p>Note: This field appears when the Approval Required option is selected.</p>	<p>Yes (Conditional)</p> <p>Note: This field is required when the Approval Required option is selected.</p>
Submitter To Do Type	<p>Used to indicate that To Do entry of the specified To Do type must be created when the approver rejects the funding request or raises the request for resubmitting the funding request.</p> <p>Note:</p> <p>You must specify the C1-FNDSB To Do type in the Submitter To Do Type field.</p> <p>The Search  icon appears corresponding to the Submitter To Do Type field. On clicking the Search icon, the To Do Type Search window appears.</p> <p>This field appears when the Approval Required option is selected.</p>	<p>Yes (Conditional)</p> <p>Note: This field is required when the Approval Required option is selected.</p>

Field Name	Field Description	Mandatory (Yes or No)
Submitter To Do Role	Used to indicate that the users with the specified To Do role must receive a To Do when the approver rejects the funding request or raises the request for resubmitting the funding request.	Yes (Conditional)
	<p>Note:</p> <p>This field appears when the Approval Required option is selected.</p> <p>The list includes only those To Do roles which are associated to the specified submitter To Do type.</p>	<p>Note: This field is required when the Approval Required option is selected.</p>
Currency Conversion Adjustment Algorithm	Used to indicate the currency conversion algorithm. It is used while determining the approval hierarchy for a funding request when the sum total of the debit and credit amount (i.e. which is in credit) is different from the installation options currency.	Yes (Conditional)
	<p>Note:</p> <p>This field appears when the Approval Required option is selected.</p> <p>The Search  icon appears corresponding to the Currency Conversion Adjustment Algorithm field. On clicking the Search icon, the Algorithm Search window appears.</p>	<p>Note: This field is required when the Currency Conversion Required option is selected in the approval profile.</p>
Currency Conversion Payment Algorithm	Used to indicate the currency conversion algorithm. It is used while determining the approval hierarchy for a funding request when the sum total of the debit and credit amount (i.e. which is in debit) is different from the installation options currency.	Yes (Conditional)
	<p>Note:</p> <p>This field appears when the Approval Required option is selected.</p> <p>The Search  icon appears corresponding to the Currency Conversion Payment Algorithm field. On clicking the Search icon, the Algorithm Search window appears.</p>	<p>Note: This field is required when the Currency Conversion Required option is selected in the approval profile.</p>

Tip: Alternatively, you can copy a funding request type by clicking the **Duplicate** button in the **Funding Request Type** zone.

5. Enter the required details in the **Main** section.

6. Define, edit, or remove characteristics of the funding request type, if required.
7. Click **Save**.

The new funding request type is defined.

Related Topics

For more information on...	See...
Funding Request Type screen	Funding Request Type on page 1624
Funding Request Type List zone	Funding Request Type List on page 1624
Funding Request Type zone	Funding Request Type on page 1625
How to define a characteristic for a funding request type	Defining a Characteristic for a Funding Request Type on page 1635

Viewing the Funding Request Type Details

Procedure

To view the details of a funding request type:

1. Click the **Admin** link in the **Application** toolbar.
A list appears.
2. From the **Admin** menu, select **F** and then click **Funding Request Type**.
A sub-menu appears.
3. Click the **Search** option from the **Funding Request Type** sub-menu.
The **Funding Request Type** screen appears.
4. In the **Funding Request Type List** zone, click the **Broadcast** () icon corresponding to the funding request type whose details you want to view.
The **Funding Request Type** zone appears.
5. View the details of the funding request type in the **Funding Request Type** zone.

Related Topics

For more information on...	See...
Funding Request Type screen	Funding Request Type on page 1624
Funding Request Type List zone	Funding Request Type List on page 1624
Funding Request Type zone	Funding Request Type on page 1625

Funding Request (Used for Searching)

The **Funding Request** screen allows you to search for a funding request using various search criteria. It also allows you to create a funding request. It contains the following zone:

- [Search Funding Request](#) on page 1651

Through this screen, you can navigate to the following screen:

- [Funding Request \(Used for Viewing\)](#) on page 1655

Search Funding Request

The **Search Funding Request** zone allows you to search for a funding request using various search criteria. It contains the following two sections:

- **Search Criteria** - The **Search Criteria** section contains the following fields:

Field Name	Field Description	Mandatory (Yes or No)
Search By	Used to indicate whether you want to search for a funding request using the funding request or bill details. The valid values are: <ul style="list-style-type: none"> • Request Details • Bill Details 	Yes
	Note: By default, the Request Details option is selected.	
Created From	Used to search funding requests which are created from a particular date onwards.	No
	Note: This field appears when the Request Details option is selected from the Search By list.	
Status	Used to search funding requests with a particular status. The valid values are: <ul style="list-style-type: none"> • Approval In Progress • Deferred Processing • Draft • Processed • Rejected 	No
	Note: This field appears when the Request Details option is selected from the Search By list.	
Created To	Used to search funding requests which are created till a particular date.	No
	Note: This field appears when the Request Details option is selected from the Search By list.	
User ID	Used to search funding requests which are created by a particular user.	No
	Note: This field appears when the Request Details option is selected from the Search By list.	
Funding Request Type	Used to search funding requests which are created using a particular funding request type.	No
	Note: This field appears when the Request Details option is selected from the Search By list.	

Field Name	Field Description	Mandatory (Yes or No)
Person Name	Used to search funding requests which includes bills of a particular person.	No
	Note: This field appears when the Request Details option is selected from the Search By list.	
Funding Request ID	Used to search a particular funding request.	No
	Note: This field appears when the Request Details option is selected from the Search By list.	
Creation Mode	Used to search funding requests which are created in a particular mode. The valid values are: <ul style="list-style-type: none"> • Automatic • Manual 	No
	Note: This field appears when the Request Details option is selected from the Search By list.	
Bill ID	Used to search funding requests which include a particular bill.	No
	Note: This field appears when the Bill Details option is selected from the Search By list. The Search (🔍) icon appears corresponding to the Bill ID field. On clicking the Search icon, the Bill Search window appears.	
Bill Date From	Used to search funding requests which include bills that are created from a particular date onwards.	No
	Note: This field appears when the Bill Details option is selected from the Search By list.	
Alternate Bill ID	Used to search funding requests which include a particular bill.	No
	Note: This field appears when the Bill Details option is selected from the Search By list.	
Bill Date To	Used to search funding requests which include bills that are created till a particular date.	No
	Note: This field appears when the Bill Details option is selected from the Search By list.	
Division	Used to search funding requests which includes bills of accounts which belong to a particular division.	No

Field Name	Field Description	Mandatory (Yes or No)
	<p>Note:</p> <p>This field appears when the Bill Details option is selected from the Search By list.</p> <p>You can only view those divisions to which you have access in the Division list.</p>	

Note: You must specify at least one search criterion while searching for a funding request.

- **Search Results** - On clicking the **Search** button, the search results appear based on the specified search criteria. The **Search Results** section contains the following columns:

Column Name	Column Description
Create Date Time	Displays the date and time when the funding request is created.
Funding Request Information	<p>Displays information about the funding request.</p> <p>Note: It has a link. On clicking the link, the Funding Request screen appears where you can view the details of the respective funding request.</p>
Status	<p>Indicates the status of the funding request. The valid values are:</p> <ul style="list-style-type: none"> • Approval In Progress • Deferred Processing • Draft • Processed • Rejected
Total Debit Amount	Displays the total amount of the debit bills which are added in the funding request.
Total Credit Amount	Displays the total amount of the credit bills which are added in the funding request.
Created By	Indicates the user who has created the funding request.
Creation Mode	<p>Indicates how the funding request is created. The valid values are:</p> <ul style="list-style-type: none"> • Automatic • Manual

Note: Pagination is used to display limited number of records in the **Search Results** section. You can use the navigation links, such as **Previous** and **Next** to navigate between pages.

Related Topics

For more information on...	See...
How to search for a funding request	Searching for a Funding Request on page 1653

Searching for a Funding Request

Prerequisites

To search for a funding request, you should have:

- Funding request types defined in the application

Procedure

To search for a funding request:

1. Click the **Menu** link in the **Application** toolbar.
A list appears.
2. From the **Main** menu, select **Accounting and Receivable** and then click **Funding Request**.
A sub-menu appears.
3. Click the **Search** option from the **Funding Request** sub-menu.
The **Funding Request** screen appears.
4. Enter the search criteria in the **Search Funding Request** zone.

Note: ORMB search engine supports wildcard search, where you can substitute the percentage (%) symbol as a stand in for any word or letter in a search criteria. You can use the ‘%’ wildcard character in all input fields except the date and ID fields. The ‘%’ wildcard character is suffixed automatically at the end of the partial search criteria. Therefore, you may or may not specify the wildcard character at the end of the partial search criteria. However, you have to prefix the wildcard character manually wherever required.

5. Click **Search**.

A list of funding requests that meet the search criteria appears in the **Search Results** section.

Related Topics

For more information on...	See...
Funding Request screen	Funding Request (Used for Searching) on page 1650
Search Funding Request zone	Search Funding Request on page 1651

Creating a Funding Request

Prerequisites

To create a funding request, you should have:

- Funding request types defined in the application

Procedure

To create a funding request:

1. Click the **Menu** link in the **Application** toolbar.
A list appears.
2. From the **Main** menu, select **Accounting and Receivable** and then click **Funding Request**.
A sub-menu appears.
3. Click the **Add** option from the **Funding Request** sub-menu.

The **Add Funding Request** screen appears. It contains the following field:

Field Name	Field Description	Mandatory (Yes or No)
Funding Request Type	Used to indicate the funding request type using which you want to create the funding request.	Yes

Tip: Alternatively, you can access this screen by clicking the **Add** button in the **Page Title** area of the **Funding Request** screen.

4. Select the required funding request type from the respective field.
5. Click **OK**.

The funding request is created in the **Draft** status.

Related Topics

For more information on...	See...
Funding Request screen	Funding Request (Used for Searching) on page 1650
How to add a debit or credit bill to the funding request	Adding a Debit or Credit Bill to a Funding Request on page 1668
How to define a characteristic for a funding request	Defining a Characteristic for a Funding Request on page 1673

Viewing the Funding Request Details

Procedure

To view the details of a funding request:

1. Search for the funding request in the **Funding Request** screen.
2. In the **Search Results** section, click the link in the **Funding Request Information** column corresponding to the funding request whose details you want to view.

The **Funding Request** screen appears.

3. Ensure that the **Main** tab is selected.
4. View the details of the funding request in the **Funding Request** zone.
5. View the credit and/or debit bills added in the funding request in the **Selected Bills** zone.

Related Topics

For more information on...	See...
How to search for a funding request	Searching for a Funding Request on page 1653
Funding Request screen	Funding Request (Used for Viewing) on page 1655
Funding Request zone	Funding Request on page 1656
Selected Bills zone	Selected Bills on page 1664

Funding Request (Used for Viewing)

The **Funding Request** screen allows you to:

- Edit the details of a funding request
- Delete or cancel a funding request
- View the details of a funding request

- Submit a funding request for processing
- Approve or reject a funding request
- Request the submitter to resubmit a funding request for approval
- Withdraw a funding request
- View the log of a funding request
- Add a log entry for a funding request

It consists of the following tabs:

- [Funding Request - Main](#) on page 1656
- [Funding Request - Bills](#) on page 1663
- [Funding Request - Log](#) on page 1667

Funding Request - Main

The **Main** tab displays information about the funding request. It contains the following zones:

- [Funding Request](#) on page 1656
- [Search Bill](#) on page 1659

Funding Request

The **Funding Request** zone displays the details of the funding request. It contains the following sections:

- **Main** - Displays basic information about the funding request. It contains the following fields:

Field Name	Field Description
Funding Request Information	Displays information about the funding request.
Funding Request Type	Indicates the funding request type using which the funding request is created. Note: It has a link. On clicking the link, the Funding Request Type screen appears where you can view the details of the respective funding request type.
Status	Indicates the status of the funding request. The valid values are: <ul style="list-style-type: none"> • Approval In Progress • Deferred Processing • Draft • Processed • Rejected
Status Reason	Indicates the reason why the funding request is rejected. Note: This field appears when the funding request is in the Rejected status. It has a link. On clicking the link, the Status Reason screen appears where you can view the details of the respective status reason.
Funding Adjustment Type	Indicates the adjustment type using which the A/P adjustment is created against a credit bill.

Field Name	Field Description
	Note: It has a link. On clicking the link, the Adjustment Type screen appears where you can view the details of the respective adjustment type.
Garnishment Adjustment Type	Indicates the adjustment type using which the garnishment adjustment is created when the amount from the credit bill is transferred to the garnishment contract of the account. Note: It has a link. On clicking the link, the Adjustment Type screen appears where you can view the details of the respective adjustment type.
Comments	Displays additional information entered while rejecting the funding request. Note: This field appears when the funding request is in the Rejected status.
Creation Mode	Indicates whether the funding request is created automatically or manually. The valid values are: <ul style="list-style-type: none"> • Automatic • Manual

- **Statistics** - Displays analytical information about the funding request. It contains the following fields:

Field Name	Field Description
Total Records	Displays the total number of debit or credit bills which are added in the funding request.
Total Records Processed	Displays the total number of debit or credit bills for which payments or adjustments are successfully created in the system.
Total Records Excluded	Displays the total number of debit or credit bills which are excluded from the automatic funding request.
Total Records In Error	Displays the total number of debit or credit bills for which payments or adjustments was not successfully created in the system.
Total Payment Incoming Events Created	Displays the total number of payment events created against the debit bills in the funding request.
Total Adjustments Created	Displays the total number of adjustments created against the credit bills in the funding request.
Total Credit Funding Amount	Displays the sum of funding amount and garnishment amount of all bills whose funding amount is in credit. The sum total is calculated in the funding amount currency which is specified in the funding request type. Note: If the credit bill's currency is different from the funding amount currency, the system does the currency conversion before calculating the sum total. The system uses the currency conversion algorithm attached to the Currency Conversion For Adjustments algorithm spot of the account's division.
Total Debit Funding Amount	Displays the sum of funding amount of all bills whose funding amount is in debit. The sum total is calculated in the funding amount currency which is specified in the funding request type.

Field Name	Field Description
	<p>Note: If the debit bill's currency is different from the funding amount currency, the system does the currency conversion before calculating the sum total. The system uses the currency conversion algorithm attached to the Currency Conversion For Payments algorithm spot of the account's division.</p>

- **Record Actions** - This section contains the following buttons:

Button Name	Button Description
Edit	Used to edit the details of the funding request.
	Note: The Edit button appears when the funding request is in the Draft status.
Delete	Used to delete the funding request.
	Note: The Delete button appears when the funding request is in the Draft status.
Submit	Used to submit the funding request.
	Note: The Submit button appears when the funding request is in the Draft status.
Cancel	Used to cancel the funding request.
	Note: The Cancel button appears when the funding request is in the Draft status.
Approve	Used to approve the funding request.
	<p>Note: The Approve button appears when:</p> <ul style="list-style-type: none"> • The funding request is in the Approval In Progress status. • A user with the approval To Do role is reviewing the funding request.
Reject	Used to reject the funding request.
	<p>Note: The Reject button appears when:</p> <ul style="list-style-type: none"> • The funding request is in the Approval In Progress status. • A user with the approval To Do role is reviewing the funding request.
Re Submit	Used to request for resubmitting the funding request.
	<p>Note: The Re Submit button appears when:</p> <ul style="list-style-type: none"> • The funding request is in the Approval In Progress status. • A user with the approval To Do role is reviewing the funding request.
Withdraw	Used to withdraw the funding request.

Button Name	Button Description
	<p>Note: The Withdraw button appears when:</p> <ul style="list-style-type: none"> The funding request is in the Approval In Progress status. A user with the submitter To Do role is viewing the funding request.

- **Record Information** - This section contains the following fields:

Field Name	Field Description
Business Object	<p>Indicates the business object using which the funding request is created. In addition, a context menu appears corresponding to this field which helps in navigating to other screens in the application.</p> <p>Note: It has a link. On clicking the link, the Business Object screen appears where you can view the details of the respective business object.</p>
Status Date/Time	Displays the date and time when the funding request status is updated
Create Date/Time	Displays the date and time when the funding request is created.

- **Characteristics** - Lists the characteristics defined for the funding request. It contains the following columns:

Column Name	Column Description
Effective Date	Displays the date from when the characteristic is effective for the funding request.
Characteristic Type	Indicates the characteristic type.
Characteristic Value	Displays the value of the characteristic type.

Related Topics

For more information on...	See...
How to edit a funding request	Editing a Funding Request on page 1671
How to delete a funding request	Deleting a Funding Request on page 1674
How to submit a funding request	Submitting a Funding Request on page 1675
How to cancel a funding request	Cancelling a Funding Request on page 1675
How to approve a funding request	Approving a Funding Request on page 1677
How to reject a funding request	Rejecting a Funding Request on page 1679
How to request for resubmitting a funding request	Requesting to Resubmit a Funding Request on page 1681
How to withdraw a funding request	Withdrawing a Funding Request on page 1682

Search Bill

The **Search Bill** zone allows you to search for a bill using various search criteria. It appears when the funding request is in the **Draft** status and the creation mode is set to **Manual**. It contains the following two sections:

- **Search Criteria** - The **Search Criteria** section contains the following fields:

Field Name	Field Description	Mandatory (Yes or No)
Search By	Used to indicate whether you want to search for a bill using the person, account, or bill details. The valid values are: <ul style="list-style-type: none"> • Bill Details • Account Details • Person Details 	Yes
	Note: By default, the Bill Details option is selected.	
Bill ID	Used to search a particular bill.	No
	Note: This field appears when the Bill Details option is selected from the Search By list. The Search (🔍) icon appears corresponding to the Bill ID field. On clicking the Search icon, the Bill Search window appears.	
Bill Date From	Used to search bills which are created from a particular date onwards.	Yes
	Note: This field appears when the Bill Details option is selected from the Search By list. By default, the current date appears in this field.	
Alternate Bill ID	Used to search a particular bill.	No
	Note: This field appears when the Bill Details option is selected from the Search By list.	
Bill Date To	Used to search bills which are created till a particular date.	Yes
	Note: This field appears when the Bill Details option is selected from the Search By list. By default, the current date appears in this field.	
Bill Balance	Used to indicate whether you want to search bills with debit or credit balance. The valid values are: <ul style="list-style-type: none"> • Credit • Debit 	No
	Note: This field appears when the Bill Details option is selected from the Search By list.	

Field Name	Field Description	Mandatory (Yes or No)
Bill Due Date From	Used to search bills which are due from a particular date onwards.	No
	Note: This field appears when the Bill Details option is selected from the Search By list.	
Division	Used to search bills of accounts which belong to a particular division.	No
	Note: You can only view those divisions to which you have access in the Division list. This field appears when the Bill Details option is selected from the Search By list.	
Bill Due Date To	Used to search bills which are due till a particular date.	No
	Note: This field appears when the Bill Details option is selected from the Search By list.	
Account ID	Used to search bills of a particular account.	Yes (Conditional)
	Note: This field appears when the Account Details option is selected from the Search By list.	
Person ID	Used to search bills which belong to a particular person.	Yes (Conditional)
	Note: This field appears when the Person Details option is selected from the Search By list.	
Person Name	Used to search bills which are created for accounts of a particular person.	Yes (Conditional)
	Note: This field appears when the Person Details option is selected from the Search By list.	
		Note: This field is required when: <ul style="list-style-type: none"> The Person Details option is selected from the Search By list. The person name is not specified in the search criteria.
		Note: This field is required when: <ul style="list-style-type: none"> The Person Details option is selected from the Search By list. The person ID is not specified in the search criteria.

Field Name	Field Description	Mandatory (Yes or No)
Country	Used to search bills of persons who reside in a particular country.	No
	Note: This field appears when the Person Details option is selected from the Search By list.	

Note: You must specify at least one search criterion while searching for a bill.

- **Search Results** - On clicking the **Search** button, the search results appear based on the specified search criteria. The **Search Results** section contains the following columns:

Column Name	Column Description						
Bill Information	Displays additional information about the bill. In addition, this column has a context menu which helps in navigating to other screens in the application.						
	Note: It has a link. On clicking the link, the Bill screen appears where you can view the details of the respective bill.						
Due Date	Displays the date when the bill is due for payment.						
Outstanding Amount	Displays the unpaid amount of the bill.						
Hold Amount	Displays the amount of the bill which is kept on hold through a hold request.						
Funding Amount	Displays the bill amount which can be used for the funding process. It is calculated in the following manner:						
	<table border="1"> <thead> <tr> <th>Bill Type</th> <th>Funding Amount for the Bill</th> </tr> </thead> <tbody> <tr> <td>Debit Bill</td> <td>Outstanding Bill Amount – Hold Amount (set on the bill in a hold request) – Offset Amount (set on the bill in an offset request)</td> </tr> <tr> <td>Credit Bill</td> <td>Outstanding Bill Amount – Hold Amount (set on the bill in a hold request) – Offset Amount (set on the bill in an offset request) – Garnishment Amount (set on the bill in a funding request)</td> </tr> </tbody> </table>	Bill Type	Funding Amount for the Bill	Debit Bill	Outstanding Bill Amount – Hold Amount (set on the bill in a hold request) – Offset Amount (set on the bill in an offset request)	Credit Bill	Outstanding Bill Amount – Hold Amount (set on the bill in a hold request) – Offset Amount (set on the bill in an offset request) – Garnishment Amount (set on the bill in a funding request)
	Bill Type	Funding Amount for the Bill					
	Debit Bill	Outstanding Bill Amount – Hold Amount (set on the bill in a hold request) – Offset Amount (set on the bill in an offset request)					
Credit Bill	Outstanding Bill Amount – Hold Amount (set on the bill in a hold request) – Offset Amount (set on the bill in an offset request) – Garnishment Amount (set on the bill in a funding request)						
Person Name	Indicates the person to whom the bill belongs. In addition, this column has a context menu which helps in navigating to other screens in the application.						
	Note: It has a link. On clicking the link, the Person screen appears where you can view the details of the respective person.						
Bill ID	Displays the bill ID.						
Defer Auto Pay	Indicates whether the Defer Auto Pay option is selected on the customer class of the account for which the bill is created. The valid values are: <ul style="list-style-type: none"> • N • Y 						

Note: Pagination is used to display limited number of records in the **Search Results** section. You can use the navigation links, such as **Previous** and **Next** to navigate between pages.

In addition, this section contains the following button:

Button Name	Button Description
Add	Used to add a bill to the funding request.

A check box appears corresponding to each bill. On selecting the check box, you can add the bill to the funding request. You can also select multiple bills at the same time. In addition, you can select the check box corresponding to the column header. This allows you to add all bills listed in the respective page to the funding request.

Related Topics

For more information on...	See...
How to add a debit or credit bill to a funding request	Adding a Debit or Credit Bill to a Funding Request on page 1668

Funding Request - Bills

The **Bills** tab lists the bills which are added in the funding request. It contains the following zones:

- [Currency Statistics](#) on page 1663
- [Selected Bills](#) on page 1664
- [Funding Payment Details](#) on page 1667

Note: This zone appears when the funding request is in the **Processed** status and the funding amount of the bill is in debit.

- [Funding Adjustments](#) on page 1667

Note: This zone appears when the funding request is in the **Processed** status and the funding amount of the bill is in credit.

Currency Statistics



A funding request might include bills in different currencies. The **Currency Statistics** zone lists the sum total of various amount of bills which are created in the same currency. It contains the following columns:

Column Name	Column Description
Currency Code	Indicates the currency in which the sum total is calculated.
	Note: Here, the system lists those currencies in which the bills added to the funding request are created.
Total Outstanding Amount	Displays the sum of outstanding amount of all bills which are created in the respective currency.
Total Hold Amount	Displays the sum of hold amount of all bills which are created in the respective currency.
Total Garnishment Amount	Displays the sum of garnishment amount of all bills which are created in the respective currency.
Total Debit Funding Amount	Displays the sum of funding amount (which is in debit) of all bills which are created in the respective currency.
Total Credit Funding Amount	Displays the sum of funding amount (which is in credit) of all bills which are created in the respective currency.

Selected Bills

The **Selected Bills** zone lists the debit and credit bills which are added to the funding request. It contains the following columns:

Column Name	Column Description						
Bill Date	Displays the date when the bill is created.						
Person Identifier	Displays the primary identifier of the person for whom the bill is created.						
Person Country	Indicates the country where the person is located.						
Invoice Account Identifier	Displays the primary identifier of the account for which the bill is created.						
Funding Amount	<p>Displays the bill amount which can be used for the funding process. It is calculated in the following manner:</p> <table border="1"> <thead> <tr> <th>Bill Type</th> <th>Funding Amount for the Bill</th> </tr> </thead> <tbody> <tr> <td>Debit Bill</td> <td>Outstanding Bill Amount – Hold Amount (set on the bill in a hold request) – Offset Amount (set on the bill in an offset request)</td> </tr> <tr> <td>Credit Bill</td> <td>Outstanding Bill Amount – Hold Amount (set on the bill in a hold request) – Offset Amount (set on the bill in an offset request) – Garnishment Amount (set on the bill in a funding request)</td> </tr> </tbody> </table> <p>Note: The funding amount is calculated in the bill's currency.</p>	Bill Type	Funding Amount for the Bill	Debit Bill	Outstanding Bill Amount – Hold Amount (set on the bill in a hold request) – Offset Amount (set on the bill in an offset request)	Credit Bill	Outstanding Bill Amount – Hold Amount (set on the bill in a hold request) – Offset Amount (set on the bill in an offset request) – Garnishment Amount (set on the bill in a funding request)
Bill Type	Funding Amount for the Bill						
Debit Bill	Outstanding Bill Amount – Hold Amount (set on the bill in a hold request) – Offset Amount (set on the bill in an offset request)						
Credit Bill	Outstanding Bill Amount – Hold Amount (set on the bill in a hold request) – Offset Amount (set on the bill in an offset request) – Garnishment Amount (set on the bill in a funding request)						
Currency Code	Indicates the currency in which the funding amount is calculated.						
Hold Amount	Displays the amount of the bill which is kept on hold through a hold request.						
Offset Amount	Displays the amount of the bill which is offset against another bill through an offset request.						
Garnishment Amount	Displays the amount of the credit bill which is transferred to the garnishment contracts of the account through the funding request.						
Original Outstanding Amount	Displays the original outstanding amount when the bill was added in the funding request.						
Bill ID	<p>Displays the bill ID.</p> <p>Note: It has a link. On clicking the link, the Bill screen appears where you can view the details of the respective bill.</p>						
Open Bills	<p>Indicates whether there are any unpaid bills of the person. The valid values are:</p> <ul style="list-style-type: none"> • Y • N 						
Garnishment Contract	<p>Indicates whether the garnishment contract exists for the account. The valid values are:</p> <ul style="list-style-type: none"> • Y • N 						

Column Name	Column Description
	<p>Note:</p> <p>This column appears when the funding request is in the Draft status.</p> <p>The data appears in this column when a credit bill is added to the funding request.</p> <p>It has a link. On clicking the link, the Edit Garnishment Details screen appears where you can transfer the funding amount from the credit bill to one or more garnishment contracts of the account.</p>
Garnishment	<p>On clicking the View () icon, the View Garnishment Details screen appears where you can view the funding amount transferred to the different garnishment contracts of the account.</p> <p>Note:</p> <p>This column does not appear when the funding request is in the Draft status.</p> <p>The View () icon appears in this column when the funding request is in the Processed status.</p>
Record Status	<p>Indicates the status of the bill record in the funding request. The valid values are:</p> <ul style="list-style-type: none"> • Excluded • Invalid • Masked • Pending • Processed • Valid • Error
Threshold Range	Indicates the threshold range for a bill which is calculated based on the number of payments made for the bill in the specified period.
Person Name	Indicates the person whose bill is added in the funding request.
Bill Information	Displays the information about the bill.
Split Banking	<p>Indicates whether the split automatic payment feature is used for the account. The valid values are:</p> <ul style="list-style-type: none"> • Y • N
Funding Currency Amount	Displays the funding amount which is converted in the funding currency defined on the account.

Note: Pagination is used to display limited number of records in the **Search Results** section. You can use the navigation links, such as **Previous** and **Next** to navigate between pages.

In addition, this section contains the following button:

Button Name	Button Description
Delete	Used to delete a bill from the funding request.
	Note: The Delete button appears when the funding request is created manually and it is in the Draft status.
Edit	Used to exclude a debit or credit bill from the funding request.
	Note: The Edit button appears when the funding request is created automatically and it is in the Draft status.
Hold	Used to create a hold request for one or more bills. However, you cannot select more than 20 bills. On activating or releasing a hold request, the funding amount is automatically updated in the funding request.
	Note: The Hold button appears only when the funding request is in the Draft status.
Offset	Used to create an offset request for a bill. On processing or unapplying an offset request, the funding amount is automatically updated in the funding request.
	Note: The Offset button appears when the funding request is in the Draft status.

A check box appears corresponding to each bill when the funding request is in the **Draft** status. On selecting the check box, you can delete the bill from the funding request. You can also select multiple bills at the same time. In addition, you can select the check box corresponding to the column header. This allows you to delete all bills listed in the respective page from the funding request.

On clicking the **Broadcast** () icon corresponding to a debit or credit bill, the **Funding Payment Details** or **Funding Adjustments** zone appears, respectively.

Note: The **Broadcast** icon does not appear when the funding request is in the **Draft** status.

You can filter the list using various search criteria (such as, **Bill ID**, **Alternate Bill ID**, **Record Status**, **Bill Balance**, **Funding Amount From**, **Person ID**, **Funding Amount To**, **Currency**, **Funding Amount Threshold Range**, and **Country**) available in the **Filter** area. By default, the **Filter** area is hidden. You can view the **Filter** area by clicking the **Filters** () icon in the upper right corner of this zone.

Related Topics

For more information on...	See...
How to delete a debit or credit bill from a funding request	Deleting a Debit or Credit Bill from a Funding Request on page 1669
Funding Payment Details zone	Funding Payment Details on page 1667
Funding Adjustments zone	Funding Adjustments on page 1667
How to transfer the funding amount of a credit bill to a garnishment contract	Transferring the Funding Amount of a Credit Bill to a Garnishment Contract on page 1683
How to view the garnishment details of a credit bill	Viewing the Garnishment Details of a Credit Bill on page 1684
How to exclude a debit or credit bill from a funding request	Excluding a Bill from a Funding Request on page 1669

Funding Payment Details

The **Funding Payment Details** zone lists the payment events which are created for a debit bill through the funding request. It appears when the funding request is in the **Processed** status. It contains the following columns:

Column Name	Column Description
Payment Event Information	Displays information about the payment event.
	Note: It has a link. On clicking the link, the Payment Event screen appears where you can view the details of the respective payment event.
Payment Amount	Displays the amount for which automatic payment is created.

Note: Pagination is used to display limited number of records in the **Search Results** section. You can use the navigation links, such as **Previous** and **Next** to navigate between pages.

Funding Adjustments

The **Funding Adjustments** zone lists the funding and garnishment adjustments which are created for a credit bill through the funding request. It appears when the funding request is in the **Processed** status. It contains the following columns:

Column Name	Column Description
Adjustment Information	Displays information about the funding or garnishment adjustment.
	Note: It has a link. On clicking the link, the Adjustment screen appears where you can view the details of the respective adjustment.
Adjustment Amount	Displays the adjustment amount.

Note: Pagination is used to display limited number of records in the **Search Results** section. You can use the navigation links, such as **Previous** and **Next** to navigate between pages.

Funding Request - Log

The **Log** tab contains the following zone:

- [Funding Request Log](#) on page 1667

Funding Request Log

The **Funding Request Log** zone lists the complete trail of actions performed on the funding request. It contains the following columns:

Column Name	Column Description
Date/Time	Displays the date and time when the action was performed on the funding request.
Details	Displays the details of the action performed on the funding request.
User	Indicates the user who has performed the action on the funding request.
Log Type	Indicates the type of log.
Related Object	Indicates the object or entity which is created when the action is performed on the funding request.

Column Name	Column Description
	Note: At present, no data appears in this column. The implementation team can build the custom logic to meet the business requirements.
Status Reason	Indicates the reason why the funding request was rejected by the approver. Note: The data appears in this column when the funding request is in the Rejected status.

Note: You can manually add a log entry for the funding request by clicking the **Add Log Entry** link in the upper right corner of the **Funding Request Log** zone.

Related Topics

For more information on...	See...
How to view the log of a funding request	Viewing the Log of a Funding Request on page 1686
How to add a log entry for a funding request	Adding a Log Entry for a Funding Request on page 1687

Adding a Debit or Credit Bill to a Funding Request

In a funding request, you can only add the debit or credit bills of the accounts for which the **Defer Auto Pay** option is selected on the respective customer class.

Procedure

To add a debit or credit bill to a funding request:

1. Search for the funding request in the **Funding Request** screen.
2. In the **Search Results** section, click the link in the **Funding Request Information** column corresponding to the funding request whose details you want to edit.
The **Funding Request** screen appears.
3. Ensure that the **Main** tab is selected.
4. Enter the search criteria in the **Search Bill** zone.

Note:

The **Search Bill** zone appears when the funding request is in the **Draft** status.

ORMB search engine supports wildcard search, where you can substitute the percentage (%) symbol as a stand in for any word or letter in a search criteria. You can use the ‘%’ wildcard character in all input fields except the date and ID fields. The ‘%’ wildcard character is suffixed automatically at the end of the partial search criteria. Therefore, you may or may not specify the wildcard character at the end of the partial search criteria. However, you have to prefix the wildcard character manually wherever required.

5. Click **Search**.
A list of bills that meet the search criteria appears in the **Search Results** section.
6. Select the check box corresponding to a bill that you want to add to the funding request.
7. Click the **Add** button in the **Search Bill** zone.
A message appears indicating that the bill is added to the funding request.

Note: You can only add a debit or credit bill of an account for which the **Defer Auto Pay** option is selected on the respective customer class.

8. Click **OK**.

The bill is added to the funding request. The status of the bill record in the funding request is set to **Pending**.

Related Topics

For more information on...	See...
How to search for a funding request	Searching for a Funding Request on page 1653
Funding Request screen	Funding Request (Used for Viewing) on page 1655
Search Bill zone	Search Bill on page 1659
How to create a funding request	Creating a Funding Request on page 1654

Deleting a Debit or Credit Bill from a Funding Request

Procedure

To delete a debit or credit bill from a funding request:

1. Search for the funding request in the **Funding Request** screen.
2. In the **Search Results** section, click the link in the **Funding Request Information** column corresponding to the funding request whose details you want to edit.

The **Funding Request** screen appears.

3. Click the **Bills** tab.

The **Bills** tab appears.

4. In the **Selected Bills** zone, select the check box corresponding to a bill that you want to delete from the funding request.
5. Click the **Delete** button in the **Selected Bills** zone.

A message appears confirming whether you want to delete the bill from the funding request.

Note: The **Delete** button appears when the funding request is in the **Draft** status.

6. Click **OK**.

The debit or credit bill is deleted from the funding request.

Related Topics

For more information on...	See...
How to search for a funding request	Searching for a Funding Request on page 1653
Funding Request screen	Funding Request (Used for Viewing) on page 1655
Selected Bills zone	Selected Bills on page 1664

Excluding a Bill from a Funding Request

If the funding request is manually created through the user interface, you add or delete bills from the funding request when it is in the **Draft** status. However, if the funding request is automatically created through a custom logic, the system allows you to exclude the required bills from the funding request when it is in the **Draft** status. In such case, the status of the record in the funding request is changed to **Excluded**. The excluded bills can then be included in some other funding request.

Prerequisites

To exclude a bill from a funding request, you should have:

- Values defined for the **CAN_RSN_CD_FLG** lookup field

Procedure

To exclude a bill from a funding request:

1. Search for the funding request in the **Funding Request** screen.
2. In the **Search Results** section, click the link in the **Funding Request Information** column corresponding to the funding request whose details you want to edit.

The **Funding Request** screen appears.

3. Click the **Bills** tab.

The **Bills** tab appears.

4. In the **Selected Bills** zone, select the check box corresponding to a bill that you want to exclude from the funding request.

5. Click the **Edit** button in the **Selected Bills** zone.

The **Edit Funding Request Details** screen appears. It contains the following field:

Field Name	Field Description
Funding Request Information	Displays the information about the funding request.

In addition, this screen contains the following fields in a grid:

Field Name	Field Description	Mandatory (Yes or No)						
Bill Information	Displays the information about the bill.	Not applicable						
Garnishment Amount	Displays the funding amount which is transferred to the garnishment contracts of the account.	Not applicable						
Funding Amount	Displays the bill amount which can be used for the funding process. It is calculated in the following manner: <table border="1" data-bbox="560 1543 1063 1904"> <thead> <tr> <th>Bill Type</th> <th>Funding Amount for the Bill</th> </tr> </thead> <tbody> <tr> <td>Debit Bill</td> <td>Outstanding Bill Amount – Hold Amount (set on the bill in a hold request) – Offset Amount (set on the bill in an offset request)</td> </tr> <tr> <td>Credit Bill</td> <td>Outstanding Bill Amount – Hold Amount (set on the bill in a hold request) – Offset Amount (set on the bill in an offset request) –</td> </tr> </tbody> </table>	Bill Type	Funding Amount for the Bill	Debit Bill	Outstanding Bill Amount – Hold Amount (set on the bill in a hold request) – Offset Amount (set on the bill in an offset request)	Credit Bill	Outstanding Bill Amount – Hold Amount (set on the bill in a hold request) – Offset Amount (set on the bill in an offset request) –	Not applicable
Bill Type	Funding Amount for the Bill							
Debit Bill	Outstanding Bill Amount – Hold Amount (set on the bill in a hold request) – Offset Amount (set on the bill in an offset request)							
Credit Bill	Outstanding Bill Amount – Hold Amount (set on the bill in a hold request) – Offset Amount (set on the bill in an offset request) –							

Field Name	Field Description	Mandatory (Yes or No)				
	<table border="1"> <tr> <td>Bill Type</td> <td>Funding Amount for the Bill</td> </tr> <tr> <td></td> <td>Garnishment Amount (set on the bill in a funding request)</td> </tr> </table>	Bill Type	Funding Amount for the Bill		Garnishment Amount (set on the bill in a funding request)	
Bill Type	Funding Amount for the Bill					
	Garnishment Amount (set on the bill in a funding request)					
Status	<p>Used to indicate the status of the record in the funding request. The valid values are:</p> <ul style="list-style-type: none"> Excluded Invalid Masked Pending Processed Valid 	Yes				
Cancel Reason	<p>Used to indicate the reason why you want to exclude the bill from the funding request.</p> <p>Note: The list includes only those values which are defined in the CAN_RSN_CD_FLG lookup field.</p>	<p>Yes (Conditional)</p> <p>Note: This field is required when you want to exclude the bill from the funding request.</p>				

Note: The **Edit** button appears when the creation mode of the funding request is set to **Automatic** and the funding request is in the **Draft** status.

- Select the **Excluded** option from the **Status** field.
- Select the required cancel reason from the respective field.
- Click **Save**.

The bill is excluded from the funding request. The status of the bill record in the funding request is set to **Excluded**.

Related Topics

For more information on...	See...
How to search for a funding request	Searching for a Funding Request on page 1653
Funding Request screen	Funding Request (Used for Viewing) on page 1655
Selected Bills zone	Selected Bills on page 1664

Editing a Funding Request

Prerequisites

To edit a funding request, you should have:

- Funding adjustment types defined in the application (where the **A/P Request Type Code** field is set to **REFUND**)
- Garnishment adjustment types defined in the application (where the **A/P Request Type Code** field is not set to **REFUND**)

Procedure

To edit a funding request:

1. Search for the funding request in the **Funding Request** screen.
2. In the **Search Results** section, click the link in the **Funding Request Information** column corresponding to the funding request whose details you want to edit.

The **Funding Request** screen appears.

3. Click the **Edit** button in the **Funding Request** zone.

The **Edit Funding Request** screen appears. It contains the following sections:

- **Main** - Used to specify basic details about the funding request.
- **Characteristics** - Used to define the characteristics for the funding request.

The **Main** section contains the following fields:

Field Name	Field Description	Mandatory (Yes or No)
Funding Request Information	Displays information about the funding request.	Not applicable
Funding Adjustment Type	Used to indicate the adjustment type using which the A/P adjustment should be created against a credit bill. Note: The Search (🔍) icon appears corresponding to the Funding Adjustment Type field. On clicking the Search icon, the Adjustment Type Search window appears. In the Funding Adjustment Type field, you can only specify an adjustment type where the A/P Request Type Code field is set to REFUND .	Yes (Conditional) Note: This field is required while creating an A/P adjustment against a credit bill.
Garnishment Adjustment Type	Used to indicate the adjustment type using which the garnishment adjustment should be created when the amount from the credit bill is transferred to the garnishment contract of the account. Note: The Search (🔍) icon appears corresponding to the Garnishment Adjustment Type field. On clicking the Search icon, the Adjustment Type Search window appears. In the Garnishment Adjustment Type field, you can only specify an adjustment type where the A/P Request Type Code field is not set to REFUND .	Yes (Conditional) Note: This field is required while creating garnishment adjustments for a credit bill.
Comments	Used to specify additional information about the funding request.	No

Note: The **Edit** button appears when the funding request is in the **Draft** status.

4. Modify the details of the funding request, if required.
5. Define, edit, or remove characteristics of the funding request, if required.
6. Click **Save**.

The changes made to the funding request are saved.

Related Topics

For more information on...	See...
How to search for a funding request	Searching for a Funding Request on page 1653
Funding Request screen	Funding Request (Used for Viewing) on page 1655
Funding Request zone	Funding Request on page 1656
How to define a characteristic for a funding request	Defining a Characteristic for a Funding Request on page 1673

Defining a Characteristic for a Funding Request

Prerequisites

To define a characteristic for a funding request, you should have:

- Characteristic types defined in the application (where the characteristic entity is set to **Funding Request**)

Procedure

To define a characteristic for a funding request:

1. Ensure that the **Characteristics** section is expanded when you are editing a funding request.

The **Characteristics** section contains the following fields in a grid:

Field Name	Field Description	Mandatory (Yes or No)
Effective Date	Used to specify the date from when the characteristic is effective for the funding request.	Yes (Conditional)
		Note: This field is required when you are defining a characteristic for the funding request.
Characteristic Type	Used to indicate the characteristic type. Note: The list includes only those characteristic types where the characteristic entity is set to Funding Request .	Yes (Conditional)
		Note: This field is required when you are defining a characteristic for the funding request.
Characteristic Value	Used to specify the value for the characteristic type.	Yes (Conditional)
		Note: This field is required when you are defining a characteristic for the funding request.

Field Name	Field Description	Mandatory (Yes or No)
	<p>Note:</p> <p>If you select a predefined characteristic type, the Search (🔍) icon appears corresponding to the Characteristic Value field. On clicking the Search icon, you can search for a predefined characteristic value.</p> <p>On specifying the value for a predefined characteristic type, the description of the characteristic value appears corresponding to the Characteristic Value field.</p>	

2. Enter the required details in the **Characteristics** section.
3. If you want to define more than one characteristic for the funding request, click the **Add** (+) icon and then repeat step 2.

Note: However, if you want to remove a characteristic from the funding request, click the **Delete** (🗑️) icon corresponding to the characteristic.

Related Topics

For more information on...	See...
How to edit a funding request	Editing a Funding Request on page 1671

Deleting a Funding Request

Procedure

To delete a funding request:

1. Search for the funding request in the **Funding Request** screen.
2. In the **Search Results** section, click the link in the **Funding Request Information** column corresponding to the funding request that you want to delete.

The **Funding Request** screen appears.

3. Click the **Delete** button in the **Funding Request** zone.

A message appears confirming whether you want to delete the funding request.

Note: The **Delete** button appears when the funding request is in the **Draft** status.

4. Click **OK**.

The funding request is deleted.

Related Topics

For more information on...	See...
How to search for a funding request	Searching for a Funding Request on page 1653
Funding Request screen	Funding Request (Used for Viewing) on page 1655

For more information on...	See...
Funding Request zone	Funding Request on page 1656

Canceling a Funding Request

Prerequisites

To cancel a funding request, you should have:

- Reasons defined for the **Canceled** status of the **C1-FundingRequest** business object in the **Status Reason** screen

Procedure

To cancel a funding request:

- Search for the funding request in the **Funding Request** screen.
- In the **Search Results** section, click the link in the **Funding Request Information** column corresponding to the funding request that you want to cancel.

The **Funding Request** screen appears.

- Click the **Cancel** button in the **Funding Request** zone.

The **Funding Request** window appears. It contains the following field:

Field Name	Field Description	Mandatory (Yes or No)
Status Reason	Used to indicate the reason why you want to cancel the funding request.	Yes
	Note: The list includes only those reasons which are defined for the Canceled status of the C1-FundingRequest business object in the Status Reason screen.	

Note: The **Cancel** button appears when the funding request is in the **Draft** status.

- Select the cancellation reason from the **Status Reason** list.
- Click **Save**.

The status of all records in the funding request is changed to **Excluded** and the status of the funding request is changed to **Canceled**. The excluded bills can then be included in some other funding request.

Related Topics

For more information on...	See...
How to search for a funding request	Searching for a Funding Request on page 1653
Funding Request screen	Funding Request (Used for Viewing) on page 1655
Funding Request zone	Funding Request on page 1656

Submitting a Funding Request

Prerequisites

To submit a funding request, you should have:

- At least one debit or credit bill in the funding request
- Funding and garnishment adjustment types defined in the funding request
- Funding adjustment type defined in the application (where the **A/P Request Type Code** field is set to **REFUND**)
- Garnishment adjustment type defined in the application (where the **A/P Request Type Code** field is not set to **REFUND**)

Procedure

To submit a funding request:

1. Search for the funding request in the **Funding Request** screen.
2. In the **Search Results** section, click the link in the **Funding Request Information** column corresponding to the funding request that you want to submit.

The **Funding Request** screen appears.

3. Click the **Submit** button in the **Funding Request** zone.

The system behaves in the following manner:

If...	Then...				
The Approval Required option is selected in the funding request type using which the funding request is created	It calculates the sum of total debit and credit amount in the funding request. Depending on whether the sum total is debit or credit, it uses the debit or credit hierarchy in the approval profile (which is specified in the funding request type), respectively. Depending on the sum total amount, the system behaves in the following manner:				
	<table border="1"> <thead> <tr> <th data-bbox="889 1045 1177 1098">If...</th> <th data-bbox="1182 1045 1466 1098">Then...</th> </tr> </thead> <tbody> <tr> <td data-bbox="889 1098 1177 1499"> The sum total is less than the minimum threshold amount in the approval hierarchy </td> <td data-bbox="1182 1098 1466 1499"> The system automatically approves the funding request and changes the status of the funding request to either Deferred Processing or Create Funding depending on whether the number of bills in the funding request exceeds the defer processing count. </td> </tr> </tbody> </table>	If...	Then...	The sum total is less than the minimum threshold amount in the approval hierarchy	The system automatically approves the funding request and changes the status of the funding request to either Deferred Processing or Create Funding depending on whether the number of bills in the funding request exceeds the defer processing count.
	If...	Then...			
The sum total is less than the minimum threshold amount in the approval hierarchy	The system automatically approves the funding request and changes the status of the funding request to either Deferred Processing or Create Funding depending on whether the number of bills in the funding request exceeds the defer processing count.				
The sum total is equal to or greater than the threshold amount specified at the first level in the approval hierarchy	The system changes the status of the funding request to Approval In Progress . It creates a To Do using the To Do type specified in the approval profile and assigns it to the users with the To Do role defined at the first level in the approval hierarchy. In addition, it creates a log entry				

If...	Then...	
	If...	Then...
		for the funding request when the To Do is created.
<p>The Approval Required option is not selected in the funding request type using which the funding request is created</p>	<p>The system changes the status of the funding request to either Deferred Processing or Create Funding depending on whether the number of bills in the funding request exceeds the defer processing count.</p> <p>Once the Funding Request Periodic Monitor (C1-FNDRQ) batch is executed, it checks whether there are any funding requests in the Deferred Processing status. If so, it changes the status of the funding request to Create Funding.</p> <p>Once the status of a funding request is changed to Create Funding, the system creates the A/P adjustment against a bill when the funding amount of the bill is in credit. It also creates non A/P adjustments using the garnishment adjustment type when the funding amount of a credit bill is transferred to the garnishment contracts of the account. However, if the funding amount of a bill is in debit, the funding amount is stamped as the automatic payment amount against the bill in the CI_BILL_ACH table. Then, on executing the Create Automatic Payments and Refunds (APAYCRET) batch, the system creates automatic payment and payment event for such bill.</p> <p>Note: The funding and garnishment adjustments are created in the Frozen status.</p>	

Note: The **Submit** button appears when the funding request is in the **Draft** status.

Related Topics

For more information on...	See...
How to search for a funding request	Searching for a Funding Request on page 1653
Funding Request screen	Funding Request (Used for Viewing) on page 1655
Funding Request zone	Funding Request on page 1656

Approving a Funding Request

You can view the number of funding requests which are pending for approval in the **Funding Request** screen. The approver can review, and accordingly approve, reject, or ask the submitter to resubmit the funding request based on the observations.

Note: The system will not allow you to approve, reject or resubmit a funding request submitted by you.

Procedure

To approve a funding request:

1. Do either of the following:

If you want to...	Then...
Approve a funding request through the Funding Request screen	<ol style="list-style-type: none"> 1. Search for the funding request in the Funding Request screen. 2. In the Search Results section, click the link in the Funding Request Information column corresponding to the funding request which you want to review.
Approve a funding request from the To Do List screen	<ol style="list-style-type: none"> 1. Click the Menu link in the Application toolbar. A list appears. 2. From the Main menu, select To Do and then click To Do List. The To Do Type for User Search window appears. 3. Enter C1-FNDAP in the To Do Type field. 4. Click the Search button corresponding to the To Do Type field. The To Do List screen appears. 5. Select the Open option from the Filter by list to view all unassigned To Dos. 6. Click the link in the Message column corresponding to the To Do of the funding request that you want to review.

The **Funding Request** screen appears.

2. Review the details in the **Funding Request** screen.
3. If the information in the funding request is accurate, then click the **Approve** button in the **Funding Request** zone.

The system behaves in the following manner:

If...	Then...
The sum total of the debit and credit amount is equal to or greater than the threshold amount specified at the next level in the approval hierarchy	The system changes the status of the funding request to Approval In Progress . It creates a To Do using the To Do type specified in the approval profile and assigns it to the users with the To Do role defined at the next level in the approval hierarchy. In addition, it creates a log entry for the funding request when the To Do is created.

If...	Then...
<p>The sum total of the debit and credit amount is less than the threshold amount specified at the next level in the approval hierarchy</p>	<p>The system changes the status of the funding request to either Deferred Processing or Create Funding depending on whether the number of bills in the funding request exceeds the defer processing count.</p> <p>Once the Funding Request Periodic Monitor (C1-FNDRQ) batch is executed, it checks whether there are any funding requests in the Deferred Processing status. If so, it changes the status of the funding request to Create Funding.</p> <p>Once the status of a funding request is changed to Create Funding, the system creates the A/P adjustment against a bill when the funding amount of the bill is in credit. It also creates non A/P adjustments using the garnishment adjustment type when the funding amount of a credit bill is transferred to the garnishment contracts of the account. However, if the funding amount of a bill is in debit, the funding amount is stamped as the automatic payment amount against the bill in the CI_BILL_ACH table. Then, on executing the Create Automatic Payments and Refunds (APAYCRET) batch, the system creates automatic payment and payment event for such bill.</p> <p>Note: The funding and garnishment adjustments are created in the Frozen status.</p>

Note: The **Approve** button appears when:

- The funding request is in the **Approval In Progress** status.
- A user with the approval To Do role is reviewing the funding request.

Related Topics

For more information on...	See...
How to search for a funding request	Searching for a Funding Request on page 1653
Funding Request screen	Funding Request (Used for Viewing) on page 1655
Funding Request zone	Funding Request on page 1656

Rejecting a Funding Request

Prerequisites

To reject a funding request, you should have:

- Reasons defined for the **Rejected** status of the **C1-FundingRequest** business object in the **Status Reason** screen

Note: The system will not allow you to approve, reject or resubmit a funding request submitted by you.

Procedure

To reject a funding request:

1. Do either of the following:

If you want to...	Then...
Reject a funding request through the Funding Request screen	<ol style="list-style-type: none"> 1. Search for the funding request in the Funding Request screen. 2. In the Search Results section, click the link in the Funding Request Information column corresponding to the funding request which you want to review.
Reject a funding request from the To Do List screen	<ol style="list-style-type: none"> 1. Click the Menu link in the Application toolbar. A list appears. 2. From the Main menu, select To Do and then click To Do List. The To Do Type for User Search window appears. 3. Enter C1-FNDAP in the To Do Type field. 4. Click the Search button corresponding to the To Do Type field. The To Do List screen appears. 5. Select the Open option from the Filter by list to view all unassigned To Dos. 6. Click the link in the Message column corresponding to the To Do of the funding request that you want to review.

The **Funding Request** screen appears.

2. Review the details in the **Funding Request** screen.
3. If the information in the funding request is incorrect, then click the **Reject** button in the **Funding Request** zone.

The **Reject Funding Request** window appears. It contains following fields:

Field Name	Field Description	Mandatory (Yes or No)
Status Reason	<p>Used to indicate the reason why you want to reject the funding request.</p> <p>Note: The list includes only those reasons which are defined for the Rejected status of the C1-FundingRequest business object in the Status Reason screen.</p>	Yes
Comments	Used to specify additional information while rejecting the funding request.	No

Note: The **Reject** button appears when:

- The funding request is in the **Approval In Progress** status.
- A user with the approval To Do role is reviewing the funding request.

4. Select the rejection reason from the **Status Reason** list.
5. Click **Save**.

The status of the funding request is changed to **Rejected**.

Related Topics

For more information on...	See...
How to search for a funding request	Searching for a Funding Request on page 1653
Funding Request screen	Funding Request (Used for Viewing) on page 1655
Funding Request zone	Funding Request on page 1656

Requesting to Resubmit a Funding Request

Procedure

To request for resubmitting a funding request:

1. Do either of the following:

If you want to...	Then...
Request for resubmitting a funding request through the Funding Request screen	<ol style="list-style-type: none"> 1. Search for the funding request in the Funding Request screen. 2. In the Search Results section, click the link in the Funding Request Information column corresponding to the funding request which you want to review.
Request for resubmitting a funding request from the To Do List screen	<ol style="list-style-type: none"> 1. Click the Menu link in the Application toolbar. A list appears. 2. From the Main menu, select To Do and then click To Do List. The To Do Type for User Search window appears. 3. Enter C1-FNDAP in the To Do Type field. 4. Click the Search button corresponding to the To Do Type field. The To Do List screen appears.

If you want to...	Then...
	<ol style="list-style-type: none"> 5. Select the Open option from the Filter by list to view all unassigned To Dos. 6. Click the link in the Message column corresponding to the To Do of the funding request that you want to review.

The **Funding Request** screen appears.

2. Review the details in the **Funding Request** screen.
3. If the information in the funding request is incomplete and you want the submitter to make the required changes and resubmit, click the **Re Submit** button in the **Funding Request** zone.

The **Resubmit Funding Request** window appears. It contains the following field:

Field Name	Field Description	Mandatory (Yes or No)
Comments	Used to specify the changes which the submitter should make in the funding request before resubmitting it for approval.	Yes

Note: The **Re Submit** button appears when:

- The funding request is in the **Approval In Progress** status.
- A user with the approval To Do role is reviewing the funding request.

4. Enter the comments in the respective field and then click **Save**.

A To Do is created using the submitter To Do type and assigned to all users with a submitter To Do role specified in the funding request type. In addition, the status of the funding request is changed to **Draft**.

Related Topics

For more information on...	See...
How to search for a funding request	Searching for a Funding Request on page 1653
Funding Request screen	Funding Request (Used for Viewing) on page 1655
Funding Request zone	Funding Request on page 1656

Withdrawing a Funding Request

Prerequisites

To withdraw a funding request, you should have:

- Submitter To Do role (which is specified in the funding request type) associated with the **C1-FNDAP** To Do type

Procedure

To withdraw a funding request:

1. Search for the funding request in the **Funding Request** screen.

2. In the **Search Results** section, click the link in the **Funding Request Information** column corresponding to the funding request that you want to withdraw.

The **Funding Request** screen appears.

3. If you want to make some changes in the funding request which is already sent for approval, click the **Withdraw** button in the **Funding Request** zone.

The status of the funding request is changed to **Draft**. The submitter can then make the required changes and resubmit the funding request for approval. The To Do for approver is automatically closed when the submitter withdraws the funding request. Note that the To Do for approver is automatically closed when the submitter To Do role is associated with the To Do type specified in the approval profile.

Note: The **Withdraw** button appears when:

- The funding request is in the **Approval In Progress** status.
- A user with the submitter To Do role is viewing the funding request.

Related Topics

For more information on...	See...
How to search for a funding request	Searching for a Funding Request on page 1653
Funding Request screen	Funding Request (Used for Viewing) on page 1655
Funding Request zone	Funding Request on page 1656

Transferring the Funding Amount of a Credit Bill to a Garnishment Contract

Prerequisites

To transfer the funding amount of a credit bill to a garnishment contract, you should have:

- At least one garnishment contract on the account

Note: The garnishment contract is a contract which is created using a contract type where the **Special Role Flag** field is set to **Garnishment**.

Procedure

To transfer the funding amount of a credit bill to a garnishment contract:

1. Search for the funding request in the **Funding Request** screen.
2. In the **Search Results** section, click the link in the **Funding Request Information** column corresponding to the funding request whose details you want to edit.

The **Funding Request** screen appears.

3. Click the **Bills** tab.

The **Bills** tab appears.

4. In the **Selected Bills** zone, click the link on the value **Y** in the **Garnishment Contract** column corresponding to a credit bill whose funding amount you want to transfer to a garnishment contract of the account.

The **Edit Garnishment Details** screen appears. It contains the following field:

Field Name	Field Description
Bill Information	Indicates the credit bill whose funding amount you want to transfer to a garnishment contract of the account.

In addition, this screen contains the following fields in a grid:

Field Name	Field Description	Mandatory (Yes or No)
Garnishment Contract	Used to indicate the garnishment contract of the account.	Yes
Garnishment Amount	Used to specify the amount that you want to transfer to the garnishment contract.	Yes

- Enter the required details in the **Edit Garnishment Details** screen.
- If you want to transfer the funding amount of the credit bill to more than one garnishment contract of the account, click the **Add (+)** icon and then repeat step 5.

Note: However, if you want to remove a garnishment record from the funding request, click the **Delete** (🗑️) icon corresponding to the garnishment record.

- Click **Save**.

The changes made to the funding request are saved.

Related Topics

For more information on...	See...
How to search for a funding request	Searching for a Funding Request on page 1653
Funding Request screen	Funding Request (Used for Viewing) on page 1655
Selected Bills zone	Selected Bills on page 1664

Viewing the Garnishment Details of a Credit Bill

Procedure

To view the garnishment details of a credit bill:

- Search for the funding request in the **Funding Request** screen.
- In the **Search Results** section, click the link in the **Funding Request Information** column corresponding to the funding request whose details you want to view.

The **Funding Request** screen appears.

- Click the **Bills** tab.

The **Bills** tab appears.

- In the **Selected Bills** zone, click the **Broadcast** (📡) icon in the **Garnishment** column corresponding to the credit bill whose garnishment details you want to view.

The **View Garnishment Details** screen appears. It contains the following field:

Field Name	Field Description
Bill Info	Indicates the credit bill whose garnishment details you are viewing.

In addition, this screen contains the following columns:

Column Name	Column Description
Garnishment Contract	Indicates the garnishment contract of the account against which amount from the credit bill is transferred.
Garnishment Amount	Displays the amount which is transferred to the garnishment contract.

Note:

The **Garnishment** column does not appear when the funding request is in the **Draft** status.

The **View** () icon appears in the **Garnishment** column only when the funding request is in the **Processed** status.

Related Topics

For more information on...	See...
How to search for a funding request	Searching for a Funding Request on page 1653
Funding Request screen	Funding Request (Used for Viewing) on page 1655
Selected Bills zone	Selected Bills on page 1664

Viewing the Payments Created Through a Funding Request**Procedure**

To view the payments created through a funding request:

1. Search for the funding request in the **Funding Request** screen.
2. In the **Search Results** section, click the link in the **Funding Request Information** column corresponding to the funding request whose details you want to view.

The **Funding Request** screen appears.

3. Click the **Bills** tab.

The **Bills** tab appears.

4. In the **Selected Bills** zone, click the **Broadcast** () icon corresponding to a debit bill whose payment details you want to view.

The **Funding Payments Details** zone appears.

Note: The **Broadcast** () icon appears when the funding request is in the **Processed** status.

5. View the payments created for the debit bill through the funding request in the **Funding Payments Details** zone.

Note: The data appears in the **Funding Payments Details** zone when the **Create Automatic Payments and Refunds (APAYCRET)** batch is executed to create the automatic payment and payment event for the debit bill. For more information about the batch, refer to *Oracle Revenue Management and Billing Batch Guide*.

Related Topics

For more information on...	See...
How to search for a funding request	Searching for a Funding Request on page 1653
Funding Request screen	Funding Request (Used for Viewing) on page 1655

For more information on...	See...
Selected Bills zone	Selected Bills on page 1664
Funding Payments Details zone	Funding Payment Details on page 1667

Viewing the Adjustments Created Through a Funding Request

Procedure

To view the adjustments created through a funding request:

1. Search for the funding request in the **Funding Request** screen.
2. In the **Search Results** section, click the link in the **Funding Request Information** column corresponding to the funding request whose details you want to view.

The **Funding Request** screen appears.

3. Click the **Bills** tab.

The **Bills** tab appears.

4. In the **Selected Bills** zone, click the **Broadcast** () icon corresponding to a credit bill whose adjustment details you want to view.

The **Funding Adjustments** zone appears.

Note: The **Broadcast** () icon appears when the funding request is in the **Processed** status.

5. View the A/P adjustments and garnishment adjustments (if any) created for the credit bill through the funding request in the **Funding Adjustments** zone.

Related Topics

For more information on...	See...
How to search for a funding request	Searching for a Funding Request on page 1653
Funding Request screen	Funding Request (Used for Viewing) on page 1655
Selected Bills zone	Selected Bills on page 1664
Funding Adjustments zone	Funding Adjustments on page 1667

Viewing the Log of a Funding Request

Procedure

To view the log of a funding request:

1. Search for the funding request in the **Funding Request** screen.
2. In the **Search Results** section, click the link in the **Funding Request Information** column corresponding to the funding request whose log you want to view.

The **Funding Request** screen appears.

3. Click the **Log** tab.

The **Log** tab appears.

4. View the complete trail of actions performed on the funding request in the **Funding Request Log** zone.

Related Topics

For more information on...	See...
How to search for a funding request	Searching for a Funding Request on page 1653
How to add a log entry for a funding request	Adding a Log Entry for a Funding Request on page 1687
Funding Request screen	Funding Request (Used for Viewing) on page 1655
Funding Request Log zone	Funding Request Log on page 1667

Adding a Log Entry for a Funding Request**Procedure**

To add a log entry for a funding request:

1. Search for the funding request in the **Funding Request** screen.
2. In the **Search Results** section, click the link in the **Funding Request Information** column corresponding to the funding request whose log you want to edit.

The **Funding Request** screen appears.

3. Click the **Log** tab.

The **Log** tab appears.

4. Click the **Add Log Entry** link in the upper right corner of the **Funding Request Log** zone.

The **Add Request Log** window appears. It contains the following fields:

Field Name	Field Description	Mandatory (Yes or No)
Request Information	Displays information about the funding request.	Not applicable
Log Details	Used to specify additional comments for the funding request.	Yes

5. Enter the comments in the **Log Details** field.
6. Click **Save**.

The log entry is added in the **Funding Request Log** zone.

Related Topics

For more information on...	See...
How to search for a funding request	Searching for a Funding Request on page 1653
Funding Request screen	Funding Request (Used for Viewing) on page 1655
Funding Request Log zone	Funding Request Log on page 1667

Chapter 25

Hold Request

Topics:

- [Hold Request \(Without Approval\) Status Transition](#)
- [Hold Request \(With Approval\) Status Transition](#)
- [Algorithms Used in C1-HoldRequest](#)
- [Prerequisites](#)
- [Approval Process for Hold Request Release](#)
- [Hold Refund](#)
- [Hold Mass Accounts Using Selection Criteria](#)
- [Hold Request Type](#)
- [Hold Request \(Used for Searching\)](#)
- [Hold Request \(Used for Viewing\)](#)

Oracle Revenue Management and Billing allows you to hold the amount for Person, Account or Bills. Hold is a way to prevent certain types of activities from taking place for a customer over a given period of time. The activities that need to be on Hold vary according to the reason for hold, such as due to a climate disaster the collection activity remains on Hold until disaster period is over.

Hold Request is a object which contains list of processes to be kept on hold for certain entities such as account, person, and bill for certain period of time. The hold period is defined as the duration between Hold Request Start Date and End Date. Each Hold Request contains an entity and processes on hold. There could exists multiple hold requests for an entity for different hold reasons and processes.

Following are the hold request entities:

- **Person:** If the person is on hold then all entities linked to that person where the person is financially responsible, such as accounts and its bills will be on hold.
- **Account:** If the account is on hold then all the bills of that account will be on hold.
- **Bill:** A bill will be on complete or partial hold.

In Hold Request, following mentioned processes can be on hold:

- **Auto Pay** — If the auto payment process is on hold then, then auto pay for the bills of the account added in hold request will be on hold till the request is released. However, you can do the manual payments. On activation of the hold request, **Defer Auto Pay Date** field (in Account screen) is populated with some future date. If billing process is on hold then auto payment process would also go on hold.
- **Bill Generation** — If the bill generation process is on hold then, then new bills will not be created for the account added in hold request till request is released. On activation of the hold request, **Bill After** date field (in Account screen) is populated with either hold request end date or some future date until that date billing is kept on hold. Whenever hold request is released for billing process then **Bill After** date field will be populated as system date.

Note: During the tenure of a hold request if customer does not require pending bills to be used for bill generation, bill in pending for accounts under hold are identified during activation of hold request which can be deleted by execution of the **C1-DELBI** batch . For more information about the batch, refer to *Oracle Revenue Management and Billing Batch Guide*

- **Overdue** — If the overdue process is on hold then bills associated with accounts in the hold request will be on hold for overdue process. It means existing overdue will be cancelled. New overdue process will get created once hold request is released. On activation of the hold request, **Postpone Credit Review** field (in Account screen) is populated with either hold request end date or some future date. When hold request is released, **Postpone Credit Review** field would be set as system date. If the overdue process is on hold then request for policy termination due to non payment will be on hold.
- **Funding** — A list of bills identified for a full bill amount or a partial bill amount will be kept on hold for a funding process.

Note:

For Funding process, Person, Bill, and Account entities can be put on hold. However, for processes like Auto pay, Bill Generation, and Overdue, only Account entity can be put on hold.

Processes and Entities start dates and end dates are expected to be within the limit of Hold Request Start Date and End Date.

You need to specify the hold request type while creating a hold request. Hold request type helps the system to determine:

- Whether to allow the partial hold for bill or not
- Whether hold request must be approved by the approver before keeping entities and processes on hold

It is possible for a given entity, such as a person or account, to be affected by hold request with differing periods or at differing levels. For example, if there is a hold request added for a person manually and another hold request is there due to some other reason for an account belongs to the person who is already on hold. The system assumes that both hold requests are in effect for the account and that the period of accounts starts from the start of the earlier hold request record (for the account) until the later of the two release dates.

During the hold request process, a hold request goes through various statuses in its lifecycle. For more information about the hold request statuses, see [Hold Request \(Without Approval\) Status Transition](#) on page 1691 and [Hold Request \(With Approval\) Status Transition](#) on page 1691

Note that the lifecycle of a hold request is driven by the business object using which the hold request is created. A hold request business object named **C1-HoldRequest** is shipped with the product. The hold request feature explained in this document is articulated based on the lifecycle and logic defined in the **C1-HoldRequest** business object. In addition, you can configure the search feature by setting **Fkref** feature configuration for each entity, such as person, account and bill.

For more information on how to setup the hold request processes, see [Prerequisites](#) on page 1697.

Hold Request (Without Approval) Status Transition

The following figure graphically indicates how a hold request moves from one status to another when approval workflow is off:

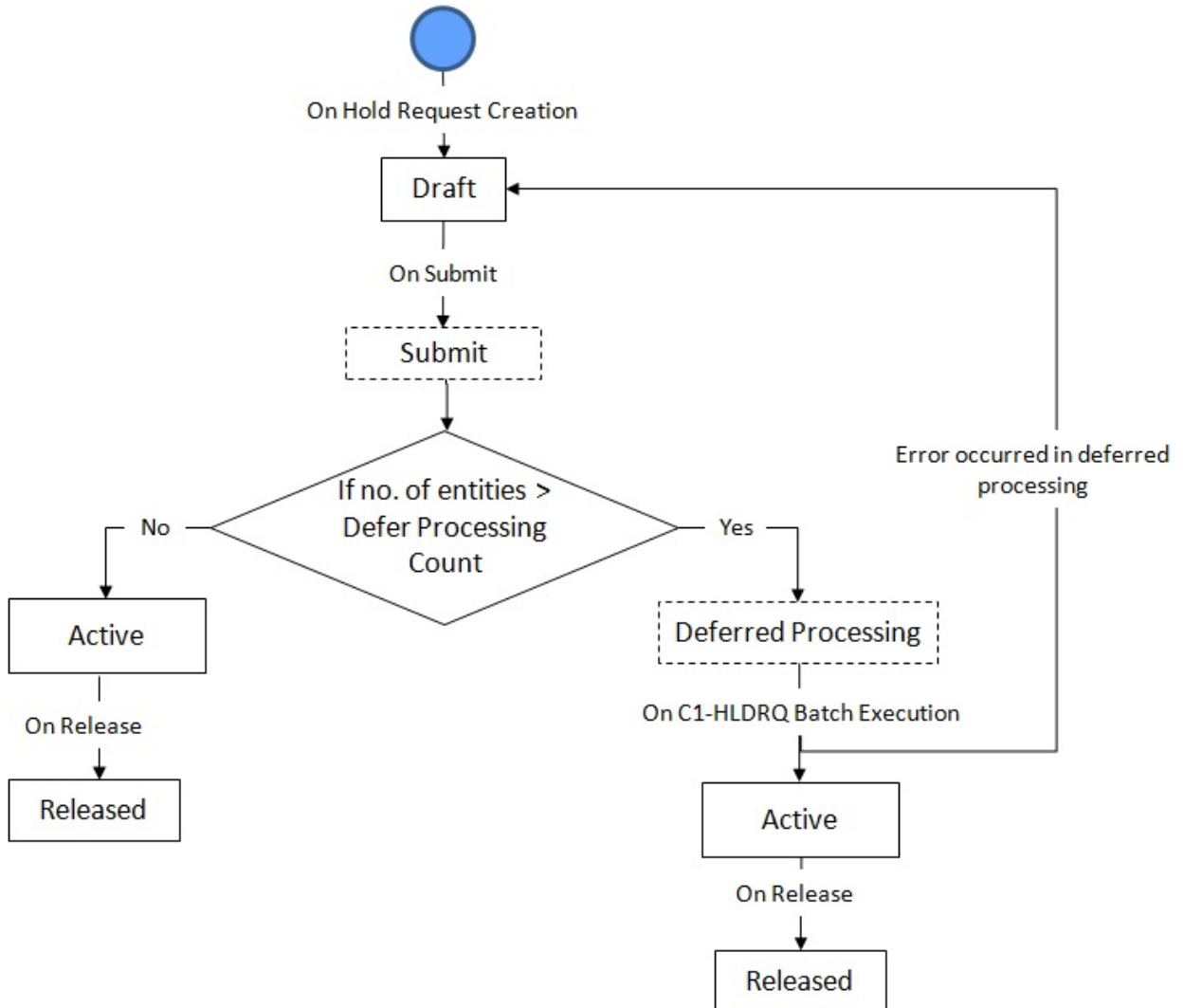

Hold Request (With Approval) Status Transition

The following figure graphically indicates how a hold request moves from one status to another when approval workflow is on:

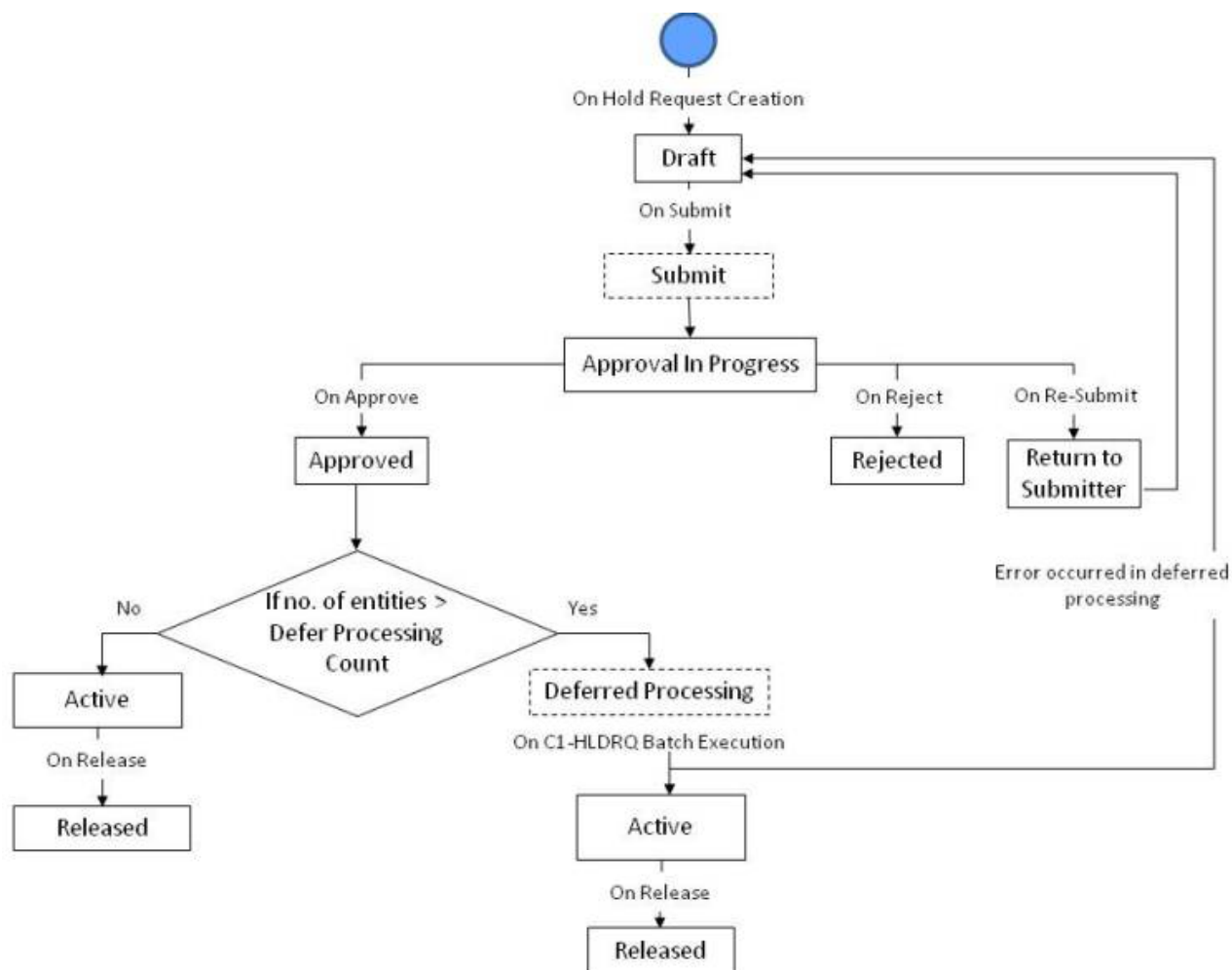

Algorithms Used in C1-HoldRequest

The following table lists the algorithms which are attached to the **C1-HoldRequest** business object:

System Event	Algorithm	Algorithm Type	Description
Information	C1-HOLD-INF	C1-HOLD-INF	This algorithm generates hold request information string which appears throughout the application. This algorithm concatenates the following fields: <ul style="list-style-type: none"> • Hold Request Type • Status • Entity • Hold Request ID
Validation	C1-HLDVALDN	C1-HLDVALDN	This algorithm validates following during different statuses: For Draft status, it checks the following:

System Event	Algorithm	Algorithm Type	Description
			<ul style="list-style-type: none"> • At least one Process is present in the request. Entity selection is optional • No duplicate entity and process is allowed in a single request. • Same entity cannot be placed on hold with the same Hold Reason in multiple Hold Requests. • Request start date is earlier than or equal to process and entity start date. • Request End Date is later than or equal to process and entity end date. • At least one process start date is earlier than or equal to any entity start date. • At least one process end date is later than or equal to any entity end date. • For Bill and Person entity, Bill Generation, Overdue, and Auto Pay processes cannot be selected as the hold processes in a hold request. • For Bill entity, it checks if hold amount is less than or equal to bill outstanding amount • For Bill entity, to add a new bill to the request, the selected bill should be with a non-zero outstanding amount. • Each Entities start date should lie within at least one process start date and end date in a request. <p>For Active state following are some additional validations:</p> <ul style="list-style-type: none"> • Hold Process or Entities cannot be deleted. • Hold Request or Entity or Process Start Date cannot be modified. • Hold Reason cannot be modified • Hold Request or Process or Entity End Date can be updated as either equal or greater than system date. • Process can be added with start date as system date. • Entity cannot be added in hold request. • If entity or process end date is in past then it cannot be updated.

The following table lists the algorithms which are used in the lifecycle of the **C1-HoldRequest** business object:

Status	System Event	Algorithm	Algorithm Type	Description
Draft	Enter	C1-HLDARCTRN	C1-HLDARCTRN	This algorithm transitions the request to active status when the request is created from Account Receivable Central and Delinquency Control .
Draft	Exit	F1-TODOCOMPL	F1-TODOCOMPL	This algorithm type completes To Do entries that are linked to an object when the object exits a given state. The system finds all open To Do entries with drill keys for primary key of the current business object, and completes them, unless the To Do entry's type has been configured with an Exclude To Do Type Characteristic Type indicating that it should not be automatically completed.
Submit	Enter	C1-HOLDSUBMT	C1-HOLDSUBMT	This algorithm checks the following: <ul style="list-style-type: none"> Whether the approval is required for the hold request. If the approval is required for a hold request, the status of the hold request is changed to Approval In Progress. However, if the approval is not required for a hold request, the status of the hold request is changed to Active or Deferred Processing depending on the Defer Processing Count specified in the hold request type.
Active	Enter	C1-HOLDACTV	C1-HOLDACTV	This algorithm is invoked on Active button and validates following: <ul style="list-style-type: none"> Entities Start Date is on or after Hold Request Start Date Entities End Date is on or before Hold Request End Date For an Entity Bill, Hold Amount is not more than bill outstanding amount or Bill outstanding amount is not equal to zero. Updates and processes entities start date to system date. It updates following mentioned date to minimum of Entity End Date or Process End Date: <ul style="list-style-type: none"> Bill After Date - For Bill Generation Process.

Status	System Event	Algorithm	Algorithm Type	Description
				<ul style="list-style-type: none"> Postpone Credit review Date Until- For Overdue Process. Defer Auto Pay Date - For Auto pay process. Parameter-Alert Type-Using this Alert Type alerts are shown in the dashboard. A alert will have hyperlink which will enable user to navigate to Alerts tab on account. Start Dates and End Dates of Alert types are maintained based on the Hold Requests associated with the account. <p>Note: If entity end date is empty, process end date will be considered. If process end date and entity is empty, Hold Request End Date will be considered.</p>
Deferred Processing	Monitor	F1-AT-RQJ	F1-AT-RQJ	This algorithm type transitions business object current state to the input Next Status or to the status related to the input Next Transition Condition. Only one of the soft parameters may be specified. If both soft parameters are not specified, the business object will be transitioned to the default next status specified on lifecycle. Algorithms of this algorithm type may be defined for any business object status as its monitor algorithm.
Approval In Progress	Enter	C1-HOLDAPP	C1-HOLDAPP	This algorithm creates To Do based on 'Approval To Do Type configured in Hold Request Type.
Approval In Progress	Exit	F1-TODOCOMPL	F1-TODOCOMPL	This algorithm type completes To Do entries that are linked to an object when the object exits a given state. The system finds all open To Do entries with drill keys for the current business object's primary key, and completes them, unless the To Do entry's type has been configured with an Exclude To Do Type Characteristic Type indicating that it should not be automatically completed.

Status	System Event	Algorithm	Algorithm Type	Description
Approved	Enter	C1-HOLDAPRVD	C1-HOLDAPRVD	This algorithm is triggered when the approver clicks the Approve button. It checks whether the approval is required from users at the next level in the approval profile hierarchy. If the approval is required from the next level in the approval hierarchy, the status of the hold request is changed to Approval In Progress . If further approval is not required, the status of the hold request is changed to Active or Deferred Processing depending on the Defer Processing Count specified in the hold request type.
Return to Submitter	Enter	C1-HLDRESUBM	C1-HLDRESUBM	This algorithm is triggered when the approver clicks the Re Submit button. A To Do is created and sent to the submitter. It transitions the status of the hold request from Approval In Progress to Draft . The submitter can make required changes to the request details and submit it again. The To Do Type and To Do Role for submitter is specified in hold request type.
Rejected	-	-	-	-
Released	Enter	C1-RELENTITY	C1-RELENTITY	This algorithm is invoked on Release button and updates following date to system date for all entities in the Hold Request: <ul style="list-style-type: none"> • Bill After Date - For Bill Generation Process • Postpone Credit review Date Until- For Overdue Process • Defer Auto Pay Date - For Auto pay process • Parameter-Alert Type-Using this Alert Type alerts are shown in the dashboard. A alert will have hyperlink which will enable user to navigate to Alerts tab on account • Start Dates and End Dates of Alert types are maintained based on the Hold Requests associated with the account.

Status	System Event	Algorithm	Algorithm Type	Description
Released	Enter	C1-RLSHOLD	C1-RLSHOLD	<p>This algorithm is invoked on click of Release button in hold request and updates the following:</p> <ul style="list-style-type: none"> • Hold Request End Date is updated to System Date • Processes End Date is updated to System Date • Entities End Date is updated to System Date • Hold request status is changed to Released after Hold Release Reason is accepted.

Prerequisites

To setup the hold request process, you need to do the following:

- Define the release status reasons for the **C1-HoldRequest** business object
- Define the required hold reasons in the system
- Define rejected status reasons for the **C1-HoldRequest** business object
- Assign the **C1-HLDAP** To Do type to a To Do role whose users must receive To Do generated while submitting a hold request for approval
- Assign the **C1-HOLSB** To Do type to a To Do role whose users must receive To Do generated while resubmitting a hold request
- Define the required hold request types in the system
- Define the required characteristic types where the characteristic entity is set to **Hold Request**
- Define the required characteristic types where the characteristic entity is set to **Hold Request Type**
- Set the batch control type of the **Hold Request Periodic Monitor (C1-HLDRQ)** and **Hold Request Monitor (C1-HLMON)** batches to Timed and define the following attributes:
 - Time Interval
 - Timer Active
 - User ID
 - Batch Language
 - Email Address

Note: For more information about the batch, refer to *Oracle Revenue Management and Billing Batch Guide*

Approval Process for Hold Request Release

Earlier, you were able to configure the approval process for activating a hold request. Now, you can configure the approval process for activating and/or releasing a hold request. To introduce this feature, the following changes are made in the system:

- The **Approval Required**, **Approval To Do Type**, and **Approval To Do Role** fields in the **Hold Request Type** screen are renamed to **Activation Approval**, **Activation Approval To Do Type**, and **Activation Approval To Do Role**, respectively.
- The **Release Approval**, **Release Approval To Do Type**, and **Release Approval To Do Role** fields are newly added in the **Hold Request Type** screen.
- The description of the **APPRPROGRESS** status in the **C1-HoldRequest** business object is changed to **Activation Approval In Progress**.
- The following new statuses are introduced in the **C1-HoldRequest** business object:
 - Release Approval in Progress
 - Release Request Approved
 - Return Release Request to Submitter

If you want to configure the approval process for hold request activation, you need to set the following fields in the respective hold request type - **Activation Approval**, **Activation Approval To Do Type**, and **Activation Approval To Do Role**. However, if you want to configure the approval process for hold request release, you need to set the following fields in the respective hold request type - **Release Approval**, **Release Approval To Do Type**, and **Release Approval To Do Role**. You can set the same or different approval configuration for hold request activation and release.

On clicking the **Release** button, the system does the following:

If...	Then...
<p>The Release Approval option is selected in the respective hold request type</p>	<p>A To Do is created using the To Do type specified in the Release Approval To Do Type field and sent to the approver having a To Do role specified in the Release Approval To Do Role field. The status of the hold request is then changed to Release Approval in Progress.</p> <p>The approver can review, and accordingly approve or resubmit the hold request based on the observations. On clicking the Approve button, the system updates the hold entity, hold process, and hold request end dates and then changes the status of the hold request to Released.</p> <p>Note: If the hold request is created for an account, the system also updates the following dates - Bill After Date, Postpone Credit Review Until, Defer Auto Pay Date, and Hold Request Until.</p> <p>However, on clicking the Resubmit button, the system enables you to enter the reason why you want to reject the hold release request. Once you specify the reason, the system changes the status of the hold request to Active. In addition, a To Do is created using the To Do type specified in the Submitter To Do Type field and sent to the approver having a To Do role specified in the Submitter To Do Role field.</p>
<p>The Release Approval option is not selected in the respective hold request type</p>	<p>The system then changes the hold entity, hold process, and hold request end dates. Finally, the status of the hold request is changed to Released.</p> <p>Note: If the hold request is created for an account, the system also updates the following dates - Bill After Date, Postpone Credit Review Until, Defer Auto Pay Date, and Hold Request Until.</p>

Hold Refund

Until now, you were able to hold the bill generation, auto pay, funding, and overdue process for an account through a hold request. Now, in addition, the system enables you to hold the refund process for an account through a hold request. If the refund process is kept on hold for an account, the system does not process the refund requests (if any) created for the account. However, the system does not stop you from creating A/P adjustments for an account from the **Adjustment** screen when the refund process is kept on hold for the account.

While adding the refund process in a hold request, you need to specify the date range for which you want to hold the refund process for the accounts. The system enables you to add the refund process in a hold request from the user interface or through the upload request feature. If you want to create a hold request for an account through the upload request feature, you need to specify the following details in the CSV file:

- Whether you want to hold the refund process for the accounts (the valid values are Y or N)
- Hold refund start date (required if the hold refund is set to Y)
- Hold refund end date

On activating a hold request, the system stamps the hold refund until date corresponding to each account in the hold request. The hold refund until date is set to the hold entity end date or refund process end date whichever is earlier. This means that the system will allow to process the refund request of the account only after hold refund until date. If the number of accounts in a hold request is less than the defer processing count specified in the respective hold request type, the system stamps the hold refund until date immediately for each account in the hold request. In addition, the system changes the status of the refund request (if any) for respective accounts to **Hold**.

However, if the number of accounts in a hold request is equal to or greater than the defer processing count specified in the respective hold request type, the system stamps the hold refund until date for each account in the hold request when the **C1-HLMON** batch is executed. In addition, the **C1-HLMON** batch changes the status of the refund request (if any) for respective accounts to **Hold**.

When you manually release a hold request from the user interface, the system sets the hold request, hold entities, and hold processes end dates (which are later than or equal to the system date) to the system date and then changes the status of the hold request to **Released**. In addition, if the number of accounts in a hold request is less than the defer processing count specified in the respective hold request type, the system immediately sets the hold refund until date (which is later than or equal to the system date) to the system date for the account in the hold request. In addition, the system immediately changes the status of the refund request (if any) for respective accounts from **Hold** to its previous status.

However, if the number of accounts in a hold request is equal to or greater than the defer processing count specified in the respective hold request type, the system sets the hold refund until date (which is later than or equal to the system date) to the system date for the account in the hold request when the **C1-HLMON** batch is executed. In addition, the **C1-HLMON** batch changes the status of the refund request (if any) for respective accounts from **Hold** to its previous status.

Hold Mass Accounts Using Selection Criteria

Until now, you were able to add multiple accounts in a hold request by specifying their respective account ID. Now, this feature is extended wherein you can specify a selection criteria to derive the list of accounts which you want to add in a hold request. A new option named **Use Selection Criteria** is available when you set the entity to **Account** while creating a hold request. On selecting the **Use Selection Criteria** option, the **Hold Entities** section is removed from the **Hold Request** screen. Instead, a new section named **Account Selection Criteria** appears in the **Hold Request** screen. This section enables you to specify the criteria for deriving accounts using the account, person, policy, or individual membership details. You can specify the criteria for deriving accounts using the policy or individual membership details only when the **Environment Type** option type of a feature configuration which is created using the **General System Configuration** feature type is set to **H**.

A new status named **Entity Derivation Pending** is added in the lifecycle of the **C1-HoldRequest** business object. While saving a hold request with account selection criteria, the system creates the hold request in the **Entity Derivation Pending** status. However, while saving a hold request without account selection criteria, the system creates the hold request in the **Draft** status.

A new batch named **C1-HLDET** is introduced in this release. It checks whether there are any hold requests in the **Entity Derivation Pending** status. The system considers those hold requests whose start date is earlier than or equal to batch

business date. If there is a hold request in the **Entity Derivation Pending** status, the batch derives the accounts for the hold request and then changes the status of the hold request from **Entity Derivation Pending** to **Draft**.

You can then add more accounts (if required) manually from the user interface. You can also edit or delete the accounts derived through the criteria from the hold request.

Hold Request Type

Oracle Revenue Management and Billing allows you to define a hold request type using which you can create a hold request.

The **Hold Request Type** screen allows you to define, edit, copy, and delete a hold request type. This screen consists of the following zones:

- [Hold Request Type List](#) on page 1700
- [Hold Request Type](#) on page 1700

Hold Request Type List

The **Hold Request Type List** zone lists hold request types that are already defined in the system. It contains the following columns:

Column Name	Column Description
Hold Request Type	Displays the hold request type.
Description	Displays the description of the hold request type.
Edit	On clicking the Edit (✎) icon, the Hold Request Type screen appears where you can edit the details of the hold request type.
Duplicate	On clicking the Duplicate (📄) icon, the Hold Request Type screen appears where you can define a hold request type using an existing hold request type.
Delete	On clicking the Delete (🗑) icon, you can delete the hold request type.
	Note: You can delete a hold request type when you have not created a hold request using the hold request type.

On clicking the **Broadcast** (📡) icon corresponding to the hold request type, the **Hold Request Type** zone appears with the details of the respective hold request type.

Related Topics

For more information on...	See...
How to define a hold request type	Defining a Hold Request Type on page 1703
How to edit a hold request type	Editing a Hold Request Type on page 1706
How to copy a hold request type	Copying a Hold Request Type on page 1709
How to delete a hold request type	Deleting a Hold Request Type on page 1709
How to view the details of a hold request type	Viewing the Hold Request Type Details on page 1712

Hold Request Type

The **Hold Request Type** zone displays the details of the hold request type. This zone consists of the following sections:

- **Main** — This section provides basic information about the hold request type. It contains the following fields:

Field Name	Field Description
Hold Request Type	Displays the hold request type.
Description	Displays the description of the hold request type.
Hold Request Business Object	Indicates the business object that will be used to create the hold request. Note: It has a link. On clicking the link, the Business Object screen appears where you can view the details of the respective business object.
Detailed Description	Displays additional information about the hold request type.
Status	Indicates the status of the hold request type. The valid values are: <ul style="list-style-type: none"> • Active • Inactive
Allow Partial Hold for Bill	Indicates whether the partial hold amount is allowed for a bill.
Defer Processing Count	Displays the number of entities to determine if the hold request will be processed in deferred mode. Note: If the number of entities is less than the Defer Processing Count , the hold request will be processed in real time (i.e. immediately).
Approval Required	Indicates whether approval is required while creating the hold request using hold request type.
Approval To Do Type	Indicates that To Do of the specified To Do type must be created when you submit the hold request for approval. Note: This field appears when the Approval Required check box is selected. It has a link. On clicking the link, the To Do Type screen appears with the details of the respective To Do type.
Approval To Do Role	Indicates that users with the specified To Do role can only approve the hold request submitted for approval. Note: This field appears when the Approval Required check box is selected. It has a link. On clicking the link, the To Do Role screen appears where you can view the details of the respective To Do role.
Submitter To Do Type	Indicates the To Do type of the submitter.

Field Name	Field Description
	Note: It has a link. On clicking the link, the To Do Type screen appears where you can view the details of the respective To Do type.
Submitter To Do Role	Indicates the To Do role of the submitter.
	Note: It has a link. On clicking the link, the To Do Role screen appears where you can view the details of the respective To Do role.

- **Hold Processes** — This section displays the list of processes to be kept on hold for the hold request type.
- **Characteristics** — This section lists the characteristics of the hold request type. It contains the following columns:

Column Name	Column Description
Characteristic Type	Indicates the characteristic type.
Characteristic Value	Displays the value of the characteristic type.

- **Record Actions** — This section contains the following buttons:

Button Name	Button Description
Edit	Used to edit the details of the hold request type.
Delete	Used to delete the hold request type.
	Note: You can delete a hold request type when you have not created a hold request using the hold request type.
Duplicate	Used to create a new hold request type using an existing hold request type.

- **Record Information** — This section contains the following fields:

Field Name	Field Description
Business Object	Indicates the business object using which the hold request type is created. In addition, a context menu appears corresponding to this field which helps in navigating to other screens in the application.
	Note: It has a link. On clicking the link, the Business Object screen appears where you can view the details of the respective business object.

By default, the **Hold Request Type** zone does not appear in the **Hold Request Type** screen. It appears when you click the **Broadcast** (📡) icon corresponding to the hold request type in the **Hold Request Type List** zone.

Related Topics

For more information on...	See...
How to define a hold request type	Defining a Hold Request Type on page 1703
How to edit a hold request type	Editing a Hold Request Type on page 1706
How to copy a hold request type	Copying a Hold Request Type on page 1709
How to delete a hold request type	Deleting a Hold Request Type on page 1709
How to view the details of a hold request type	Viewing the Hold Request Type Details on page 1712

Defining a Hold Request Type

Prerequisites

To define a hold request type, you should have:

- Hold request business objects defined in the application

Procedure

To define a hold request type:

1. Click the **Admin** link in the **Application** toolbar.
A list appears.
2. From the **Admin** menu, select **H** and then click **Hold Request Type**.
A sub-menu appears.
3. Click the **Add** option from the **Hold Request Type** sub-menu.

The **Select Business Object** screen appears. It contains the following fields:

Field Name	Field Description	Mandatory (Yes or No)
Hold Request Type Business Object	Used to indicate the business object that you want to use to create the hold request type.	Yes

Tip: Alternatively, you can access the **Select Business Object** screen by clicking the **Add** button in the **Page Title** area of the **Hold Request Type** screen.

Note: The **Select Business Object** screen appears when there are multiple hold request type business objects defined in the application. If there is only one hold request type business object defined in the application, the **Hold Request Type** screen appears.

4. Select the required hold request type business object from the respective field.
5. Click **OK**.

The **Hold Request Type** screen appears. It contains the following sections:

- **Main** — Used to specify basic details about the hold request type.
- **Hold Processes** — Used to define the processes to hold for the hold request type.
- **Characteristics** — Used to define the characteristics for the hold request type.

The **Main** section contains the following fields:

Field Name	Field Description	Mandatory (Yes or No)
Hold Request Type	Used to specify the hold request type.	Yes
Business Object	Indicates the hold request type business object used while defining the hold request type.	Not applicable
Description	Used to specify the description for the hold request type.	Yes
Hold Request Business Object	Used to indicate the business object that you want to use while creating the hold request.	Yes

Field Name	Field Description	Mandatory (Yes or No)
Detailed Description	Used to specify additional information about the hold request type.	No
Status	Used to indicate the status of the hold request type. The valid values are: <ul style="list-style-type: none"> Active Inactive <p>Note: You cannot change the status of a hold request type to Inactive if there are hold requests which are created using the hold request type and are currently in the Draft or Approval In Progress status.</p>	Yes
Allow Partial Hold for Bill	Used to indicate whether the partial hold amount will be accepted for a bill.	Yes
Defer Processing Count	Used to indicate the number of entities to determine if the hold request will be processed in deferred mode. <p>Note: If the number of entities is less than the Defer Processing Count, the hold request will be processed in real time (i.e. immediately). Defer processing count should be a numerical value without decimal points.</p>	No
Approval Required	Used to indicate whether approval is required while creating the hold request using hold request type.	No
Approval To Do Type	Used to indicate that To Do of the specified To Do type must be created when you submit the hold request for approval. <p>Note: This field appears when the Approval Required check box is selected.</p>	Yes (Conditional) <p>Note: This field is required when the Approval Required check box is selected</p>
Approval To Do Role	Used to indicate that users with the specified To Do role can only approve the hold request submitted for approval. <p>Note: This field appears when the Approval Required check box is selected.</p>	Yes (Conditional) <p>Note: This field is required when the Approval Required check box is selected</p>
Submitter To Do Type	Used to indicate the To Do type for the submitter.	No

Field Name	Field Description	Mandatory (Yes or No)
Submitter To Do Role	Used to indicate the To Do role for the submitter.	No

Note:

Deferred mode means in the background when the **Hold Request Periodic Monitor (C1-HLDRQ)** batch is invoked. You can configure the **Hold Request Periodic Monitor (C1-HLDRQ)** batch such that it is executed at regular intervals. When the **Hold Request Periodic Monitor (C1-HLDRQ)** batch is invoked, the system checks whether there are any hold requests in the **Deferred** status. If there is an hold request in the **Deferred** status, then its status is changed to **Active**.

- Enter the required details.

Note: You can search for **To Do Type** by clicking the **Search** (🔍) icon corresponding to the respective field.

- Define processes to hold for the hold request type.

Note:

At least one hold process needs to be selected for defining a hold request type.

- Define characteristics for the hold request type, if required.
- Click **Save**.

The hold request type is defined.

Related Topics

For more information on...	See...
Hold Request Type screen	Hold Request Type on page 1700
Hold Request Type List zone	Hold Request Type List on page 1700
How to define a characteristic for a hold request type	Defining a Characteristic for a Hold Request Type on page 1705

Defining a Characteristic for a Hold Request Type**Prerequisites**

To define a characteristic for a hold request type, you should have:

- Characteristic types defined in the application (where the characteristic entity is set to **Hold Request Type**)

Procedure

To define a characteristic for a hold request type:

- Ensure that the **Characteristics** section is expanded when you are defining, editing, or copying a hold request type.

The **Characteristics** section contains the following fields:

Field Name	Field Description	Mandatory (Yes or No)
Characteristic Type	Used to indicate the characteristic type.	Yes (Conditional)
	Note: The list includes only those characteristic types where the characteristic entity is set to Hold Request Type .	Note: This field is required when you are defining a characteristic for the hold request type.
Characteristic Value	Used to specify the value for the characteristic type.	Yes (Conditional)
	Note: On specifying the value for a predefined characteristic type, the description of the characteristic value appears corresponding to the Characteristic Value field.	Note: This field is required when you are defining a characteristic for the hold request type.

- Enter the required details.

Note: If you select a predefined characteristic type, the **Search** (🔍) icon appears corresponding to the **Characteristic Value** field. On clicking the **Search** icon, you can search for a predefined characteristic value.

- If you want to define more than one characteristic for the hold request type, click the **Add** (+) icon and then repeat step 2.

Note: However, if you want to remove a characteristic from the hold request type, click the **Delete** (🗑️) icon corresponding to the characteristic.

Related Topics

For more information on...	See...
How to define a hold request type	Defining a Hold Request Type on page 1703
How to edit a hold request type	Editing a Hold Request Type on page 1706
How to copy a hold request type	Copying a Hold Request Type on page 1709

Editing a Hold Request Type

Prerequisites

To edit a hold request type, you should have:

- Hold request business objects defined in the application

Procedure

To edit a hold request type:

- Click the **Admin** link in the **Application** toolbar.
A list appears.
- From the **Admin** menu, select **H** and then click **Hold Request Type**.
A sub-menu appears.

- Click the **Search** option from the **Hold Request Type** sub-menu.

The **Hold Request Type** screen appears.

- In the **Hold Request Type List** zone, click the **Edit** (✎) icon in the **Edit** column corresponding to the hold request type whose details you want to edit.

The **Hold Request Type** screen appears. It contains the following sections:

- **Main** — Used to specify basic details about the hold request type.
- **Hold Processes** — Used to define the processes to hold for the hold request type.
- **Characteristics** — Used to define the characteristics for the hold request type.

The **Main** section contains the following fields:

Field Name	Field Description	Mandatory (Yes or No)
Hold Request Type	Displays the hold request type.	Not applicable
Business Object	Indicates the hold request type business object used while defining the hold request type.	Not applicable
Description	Used to specify the description for the hold request type.	Yes
Hold Request Business Object	Used to indicate the business object that you want to use while creating the hold request.	Yes
Detailed Description	Used to specify additional information about the hold request type.	No
Status	Used to indicate the status of the hold request type. The valid values are: <ul style="list-style-type: none"> • Active • Inactive <div style="border: 1px solid black; padding: 5px; margin-top: 5px;"> <p>Note: You cannot change the status of a hold request type to Inactive if there are hold requests which are created using the hold request type and are currently in the Draft or Approval In Progress status.</p> </div>	Yes
Allow Partial Hold for Bill	Used to indicate whether the partial hold amount will be accepted for a bill.	Yes
Defer Processing Count	Used to indicate the number of entities to determine if the hold request will be processed in deferred mode.	No

Field Name	Field Description	Mandatory (Yes or No)
	<p>Note:</p> <p>If the number of entities is less than the Defer Processing Count, the hold request will be processed in real time (i.e. immediately).</p> <p>Defer processing count should be a numerical value without decimal points.</p>	
Approval Required	Used to indicate whether approval is required while creating the hold request using hold request type.	No
Approval To Do Type	Used to indicate that To Do of the specified To Do type must be created when you submit the hold request for approval.	Yes (Conditional)
	Note: This field appears when the Approval Required check box is selected.	Note: This field is required when the Approval Required check box is selected
Approval To Do Role	Used to indicate that users with the specified To Do role can only approve the hold request submitted for approval.	Yes (Conditional)
	Note: This field appears when the Approval Required check box is selected.	Note: This field is required when the Approval Required check box is selected
Submitter To Do Type	Used to indicate the To Do type for the submitter.	No
Submitter To Do Role	Used to indicate the To Do role for the submitter.	No

Note:

Deferred mode means in the background when the **Hold Request Periodic Monitor (C1-HLDRQ)** batch is invoked. You can configure the **Hold Request Periodic Monitor (C1-HLDRQ)** batch such that it is executed at regular intervals. When the **Hold Request Periodic Monitor (C1-HLDRQ)** batch is invoked, the system checks whether there are any hold requests in the **Deferred** status. If there is an hold request in the **Deferred** status, then its status is changed to **Active**.

Tip: Alternatively, you can click the **Edit** button in the **Hold Request Type** zone to edit the details of the hold request type.

5. Modify the details, if required.
6. Define, edit, or remove characteristics of the hold request type, if required.
7. Click **Save**.

The changes made to the hold request type are saved.

Related Topics

For more information on...	See...
Hold Request Type screen	Hold Request Type on page 1700
Hold Request Type List zone	Hold Request Type List on page 1700
Hold Request Type zone	Hold Request Type on page 1700
How to define a characteristic for a hold request type	Defining a Characteristic for a Hold Request Type on page 1705

Deleting a Hold Request Type

Procedure

To delete a hold request type:

1. Click the **Admin** link in the **Application** toolbar.
A list appears.
2. From the **Admin** menu, select **H** and then click **Hold Request Type**.
A sub-menu appears.
3. Click the **Search** option from the **Hold Request Type** sub-menu.
The **Hold Request Type** screen appears.
4. In the **Hold Request Type List** zone, click the **Delete** (🗑) icon in the **Delete** column corresponding to the hold request type that you want to delete.
A message appears confirming whether you want to delete the hold request type.

Note: You can delete a hold request type when you have not defined a hold request using the hold request type.

Tip: Alternatively, you can click the **Delete** button in the **Hold Request Type** zone to delete the hold request type.

5. Click **OK**.
The hold request type is deleted.

Related Topics

For more information on...	See...
Hold Request Type screen	Hold Request Type on page 1700
Hold Request Type List zone	Hold Request Type List on page 1700
Hold Request Type zone	Hold Request Type on page 1700

Copying a Hold Request Type

Instead of creating a hold request type from scratch, you can create a new hold request type using an existing hold request type. This is possible through copying a hold request type. On copying a hold request type, the details including the characteristics are copied to the new hold request type. You can then edit the details, if required.

Prerequisites

To copy a hold request type, you should have:

- Hold request type (whose copy you want to create) defined in the application
- Hold request business objects defined in the application

Procedure

To copy a hold request type:

1. Click the **Admin** link in the **Application** toolbar.
A list appears.
2. From the **Admin** menu, select **H** and then click **Hold Request Type**.
A sub-menu appears.
3. Click the **Search** option from the **Hold Request Type** sub-menu.
The **Hold Request Type** screen appears.
4. In the **Hold Request Type List** zone, click the **Duplicate** () icon in the **Duplicate** column corresponding to the hold request type whose copy you want to create.

The **Hold Request Type** screen appears. It contains the following sections:

- **Main** — Used to specify basic details about the hold request type.
- **Hold Processes** — Used to define the processes to hold for the hold request type.
- **Characteristics** — Used to define the characteristics for the hold request type.

The **Main** section contains the following fields:

Field Name	Field Description	Mandatory (Yes or No)
Hold Request Type	Used to specify the hold request type.	Yes
Business Object	Indicates the hold request type business object used while defining the hold request type.	Not applicable
Description	Used to specify the description for the hold request type.	Yes
Hold Request Business Object	Used to indicate the business object that you want to use while creating the hold request.	Yes
Detailed Description	Used to specify additional information about the hold request type.	No
Status	Used to indicate the status of the hold request type. The valid values are: <ul style="list-style-type: none"> • Active • Inactive <p>Note: You cannot change the status of a hold request type to Inactive if there are hold requests which are created using the hold request type and are currently in the Draft or Approval In Progress status.</p>	Yes

Field Name	Field Description	Mandatory (Yes or No)
Allow Partial Hold for Bill	Used to indicate whether the partial hold amount will be accepted for a bill.	Yes
Defer Processing Count	<p>used to indicate the number of bills to determine if the hold request will be processed in deferred mode.</p> <p>Note: Deferred mode means in the background when the Hold Request Periodic Monitor (C1-HLDRQ) batch is invoked. You can configure the Hold Request Periodic Monitor (C1-HLDRQ) batch such that it is executed at regular intervals. When the Hold Request Periodic Monitor (C1-HLDRQ) batch is invoked, the system checks whether there are any hold requests in the Deferred status. If there is an hold request in the Deferred status, then its status is changed to Active.</p> <p>If the number of bills is less than the Defer Processing Count, the hold request will be processed in real time (i.e. immediately).</p> <p>Defer processing count should be a numerical value without decimal points.</p>	No
Approval Required	Used to indicate whether approval is required while creating the hold request using hold request type.	No
Approval To Do Type	<p>Used to indicate that To Do of the specified To Do type must be created when you submit the hold request for approval.</p> <p>Note: This field appears when the Approval Required check box is selected.</p>	<p>Yes (Conditional)</p> <p>Note: This field is required when the Approval Required check box is selected</p>
Approval To Do Role	<p>Used to indicate that users with the specified To Do role can only approve the hold request submitted for approval.</p> <p>Note: This field appears when the Approval Required check box is selected.</p>	<p>Yes (Conditional)</p> <p>Note: This field is required when the Approval Required check box is selected</p>
Submitter To Do Type	Used to indicate the To Do type for the submitter.	No

Field Name	Field Description	Mandatory (Yes or No)
Submitter To Do Role	Used to indicate the To Do role for the submitter.	No

Tip: Alternatively, you can click the **Duplicate** button in the **Hold Request Type** zone to create a copy of the hold request type.

5. Enter the required details.
6. Define, edit or remove processes from the hold request type, if required.
7. Define, edit, or remove characteristics of the hold request type, if required.
8. Click **Save**.

The new hold request type is defined.

Related Topics

For more information on...	See...
Hold Request Type screen	Hold Request Type on page 1700
Hold Request Type List zone	Hold Request Type List on page 1700
Hold Request Type zone	Hold Request Type on page 1700
How to define a characteristic for a hold request type	Defining a Characteristic for a Hold Request Type on page 1705

Viewing the Hold Request Type Details

Procedure

To view the details of a hold request type:

1. Click the **Admin** link in the **Application** toolbar.
A list appears.
2. From the **Admin** menu, select **H** and then click **Hold Request Type**.
A sub-menu appears.
3. Click the **Search** option from the **Hold Request Type** sub-menu.
The **Hold Request Type** screen appears.
4. In the **Hold Request Type List** zone, click the **Broadcast** () icon corresponding to the hold request type whose details you want to view.
The **Hold Request Type** zone appears.
5. View the details of the hold request type in the **Hold Request Type** zone.

Related Topics

For more information on...	See...
Hold Request Type screen	Hold Request Type on page 1700
Hold Request Type List zone	Hold Request Type List on page 1700
Hold Request Type zone	Hold Request Type on page 1700

--

Hold Request (Used for Searching)

The **Hold Request** screen allows you to search for a hold request using various search criteria. It also allows you to create a hold request. Through this screen, you can navigate to the following screen:

- [Hold Request \(Used for Viewing\)](#) on page 1720

This screen consists of the following zone:

- [Search Hold Request](#) on page 1713

Search Hold Request

The **Search Hold Request** zone allows you to search for hold requests using various search criteria. This zone contains the following two sections:

- **Search Criteria** - The **Search Criteria** section contains the following fields:

Field Name	Field Description	Mandatory (Yes or No)
Search By	Used to indicate whether you want to search for a hold request using request or bill details. The valid values are: <ul style="list-style-type: none"> • Request Details • Bill Details <p>Note: By default, the Request Details option is selected.</p>	Yes
Hold Request Type	Used to search hold requests which are created using a particular hold request type. <p>Note: This field appears when you select the Request Details option from the Search By list.</p>	No
Entity	Used to search hold request with a particular entity. The valid values are: <ul style="list-style-type: none"> • Account • Person • Bill <p>Note: This field appears when you select the Request Details option from the Search By list.</p>	No
Hold Process	Used to search hold requests which are created using a particular hold process. <p>Note: This field appears when you select the Request Details option from the Search By list.</p>	No
User ID	Used to search hold requests which are created by a particular user.	

Field Name	Field Description	Mandatory (Yes or No)
	Note: This field appears when you select the Request Details option from the Search By list.	
Hold Reason	Used to search hold requests which are created using a particular hold reason. Note: This field appears when you select the Request Details option from the Search By list.	No
Start Date	Used to search hold requests which are created from a particular date onwards. Note: This field appears when you select the Request Details option from the Search By list.	No
Status	Used to search hold requests with a particular status. The valid values are: <ul style="list-style-type: none"> • Active • Draft • Released • Approval In Progress • Deferred Processing • Rejected Note: This field appears when you select the Request Details option from the Search By list.	No
End Date	Used to search hold requests which are created till a particular date. Note: This field appears when you select the Request Details option from the Search By list.	No
Account ID	Used to search hold requests which are created for a particular account. Note: This field appears when you select the Request Details option from the Search By list. You can search for an account by clicking the Search  icon corresponding to the field.	No
Hold Request ID	Used to search a particular hold request. Note: This field appears when you select the Request Details option from the Search By list.	No

Field Name	Field Description	Mandatory (Yes or No)
Person ID	Used to search hold requests which are created for a particular person. Note: This field appears when you select the Request Details option from the Search By list. You can search for a person by clicking the Search (🔍) icon corresponding to the field.	No
Bill ID	Used to search hold requests which includes bill segments or adjustments of a particular bill. Note: This field appears only when you select the Bill Details option from the Search By list. You can search for a bill by clicking the Search (🔍) icon corresponding to the field.	No
Bill Date From	Used to search hold requests which includes bill segments or adjustments of bills which are created from a particular date onwards. Note: This field appears when you select the Bill Details option from the Search By list.	No
To	Used to search hold requests which includes bill segments or adjustments of bills which are created till a particular date. Note: This field appears when you select the Bill Details option from the Search By list.	No

Note: You must specify at least one search criterion while searching for a hold request.

- **Search Results** - On clicking the **Search** button, the search results appear based on the specified search criteria. The **Search Results** section contains the following columns:

Column Name	Column Description
Create Date/Time	Displays the date and time when the hold request is created.
Hold Request Information	Displays information about the hold request. Note: It has a link. On clicking the link, the Hold Request screen appears where you can view the details of the respective hold request.
Status	Indicates the status of the hold request. The valid values are: <ul style="list-style-type: none"> • Active • Draft

Column Name	Column Description
	<ul style="list-style-type: none"> Released Approval In Progress Deferred Processing Rejected
Start Date	Displays the date when the hold request is created.
End Date	Displays the date when the hold request is released.
Hold Processes	Displays the hold processes using which hold request is created.
Hold Reason	Displays the hold reason for the hold request.
Created By	Indicates the user who has created the hold request.

Related Topics

For more information on...	See...
How to search for a hold request	Searching for a Hold Request on page 1716
How to view the details of a hold request	Viewing the Hold Request Details on page 1719
How to create a hold request	Creating a Hold Request on page 1717

Searching for a Hold Request

Prerequisites

To search for a hold request, you should have:

- Hold request types defined in the application

Procedure

To search for a hold request:

- Click the **Menu** link in the **Application** toolbar.
A list appears.
- From the **Main** menu, select **Accounting and Receivable** and then click **Hold Request**.
A sub-menu appears.
- Click the **Search** option from the **Hold Request** sub-menu.
The **Hold Request** screen appears.
- Enter the search criteria in the **Search Hold Request** zone.

Note: ORMB search engine supports wildcard search, where you can substitute the percentage (%) symbol as a stand in for any word or letter in a search criteria. You can use the ‘%’ wildcard character in all input fields except the date and ID fields. The ‘%’ wildcard character is suffixed automatically at the end of the partial search criteria. Therefore, you may or may not specify the wildcard character at the end of the partial search criteria. However, you have to prefix the wildcard character manually wherever required.

- Click **Search**.

A list of hold requests that meet the search criteria appears in the **Search Results** section.

Related Topics

For more information on...	See...
Hold Request screen	Hold Request (Used for Searching) on page 1713
Search Hold Request zone	Search Hold Request on page 1713

Creating a Hold Request**Prerequisites**

To create a hold request, you should have:

- Hold request types defined in the application.
- Hold request reasons defined in the application.
- Hold request entities defined in the application.
- Hold request processes defined in the application.

Procedure

To create a hold request:

1. Do either of the following:

If you want to...	Then...
Define a hold request from the Account Receivable Central screen	<ol style="list-style-type: none"> 1. Click the Menu link in the Application toolbar. A list appears. 2. From the Main menu, select Accounting and Receivable and then click Account Receivable Central. The Account Receivable Central screen appears. 3. Search for the bill in the Account Receivable Central screen. 4. In the Search Results section, select the required bill and then click Hold. <p>Note: Bills are selected to be on hold from Account Receivable Central. Only one bill at a time is allowed to select for Hold Request from Account Receivable Central</p>
Define a hold request from the Delinquency Central screen	<ol style="list-style-type: none"> 1. Click the Menu link in the Application toolbar. A list appears. 2. From the Main menu, select Delinquency Management and then click Delinquency Central. The Delinquency Central screen appears. 3. Search for the overdue process in the Delinquency Central screen.

If you want to...	Then...
	<p>4. In the Search Results section, select the required overdue process and then click Create Hold Request.</p> <p>Note: Accounts are selected to be on hold from Delinquency Central screen Only one account at a time is allowed to select for Hold Request from Delinquency Central screen.</p>
Define a hold request from the Hold Request screen	<p>1. Click the Menu link in the Application toolbar. A list appears.</p> <p>2. From the Main menu, select Accounting and Receivable and then click Hold Request. A sub-menu appears.</p> <p>3. Click the Add option from the Hold Request sub-menu.</p>

The **Add Hold Request** screen appears. It contains the following fields:

Field Name	Field Description	Mandatory (Yes or No)
Hold Request Type	Used to indicate the request type using which you want to create the hold request.	Yes

Tip: Alternatively, you can access the **Add Hold Request** screen by clicking the **Add** button in the **Page Title** area of the **Hold Request** screen.

2. Select the required hold request type from the respective field.
3. Click **OK**.

The **Hold Request** screen appears. It contains the following sections:

- **Main** – Used to specify basic details about the hold request. This section contains the following fields:

Field Name	Field Description	Mandatory (Yes or No)
Hold Request Type	Indicates the hold request type using which you want to create the hold request.	Not applicable
Start Date	Used to specify the date from when the hold request is effective. Note: The hold request start date cannot be later than the hold request end date. By default, system date appears in this field.	Yes
End Date	Used to specify the date till when the hold request is effective.	Yes

Field Name	Field Description	Mandatory (Yes or No)
	Note: The hold request end date cannot be earlier than the hold request start date.	
Hold Reason	Used to indicate the reason why you want to hold the entity.	Yes
Entity	Used to indicate the type of the entity for which you want to create the hold request. The valid values are: <ul style="list-style-type: none"> • Account • Bill • Person Note: If a bill is kept on hold using the Account Receivable Central screen, then this field displays Bill as an entity and the Hold Entities section displays information about the bill.	Yes
Comments	Used to specify additional information about the hold request.	No

4. Enter the required details in the **Hold Request** screen.
5. Define entities for the hold request, if required.
6. Define processes for the hold request.
7. Define characteristics for the hold request, if required.
8. Click **Save**.

The hold request is created in the **Draft** status.

Note: It is recommended that user should set the **C1-HLMON** batch every time the hold request is generated. Otherwise, alert would be shown in the dashboard which may not give the proper representation of active hold requests.

Related Topics

For more information on...	See...
Hold Request screen	Hold Request (Used for Searching) on page 1713
How to define an entity for a hold request	Defining an Entity for a Hold Request on page 1737
How to define a process for a hold request	Defining a Process for a Hold Request on page 1738
How to define a characteristic for a hold request	Defining a Characteristic for a Hold Request on page 1739

Viewing the Hold Request Details

Procedure

To view the details of a hold request:

1. Search for the hold request in the **Hold Request** screen.

- In the **Search Results** section, click the link in the **Hold Request Information** column corresponding to the hold request whose details you want to view.

The **Hold Request** screen appears. It consists of the following tabs:

- Main** – Displays information about the hold request. It contains the following zones:
 - Hold Request** – Displays the details of the hold request.
 - Hold Entities** – Lists the entities, such as person, accounts, or bills that are on hold request.
 - Search Account** – Searches the accounts to be put on hold.

Note: This zone appears when hold request is for **Account** and its status is **Draft**.

- Search Bill** – Searches the bills to be put on hold.

Note: This zone appears when hold request is for **Bill** and its status is **Draft**.

- Search Person** – Searches the persons to be put on hold.

Note: This zone appears when hold request is for **Person** and its status is **Draft**.

- Log** – Lists the complete trail of actions performed on the hold request.

- View the details of the hold request in the **Hold Request** zone.
- View the hold request entities (such as person, accounts, or bills) in the **Hold Entities** zone.

Related Topics

For more information on...	See...
Hold Request screen	Hold Request (Used for Searching) on page 1713
Hold Request zone	Hold Request on page 1721
How to search for a hold request	Searching for a Hold Request on page 1716

Hold Request (Used for Viewing)

Once you create a hold request, the **Hold Request** screen allows you to:

- Add entities in a hold request
- Add processes in a hold request
- Edit the details of a hold request
- Edit the hold amount against each entity. This is valid for only bill.
- Delete a hold request
- View the details of a hold request
- Submit a hold request for approval
- Approve or reject a hold request
- Resubmit a hold request for approval
- Activate and Release a hold request
- Search for an account, bill, and person in a hold request
- Edit the end dates of all the entities in a hold request

- Delete all the entities in a hold request
- View the log of a hold request
- Add a log entry for a hold request

This screen consists of the following tabs:

- **Main** – Displays information about the hold request. It contains the following zones:
 - **Hold Request** – Displays the details of the hold request.
 - **Hold Entities** – Lists the entities, such as person, accounts, or bills that are on hold request.
 - **Search Account** – Searches the accounts to be put on hold.

Note: This zone appears when hold request is for an **Account** and its status is **Draft**.

- **Search Bill** – Searches the bills to be put on hold.

Note: This zone appears when hold request is for **Bill** and its status is **Draft**.

- **Search Person** – Searches the persons to be put on hold.

Note: This zone appears when hold request is for **Person** and its status is **Draft**.

- **Log** – Lists complete trail of actions performed on the hold request. This tab contains the following zone:
 - **Hold Request Log** – Displays the actions performed on the hold request.

Hold Request - Main

The **Main** tab on the **Hold Request** contains the following zones:

- [Hold Request](#) on page 1721
- [Hold Entities](#) on page 1723
- [Search Account](#) on page 1725

Note: This zone appears when the hold request for an **Account** is in the **Draft** status.

- [Search Bill](#) on page 1729

Note: This zone appears when hold request for a **Bill** is in the **Draft** status.

- [Search Person](#) on page 1731

Note: This zone appears when hold request is for a **Person** is in the **Draft** status.

Hold Request

The **Hold Request** zone displays the details of the hold request. This zone contains the following sections:

- **Main** - This section provides basic information about the hold request. It contains the following fields:

Field Name	Field Description
Hold Request Information	Displays information about the hold request.
Hold Request Type	Indicates the hold request type using which the hold request is created.
	Note: It has a link. On clicking the link, the Hold Request Type screen appears where you can view the details of the hold request type.

Field Name	Field Description
Status	Indicates the status of the hold request.
Status Reason	Indicates the reason why the hold request is rejected or released. Note: This field appears when the hold request is in Rejected or Released status. It has a link. On clicking the link, the Status Reason screen appears where you can view the details of the respective status reason.
Start Date	Displays the date from when the hold request is effective.
End Date	Displays the date till when the hold request is effective.
Hold Reason	Indicates the reason for creating the hold request.
Entity	Indicates the entity for which the hold request is created.
Comments	Displays additional information about the hold request. Note: This field appears if comments are provided while defining or editing a hold request.

- **Hold Processes** - Lists the processes which are kept on hold in the hold request. It contains the following columns:

Column Name	Column Description
Hold Process	Indicates the process which is kept on hold.
Start Date	Displays the date from when the hold process is effective.
End Date	Displays the date till when the hold process is effective.

- **Record Actions** - This section contains the following buttons:

Button Name	Button Description
Edit	Used to edit the details of the hold request. Note: The Edit button appears when the hold request is in the Draft or Active status.
Delete	Used to delete the hold request. Note: The Delete button appears when the hold request is in the Draft status.
Submit	Used to activate the hold request. Note: The Submit button appears when the hold request is in the Draft status.
Re Submit	Used to re-submit the hold request. Note: The Re Submit button appears when the hold request is in the Approval In Progress status.
Approve	Used to approve the hold request.

Button Name	Button Description
	Note: The Approve button appears when the hold request is in the Approval In Progress status.
Reject	Used to reject the hold request. Note: The Reject button appears when the hold request is in the Approval In Progress status.
Release	Used to release the hold request. Note: The Release button appears when the hold request is in the Active status.

- **Record Information** - This section contains the following fields:

Field Name	Field Description
Business Object	Indicates the business object using which the hold request is created. In addition, a context menu appears corresponding to this field which helps in navigating to other screens in the application. Note: It has a link. On clicking the link, the Business Object screen appears where you can view the details of the respective business object.
Status Date/Time	Displays the date and time when the hold request status is updated.
Create Date/Time	Displays the date and time when the hold request is created.

- **Characteristics** - Lists the characteristics defined for the hold request. It contains the following columns:

Column Name	Column Description
Effective Date	Indicates the date from when the characteristic is effective.
Characteristic Type	Indicates the characteristic type.
Characteristic Value	Displays the value of the characteristic type.

Hold Entities

The **Hold Entities** zone lists the entities which are added to the hold request. It contains the following columns:

Column Name	Column Description
Person Information	Indicates information about the person who is added to the hold request. In addition, this column has a context menu which helps in navigating to other screens in the application. Note: It has a link. On clicking the link, the Person screen appears where you can view the details of the respective person.
Account Information	Indicates information about the account which is added to the hold request. In addition, this column has a context menu which helps in navigating to other screens in the application. Note: It has a link. On clicking the link, the Account screen appears where you can view the details of the respective account.

Column Name	Column Description
Bill Information	Indicates information about the bill which is added to the hold request. In addition, this column has a context menu which helps in navigating to other screens in the application. Note: It has a link. On clicking the link, the Bill screen appears where you can view the details of the respective bill.
Entity ID	Indicates the entity for which the hold request is created.
Start Date	Displays the date from when the entity is effective for the hold request.
End Date	Displays the date till when the entity is effective for the hold request. Note: When the status of the hold request is changed to released, the system updates the end date with the date when the hold request is released, ensuring that the new date resides within the start and end date of the hold request.
Hold Amount	Displays the amount of the bill which is kept on hold through a hold request. Note: This column appears only when Bill is defined as an entity.
Bill After Date	Displays the date after which bills can be generated. Note: This column appears only when Account is defined as an entity.
Postpone Credit Review Until	Displays the date till when overdue process is to be on hold. Note: This column appears only when Account is defined as an entity.
Defer Auto Pay Date	Displays the date from when auto pay process is to be put on deferred mode. Note: This column appears only when Account is defined as an entity.
Hierarchy	Indicates whether the entity is associated with the entity hierarchy relationship. Note: This column appears only when Person is defined as an entity.

In addition to above columns, this screen contains following buttons:

Button Name	Button Description
Edit	Used to edit the end date of hold entities.
Delete	Used to delete the hold entities.

Note:

A check box appears corresponding to each hold entity. To update the end date of a hold entity, select the check box corresponding to the hold entity and click the **Edit** button. You can also select multiple hold entities at the same time. In addition, you can select the check box corresponding to the column header. This allows you to update the end date of all the hold entities listed in the respective page.

You can also edit all the hold entities by clicking the **Edit All** link available in the upper right corner of this zone.

To delete a hold entity, select the check box corresponding to the hold entity and click the **Delete** button. You can also select multiple hold entities at the same time. In addition, you can select the check box corresponding to the column header. This allows you to delete all the hold entities listed in the respective page.

Pagination is used to display limited number of records in this zone. You can use the navigation links, such as **Previous** and **Next** to navigate between pages.

You can filter the list using the **Entity ID** search criteria available in the **Filter** area. By default, the **Filter** area is hidden. You can view the **Filter** area by clicking the **Filters** (∨) icon in the upper right corner of this zone.

Related Topics

For more information on...	See...
How to edit the entities of the hold request	Editing Hold Request Entities on page 1742
Search Account	Search Account on page 1725
Search Bill	Search Bill on page 1729
Search Person	Search Person on page 1731

Search Account

The **Search Account** zone allows you to search for accounts using various search criteria. It also allows you to add the accounts in a hold request. It contains the following two sections:

- **Search Criteria** - This section contains the following fields:

Field Name	Field Description	Mandatory (Yes or No)
Search By	Used to indicate whether you want to search for an account using the account or policy details. The valid values are: <ul style="list-style-type: none"> • Account Details • Policy Details <p>Note: By default, the Account Details option is selected.</p>	Not applicable
Account ID	Used to search a particular account.	No

Field Name	Field Description	Mandatory (Yes or No)
	<p>Note:</p> <p>The Search (🔍) icon appears corresponding to the Account ID field. On clicking the Search icon, the Account Search window appears.</p> <p>On specifying the account, the description of the account appears corresponding to the Account ID field.</p> <p>This field appears when you select the Account Details option from the Search By list.</p>	
Division	<p>Used to search accounts which belong to a particular division.</p> <p>Note: This field appears when you select the Account Details option from the Search By list.</p>	No
Address Source	<p>Used to indicate the address source of the account.</p> <p>Note:</p> <p>The list includes only those values which are defined in the BILL_ADDR_SRCE_FLG lookup field.</p> <p>This field appears when you select the Account Details option from the Search By list.</p>	<p>Yes (Conditional)</p> <p>Note: This field is required if you are searching for accounts using the state, country, or postal as a search criteria.</p>
Bill Cycle	<p>Used to indicate the bill cycle of the account.</p> <p>Note: This field appears when you select the Account Details option from the Search By list.</p>	No
State	<p>Used to specify the state name.</p> <p>Note: This field appears when you either select the Account Details or Policy Details option from the Search By list.</p>	No
Customer Class	<p>Used to indicate the customer class to which the account belongs.</p> <p>Note: This field appears when you select the Account Details option from the Search By list.</p>	No
County	<p>Used to specify the county name.</p> <p>Note: This field appears when you either select the Account Details or Policy Details option from the Search By list.</p>	No
Postal	<p>Used to specify the postal or zip code.</p> <p>Note: This field appears when you either select the Account Details or Policy Details option from the Search By list.</p>	No

Field Name	Field Description	Mandatory (Yes or No)
Price Item	Used to search a particular price item.	No
	<p>Note:</p> <p>You can search for a price item by clicking the Search  icon corresponding to the field. On clicking the Search icon, the Price Item Search window appears.</p> <p>This field appears when you select the Policy Details option from the Search By list.</p>	
Policy Plan Number	Used to search accounts which belong to a particular policy plan number.	No
	<p>Note: This field appears when you select the Policy Details option from the Search By list.</p>	
Policy Type	Used to search accounts which belong to a particular policy type.	Yes (Conditional)
	<p>Note:</p> <p>The list includes only those policy types where the policy category is set to Fully-Insured Group, Fully-Insured Individual or Self-Funded.</p> <p>This field appears when you select the Policy Details option from the Search By list.</p>	<p>Note: This field is required if you are searching for accounts using the state, country, or postal as a search criteria.</p>
Source System	Used to search accounts which were created in a particular external system.	Yes (Conditional)
	<p>Note:</p> <p>The list includes only those values which are defined in the C1-SourceSystemLookup extendable lookup.</p> <p>This field appears when you select the Policy Details option from the Search By list.</p>	<p>Note: This field is required if you are searching for accounts using the state, country, or postal as a search criteria.</p>
Policy Number	Used to search accounts with a particular policy number.	No
	<p>Note: This field appears when you select the Policy Details option from the Search By list.</p>	
Start Date	Used to search accounts which are associated with the policies effective from a particular date.	No
	<p>Note: This field appears when you select the Policy Details option from the Search By list.</p>	
End Date	Used to search accounts which are associated with the policies effective till a particular date.	No

Field Name	Field Description	Mandatory (Yes or No)
	Note: This field appears when you select the Policy Details option from the Search By list.	
Status	Used to search accounts which are associated with a particular policy status. Note: This field appears when you select the Policy Details option from the Search By list.	No
Characteristic Type	Used to search accounts which are associated with the policies belonging to a particular characteristic type. Note: This field appears when you select the Policy Details option from the Search By list.	No

Note:

You must specify at least one search criterion while searching for an account. One more search criterion is required when you are searching for an account using the division and/or customer class. Similarly, one more search criterion is required when you are searching for an account (associated with the policies) using the policy type and/or source system.

ORMB search engine supports wildcard search, where you can substitute the percentage (%) symbol as a stand in for any word or letter in a search criteria. You can use the ‘%’ wildcard character in all input fields except the date and ID fields. The ‘%’ wildcard character is suffixed automatically at the end of the partial search criteria. Therefore, you may or may not specify the wildcard character at the end of the partial search criteria. However, you have to prefix the wildcard character manually wherever required.

- **Search Results** - On clicking the **Search** button, the search results appear based on the specified search criteria.

The **Search Results** section contains the following columns:

Column Name	Column Description
Account Information	Displays additional information about the account. In addition, this column has a context menu which helps in navigating to other screens in the application. Note: It has a link. On clicking the link, the Account screen appears where you can view the details of the respective account.
Country	Displays the country name.
State	Displays the state where the county is located.
County	Displays the county name.
Postal	Displays the postal or zip code.
Customer Class	Indicates the customer class to which the account belongs.
Division	Indicates the division to which the account belongs.
Entity ID	Displays the entity ID.

Note: Pagination is used to display limited number of records in the **Search Results** section. You can use the navigation links, such as **Previous** and **Next** to navigate between pages.

In addition, this section contains the following button:

Button Name	Button Description
Add	Used to add an account to the hold request.

A check box appears corresponding to each account. On selecting the check box, you can add the account to the hold request. You can also select multiple accounts at the same time. In addition, you can select the check box corresponding to the column header. This allows you to add all the accounts listed in the respective page to the hold request.

Related Topics

For more information on...	See...
How to search accounts	Searching Accounts on page 1734
How to view the log of a hold request	Viewing the Log of a Hold Request on page 1750

Search Bill

The **Search Bill** zone allows you to search for the bills using various search criteria. It also allows you to add the bills in a hold request. It contains the following two sections:

- **Search Criteria** - This section contains the following fields:

Field Name	Field Description	Mandatory (Yes or No)
Search By	Used to indicate whether you want to search for a bill using the bill details.	Not applicable
	Note: By default, the Bill Details option is selected.	
Bill ID	Used to search a particular bill.	No
	Note: The Search (🔍) icon appears corresponding to the Bill ID field. On clicking the Search icon, the Bill Search window appears. On specifying the bill, the description of the bill appears corresponding to the Bill ID field.	
Alternate Bill ID	Used to search a particular bill using the alternate bill ID.	No
Address Source	Used to indicate the address source of the bill.	Yes (Conditional)
	Note: The list includes only those values which are defined in the BILL_ADDR_SRCE_FLG lookup field.	
		Note: This field is required if you are searching for bills using the state, country, or postal as a search criteria.

Field Name	Field Description	Mandatory (Yes or No)
Bill Date From	Used to search bills which are created from a particular date onwards.	Yes (Conditional) Note: This field is required if you have specified the value in the To field.
	Note: By default, the current date appears in this field.	
State	Used to specify the state name.	No
To	Used to search bills which are created till a particular date.	Yes (Conditional) Note: This field is required if you have specified the value in the Bill Date From field.
	Note: By default, the current date appears in this field.	
County	Used to indicate the county name.	No
Show All Bills	Used to search all those bills where the bill amount is greater than or equal to zero.	No
	Note: If this field is not selected, the system displays only those bills where the amount is greater than zero.	
Postal	Used to indicate the postal or zip code.	No

Note:

You must specify at least one search criterion while searching for a bill.

ORMB search engine supports wildcard search, where you can substitute the percentage (%) symbol as a stand in for any word or letter in a search criteria. You can use the ‘%’ wildcard character in all input fields except the date and ID fields. The ‘%’ wildcard character is suffixed automatically at the end of the partial search criteria. Therefore, you may or may not specify the wildcard character at the end of the partial search criteria. However, you have to prefix the wildcard character manually wherever required.

- **Search Results** - On clicking the **Search** button, the search results appear based on the specified search criteria. The **Search Results** section contains the following columns:

Column Name	Column Description
Bill Information	Displays additional information about the bill. In addition, this column has a context menu which helps in navigating to other screens in the application.
	Note: It has a link. On clicking the link, the Bill screen appears where you can view the details of the respective bill.
Account Information	Displays additional information about the account. In addition, this column has a context menu which helps in navigating to other screens in the application.
	Note: It has a link. On clicking the link, the Account screen appears where you can view the details of the respective account.

Column Name	Column Description
Country	Displays the country name.
State	Displays the state where the county is located.
County	Displays the county name.
Postal	Displays the postal or zip code.
Entity ID	Displays the entity ID.

Note: Pagination is used to display limited number of records in the **Search Results** section. You can use the navigation links, such as **Previous** and **Next** to navigate between pages.

In addition, this section contains the following button:

Button Name	Button Description
Add	Used to add a bill to the hold request.

A check box appears corresponding to each bill. On selecting the check box, you can add the bill to the hold request. You can also select multiple accounts at the same time. In addition, you can select the check box corresponding to the column header. This allows you to add all the bills listed in the respective page to the hold request.

Related Topics

For more information on...	See...
How to search bills	Searching Bills on page 1734
How to view the log of a hold request	Viewing the Log of a Hold Request on page 1750

Search Person

The **Search Person** zone allows you to search for persons using various search criteria. It also allows you to add the persons in a hold request. It contains the following two sections:

- **Search Criteria** - This section contains the following fields:

Field Name	Field Description	Mandatory (Yes or No)
Search By	Used to indicate whether you want to search for a person using the person details.	Not applicable
	Note: By default, the Person Details option is selected.	
Person ID	Used to search a particular person.	No
	Note: The Search (🔍) icon appears corresponding to the Person ID field. On clicking the Search icon, the Person Search window appears. On specifying the person, the description of the person appears corresponding to the Person ID field.	
County	Used to indicate the county name.	No

Field Name	Field Description	Mandatory (Yes or No)
State	Used to indicate the state name.	No
Postal	Used to indicate the postal or zip code.	No

Note:

You must specify at least one search criterion while searching for a person.

ORMB search engine supports wildcard search, where you can substitute the percentage (%) symbol as a stand in for any word or letter in a search criteria. You can use the '%' wildcard character in all input fields except the date and ID fields. The '%' wildcard character is suffixed automatically at the end of the partial search criteria. Therefore, you may or may not specify the wildcard character at the end of the partial search criteria. However, you have to prefix the wildcard character manually wherever required.

- **Search Results** - On clicking the **Search** button, the search results appear based on the specified search criteria. The **Search Results** section contains the following columns:

Column Name	Column Description
Person Information	Displays additional information about the person. In addition, this column has a context menu which helps in navigating to other screens in the application. Note: It has a link. On clicking the link, the Person screen appears where you can view the details of the respective person.
Person Identifier Type	Displays the identifier type associated with the person.
Person Identifier	Displays the value of the person identifier type.
Country	Displays the country name.
State	Displays the state where the county is located.
County	Displays the county name.
Postal	Displays the postal or zip code.
Entity ID	Displays the entity ID.

Note: Pagination is used to display limited number of records in the **Search Results** section. You can use the navigation links, such as **Previous** and **Next** to navigate between pages.

In addition, this section contains the following button:

Button Name	Button Description
Add	Used to add a person to the hold request.

A check box appears corresponding to each person. On selecting the check box, you can add the person to the hold request. You can also select multiple accounts at the same time. In addition, you can select the check box corresponding to the column header. This allows you to add all the persons listed in the respective page to the hold request.

Related Topics

For more information on...	See...
How to search persons	Searching Persons on page 1733
How to view the log of a hold request	Viewing the Log of a Hold Request on page 1750

Hold Request - Log

The **Log** tab on the **Hold Request** screen contains the following zone:

- [Hold Request Log](#) on page 1733

Hold Request Log

The **Hold Request Log** zone on the **Hold Request** screen lists the complete trail of actions performed on the hold request. This zone contains the following columns:

Column Name	Column Description
Date/Time	Displays the date and time when the action was performed on the hold request.
Details	Displays the details about the action performed on the hold request.
User	Indicates the user who has performed the action on the hold request.
Log Type	Indicates the type of log.
Related Object	Indicates the object or entity which is generated when the action is performed on the hold request.
Status Reason	Displays the status reason of action performed on the hold request.

Note: You can manually add a log entry for the hold request by clicking the **Add Log Entry** link in the upper right corner of the **Hold Request Log** zone.

The **Add Hold Request Log** window appears. Enter **Log Details** and click **Save**. The hold request log is added.

Related Topics

For more information on...	See...
How to view the log of a hold request	Viewing the Log of a Hold Request on page 1750

Searching Persons

Prerequisites

To search persons, you should have:

- Persons created in the application

Procedure

To search for persons:

1. Search the hold requests for **Persons** that are having **Draft** status.
2. In the **Search Results** section, click the link in the **Hold Request Information** column corresponding to the hold request whose details you want to search.

The **Hold Request** screen appears.

3. Enter the search criteria in the **Search Person** zone.

4. Click **Search**.

A list of persons that meet the search criteria appears in the **Search Results** section.

Related Topics

For more information on...	See...
Hold Request Screen	Hold Request (Used for Viewing) on page 1720
Hold Request Zone	Hold Request on page 1721
Adding Persons in a Hold Request	Adding Persons in a Hold Request on page 1735

Searching Accounts

Prerequisites

To search accounts, you should have:

- Accounts created in the application

Procedure

To search for accounts:

1. Search the hold requests for **Account** that are having **Draft** status.
2. In the **Search Results** section, click the link in the **Hold Request Information** column corresponding to the *hold* request whose details you want to search.

The **Hold Request** screen appears.

3. Enter the search criteria in the **Search Account** zone.
4. Click **Search**.

A list of accounts that meet the search criteria appears in the **Search Results** section.

Related Topics

For more information on...	See...
Hold Request Screen	Hold Request (Used for Viewing) on page 1720
Hold Request Zone	Hold Request on page 1721
Adding Accounts in a Hold Request	Adding Accounts in a Hold Request on page 1735

Searching Bills

Prerequisites

To search bills, you should have:

- Bills generated in the application

Procedure

To search for bills:

1. Search the hold requests for **Bill** that are having **Draft** status.

2. In the **Search Results** section, click the link in the **Hold Request Information** column corresponding to the *hold request* whose details you want to search.

The **Hold Request** screen appears.

3. Enter the search criteria in the **Search Bill** zone.
4. Click **Search**.

A list of bills that meet the search criteria appears in the **Search Results** section.

Related Topics

For more information on...	See...
Hold Request Screen	Hold Request (Used for Viewing) on page 1720
Hold Request Zone	Hold Request on page 1721
Adding Bills in a Hold Request	Adding Bills in a Hold Request on page 1736

Adding Persons in a Hold Request

Procedure

To add persons in a hold request:

1. Search for the hold request in the **Hold Request** screen which are having **Person** as a hold entity and **Draft as** status.
2. In the **Search Results** section, click the link in the **Hold Request Information** column corresponding to the *hold request* whose details you want to view.

The **Hold Request** screen appears.

3. Ensure the **Search Person** zone is expanded.
4. Enter the search criteria in the **Search Person** zone.

In the **Search Results** section, list of persons meeting the search criteria are displayed.

5. Select the persons which you want to add in the hold request and then click the **Add** button available in the upper left corner.

Selected persons are added in the hold request.

Related Topics

For more information on...	See...
How to search for a hold request	Searching for a Hold Request on page 1716
How to create a hold request	Creating a Hold Request on page 1717
Search Person zone	Search Person on page 1731
How to search for persons in a Hold Request Screen	Searching Persons on page 1733

Adding Accounts in a Hold Request

Procedure

To add accounts in a hold request:

1. Search for the hold request in the **Hold Request** screen which are having **Account** as a hold entity and **Draft as** status.
2. In the **Search Results** section, click the link in the **Hold Request Information** column corresponding to the hold request whose details you want to view.

The **Hold Request** screen appears.

3. Ensure the **Search Account** zone is expanded.
4. Enter the search criteria in the **Search Account** zone.

In the **Search Results** section, list of accounts meeting the search criteria are displayed.

5. Select the accounts which you want to add in the hold request and then click the **Add** button available in the upper left corner.

Selected accounts are added in the hold request.

Related Topics

For more information on...	See...
How to search for a hold request	Searching for a Hold Request on page 1716
How to create a hold request	Creating a Hold Request on page 1717
Search Account Zone	Search Account on page 1725
How to search for accounts in a hold request	Searching Accounts on page 1734

Adding Bills in a Hold Request**Procedure**

To add bills in a hold request:

1. Search for the hold request in the **Hold Request** screen which are having **Bill** as a hold entity and **Draft** as status.
2. In the **Search Results** section, click the link in the **Hold Request Information** column corresponding to the hold request whose details you want to view.

The **Hold Request** screen appears.

3. Ensure the **Search Bill** zone is expanded.
4. Enter the search criteria in the **Search Bill** zone.

In the **Search Results** section, list of bills meeting the search criteria are displayed.

5. Select the bills which you want to add in the hold request and then click the **Add** button available in the upper left corner.

Selected bills are added in the hold request.

Related Topics

For more information on...	See...
How to search for a hold request	Searching for a Hold Request on page 1716

For more information on...	See...
How to create a hold request	Creating a Hold Request on page 1717
Search Bill Zone	Search Bill on page 1729
How to search for bills in a hold request	Searching Bills on page 1734

Defining an Entity for a Hold Request

Prerequisites

To define an entity for a hold request, you should have:

- Values defined for the values **HOLD_ENTITY_LVL_FLG** flag.

Procedure

To define an entity for a hold request:

1. Ensure that the **Hold Entities** section is expanded when you are defining or editing the hold request.

The **Hold Entities** section contains the following columns in a grid:

Field Name	Field Description	Mandatory (Yes or No)
Hold Entity ID	Used to specify the hold entity ID. Note: You can search for an entity ID by clicking the search (🔍) icon corresponding to the field <ul style="list-style-type: none"> • If the hold entity is selected as an account, you must specify the account ID in this field. • If the hold entity is selected as bill, you must specify the bill ID in this field. • If the hold entity is selected as person, you must specify the person ID in this field 	Yes
Start Date	Used to specify the date from when you want to hold the entity. Note: By default, system date appears in this field The hold entity start date must be between the hold request start and end dates and between at least one process's start and end dates. The hold entity start date cannot be later than the hold entity end date.	Yes
End Date	Used to specify the date till when you want to hold the entity.	No

Field Name	Field Description	Mandatory (Yes or No)
	<p>Note:</p> <p>The hold entity end date must be between hold request start and end dates and between the process's start and end dates.</p> <p>The hold entity end date cannot be earlier than the hold entity start date.</p>	
Hold Amount	<p>Displays the amount which is kept on hold.</p> <p>Note: This column appears when the hold entity is Bill.</p>	Not applicable
Hierarchy	<p>Used to associate the hold entity with the entity hierarchy relationship.</p> <p>Note: This field appears only when you select the Person option from the Entity list.</p>	No

- Enter the required details in the **Hold Entities** section.
- If you want to define more than one entity for the hold request, click the **Add (+)** icon and then repeat step 2.

Note: However, if you want to remove an entity from the hold request, click the **Delete (🗑)** icon corresponding to the hold entity.

Related Topics

For more information on...	See...
How to search for a hold request	Searching for a Hold Request on page 1716
How to create a hold request	Creating a Hold Request on page 1717

Defining a Process for a Hold Request

Prerequisites

To define a process for a hold request, you should have:

- Values defined for the values **HOLD_PROCESS_FLG** flag.

Procedure

To define a process for a hold request:

- Ensure that the **Hold Process** section is expanded when you are defining or editing the hold request.

The **Hold Process** section contains the following columns in a grid:

Field Name	Field Description	Mandatory (Yes or No)
Hold Process	Used to indicate the process which you want to keep on hold.	Yes
Start Date	Used to specify the date from when the process is kept on hold.	Yes

Field Name	Field Description	Mandatory (Yes or No)
	<p>Note:</p> <p>By default, system date appears in this field</p> <p>The hold process start date must be between the hold request start and end dates.</p>	
End Date	Used to specify the date till when the process is kept on hold.	No

- Enter the required details in the **Hold Processes** section.
- If you want to define more than one process for the hold request, click the **Add (+)** icon and then repeat step 2.

Note: However, if you want to remove a process from the hold request, click the **Delete** (🗑️) icon corresponding to the hold process.

Related Topics

For more information on...	See...
How to search for a hold request	Searching for a Hold Request on page 1716
How to create a hold request	Creating a Hold Request on page 1717

Defining a Characteristic for a Hold Request

Prerequisites

To define a characteristic for a hold request, you should have:

- Characteristic types defined in the application (where the characteristic entity is set to **Hold Request**)

Procedure

To define a characteristic for a hold request:

- Ensure that the **Characteristics** section is expanded when you are defining or editing the hold request.

The **Characteristics** section contains the following columns in a grid:

Field Name	Field Description	Mandatory (Yes or No)
Effective Date	Used to specify the date from when the characteristic is effective for the hold request.	Yes (Conditional)
		Note: This field is required when you are defining a characteristic for the hold request.
Characteristic Type	Used to indicate the characteristic type.	Yes (Conditional)
	Note: The list includes only those characteristic types where the characteristic entity is set to Hold Request .	Note: This field is required when you are defining a characteristic for the hold request.

Field Name	Field Description	Mandatory (Yes or No)
Characteristic Value	Used to specify the value for the characteristic type.	Yes (Conditional)
	Note: On specifying the value for a predefined characteristic type, the description of the characteristic value appears corresponding to the Characteristic Value field.	Note: This field is required when you are defining a characteristic for the hold request.

- Enter the required details in the **Characteristics** section.

Note: If you select a predefined characteristic type, the **Search** (🔍) icon appears corresponding to the **Characteristic Value** field. On clicking the **Search** icon, you can search for a predefined characteristic value.

- If you want to define more than one characteristic for the hold request, click the **Add** (+) icon and then repeat step 5.

Note: However, if you want to remove a characteristic from the hold request, click the **Delete** (🗑️) icon corresponding to the characteristic.

Related Topics

For more information on...	See...
How to search for a hold request	Searching for a Hold Request on page 1716
How to create a hold request	Creating a Hold Request on page 1717

Editing a Hold Request

Procedure

To edit a hold request:

- Search for the hold request in the **Hold Request** screen.
- In the **Search Results** section, click the link in the **Hold Request Information** column corresponding to the hold request whose details you want to edit.
The **Hold Request** screen appears.
- Click the **Edit** button in the **Hold Request** zone.

Note: The **Edit** button appears when the hold request is in the **Draft** or **Active** status.

The **Hold Request** screen appears. It contains the following sections:

- Main** — Used to specify basic details about the hold request. This section contains the following fields:

Field Name	Field Description	Mandatory (Yes or No)
Hold Request Information	Displays information about the hold request.	Not applicable
Hold Request Type	Displays the hold request type using which the hold request is created.	Not applicable
Start Date	Used to specify the date till when you want to hold the entity.	Yes

Field Name	Field Description	Mandatory (Yes or No)
	<p>Note:</p> <p>The hold entity end date must be between hold request start and end dates and between the process's start and end dates.</p> <p>The hold entity end date cannot be earlier than the hold entity start date.</p>	
End Date	<p>Used to specify the date till when the hold request is effective.</p> <p>Note: The hold request end date cannot be earlier than the hold request start date.</p>	Yes
Hold Reason	<p>Used to indicate the reason why you want to hold the entity.</p> <p>Note: The hold reason must exist in the HOLD_REASON_FLG lookup field and its status must be Active.</p>	<p>Yes</p> <p>Note: This field cannot be edited if hold request is in Active status.</p>
Entity	Displays the hold entity.	Not applicable
Comments	Used to specify the additional information about hold request.	No

- **Hold Processes** — Used to specify the processes on hold in the hold request. This section contains the following fields:

Field Name	Field Description	Mandatory (Yes or No)
Hold Process	Used to indicate the process that needs to be kept on hold.	Yes
Start Date	<p>Used to specify the date from when process is to be on hold for the hold request.</p> <p>Note:</p> <p>This field is not editable when hold request is in Active status.</p> <p>The hold process start date must be between the hold request start and end dates.</p>	Yes
End Date	Used to specify the date till when the hold process is to be on hold.	No

- **Characteristics** — Used to define the characteristics for the hold request. This section contains the following fields:

Field Name	Field Description	Mandatory (Yes or No)
Effective Date	Used to specify the date from when the characteristic is effective for the hold request.	Yes (Conditional)
		Note: This field is required when you are defining a characteristic for the hold request.
Characteristic Type	Used to indicate the characteristic type. Note: The list includes only those characteristic types where the characteristic entity is set to Hold Request .	Yes (Conditional)
		Note: This field is required when you are defining a characteristic for the hold request.
Characteristic Value	Used to specify the value for the characteristic type. Note: On specifying the value for a predefined characteristic type, the description of the characteristic value appears corresponding to the Characteristic Value field.	Yes (Conditional)
		Note: This field is required when you are defining a characteristic for the hold request.

- Modify the details of the hold request, if required.

Note:

If you want to specify more than one hold processes, click the **Add** (+) icon corresponding to the process and then specify the details.

However, if you want to remove a hold process from the hold request, click the **Delete** (🗑️) icon corresponding to the process.

- Define, edit, or remove characteristics of the hold request, if required.
- Click **Save**.

The changes made to the hold request are saved.

Related Topics

For more information on...	See...
How to search for a hold request	Searching for a Hold Request on page 1716
Hold Request screen	Hold Request (Used for Searching) on page 1713
Hold Request zone	Hold Request on page 1721
How to define a characteristic for a hold request	Defining a Characteristic for a Hold Request on page 1739

Editing Hold Request Entities

Procedure

To edit a hold request entities:

1. Search for the hold request in the **Hold Request** screen.
2. In the **Search Results** section, click the link in the **Hold Request Information** column corresponding to the hold request whose details you want to edit.

The **Hold Request** screen appears.

3. Select the entities that you want to edit in the **Hold Entities** zone and click the **Edit** button available in the upper left corner.

Note: The **Edit** button appears when the hold request is in the **Draft** or **Active** status.

The **Edit Hold Request Entities** screen appears. It contains the following fields:

Field Name	Field Description	Mandatory (Yes or No)
Hold Request Information	Displays information about hold request.	Not applicable
Start Date	Displays the start date of hold request.	Not applicable
End Date	Displays the end date of hold request.	Not applicable

It also contains the following columns:

Column Name	Column Description	Mandatory (Yes or No)
Entity ID	Displays the entity ID.	Not applicable
Entity Information	Displays the information about the entity.	Not applicable
Start Date	Used to indicate the date from when the entity is on hold.	Yes
	Note: This field is not editable when hold request is in Active status.	
End Date	Used to indicate the date till when the entity is on hold.	No
Hold Amount	Used to indicate the hold amount for bill.	Yes
	Note: This field appears only hold request is for bill.	

4. Modify the details of the hold entities, if required.
5. Click **Save**.

The changes made to the hold entities are saved.

Related Topics

For more information on...	See...
How to search for a hold request	Searching for a Hold Request on page 1716
Hold Request screen	Hold Request (Used for Searching) on page 1713
Hold Request zone	Hold Request on page 1721

For more information on...	See...
How to define a characteristic for a hold request	Defining a Characteristic for a Hold Request on page 1739

Deleting Hold Request Entities

Procedure

To delete hold request entities:

1. Search for the hold request in the **Hold Request** screen.
2. In the **Search Results** section, click the link in the **Hold Request Information** column corresponding to the hold request whose details you want to delete.

The **Hold Request** screen appears.

3. Select the entities to delete in the **Hold Entities** zone and click the **Delete** button available in the upper left corner.

A message appears confirming whether you want to delete the hold entity.

Note:

The **Delete** button appears when the hold request is in the **Draft** or **Active** status.

4. Click **OK**.

The hold entities are deleted.

Note: No deletion is allowed on entities of hold requests which are in active status and are added from **Account Receivable Central** or **Delinquency Central**.

Related Topics

For more information on...	See...
How to search for a hold request	Searching for a Hold Request on page 1716
Hold Request screen	Hold Request (Used for Searching) on page 1713
Hold Request zone	Hold Request on page 1721
How to define a characteristic for a hold request	Defining a Characteristic for a Hold Request on page 1739

Deleting a Hold Request

Procedure

To delete a hold request:

1. Search for the hold request in the **Hold Request** screen.
2. In the **Search Results** section, click the link in the **Hold Request Information** column corresponding to the hold request that you want to delete.

The **Hold Request** screen appears.

3. Click the **Delete** button in the **Hold Request** zone.

A message appears confirming whether you want to delete the hold request.

Note: The **Delete** button appears when the hold request is in the **Draft** status.

4. Click **OK**.

The hold request is deleted.

Note:

You can delete a hold request when its status is **Draft**.

Bills added from ARC cannot be deleted from the **Hold Request** screen.

Related Topics

For more information on...	See...
How to search for a hold request	Searching for a Hold Request on page 1716
Hold Request screen	Hold Request (Used for Searching) on page 1713
Hold Request zone	Hold Request on page 1721

Submitting a Hold Request

Prerequisites

To submit a hold request, you should have:

- Hold Request Types, Hold Processes and Hold Entities defined in the request.

Procedure

To submit a hold request:

1. Search for the hold request in the **Hold Request** screen.
2. In the **Search Results** section, click the link in the **Hold Request Information** column corresponding to the hold request that you want to submit.

The **Hold Request** screen appears.

3. Click the **Submit** button in the **Hold Request** zone.

The system behaves in the following manner:

If...	Then
The Approval Required check box is selected in the hold request type using which the hold request is created.	A To Do of the C1-HLDAP To Do type is created and sent to the approver and the status of the hold request is changed to Approval In Progress .
The Approval Required check box is not selected in the hold request type using which the hold request is created.	The hold request is created using the specified hold request types and the status of the hold request is changed to Active or Deferred Processing as specified in the hold request type.

Note:

The **Submit** button appears when the hold request is in the **Draft** status.

Once the request is activated, the **Release** button appears in the **Record Actions** section.

If hold request start date is in past and its status is draft then, on activation of the hold request, the start date is changed to the system date.

For Active hold request, **C1-DELBI** batch will delete all pending bill segments and bills under account for bill generation process.

For more information about the **Delete Pending Bill segments and Bills (C1-DELBI) batch**, refer to Oracle Revenue Management and Billing Batch Guide.

Related Topics

For more information on...	See...
How to search for a hold request	Searching for a Hold Request on page 1716
Hold Request screen	Hold Request (Used for Searching) on page 1713
Hold Request zone	Hold Request on page 1721

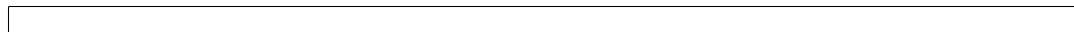
**Approving a Hold Request**

You can view the number of hold requests which are pending for approval in the **Hold Request** screen. The approver can review, and accordingly approve, reject or resubmit the hold request based on the observations.

Note: The system will not allow you to approve, reject or resubmit a hold request submitted by you.

Procedure

To approve a hold request:

1. Do either of the following:

If you want to...	Then...
Approve a hold request through the Hold Request screen	<ol style="list-style-type: none"> 1. Search for the hold request in the Hold Request screen. 2. In the Search Results section, click the link in the Hold Request Information column corresponding to the hold request which you want to review.
Approve a hold request from the To Do List screen	<ol style="list-style-type: none"> 1. Click the Menu link in the Application toolbar. A list appears. 2. From the Main menu, select To Do and then click To Do List. The To Do Type for User Search window appears.

If you want to...	Then...
	<ol style="list-style-type: none"> 3. Enter C1-HLDAP in the To Do Type field. 4. Click the Search button corresponding to the To Do Type field. The To Do List screen appears. 5. Select the Open option from the Filter by list to view all unassigned To Dos. 6. Click the link in the Message column corresponding to the To Do of the hold request that you want to review.

The **Hold Request** screen appears.

2. Review the hold request details.
3. Click the **Approve** button in the **Hold Request** zone.

The system behaves in the following manner:

If you are...	Then...
Approving a Hold request	The status of the hold request is changed to Active or Deferred Processing as specified in the hold request type.

Note:

The **Approve** button appears when the hold request is in the **Approval In Progress** status.

You can also resubmit the hold request if any changes are required in the hold request. Upon clicking the **Resubmit** button, provide the comments to make the required changes for the hold request.

Related Topics

For more information on...	See...
Hold Request screen	Hold Request (Used for Searching) on page 1713
Hold Request zone	Hold Request on page 1721
How to search for a hold request	Searching for a Hold Request on page 1716

Releasing a Hold Request

Procedure

To release a hold request:

1. Search for the hold request in the **Hold Request** screen.
2. In the **Search Results** section, click the link in the **Hold Request Information** column corresponding to the hold request whose details you want to edit.

The **Hold Request** screen appears.

- Click the **Release** button in the **Hold Request** zone.

The **Release Reason** window appears. It contains the following fields:

Field Name	Field Description	Mandatory (Yes or No)
Release Reason	Used to indicate the reason for releasing the hold request.	Yes
Comments	Used to specify the additional comments for the release reason	No

- Ensure the required release reason.
- click **Save**.

The hold request is released.

Note:

The **Release** button appears only when the hold request is in the **Active** status.

Once the hold request is in **Released** status, the **End Date** of processes and entities gets updated.

Related Topics

For more information on...	See...
How to search for a hold request	Searching for a Hold Request on page 1716
How to create a hold request	Creating a Hold Request on page 1717

Rejecting a Hold Request

Prerequisites

To reject a hold request, you should have:

- Rejection reasons defined in the application

Note:

While rejecting a hold request, you need to specify the reason why you want to reject the hold request. You can select the appropriate rejection reason when you have defined the reasons for the **Rejected** status of the **C1-HoldRequest** business object in the **Status Reason** screen.

The system will not allow you to approve, reject or resubmit a hold request submitted by you.

Procedure

To reject a hold request:

- Do either of the following:

If you want to	Then
Reject a hold request through the Hold Request screen	<ol style="list-style-type: none"> Search for the hold request in the Hold Request screen. In the Search Results section, click the link in the Hold Request Information column

If you want to	Then
	corresponding to the hold request which you want to review.
Reject a hold request from the To Do List screen	<ol style="list-style-type: none"> 1. Click the Menu link in the Application toolbar. A list appears. 2. From the Main menu, select To Do and then click To Do List. The To Do Type for User Search window appears. 3. Enter C1-HLDAP in the To Do Type field. 4. Click the Search button corresponding to the To Do Type field. The To Do List screen appears. 5. Select the Open option from the Filter by list to view all unassigned To Dos. 6. Click the link in the Message column corresponding to the To Do of the hold request that you want to review.

The **Hold Request** screen appears.

2. Review the hold request details.
3. Click the **Reject** button in the **Hold Request** zone.

The **Reject Hold Request** window appears. It contains following fields:

Field Name	Field Description	Mandatory (Yes or No)
Status Reason	Used to indicate the reason why you want to reject the hold request.	Yes
Comments	Used to specify additional information while rejecting the hold request.	No

Note: The **Reject** button appears when:

- The hold request is in the **Approval In Progress** status.
- A user with the approval To Do role is reviewing the hold request.

4. Select the rejection reason from the **Status Reason** list.
5. Click **Save**.

The status of the hold request is changed to **Rejected**.

Related Topics

For more information on...	See...
How to search for a hold request	Searching for a Hold Request on page 1716

For more information on...	See...
Hold Request screen	Hold Request (Used for Searching) on page 1713
Hold Request zone	Hold Request on page 1721

Resubmitting a Hold Request

Prerequisites

To resubmit a hold request, you should have:

- Entities added in the hold request which is submitted for approval.

While resubmitting, To Do will be sent to the submitter of the request using the submitter To Do Role mapped on the hold request type and the request will be moved to Draft status. The submitter can do necessary changes and re submit the request. Log will be maintained when the approver sends the request back to submitter.

Procedure

To resubmit a hold request:

1. Search for the hold request in the **Hold Request** screen.
2. In the **Search Results** section, click the link in the **Hold Request Information** column corresponding to the hold request that you want to resubmit.

The **Hold Request** screen appears.

3. Click the **Re Submit** button in the **Hold Request** zone.

The **Resubmit Hold Request** screen appears.

Note: The **Re Submit** button appears when the hold request is in the **Approval In Progress** status.

A To Do of the **C1-HOLSB** To Do type is created and sent to the request submitter using the submitter TO DO Role and the status of the hold request is changed to **Draft**.

4. Enter the comments in the respective field and click **Save**.

Related Topics

For more information on...	See...
How to search for a hold request	Searching for a Hold Request on page 1716
Hold Request screen	Hold Request (Used for Searching) on page 1713
Hold Request zone	Hold Request on page 1721
How to submit a hold request	Submitting a Hold Request on page 1745

Viewing the Log of a Hold Request

Procedure

To view the log of a hold request:

1. Search for the hold request in the **Hold Request** screen.

- In the **Search Results** section, click the link in the **Hold Request Information** column corresponding to the *hold* request whose log you want to view.

The **Hold Request** screen appears. It consists of the following tabs:

- Main** – Displays information about the hold request. It contains the following zones:

- Hold Request** – Displays the details of the hold request.
- Hold Entities** – Lists the hold entities records of the hold request.
- Search Account** – Searches the accounts to be put on hold.

Note: This zone appears when hold request is for **Account** and its status is **Draft**.

- Search Bill** – Searches the bills to be put on hold.

Note: This zone appears when hold request is for **Bill** and its status is **Draft**.

- Search Person** – Searches the persons to be put on hold.

Note: This zone appears when hold request is for **Person** and its status is **Draft**.

- Log** – Lists the complete trail of actions performed on the hold request. This tab contains the following zone:

- Hold Request Log** – Displays the trail of actions performed on the particular hold request.

- Click the **Log** tab.

The **Hold Request Log** zone in the **Log** tab contains the following columns:

Column Name	Column Description
Date/Time	Displays the date and time when the action was performed on the hold request.
Details	Displays the details about the action performed on the hold request.
User	Indicates the user who has performed the action on the hold request.
Log Type	Indicates the type of log.
Related Object	Indicates the object or entity which is generated when the action is performed on the hold request.
Status Reason	Indicates the reason why the hold request was rejected or voided.

Note: You can manually add a log entry for the hold request by clicking the **Add Log Entry** link in the upper right corner of the **Hold Request Log** zone.

Related Topics

For more information on...	See...
How to search for a hold request	Searching for a Hold Request on page 1716
How to add a log entry for a hold request	Adding a Log Entry for a Hold Request on page 1751

Adding a Log Entry for a Hold Request

Procedure

To add a log entry for a hold request:

1. Search for the hold request in the **Hold Request** screen.
2. In the **Search Results** section, click the link in the **Hold Request Information** column corresponding to the hold request whose log you want to edit.

The **Hold Request** screen appears. It consists of the following tabs:

- **Main** – Displays information about the hold request. It contains the following zones:

- **Hold Request** – Displays the details of the hold request.
- **Hold Entities** – Lists the hold entities records of the hold request.
- **Search Account** – Searches the accounts to be put on hold.

Note: This zone appears when hold request is for **Account** and its status is **Draft**.

- **Search Bill** – Searches the bills to be put on hold.

Note: This zone appears when hold request is for **Bill** and its status is **Draft**.

- **Search Person** – Searches the persons to be put on hold.

Note: This zone appears when hold request is for **Person** and its status is **Draft**.

- **Log** – Lists the complete trail of actions performed on the hold request. This tab contains the following zone:
 - **Hold Request Log** – Displays the trail of actions performed on the particular hold request.

3. Click the **Log** tab.

The **Log** tab appears.

4. Click the **Add Log Entry** link in the upper right corner of the **Hold Request Log** zone.

The **Add Hold Request Log** window appears. It contains the following fields:

Field Name	Field Description	Mandatory (Yes or No)
Hold Request Information	Displays information about the hold request.	Not applicable
Log Details	Used to specify additional comments for the hold request.	Yes

5. Enter the comments in the **Log Details** field.
6. Click **Save**.

The log entry is added in the **Hold Request Log** zone.

Related Topics

For more information on...	See...
How to search for a hold request	Searching for a Hold Request on page 1716

Chapter 26

Delinquency Central

Topics:

- [Prerequisites](#)
- [Delinquency Central \(Used for Viewing\)](#)
- [Overdue Process Information for Account: {Account ID}](#)

Oracle Revenue Management and Billing provides a complete overview of the overdue bills belonging to the delinquent accounts of a particular person using the **Delinquency Central**. User can review the overdue bills and perform following actions from the delinquency central:

- Initiate customer contact
- Initiate hold on overdue process
- Create payment arrangement for an account
- Create promise to pay for person's account

The Delinquency Central assists you in identifying all the overdue processes, overdue bills & delinquent accounts using an overdue monitoring process.

For more information on how to setup the delinquency central, see [Prerequisites](#) on page 1754.

Related Topics

For more information on...	See...
Delinquency Central screen	Delinquency Central (Used for Viewing) on page 1754
Overdue Process Information for Account: {Account ID}	Overdue Process Information for Account: {Account ID} on page 1761

Prerequisites

To setup delinquency central, you need to do the following:

- Define the required characteristic types where the characteristic entity is set to overdue event.
- Define the overdue event type and overdue process template in the system.
- Promise To Pay type defined in the application.
- Customer contact type defined in the application.
- Hold request type defined in the application.

Delinquency Central (Used for Viewing)

The **Delinquency Central** screen allows you to:

- Search for an overdue process
- View the details of an overdue process
- View the details of an overdue event
- Create customer contact
- Create a hold request for an overdue process
- Create a payment arrangement for an account
- Create a promise to pay for a person's account
- Create a payment agreement request for an account

This screen consists of the following zones:

- [Search Overdue Process](#) on page 1754
- [Overdue Events](#) on page 1759

Search Overdue Process

The **Search Overdue Process** zone allows you to search for overdue processes using various search criteria. This zone contains the following two sections:

- **Search Criteria** — The **Search Criteria** section contains the following fields:

Field Name	Field Description	Mandatory (Yes or No)
Search By	Used to indicate whether you want to search for overdue processes using person, account, bill or overdue process. The valid values are: <ul style="list-style-type: none"> • Person • Account • Bill • Overdue Process 	No
	Note: By default, the Person option is selected.	

Field Name	Field Description	Mandatory (Yes or No)
Person ID	Used to search for overdue processes which belong to a particular person.	No
	Note: This field appears when you select the Person option from the Search By list.	
Person Identifier Type	Used to search for overdue processes with a particular person identifier type.	Yes (Conditional)
	Note: This field appears when you select the Person option from the Search By list.	
Person Identifier	Used to search for overdue processes with a specific value of the person identifier type.	Yes
	Note: This field appears when you select the Person option from the Search By list.	
Account ID	Used to search for overdue processes created for a particular account.	No
	Note: This field appears when you select the Account option from the Search By list.	
Account Identifier Type	Used to search for overdue processes with a particular account identifier type.	Yes (Conditional)
	Note: This field appears when you select the Account option from the Search By list.	
Account Identifier	Used to search for overdue processes with a particular account identifier.	Yes
	Note: This field appears when you select the Account option from the Search By list.	
Bill ID	Used to search for overdue processes with a particular bill.	No
	Note: This field appears when you select the Bill option from the Search By list.	
Alternate Bill ID	Used to search for overdue processes using an alternate bill ID.	No
	Note: This field appears when you select the Bill option from the Search By list.	
Characteristic Type / Value	Used to search for overdue processes with a particular characteristic type and its value.	No

Field Name	Field Description	Mandatory (Yes or No)
	Note: This field appears when you select the Bill option from the Search By list.	
Overdue Process Template	Used to search for overdue processes with a particular overdue process template. Note: This field appears when you select the Overdue Process option from the Search By list.	No
Start Date	Used to search for overdue processes with a particular start date. Note: This field appears when you select the Overdue Process option from the Search By list.	Yes
End Date	Used to search overdue process with a particular end date. Note: This field appears when you select the Overdue Process option from the Search By list.	Yes
Status	Used to search for overdue processes with a particular status. The valid values are: <ul style="list-style-type: none"> • Active • Inactive Note: This field appears when you select the Overdue Process option from the Search By list.	No
On Hold	Used to search for overdue processes that are on hold. Note: This field appears when you select the Overdue Process option from the Search By list.	No
Overdue Amount From	Used to search for overdue processes with a particular lower limit of the overdue amount. Note: This field appears when you select the Overdue Process option from the Search By list.	No
To	Used to search for overdue processes with a particular higher limit of the overdue amount. Note: This field appears when you select the Overdue Process option from the Search By list.	No
Characteristic Type / Value	Used to search for overdue processes with a particular characteristic type and value. Note: This field appears when you select the Overdue Process option from the Search By list.	No

- In addition to above search parameters, the screen consists of following fields in the **Person Details** or **Account Details** section:

Column Name	Column Description
Main Customer	Displays the name of the main customer to whom the account belongs.
	Note: This field appears when you select the Account option from the Search By list.
Person Name	Displays the name of the person to whom the account belongs.
	Note: This field appears when you select the Person option from the Search By list.
Person Identifier Type	Displays the person identifier type.
	Note: This field appears when you select the Person or Account option from the Search By list.
Person Identifier	Displays the value of the person identifier type.
	Note: This field appears when you select the Person or Account option from the Search By list.
Account Identifier Type	Displays the account identifier type.
	Note: This field appears when you select the Account option from the Search By list.
Account Identifier	Displays the value of the account identifier type.
	Note: This field appears when you select the Account option from the Search By list.
Overdue	Displays whether the person account(s)/bill(s) are overdue. The valid values are: <ul style="list-style-type: none"> • Yes • No
	Note: This field appears when you select the Person or Account option from the Search By list.
Number of Active Overdue processes	Displays the number of overdue processes linked to the person's account that are in active status.
	Note: This field appears when you select the Person or Account option from the Search By list.
Number of Hold(s) on Account(s)	Displays the number of hold requests on the particular account.
Number of Overdue Bills	Displays the total number of bills that are overdue.
	Note: This field appears when you select the Person or Account option from the Search By list.

Column Name	Column Description
Total Overdue Amount	Displays the total overdue amount for an account.
Last Payment Date	Displays date of the last payment made by the person. Note: This field appears when you select the Person or Account option from the Search By list.
Last Payment Amount	Displays the amount last paid by the person. Note: This field appears when you select the Person or Account option from the Search By list.
Number Of Payment Arrangements	Displays the number of payment arrangements for the person's account. Note: This field appears when you select the Person or Account option from the Search By list.
Total Number of Overdue Process on Hold	Displays the total number of overdue process that are on hold. Note: This field appears when you select the Person or Account option from the Search By list.
Number of Promise To Pay	Displays the number of promise to pay belonging to the person. Note: This field appears when you select the Person or Account option from the Search By list.
Number of Broken Promise To Pay	Displays the total number of promise to pay that are broken. Note: This field appears when you select the Person or Account option from the Search By list.

- **Search Results** — On clicking the **Search** button, the search results appear based on the specified search criteria. The **Search Results** section contains the following columns:

Column Name	Column Description
Overdue Process	Display additional information about the overdue process. Note: It has a link. On clicking the link, the Overdue Process screen appears where you can view the details of the overdue process.
Overdue Process Template	Displays the template that was used to create overdue process's events.
Account Information	Display additional information about the account. In addition, this column has a context menu which helps in navigating to other screens in the application. Note: It has a link. On clicking the link, the Account screen appears with the details of the account.
Person Information	Display additional information about the person. In addition, this column has a context menu which helps in navigating to other screens in the application.

Column Name	Column Description
	Note: It has a link. On clicking the link, the Person screen appears with the details of the person.
Overdue Amount	Displays the overdue amount under that overdue process.
On Hold	Displays whether the overdue process is on hold.
Overdue Process Details	On clicking the View () icon, the Overdue Process Details screen appears where you can view details of the overdue process.

On clicking the **Broadcast** () icon corresponding to the overdue process, the **Overdue Events** zone appears with the details of the respective overdue process.

Related Topics

For more information on...	See...
Overdue Events screen	Overdue Events on page 1759
How to search for a bill	Searching for a Bill on page 1765
How to view events of an overdue process	Viewing Events of an Overdue Process on page 1760
How to view details of an overdue process	Viewing the Overdue Process Details on page 1760

Overdue Events

The **Overdue Events** zone displays the details of the events of the overdue process on the **Delinquency Central** screen.

Column Name	Column Description
Event	Displays information about the event of the overdue process.
Event Status	Displays the status of the event.
Dependency on Other Events	Displays whether the event is dependent on other events. The valid values are: <ul style="list-style-type: none"> • No • Yes
Trigger Date	Displays the trigger date of the event.

Related Topics

For more information on...	See...
Delinquency Central screen	Delinquency Central (Used for Viewing) on page 1754
How to view events of an overdue process	Viewing Events of an Overdue Process on page 1760

Searching for an Overdue Process

Prerequisites

To search for an overdue process, you should have:

- Overdue process defined in the application.

Procedure

To search for an overdue process:

1. Click the **Menu** link in the **Application** toolbar
2. From the **Main** menu, select **Delinquency Management** and then click **Delinquency Central**.
The **Delinquency Central** screen appears.
3. Enter the search criteria in the **Search Overdue Process** zone.

Note: ORMB search engine supports wildcard search, where you can substitute the percentage (%) symbol as a stand in for any word or letter in a search criteria. You can use the ‘%’ wildcard character in all input fields except the date and ID fields. The ‘%’ wildcard character is suffixed automatically at the end of the partial search criteria. Therefore, you may or may not specify the wildcard character at the end of the partial search criteria. However, you have to prefix the wildcard character manually wherever required.

4. Click **Search**.

A list of overdue processes that meet the search criteria appear in the **Search Results** section.

Related Topics

For more information on...	See...
Delinquency Central screen	Delinquency Central (Used for Viewing) on page 1754
Search Overdue Process zone	Search Overdue Process on page 1754

Viewing Events of an Overdue Process

Procedure

To view events of an overdue process:

1. Search for the overdue process in the **Delinquency Central** screen.
2. In the **Search Results** section, click the **Broadcast** (📡) icon corresponding to the overdue process whose event details you want to view.
The **Overdue Events** zone appears.
3. View the overdue event details of the overdue process in the **Overdue Events** zone.

Related Topics

For more information on...	See...
Delinquency Central screen	Delinquency Central (Used for Viewing) on page 1754
Overdue Events screen	Overdue Events on page 1759
How to search for an overdue process	Searching for an Overdue Process on page 1759

Viewing the Overdue Process Details

Procedure

To view the details of an overdue process:

1. Search for the overdue process in the **Delinquency Central** screen.

- In the **Search Results** section, click the link in the **Overdue Process Information** column corresponding to the overdue process whose details you want to view.

The **Overdue Process** screen appears. It consists of the following tabs:

- Main** – Displays the basic details of the overdue process.
- Events** – Displays the events details of the overdue process.
- Log** – Displays a complete trail of actions performed on the overdue process.
- Characteristics** – Displays the characteristics of the overdue process.

- View the event details of the overdue process in the **Overdue Process** screen.

Related Topics

For more information on...	See...
Delinquency Central screen	Delinquency Central (Used for Viewing) on page 1754
How to search for an overdue process	Searching for an Overdue Process on page 1759

Overdue Process Information for Account: {Account ID}

The **Overdue Process Information for Account: {Account ID}** screen allows you to view detail information of the account which is linked to the overdue process.

This screen consists of the following zones:

- [Person Information](#) on page 1761
- [Account Information](#) on page 1762
- [Customer Contact Details](#) on page 1762
- [Promise To Pay](#) on page 1762
- [Hold Details](#) on page 1763
- [Overdue Bills](#) on page 1763
- [Payment Arrangement](#) on page 1763
- [Search Bill](#) on page 1764
- [Searching for a Bill](#) on page 1765
- [Adding the Customer Contact Details](#) on page 1765
- [Creating a Hold Request for an Overdue Process](#) on page 1766
- [Creating a Payment Arrangement for an Overdue Process](#) on page 1767
- [Defining a Promise To Pay for an Overdue Process](#) on page 1767

Person Information

The **Person Information** zone displays details of the person whose account is linked to the overdue process. This zone contains following columns:

Column Name	Column Description
Person Name	Displays the name of the person whose account is linked to the overdue process.
Phone Number	Displays the phone number of the person.
Address	Displays the address of the person.

Account Information

The **Account Information** zone displays the details of the account that is linked with the overdue process. This zone contains following columns:

Column Name	Column Description
Account ID	Displays the account ID.
Account Identifier Type	Displays the account identifier type.
Account Identifier	Displays the value of the account identifier type.
Last Payment Date	Displays the date of the last payment made from the account that is linked with the overdue process.
Last Payment Amount	Displays the amount last paid from the account.

Customer Contact Details

The **Customer Contact Details** zone displays the contact details of the customer whose account is linked with the overdue process. This zone contains following columns:

Column Name	Column Description
Contact Date/Time	Displays the date and time when the customer was contacted.
Customer Contact Information	Displays additional information about the customer contact. Note: It has a link. On clicking the link, the Customer Contact screen appears where you can view the details of the respective customer contact.
Preferred Contact Method	Displays the preferred method of contacting the customer.
Comments	Displays the comments that are placed against each customer.

Promise To Pay

The **Promise To Pay** zone displays promise to pay created for an account which is linked to the overdue process. This zone contains following columns:

Column Name	Column Description
Promise To Pay Information	Displays additional information of promise to pay. Note: It has a link. On clicking the link, the Promise To Pay screen appears where you can view the details of promise to pay.
Scheduled Amount	Displays the amount to be paid on the Scheduled Date .
Scheduled Date	Displays the date when the payment is expected as per promise to pay.

Column Name	Column Description
Status	Displays the status of promise to pay.
Created By	Displays the user ID who has created the promise to pay.

Hold Details

The **Hold Details** zone displays the details of the person whose account is linked to the overdue process. This zone contains the following columns:

Column Name	Column Description
Hold Request Information	Displays additional information about the hold request. Note: It has a link. On clicking the link, the Hold Request screen appears where you can view the details of the hold request.
Status	Displays the status of the hold request.
Entity	Displays the hold request entity.
Entity Information	Displays the information about the entity on hold. Note: It has a link. On clicking the link, the Account, Bill or Person screen appears, where you can view details of the respective account, bill or person.
Start Date	Displays the date when the hold request is created.
End Date	Displays the end date of the hold request.

Overdue Bills

The **Overdue Bills** zone displays details of the overdue bills. This zone contains following columns:

Column Name	Column Description
Bill Information	Displays additional information about the bill. Note: It has a link. On clicking the link, the Bill screen appears where you can view the details of the respective bill.
Original Bill Amount	Displays the bill amount when the bill was generated.
Due Date	Displays the due date of the bill.
Overdue Amount	Displays the amount that is overdue in the bill.
Days Past Due	Displays the number of days past after the bill date.

Payment Arrangement

The **Payment Arrangement** zone displays the details of the payment arrangement that is created for an account linked to the overdue process. This zone contains following columns:

Column Name	Column Description
Contract Information	Displays the payment arrangement contract information . In addition, this column has a context menu which helps in navigating to other screens in the application.

Column Name	Column Description
	Note: It has a link. On clicking the link, the Contract screen appears where you can view the details of the respective contract.
Payoff Balance	Displays the total amount that is paid against the payment arrangement contract.
Arrange Amount	Displays the amount that is paid in installments as per the payment arrangement contract.
Number of Installments	Displays the number of installments used to calculate the Arrange Amount .

Search Bill

The **Search Bill** zone allows you to search for a bill. This zone contains the following fields:

- **Search Criteria** — The **Search Criteria** section contains the following fields:

Field Name	Field Description	Mandatory (Yes or No)
Person Name	Used to specify the name of the person for whom the bill is generated.	No
Person ID	Used to specify the person ID.	No
Bills of Persons in Hierarchy	Used to indicate whether you want to search for a bills generated against a person's hierarchy.	No
Bill Cycle	Used to indicate bills where a particular bill cycle is defined.	No
Bill Currency	Used to indicate the bill currency.	No
Billing Method	Used to indicate the billing method. The valid values are: <ul style="list-style-type: none"> • Ad-Hoc Billing • Regular Billing 	No
Bill ID	Used to specify the bill ID.	No
Alternate Bill ID	Used to search a particular bill using the alternate bill ID.	No
Account ID	Used to indicate the account against which the bill is generated.	No
On or After Bill Date	Used to specify the date when the bill was completed.	No
Account Identifier Type	Used to search for bills where the account against which it is generated, a particular account identifier type is defined.	No
Account Identifier	Used to search for a bill generated against an account with a particular account identifier.	No

Note: You must specify at least one search criterion while searching for the bill.

- **Search Results** — On clicking the **Search** button, the search results appear based on the specified search criteria. The **Search Results** section contains the following columns:

Column Name	Column Description
Person Name	Displays the name of the person against whom the bill is generated.
Bill ID	Displays the bill ID.
Bill Status	Displays the status of the bill. The valid values are: <ul style="list-style-type: none"> • Pending • Complete
Bill Date	Displays the date when the bill was completed.
Due Date	Displays the due date of the bill.
Current Charges	Displays the bill amount.
Bill Information	Displays additional information about the bill.

Searching for a Bill

Procedure

To search for a bill:

1. Click the **Menu** link in the **Application** toolbar.
A list appears.
2. From the **Main** menu, select **Delinquency Management** and then click **Delinquency Central**.
The **Delinquency Central** screen appears.
3. Select the **Bill** option from the **Search By** list.

Note: ORMB search engine supports wildcard search, where you can substitute the percentage (%) symbol as a stand in for any word or letter in a search criteria. You can use the ‘%’ wildcard character in all input fields except the date and ID fields. The ‘%’ wildcard character is suffixed automatically at the end of the partial search criteria. Therefore, you may or may not specify the wildcard character at the end of the partial search criteria. However, you have to prefix the wildcard character manually wherever required.

4. Click **Search**.

A list of bills that meet the search criteria appear in the **Search Results** section.

Related Topics

For more information on...	See...
Delinquency Central screen	Delinquency Central (Used for Viewing) on page 1754
Search Overdue Process zone	Search Overdue Process on page 1754

Adding the Customer Contact Details

Procedure

To add customer contact details:

1. Search for an overdue process in the **Delinquency Central** screen.
2. In the **Search Results** section, select the check box corresponding to the overdue process linked to the account for which you want to add the customer contact.
3. Click **Contact Customer**.

The **Customer Contact** screen appears.

4. Enter the required details.

The fields **Person ID**, **Contact Date/Time** and **User ID** are auto-populated.

5. Click **Save**.

The customer is contacted based on the value set for **Preferred Contact Method** field on the **Customer Contact** screen.

Related Topics

For more information on...	See...
Delinquency Central screen	Delinquency Central (Used for Viewing) on page 1754

Creating a Hold Request for an Overdue Process

Procedure

To create a hold request for an overdue process:

1. Search for an overdue process in the **Delinquency Central** screen.
2. In the **Search Results** section, select the check box corresponding to the **Overdue Process Information** column for whom you want to create a hold request for an overdue process.
3. Click **Create Hold Request** button.

The **Add Hold Request** screen appears. It contains the following field:

Field Name	Field Description	Mandatory
Hold Request Type	Used to indicate the hold request type that is used for creating a hold request.	Yes

4. Select the required hold request type from the **Hold Request Type** field.
5. Click **OK**.

The **Hold Request** screen appears.

6. Enter the required details for an overdue process.
7. Click **Save**.

A hold request is defined for an overdue process where the status of the hold request is set as **Draft**.

Note:

The **Hold Request** screen appears where you can view the details of the hold request.

Related Topics

For more information on...	See...
Delinquency Central screen	Delinquency Central (Used for Viewing) on page 1754
Hold Request screen	Hold Request (Used for Searching) on page 1713
How to search for an overdue process	Searching for an Overdue Process on page 1759

Creating a Payment Arrangement for an Overdue Process

Procedure

To create a payment arrangement for an overdue process:

1. Search for the overdue process in the **Delinquency Central** screen.
2. In the **Search Results** section, select the check box corresponding to the **Overdue Process Information** column for whom you want to create a payment arrangement for an overdue process.
3. Click the **Create Payment Arrangement** button.

The **Payment Arrangement** screen appears. It contains the following tabs:

- **Main**
- **History**

4. Enter the required details in the **Payment Arrangement** screen.
5. Click the **Save** button in the **Page Title** area of the **Payment Arrangement** screen.

A payment arrangement is created with the respective payment arrangement contract.

Note: The **Payment Arrangement** screen appears with the details of the payment arrangement.

Related Topics

For more information on...	See...
Delinquency Central screen	Delinquency Central (Used for Viewing) on page 1754
How to search for an overdue process	Searching for an Overdue Process on page 1759

Defining a Promise To Pay for an Overdue Process

Procedure

To create a promise to pay for an overdue process:

1. Search for the overdue process in the **Delinquency Central** screen.
2. In the **Search Results** section, select the check box corresponding to the **Overdue Process Information** column for whom you want to define a promise to pay for an overdue process.
3. Click the **Create Promise To Pay** button.

A message appears confirming that the promise to pay will be created for the account for which the overdue process is initiated.

4. Click **OK**.
- The **Promise To Pay** screen appears.
5. Enter the required details in the **Promise To Pay** screen.
6. Click the **Save** button in the **Page Title** area of the **Promise To Pay** screen.

A promise to pay is created with the scheduled payment details.

Related Topics

For more information on...	See...
Delinquency Central screen	Delinquency Central (Used for Viewing) on page 1754

For more information on...	See...
How to search for an overdue process	Searching for an Overdue Process on page 1759

Chapter 27

Upload Request

Topics:

- [Prerequisites](#)
- [Upload Request \(Without Approval\) Status Transition](#)
- [Upload Request \(With Approval\) Status Transition](#)
- [Defer Upload Request Validation](#)
- [Algorithms Used in C1-BillCycleUpdateUpdReq](#)
- [Algorithms Used in C1-ContractRiderUpdateUpdReq](#)
- [Algorithms Used in C1-HoldUploadRequest](#)
- [Algorithms Used in C1-RefundUploadRequest](#)
- [Algorithms Used in C1-WriteOffUploadRequest](#)
- [Algorithms Used in C1-BillableChargeUploadRequest](#)
- [Algorithms Used in C1-ReinstatementUploadRequest](#)
- [Algorithms Used in C1-BillGrpSortUploadRequest](#)
- [Algorithms Used in C1-BillLevelUploadRequest](#)
- [CSV File Format for Account Bill Cycle Upload Request](#)
- [CSV File Format for Contract Rider Upload Request](#)
- [CSV File Format for Billable Charge Upload](#)
- [CSV File Format for Hold Upload Request](#)

Oracle Revenue Management and Billing provides a generic upload feature which enables you to upload various types of data. The system enables you to upload data for the following using the **Upload Request** feature:

- Billable Charge (Adhoc and Regular)
- Hold Request
- Refund Request
- Write Off Request
- Policy Reinstatement
- Bill Group Sort ID
- Derivation and Pricing Parameters for a Bill Group and Sort ID Combination

It also enables you to update the following information:

- Contract rider of a contract
- Bill cycle of an account

While uploading data for the above supported entities, you need to specify the upload request type using which you want to upload the file. It is the upload request type which helps the system to determine:

- Whether the file must be approved by the approver before creating or updating the entities
- Which business object must be used for creating the upload request
- Which business object must be used for creating or updating entities through an upload request
- Which foreign key reference must be used for generating information string for the entity
- A set of fields using which you can search records uploaded through an upload request

You can upload a data file in the CSV format. You cannot upload data for more than one entity type through the same CSV file. For example, you cannot upload data for billable charges and hold requests using a single CSV file. An upload request of the specified upload request type is created when the file is successfully uploaded in the system. You can track a file through an upload request.

Once an upload request is created, the status of the upload request is set to **Draft**. The status of each record uploaded through an upload request is set to **Pending**. However, if the mandatory data is not available or data required for deriving

- [CSV File Format for Refund Request Upload](#)
- [CSV File Format for Write Off Request Upload](#)
- [CSV File Format for Reinstatement Upload Request](#)
- [CSV File Format for Bill Group Sorting Upload Request](#)
- [CSV File Format for Bill Group Derivation and Pricing Parameters Upload Request](#)
- [Upload Request Type](#)
- [Upload Request \(Used for Searching\)](#)
- [Upload Request \(Used for Viewing\)](#)

mandatory data is incorrect in the record, the status of record is set to **Invalid**. You can then edit, delete, or validate the upload request. During the validation process, the system and custom validations (if any) are executed. The status of each record is changed to **Valid** or **Invalid** depending on whether the record was validated successfully or not.

Once the upload request is validated, you can either cancel or submit the upload request for further processing. On submitting an upload request, the system checks whether the number of valid records in the uploaded file exceed the online record process limit defined in the Defer Upload Request algorithm. If the number of valid records in the uploaded file does not exceed the online record process limit, the system creates or updates the entities in the real time (i.e. immediately). However, if the number of valid records in the uploaded file exceeds the online record process limit, the system creates or updates the entities in the deferred mode (i.e. when the **Upload Request Periodic Monitor (C1-UPLRQ)** batch is invoked).

You can optionally configure the system to use the approval workflow process for an upload request. If the **Approval Required** flag is set to **Yes** in an upload request type, then on submitting the respective upload request, the approval workflow process creates a To Do for the approver to review the upload request. Once the approver approves the upload request, the system checks whether the number of valid records in the uploaded file exceed the online record process limit defined in the Defer Upload Request algorithm. If the number of valid records in the uploaded file does not exceed the online record process limit, the system creates or updates the entities in the real time (i.e. immediately). However, if the number of valid records in the uploaded file exceeds the online record process limit, the system creates or updates the entities in the deferred mode (i.e. when the **Upload Request Periodic Monitor (C1-UPLRQ)** batch is invoked. However, if the approver rejects the upload request, the status of the upload request is set to **Rejected**.

During the upload process, an upload request goes through various statuses in its lifecycle. Note that the lifecycle of an upload request is driven by the business object using which the upload request is created. In this release, we have shipped the following upload request business objects:

- Update Bill Cycle Upload Request (C1-BillCycleUpdateUplReq)
- Billable Charge Upload Request (C1-BillableChargeUploadRequest)
- Update Contract Rider Upload Request (C1-ContractRiderUpdateUplReq)
- Hold Request Upload Request (C1-HoldUploadRequest)
- Refund Request Upload Request (C1-RefundUploadRequest)
- Write Off Request Upload Request (C1-WriteOffUploadRequest)
- Reinstatement Upload Request (C1-ReinstatementUploadRequest)
- Bill Group Sorting Upload Request (C1-BillGrpSortUploadRequest)
- Bill Group Derivation and Pricing Parameters Upload Request(C1-BillLevelUploadRequest)

During the upload request process, an upload request creation goes through various statuses in its lifecycle. For more information about the upload request statuses, see [Upload Request \(Without Approval\) Status Transition](#) on page 1773 and [Upload Request \(With Approval\) Status Transition](#) on page 1774.

Note: The lifecycle of an upload request creation is driven by the respective business object using which the request is created. The upload request feature explained in this document is articulated based on the lifecycle and logic defined in the business objects.

For more information on how to setup the upload request process, see [Prerequisites](#) on page 1772.

Prerequisites

To setup the upload request process, you need to do the following:

- Define the required upload request types in the system.
- Define the required characteristic types where the characteristic entity is set to **Upload Request Type**.
- Define the required characteristic types where the characteristic entity is set to **Upload Request**.
- Define the values for the following parameters in the **C1-REN-VALID** algorithm:
 - Policy Status after Processing Reinstatement Upload Request
 - Policy Reinstatement Status for Reason Verification
- Define the value for the **Online Record Process Limit** parameter in the **C1-DEFERUPLD** algorithm.
- Define the value for the **Policy Status after Processing Reinstatement Upload Request** parameter in the **C1-REN-PROC** algorithm.
- Assign the **C1-BCUUR** To Do type to a To Do role whose users must receive the To Do for approving a bill cycle update upload request.
- Assign the **C1-CRUUR** To Do type to a To Do role whose users must receive the To Do for approving a contract rider update upload request.
- Assign the **C1-HLDUR** To Do type to a To Do role whose users must receive the To Do for approving a hold upload request.
- Assign the **C1-REFUR** To Do type to a To Do role whose users must receive the To Do for approving a refund upload request.
- Assign the **C1-WOUR** To Do type to a To Do role whose users must receive the To Do for approving a write off upload request.
- Assign the **C1-BCUR** To Do type to a To Do role whose users must receive the To Do for approving a billable charge upload request.
- Assign the **C1-RPUR** To Do type to a To Do role whose users must receive the To Do for approving a reinstatement upload request.
- Create a To Do type named **C1-BGSRT** using the following information:
 - **Navigation Option** - c1upldrqTabMenu
 - **Sort Keys** - Define the following sort keys for the To Do type:

Sort Key	Use as Default	Sort Order
Upload Request ID	Yes	Descending

- **Drill Keys** - Define the following drill keys for the To Do type:

Table Name	Field Name
C1_UPLOAD_REQ	Upload Request ID

- Assign the **C1-BGSRT** To Do type to a To Do role whose users must receive the To Do for approving a bill group sorting upload request.
- Create a To Do type named **C1-BGDVP** using the following information:
 - **Navigation Option** - c1upldrqTabMenu

- **Sort Keys** - Define the following sort keys for the To Do type:

Sort Key	Use as Default	Sort Order
Upload Request ID	Yes	Descending

- **Drill Keys** - Define the following drill keys for the To Do type:

Table Name	Field Name
C1_UPLOAD_REQ	Upload Request ID

- Assign the **C1-BGDVP** To Do type to a To Do role whose users must receive the To Do for approving a bill group derivation and pricing parameters upload request.
- Set the batch control type of the **Upload Request Periodic Monitor (C1-UPLRQ)** batch to **Timed** and define the following attributes:
 - Time Interval
 - Timer Active
 - User ID
 - Batch Language
 - Email Address

Upload Request (Without Approval) Status Transition

The following figure graphically indicates how an upload request moves from one status to another when the approval workflow is off:

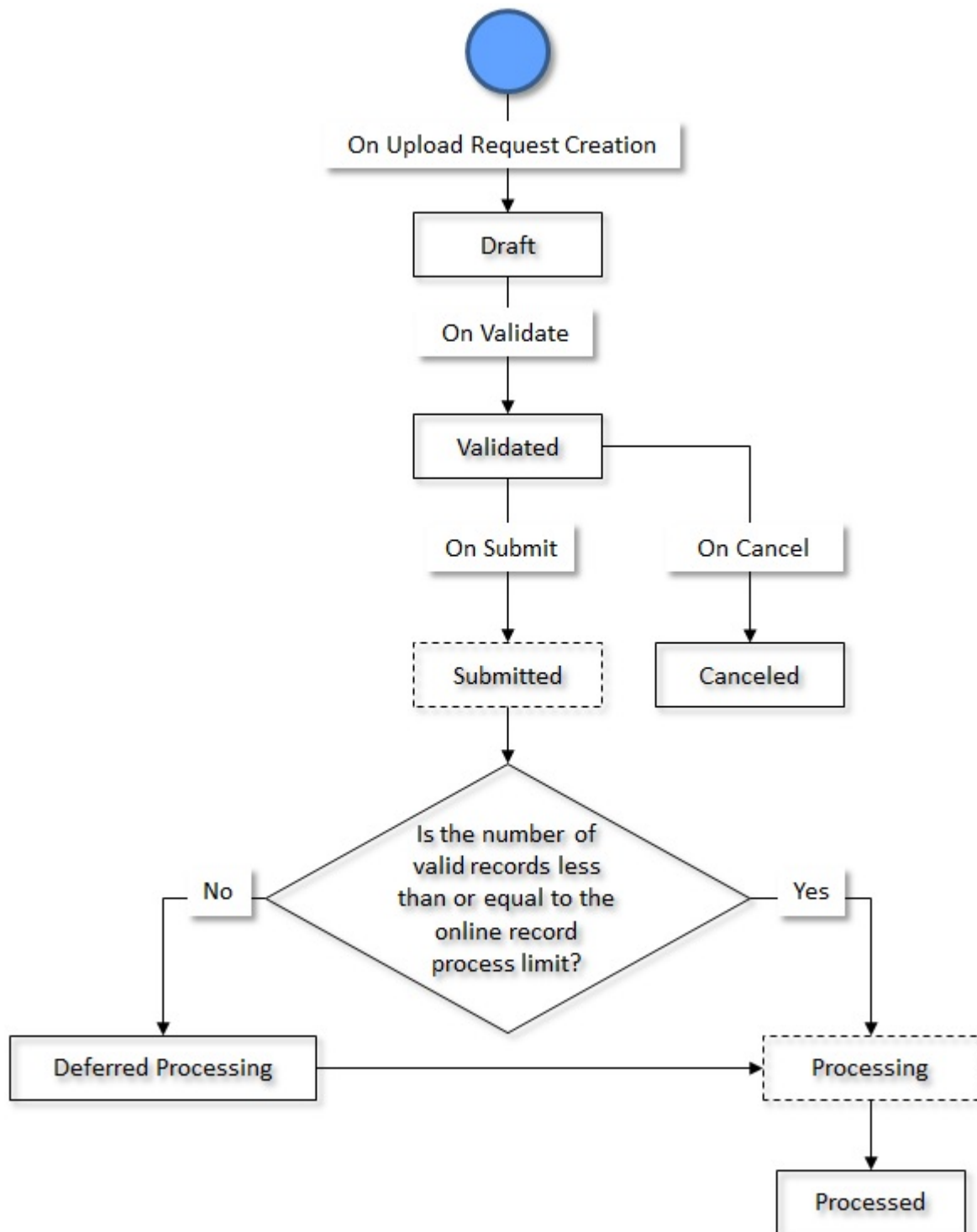

Upload Request (With Approval) Status Transition

The following figure graphically indicates how an upload request moves from one status to another when the approval workflow is on:

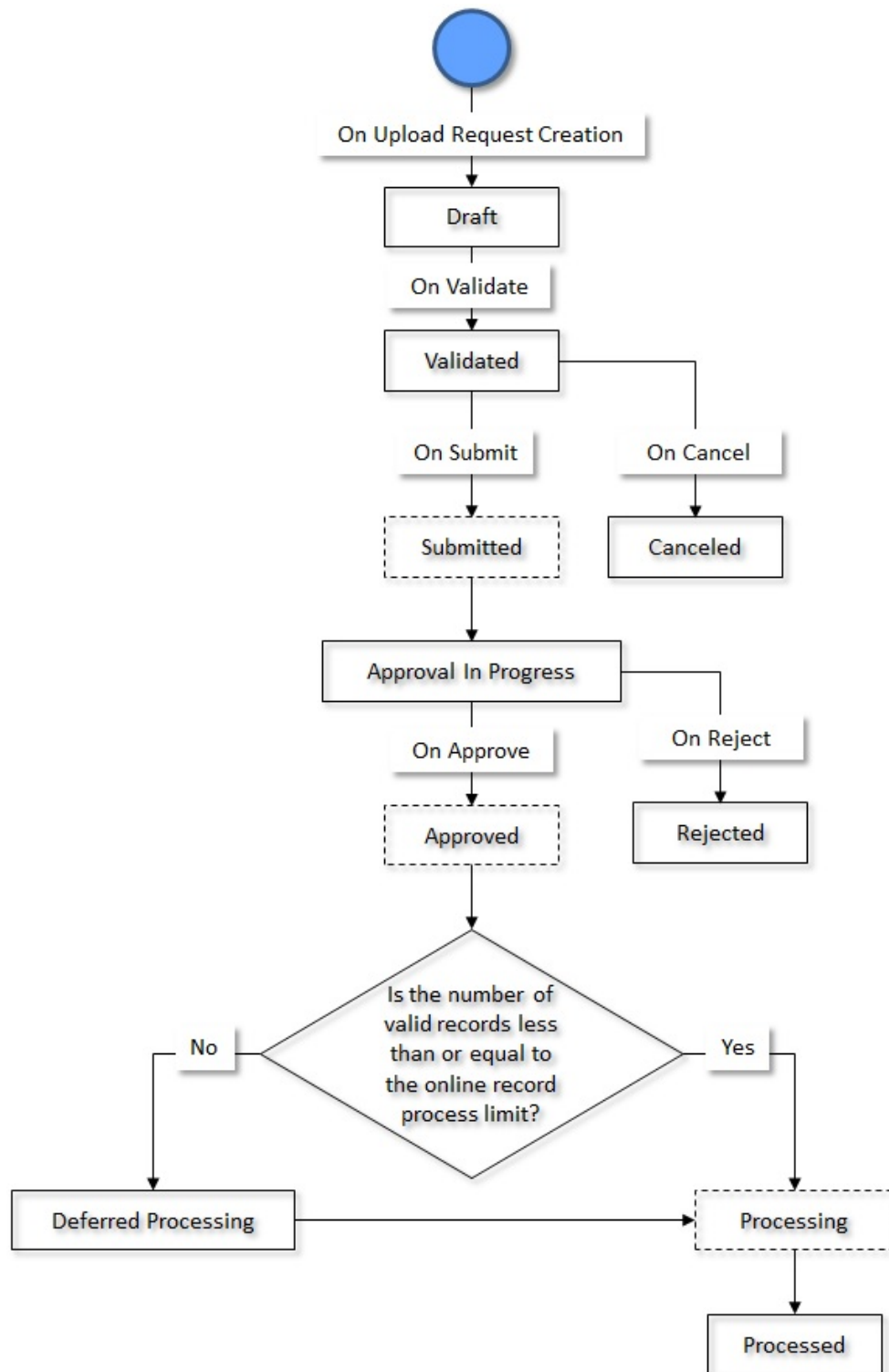

Defer Upload Request Validation

Until now, the system enabled you to upload data for the following using the **Upload Request** feature:

- Billable Charge (Adhoc and Regular)

- Hold Request
- Refund Request
- Write Off Request
- Derivation and Pricing Parameters for a Bill Group and Sort ID Combination

The system faced performance issues while validating a CSV file uploaded through the Upload Request feature when the CSV file had voluminous records. Therefore, now the system has introduced defer processing mechanism while validating a CSV file. The defer processing mechanism for the validation process is introduced for the following business objects:

- C1-BillableChargeUploadRequest
- C1-HoldUploadRequest
- C1-RefundUploadRequest
- C1-WriteOffUploadRequest
- C1-BillLevelUploadRequest

Two new statuses named **Validating** and **Deferred Validation** are added in the lifecycle of the above business objects. Now, when you click the **Validate** button, the system changes the status of the upload request to **Validating**. The system then invokes the **C1-DEFERVALD** algorithm which is attached to the **Validating** status. It checks whether the total number of records in the upload request exceeds the online record validate limit defined in the **C1-DEFERVALD** algorithm. If the total number of records in the upload request does not exceed the online record validate limit, all records in the upload request are validated immediately and its record status is changed to **Valid** or **Invalid** depending on whether it is successfully validated or not. Finally, the status of the upload request is changed to **Validated**.

However, if the total number of records in the upload request exceeds the online record validate limit, the status of the upload request is changed to **Deferred Validation**. On executing the **C1-UPLRQ** batch, the system checks whether there are any upload requests in the **Deferred Validation** status. If there is an upload request in the **Deferred Validation** status, all records in the upload request are validated in the deferred mode and its record status is changed to **Valid** or **Invalid** depending on whether it is successfully validated or not. Finally, the status of the upload request is changed to **Validated**.

Algorithms Used in C1-BillCycleUpdateUplReq

The following table lists the algorithms which are used in the lifecycle of the **C1-BillCycleUpdateUplReq** business object:

Status	System Event	Algorithm	Algorithm Type	Description
Draft	Enter	C1-BCU-DERIV	C1-BCU-DERIV	<p>This algorithm reads the data in the BO_DATA_AREA column of the C1_UPL_REQUEST table and accordingly inserts the records in the C1_UPLOAD_REQ_DTLS table. In addition, the status of each record in the C1_UPLOAD_REQ_DTLS table is set to Pending.</p> <p>It derives the account ID using the account identifier type and account identifier combination whenever the account ID is not specified in the record. Once the account ID is derived, the corresponding record is updated in the C1_UPLOAD_REQ_DTLS</p>

Status	System Event	Algorithm	Algorithm Type	Description
				table. If the system could not derive the account ID using the account identifier type and account identifier combination, the status of the record in the C1_UPLOAD_REQ_DTLS table is changed to Invalid .
Validated	Enter	C1-BCU-VALID	C1-BCU-VALID	<p>This algorithm is invoked when the user clicks the Validate button. It validates the records which are in the Pending status. It checks whether the account ID and bill cycle specified in the record are valid. If the account ID and bill cycle are valid and if the bill cycle is associated with the division to which the account belongs, the status of the record in the C1_UPLOAD_REQ_DTLS table is changed to Valid.</p> <p>If the account ID is invalid, it derives the account ID using the account identifier type and account identifier combination and updates the record accordingly. In addition, it changes the status of the record in the C1_UPLOAD_REQ_DTLS table to Valid. However, if the system could not derive the account ID using the account identifier type and account identifier combination, or if the bill cycle is invalid, or if the bill cycle is not associated with the division to which the account belongs, the status of the record in the C1_UPLOAD_REQ_DTLS table is changed to Invalid.</p> <p>It also checks whether there are two or more records with the same account ID. If so, it validates and changes the status of one record to Valid and the status of the remaining records is changed to Invalid.</p>
Submitted	Monitor	F1-AT-RQJ	F1-GEN-BOMNJ	<p>This algorithm transitions the current status to the specified status. You can specify the status to which you want the business object to transition in the following parameters:</p> <ul style="list-style-type: none"> • Next Status • Next Transition Condition <p>At a time, you can specify value for either the Next Status or Next</p>

Status	System Event	Algorithm	Algorithm Type	Description
				Transition Condition parameter. If you don't specify any value for these parameters, the system will transition the business object to the default next status specified in its lifecycle.
Submitted	Enter	C1-UPLSUBENT	C1-UPLSUBENT	This algorithm is invoked when the user clicks the Submit button. It checks whether the approval is required for the upload request. If the approval is required for an upload request, the status of the upload request is changed to Approval In Progress . However, if the approval is not required for an upload request, the status of the upload request remains in the Submitted status.
Submitted	Enter	C1-DEFERUPLD	C1-DEFERUPLD	This algorithm is invoked when the status of the upload request is changed to Submitted or Approved . It checks whether the upload request must be processed in the real time (i.e. immediately) or in the deferred mode (i.e. in the background). If the number of valid records in the upload request does not exceed the online record process limit, the system changes the status of the upload request to Processing . However, if the number of valid records in the upload request exceeds the online record process limit, the system changes the status of the upload request to Deferred Processing . It contains the following parameter: <ul style="list-style-type: none"> • Online Record Process Limit <ul style="list-style-type: none"> – Used to indicate the maximum number of valid records you can process in the real time (i.e. immediately).
Approval In Progress	Enter	C1-UPLAPPENT	C1-UPLAPPENT	This algorithm creates a To Do using the To Do type specified in the upload request type. The To Do is sent to the appropriate users with the To Do role which is specified in the upload request type. In addition, a log entry is added when a To Do is created using the To Do type.
Approval In Progress	Exit	C1-UPLAPPEXT	C1-UPLAPPEXT	This algorithm checks whether the approver is associated with the approval To Do role specified in the upload request type. If not, it does

Status	System Event	Algorithm	Algorithm Type	Description
				not allow the approver to approve or reject the upload request. In addition, it does not allow the submitter to approve or reject the upload request.
Approval In Progress	Exit	F1-TODOCOMPL	F1-TODOCOMPL	This algorithm completes To Do entries that are created for the business object when the business object exits the given status. It finds and completes all open To Do entries where the business object's primary key is defined as a drill key. However, if the Exclude To Do Entries From Auto Completion characteristic is defined for the business object, then the system does not automatically complete the respective To Do entry.
Approved	Enter	C1-DEFERUPLD	C1-DEFERUPLD	This algorithm is invoked when the status of the upload request is changed to Submitted or Approved . It checks whether the upload request must be processed in the real time (i.e. immediately) or in the deferred mode (i.e. in the background). If the number of valid records in the upload request does not exceed the online record process limit, the system changes the status of the upload request to Processing . However, if the number of valid records in the upload request exceeds the online record process limit, the system changes the status of the upload request to Deferred Processing . It contains the following parameter: <ul style="list-style-type: none"> • Online Record Process Limit – Used to indicate the maximum number of valid records you can process in the real time (i.e. immediately).
Approved	Monitor	F1-AT-RQJ	F1-GEN-BOMNJ	This algorithm transitions the current status to the specified status. You can specify the status to which you want the business object to transition in the following parameters: <ul style="list-style-type: none"> • Next Status • Next Transition Condition At a time, you can specify value for either the Next Status or Next Transition Condition parameter. If

Status	System Event	Algorithm	Algorithm Type	Description
				you don't specify any value for these parameters, the system will transition the business object to the default next status specified in its lifecycle.
Deferred Processing	Monitor	F1-AT-RQJ	F1-GEN-BOMNJ	<p>This algorithm transitions the current status to the specified status. You can specify the status to which you want the business object to transition in the following parameters:</p> <ul style="list-style-type: none"> • Next Status • Next Transition Condition <p>At a time, you can specify value for either the Next Status or Next Transition Condition parameter. If you don't specify any value for these parameters, the system will transition the business object to the default next status specified in its lifecycle.</p>
Processing	Enter	C1-BCU-PROC	C1-BCU-PROC	<p>This algorithm fetches a list of records which are in the Valid status. For each valid record, the system reads the account ID and bill cycle, and updates the bill cycle information of the account using the entity business object defined in the upload request type. If the record is successfully processed, the status of the record is changed to Processed. However, if the record could not be processed successfully due to any reason, the status of the record is changed to Error. Finally, the status of the upload request is changed to Processed.</p>
Processing	Monitor	F1-AT-RQJ	F1-GEN-BOMNJ	<p>This algorithm transitions the current status to the specified status. You can specify the status to which you want the business object to transition in the following parameters:</p> <ul style="list-style-type: none"> • Next Status • Next Transition Condition <p>At a time, you can specify value for either the Next Status or Next Transition Condition parameter. If you don't specify any value for these parameters, the system will transition the business object to the default next status specified in its lifecycle.</p>

Algorithms Used in C1-ContractRiderUpdateUpReq

The following table lists the algorithms which are used in the lifecycle of the **C1-ContractRiderUpdateUpReq** business object:

Status	System Event	Algorithm	Algorithm Type	Description
Draft	Enter	C1-CR-DERIV	C1-CR-DERIV	<p>This algorithm reads the data in the BO_DATA_AREA column of the C1_UPL_REQUEST table and accordingly inserts the records in the C1_UPLOAD_REQ_DTLS table. In addition, the status of each record in the C1_UPLOAD_REQ_DTLS table is set to Pending.</p> <p>It derives the account ID using the account identifier type and account identifier combination whenever the account ID is not specified in the record. Once the account ID is derived, the corresponding record is updated in the C1_UPLOAD_REQ_DTLS table. If the system could not derive the account ID using the account identifier type and account identifier combination, the status of the record in the C1_UPLOAD_REQ_DTLS table is changed to Invalid.</p>
Validated	Enter	C1-CR-VALID	C1-CR-VALID	<p>This algorithm is invoked when the user clicks the Validate button. It validates the records which are in the Pending status. It checks whether the account ID, contract ID, contract type, and bill factor specified in the record are valid. If the account ID, contract ID, contract type, and bill factor are valid, if the specified contract belongs to the account, and if the Contract Rider Applicability flag on the bill factor is set to Y, the status of the record in the C1_UPLOAD_REQ_DTLS table is changed to Valid.</p> <p>If the account ID is invalid, it derives the account ID using the account identifier type and account identifier combination and updates the record accordingly. In addition, it changes the status of the record in the C1_UPLOAD_REQ_DTLS table to Valid. However, if the system could not derive the account</p>

Status	System Event	Algorithm	Algorithm Type	Description
				<p>ID using the account identifier type and account identifier combination, or if the bill factor is invalid, or if the specified contract does not belong to the account, or if the Contract Rider Applicability flag on the bill factor is set to N, the status of the record in the C1_UPLOAD_REQ_DTLS table is changed to Invalid.</p> <p>It also checks whether there are two or more records with the same account ID and contract type combination. If so, it validates and changes the status of one record to Valid and the status of the remaining records is changed to Invalid.</p>
Submitted	Enter	C1-UPLSUBENT	C1-UPLSUBENT	<p>This algorithm is invoked when the user clicks the Submit button. It checks whether the approval is required for the upload request. If the approval is required for an upload request, the status of the upload request is changed to Approval In Progress. However, if the approval is not required for an upload request, the status of the upload request remains in the Submitted status.</p>
Submitted	Enter	C1-DEFERUPLD	C1-DEFERUPLD	<p>This algorithm is invoked when the status of the upload request is changed to Submitted or Approved. It checks whether the upload request must be processed in the real time (i.e. immediately) or in the deferred mode (i.e. in the background). If the number of valid records in the upload request does not exceed the online record process limit, the system changes the status of the upload request to Processing. However, if the number of valid records in the upload request exceeds the online record process limit, the system changes the status of the upload request to Deferred Processing.</p> <p>It contains the following parameter:</p> <ul style="list-style-type: none"> Online Record Process Limit <ul style="list-style-type: none"> Used to indicate the maximum number of valid records you can process in the real time (i.e. immediately).

Status	System Event	Algorithm	Algorithm Type	Description
Submitted	Monitor	F1-AT-RQJ	F1-GEN-BOMNJ	<p>This algorithm transitions the current status to the specified status. You can specify the status to which you want the business object to transition in the following parameters:</p> <ul style="list-style-type: none"> • Next Status • Next Transition Condition <p>At a time, you can specify value for either the Next Status or Next Transition Condition parameter. If you don't specify any value for these parameters, the system will transition the business object to the default next status specified in its lifecycle.</p>
Approval In Progress	Enter	C1-UPLAPPENT	C1-UPLAPPENT	<p>This algorithm creates a To Do using the To Do type specified in the upload request type. The To Do is sent to the appropriate users with the To Do role which is specified in the upload request type. In addition, a log entry is added when a To Do is created using the To Do type.</p>
Approval In Progress	Exit	C1-UPLAPPEXT	C1-UPLAPPEXT	<p>This algorithm checks whether the approver is associated with the approval To Do role specified in the upload request type. If not, it does not allow the approver to approve or reject the upload request. In addition, it does not allow the submitter to approve or reject the upload request.</p>
Approval In Progress	Exit	F1-TODOCOMPL	F1-TODOCOMPL	<p>This algorithm completes To Do entries that are created for the business object when the business object exits the given status. It finds and completes all open To Do entries where the business object's primary key is defined as a drill key. However, if the Exclude To Do Entries From Auto Completion characteristic is defined for the business object, then the system does not automatically complete the respective To Do entry.</p>
Approved	Enter	C1-DEFERUPLD	C1-DEFERUPLD	<p>This algorithm is invoked when the status of the upload request is changed to Submitted or Approved. It checks whether the upload request must be processed in the real time (i.e. immediately) or in the deferred</p>

Status	System Event	Algorithm	Algorithm Type	Description
				<p>mode (i.e. in the background). If the number of valid records in the upload request does not exceed the online record process limit, the system changes the status of the upload request to Processing. However, if the number of valid records in the upload request exceeds the online record process limit, the system changes the status of the upload request to Deferred Processing.</p> <p>It contains the following parameter:</p> <ul style="list-style-type: none"> • Online Record Process Limit <ul style="list-style-type: none"> – Used to indicate the maximum number of valid records you can process in the real time (i.e. immediately).
Approved	Monitor	F1-AT-RQJ	F1-GEN-BOMNJ	<p>This algorithm transitions the current status to the specified status. You can specify the status to which you want the business object to transition in the following parameters:</p> <ul style="list-style-type: none"> • Next Status • Next Transition Condition <p>At a time, you can specify value for either the Next Status or Next Transition Condition parameter. If you don't specify any value for these parameters, the system will transition the business object to the default next status specified in its lifecycle.</p>
Deferred Processing	Monitor	F1-AT-RQJ	F1-GEN-BOMNJ	<p>This algorithm transitions the current status to the specified status. You can specify the status to which you want the business object to transition in the following parameters:</p> <ul style="list-style-type: none"> • Next Status • Next Transition Condition <p>At a time, you can specify value for either the Next Status or Next Transition Condition parameter. If you don't specify any value for these parameters, the system will transition the business object to the default next status specified in its lifecycle.</p>

Status	System Event	Algorithm	Algorithm Type	Description
Processing	Enter	C1-CR-PROC	C1-CR-PROC	This algorithm fetches a list of records which are in the Valid status. For each valid record, the system reads the account ID and contract ID, and updates the contract rider information of the contract using the entity business object defined in the upload request type. If the contract ID is not specified in the record, then the system derives the active contract of the specified contract type on the account, and then updates the contract rider information of the contract. If the record is successfully processed, the status of the record is changed to Processed . However, if the record could not be processed successfully due to any reason, the status of the record is changed to Error . Finally, the status of the upload request is changed to Processed .
Processing	Monitor	F1-AT-RQJ	F1-GEN-BOMNJ	This algorithm transitions the current status to the specified status. You can specify the status to which you want the business object to transition in the following parameters: <ul style="list-style-type: none"> • Next Status • Next Transition Condition At a time, you can specify value for either the Next Status or Next Transition Condition parameter. If you don't specify any value for these parameters, the system will transition the business object to the default next status specified in its lifecycle.

Algorithms Used in C1-HoldUploadRequest

The following table lists the algorithms which are used in the lifecycle of the **C1-HoldUploadRequest** business object:

Status	System Event	Algorithm	Algorithm Type	Description
Draft	Enter	C1-HLD-DERIV	C1-HLD-DERIV	This algorithm reads the data in the BO_DATA_AREA column of the C1_UPL_REQUEST table and accordingly inserts the records in the C1_UPLOAD_REQ_DTLS table. In addition, the status of each record

Status	System Event	Algorithm	Algorithm Type	Description
				<p>in the C1_UPLOAD_REQ_DTLS table is set to Pending.</p> <p>If the hold entity is ACCT and the entity ID is not specified in the record, it derives the account ID using the account identifier type and account identifier combination. Similarly, if the hold entity is PERS and the entity ID is not specified in the record, it derives the person ID using the person identifier type and person identifier combination. Once the account ID or person ID is derived, the corresponding record is updated in the C1_UPLOAD_REQ_DTLS table. If the system could not derive the account ID using the account identifier type and account identifier combination or if the system could not derive the person ID using the person identifier type and person identifier combination, the status of the record in the C1_UPLOAD_REQ_DTLS table is changed to Invalid.</p>
Validated	Enter	C1-HLD-VALID	C1-HLD-VALID	<p>This algorithm is invoked when the user clicks the Validate button. It validates the records which are in the Pending status. It checks whether the data provided for creating a hold request is valid. If the entity ID and hold data are valid, the status of the record in the C1_UPLOAD_REQ_DTLS table is changed to Valid.</p> <p>If the hold entity is ACCT and the entity ID is invalid, it derives the account ID using the account identifier type and account identifier combination and updates the record accordingly. Similarly, if the hold entity is PERS and the entity ID is invalid, it derives the person ID using the person identifier type and person identifier combination and updates the record accordingly. In addition, it changes the status of the record in the C1_UPLOAD_REQ_DTLS table to Valid. However, if the system could not derive the account ID using the account identifier type and account identifier combination,</p>

Status	System Event	Algorithm	Algorithm Type	Description
				or if the system could not derive the person ID using the person identifier type and person identifier combination, or if the hold data is invalid, the status of the record in the C1_UPLOAD_REQ_DTLS table is changed to Invalid .
Submitted	Enter	C1-UPLSUBENT	C1-UPLSUBENT	This algorithm is invoked when the user clicks the Submit button. It checks whether the approval is required for the upload request. If the approval is required for an upload request, the status of the upload request is changed to Approval In Progress . However, if the approval is not required for an upload request, the status of the upload request remains in the Submitted status.
Submitted	Enter	C1-DEFERUPLD	C1-DEFERUPLD	This algorithm is invoked when the status of the upload request is changed to Submitted or Approved . It checks whether the upload request must be processed in the real time (i.e. immediately) or in the deferred mode (i.e. in the background). If the number of valid records in the upload request does not exceed the online record process limit, the system changes the status of the upload request to Processing . However, if the number of valid records in the upload request exceeds the online record process limit, the system changes the status of the upload request to Deferred Processing . It contains the following parameter: <ul style="list-style-type: none"> • Online Record Process Limit <ul style="list-style-type: none"> – Used to indicate the maximum number of valid records you can process in the real time (i.e. immediately).
Submitted	Monitor	F1-AT-RQJ	F1-GEN-BOMNJ	This algorithm transitions the current status to the specified status. You can specify the status to which you want the business object to transition in the following parameters: <ul style="list-style-type: none"> • Next Status • Next Transition Condition At a time, you can specify value for either the Next Status or Next

Status	System Event	Algorithm	Algorithm Type	Description
				Transition Condition parameter. If you don't specify any value for these parameters, the system will transition the business object to the default next status specified in its lifecycle.
Approval In Progress	Enter	C1-UPLAPPENT	C1-UPLAPPENT	This algorithm creates a To Do using the To Do type specified in the upload request type. The To Do is sent to the appropriate users with the To Do role which is specified in the upload request type. In addition, a log entry is added when a To Do is created using the To Do type.
Approval In Progress	Exit	C1-UPLAPPEXT	C1-UPLAPPEXT	This algorithm checks whether the approver is associated with the approval To Do role specified in the upload request type. If not, it does not allow the approver to approve or reject the upload request. In addition, it does not allow the submitter to approve or reject the upload request.
Approval In Progress	Exit	F1-TODOCOMPL	F1-TODOCOMPL	This algorithm completes To Do entries that are created for the business object when the business object exits the given status. It finds and completes all open To Do entries where the business object's primary key is defined as a drill key. However, if the Exclude To Do Entries From Auto Completion characteristic is defined for the business object, then the system does not automatically complete the respective To Do entry.
Approved	Enter	C1-DEFERUPLD	C1-DEFERUPLD	This algorithm is invoked when the status of the upload request is changed to Submitted or Approved . It checks whether the upload request must be processed in the real time (i.e. immediately) or in the deferred mode (i.e. in the background). If the number of valid records in the upload request does not exceed the online record process limit, the system changes the status of the upload request to Processing . However, if the number of valid records in the upload request exceeds the online record process limit, the system changes the status of the upload request to Deferred Processing .

Status	System Event	Algorithm	Algorithm Type	Description
				<p>It contains the following parameter:</p> <ul style="list-style-type: none"> • Online Record Process Limit <ul style="list-style-type: none"> – Used to indicate the maximum number of valid records you can process in the real time (i.e. immediately).
Approved	Monitor	F1-AT-RQJ	F1-GEN-BOMNJ	<p>This algorithm transitions the current status to the specified status. You can specify the status to which you want the business object to transition in the following parameters:</p> <ul style="list-style-type: none"> • Next Status • Next Transition Condition <p>At a time, you can specify value for either the Next Status or Next Transition Condition parameter. If you don't specify any value for these parameters, the system will transition the business object to the default next status specified in its lifecycle.</p>
Deferred Processing	Monitor	F1-AT-RQJ	F1-GEN-BOMNJ	<p>This algorithm transitions the current status to the specified status. You can specify the status to which you want the business object to transition in the following parameters:</p> <ul style="list-style-type: none"> • Next Status • Next Transition Condition <p>At a time, you can specify value for either the Next Status or Next Transition Condition parameter. If you don't specify any value for these parameters, the system will transition the business object to the default next status specified in its lifecycle.</p>
Processing	Enter	C1-HLD-PROC	C1-HLD-PROC	<p>This algorithm fetches a list of records which are in the Valid status. For each valid record with a unique combination of the hold request type, start date, end date, hold reason, hold entity, hold entity start date, hold entity end date, comments, hold process details, and hold characteristic details, it creates one hold request using the entity business object defined in the upload request type. However, if there are</p>

Status	System Event	Algorithm	Algorithm Type	Description
				<p>multiple entity IDs with the same combination, all are added in the same hold request. The hold request is created in the Draft status and then transitioned to Submit.</p> <p>From the Submit status, the status of the hold request is either changed to Approval In Progress or Active depending on whether the Approval Required flag is set to Yes. If the number of bills of the entities which are kept on hold through the hold request does not exceed the defer processing count (defined in the hold request type), the status of the hold request is changed to Active. However, if the number of bills of the entities which are kept on hold through the hold request exceeds the defer processing count, the status of the hold request is changed to Deferred Processing. If the record is successfully processed, the status of the record is changed to Processed. However, if the record could not be processed successfully due to any reason, the status of the record is changed to Error. Finally, the status of the upload request is changed to Processed.</p>
Processing	Monitor	F1-AT-RQJ	F1-GEN-BOMNJ	<p>This algorithm transitions the current status to the specified status. You can specify the status to which you want the business object to transition in the following parameters:</p> <ul style="list-style-type: none"> • Next Status • Next Transition Condition <p>At a time, you can specify value for either the Next Status or Next Transition Condition parameter. If you don't specify any value for these parameters, the system will transition the business object to the default next status specified in its lifecycle.</p>

Algorithms Used in C1-RefundUploadRequest

The following table lists the algorithms which are used in the lifecycle of the **C1-RefundUploadRequest** business object:

Status	System Event	Algorithm	Algorithm Type	Description
Validated	Enter	C1-RF-VALID	C1-RF-VALID	This algorithm validates the data uploaded in an upload request for creating refund requests before the request is submitted for processing.
Draft	Enter	C1-RF-DERIV	C1-RF-DERIV	This algorithm reads the BO_DATA_AREA in the request's primary table, derives additional data that is required for creating refund requests and inserts the records in C1_UPLOAD_REQ_DTLS table.
Submitted	Enter	C1-UPLSUBENT	C1-UPLSUBENT	This algorithm is invoked when the user clicks the Submit button. It checks whether the approval is required for the upload request. If the approval is required for an upload request, the status of the upload request is changed to Approval In Progress . However, if the approval is not required for an upload request, the status of the upload request remains in the Submitted status.
Submitted	Enter	C1-DEFERUPLD	C1-DEFERUPLD	<p>This algorithm is invoked when the status of the upload request is changed to Submitted or Approved. It checks whether the upload request must be processed in the real time (i.e. immediately) or in the deferred mode (i.e. in the background). If the number of valid records in the upload request does not exceed the online record process limit, the system changes the status of the upload request to Processing. However, if the number of valid records in the upload request exceeds the online record process limit, the system changes the status of the upload request to Deferred Processing.</p> <p>It contains the following parameter:</p> <ul style="list-style-type: none"> • Online Record Process Limit <ul style="list-style-type: none"> – Used to indicate the maximum number of valid records you can process in the real time (i.e. immediately).
Submitted	Monitor	F1-AT-RQJ	F1-GEN-BOMNJ	<p>This algorithm transitions the current status to the specified status. You can specify the status to which you want the business object to transition in the following parameters:</p> <ul style="list-style-type: none"> • Next Status

Status	System Event	Algorithm	Algorithm Type	Description
				<ul style="list-style-type: none"> Next Transition Condition <p>At a time, you can specify value for either the Next Status or Next Transition Condition parameter. If you don't specify any value for these parameters, the system will transition the business object to the default next status specified in its lifecycle.</p>
Approval In Progress	Enter	C1-UPLAPPENT	C1-UPLAPPENT	This algorithm creates a To Do using the To Do type specified in the upload request type. The To Do is sent to the appropriate users with the To Do role which is specified in the upload request type. In addition, a log entry is added when a To Do is created using the To Do type.
Approval In Progress	Exit	C1-UPLAPPEXT	C1-UPLAPPEXT	This algorithm checks whether the approver is associated with the approval To Do role specified in the upload request type. If not, it does not allow the approver to approve or reject the upload request. In addition, it does not allow the submitter to approve or reject the upload request.
Approval In Progress	Exit	F1-TODOCOMPL	F1-TODOCOMPL	This algorithm completes To Do entries that are created for the business object when the business object exits the given status. It finds and completes all open To Do entries where the business object's primary key is defined as a drill key. However, if the Exclude To Do Entries From Auto Completion characteristic is defined for the business object, then the system does not automatically complete the respective To Do entry.
Approved	Enter	C1-DEFERUPLD	C1-DEFERUPLD	This algorithm is invoked when the status of the upload request is changed to Submitted or Approved . It checks whether the upload request must be processed in the real time (i.e. immediately) or in the deferred mode (i.e. in the background). If the number of valid records in the upload request does not exceed the online record process limit, the system changes the status of the upload request to Processing . However, if the number of valid records in the

Status	System Event	Algorithm	Algorithm Type	Description
				<p>upload request exceeds the online record process limit, the system changes the status of the upload request to Deferred Processing.</p> <p>It contains the following parameter:</p> <ul style="list-style-type: none"> • Online Record Process Limit <ul style="list-style-type: none"> – Used to indicate the maximum number of valid records you can process in the real time (i.e. immediately).
Approved	Monitor	F1-AT-RQJ	F1-GEN-BOMNJ	<p>This algorithm transitions the current status to the specified status. You can specify the status to which you want the business object to transition in the following parameters:</p> <ul style="list-style-type: none"> • Next Status • Next Transition Condition <p>At a time, you can specify value for either the Next Status or Next Transition Condition parameter. If you don't specify any value for these parameters, the system will transition the business object to the default next status specified in its lifecycle.</p>
Deferred Processing	Monitor	F1-AT-RQJ	F1-GEN-BOMNJ	<p>This algorithm transitions the current status to the specified status. You can specify the status to which you want the business object to transition in the following parameters:</p> <ul style="list-style-type: none"> • Next Status • Next Transition Condition <p>At a time, you can specify value for either the Next Status or Next Transition Condition parameter. If you don't specify any value for these parameters, the system will transition the business object to the default next status specified in its lifecycle.</p>
Processing	Enter	C1-RF-PROC	C1-RF-PROC	<p>This algorithm fetches the list of records that are in Valid status for a given request ID and invokes the entity business object for creating the refund requests. If successfully processed, then the record status will be updated to Processed, otherwise the record status will be updated</p>

Status	System Event	Algorithm	Algorithm Type	Description
				to Error and error details will be logged in the exception table.
Processing	Monitor	F1-AT-RQJ	F1-GEN-BOMNJ	<p>This algorithm transitions the current status to the specified status. You can specify the status to which you want the business object to transition in the following parameters:</p> <ul style="list-style-type: none"> • Next Status • Next Transition Condition <p>At a time, you can specify value for either the Next Status or Next Transition Condition parameter. If you don't specify any value for these parameters, the system will transition the business object to the default next status specified in its lifecycle.</p>

Algorithms Used in C1-WriteOffUploadRequest

The following table lists the algorithms which are used in the lifecycle of the **C1-WriteOffUploadRequest** business object:

Status	System Event	Algorithm	Algorithm Type	Description
Draft	Enter	C1-WO-DERIV	C1-WO-DERIV	This algorithm reads the BO_DATA_AREA in the request's primary table, derives additional data that is required for creating write off requests and inserts the records in C1_UPLOAD_REQ_DTLS table.
Submitted	Enter	C1-UPLSUBENT	C1-UPLSUBENT	This algorithm is invoked when the user clicks the Submit button. It checks whether the approval is required for the upload request. If the approval is required for an upload request, the status of the upload request is changed to Approval In Progress . However, if the approval is not required for an upload request, the status of the upload request remains in the Submitted status.
Submitted	Enter	C1-DEFERUPLD	C1-DEFERUPLD	This algorithm is invoked when the status of the upload request is changed to Submitted or Approved . It checks whether the upload request must be processed in the real time (i.e. immediately) or in the deferred mode (i.e. in the background). If the number of valid records in the upload

Status	System Event	Algorithm	Algorithm Type	Description
				request does not exceed the online record process limit, the system changes the status of the upload request to Processing . However, if the number of valid records in the upload request exceeds the online record process limit, the system changes the status of the upload request to Deferred Processing . It contains the following parameter: <ul style="list-style-type: none"> • Online Record Process Limit <ul style="list-style-type: none"> – Used to indicate the maximum number of valid records you can process in the real time (i.e. immediately).
Submitted	Monitor	F1-AT-RQJ	F1-GEN-BOMNJ	This algorithm transitions the current status to the specified status. You can specify the status to which you want the business object to transition in the following parameters: <ul style="list-style-type: none"> • Next Status • Next Transition Condition At a time, you can specify value for either the Next Status or Next Transition Condition parameter. If you don't specify any value for these parameters, the system will transition the business object to the default next status specified in its lifecycle.
Approval In Progress	Enter	C1-UPLAPPENT	C1-UPLAPPENT	This algorithm creates a To Do using the To Do type specified in the upload request type. The To Do is sent to the appropriate users with the To Do role which is specified in the upload request type. In addition, a log entry is added when a To Do is created using the To Do type.
Approval In Progress	Exit	C1-UPLAPPEXT	C1-UPLAPPEXT	This algorithm checks whether the approver is associated with the approval To Do role specified in the upload request type. If not, it does not allow the approver to approve or reject the upload request. In addition, it does not allow the submitter to approve or reject the upload request.
Approval In Progress	Exit	F1-TODOCOMPL	F1-TODOCOMPL	This algorithm completes To Do entries that are created for the business object when the business

Status	System Event	Algorithm	Algorithm Type	Description
				<p>object exits the given status. It finds and completes all open To Do entries where the business object's primary key is defined as a drill key. However, if the Exclude To Do Entries From Auto Completion characteristic is defined for the business object, then the system does not automatically complete the respective To Do entry.</p>
Approved	Enter	C1-DEFERUPLD	C1-DEFERUPLD	<p>This algorithm is invoked when the status of the upload request is changed to Submitted or Approved. It checks whether the upload request must be processed in the real time (i.e. immediately) or in the deferred mode (i.e. in the background). If the number of valid records in the upload request does not exceed the online record process limit, the system changes the status of the upload request to Processing. However, if the number of valid records in the upload request exceeds the online record process limit, the system changes the status of the upload request to Deferred Processing.</p> <p>It contains the following parameter:</p> <ul style="list-style-type: none"> • Online Record Process Limit <ul style="list-style-type: none"> – Used to indicate the maximum number of valid records you can process in the real time (i.e. immediately).
Approved	Monitor	F1-AT-RQJ	F1-GEN-BOMNJ	<p>This algorithm transitions the current status to the specified status. You can specify the status to which you want the business object to transition in the following parameters:</p> <ul style="list-style-type: none"> • Next Status • Next Transition Condition <p>At a time, you can specify value for either the Next Status or Next Transition Condition parameter. If you don't specify any value for these parameters, the system will transition the business object to the default next status specified in its lifecycle.</p>

Status	System Event	Algorithm	Algorithm Type	Description
Deferred Processing	Monitor	F1-AT-RQJ	F1-GEN-BOMNJ	<p>This algorithm transitions the current status to the specified status. You can specify the status to which you want the business object to transition in the following parameters:</p> <ul style="list-style-type: none"> • Next Status • Next Transition Condition <p>At a time, you can specify value for either the Next Status or Next Transition Condition parameter. If you don't specify any value for these parameters, the system will transition the business object to the default next status specified in its lifecycle.</p>
Processing	Enter	C1-WO-PROC	C1-WO-PROC	<p>This algorithm fetches the list of records that are in Valid status for a given request ID and invokes the entity business object for creating the write off requests. If successfully processed, then the record status will be updated to Processed, otherwise the record status will be updated to Error and error details will be logged in the exception table.</p>
Processing	Monitor	F1-AT-RQJ	F1-GEN-BOMNJ	<p>This algorithm transitions the current status to the specified status. You can specify the status to which you want the business object to transition in the following parameters:</p> <ul style="list-style-type: none"> • Next Status • Next Transition Condition <p>At a time, you can specify value for either the Next Status or Next Transition Condition parameter. If you don't specify any value for these parameters, the system will transition the business object to the default next status specified in its lifecycle.</p>

Algorithms Used in C1-BillableChargeUploadRequest

The following table lists the algorithms which are used in the lifecycle of the **C1-BillableChargeUploadRequest** business object:

Status	System Event	Algorithm	Algorithm Type	Description
Draft	Enter	C1-CRTUPLDTL	C1-CRTUPLDTL	This algorithm reads the data in the BO_DATA_AREA column of the C1_UPL_REQUEST table and accordingly inserts the records in the C1_UPLOAD_REQ_DTLS table. In addition, the status of each record in the C1_UPLOAD_REQ_DTLS table is set to Pending .
Draft	Enter	C1-BC-DERIV	C1-BC-DERIV	This algorithm reads the BO_DATA_AREA in the request's primary table, derives additional data that is required for creating billable charges and inserts the records in C1_UPLOAD_REQ_DTLS table.
Validated	Enter	C1-BC-VALID	C1-BC-VALID	This algorithm validates the data upload in an upload request for creating billable charges before the request is submitted for processing.
Submitted	Enter	C1-UPLSUBENT	C1-UPLSUBENT	This algorithm is invoked when the user clicks the Submit button. It checks whether the approval is required for the upload request. If the approval is required for an upload request, the status of the upload request is changed to Approval In Progress . However, if the approval is not required for an upload request, the status of the upload request remains in the Submitted status.
Submitted	Enter	C1-DEFERUPLD	C1-DEFERUPLD	This algorithm is invoked when the status of the upload request is changed to Submitted or Approved . It checks whether the upload request must be processed in the real time (i.e. immediately) or in the deferred mode (i.e. in the background). If the number of valid records in the upload request does not exceed the online record process limit, the system changes the status of the upload request to Processing . However, if the number of valid records in the upload request exceeds the online record process limit, the system changes the status of the upload request to Deferred Processing . It contains the following parameter: <ul style="list-style-type: none"> • Online Record Process Limit <ul style="list-style-type: none"> – Used to indicate the maximum number of valid

Status	System Event	Algorithm	Algorithm Type	Description
				records you can process in the real time (i.e. immediately).
Submitted	Monitor	F1-AT-RQJ	F1-GEN-BOMNJ	<p>This algorithm transitions the current status to the specified status. You can specify the status to which you want the business object to transition in the following parameters:</p> <ul style="list-style-type: none"> • Next Status • Next Transition Condition <p>At a time, you can specify value for either the Next Status or Next Transition Condition parameter. If you don't specify any value for these parameters, the system will transition the business object to the default next status specified in its lifecycle.</p>
Approval In Progress	Enter	C1-UPLAPPENT	C1-UPLAPPENT	This algorithm creates a To Do using the To Do type specified in the upload request type. The To Do is sent to the appropriate users with the To Do role which is specified in the upload request type. In addition, a log entry is added when a To Do is created using the To Do type.
Approval In Progress	Exit	C1-UPLAPPEXT	C1-UPLAPPEXT	This algorithm checks whether the approver is associated with the approval To Do role specified in the upload request type. If not, it does not allow the approver to approve or reject the upload request. In addition, it does not allow the submitter to approve or reject the upload request.
Approval In Progress	Exit	F1-TODOCOMPL	F1-TODOCOMPL	This algorithm completes To Do entries that are created for the business object when the business object exits the given status. It finds and completes all open To Do entries where the business object's primary key is defined as a drill key. However, if the Exclude To Do Entries From Auto Completion characteristic is defined for the business object, then the system does not automatically complete the respective To Do entry.
Approved	Enter	C1-DEFERUPLD	C1-DEFERUPLD	This algorithm is invoked when the status of the upload request is changed to Submitted or Approved . It checks whether the upload request must be processed in the real time

Status	System Event	Algorithm	Algorithm Type	Description
				<p>(i.e. immediately) or in the deferred mode (i.e. in the background). If the number of valid records in the upload request does not exceed the online record process limit, the system changes the status of the upload request to Processing. However, if the number of valid records in the upload request exceeds the online record process limit, the system changes the status of the upload request to Deferred Processing.</p> <p>It contains the following parameter:</p> <ul style="list-style-type: none"> • Online Record Process Limit <ul style="list-style-type: none"> – Used to indicate the maximum number of valid records you can process in the real time (i.e. immediately).
Approved	Monitor	F1-AT-RQJ	F1-GEN-BOMNJ	<p>This algorithm transitions the current status to the specified status. You can specify the status to which you want the business object to transition in the following parameters:</p> <ul style="list-style-type: none"> • Next Status • Next Transition Condition <p>At a time, you can specify value for either the Next Status or Next Transition Condition parameter. If you don't specify any value for these parameters, the system will transition the business object to the default next status specified in its lifecycle.</p>
Deferred Processing	Monitor	F1-AT-RQJ	F1-GEN-BOMNJ	<p>This algorithm transitions the current status to the specified status. You can specify the status to which you want the business object to transition in the following parameters:</p> <ul style="list-style-type: none"> • Next Status • Next Transition Condition <p>At a time, you can specify value for either the Next Status or Next Transition Condition parameter. If you don't specify any value for these parameters, the system will transition the business object to the default next status specified in its lifecycle.</p>
Processing	Enter	C1-BC-PROC	C1-BC-PROC	<p>This algorithm fetches the list of records that are in Valid status for</p>

Status	System Event	Algorithm	Algorithm Type	Description
				a given request ID and invokes the entity business object for creating billable charge on the contract. If successfully created, then the record status will be updated to Processed , otherwise the record status will be updated to Error and error details will be logged in the exception table.
Processing	Monitor	F1-AT-RQJ	F1-GEN-BOMNJ	<p>This algorithm transitions the current status to the specified status. You can specify the status to which you want the business object to transition in the following parameters:</p> <ul style="list-style-type: none"> • Next Status • Next Transition Condition <p>At a time, you can specify value for either the Next Status or Next Transition Condition parameter. If you don't specify any value for these parameters, the system will transition the business object to the default next status specified in its lifecycle.</p>

Algorithms Used in C1-ReinstatementUploadRequest

The following table lists the algorithms which are used in the lifecycle of the **C1-ReinstatementUploadRequest** business object:

Status	System Event	Algorithm	Algorithm Type	Description
Draft	Enter	C1-CRTUPLDTL	C1-CRTUPLDTL	This algorithm reads the data in the BO_DATA_AREA column of the C1_UPL_REQUEST table and accordingly inserts the records in the C1_UPLOAD_REQ_DTLS table. In addition, the status of each record in the C1_UPLOAD_REQ_DTLS table is set to Pending .
Draft	Enter	C1-REN-DERIV	C1-REN-DERIV	This algorithm reads the data in the BO_DATA_AREA column of the C1_UPLOAD_REQ_DTLS table and then derives the policy ID using the source system and policy number combination whenever the policy ID is not specified in the record. Once the policy ID is derived, the corresponding record is updated in the C1_UPLOAD_REQ_DTLS table. If the system could not derive the policy ID using the source system and policy number combination, the status of the record

Status	System Event	Algorithm	Algorithm Type	Description
				in the C1_UPLOAD_REQ_DTLS table is changed to Invalid .
Validated	Enter	C1-REN-VALID	C1-REN-VALID	<p>This algorithm is invoked when the user clicks the Validate button. It validates the records which are in the Pending status. It checks whether the policy ID and reinstatement reason specified in the record is valid. If the policy ID and reinstatement reason are valid, the status of the record in the C1_UPLOAD_REQ_DTLS table is changed to Valid.</p> <p>If the policy ID is invalid, it derives the policy ID using the source system and policy number combination and updates the record accordingly. In addition, it changes the status of the record in the C1_UPLOAD_REQ_DTLS table to Valid. However, if the system could not derive the policy ID using the source system and policy number combination, or if the reinstatement reason is invalid, the status of the record in the C1_UPLOAD_REQ_DTLS table is changed to Invalid.</p> <p>It also checks whether there are two or more policies with the same policy ID. If so, it validates and changes the status of one record to Valid and the status of the remaining records is changed to Invalid. It contains the following parameters:</p> <ul style="list-style-type: none"> • Policy Status after Processing Reinstatement Upload Request – Used to specify the status to which you want to transition the policy when the reinstatement upload request is processed. • Policy Reinstatement Status for Reason Verification – Used to validate the reinstatement reason. The reason should be a valid reason for the specified status.
Submitted	Monitor	F1-AT-RQJ	F1-GEN-BOMNJ	<p>This algorithm transitions the current status to the specified status. You can specify the status to which you want the business object to transition in the following parameters:</p> <ul style="list-style-type: none"> • Next Status • Next Transition Condition <p>At a time, you can specify value for either the Next Status or Next Transition Condition parameter. If you don't specify any value for</p>

Status	System Event	Algorithm	Algorithm Type	Description
				these parameters, the system will transition the business object to the default next status specified in its lifecycle.
Submitted	Enter	C1-UPLSUBENT	C1-UPLSUBENT	This algorithm is invoked when the user clicks the Submit button. It checks whether the approval is required for the upload request. If the approval is required for an upload request, the status of the upload request is changed to Approval In Progress . However, if the approval is not required for an upload request, the status of the upload request remains in the Submitted status.
Submitted	Enter	C1-DEFERUPLD	C1-DEFERUPLD	This algorithm is invoked when the status of the upload request is changed to Submitted or Approved . It checks whether the upload request must be processed in the real time (i.e. immediately) or in the deferred mode (i.e. in the background). If the number of valid records in the upload request does not exceed the online record process limit, the system changes the status of the upload request to Processing . However, if the number of valid records in the upload request exceeds the online record process limit, the system changes the status of the upload request to Deferred Processing . It contains the following parameter: <ul style="list-style-type: none"> • Online Record Process Limit – Used to indicate the maximum number of valid records you can process in the real time (i.e. immediately).
Approval In Progress	Enter	C1-UPLAPPENT	C1-UPLAPPENT	This algorithm creates a To Do using the To Do type specified in the upload request type. The To Do is sent to the appropriate users with the To Do role which is specified in the upload request type. In addition, a log entry is added when a To Do is created using the To Do type.
Approval In Progress	Exit	C1-UPLAPPEXT	C1-UPLAPPEXT	This algorithm checks whether the approver is associated with the approval To Do role specified in the upload request type. If not, it does not allow the approver to approve or reject the upload request. In addition, it does not allow the submitter to approve or reject the upload request.
Approval In Progress	Exit	F1-TODOCOMPL	F1-TODOCOMPL	This algorithm completes To Do entries that are created for the business object when the business object exits the given status. It finds and completes all open To Do entries where the business object's primary

Status	System Event	Algorithm	Algorithm Type	Description
				key is defined as a drill key. However, if the Exclude To Do Entries From Auto Completion characteristic is defined for the business object, then the system does not automatically complete the respective To Do entry.
Approved	Enter	C1-DEFERUPLD	C1-DEFERUPLD	<p>This algorithm is invoked when the status of the upload request is changed to Submitted or Approved. It checks whether the upload request must be processed in the real time (i.e. immediately) or in the deferred mode (i.e. in the background). If the number of valid records in the upload request does not exceed the online record process limit, the system changes the status of the upload request to Processing. However, if the number of valid records in the upload request exceeds the online record process limit, the system changes the status of the upload request to Deferred Processing.</p> <p>It contains the following parameter:</p> <ul style="list-style-type: none"> • Online Record Process Limit – Used to indicate the maximum number of valid records you can process in the real time (i.e. immediately).
Approved	Monitor	F1-AT-RQJ	F1-GEN-BOMNJ	<p>This algorithm transitions the current status to the specified status. You can specify the status to which you want the business object to transition in the following parameters:</p> <ul style="list-style-type: none"> • Next Status • Next Transition Condition <p>At a time, you can specify value for either the Next Status or Next Transition Condition parameter. If you don't specify any value for these parameters, the system will transition the business object to the default next status specified in its lifecycle.</p>
Deferred Processing	Monitor	F1-AT-RQJ	F1-GEN-BOMNJ	<p>This algorithm transitions the current status to the specified status. You can specify the status to which you want the business object to transition in the following parameters:</p> <ul style="list-style-type: none"> • Next Status • Next Transition Condition <p>At a time, you can specify value for either the Next Status or Next Transition Condition parameter. If you don't specify any value for these parameters, the system will transition</p>

Status	System Event	Algorithm	Algorithm Type	Description
				the business object to the default next status specified in its lifecycle.
Processing	Monitor	F1-AT-RQJ	F1-GEN-BOMNJ	<p>This algorithm transitions the current status to the specified status. You can specify the status to which you want the business object to transition in the following parameters:</p> <ul style="list-style-type: none"> • Next Status • Next Transition Condition <p>At a time, you can specify value for either the Next Status or Next Transition Condition parameter. If you don't specify any value for these parameters, the system will transition the business object to the default next status specified in its lifecycle.</p>
Processing	Enter	C1-REN-PROC	C1-REN-PROC	<p>This algorithm fetches a list of records which are in the Valid status. For each valid record, the system reads the policy ID and reinstatement reason, and reinstates the policy using the entity business object defined in the upload request type. On reinstating the policy, the status of the policy is changed as mentioned in this algorithm. If the record is successfully processed, the status of the record is changed to Processed. However, if the record could not be processed successfully due to any reason, the status of the record is changed to Error. Finally, the status of the upload request is changed to Processed.</p> <p>It contains the following parameter:</p> <ul style="list-style-type: none"> • Policy Status after Processing Reinstatement Upload Request - Used to specify the status to which you want to transition the policy when the reinstatement upload request is processed.

Algorithms Used in C1-BillGrpSortUploadRequest

The following table lists the algorithms which are used in the lifecycle of the **C1-BillGrpSortUploadRequest** business object:

Status	System Event	Algorithm	Algorithm Type	Description
Draft	Enter	C1-BLSRTUPLD	C1-BLSRTUPLD	Refer to C1-BLSRTUPLD on page 1806.
Draft	Enter	C1-BLSRTDERV	C1-BLSRTDERV	Refer to C1-BLSRTDERV on page 1806.

Status	System Event	Algorithm	Algorithm Type	Description
Validated	Enter	C1-BLSRTVALD	C1-BLSRTVALD	Refer to C1-BLSRTVALD on page 1806.
Canceled	—	—	—	—
Submitted	Monitor	F1-AT-RQJ	F1-GEN-BOMNJ	Refer to F1-AT-RQJ on page 1560.
Submitted	Enter	C1-UPLSUBENT	C1-UPLSUBENT	Refer to C1-UPLSUBENT on page 1807.
Submitted	Enter	C1-DEFERUPLD	C1-DEFERUPLD	Refer to C1-DEFERUPLD on page 1807.
Approval In Progress	Enter	C1-UPLAPPENT	C1-UPLAPPENT	Refer to C1-UPLAPPENT on page 1807.
Approval In Progress	Exit	C1-UPLAPPEXT	C1-UPLAPPEXT	Refer to C1-UPLAPPEXT on page 1808.
Approval In Progress	Exit	F1-TODOCOMPL	F1-TODOCOMPL	Refer to F1-TODOCOMPL on page 1453.
Approved	Monitor	F1-AT-RQJ	F1-GEN-BOMNJ	Refer to F1-AT-RQJ on page 1560.
Approved	Enter	C1-DEFERUPLD	C1-DEFERUPLD	Refer to C1-DEFERUPLD on page 1807.
Rejected	—	—	—	—
Deferred Processing	Monitor	F1-AT-RQJ	F1-GEN-BOMNJ	Refer to F1-AT-RQJ on page 1560.
Processing	Monitor	F1-AT-RQJ	F1-GEN-BOMNJ	Refer to F1-AT-RQJ on page 1560.
Processing	Enter	C1-BLSRTPROC	C1-BLSRTPROC	Refer to C1-BLSRTPROC on page 1808.
Processed	—	—	—	—

C1-BLSRTUPLD

This algorithm reads the data in the **BO_DATA_AREA** column of the **C1_UPL_REQUEST** table and accordingly inserts the records in the **C1_UPLOAD_REQ_DTLS** table. In addition, the status of each record in the **C1_UPLOAD_REQ_DTLS** table is set to **Pending**.

C1-BLSRTDERV

This algorithm reads the data in the **BO_DATA_AREA** column of the **C1_UPLOAD_REQ_DTLS** table and then derives the bill group (person) ID using the bill group (person) identifier type and bill group (person) identifier combination whenever the bill group ID is not specified in the record. Once the bill group ID is derived, the corresponding record is updated in the **C1_UPLOAD_REQ_DTLS** table. If the system could not derive the bill group ID using the bill group identifier type and bill group identifier combination, the status of the record in the **C1_UPLOAD_REQ_DTLS** table is changed to **Invalid**.

C1-BLSRTVALD

This algorithm is invoked when the user clicks the **Validate** button. It validates the records which are in the **Pending** status. It checks the following:

- The parent customer's person type is set to **Parent Customer** in the system.

- All mandatory information is available in the bill group sort record.
- The end date is not earlier than the start date and the start date is not later than the end date.
- Either the bill group (person) identifier type and bill group (person) identifier or the bill group (person) ID is available in the bill group sort record.
- The bill group identifier type is available when the bill group identifier is specified and vice versa.
- A bill group with the specified bill group ID exists in the system.
- The bill group is the child person of the parent customer.
- The bill group's person type is set to **Bill Group** in the system.
- The relationship between the bill group and parent customer is effective on the system date.
- The bill group is related to the parent customer using a relationship type which is specified in the **Person Relationship Type** option type of the **C1-ASOBLLNG** feature configuration.
- A duplicate record with the bill group ID and sort ID combination does not exist in the **C1_BILL_LVL** table.
- A duplicate record with the bill group ID and sort ID combination does not exist in the **C1_UPLOAD_REQ_DTLS** table.

If the above mentioned validations are successful, the status of the record in the **C1_UPLOAD_REQ_DTLS** table is changed to **Valid**. However, if any of the above validation fails, the status of the record in the **C1_UPLOAD_REQ_DTLS** table is changed to **Invalid**.

F1-AT-RQJ

This algorithm transitions the current status of the business object to the specified status. It contains the following parameters:

- **Next Status** – Used when you want to override the default next status specified in the lifecycle.
- **Next Transition Condition** – Used when you want to override the default next transition condition specified in the lifecycle.

At a time, you can specify value for either the **Next Status** or **Next Transition Condition** parameter. If you don't specify any value for these parameters, the system will transition the business object to the default next status specified in its lifecycle.

C1-UPLSUBENT

This algorithm is invoked when the user clicks the **Submit** button. It checks whether the approval is required for the upload request. If the approval is required for an upload request, the status of the upload request is changed to **Approval In Progress**. However, if the approval is not required for an upload request, the status of the upload request remains in the **Submitted** status.

C1-DEFERUPLD

This algorithm is invoked when the status of the upload request is changed to **Submitted** or **Approved**. It checks whether the upload request must be processed in the real time (i.e. immediately) or in the deferred mode (i.e. in the background). If the number of valid records in the upload request does not exceed the online record process limit, the system changes the status of the upload request to **Processing**. However, if the number of valid records in the upload request exceeds the online record process limit, the system changes the status of the upload request to **Deferred Processing**.

It contains the following parameter:

- **Online Record Process Limit** – Used to indicate the maximum number of valid records you can process in the real time (i.e. immediately).

C1-UPLAPPENT

This algorithm creates a To Do using the To Do type specified in the upload request type. The To Do is sent to the appropriate users with the To Do role which is specified in the upload request type. In addition, a log entry is added when a To Do is created using the To Do type.

C1-UPLAPPEXT

This algorithm checks whether the approver is associated with the approval To Do role specified in the upload request type. If not, it does not allow the approver to approve or reject the upload request. In addition, it does not allow the submitter to approve or reject the upload request.

F1-TODOCOMPL

This algorithm type completes the To Do entries that are linked to an object when the object exits the given status.

It finds and completes all open To Do entries where the business object's primary key is defined as a drill key. However, if the **Exclude To Do Entries From Auto Completion** characteristic is set to **Y** for the business object, the system does not automatically complete the respective To Do entry.

C1-BLSRTPROC

This algorithm fetches a list of records which are in the **Valid** status. For each valid record with a unique combination of the bill group (person) ID and sort ID, it creates one bill group sort record using the entity business object defined in the upload request type. If the record is successfully processed, the status of the record is changed to **Processed**. However, if the record could not be processed successfully due to any reason, the status of the record is changed to **Error**. Finally, the status of the upload request is changed to **Processed**.

Algorithms Used in C1-BillLevelUploadRequest

The following table lists the algorithms which are used in the lifecycle of the **C1-BillLevelUploadRequest** business object:

Status	System Event	Algorithm	Algorithm Type	Description
Draft	Enter	C1-BLVUPLDTL	C1-BLVUPLDTL	Refer to C1-BLVUPLDTL on page 1809.
Draft	Enter	C1-BLVLDERIV	C1-BLVLDERIV	Refer to C1-BLVLDERIV on page 1809.
Validated	Enter	C1-BLVLVALID	C1-BLVLVALID	Refer to C1-BLVLVALID on page 1809.
Canceled	—	—	—	—
Submitted	Monitor	F1-AT-RQJ	F1-GEN-BOMNJ	Refer to F1-AT-RQJ on page 1560.
Submitted	Enter	C1-UPLSUBENT	C1-UPLSUBENT	Refer to C1-UPLSUBENT on page 1807.
Submitted	Enter	C1-DEFERUPLD	C1-DEFERUPLD	Refer to C1-DEFERUPLD on page 1807.
Approval Progress	In Enter	C1-UPLAPPENT	C1-UPLAPPENT	Refer to C1-UPLAPPENT on page 1807.
Approval Progress	In Exit	C1-UPLAPPEXT	C1-UPLAPPEXT	Refer to C1-UPLAPPEXT on page 1808.

Status	System Event	Algorithm	Algorithm Type	Description
Approval In Progress	Exit	F1-TODOCOMPL	F1-TODOCOMPL	Refer to F1-TODOCOMPL on page 1453.
Approved	Monitor	F1-AT-RQJ	F1-GEN-BOMNJ	Refer to F1-AT-RQJ on page 1560.
Approved	Enter	C1-DEFERUPLD	C1-DEFERUPLD	Refer to C1-DEFERUPLD on page 1807.
Rejected	—	—	—	—
Deferred Processing	Monitor	F1-AT-RQJ	F1-GEN-BOMNJ	Refer to F1-AT-RQJ on page 1560.
Processing	Monitor	F1-AT-RQJ	F1-GEN-BOMNJ	Refer to F1-AT-RQJ on page 1560.
Processing	Enter	C1-BLVLVLPPO	C1-BLVLVLPPO	Refer to C1-BLVLVLPPO on page 1811.
Processed	—	—	—	—

C1-BLVUPLDTL

This algorithm reads the data in the **BO_DATA_AREA** column of the **C1_UPL_REQUEST** table and accordingly inserts the records in the **C1_UPLOAD_REQ_DTLS** table. In addition, the status of each record in the **C1_UPLOAD_REQ_DTLS** table is set to **Pending**.

C1-BLVLDERIV

This algorithm reads the data in the **BO_DATA_AREA** column of the **C1_UPLOAD_REQ_DTLS** table and then derives the bill group (person) ID using the bill group (person) identifier type and bill group (person) identifier combination whenever the bill group ID is not specified in the record. Once the bill group ID is derived, the corresponding record is updated in the **C1_UPLOAD_REQ_DTLS** table. If the system could not derive the bill group ID using the bill group identifier type and bill group identifier combination, the status of the record in the **C1_UPLOAD_REQ_DTLS** table is changed to **Invalid**.

C1-BLVLVALID

This algorithm is invoked when the user clicks the **Validate** button. It validates the records which are in the **Pending** status. It checks the following:

- The parent customer's person type is set to **Parent Customer** in the system.
- All mandatory information is available in the bill group derivation and pricing parameters record.
- Either the bill group (person) identifier type and bill group (person) identifier or the bill group (person) ID is available in the bill group derivation and pricing parameters record.
- The bill group identifier type is available when the bill group identifier is specified and vice versa.
- The number of characters specified in each field does not exceed the maximum field length.
- A bill group with the specified bill group ID exists in the system.
- The bill group is the child person of the parent customer.
- The bill group's person type is set to **Bill Group** in the system.
- The relationship between the bill group and parent customer is effective on the system date.
- The bill group is related to the parent customer using the relationship type which is specified in the **Person Relationship Type** option type of the **C1-ASOBLLNG** feature configuration.

- A duplicate record with the source system, parameter 1, parameter 2, parameter 3, parameter 4, and effective date combination does not exist in the **C1_BILL_LVL** table.
- A duplicate record with the source system, parameter 1, parameter 2, parameter 3, parameter 4, and effective date combination does not exist in the **C1_UPLOAD_REQ_DTLS** table.
- The source system exists in the extendable lookup which is specified in the **Source System Extendable Lookup** parameter.
- The bill group sort record with the bill group ID and sort ID combination already exists in the system.
- The effective date specified in the record is within the date range of the effective bill group sort record.

If the above mentioned validations are successful, the status of the record in the **C1_UPLOAD_REQ_DTLS** table is changed to **Valid**. However, if any of the above validation fails, the status of the record in the **C1_UPLOAD_REQ_DTLS** table is changed to **Invalid**.

It contains the following parameter:

- **Source System Extendable Lookup** – Used to specify the source system extendable lookup business object. The bill group derivation and pricing parameters records should contain the source system which is already defined in this extendable lookup.

F1-AT-RQJ

This algorithm transitions the current status of the business object to the specified status. It contains the following parameters:

- **Next Status** – Used when you want to override the default next status specified in the lifecycle.
- **Next Transition Condition** – Used when you want to override the default next transition condition specified in the lifecycle.

At a time, you can specify value for either the **Next Status** or **Next Transition Condition** parameter. If you don't specify any value for these parameters, the system will transition the business object to the default next status specified in its lifecycle.

C1-UPLSUBENT

This algorithm is invoked when the user clicks the **Submit** button. It checks whether the approval is required for the upload request. If the approval is required for an upload request, the status of the upload request is changed to **Approval In Progress**. However, if the approval is not required for an upload request, the status of the upload request remains in the **Submitted** status.

C1-DEFERUPLD

This algorithm is invoked when the status of the upload request is changed to **Submitted** or **Approved**. It checks whether the upload request must be processed in the real time (i.e. immediately) or in the deferred mode (i.e. in the background). If the number of valid records in the upload request does not exceed the online record process limit, the system changes the status of the upload request to **Processing**. However, if the number of valid records in the upload request exceeds the online record process limit, the system changes the status of the upload request to **Deferred Processing**.

It contains the following parameter:

- **Online Record Process Limit** – Used to indicate the maximum number of valid records you can process in the real time (i.e. immediately).

C1-UPLAPPENT

This algorithm creates a To Do using the To Do type specified in the upload request type. The To Do is sent to the appropriate users with the To Do role which is specified in the upload request type. In addition, a log entry is added when a To Do is created using the To Do type.

C1-UPLAPPEXT

This algorithm checks whether the approver is associated with the approval To Do role specified in the upload request type. If not, it does not allow the approver to approve or reject the upload request. In addition, it does not allow the submitter to approve or reject the upload request.

F1-TODOCOMPL

This algorithm type completes the To Do entries that are linked to an object when the object exits the given status.

It finds and completes all open To Do entries where the business object's primary key is defined as a drill key. However, if the **Exclude To Do Entries From Auto Completion** characteristic is set to **Y** for the business object, the system does not automatically complete the respective To Do entry.

C1-BLVVLVPRO

This algorithm fetches a list of records which are in the **Valid** status. For each valid record with a unique combination of the source system, parameter 1, parameter 2, parameter 3, parameter 4, and effective date, it creates one bill group derivation and pricing parameters record using the entity business object defined in the upload request type. If the record is successfully processed, the status of the record is changed to **Processed**. However, if the record could not be processed successfully due to any reason, the status of the record is changed to **Error**. Finally, the status of the upload request is changed to **Processed**.

CSV File Format for Account Bill Cycle Upload Request

Before uploading the account bill cycle file, you need to ensure that the CSV file contains the following columns:

Column Name	Description	Mandatory (Yes or No)
Account Identifier Type	Used to specify the account identifier type.	Yes (Conditional) Note: This data is required when the account ID is not specified.
Account Identifier	Used to specify the identifier of the account whose bill cycle you want to update.	Yes (Conditional) Note: This data is required when the account ID is not specified.
Account ID	Used to indicate the account whose bill cycle you want to update. Note: If you do not specify the account ID, the system derives the account ID using the account identifier type and account identifier combination.	No
Bill Cycle	Used to specify the bill cycle. Note: You must specify a valid bill cycle which is associated with the division to which the account belongs.	Yes

CSV File Format for Contract Rider Upload Request

Before uploading a contract rider file, you need to ensure that the CSV file contains the following columns:

Column Name	Description	Mandatory (Yes or No)
Account Identifier Type	Used to specify the account identifier type.	Yes (Conditional) Note: This data is required when the account ID and contract ID are not specified.
Account Identifier	Used to specify the identifier of the account whose contract you want to update.	Yes (Conditional) Note: This data is required when the account ID and contract ID are not specified.
Account ID	Used to indicate the account whose contract you want to update.	Yes (Conditional) Note: This data is required when the account identifier type, account identifier, and contract ID are not specified.
Contract Type	Used to indicate the type of the contract whose details you want to update. Note: You must specify a contract type which already exists in the system.	Yes (Conditional) Note: This data is required when the contract ID is not specified.
Contract ID	Used to indicate the contract whose contract rider information you want to update. Note: If you do not specify the contract ID, the system derives the active contract using the account ID and contract type combination.	No
Start Date	Used to specify the date from when the bill factor is effective for the contract. Note: The start date cannot be later than the end date.	Yes
End Date	Used to specify the date till when the bill factor is effective for the contract. Note: The end date cannot be earlier than the start date.	No
Bill Factor	Used to specify the bill factor.	Yes

Column Name	Description	Mandatory (Yes or No)
	Note: You must specify a valid bill factor where the Contract Rider Applicability flag is set to Y .	

CSV File Format for Billable Charge Upload

Before uploading a billable charge file, you need to ensure that the CSV file contains the following columns:

Column Name	Description	Mandatory (Yes or No)
Account Identifier Type	Used to specify the account identifier type.	Yes (Conditional) Note: This data is required when the Account ID is not specified.
Account Identifier	Used to specify the account identifier of the account for which you want to create the billable charge.	Yes (Conditional) Note: This data is required when the Account ID is not specified.
Account ID	Used to specify the account for which you want to create the billable charge.	Yes (Conditional) Note: This data is required when the Account Identifier Type and Account Identifier is not specified.
Contract ID	Used to specify the contract against which you want to create the billable charge.	Yes (Conditional) Note: This data is required when you want to create the billable charge against a specific contract on the account. If this data is not specified then billable charge is created against a contract with highest priority.
Start Date	Used to specify the start date of billable charge.	Yes
End Date	Used to specify the end date of billable charge.	Yes
Charge Type	Used to specify the charge type for which you want to create a billable charge.	No
Description On Bill	Used to specify description for a billable charge.	Yes
Recurring Flag	Used to indicate whether recurring bill segments must be created at the intervals defined in the bill period or at the set policy invoice frequency. The valid values are: <ul style="list-style-type: none"> BP 	Yes (Conditional) Note: This data is required if Frequency or Bill Period is specified.

Column Name	Description	Mandatory (Yes or No)
	<ul style="list-style-type: none"> FR 	
Frequency	Used to specify the invoice frequency at which the recurring bill segments must be created.	Yes (Conditional) Note: This data is required if Recurring Flag is FR.
Bill Period	Used to specify the bill period that you want to use for specifying the intervals at which the recurring bill segments must be created.	Yes (Conditional) Note: This data is required if Recurring Flag is BP.
Bill After	Used to specify the date after which the bill must be generated for the billable charge.	No
Adhoc Bill	Used to indicate whether the billable charge should be considered during adhoc or regular billing.	No
Description on Bill1, Description on Bill2,, Description on Bill5	Used to specify description for the billable charge lines.	Yes (Conditional) Note: This data is required when the charge amount is specified.
Currency1, Currency2,, Currency5	Used to specify the currency in which the amount is charged. Note: If you specify a currency other than the account's invoice currency, the system will do the currency conversion if the appropriate exchange rate is available in the system.	Yes (Conditional) Note: This data is required when the charge amount is specified.
Amount1, Amount2,, Amount5	Used to specify the charge amount.	Yes (Conditional) Note: This data is required when the description on bill or currency is specified.
Show On Bill1, Show on Bill2,, Show On Bill5	Used to indicate whether the charge should appear on the person's printed bill or not. The valid values are: <ul style="list-style-type: none"> true false Note: By default, the value will be set to true if the column does not contain any value.	No
Summary1, Summary2,, Summary5	Used to indicate whether the charge should be included in the summary line or not. The valid value are: <ul style="list-style-type: none"> true false Note: By default, the value will be set to true if the column does not contain any value.	No

Column Name	Description	Mandatory (Yes or No)
Memo Only1, Memo Only2,, Memo Only5	Used to indicate whether the charge should be included in the bill amount or not. The valid values are: <ul style="list-style-type: none"> true false 	No
	Note: By default, the value will be set to false if the column does not contain any value.	
GL Distribution Code1, GL Distribution Code2,, GL distribution Code5	Used to specify the distribution code which indicates the GL account associated with the charge.	Yes (Conditional)
		Note: This data is required when false is specified in the Memo Only column corresponding to the bill line description.
Price Item	Used to specify the price item code.	Yes (Conditional)
		Note: This data is required when Variance Parameter or, Price Item Parameter and Price Item Parameter Value is specified.
Variance Parameter	Used to indicate the variance that must be used along with the price item for determining the price item pricing.	Yes (Conditional)
		Note: This data is required when Price Item is specified and Price Item Parameter and Price Item Parameter Value are not specified.
Price Item Parameter1, Price Item Parameter2,, Price Item Parameter15	Used to indicate the price item parameter that must be used along with the price item for determining the price item pricing.	Yes (Conditional)
	Note: If the data in these columns will be used for price item parameter mapping, you must not use the equal to (=) and tilde (~) symbols in these columns.	Note: This data is required when Price Item is specified and Variance Parameter is not specified.
Price Item Parameter Value1, Price Item Parameter Value2,, Price Item Parameter Value15	Used to specify the parameter value.	Yes (Conditional)
	Note: If the data in these columns will be used for price item parameter mapping, you must not use the equal to (=) and tilde (~) symbols in these columns.	Note: This data is required when Price Item is specified and Variance Parameter is not specified.
SQI1, SQI2,, SQI5	Used to indicate the service quantity identifier that must be used for calculating the price item charges.	Yes (Conditional)
		Note: This data is required when the service quantity is specified.

Column Name	Description	Mandatory (Yes or No)
SQI Value1, SQI Value2,, SQI Value5	Used to specify the number of units of the service quantity.	Yes (Conditional) Note: This data is required when the SQI is specified.
Effective Date1, Effective Date2,, Effective Date20	Used to indicate the effective date of the characteristics.	Yes (Conditional) Note: This data is required when Char Type or Char Val is specified.
Char Type1, Char Type2,, Char Type20	Used to indicate the characteristic that must be defined for the billable charge.	Yes (Conditional) Note: This data is required when Effective Date or Char Val is specified.
Char Value1, Char Value2,, Char Value20	Used to specify the value of the characteristic type.	Yes (Conditional) Note: This data is required when Effective Date or Char Type is specified.

CSV File Format for Hold Upload Request

Before uploading a hold request file, you need to ensure that the CSV file contains the following columns:

Column Name	Description	Mandatory (Yes or No)
Hold Request Type	Used to specify the hold request type. Note: You must specify a valid hold request type which is in the Active status.	Yes
Start Date	Used to specify the date from when the hold request is effective. Note: The hold request start date cannot be later than the hold request end date.	Yes
End Date	Used to specify the date till when the hold request is effective. Note: The hold request end date cannot be earlier than the hold request start date.	Yes
Hold Reason	Used to indicate the reason why you want to hold the entity. Note: The hold reason must exist in the HOLD_REASON_FLG lookup field and its status must be Active .	Yes

Column Name	Description	Mandatory (Yes or No)
Hold Entity	Used to indicate the type of the entity for which you want to create the hold request. The valid values are: <ul style="list-style-type: none"> • ACCT • BILL • PERS 	Yes
Account Identifier Type	Used to specify the account identifier type.	Yes (Conditional) Note: This data is required when the hold entity is ACCT and the entity ID is not specified.
Account Identifier	Used to specify the identifier of the account for which you want to create the hold request.	Yes (Conditional) Note: This data is required when the hold entity is ACCT and the entity ID is not specified.
Person Identifier Type	Used to specify the person identifier type.	Yes (Conditional) Note: This data is required when the hold entity is PERS and the entity ID is not specified.
Person Identifier	Used to specify the identifier of the person for which you want to create the hold request.	Yes (Conditional) Note: This data is required when the hold entity is PERS and the entity ID is not specified.
Hold Entity ID	Used to specify the entity ID. Note: If the hold entity is ACCT , you must specify the account ID in this field. If the hold entity is PERS , you must specify the person ID in this field. And, if the hold entity is BILL , you must specify the bill ID in this field. If you do not specify the account ID, the system derives the account ID using the account identifier type and account identifier combination. Similarly, if you do not specify the person ID, the system derives the person ID using the person identifier type and person identifier combination.	Yes (Conditional) Note: This data is required when the hold entity is BILL .
Comments	Used to specify additional information about the hold request.	No
Hold Entity Start Date	Used to specify the date from when you want to hold the entity.	Yes

Column Name	Description	Mandatory (Yes or No)
	<p>Note:</p> <p>The hold entity start date must be between the hold request start and end dates and between at least one process's start and end dates.</p> <p>The hold entity start date cannot be later than the hold entity end date.</p>	
Hold Entity End Date	<p>Used to specify the date till when you want to hold the entity.</p> <p>Note:</p> <p>The hold entity end date must be between hold request start and end dates and between the process's start and end dates.</p> <p>The hold entity end date cannot be earlier than the hold entity start date.</p>	No
Hold Funding	<p>Used to indicate whether you want to hold the funding process for the entity. The valid values are:</p> <ul style="list-style-type: none"> • Y • N <p>Note: You can hold the funding process when the hold entity is PERS or BILL.</p>	No
Hold Funding Start Date	<p>Used to specify the date from when you want to hold the funding process.</p> <p>Note:</p> <p>The hold funding start date must be between the hold request start and end dates.</p> <p>The hold funding start date cannot be later than the hold funding end date.</p>	Yes (Conditional)
		Note: This data is required when the funding process must be kept on hold.
Hold Funding End Date	<p>Used to specify the date till when you want to hold the funding process.</p> <p>Note:</p> <p>The hold funding end date must be between the hold request start and end dates.</p> <p>The hold funding end date cannot be earlier than the hold funding start date.</p>	No
Hold Overdue	<p>Used to indicate whether you want to hold the overdue process for the entity. The valid values are:</p> <ul style="list-style-type: none"> • Y 	No

Column Name	Description	Mandatory (Yes or No)
	<ul style="list-style-type: none"> N 	
Hold Overdue Start Date	<p>Used to specify the date from when you want to hold the overdue process.</p> <p>Note: The hold overdue start date must be between the hold request start and end dates. The hold overdue start date cannot be later than the hold overdue end date.</p>	<p>Yes (Conditional)</p> <p>Note: This data is required when the overdue process must be kept on hold.</p>
Hold Overdue End Date	<p>Used to specify the date till when you want to hold the overdue process.</p> <p>Note: The hold overdue end date must be between the hold request start and end dates. The hold overdue end date cannot be earlier than the hold overdue start date.</p>	No
Hold Bill Generation	<p>Used to indicate whether you want to hold the bill generation process for the entity. The valid values are:</p> <ul style="list-style-type: none"> Y N 	No
Hold Bill Generation Start Date	<p>Used to specify the date from when you want to hold the bill generation process.</p> <p>Note: The hold bill generation start date must be between the hold request start and end dates. The hold bill generation start date cannot be later than the hold bill generation end date.</p>	<p>Yes (Conditional)</p> <p>Note: This data is required when the bill generation process must be kept on hold.</p>
Hold Bill Generation End Date	<p>Used to specify the date till when you want to hold the bill generation process.</p> <p>Note: The hold bill generation end date must be between the hold request start and end dates. The hold bill generation end date cannot be earlier than the hold bill generation start date.</p>	No
Hold Auto Pay	<p>Used to indicate whether you want to hold the automatic payment process for the entity. The valid values are:</p> <ul style="list-style-type: none"> Y 	No

Column Name	Description	Mandatory (Yes or No)
	<ul style="list-style-type: none"> N 	
Hold Autopay Start Date	<p>Used to specify the date from when you want to hold the automatic payment process.</p> <p>Note: The hold autopay start date must be between the hold request start and end dates. The hold autopay start date cannot be later than the hold autopay end date.</p>	<p>Yes (Conditional)</p> <p>Note: This data is required when the automatic payment process must be kept on hold.</p>
Hold Autopay End Date	<p>Used to specify the date till when you want to hold the automatic payment process.</p> <p>Note: The hold autopay end date must be between the hold request start and end dates. The hold autopay end date cannot be earlier than the hold autopay start date.</p>	No
Effective Date1, Effective Date2,, Effective Date5	Used to specify the date from when the characteristic is effective for the hold request.	<p>Yes (Conditional)</p> <p>Note: This data is required when the characteristic type or characteristic value is specified.</p>
Char Type1, Char Type2,, Char Type5	<p>Used to indicate the characteristic that must be defined for the hold request.</p> <p>Note: You must specify a characteristic type where the characteristic entity is set to Hold Request.</p>	<p>Yes (Conditional)</p> <p>Note: This data is required when the effective date or characteristic value is specified.</p>
Char Val1, Char Val2,, Char Val5	Used to specify the value for the characteristic type.	<p>Yes (Conditional)</p> <p>Note: This data is required when the effective date or characteristic type is specified.</p>

CSV File Format for Refund Request Upload

Before uploading a refund request file, you need to ensure that the CSV file contains the following columns:

Column Name	Description	Mandatory (Yes or No)
Refund Request Type	Used to specify the refund request type.	Yes

Column Name	Description	Mandatory (Yes or No)
Account Identifier Type	Used to specify the account identifier type.	Yes (Conditional) Note: This data is required when the Account ID is not specified.
Account Identifier	Used to specify the account identifier of the account for which you want to create the refund request.	Yes (Conditional) Note: This data is required when the Account ID is not specified.
Account ID	Used to specify the account for which you want to create the refund request.	Yes (Conditional) Note: This data is required when the Account Identifier Type and Account Identifier are not specified.
Entity Type	Used to specify the entity type.	Yes
Entity ID	Used to specify the entity ID.	Yes
Adjustment Type	Used to specify the adjustment type using which the refund adjustments are created.	No
Refund Amount	Used to specify the amount that you want to refund.	Yes
Comments	Used to specify the comments which are added on the refund request.	No
Effective Date1, Effective Date2,, Effective Date5	Used to indicate the effective date of the characteristics.	Yes (Conditional) Note: This data is required when Char Type or Char Val is specified.
Char Type1, Char Type2,, Char Type5	Used to indicate the characteristic that must be defined for the refund request.	Yes (Conditional) Note: This data is required when Effective Date or Char Val is specified.
Char Val1, Char Val2,, Char Val5	Used to specify the value of the characteristic type.	Yes (Conditional) Note: This data is required when Effective Date or Char Type is specified.

CSV File Format for Write Off Request Upload

Before uploading a write off request file, you need to ensure that the CSV file contains the following columns:

Column Name	Description	Mandatory (Yes or No)
Write Off Request Type	Used to specify the write off request type.	Yes
Account Identifier Type	Used to specify the account identifier type.	Yes (Conditional) Note: This data is required when the Account ID is not specified.
Account Identifier	Used to specify the account identifier of the account for which you want to create the write off request.	Yes (Conditional) Note: This data is required when the Account ID is not specified.
Account ID	Used to specify the account for which you want to create the write off request.	Yes (Conditional) Note: This data is required when the Account Identifier Type and Account Identifier are not specified.
Entity Type	Used to specify the entity type.	Yes
Entity ID	Used to specify the entity ID.	Yes
Adjustment Type	Used to specify the adjustment type using which the write off adjustments are created.	No
Write Off Amount	Used to specify the amount that you want to write off.	Yes
Comments	Used to specify the comments which are added on the write off request.	No
Effective Date1, Effective Date2,, Effective Date5	Used to indicate the effective date of the characteristics.	Yes (Conditional) Note: This data is required when Char Type or Char Val is specified.
Char Type1, Char Type2,, Char Type5	Used to indicate the characteristic that must be defined for the write off request.	Yes (Conditional) Note: This data is required when Effective Date or Char Val is specified.
Char Val1, Char Val2,, Char Val5	Used to specify the value of the characteristic type.	Yes (Conditional) Note: This data is required when Effective Date or Char Type is specified.

CSV File Format for Reinstatement Upload Request

Before uploading a policy reinstatement file, you need to ensure that the CSV file contains the following columns:

Column Name	Description	Mandatory (Yes or No)
Policy ID	Used to indicate the policy which you want to reinstate.	No
	Note: If you do not specify the policy ID, the system derives the policy ID using the source system and policy number combination.	
Source System	Used to indicate the external system from where the policy is originated.	Yes (Conditional)
		Note: This data is required when the policy ID is not specified.
Policy Number	Used to indicate the policy number.	Yes (Conditional)
		Note: This data is required when the policy ID is not specified.
Reinstatement Reason	Used to indicate the reason why you want to reinstate the policy.	Yes
	Note: You must specify a reason which is defined for the status specified in the Policy Reinstatement Status for Reason Verification parameter of the C1-REN-VALID algorithm.	

CSV File Format for Bill Group Sorting Upload Request

Before uploading a bill group sorting file, you need to ensure that the CSV file contains the following values in the specified order separated by a comma:

Sr. No.	Value	Description	Mandatory (Yes or No)
1	Bill Group ID	Used to indicate the bill group (i.e. person) for whom you want to define the sort ID.	Yes (Conditional)
		Note: You must specify an effective child person of the parent customer for whom you are creating the bill group sorting upload request. In addition, note that you must specify a child person whose person type is set to Bill Group and who is related to the parent customer using a relationship type which is specified in the Person Relationship Type option type of the C1-ASOBLNG feature configuration.	Note: This data is required when the bill group (i.e. person) identifier type and bill group (i.e. person) identifier are not specified.
2	Bill Group Identifier Type	Used to specify the bill group (i.e. person) identifier type.	Yes (Conditional)
			Note: This data is required when the bill group (i.e. person) ID is not specified.

Sr. No.	Value	Description	Mandatory (Yes or No)
3	Bill Group Identifier	Used to specify identifier of the bill group (i.e. person) for whom you want to define the sort ID.	Yes (Conditional)
			Note: This data is required when the bill group (i.e. person) ID is not specified.
4	Sort ID	Used to specify the sort ID.	Yes
5	Description	Used to specify the description for the sort ID.	Yes
6	Start Date	Used to specify the date from when the sort ID is effective for the bill group.	Yes
		Note: The start date cannot be later than the end date.	
7	End Date	Used to specify the date till when the sort ID is effective for the bill group.	No
		Note: The end date cannot be earlier than the start date.	

CSV File Format for Bill Group Derivation and Pricing Parameters Upload Request

Before uploading a bill group derivation and pricing parameters file, you need to ensure that the CSV file contains the following values in the specified order separated by a comma:

Sr. No.	Value	Description	Mandatory (Yes or No)
1	Source System	Used to indicate the source system from where the claim and enrollment transactions are received.	Yes
		Note: You must specify a source system which already exists in the extendable lookup which is specified in the Source System Extendable Lookup parameter of the C1-BLVLVALID algorithm.	
2	Parameter 1	Used to specify the employee attribute based on which you want to derive the bill group.	Yes
		Note: You must not specify the ampersand (&) character in the parameter 1.	
3	Parameter 2	Used to specify the employee attribute based on which you want to derive the bill group.	No
		Note: You must not specify the ampersand (&) character in the parameter 2.	
4	Parameter 3	Used to specify the employee attribute based on which you want to derive the bill group.	No

Sr. No.	Value	Description	Mandatory (Yes or No)
		Note: You must not specify the ampersand (&) character in the parameter 3.	
5	Parameter 4	Used to specify the employee attribute based on which you want to derive the bill group. Note: You must not specify the ampersand (&) character in the parameter 4.	No
6	Effective Date	Used to specify the date from when the derivation and pricing parameters are effective for the bill group and sort ID combination. Note: The effective date must be within the date range of the sort ID defined for the bill group.	Yes
7	Bill Group ID	Used to indicate the bill group (i.e. person) for whom you want to define the derivation and pricing parameters. Note: You must specify an effective child person of the parent customer for whom you are creating the bill group derivation and pricing parameters upload request. In addition, note that you must specify a child person whose person type is set to Bill Group and who is related to the parent customer using a relationship type which is specified in the Person Relationship Type option type of the C1-ASOBLNG feature configuration.	Yes (Conditional) Note: This data is required when the bill group (i.e. person) identifier type and bill group (i.e. person) identifier are not specified.
8	Bill Group Identifier Type	Used to specify the bill group (i.e. person) identifier type.	Yes (Conditional) Note: This data is required when the bill group (i.e. person) ID is not specified.
9	Bill Group Identifier	Used to specify identifier of the bill group (i.e. person) for whom you want to define the derivation and pricing parameters.	Yes (Conditional) Note: This data is required when the bill group (i.e. person) ID is not specified.
10	Sort ID	Used to indicate the sort ID of the bill group for which you want to define the derivation and pricing parameters.	Yes

Upload Request Type

Oracle Revenue Management and Billing allows you to define an upload request type using which you can upload a file. An upload request of the specified upload request type is created on uploading the file. It is the upload request type which helps the system to understand how to process the file. If you upload a file which exceeds the maximum file size, the system will not allow you to upload the file.

The **Adjustment Upload Request Type (C1-AdjRequestType)** business object is used for the maintenance of upload request types for uploading CSV data. Configurations like upload file size, approval workflow can be configured using this object. If you are going to upload adjustment data files using an upload request type, you need to specify the match types (using which the adjustments must be created) in the upload request type. At present, the following two match types are shipped with the product:

- Contract
- Contract Type

You can also define custom match types, if required. You must use the **ADJ_MATCH_TYPE** lookup field to add a new match type. You need to attach an algorithm to each match type to determine the contract against which the adjustment must be created. At present, the following algorithm types and sample algorithms are shipped with the product:

Match Type	Algorithm Type	Sample Algorithm	Algorithm Description
Contract	C1-MTCIALG	C1-MTCIALG	This algorithm fetches contract ID for each adjustment record where the match type is set to Contract (CONT) .
Contract Type	C1-MTCTALG	C1-MTCTALG	This algorithm fetches contract ID based on the contract type and account ID for each adjustment record where the match type is set to Contract Type (CNTY) . If there are multiple active contracts of the specified contract type on the account, the contract ID with the latest start date will be fetched.

The **Upload Request Type (C1-UplRequestType)** business object will be used for the maintenance of upload request types for uploading CSV data. Configurations like upload file size, approval workflow can be configured using this object. The system enables you to upload data for the following using the **Upload Request** feature:

- Billable Charge (Adhoc and Regular)
- Hold Request
- Refund Request
- Write Off Request
- Policy Reinstatement
- Bill Group Sort ID
- Derivation and Pricing Parameters for a Bill Group and Sort ID Combination

It also enables you to update the following information:

- Contract rider of a contract
- Bill cycle of an account

It is the upload request type which helps the system to determine:

- Whether the file must be approved by the approver before creating or updating the entities
- Which business object must be used for creating the upload request
- Which business object must be used for creating or updating entities through an upload request
- Which foreign key reference must be used for generating information string for the entity

- A set of fields using which you can search records uploaded through an upload request

You can also define custom algorithm types and algorithms, if required. The **Upload Request Type** screen allows you to define, edit, copy, and delete an upload request type. This screen consists of the following zones:

- [Upload Request Type List](#) on page 1388
- [Upload Request Type](#) on page 1389

Upload Request Type List

The **Upload Request Type List** zone lists upload request types that are already defined in the system. It contains the following columns:

Column Name	Column Description
Upload Request Type	Displays the upload request type.
Description	Displays the description of the upload request type.
Edit	On clicking the Edit (✎) icon, the Upload Request Type screen appears where you can edit the details of the upload request type.
Duplicate	On clicking the Duplicate (📄) icon, the Upload Request Type screen appears where you can define an upload request type using an existing upload request type.
Delete	On clicking the Delete (🗑) icon, you can delete the upload request type.
	Note: You can delete an upload request type when you have not uploaded a file (i.e. created an upload request) using the upload request type.
Mapping	On clicking the Mapping (🔗) icon, the mapping screen appears where you can map the columns of CSV file with the upload request type.

On clicking the **Broadcast** (📡) icon corresponding to an upload request type, the **Upload Request Type** zone appears with the details of the respective upload request type.

Related Topics

For more information on...	See...
How to define an upload request type	Defining an Upload Request Type on page 1392
How to define a characteristic for an upload request type	Defining a Characteristic for an Upload Request Type on page 1397
How to edit an upload request type	Editing an Upload Request Type on page 1398
How to copy an upload request type	Copying an Upload Request Type on page 1401
How to delete an upload request type	Deleting an Upload Request Type on page 1406
How to map an upload request type	Mapping an Upload Request Type on page 1405
How to view the details of an upload request type	Viewing the Upload Request Type Details on page 1407

Upload Request Type

The **Upload Request Type** zone displays the details of the upload request type. This zone contains the following sections:

- **Main** – This section provides basic information about the upload request type. It contains the following fields:

Field Name	Field Description
Upload Request Type	Displays the upload request type.
Upload Request Business Object	<p>Indicates the business object that will be used to create the upload request. In addition, a context menu appears corresponding to this field which helps in navigating to other screens in the application.</p> <p>Note: It has a link. On clicking the link, the Business Object screen appears where you can view the details of the respective business object.</p>
Description	Displays the description of the upload request type.
Detailed Description	Displays additional information about the upload request type.
Status	<p>Indicates the status of the upload request type. The valid values are:</p> <ul style="list-style-type: none"> • Active • Inactive
File Size (KB)	<p>Displays the maximum size of file (in kilobytes) that you can upload using the upload request type. If you upload a file which exceeds the maximum file size, the system will not allow you to upload the file.</p> <p>Note: This field appears when you create upload request type using Adjustment Upload Request Type business object.</p>
Defer Algorithm	<p>Indicates the algorithm that will be triggered when you create entities (for example, adjustments) or approve the uploaded file (for example, adjustment data file). This algorithm checks whether the number of records in the uploaded file exceeds the online record process limit. If the number of records in the uploaded file does not exceed the online record process limit, the system creates the entities in the real time (i.e. immediately). However, if the number of records in the uploaded file exceeds the online record process limit, the system creates the entities (for example, adjustments) in the real time (i.e. immediately). However, if the number of records in the uploaded file exceeds the online record process limit, the system creates the entities (for example, adjustments) in the deferred mode.</p>

Field Name	Field Description
	<p>Note:</p> <p>This field appears when you create upload request type using Adjustment Upload Request Type business object.</p> <p>It has a link. On clicking the link, the Algorithm screen appears where you can view the details of the respective algorithm.</p> <p>In Upload Request Type, online and deferred mode is used for processing the file if approval is not required. The defer algorithm is invoked if the number of records to be processed on the respective business object is more than the count specified on the algorithm then the status for number of records is changed from Validated to Deferred Processing else the status is changed to Processed.</p>
Approval Required	Indicates whether approval is required for a file which is uploaded using the upload request type.
Approval To Do Type	<p>Indicates that the To Do entry of the specified To Do type must be created when you submit the upload request for approval.</p> <p>Note:</p> <p>This field appears when the Approval Required check box is selected.</p> <p>It has a link. On clicking the link, the To Do Type screen appears with the details of the respective To Do type.</p>
Approval To Do Role	<p>Indicates that users with the specified To Do role can only approve or reject the upload request submitted for approval.</p> <p>Note:</p> <p>This field appears when the Approval Required check box is selected.</p> <p>On selecting the To Do Type, the To Do Roles configured on the To Do Type is populated.</p> <p>It has a link. On clicking the link, the To Do Role screen appears with the details of the respective To Do role.</p>
FK Reference	<p>Indicates the foreign key reference which specifies the created upload request type.</p> <p>Note:</p> <p>This field appears when you create upload request type using Upload Request Type business object.</p> <p>It has a link. On clicking the link, the Foreign Key Reference screen appears with the details of the respective foreign key.</p>

In addition, this section has the following columns:

Column Name	Column Description
Match Type	Indicates the match type using which the adjustments must be created when you upload a file using the upload request type. The valid values are:

Column Name	Column Description
	<ul style="list-style-type: none"> Contract Contract Type
	Note: The Match Type column is displayed for Adjustment Upload Request Business Object.
Algorithm	Indicates the algorithm that will be triggered when you upload an adjustment data file. This algorithm determines the contract against which the adjustment must be created.
	Note: It has a link. On clicking the link, the Algorithm screen appears with the details of the respective algorithm. The Algorithm column is displayed for Adjustment Upload Request Business Object.

- **Characteristics** – This section lists the characteristics of the upload request type. It contains the following columns:

Column Name	Column Description
Characteristic Type	Indicates the characteristic type.
Characteristic Value	Displays the value of the characteristic type.

- **Record Actions** – This section contains the following buttons:

Button Name	Button Description
Edit	Used to edit the details of the upload request type.
Delete	Used to delete the upload request type.
	Note: You can delete an upload request type when you have not uploaded a file (i.e. created an upload request) using the upload request type.
Duplicate	Used to create a new upload request type using an existing upload request type.

- **Record Information** – This section contains the following fields:

Field Name	Field Description
Business Object	Indicates the business object using which the upload request type is created. In addition, a context menu appears corresponding to this field which helps in navigating to other screens in the application.
	Note: It has a link. On clicking the link, the Business Object screen appears where you can view the details of the respective business object.

By default, the **Upload Request Type** zone does not appear in the **Upload Request Type** screen. It appears when you click the **Broadcast** () icon corresponding to an upload request type in the **Upload Request Type List** zone.

Related Topics

For more information on...	See...
How to define an upload request type	Defining an Upload Request Type on page 1392

For more information on...	See...
How to define a characteristic for an upload request type	Defining a Characteristic for an Upload Request Type on page 1397
How to edit an upload request type	Editing an Upload Request Type on page 1398
How to copy an upload request type	Copying an Upload Request Type on page 1401
How to delete an upload request type	Deleting an Upload Request Type on page 1406
How to map an upload request type	Mapping an Upload Request Type on page 1405
How to view the details of an upload request type	Viewing the Upload Request Type Details on page 1407

Defining an Upload Request Type

Prerequisites

To define an upload request type, you should have:

- Upload request business objects defined in the application
- Defer algorithm for adjustment is defined using the **C1-UPLDEFEVL** algorithm type
- Defer algorithm for upload is defined using the **C1-DEFERUPLD** algorithm type
- Algorithm defined using the **C1-MTCIALG** algorithm type when you want to create adjustment using the **Contract** match type
- **C1-ADJUP** To Do type assigned to a To Do role whose users must receive To Do while submitting an adjustment upload request for approval
- **C1-BCUUR** To Do type assigned to a To Do role whose users must receive To Do while submitting a bill cycle update upload request for approval
- **C1-CRUUR** To Do type assigned to a To Do role whose users must receive To Do while submitting a contract rider update upload request for approval
- **C1-HLDUR** To Do type assigned to a To Do role whose users must receive To Do while submitting a hold upload request for approval
- **C1-REFUR** To Do type assigned to a To Do role whose users must receive To Do while submitting a refund upload request for approval
- **C1-WOUR** To Do type assigned to a To Do role whose users must receive To Do while submitting a write off upload request for approval
- **C1-BCUR** To Do type assigned to a To Do role whose users must receive To Do while submitting a billable charge upload request for approval
- **C1-RPUR** To Do type assigned to a To Do role whose users must receive To Do while submitting a reinstatement upload request for approval
- **C1-BGSRT** To Do type assigned to a To Do role whose users must receive To Do while submitting a bill group sorting upload request for approval
- **C1-BGDVP** To Do type assigned to a To Do role whose users must receive To Do while submitting a bill group derivation and pricing parameters upload request for approval

Procedure

To define an upload request type:

1. Click the **Admin** link in the **Application** toolbar.
A list appears.
2. From the **Admin** menu, select **U** and then click **Upload Request Type**.
A sub-menu appears.
3. Click the **Add** option from the **Upload Request Type** sub-menu.

The **Select Business Object** screen appears. It contains the following field:

Field Name	Field Description	Mandatory (Yes or No)
Upload Request Type Business Object	Used to indicate the business object that you want to use to create the upload request type.	Yes

Tip: Alternatively, you can access the **Select Business Object** screen by clicking the **Add** button in the **Page Title** area of the **Upload Request Type** screen.

Note: The **Select Business Object** screen appears when there are multiple upload request type business objects defined in the application. If there is only one upload request type business object defined in the application, the **Upload Request Type** screen appears.

4. Select the required upload request type business object from the respective field.
5. Click **OK**.

The **Upload Request Type** screen appears. It contains the following sections:

- **Main** – Used to specify basic details about the upload request type.
- **Characteristics** – Used to define the characteristics for the upload request type.

The **Main** section contains the following fields:

Field Name	Field Description	Mandatory (Yes or No)
Upload Request Type	Used to specify the upload request type.	Yes
Upload Request Type Business Object	Indicates the upload request type business object used while defining the upload request type.	Not applicable
Upload Request Business Object	Used to indicate the business object that you want to use while creating the upload request.	Yes
Description	Used to specify the description for the upload request type.	Yes
Detailed Description	Used to specify additional information about the upload request type.	No
Status	Used to indicate the status of the upload request type. The valid values are: <ul style="list-style-type: none"> • Active • Inactive 	Yes
File Size (KB)	Used to specify the maximum size of file (in kilobytes) that you can upload using the upload request type. If you upload a file which exceeds the maximum file size, the system will not allow you to upload the file.	Yes

Field Name	Field Description	Mandatory (Yes or No)
	<p>Note: This field appears when Adjustment Upload Request Type business object is selected.</p>	
Defer Algorithm	<p>Used to attach an algorithm that will be triggered when you create entities (for example, adjustments) or approve the uploaded file (for example, adjustment data file). This algorithm checks whether the number of records in the uploaded file exceeds the online record process limit (defined in the Defer algorithm). If the number of records in the uploaded file does not exceed the online record process limit, the system creates the entities (for example, adjustments) in the real time (i.e. immediately). However, if the number of records in the uploaded file exceeds the online record process limit, the system creates the entities (for example, adjustments) in the deferred mode.</p> <p>Note:</p> <p>Deferred mode means in the background when the Upload Request Periodic Monitor (C1-UPLRQ) batch is invoked. You can configure the Upload Request Periodic Monitor (C1-UPLRQ) batch such that it is executed at regular intervals. When the Upload Request Periodic Monitor (C1-UPLRQ) batch is invoked, the system checks whether there are any upload requests in the Deferred status. If there is an upload request in the Deferred status, the system creates the entities (for example, adjustments).</p> <p>This field appears when Adjustment Upload Request Type business object is selected.</p> <p>In Upload Request Type, online and deferred mode is used for processing the file if approval is not required. The defer algorithm is invoked if the number of records to be processed on the respective business object is more than the count specified on the algorithm then the status for number of records is changed from Validated to Deferred Processing else the status is changed to Processed.</p> <p>Note: The Search (🔍) icon appears corresponding to this field. On clicking the Search icon, the Algorithm Search window appears.</p>	Yes
Entity Business Object	Used to indicate for creating Business Object of the entity using the upload request type.	No

Field Name	Field Description	Mandatory (Yes or No)																						
	<p>Note:</p> <p>The Search (🔍) icon appears corresponding to this field. On clicking the Search icon, the Business Object Search window appears.</p> <p>This field appears when Upload Request Type business object is selected.</p>																							
Approval Required	Used to indicate whether approval is required for a file which is uploaded using the upload request type.	No																						
Approval To Do Type	<p>Used to indicate that To Do entry of the specified To Do type must be created when you submit the upload request for approval.</p> <p>Note:</p> <p>The Search (🔍) icon appears corresponding to this field. On clicking the Search icon, the To Do Type Search window appears.</p> <p>The following table lists the To Do type using which the To Do must be generated for the different upload requests:</p> <table border="1"> <thead> <tr> <th>Upload Request</th> <th>To Do Type</th> </tr> </thead> <tbody> <tr> <td>Adjustment</td> <td>C1-ADJUP</td> </tr> <tr> <td>Bill Cycle Update</td> <td>C1-BCUUR</td> </tr> <tr> <td>Billable Charge</td> <td>C1-BCUR</td> </tr> <tr> <td>Contract Rider Update</td> <td>C1-CRUUR</td> </tr> <tr> <td>Hold Request</td> <td>C1-HLDUR</td> </tr> <tr> <td>Refund Request</td> <td>C1-REFUR</td> </tr> <tr> <td>Write Off Request</td> <td>C1-WOUR</td> </tr> <tr> <td>Policy Reinstatement</td> <td>C1-RPUR</td> </tr> <tr> <td>Bill Group Sorting</td> <td>C1-BGSRT</td> </tr> <tr> <td>Bill Group Derivation and Pricing Parameters</td> <td>C1-BGDVP</td> </tr> </tbody> </table>	Upload Request	To Do Type	Adjustment	C1-ADJUP	Bill Cycle Update	C1-BCUUR	Billable Charge	C1-BCUR	Contract Rider Update	C1-CRUUR	Hold Request	C1-HLDUR	Refund Request	C1-REFUR	Write Off Request	C1-WOUR	Policy Reinstatement	C1-RPUR	Bill Group Sorting	C1-BGSRT	Bill Group Derivation and Pricing Parameters	C1-BGDVP	<p>Yes (Conditional)</p> <p>Note: This field is required when the Approval Required check box is selected.</p>
Upload Request	To Do Type																							
Adjustment	C1-ADJUP																							
Bill Cycle Update	C1-BCUUR																							
Billable Charge	C1-BCUR																							
Contract Rider Update	C1-CRUUR																							
Hold Request	C1-HLDUR																							
Refund Request	C1-REFUR																							
Write Off Request	C1-WOUR																							
Policy Reinstatement	C1-RPUR																							
Bill Group Sorting	C1-BGSRT																							
Bill Group Derivation and Pricing Parameters	C1-BGDVP																							
Approval To Do Role	Used to indicate that users with the specified To Do role can only approve the upload request submitted for approval.	<p>Yes (Conditional)</p> <p>Note: This field is required when the Approval Required check box is selected.</p>																						
FK Reference	Used to indicate the FK Reference code to display the entity information.	No																						

Field Name	Field Description	Mandatory (Yes or No)
	<p>Note:</p> <p>The Search (🔍) icon appears corresponding to this field. On clicking the Search icon, the Foreign Key Search window appears.</p> <p>This field appears when Upload Request Type business object is selected.</p>	

In addition, this section contains the following fields in the grid:

Note: This field appears when **Adjustment Upload Request Type** business object is selected.

Field Name	Field Description	Mandatory (Yes or No)
Match Type	<p>Used to indicate the match type using which you want to create adjustments when you upload a file using the upload request type. The valid values are:</p> <ul style="list-style-type: none"> • Contract • Contract Type 	<p>Yes (Conditional)</p> <p>Note: This field is required when you select the Adjustment Upload Request option from the Upload Request Business Object list.</p>
Algorithm	<p>Used to attach an algorithm that will be triggered when you upload an adjustment data file. This algorithm determines the contract against which the adjustment must be created.</p> <p>Note: The Search (🔍) icon appears corresponding to this field. On clicking the Search icon, the Algorithm Search window appears.</p>	<p>Yes (Conditional)</p> <p>Note: This field is required when you select the match type from the respective field.</p>

6. Enter the required details.

Note:

You can search for an algorithm by clicking the **Search** (🔍) icon corresponding to the respective field.

If you want to associate more than one match type with the upload request type, click the **Add** (+) icon and then specify the details. However, if you want to remove a match type from the upload request type, click the **Delete** (🗑️) icon corresponding to the match type.

7. Define characteristics for the upload request type, if required.

8. Click **Save**.

The upload request type is defined.

Related Topics

For more information on...	See...
Upload Request Type screen	Upload Request Type on page 1387
Upload Request Type List zone	Upload Request Type List on page 1388

For more information on...	See...
How to define a characteristic for an upload request type	Defining a Characteristic for an Upload Request Type on page 1397

Defining a Characteristic for an Upload Request Type

Prerequisites

To define a characteristic for an upload request type, you should have:

- Characteristic types defined in the application (where the characteristic entity is set to Upload Request Type)

Procedure

To define a characteristic for an upload request type:

1. Ensure that the **Characteristics** section is expanded when you are defining, editing, or copying an upload request type.

The **Characteristics** section contains the following fields:

Field Name	Field Description	Mandatory (Yes or No)
Characteristic Type	Used to indicate the characteristic type.	Yes (Conditional)
	Note: The list includes only those characteristic types where the characteristic entity is set to Upload Request Type.	Note: This field is required when you are defining a characteristic for the upload request type.
Characteristic Value	Used to specify the value for the characteristic type.	Yes (Conditional)
	Note: On specifying the value for a predefined characteristic type, the description of the characteristic value appears corresponding to the Characteristic Value field.	Note: This field is required when you are defining a characteristic for the upload request type.

2. Enter the required details.

Note: If you select a predefined characteristic type, the **Search** (🔍) icon appears corresponding to the **Characteristic Value** field. On clicking the **Search** icon, you can search for a predefined characteristic value.

3. If you want to define more than one characteristic for the upload request type, click the **Add** (+) icon and then repeat step 2.

Note: However, if you want to remove a characteristic from the upload request type, click the **Delete** (🗑️) icon corresponding to the characteristic.

Related Topics

For more information on...	See...
How to define an upload request type	Defining an Upload Request Type on page 1392
How to edit an upload request type	Editing an Upload Request Type on page 1398

For more information on...	See...
How to copy an upload request type	Copying an Upload Request Type on page 1401

Editing an Upload Request Type

Prerequisites

To edit an upload request type, you should have:

- Upload request business objects defined in the application
- Defer algorithm for adjustment is defined using the **C1-UPLDEFEVL** algorithm type
- Defer algorithm for upload is defined using the **C1-DEFERUPLD** algorithm type
- Algorithm defined using the **C1-MTCIALG** algorithm type when you want to create adjustment using the Contract match type
- Algorithm defined using the **C1-MTCTALG** algorithm type when you want to create adjustment using the Contract Type match type
- **C1-ADJUP** To Do type assigned to a To Do role whose users must receive To Do entries generated while submitting an adjustment upload request for approval
- **C1-UPLAPPENT** To Do type assigned to a To Do role whose users must receive To Do generated while submitting an upload request for approval

Procedure

To edit an upload request type:

1. Click the **Admin** link in the **Application** toolbar.
A list appears.
2. From the **Admin** menu, select **U** and then click **Upload Request Type**.
A sub-menu appears.
3. In the **Upload Request Type List** zone, click the **Edit**  icon in the **Edit** column corresponding to the upload request type whose details you want to edit.

The **Upload Request Type** screen appears. It contains the following sections:

- **Main** – Used to specify basic details about the upload request type.
- **Characteristics** – Used to define the characteristics for the upload request type.

The **Main** section contains the following fields:

Field Name	Field Description	Mandatory (Yes or No)
Upload Request Type	Displays the upload request type.	Not applicable
Upload Request Type Business Object	Indicates the upload request type business object used while defining the upload request type.	Not applicable
Upload Request Business Object	Used to specify the business object that you want to use while creating the upload request.	Yes
Description	Used to specify the description for the upload request type.	Yes
Detailed Description	Used to specify additional information about the upload request type.	No

Field Name	Field Description	Mandatory (Yes or No)
Status	Used to indicate the status of the upload request type. The valid values are: <ul style="list-style-type: none"> Active Inactive 	Yes
File Size (KB)	Used to specify the maximum size of file (in kilobytes) that you can upload using the upload request type. If you upload a file which exceeds the maximum file size, the system will not allow you to upload the file.	Yes
	Note: This field appears when the business object is Adjustment Upload Request Type .	
Defer Algorithm	Used to attach an algorithm that will be triggered when you create entities (for example, adjustments) or approve the uploaded file (for example, adjustment data file). This algorithm checks whether the number of records in the uploaded file exceeds the online record process limit (defined in the Defer algorithm). If the number of records in the uploaded file does not exceed the online record process limit, the system creates the entities (for example, adjustments) in the real time (i.e. immediately). However, if the number of records in the uploaded file exceeds the online record process limit, the system creates the entities (for example, adjustments) in the deferred mode.	Yes
	Note: Deferred mode means in the background when the Upload Request Periodic Monitor (C1-UPLRQ) batch is invoked. You can configure the Upload Request Periodic Monitor (C1-UPLRQ) batch such that it is executed at regular intervals. When the Upload Request Periodic Monitor (C1-UPLRQ) batch is invoked, the system checks whether there are any upload requests in the Deferred status. If there is an upload request in the Deferred status, the system creates the entities (for example, adjustments). This field appears when the business object is Adjustment Upload Request Type .	
Entity Business Object	Used to indicate for creating Business Object of the entity using the upload request type.	No

Field Name	Field Description	Mandatory (Yes or No)
	Note: The Search (🔍) icon appears corresponding to this field. On clicking the Search icon, the Business Object Search window appears.	
Approval Required	Used to indicate whether approval is required for a file which is uploaded using the upload request type.	No
Approval To Do Type	Used to indicate that To Do entry of the specified To Do type must be created when you submit the upload request for approval. Note: The Search (🔍) icon appears corresponding to this field. On clicking the Search icon, the To Do Type Search window appears.	Yes (Conditional) Note: This field is required when the Approval Required check box is selected.
Approval To Do Role	Used to indicate that users with the specified To Do role can only approve the upload request submitted for approval.	Yes (Conditional) Note: This field is required when the Approval Required check box is selected.
FK Reference	Used to indicate the FK Reference code to display the entity information. Note: The Search (🔍) icon appears corresponding to this field. On clicking the Search icon, the Foreign Key Search window appears. This field appears when the business object is Upload Request Type .	No

In addition, this section contains the following fields in the grid:

Note: The below section appears when the business object is **Adjustment Upload Request Type**.

Field Name	Field Description	Mandatory (Yes or No)
Match Type	Used to indicate the match type using which you want to create adjustments when you upload a file using the upload request type. The valid values are: <ul style="list-style-type: none"> Contract Contract Type 	Yes (Conditional) Note: This field is required when you select the Adjustment Upload Request option from the Upload Request Business Object list.
Algorithm	Used to attach an algorithm that will be triggered when you upload an adjustment data file. This	Yes (Conditional)

Field Name	Field Description	Mandatory (Yes or No)
	algorithm determines the contract against which the adjustment must be created.	Note: This field is required when you select the match type from the respective field.

Tip: Alternatively, you can click the **Edit** button in the **Upload Request Type** zone to edit the details of the upload request type.

4. Modify the required details.

Note:

You can search for an algorithm by clicking the **Search** (🔍) icon corresponding to the respective field.

If you want to associate more than one match type with the upload request type, click the **Add** (+) icon and then specify the details. However, if you want to remove a match type from the upload request type, click the **Delete** (🗑️) icon corresponding to the match type.

5. Define, edit, or remove characteristics of the upload request type, if required.

6. Click **Save**.

The changes made to the upload request type are saved.

Related Topics

For more information on...	See...
Upload Request Type screen	Upload Request Type on page 1387
Upload Request Type List zone	Upload Request Type List on page 1388
Upload Request Type zone	Upload Request Type on page 1389
How to define a characteristic for an upload request type	Defining a Characteristic for an Upload Request Type on page 1397

Deleting an Upload Request Type

Procedure

To delete an upload request type:

1. Click the **Admin** link in the **Application** toolbar.
A list appears.
2. From the **Admin** menu, select **U** and then click **Upload Request Type**.
A sub-menu appears.
3. In the **Upload Request Type List** zone, click the **Delete** (🗑️) icon in the **Delete** column corresponding to the upload request type that you want to delete.

A message appears confirming whether you want to delete the upload request type.

Note: You can delete an upload request type when you have not uploaded a file (i.e. created an upload request) using the upload request type.

Tip: Alternatively, you can click the **Delete** button in the **Upload Request Type** zone to delete the upload request type.

4. Click **OK**.

The upload request type is deleted.

Related Topics

For more information on...	See...
Upload Request Type screen	Upload Request Type on page 1387
Upload Request Type List zone	Upload Request Type List on page 1388
Upload Request Type zone	Upload Request Type on page 1389

Copying an Upload Request Type

Instead of creating an upload request type from scratch, you can create a new upload request type using an existing upload request type. This is possible through copying an upload request type. On copying an upload request type, the details including the match types (only for adjustments) and characteristics are copied to the new upload request type. You can then edit the details, if required.

Prerequisites

To copy an upload request type, you should have:

- Upload request type (whose copy you want to create) defined in the application
- Upload request business objects defined in the application
- Defer algorithm defined using the **C1-UPLDEFEV** algorithm type
- Defer algorithm for upload is defined using the **C1-DEFERUPLD** algorithm type
- Algorithm defined using the **C1-MTCIALG** algorithm type when you want to create adjustment using the Contract match type
- Algorithm defined using the **C1-MTCTALG** algorithm type when you want to create adjustment using the Contract Type match type
- **C1-ADJUP** To Do type assigned to a To Do role whose users must receive To Do entries generated while submitting an upload request for approval
- **C1-UPLAPPENT** To Do type assigned to a To Do role whose users must receive To Do generated while submitting an upload request for approval

Procedure

To copy an upload request type:

1. Click the **Admin** link in the **Application** toolbar.
A list appears.
2. From the **Admin** menu, select **U** and then click **Upload Request Type**.
A sub-menu appears.
3. In the **Upload Request Type List** zone, click the **Duplicate**  icon in the **Duplicate** column corresponding to the upload request type whose copy you want to create.

The **Upload Request Type** screen appears. It contains the following sections:

- **Main** – Used to specify basic details about the upload request type.
- **Characteristics** – Used to define the characteristics for the upload request type.

The **Main** section contains the following fields:

Field Name	Field Description	Mandatory (Yes or No)
Upload Request Type	Used to specify the upload request type.	Yes
Upload Request Type Business Object	Indicates the upload request type business object used while defining the upload request type (whose copy you want to create).	Not applicable
Upload Request Business Object	Used to specify the business object that you want to use while creating the upload request.	Yes
Description	Used to specify the description for the upload request type.	Yes
Detailed Description	Used to specify additional information about the upload request type.	No
Status	Used to indicate the status of the upload request type. The valid values are: <ul style="list-style-type: none"> • Active • Inactive 	Yes
File Size (KB)	Used to specify the maximum size of file (in kilobytes) that you can upload using the upload request type. If you upload a file which exceeds the maximum file size, the system will not allow you to upload the file.	Yes
	Note: This field appears when the business object is Adjustment Upload Request Type .	
Defer Algorithm	Used to attach an algorithm that will be triggered when you create entities (for example, adjustments) or approve the uploaded file (for example, adjustment data file). This algorithm checks whether the number of records in the uploaded file exceeds the online record process limit (defined in the Defer algorithm). If the number of records in the uploaded file does not exceed the online record process limit, the system creates the entities (for example, adjustments) in the real time (i.e. immediately). However, if the number of records in the uploaded file exceeds the online record process limit, the system creates the entities (for example, adjustments) in the deferred mode.	Yes

Field Name	Field Description	Mandatory (Yes or No)
	<p>Note:</p> <p>Deferred mode means in the background when the Upload Request Periodic Monitor (C1-UPLRQ) batch is invoked. You can configure the Upload Request Periodic Monitor (C1-UPLRQ) batch such that it is executed at regular intervals. When the Upload Request Periodic Monitor (C1-UPLRQ) batch is invoked, the system checks whether there are any upload requests in the Deferred status. If there is an upload request in the Deferred status, the system creates the entities (for example, adjustments).</p> <p>This field appears when the business object is Adjustment Upload Request Type.</p>	
Entity Business Object	<p>Used to indicate to create the copy of Business Object of the entity using the upload request type.</p> <p>Note:</p> <p>The Search (🔍) icon appears corresponding to this field. On clicking the Search icon, the Business Object Search window appears.</p> <p>This field appears when the business object is Upload Request Type.</p>	No
Approval Required	Used to indicate whether approval is required for a file which is uploaded using the upload request type.	No
Approval To Do Type	<p>Used to indicate that To Do entry of the specified To Do type must be created when you submit the upload request for approval.</p> <p>Note: The Search (🔍) icon appears corresponding to this field. On clicking the Search icon, the To Do Type Search window appears.</p>	<p>Yes (Conditional)</p> <p>Note: This field is required when the Approval Required check box is selected.</p>
Approval To Do Role	Used to indicate that users with the specified To Do role can only approve the upload request submitted for approval.	<p>Yes (Conditional)</p> <p>Note: This field is required when the Approval Required check box is selected.</p>
FK Reference	Used to indicate the FK Reference code to display the entity information.	No

Field Name	Field Description	Mandatory (Yes or No)
	<p>Note:</p> <p>The Search (🔍) icon appears corresponding to this field. On clicking the Search icon, the Foreign Key Search window appears.</p> <p>This field appears when the business object is Upload Request Type.</p>	

In addition, this section contains the following fields in the grid:

Note: The below section appears when the business object is **Adjustment Upload Request Type**.

Field Name	Field Description	Mandatory (Yes or No)
Match Type	<p>Used to indicate the match type using which you want to create adjustments when you upload a file using the upload request type. The valid values are:</p> <ul style="list-style-type: none"> Contract Contract Type 	<p>Yes (Conditional)</p> <p>Note: This field is required when you select the Adjustment Upload Request option from the Upload Request Business Object list.</p>
Algorithm	<p>Used to attach an algorithm that will be triggered when you upload an adjustment data file. This algorithm determines the contract against which the adjustment must be created.</p>	<p>Yes (Conditional)</p> <p>Note: This field is required when you select the match type from the respective field.</p>

Tip: Alternatively, you can click the **Duplicate** button in the **Upload Request Type** zone to create a copy of the upload request type.

4. Enter the required details.

Note:

You can search for an algorithm by clicking the **Search** (🔍) icon corresponding to the respective field.

If you want to associate more than one match type with the upload request type, click the **Add** (+) icon and then specify the details. However, if you want to remove a match type from the upload request type, click the **Delete** (🗑️) icon corresponding to the match type.

5. Define, edit, or remove characteristics of the upload request type, if required.

6. Click **Save**.

The new upload request type is defined.

Related Topics

For more information on...	See...
Upload Request Type screen	Upload Request Type on page 1387
Upload Request Type List zone	Upload Request Type List on page 1388
Upload Request Type zone	Upload Request Type on page 1389

For more information on...	See...
How to define a characteristic for an upload request type	Defining a Characteristic for an Upload Request Type on page 1397

Mapping an Upload Request Type

Prerequisites

To map an upload request type, you should have:

- Upload request type (whose columns you want to map with the CSV file) defined in the application
- Upload request business objects defined in the application

Note: Once an upload request type is used for creating an upload request, then mapping for the same cannot be edited. Duplicating the upload request type will not duplicate the mapping data. You have to add the mapping details manually after duplicating an upload request type.

Procedure

To map an upload request type:

1. Click the **Admin** link in the **Application** toolbar.
A list appears.
2. From the **Admin** menu, select **U** and then click **Upload Request Type**.
A sub-menu appears.
3. In the **Upload Request Type List** zone, click the **Mapping** (🔗) icon in the **Mapping** column corresponding to the upload request type whose columns you want to map with the CSV file.

The **Upload Request Type Mapping** screen appears. It contains the following field:

Note: The **Mapping** icon is applicable only for upload request type created using **Upload Request Type (C1-UplRequestType)** business object, and it is not applicable for upload request type created using **Adjustment Upload Request Type (C1-AdjRequestType)** business object.

Field Name	Field Description	Mandatory (Yes or No)
Upload Request Type	Indicates the upload request type.	Not applicable

The **Upload Request Type Mapping** screen also contains the following columns:

Column Name	Column Description	Mandatory (Yes or No)
CSV Column Header	Used to specify the rows correspond to the columns in CSV file.	Yes (Conditional) Note: This column is required when you search the Data Records zone in the Upload Request screen.
Use for Searching	Used to indicate whether the defined CSV Column Header is searchable or not. Note: Upto 10 rows can be selected as searchable rows.	Yes (Conditional) Note: This column is required to be selected to be shown in the Data Records zone in the Upload Request screen

Column Name	Column Description	Mandatory (Yes or No)
Sequence Number	Used to specify the sequence of the searchable fields.	Yes (Conditional)
	Note: Searchable rows should have sequence less than or equal to 10.	Note: This column is required to be selected to be shown sequentially in the Data Records zone in the Upload Request screen

- Enter the required details.

Note: If you want to add more than one column names mapped to the upload request type, click the **Add (+)** icon and then specify the details. However, if you want to remove a column name mapped to the upload request type, click the **Delete (🗑)** icon corresponding to the column header.

- Click **Save**.

The columns are mapped to the CSV files for upload request type.

Related Topics

For more information on...	See...
Upload Request Type screen	Upload Request Type on page 1387
Upload Request Type List zone	Upload Request Type List on page 1388
Upload Request Type zone	Upload Request Type on page 1389

Viewing the Upload Request Type Details

Procedure

To view the details of an upload request type:

- Click the **Admin** link in the **Application** toolbar.
A list appears.
- From the **Admin** menu, select **U** and then click **Upload Request Type**.
A sub-menu appears.
- Click the **Search** option from the **Upload Request Type** sub-menu.
The **Upload Request Type** screen appears.
- In the **Upload Request Type List** zone, click the **Broadcast (📡)** icon corresponding to the upload request type whose details you want to view.
The **Upload Request Type** zone appears.
- View the details of the upload request type in the **Upload Request Type** zone.

Related Topics

For more information on...	See...
Upload Request Type screen	Upload Request Type on page 1387
Upload Request Type List zone	Upload Request Type List on page 1388
Upload Request Type zone	Upload Request Type on page 1389

--

Upload Request (Used for Searching)

The **Upload Request** screen allows you to upload, validate and process the transaction data. Through this screen, you can navigate to the following screen:

- [Upload Request \(Used for Viewing\)](#) on page 1853

This screen consists of the following zone:

- [Search Upload Request](#) on page 1847

Search Upload Request

The **Search Upload Request** zone allows you to search for a upload request using various search criteria. This zone contains the following two sections:

- **Search Criteria** – The **Search Criteria** section contains the following fields:

Field Name	Field Description	Mandatory (Yes or No)
Search By	Used to indicate whether you want to search for an upload request using Request Details .	Yes
Upload Date From	Used to search upload requests which are created from a particular date.	No
To	Used to search upload requests which are created till a particular date.	No
Status	Used to search upload requests with a particular status. The valid values are: <ul style="list-style-type: none"> • Approval In Progress • Canceled • Deferred Processing • Draft • Processed • Rejected • Validated 	No
Upload Request Type	Used to search upload requests which are created using a particular upload request type.	No
User ID	Used to search upload requests which are created by a particular user.	No
Upload Request ID	Used to search a particular upload request.	No
File Name	Used to search a particular file name.	No

Note: You must specify at least one search criterion while searching for an upload request.

- **Search Results** – On clicking the **Search** button, the search results appear based on the specified search criteria. The **Search Results** section contains the following columns:

Column Name	Column Description
Upload Date	Displays the date and time when the upload request was created in the system.
Payment Request Information	Displays information about the upload request.
	Note: It has a link. On clicking the link, the Upload Request screen appears where you can view the details of the respective upload request.
Status	Indicates the status of the upload request. The valid values are: <ul style="list-style-type: none"> • Approval In Progress • Canceled • Deferred Processing • Draft • Processed • Rejected • Validated
Upload Request Type	Displays the upload request type using which the upload request is created.
Entity Business Object	Displays the business object code of the entity.
File Name	Displays the uploaded file name.
Total Records	Displays the total number of records in the uploaded csv file.
Created By	Indicates the user who has created the upload request.

Related Topics

For more information on...	See...
How to search for an upload request	Searching for an Upload Request on page 1848
How to view the details of an upload request	Viewing the Upload Request Details on page 1849
How to create an upload request	Creating an Upload Request on page 1850
How to define a characteristic for an upload request	Defining a Characteristic for an Upload Request on page 1852

Searching for an Upload Request

Prerequisites

To search for an upload request, you should have:

- Upload request types defined in the application

Procedure

To search for an upload request:

1. Click the **Menu** link in the **Application** toolbar.
A list appears.
2. From the **Main** menu, select **Tools** and then click **Upload Request**.
A sub-menu appears.

- Click the **Search** option from the **Upload Request** sub-menu.

The **Upload Request** screen appears.

- Enter the search criteria in the **Search Upload Request** zone.

Note: ORMB search engine supports wildcard search, where you can substitute the percentage (%) symbol as a stand in for any word or letter in a search criteria. You can use the ‘%’ wildcard character in all input fields except the date and ID fields. The ‘%’ wildcard character is suffixed automatically at the end of the partial search criteria. Therefore, you may or may not specify the wildcard character at the end of the partial search criteria. However, you have to prefix the wildcard character manually wherever required.

- Click **Search**.

A list of upload requests that meet the search criteria appears in the **Search Results** section.

Related Topics

For more information on...	See...
Upload Request screen	Upload Request (Used for Searching) on page 1847
Search Upload Request zone	Search Upload Request on page 1847

Viewing the Upload Request Details

Procedure

To view the details of an upload request:

- Search for the upload request in the **Upload Request** screen.
- In the **Search Results** section, click the link in the **Upload Request Information** column corresponding to the upload request whose details you want to view.

The **Upload Request** screen appears. It consists of the following tabs:

- **Main** – This tab contains the following two zones:
 - **Upload Request** – Displays the details of the upload request.
 - **Data Records** – Lists the details of data records uploaded in the csv file.
 - **Log** – This tab lists the complete trail of actions performed on the upload request.
- View the details of the upload request in the **Upload Request** zone.
 - View the data records in the csv file of the upload request in the **Data Records** zone.

Related Topics

For more information on...	See...
How to search for an upload request	Searching for an Upload Request on page 1848
Upload Request screen	Upload Request (Used for Viewing) on page 1853
Upload Request zone	Upload Request on page 1854
Data Records zone	Data Records on page 1856

Creating an Upload Request

Prerequisites

To create an upload request, you should have:

- Upload request types defined in the application

Procedure

To create an upload request:

1. Click the **Menu** link in the **Application** toolbar.
A list appears.
2. From the **Main** menu, select **Tools** and then click **Upload Request**.
A sub-menu appears.
3. Click the **Add** option from the **Upload Request** sub-menu.

The **Select Upload Request Type** screen appears. It contains the following field:

Field Name	Field Description	Mandatory (Yes or No)
Upload Request Type	Used to indicate the upload request type using which you want to create the upload request. Note: The following upload request types are shipped with the product: <ul style="list-style-type: none"> • ADJ_UPL_REQ_TYPE_APVL • ADJ_UPL_REQ_TYPE_WO_APVL • BC_UPL_REQ_TYPE • BILL_CYCLE_UPD_UPL_REQ_TYPE • BILL_LVL_UPL_REQ_TYPE • BILL_SRT_UPL_REQ_TYPE • HOLD_UPL_REQ_TYPE • REFUND_UPL_REQ_TYPE • REIN_UPL_REQ_TYPE • SA_RIDER_UPD_UPL_REQ_TYPE • WO_UPL_REQ_TYPE 	Yes

Tip: Alternatively, you can access the **Select Upload Request Type** screen by clicking the **Upload** button in the **Page Title** area of the **Upload Request** screen.

Note: The **Select Upload Request Type** screen appears when there are multiple upload request types defined in the application. If there is only one upload request type defined in the application, the **{XXX} Upload Request** screen appears.

4. Select the required upload request type from the respective field.
5. Click **OK**.

The {XXX} **Upload Request** screen appears. Here, {XXX} changes depending on the upload request type that you have selected. It contains the following sections:

- **Main** – Used to specify basic details about the upload request.
- **Characteristics** – Used to define the characteristics for the upload request.

The **Main** section contains the following fields:

Field Name	Field Description	Mandatory (Yes or No)
Upload Request Type	Indicates the upload request type using which the upload request will be created.	Not applicable
Parent Customer	<p>Used to indicate the person for whom you want to create the bill group sorting or bill group derivation and pricing parameters upload request.</p> <p>Note: This field appears when you are creating an upload request using an upload request type where the upload request business object is set to C1-BillGrpSortUploadRequest or C1-BillLevelUploadRequest.</p> <p>The system allows you to create a bill group sorting or bill group derivation and pricing parameters upload request for a person whose person type is set to Parent Customer.</p> <p>The Search (🔍) icon appears corresponding to this field. On clicking the Search icon, the Person Search window appears.</p>	Yes
File Name	<p>Used to specify the name and path of the file that you want to upload.</p> <p>Note: You can also click the Browse button corresponding to this field to browse to the location where the file is available in the system.</p>	Yes
Replace Existing File	Used to indicate whether you want to replace any existing file in the system. You must select this check box when you want to upload the same file once again.	No
Comments	Used to specify additional information about the upload request.	No

6. Click the **Browse** button corresponding to the **File Name** field.

The **Choose File to Upload** dialog box appears.

7. Browse to the location where the file that you want to upload is available in the system.
8. Click **Open**.

The file name along with the path appears in the **File Name** field.

9. Select the **Replace Existing File** check box depending on whether you want to upload the same file once again in the system.
10. Define characteristics for the upload request, if required.
11. Click **Save**.

A message appears indicating the number of records which are successfully uploaded. Then, an upload request is created in the **Draft** status. If the required identifier (such as account ID, person ID, policy ID, or bill group ID) is available in the record, the status of the record is set to **Pending**. However, if the required identifier could not be derived from the system, the status of the record is set to **Invalid**.

Related Topics

For more information on...	See...
Upload Request screen	Upload Request (Used for Searching) on page 1847
How to define a characteristic for an upload request	Defining a Characteristic for an Upload Request on page 1852

Defining a Characteristic for an Upload Request

Prerequisites

To define a characteristic for an upload request, you should have:

- Characteristic types defined in the application (where the characteristic entity is set to **Upload Request**)

Procedure

To define a characteristic for an upload request:

1. Ensure that the **Characteristics** section is expanded when you are defining or editing an upload request.

The **Characteristics** section contains the following fields in a grid:

Field Name	Field Description	Mandatory (Yes or No)
Effective Date	Used to specify the date from when the characteristic is effective for the upload request.	Yes (Conditional) Note: This field is required when you are defining a characteristic for the upload request.
Characteristic Type	Used to indicate the characteristic type. Note: The list includes only those characteristic types where the characteristic entity is set to Upload Request .	Yes (Conditional) Note: This field is required when you are defining a characteristic for the upload request.
Characteristic Value	Used to specify the value for the characteristic type.	Yes (Conditional) Note: This field is required when you are defining a characteristic for the upload request.

Field Name	Field Description	Mandatory (Yes or No)
	Note: On specifying the value for a predefined characteristic type, the description of the characteristic value appears corresponding to the Characteristic Value field.	

- Enter the required details in the **Characteristics** section.

Note: If you select a predefined characteristic type, the **Search** (🔍) icon appears corresponding to the **Characteristic Value** field. On clicking the **Search** icon, you can search for a predefined characteristic value.

- If you want to define more than one characteristic for the upload request, click the **Add** (+) icon and then repeat step 2.

Note: However, if you want to remove a characteristic from the upload request, click the **Delete** (🗑️) icon corresponding to the characteristic.

Related Topics

For more information on...	See...
How to create an upload request	Creating an Upload Request on page 1850
How to edit an upload request	Editing an Upload Request on page 1858

Upload Request (Used for Viewing)

Once you create an upload request, the **Upload Request** screen allows you to:

- Edit the details of an upload request
- Delete an upload request
- View the details of an upload request
- Validate an upload request
- Cancel an upload request
- Submit an upload request
- Approve or reject an upload request
- View the data uploaded to a request
- View the log of an upload request
- Add a log entry for an upload request

This screen consists of the following tabs:

- **Main** – This tab contains the following two zones:
 - **Upload Request** – Displays the details of the upload request.
 - **Data Records** – Lists the data records of the upload request.
- **Log** – This tab lists the complete trail of actions performed on the upload request.

Upload Request - Main

The **Main** tab contains the following zones:

- [Upload Request](#) on page 1854
- [Data Records](#) on page 1856

Upload Request

The **Upload Request** zone displays the details of the upload request. This zone contains the following sections:

- **Main** – This section provides basic information about the upload request. It contains the following fields:

Field Name	Field Description
Upload Request Information	Displays information about the upload request.
Upload Request Type	Indicates the upload request type using which the upload request is created. Note: It has a link. On clicking the link, the Upload Request Type screen appears where you can view the details of the upload request type.
Status	Indicates the status of the payment request. The valid values are: <ul style="list-style-type: none"> • Approval In Progress • Approved • Cancelled • Deferred Processing • Draft • Processed • Rejected • Submitted • Validated
File Name	Displays name of the uploaded file.

- **Statistics** – This section lists the statistics of records in the upload request. It contains the following fields:

Field Name	Field Description
Total Records	Displays total number of records in CSV file.
Valid Records	Displays the count of valid data records.
Error Records	Displays the count of data records in error status.
Pending Records	Displays the count of data records pending after successful derivation.
Invalid Records	Displays the count of data records after unsuccessful derivation.
Processed Records	Displays the count of data records after processing.

- **Characteristics** – This section lists the characteristics of the upload request. It contains the following columns:

Column Name	Column Description
Effective Date	Indicates the date from when the characteristic is effective for the upload request.
Characteristic Type	Indicates the characteristic type.

Column Name	Column Description
Characteristic Value	Displays the value of the characteristic type.

- **Record Actions** – This section contains the following buttons:

Column Name	Column Description
Edit	Used to edit the details of the upload request.
	Note: The Edit button appears when the upload request is in the Draft or Validated status.
Delete	Used to delete the upload request.
	Note: The Delete button appears when the upload request is in the Draft status.
Validate	Used to validate the upload request.
	Note: The Validate button appears when the upload request is in the Draft status.
Cancel	Used to cancel the upload request.
	Note: The Cancel button appears when the upload request is in the Validated status.
Submit	Used to submit the upload request for approval.
	Note: The Submit button appears when: <ul style="list-style-type: none"> • The upload request is in the Validated status. • The Approval Required check box is selected in the upload request type using which the upload request is created.
Approve	Used to approve the upload request.
	Note: The Approve button appears when: <ul style="list-style-type: none"> • The upload request is in the Approval In Progress status. • A user with the approval To Do role is reviewing the upload request.
Reject	Used to reject the upload request.
	Note: The Reject button appears when: <ul style="list-style-type: none"> • The upload request is in the Approval In Progress status. • A user with the approval To Do role is reviewing the upload request.

- **Record Information** – This section contains the following fields:

Field Name	Field Description
Business Object	Indicates the business object using which the upload request is created. In addition, a context menu appears corresponding to this field which helps in navigating to other screens in the application.

Field Name	Field Description
	Note: It has a link. On clicking the link, the Business Object screen appears where you can view the details of the respective business object.
Status Date/Time	Displays the date and time when the upload request status is updated
Create Date/Time	Displays the date and time when the upload request is created.

Data Records

The **Data Records** zone lists the data records of the upload request. This zone contains the following two sections:

- **Search Criteria** – The **Search Criteria** section contains the following fields:

Field Name	Field Description	Mandatory (Yes or No)
Search Criteria 1, Search Criteria 2,,Search Criteria 10	Used to search for data from the CSV file with respect to the field.	No
	Note: We have used generic field labels here. However, these labels will change depending on the mapping defined in the respective upload request type.	
Record Status	Used to indicate whether you want to search data records for an upload request. The valid values are: <ul style="list-style-type: none"> • Error • Invalid • Pending • Processed • Valid 	No

- **Search Results** – On clicking the **Search** button, the search results appear based on the specified search criteria. The **Search Results** section contains the following columns:

Column Name	Column Description
View	On clicking the View () icon, the Data Record Details window appears where you can view the details of the data records.
Search Result 1, Search Result 2,, Search Result 10	Displays data from the CSV file.

Column Name	Column Description
Note: We have used generic field labels here. However, these labels will change depending on the mapping defined in the respective upload request type.	
Record Status	Indicates the status of the data record. The valid values are: <ul style="list-style-type: none"> • Error • Invalid • Pending • Processed • Valid
Message(s)	Displays message for the data record respective to it's status.
Entity ID	Displays entity ID of the upload request. Note: The entity ID is displayed only for data records with Processed status.
Entity Information	Displays entity information for the FK Reference selected in Upload Request Type screen. Note: The entity information is displayed only for data records with Processed status.

Note: By default the **Search Results** section displays data records for all the statuses though data is not added or selected to any of the fields and are searched through the **Search Criteria** section.

Related Topics

For more information on...	See...
How to view details against each data record.	Viewing the Data Record Details on page 1869

Upload Request - Log

The **Log** tab contains the following zone:

- [Upload Request Log](#) on page 1857

Upload Request Log

The **Upload Request Log** zone on the **Upload Request** screen lists the complete trail of actions performed on the upload request. This zone contains the following columns:

Column Name	Column Description
Date/Time	Displays the date and time when the action was performed on the upload request.
Details	Displays the details about the action performed on the upload request.
User	Indicates the user who has performed the action on the upload request.

Column Name	Column Description
Log Type	Indicates the type of log.
Related Object	Indicates the object or entity which is generated when the action is performed on the upload request.
Status Reason	Displays the status reason of action performed on the upload request.

Note: You can manually add a log entry for the upload request by clicking the **Add Log Entry** link in the upper right corner of the **Upload Request Log** zone.

The **Add Upload Request Log** window appears. Enter **Log Details** and click **Save**. The upload request log is added.

Related Topics

For more information on...	See...
How to view the log of an upload request	Viewing the Log of an Upload Request on page 1869
How to add the log for an upload request	Adding a Log Entry for an Upload Request on page 1870

Editing an Upload Request

Procedure

To edit an upload request:

1. Search for the upload request in the **Upload Request** screen.
2. In the **Search Results** section, click the link in the **Upload Request Information** column corresponding to the upload request whose details you want to edit.

The **Upload Request** screen appears.

3. Click the **Edit** button in the **Upload Request** zone.

Note: The **Edit** button appears when the upload request is in the **Draft** or **Validated** status.

The entity **Upload Request** screen appears. It contains the following sections:

- **Main** – Used to specify basic details about the upload request. This section contains the following fields:

Field Name	Field Description	Mandatory (Yes or No)
Upload Request Type	Displays the upload request type using which the upload request is created.	Not applicable
File Name	Displays name of the uploaded CSV file.	Not applicable
Comments	Used to indicate the comments for upload request.	No

- **Characteristics** – Used to define the characteristics for the upload request. This section contains the following fields:

Field Name	Field Description	Mandatory (Yes or No)
Effective Date	Used to specify the date from when the characteristic is effective for the upload request.	Yes (Conditional)
		Note: This field is required when you are defining a characteristic for the upload request.

Field Name	Field Description	Mandatory (Yes or No)
Characteristic Type	Used to indicate the characteristic type.	Yes (Conditional)
	Note: The list includes only those characteristic types where the characteristic entity is set to Upload Request .	Note: This field is required when you are defining a characteristic for the Upload request.
Characteristic Value	Used to specify the value for the characteristic type.	Yes (Conditional)
	Note: On specifying the value for a predefined characteristic type, the description of the characteristic value appears corresponding to the Characteristic Value field.	Note: This field is required when you are defining a characteristic for the Upload request.

4. Modify the details of the upload request, if required.
5. Define, edit, or remove characteristics of the upload request, if required.
6. Click **Save**.

The changes made to the upload request are saved.

Related Topics

For more information on...	See...
How to search for an upload request	Searching for an Upload Request on page 1848
Upload Request screen	Upload Request (Used for Viewing) on page 1853
Upload Request zone	Upload Request on page 1854
How to define a characteristic for an upload request	Defining a Characteristic for an Upload Request on page 1852

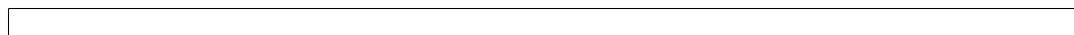

Deleting an Upload Request

Procedure

To delete an upload request:

1. Search for the upload request in the **Upload Request** screen.
2. In the **Search Results** section, click the link in the **Upload Request Information** column corresponding to the upload request that you want to delete.

The **Upload Request** screen appears.

3. Click the **Delete** button in the **Upload Request** zone.

A message appears confirming whether you want to delete the upload request.

Note: The **Delete** button appears when the upload request is in the **Draft** status.

4. Click **OK**.

The upload request is deleted.

Related Topics

For more information on...	See...
How to search for an upload request	Searching for an Upload Request on page 1848
Upload Request screen	Upload Request (Used for Viewing) on page 1853
Upload Request zone	Upload Request on page 1854

Validating an Upload Request

Prerequisites

To validate an upload request, you should have:

- Upload Request Types defined in the request.

Procedure

To validate an upload request:

1. Search for the upload request in the **Upload Request** screen.
2. In the **Search Results** section, click the link in the **Upload Request Information** column corresponding to the upload request that you want to validate.

The **Upload Request** screen appears.

3. Click the **Validate** button in the **Upload Request** zone.

Note: The **Validate** button appears when the upload request is in the **Draft** status.

For more information about the **Upload Request Periodic Monitor (C1-UPLRQ)** batch, refer to Oracle Revenue Management and Billing Batch Guide.

The status of the upload request is changed to **Validated**.

Related Topics

For more information on...	See...
How to search for an upload request	Searching for an Upload Request on page 1848
Upload Request screen	Upload Request (Used for Viewing) on page 1853
Upload Request zone	Upload Request on page 1854

Canceling an Upload Request

Prerequisites

To cancel an upload request, you should have:

- Cancellation reasons defined in the application

Note: While cancelling an upload request, you need to specify the reason why you want to cancel the upload request. You can select the appropriate cancellation reason when you have defined the reasons for the **Canceled** status of the **C1-UplRequestType** business object in the **Status Reason** screen.

Procedure

To cancel an upload request:

1. Search for the upload request in the **Upload Request** screen.
2. In the **Search Results** section, click the link in the **Upload Request Information** column corresponding to the upload request that you want to cancel.

The **Upload Request** screen appears.

3. Click the **Cancel** button in the **Upload Request** zone.

The **Cancel Reason** window appears. It contains following fields:

Field Name	Field Description	Mandatory (Yes or No)
Cancel Reason	Used to indicate the reason why you want to cancel the upload request.	Yes
Comments	Used to specify additional information while cancelling the upload request.	No

Note: The **Cancel** button appears when the upload request is in the **Validated** status.

4. Select the cancellation reason from the **Cancel Reason** list.
5. Click **Save**.

The status of the upload request is changed to **Canceled**.

Related Topics

For more information on...	See...
How to search for an upload request	Searching for an Upload Request on page 1848
Upload Request screen	Upload Request (Used for Viewing) on page 1853
Upload Request zone	Upload Request on page 1854

Submitting an Upload Request

Procedure

To submit an upload request:

1. Search for the upload request in the **Upload Request** screen.
2. In the **Search Results** section, click the link in the **Upload Request Information** column corresponding to the upload request that you want to submit.

The **Upload Request** screen appears.

3. Click the **Submit** button in the **Upload Request** zone.

The system behaves in the following manner:

If...	Then...																				
<p>The Approval Required check box is selected in the upload request type using which the upload request is created</p>	<p>A To Do of the specified To Do type is created and sent to the approver for approval. The following table lists the To Do type using which the To Do is created for the different upload requests:</p> <table border="1" data-bbox="873 359 1466 894"> <thead> <tr> <th data-bbox="881 369 1166 411">Upload Request</th> <th data-bbox="1174 369 1466 411">To Do Type</th> </tr> </thead> <tbody> <tr> <td data-bbox="881 415 1166 457">Bill Cycle Update</td> <td data-bbox="1174 415 1466 457">C1-BCUUR</td> </tr> <tr> <td data-bbox="881 462 1166 504">Billable Charge</td> <td data-bbox="1174 462 1466 504">C1-BCUR</td> </tr> <tr> <td data-bbox="881 508 1166 550">Contract Rider Update</td> <td data-bbox="1174 508 1466 550">C1-CRUUR</td> </tr> <tr> <td data-bbox="881 554 1166 596">Hold Request</td> <td data-bbox="1174 554 1466 596">C1-HLDUR</td> </tr> <tr> <td data-bbox="881 600 1166 642">Refund Request</td> <td data-bbox="1174 600 1466 642">C1-REFUR</td> </tr> <tr> <td data-bbox="881 646 1166 688">Write Off Request</td> <td data-bbox="1174 646 1466 688">C1-WOUR</td> </tr> <tr> <td data-bbox="881 693 1166 735">Policy Reinstatement</td> <td data-bbox="1174 693 1466 735">C1-RPUR</td> </tr> <tr> <td data-bbox="881 739 1166 781">Bill Group Sorting</td> <td data-bbox="1174 739 1466 781">C1-BGSRT</td> </tr> <tr> <td data-bbox="881 785 1166 884">Bill Group Derivation and Pricing Parameters</td> <td data-bbox="1174 785 1466 884">C1-BGDVP</td> </tr> </tbody> </table> <p>In addition, the status of the upload request is changed to Approval In Progress.</p>	Upload Request	To Do Type	Bill Cycle Update	C1-BCUUR	Billable Charge	C1-BCUR	Contract Rider Update	C1-CRUUR	Hold Request	C1-HLDUR	Refund Request	C1-REFUR	Write Off Request	C1-WOUR	Policy Reinstatement	C1-RPUR	Bill Group Sorting	C1-BGSRT	Bill Group Derivation and Pricing Parameters	C1-BGDVP
Upload Request	To Do Type																				
Bill Cycle Update	C1-BCUUR																				
Billable Charge	C1-BCUR																				
Contract Rider Update	C1-CRUUR																				
Hold Request	C1-HLDUR																				
Refund Request	C1-REFUR																				
Write Off Request	C1-WOUR																				
Policy Reinstatement	C1-RPUR																				
Bill Group Sorting	C1-BGSRT																				
Bill Group Derivation and Pricing Parameters	C1-BGDVP																				
<p>The Approval Required check box is not selected in the upload request type using which the upload request is created and the number of valid records in the upload request does not exceed the online record process limit defined in the C1-DEFERUPLD algorithm.</p>	<p>The following table lists the behavior for the different upload requests:</p> <table border="1" data-bbox="873 1087 1466 1850"> <thead> <tr> <th data-bbox="881 1098 1125 1140">Upload Request</th> <th data-bbox="1133 1098 1466 1140">Behaviour</th> </tr> </thead> <tbody> <tr> <td data-bbox="881 1144 1125 1220">Bill Cycle Update</td> <td data-bbox="1133 1144 1466 1220">The bill cycle information is updated for the accounts.</td> </tr> <tr> <td data-bbox="881 1224 1125 1299">Billable Charge</td> <td data-bbox="1133 1224 1466 1299">The billable charges are created.</td> </tr> <tr> <td data-bbox="881 1304 1125 1409">Contract Rider Update</td> <td data-bbox="1133 1304 1466 1409">The contract rider information is updated for the contracts.</td> </tr> <tr> <td data-bbox="881 1413 1125 1488">Hold Request</td> <td data-bbox="1133 1413 1466 1488">The hold requests are created.</td> </tr> <tr> <td data-bbox="881 1493 1125 1568">Refund Request</td> <td data-bbox="1133 1493 1466 1568">The refund requests are created.</td> </tr> <tr> <td data-bbox="881 1572 1125 1648">Write Off Request</td> <td data-bbox="1133 1572 1466 1648">The write off requests are created.</td> </tr> <tr> <td data-bbox="881 1652 1125 1850">Policy Reinstatement</td> <td data-bbox="1133 1652 1466 1850">The policies are reinstated and the status of the policies is changed to the one defined in the Policy Status after Processing Reinstatement Upload Request parameter</td> </tr> </tbody> </table>	Upload Request	Behaviour	Bill Cycle Update	The bill cycle information is updated for the accounts.	Billable Charge	The billable charges are created.	Contract Rider Update	The contract rider information is updated for the contracts.	Hold Request	The hold requests are created.	Refund Request	The refund requests are created.	Write Off Request	The write off requests are created.	Policy Reinstatement	The policies are reinstated and the status of the policies is changed to the one defined in the Policy Status after Processing Reinstatement Upload Request parameter				
Upload Request	Behaviour																				
Bill Cycle Update	The bill cycle information is updated for the accounts.																				
Billable Charge	The billable charges are created.																				
Contract Rider Update	The contract rider information is updated for the contracts.																				
Hold Request	The hold requests are created.																				
Refund Request	The refund requests are created.																				
Write Off Request	The write off requests are created.																				
Policy Reinstatement	The policies are reinstated and the status of the policies is changed to the one defined in the Policy Status after Processing Reinstatement Upload Request parameter																				

If...	Then...																			
	<table border="1"> <thead> <tr> <th data-bbox="870 201 1114 247">Upload Request</th> <th data-bbox="1127 201 1458 247">Behaviour</th> </tr> </thead> <tbody> <tr> <td data-bbox="870 247 1114 327"></td> <td data-bbox="1127 247 1458 327">of the C1-REN-VALID algorithm.</td> </tr> <tr> <td data-bbox="870 327 1114 407">Bill Group Sorting</td> <td data-bbox="1127 327 1458 407">The sort ID is defined for the respective bill group.</td> </tr> <tr> <td data-bbox="870 407 1114 554">Bill Group Derivation and Pricing Parameters</td> <td data-bbox="1127 407 1458 554">The derivation and pricing parameters are defined for the respective bill group and sort ID combination.</td> </tr> </tbody> </table>	Upload Request	Behaviour		of the C1-REN-VALID algorithm.	Bill Group Sorting	The sort ID is defined for the respective bill group.	Bill Group Derivation and Pricing Parameters	The derivation and pricing parameters are defined for the respective bill group and sort ID combination.											
Upload Request	Behaviour																			
	of the C1-REN-VALID algorithm.																			
Bill Group Sorting	The sort ID is defined for the respective bill group.																			
Bill Group Derivation and Pricing Parameters	The derivation and pricing parameters are defined for the respective bill group and sort ID combination.																			
<p>The Approval Required check box is not selected in the upload request type using which the upload request is created and the number of valid records in the upload request exceeds the online record process limit defined in the C1-DEFERUPLD algorithm</p>	<p>In addition, the status of the upload request is changed to Processed.</p> <p>The system changes the status of the upload request to Deferred Processing. When the Upload Request Periodic Monitor (C1-UPLRQ) batch is invoked, the system checks whether there are any upload requests in the Deferred Processing status. If there is an upload request in the Deferred Processing status, the system behaves in the following manner for the different upload requests:</p> <table border="1"> <thead> <tr> <th data-bbox="870 940 1122 987">Upload Request</th> <th data-bbox="1127 940 1458 987">Behaviour</th> </tr> </thead> <tbody> <tr> <td data-bbox="870 987 1122 1071">Bill Cycle Update</td> <td data-bbox="1127 987 1458 1071">The bill cycle information is updated for the accounts.</td> </tr> <tr> <td data-bbox="870 1071 1122 1155">Billable Charge</td> <td data-bbox="1127 1071 1458 1155">The billable charges are created.</td> </tr> <tr> <td data-bbox="870 1155 1122 1270">Contract Rider Update</td> <td data-bbox="1127 1155 1458 1270">The contract rider information is updated for the contracts.</td> </tr> <tr> <td data-bbox="870 1270 1122 1316">Hold Request</td> <td data-bbox="1127 1270 1458 1316">The hold requests are created.</td> </tr> <tr> <td data-bbox="870 1316 1122 1400">Refund Request</td> <td data-bbox="1127 1316 1458 1400">The refund requests are created.</td> </tr> <tr> <td data-bbox="870 1400 1122 1484">Write Off Request</td> <td data-bbox="1127 1400 1458 1484">The write off requests are created.</td> </tr> <tr> <td data-bbox="870 1484 1122 1757">Policy Reinstatement</td> <td data-bbox="1127 1484 1458 1757">The policies are reinstated and the status of the policies is changed to the one defined in the Policy Status after Processing Reinstatement Upload Request parameter of the C1-REN-VALID algorithm.</td> </tr> <tr> <td data-bbox="870 1757 1122 1837">Bill Group Sorting</td> <td data-bbox="1127 1757 1458 1837">The sort ID is defined for the respective bill group.</td> </tr> </tbody> </table>		Upload Request	Behaviour	Bill Cycle Update	The bill cycle information is updated for the accounts.	Billable Charge	The billable charges are created.	Contract Rider Update	The contract rider information is updated for the contracts.	Hold Request	The hold requests are created.	Refund Request	The refund requests are created.	Write Off Request	The write off requests are created.	Policy Reinstatement	The policies are reinstated and the status of the policies is changed to the one defined in the Policy Status after Processing Reinstatement Upload Request parameter of the C1-REN-VALID algorithm.	Bill Group Sorting	The sort ID is defined for the respective bill group.
Upload Request	Behaviour																			
Bill Cycle Update	The bill cycle information is updated for the accounts.																			
Billable Charge	The billable charges are created.																			
Contract Rider Update	The contract rider information is updated for the contracts.																			
Hold Request	The hold requests are created.																			
Refund Request	The refund requests are created.																			
Write Off Request	The write off requests are created.																			
Policy Reinstatement	The policies are reinstated and the status of the policies is changed to the one defined in the Policy Status after Processing Reinstatement Upload Request parameter of the C1-REN-VALID algorithm.																			
Bill Group Sorting	The sort ID is defined for the respective bill group.																			

If...	Then...	
	Upload Request	Behaviour
	Bill Group Derivation and Pricing Parameters	The derivation and pricing parameters are defined for the respective bill group and sort ID combination.
In addition, the status of the upload request is changed to Processed .		

Note:

The **Submit** button appears when the upload request is in the **Validated** status.

Related Topics

For more information on...	See...
Upload Request screen	Upload Request (Used for Viewing) on page 1853
Upload Request zone	Upload Request on page 1854
How to search for an upload request	Searching for an Upload Request on page 1848

Approving an Upload Request

You can view the number of upload requests which are pending for approval in the **Upload Request** screen. The approver can review, and accordingly approve or reject the upload request based on the observations.

Note: The system will not allow you to approve or reject an upload request submitted by you.

Procedure

To approve an upload request:

1. Do either of the following:

If you want to...	Then...
Approve a upload request through the Upload Request screen	<ol style="list-style-type: none"> 1. Search for the upload request in the Upload Request screen. 2. In the Search Results section, click the link in the Upload Request Information column corresponding to the upload request which you want to review.
Approve a upload request from the To Do List screen	<ol style="list-style-type: none"> 1. Click the Menu link in the Application toolbar. A list appears. 2. From the Main menu, select To Do and then click To Do List. The To Do Type for User Search window appears.

If you want to...	Then...
	<ol style="list-style-type: none"> 3. Enter the required To Do type in the respective field. 4. Click the Search button corresponding to the To Do Type field. The To Do List screen appears. 5. Select the Open option from the Filter by list to view all unassigned To Dos. 6. Click the link in the Message column corresponding to the To Do of the upload request that you want to review.

The **Upload Request** screen appears.

2. Review the upload request details.
3. Click the **Approve** button in the **Upload Request** zone.

The system behaves in the following manner:

If...	Then...																
<p>The number of valid records in the upload request does not exceed the online record process limit defined in the C1-DEFERUPLD algorithm</p>	<p>The following table lists the behavior for the different upload requests:</p> <table border="1" data-bbox="889 1010 1461 1883"> <thead> <tr> <th data-bbox="889 1010 1133 1060">Upload Request</th> <th data-bbox="1133 1010 1461 1060">Behavior</th> </tr> </thead> <tbody> <tr> <td data-bbox="889 1060 1133 1142">Bill Cycle Update</td> <td data-bbox="1133 1060 1461 1142">The bill cycle information is updated for the accounts.</td> </tr> <tr> <td data-bbox="889 1142 1133 1224">Billable Charge</td> <td data-bbox="1133 1142 1461 1224">The billable charges are created.</td> </tr> <tr> <td data-bbox="889 1224 1133 1337">Contract Rider Update</td> <td data-bbox="1133 1224 1461 1337">The contract rider information is updated for the contracts.</td> </tr> <tr> <td data-bbox="889 1337 1133 1419">Hold Request</td> <td data-bbox="1133 1337 1461 1419">The hold requests are created.</td> </tr> <tr> <td data-bbox="889 1419 1133 1501">Refund Request</td> <td data-bbox="1133 1419 1461 1501">The refund requests are created.</td> </tr> <tr> <td data-bbox="889 1501 1133 1583">Write Off Request</td> <td data-bbox="1133 1501 1461 1583">The write off requests are created.</td> </tr> <tr> <td data-bbox="889 1583 1133 1883">Policy Reinstatement</td> <td data-bbox="1133 1583 1461 1883">The policies are reinstated and the status of the policies is changed to the one defined in the Policy Status after Processing Reinstatement Upload Request parameter of the C1-REN-VALID algorithm.</td> </tr> </tbody> </table>	Upload Request	Behavior	Bill Cycle Update	The bill cycle information is updated for the accounts.	Billable Charge	The billable charges are created.	Contract Rider Update	The contract rider information is updated for the contracts.	Hold Request	The hold requests are created.	Refund Request	The refund requests are created.	Write Off Request	The write off requests are created.	Policy Reinstatement	The policies are reinstated and the status of the policies is changed to the one defined in the Policy Status after Processing Reinstatement Upload Request parameter of the C1-REN-VALID algorithm.
Upload Request	Behavior																
Bill Cycle Update	The bill cycle information is updated for the accounts.																
Billable Charge	The billable charges are created.																
Contract Rider Update	The contract rider information is updated for the contracts.																
Hold Request	The hold requests are created.																
Refund Request	The refund requests are created.																
Write Off Request	The write off requests are created.																
Policy Reinstatement	The policies are reinstated and the status of the policies is changed to the one defined in the Policy Status after Processing Reinstatement Upload Request parameter of the C1-REN-VALID algorithm.																

If...	Then...																					
	<table border="1"> <thead> <tr> <th data-bbox="886 205 1133 256">Upload Request</th> <th data-bbox="1138 205 1461 256">Behavior</th> </tr> </thead> <tbody> <tr> <td data-bbox="886 262 1133 333">Bill Group Sorting</td> <td data-bbox="1138 262 1461 333">The sort ID is defined for the respective bill group.</td> </tr> <tr> <td data-bbox="886 340 1133 478">Bill Group Derivation and Pricing Parameters</td> <td data-bbox="1138 340 1461 478">The derivation and pricing parameters are defined for the respective bill group and sort ID combination.</td> </tr> </tbody> </table> <p data-bbox="886 499 1461 562">In addition, the status of the upload request is changed to Processed.</p>		Upload Request	Behavior	Bill Group Sorting	The sort ID is defined for the respective bill group.	Bill Group Derivation and Pricing Parameters	The derivation and pricing parameters are defined for the respective bill group and sort ID combination.														
Upload Request	Behavior																					
Bill Group Sorting	The sort ID is defined for the respective bill group.																					
Bill Group Derivation and Pricing Parameters	The derivation and pricing parameters are defined for the respective bill group and sort ID combination.																					
<p data-bbox="289 594 865 682">The number of valid records in the upload request exceeds the online record process limit defined in the C1-DEFERUPLD algorithm</p>	<p data-bbox="886 594 1461 846">The system changes the status of the upload request to Deferred Processing. When the Upload Request Periodic Monitor (C1-UPLRQ) batch is invoked, the system checks whether there are any upload requests in the Deferred Processing status. If there is an upload request in the Deferred Processing status, the system behaves in the following manner for the different upload requests:</p> <table border="1"> <thead> <tr> <th data-bbox="886 867 1133 917">Upload Request</th> <th data-bbox="1138 867 1461 917">Behavior</th> </tr> </thead> <tbody> <tr> <td data-bbox="886 924 1133 995">Bill Cycle Update</td> <td data-bbox="1138 924 1461 995">The bill cycle information is updated for the accounts.</td> </tr> <tr> <td data-bbox="886 1001 1133 1073">Billable Charge</td> <td data-bbox="1138 1001 1461 1073">The billable charges are created.</td> </tr> <tr> <td data-bbox="886 1079 1133 1192">Contract Rider Update</td> <td data-bbox="1138 1079 1461 1192">The contract rider information is updated for the contracts.</td> </tr> <tr> <td data-bbox="886 1199 1133 1270">Hold Request</td> <td data-bbox="1138 1199 1461 1270">The hold requests are created.</td> </tr> <tr> <td data-bbox="886 1276 1133 1348">Refund Request</td> <td data-bbox="1138 1276 1461 1348">The refund requests are created.</td> </tr> <tr> <td data-bbox="886 1354 1133 1425">Write Off Request</td> <td data-bbox="1138 1354 1461 1425">The write off requests are created.</td> </tr> <tr> <td data-bbox="886 1432 1133 1747">Policy Reinstatement</td> <td data-bbox="1138 1432 1461 1747">The policies are reinstated and the status of the policies is changed to the one defined in the Policy Status after Processing Reinstatement Upload Request parameter of the C1-REN-VALID algorithm.</td> </tr> <tr> <td data-bbox="886 1753 1133 1824">Bill Group Sorting</td> <td data-bbox="1138 1753 1461 1824">The sort ID is defined for the respective bill group.</td> </tr> <tr> <td data-bbox="886 1831 1133 1936">Bill Group Derivation and Pricing Parameters</td> <td data-bbox="1138 1831 1461 1936">The derivation and pricing parameters are defined for</td> </tr> </tbody> </table>		Upload Request	Behavior	Bill Cycle Update	The bill cycle information is updated for the accounts.	Billable Charge	The billable charges are created.	Contract Rider Update	The contract rider information is updated for the contracts.	Hold Request	The hold requests are created.	Refund Request	The refund requests are created.	Write Off Request	The write off requests are created.	Policy Reinstatement	The policies are reinstated and the status of the policies is changed to the one defined in the Policy Status after Processing Reinstatement Upload Request parameter of the C1-REN-VALID algorithm.	Bill Group Sorting	The sort ID is defined for the respective bill group.	Bill Group Derivation and Pricing Parameters	The derivation and pricing parameters are defined for
Upload Request	Behavior																					
Bill Cycle Update	The bill cycle information is updated for the accounts.																					
Billable Charge	The billable charges are created.																					
Contract Rider Update	The contract rider information is updated for the contracts.																					
Hold Request	The hold requests are created.																					
Refund Request	The refund requests are created.																					
Write Off Request	The write off requests are created.																					
Policy Reinstatement	The policies are reinstated and the status of the policies is changed to the one defined in the Policy Status after Processing Reinstatement Upload Request parameter of the C1-REN-VALID algorithm.																					
Bill Group Sorting	The sort ID is defined for the respective bill group.																					
Bill Group Derivation and Pricing Parameters	The derivation and pricing parameters are defined for																					

If...	Then...	
	Upload Request	Behavior the respective bill group and sort ID combination.
In addition, the status of the upload request is changed to Processed .		

Note: The **Approve** button appears when:

- The upload request is in the **Approval In Progress** status.
- A user with the approval To Do role is reviewing the upload request.

Related Topics

For more information on...	See...
Upload Request screen	Upload Request (Used for Viewing) on page 1853
Upload Request zone	Upload Request on page 1854
How to search for an upload request	Searching for an Upload Request on page 1848

Rejecting an Upload Request

Prerequisites

To reject an upload request, you should have:

- Rejection reasons defined in the application

Note:

While rejecting an upload request, you need to specify the reason why you want to reject the upload request. You can select the appropriate rejection reason when you have defined the reasons for the **Rejected** status of the **C1-UplRequestType** business object in the **Status Reason** screen.

The system will not allow you to approve or reject an upload request submitted by you.

Procedure

To reject an upload request:

1. Do either of the following:

If you want to	Then
Reject an upload request through the Upload Request screen	<ol style="list-style-type: none"> 1. Search for the upload request in the Upload Request screen. 2. In the Search Results section, click the link in the Upload Request Information column corresponding to the upload request which you want to review.
Reject an upload request from the To Do List screen	<ol style="list-style-type: none"> 1. Click the Menu link in the Application toolbar. A list appears.

If you want to	Then
	<ol style="list-style-type: none"> 2. From the Main menu, select To Do and then click To Do List. The To Do Type for User Search window appears. 3. Enter the required To Do type in the respective field. 4. Click the Search button corresponding to the To Do Type field. The To Do List screen appears. 5. Select the Open option from the Filter by list to view all unassigned To Dos. 6. Click the link in the Message column corresponding to the To Do of the upload request that you want to review.

The **Upload Request** screen appears.

2. Review the upload request details.
3. Click the **Reject** button in the **Upload Request** zone.

The **Reject Upload Request** window appears. It contains following fields:

Field Name	Field Description	Mandatory (Yes or No)
Status Reason	Used to indicate the reason why you want to reject the upload request.	Yes
Comments	Used to specify additional information while rejecting the upload request.	No

Note: The **Reject** button appears when:

- The upload request is in the **Approval In Progress** status.
- A user with the approval To Do role is reviewing the upload request.

4. Select the rejection reason from the **Status Reason** list.
5. Click **Save**.

The status of the upload request is changed to **Rejected**.

Related Topics

For more information on...	See...
How to search for an upload request	Searching for an Upload Request on page 1848
Upload Request screen	Upload Request (Used for Viewing) on page 1853
Upload Request zone	Upload Request on page 1854

Viewing the Data Record Details

Procedure

To view the details of a data record:

1. Search for the data record in the **Data Records** zone in the **Upload Request** screen.
2. In the **Search Results** section, click the **View** () icon in the **View** column corresponding to the data record whose details you want to view.

The **Data Record Details** window appears. It contains the following fields:

Field Name	Field Description
Sr. No.	Displays the sequential number of data.
CSV Column Header	Displays name of the column in uploaded CSV file.
CSV Column Value	Displays value in the column in uploaded CSV file.

3. View the details of the data record in the **Data Record Details** window.

Related Topics

For more information on...	See...
Data Record zone	Data Records on page 1856

Viewing the Log of an Upload Request

Procedure

To view the log of an upload request:

1. Search for the upload request in the **Upload Request** screen.
2. In the **Search Results** section, click the link in the **Upload Request Information** column corresponding to the upload request whose log you want to view.

The **Upload Request** screen appears. It consists of the following tabs:

- **Main** – Displays information about the upload request. It contains the following zones:
 - **Upload Request** – Displays the details of the upload request.
 - **Data Records** – Lists the data records of the upload request.
 - **Log** – Lists the complete trail of actions performed on the upload request. This tab contains the following zone:
 - **Upload Request Log** – Displays the trail of actions performed on the particular upload request.
3. Click the **Log** tab.

The **Upload Request Log** zone in the **Log** tab contains the following columns:

Column Name	Column Description
Date/Time	Displays the date and time when the action was performed on the upload request.

Column Name	Column Description
Details	Displays the details about the action performed on the upload request.
User	Indicates the user who has performed the action on the upload request.
Log Type	Indicates the type of log.
Related Object	Indicates the object or entity which is generated when the action is performed on the upload request.
Status Reason	Indicates the reason why the upload request was rejected.

Note: You can manually add a log entry for the upload request by clicking the **Add Log Entry** link in the upper right corner of the **Upload Request Log** zone.

Related Topics

For more information on...	See...
How to search for an Upload request	Searching for an Upload Request on page 1848
How to add a log entry for an Upload request	Adding a Log Entry for an Upload Request on page 1870

Adding a Log Entry for an Upload Request

Procedure

To add a log entry for an upload request:

1. Search for the upload request in the **Upload Request** screen.
2. In the **Search Results** section, click the link in the **Upload Request Information** column corresponding to the upload request whose log you want to edit.

The **Upload Request** screen appears. It consists of the following tabs:

- **Main** – Displays information about the upload request. It contains the following zones:
 - **Upload Request** – Displays the details of the upload request.
 - **Data Records** – Lists the data records of the upload request.
- **Log** – Lists the complete trail of actions performed on the upload request. This tab contains the following zone:
 - **Upload Request Log** – Displays the trail of actions performed on the particular upload request.

3. Click the **Log** tab.

The **Log** tab appears.

4. Click the **Add Log Entry** link in the upper right corner of the **Upload Request Log** zone.

The **Add Upload Request Log** window appears. It contains the following fields:

Field Name	Field Description	Mandatory (Yes or No)
Upload Request Information	Displays information about the upload request.	Not applicable
Log Details	Used to specify additional comments for the upload request.	Yes

5. Enter the comments in the **Log Details** field.
6. Click **Save**.

The log entry is added in the **Upload Request Log** zone.

Related Topics

For more information on...	See...
How to search for an upload request	Searching for an Upload Request on page 1848

Chapter 28

General Ledger (GL) Accounting Template

Topics:

- [GL Accounting Template \(Without Approval\) Status Transition](#)
- [GL Accounting Template \(With Approval\) Status Transition](#)
- [Algorithms Used in C1- GLAT](#)
- [Prerequisites](#)
- [GL Accounting Template \(Used for Searching\)](#)
- [GL Accounting Template \(Used for Viewing\)](#)

Oracle Revenue Management and Billing until now created FT GL entries while generating the financial transactions for adjustments, payments, and bill segments. The FT GL entries were created using the distribution codes from the adjustment type, rate component, billable charge pass through line, or contract type depending on the type of financial transaction. Now, the system enables you to override the distribution code used for creating FT GL entries using the GL Accounting Template feature.

The system allows you to define a GL Accounting template for each process and sub processes combination for a date range. Based on the parameters defined in the **FT Generation** algorithms, the system either uses the standard process or GL Accounting Template for FT GL creation. The GL Accounting template for the specified process and sub processes combination which is effective on the accounting date is used for FT GL creation.

There should be at least one debit and credit lines in the GL Accounting template. You can define maximum 10 lines in the GL Accounting template. Each line should contain the following information:

- Whether the line should be used to create a debit FT GL entry or credit FT GL entry
- Conditional algorithm (created using the **C1-GLATLC** algorithm type) to indicate whether the line should be used to create the FT GL entry or not
- Distribution code to indicate the GL Account against which the FT GL entry should be created
- User defined amount, such as Amount 01, Amount 02, or Amount 03

The line with the Amount 01 user defined amount is used to create balancing FT GL entry against the contract type. The line with the Amount 02, Amount 03, ..., and Amount 10 user defined amount is used to create FT GL entries for bill segment calculation lines, non-calculated adjustments, adjustment calculation lines, or payments. In case of bill segments and calculated adjustments, the lines with the Amount 02, Amount 03, ..., Amount 10 user defined amount are mapped to calculation line amounts based on the rate component sequence.

You can optionally configure the system to use the approval workflow process while activating or deactivating the GL Accounting templates. If you want to enable the approval workflow process, you need to define algorithms using the following algorithm types:

- C1-GLATAPPEN
- C1-GLATSUB

If the **Approval Required (Y or N)** parameter in an algorithm created using the **C1-GLATSUB** algorithm type is set to **Y**, then on submitting or deactivating the GL Accounting template, the approval workflow process creates a To Do

for the approver to review the GL Accounting template. Once the approver approves a GL Accounting template, the status of the GL Accounting template is set to **Active** or **Inactive**.

We are supporting the following process and sub processes combinations while creating the GL Accounting template:

Process	BS	AD	PS
Sub Process 1	Contract Type	Adjustment Type	Bank Account
Sub Process 2	Division	Contract Type	Contract Type
Sub Process 3	Rate Schedule	Division	Division
Sub Process 4	-	-	-
Sub Process 5	-	-	-

For example, you can define the following the GL Accounting templates using the above supported process and sub processes combinations:

GL Accounting Template	Process	Sub Process 1	Sub Process 2	Sub Process 3
GLAT1	BS	CT1	D1	RS1
GLAT2	BS	CT2	D1	RS1
GLAT3	BS	CT3	D2	RS2
GLAT4	PS	BA1	CT1	D1
GLAT5	PS	BA2	CT2	D2
GLAT6	AD	AT1	CT1	D1
GLAT7	AD	AT1	CT2	D2

While creating the GL Accounting template for BS and AD processes, you need to ensure that the line with the Amount 1 user defined amount is a debit line. However, while creating the GL Accounting template for PS process, you need to ensure that the line with the Amount 1 user defined amount is a credit line.

Based on the customer requirements, you can define GL Accounting template for various custom process and sub processes combinations.

The **Create Additional FT GL Entries** parameter is added in the **Assign GL Account to Financial Transaction (C1-GLASN)** and **Assign GL Account to Financial Transaction (GLASSGN2)** batches. If you set this parameter to **Y**, the **C1-GLCE** algorithm is invoked. Based on the parameters defined in the algorithm, the system checks whether there is a GL Accounting template which is effective on the accounting date for the specified process and sub processes combination. If the effective GL Accounting template is available, the system creates additional FT GL entries for the financial transactions. If the financial transaction's currency is different from the division's base currency, the algorithm will create FT GL extension for the respective financial transaction.

Two new parameters are added in the **ADJT-NM**, **ADJT-AC**, **ADJT-TA**, **ADJT-TC**, **ADJT-AD**, **ADJT-GL**, **PSEG-NM**, **PSEG-AC**, **PSEG-CA**, **BSBF-BA**, **BSBF-LO** algorithm types:

- **Use GL Accounting Template (Y or N)** - Indicates whether the FT GL entries should be created using the lines in the GL Accounting template. The valid values are **Y** and **N**.
- **Show the GL Accounting Template Error When Header Record Not Found (Y or N)** - Indicates whether you want to show error message when the effective GL Accounting template is not available for the process and sub processes combination. If you set the value of this parameter to **N**, the algorithm uses the standard process for FT GL creation when the effective GL Accounting template is not available.

The following table explains how the algorithms created using the following algorithm types create FT GL entries:

Algorithm Type	Use GL Accounting Template (Y or N)	Calculated Adjustment Distribution Code Source (AT - Adjustment Type, CL - Calc Lines)	Algorithm Behaviour
ADJT-NM, ADJT-AC, ADJT-TA, ADJT-TC, ADJT-AD, and ADJT-GL	N	CL	Creates FT GL for the adjustment calculation line using the distribution code on the respective rate component and the balancing FT GL using the distribution code on contract type.
ADJT-NM, ADJT-AC, ADJT-TA, ADJT-TC, ADJT-AD, and ADJT-GL	Y	CL	Creates debit and credit FT GL entries using the lines in the GL Accounting template.
ADJT-NM, ADJT-AC, ADJT-TA, ADJT-TC, ADJT-AD, and ADJT-GL	N	AT	Creates FT GL for the adjustment using the distribution code on the respective adjustment type and the balancing FT GL using the distribution code on contract type.
ADJT-NM, ADJT-AC, ADJT-TA, ADJT-TC, ADJT-AD, and ADJT-GL	Y	AT	Creates debit and credit FT GL entries using the lines in the GL Accounting template.

If the **Use GL Accounting Template (Y or N)** parameter is set to **N** in the algorithms created using the **PSEG-NM**, **PSEG-AC**, and **PSEG-CA** algorithm types, the system creates FT GL for the payment segment using the distribution code on the respective payment segment type and the balancing FT GL using the distribution code on contract type. However, if the **Use GL Accounting Template (Y or N)** parameter is set to **Y**, the system creates debit and credit FT GL entries using the lines in the GL Accounting template.

If the **Use GL Accounting Template (Y or N)** parameter is set to **N** in the algorithms created using the **BSBF-BA** and **BSBF-LO** algorithm types, the system behaves in the following manner:

If the bill segment is...	Then, the system...
Created from a billable charge with SQI and/or price item details	Creates FT GL for the bill segment calculation line using the distribution code on the respective rate component and the balancing FT GL using the distribution code on contract type.
Created from a pass through billable charge	Creates FT GL for the pass through line using the distribution code on the respective pass through line and the balancing FT GL using the distribution code on contract type.
Created from a billable charge with pass through charges, SQI, and price item details	Creates... <ul style="list-style-type: none"> • FT GL for the bill segment calculation line using the distribution code on the respective rate component • FT GL for the pass through line using the distribution code on the respective pass through line • Balancing FT GL using the distribution code on contract type
A post processing bill segment	Creates FT GL for the post processing FT using the distribution code on the respective rate component and the balancing FT GL using the distribution code on contract type.

However, if the **Use GL Accounting Template (Y or N)** parameter is set to **Y** in the algorithms created using the **BSBF-BA** and **BSBF-LO** algorithm types, the system behaves in the following manner:

If the bill segment is...	Then, the system...
Created from a billable charge with SQI and/or price item details	Creates debit and credit FT GL entries using the lines in the GL Accounting template.
Created from a pass through billable charge	Does not use the GL Accounting template. It creates FT GL for the pass through line using the distribution code on the respective pass through line and the balancing FT GL using the distribution code on contract type.
Created from a billable charge with pass through charges, SQI, and price item details	Creates... <ul style="list-style-type: none"> • FT GL for bill segment calculation line using the lines in the GL Accounting template. • FT GL for the pass through line using the distribution code

If the bill segment is...	Then, the system...
	on the respective pass through line. <ul style="list-style-type: none"><li data-bbox="1096 281 1471 342">• Balancing FT GL using the line in the GL Accounting template.
A post processing bill segment	Creates debit and credit FT GL entries using the lines in the GL Accounting template.

GL Accounting Template (Without Approval) Status Transition

The following figure graphically indicates how a GL accounting template moves from one status to another when the Approval Required (Y or N) parameter in the C1-GLATSUB algorithm is set to N.

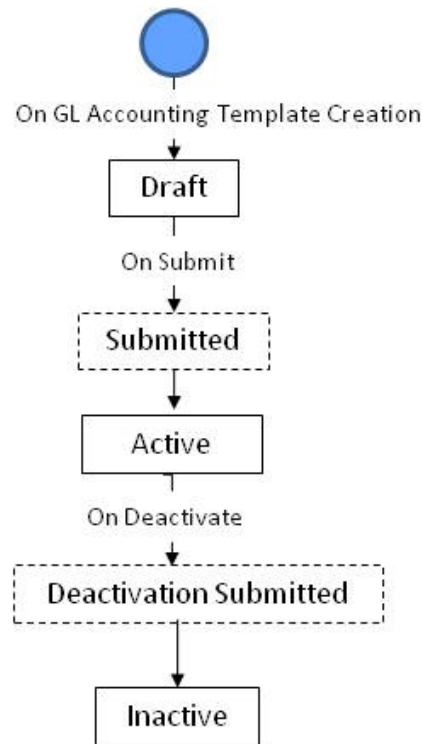

GL Accounting Template (With Approval) Status Transition

The following figure graphically indicates how a GL accounting template moves from one status to another when the Approval Required (Y or N) parameter in the C1-GLATSUB algorithm is set to Y.

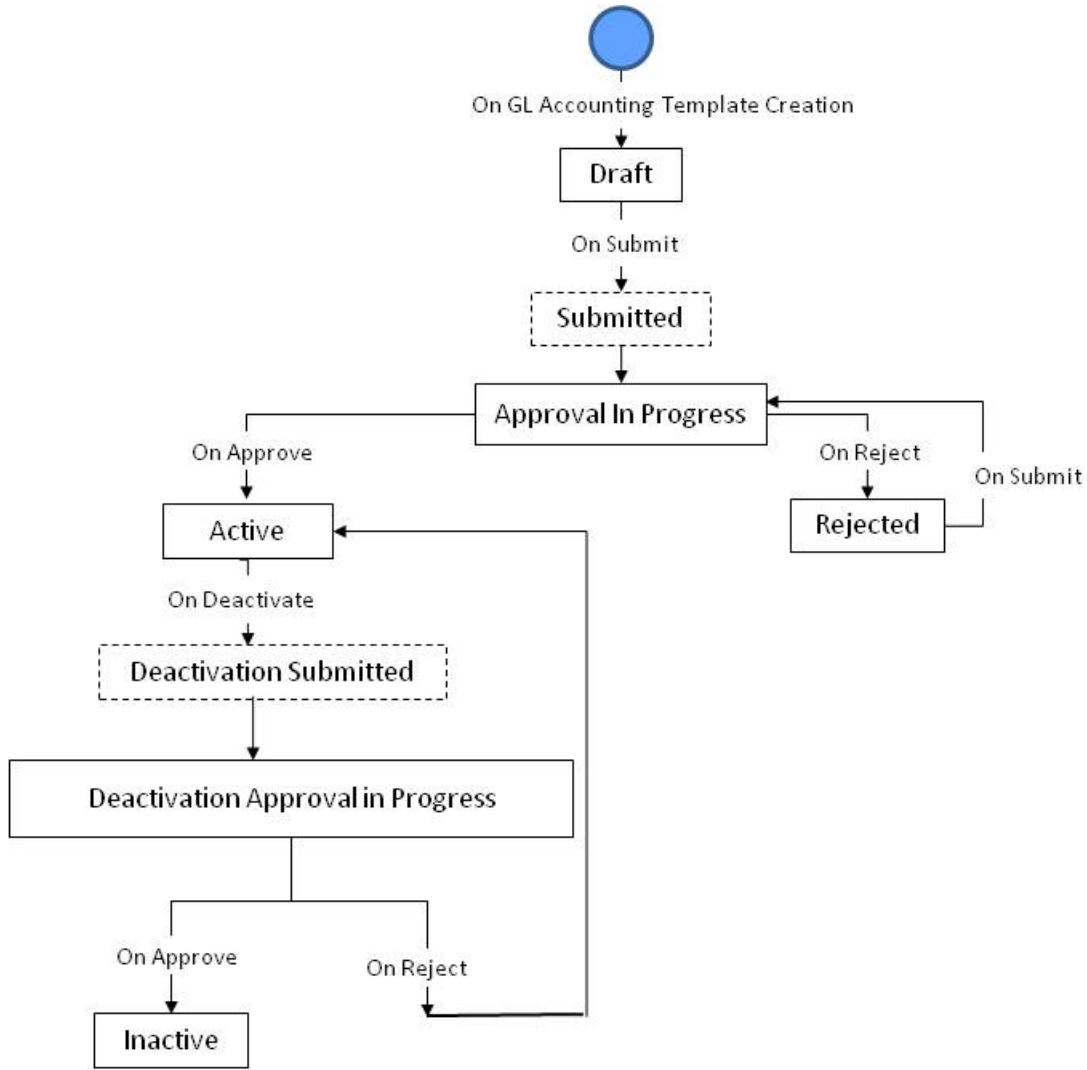

Algorithms Used in C1- GLAT

The following table lists the algorithms which are attached to the **C1-GLAT** business object:

System Event	Algorithm	Algorithm Type	Description
Information	C1-GLAT-INF	C1-GLAT-INF	This algorithm generates the GLAT information string which appears throughout the application. This algorithm concatenates the following fields: <ul style="list-style-type: none"> GLAT Description GLAT Status Description GLAT ID

The following table lists the algorithms which are used in the lifecycle of the **C1-GLAT** business object:

Status	System Event	Algorithm	Algorithm Type	Description
Draft	Exit	F1-TODOCOMPL	F1-TODOCOMPL	This algorithm type completes To Do entries that are linked to an object when the object exits a given state. The system finds all open To Do entries with drill keys for the current business object's primary key, and completes them, unless the To Do entry's type has been configured with an Exclude To Do Type Characteristic Type indicating that it should not be automatically completed.
Submitted	Enter	C1-GLATSUB	C1-GLATSUB	This algorithm checks the following: <ul style="list-style-type: none"> If soft parameter value is set to Y then approval workflow will be triggered.
Approval in Progress	Enter	C1-GLATAPPEN	C1-GLATAPPEN	This algorithm creates the To Do based on the Approval To Do Type configured in algorithm.
Approval in Progress	Exit	C1-GLATAPPEX	C1-GLATAPPEX	This algorithm checks whether an approver is associated with the approval To Do Role specified in the C1-GLATAAPEN Algorithm. It does not allow the submitter to approve or reject the GLAT request.
Approval in Progress	Exit	F1-TODOCOMPL	F1-TODOCOMPL	This algorithm type completes To Do entries that are linked to an object when the object exits a given state. The system finds all open To Do entries with drill keys for the current business object's primary key, and completes them, unless the To Do entry's type has been configured with an Exclude To Do Type Characteristic Type indicating that it should not be automatically completed.
Active	-	-	-	-
Deactivation Submitted	Enter	C1-GLATSUB	C1-GLATSUB	This algorithm checks the following: <ul style="list-style-type: none"> If soft parameter value is set to Y then approval workflow will be triggered.
Deactivation Approval In Progress	Enter	C1-GLATAPPEN	C1-GLATAPPEN	This algorithm creates the To Do based on the Approval To Do Type configured in algorithm.
Deactivation Approval In Progress	Exit	C1-GLATAPPEX	C1-GLATAPPEX	This algorithm checks whether an approver is associated with the approval To Do Role specified in

Status	System Event	Algorithm	Algorithm Type	Description
				the C1-GLATAAPEN Algorithm. It does not allow the submitter to approve or reject the GLAT request.
Deactivation Approval In Progress	Exit	F1-TODOCOMPL	F1-TODOCOMPL	This algorithm type completes To Do entries that are linked to an object when the object exits a given state. The system finds all open To Do entries with drill keys for the current business object's primary key, and completes them, unless the To Do entry's type has been configured with an Exclude To Do Type Characteristic Type indicating that it should not be automatically completed.
Rejected	Exit	F1-TODOCOMPL	F1-TODOCOMPL	This algorithm type completes To Do entries that are linked to an object when the object exits a given state. The system finds all open To Do entries with drill keys for the current business object's primary key, and completes them, unless the To Do entry's type has been configured with an Exclude To Do Type Characteristic Type indicating that it should not be automatically completed.
Inactive	-	-	-	-

Prerequisites

To setup the GL Accounting Template, you need to do the following:

- Define rejected status reasons for the **C1-GLAT** business object
- Define deactivated status reasons for the **C1-GLAT** business object
- Assign the **C1-GLAT** To Do type to a To Do role whose users must receive To Do generated while submitting a template for approval
- Define the required algorithms, for approval and To Do type role and configurations

GL Accounting Template (Used for Searching)

The **GL Accounting Template** screen allows you to search for a template using various search criteria. It also allows you to create template. Through this screen, you can navigate to the following screen:

- [GL Accounting Template \(Used for Viewing\)](#) on page 1887

This screen consists of the following zones:

- [Search GL Accounting Template](#) on page 1882
- [GL Accounting Template Lines](#) on page 1883

Search GL Accounting Template

The **Search GL Accounting Template** zone allows you to search for GL accounting templates using various search criteria. This zone contains the following two sections:

- **Search Criteria** — The **Search Criteria** section contains the following fields:

Field Name	Field Description	Mandatory (Yes or No)
Template ID	Used to search a particular template.	No
Description	Used to specify the description of a template.	No
Status	Used to indicate the status of the template. The valid values are: <ul style="list-style-type: none"> • Draft • Approval In Progress • Deactivation Approval In Progress • Active • Inactive • Rejected 	No
Process	Used to search a particular process.	No
Sub Process 1	Used to search a particular Sub Process 1.	No
Sub Process 2	Used to search a particular Sub Process 2.	No
Sub Process 3	Used to search a particular Sub Process 3.	No
Sub Process 4	Used to search a particular Sub Process 4.	No
Sub Process 5	Used to search a particular Sub Process 5.	No
Effective Start Date	Used to search templates which are effective from a particular date.	No
Effective End Date	Used to search templates which are effective till a particular date.	No

Note: You must specify at least one search criterion while searching for a template.

- **Search Results** — On clicking the **Search** button, the search results appear based on the specified search criteria. The **Search Results** section contains the following columns:

Column Name	Column Description
Process	Displays the process.
GL Accounting Template Request Information	Displays information about the template. <p>Note: It has a link. On clicking the link, the GL Accounting Template screen appears where you can view the details of the respective template.</p>
Description	Displays the description of process.
Sub Process 1	Displays the Sub Process 1.
Sub Process 2	Displays the Sub Process 2.

Column Name	Column Description
Sub Process 3	Displays the Sub Process 3.
Sub Process 4	Displays the Sub Process 4.
Sub Process 5	Displays the Sub Process 5.
Effective Start Date	Displays the date from when the template is effective.
Effective End Date	Displays the date till when the template is effective.
Status	Displays the status of template.

Related Topics

For more information on...	See...
How to search for a GL Accounting Template	Searching for a GL Accounting Template on page 1883
How to view the details of a GL Accounting Template	Viewing the GL Accounting Template Details on page 1886
How to create a GL Accounting Template	Creating a GL Accounting Template on page 1884
GL Accounting Template Lines zone	GL Accounting Template Lines on page 1883

GL Accounting Template Lines

The **GL Accounting Template Lines** zone displays the details of the template lines. This zone contains the following columns:

Column Name	Column Description
Credit/Debit	Displays whether the template lines are of credit or debit.
Conditional Algorithm	Displays the algorithm that specified that template line is valid or not.
Distribution Code	Displays the distribution code which indicates the template associated with the charge.
User Defined Amount Field	Displays the amount to be used in a template line.

Note: By default, the **GL Accounting Template Lines** zone does not appear in the **GL Accounting Template** screen. It appears when you click the **Broadcast** (📢) icon corresponding to the template in the **Search Results** section.

Related Topics

For more information on...	See...
How to search for a GL Accounting Template	Searching for a GL Accounting Template on page 1883
How to view the details of a GL Accounting Template	Viewing the GL Accounting Template Details on page 1886
How to create a GL Accounting Template	Creating a GL Accounting Template on page 1884
Search GL Accounting Template zone	Search GL Accounting Template on page 1882

Searching for a GL Accounting Template

Procedure

To search for a GL Accounting template:

1. Click the **Admin** link in the **Application** toolbar.
A list appears.
2. From the **Admin** menu, select **G** and then click **GL Accounting Template**.
The **GL Accounting Template** screen appears.
3. Enter the search criteria in the **Search GL Accounting Template** zone.

Note: ORMB search engine supports wildcard search, where you can substitute the percentage (%) symbol as a stand in for any word or letter in a search criteria. You can use the ‘%’ wildcard character in all input fields except the date and ID fields. The ‘%’ wildcard character is suffixed automatically at the end of the partial search criteria. Therefore, you may or may not specify the wildcard character at the end of the partial search criteria. However, you have to prefix the wildcard character manually wherever required.

4. Click **Search**.
A list of templates that meet the search criteria appears in the **Search Results** section.

Related Topics

For more information on...	See...
GL Accounting Template screen	GL Accounting Template (Used for Searching) on page 1881
Search GL Accounting Template zone	Search GL Accounting Template on page 1882

Creating a GL Accounting Template

Prerequisites

To create a GL Accounting template, you should have:

- Conditional Algorithms and Distribution codes defined in the application.

Procedure

To create a GL Accounting template:

1. Click the **Admin** link in the **Application** toolbar.
A list appears.
2. From the **Admin** menu, select **G** and then click **GL Accounting Template**.
The **GL Accounting Template** screen appears.
3. Click the **Add** button in the **Page Title** area of the **GL Accounting Template** screen.

The **GL Accounting Template** screen appears. It contains the following sections:

- **Main** — Used to specify basic details about the template. This section contains the following fields:

Field Name	Field Description	Mandatory (Yes or No)
Process	Used to specify a particular process.	Yes
Description	Used to indicate the description of a process.	Yes
Sub Process 1	Used to specify a Sub Process 1.	Yes (Conditional)

Field Name	Field Description	Mandatory (Yes or No)
		Note: This field is required if Process is Bill Segment or Payment Segment or Adjustments
Sub Process 2	Used to specify a Sub Process 2.	Yes (Conditional) Note: This field is required if Process is Bill Segment or Payment Segment or Adjustments
Sub Process 3	Used to specify a Sub Process 3.	Yes (Conditional) Note: This field is required if Process is Bill Segment or Payment Segment or Adjustments.
Sub Process 4	Used to specify a Sub Process 4.	No
Sub Process 5	Used to specify a Sub Process 5.	No
Effective Start Date	Used to specify date for a template which is effective from a particular date.	Yes
Effective End Date	Used to specify date for a template which is effective till a particular date.	No

- **GL Accounting Template Lines** —Used to specify the template lines in a GL accounting template. This section contains the following columns:

Column Name	Column Description	Mandatory (Yes or No)
Sequence No	Used to specify the sequence number.	Yes
Credit/Debit	Used to indicate whether template lines are of credit or debit.	Yes
Conditional Algorithm	Used to specify the algorithm which specifies that template line is valid or not.	No
Distribution Code	Used to indicate the distribution code which indicates the template associated with the charge.	Yes
User Defined Amount Field	Used to indicate the amount to be used in a template line.	Yes

4. Enter the required details

Note:

You can search for a conditional algorithm and distribution code by clicking the **search** (🔍) icon corresponding to the respective field.

At least one credit and one debit line is required while defining a template.

System will not allow to add a template having same set of process, sub processes and effective date. If there is a template already created and its status is Inactive, then only template can be created with same set of process, sub processes and effective date.

Each conditional line must have unique User Defined Amount Field value.

5. Add template lines for a template defined.

6. Click **Save**.

The GL Accounting template is created and the status of the template is set to **Draft**. The **GL Accounting Template** screen appears with the details of template.

Related Topics

For more information on...	See...
GL Accounting Template screen	GL Accounting Template (Used for Searching) on page 1881
How to edit a GL Accounting Template	Editing a GL Accounting Template on page 1890

Viewing the GL Accounting Template Details**Procedure**

To view the details of a GL Accounting Template:

1. Search for the template in the **GL Accounting Template** screen.
2. In the **Search Results** section, click the link in the **GL Accounting Template Information** column corresponding to the template whose details you want to view.

The **GL Accounting Template** screen appears. It consists of the following tabs:

- **Main** – Displays information about the template. It contains the following zone:
 - **GL Accounting Template** – Displays the details of the template.
- **Log** – Lists the complete trail of actions performed on the template. This tab contains the following zone:
 - **GL Accounting Template Log** – Displays the trail of actions performed on the particular template.

3. View the details of the template in the **GL Accounting Template** zone.

Related Topics

For more information on...	See...
GL Accounting Template screen	GL Accounting Template (Used for Searching) on page 1881
GL Accounting Template zone	GL Accounting Template on page 1887
How to search for a GL Accounting Template	Searching for a GL Accounting Template on page 1883
How to view a GL Accounting Template Lines	Viewing the GL Accounting Template Lines Details on page 1887

Viewing the GL Accounting Template Lines Details

Procedure

To view the details of a GL Accounting Template Lines:

1. Search for the template in the **GL Accounting Template** screen.
2. In the **Search Results** section, click the **Broadcast** () icon corresponding to the template in the **Search Results** section.

The **GL Accounting Template Lines** zone appears in the **GL Accounting Template** screen.

3. View the details of the template lines in the **GL Accounting Template Lines** zone.

Related Topics

For more information on...	See...
GL Accounting Template screen	GL Accounting Template (Used for Searching) on page 1881
GL Accounting Template zone	GL Accounting Template on page 1887
GL Accounting Template Lines zone	GL Accounting Template Lines on page 1883

GL Accounting Template (Used for Viewing)

Once you create a template, the **GL Accounting Template** screen allows you to:

- View the details of a template
- Edit the details of a template
- Delete a template
- Submit a template for approval
- Approve or reject a template
- Deactivate a template

This screen consists of the following tabs:

- **Main** – Displays information about the template. It contains the following zone:
 - **GL Accounting Template** – Displays the details of the template.
- **Log** – Lists the complete trail of actions performed on the template. This tab contains the following zone:
 - **GL Accounting Template Log** – Displays the trail of actions performed on the particular template.

GL Accounting Template - Main

The **Main** tab on the **GL Accounting Template** contains the following zone:

[GL Accounting Template](#) on page 1887

GL Accounting Template

The **GL Accounting Template** zone displays the details of the template. This zone contains the following sections:

- **Main** – This section provides basic information about the GL Accounting template. It contains the following fields:

Field Name	Field Description
GL Accounting Template Information	Displays information about the template
Status	Indicates the status of the template.
Process	Displays the process.
Description	Displays the description of the process.
Sub Process 1	Displays the Sub Process 1.
Sub Process 2	Displays the Sub Process 2.
Sub Process 3	Displays the Sub Process 3.
Sub Process 4	Displays the Sub Process 4.
Sub Process 5	Displays the Sub Process 5.
Effective Start Date	Displays the date from when the template is effective.
Effective End Date	Displays the date till when the template is effective.

- **GL Accounting Template Lines** – Lists the GL Accounting template lines. It contains the following columns:

Column Name	Column Description
Sequence No	Displays the sequence number.
Credit/Debit	Displays whether the template lines are of credit or debit.
Conditional Algorithm	Displays the algorithm that specified that template line is valid or not.
Distribution Code	Displays the distribution code which indicates the template associated with the charge.
User Defined Amount Field	Displays the amount to be used in a template line.

- **Record Actions** – This section contains the following buttons:

Button Name	Button Description
Edit	Used to edit the details of the template.
	Note: The Edit button appears when the template is in the Draft or Rejected status.
Delete	Used to delete the template.
	Note: The Delete button appears when the template is in the Draft or Rejected status.
Submit	Used to activate the template.
	Note: The Submit button appears when the template is in the Draft or Rejected status.
Approve	Used to approve the template.

Button Name	Button Description
	Note: the Approve button appears when the template is in the Approval In Progress or Deactivation Approval In Progress status.
Reject	Used to reject the template. Note: the Reject button appears when the template is in the Approval In Progress or Deactivation Approval In Progress status.
Deactivate	Used to deactivate the active template. Note: The Deactivate button appears when the template is in the Active status.

- **Record Information** – This section contains the following fields:

Field Name	Field Description
Business Object	Indicates the business object using which the template is created. In addition, a context menu appears corresponding to this field which helps in navigating to other screens in the application. Note: It has a link. On clicking the link, the Business Object screen appears where you can view the details of the respective business object.

GL Accounting Template - Log

The **Log** tab on the **GL Accounting Template** screen contains the following zone:

[GL Accounting Template Log](#) on page 1889

GL Accounting Template Log

The **GL Accounting Template Log** zone on the **GL Accounting Template** screen lists the complete trail of actions performed on the GL Accounting template. This zone contains the following columns:

Column Name	Column Description
Date/Time	Displays the date and time when the action was performed on the template.
Details	Displays the details about the action performed on the template.
User	Indicates the user who has performed the action on the template.
Log Type	Indicates the type of log.
Related Object	Indicates the object or entity which is generated when the action is performed on the template.
Status Reason	Displays the status reason of action performed on the template.

Note: You can manually add a log entry for the template by clicking the **Add Log Entry** link in the upper right corner of the **GL Accounting Template Log** zone.

The **Add GL Accounting Template Log** window appears. Enter **Log Details** and click **Save**. The GL Accounting Template log is added.

Related Topics

For more information on...	See...
How to view the log of a GL Accounting Template	Viewing the Log of a GL Accounting Template on page 1897

Editing a GL Accounting Template

Procedure

To edit a GL Accounting Template:

1. Search for the template in the **GL Accounting Template** screen.
2. In the **Search Results** section, click the link in the **GL Accounting Template Information** column corresponding to the template whose details you want to edit.

The **GL Accounting Template** screen for editing appears.

3. Click the **Edit** button in the **GL Accounting Template** zone.

Note: The **Edit** button appears when the template is in the **Draft** or **Rejected** status.

The **GL Accounting Template** screen appears. It contains the following sections:

- **Main** — Used to specify basic details about the template. This section contains the following fields:

Field Name	Field Description	Mandatory (Yes or No)
Process	Used to specify a particular process.	Yes
Description	Used to indicate the description of a process.	Yes
Sub Process 1	Used to specify a Sub Process 1.	Yes (Conditional) Note: This field is required if Process is Bill Segment or Payment Segment or Adjustments
Sub Process 2	Used to specify a Sub Process 2.	Yes (Conditional) Note: This field is required if Process is Bill Segment or Payment Segment or Adjustments
Sub Process 3	Used to specify a Sub Process 3.	Yes (Conditional) Note: This field is required if Process is Bill Segment or Payment Segment or Adjustments.
Sub Process 4	Used to specify a Sub Process 4.	No
Sub Process 5	Used to specify a Sub Process 5.	No
Effective Start Date	Used to specify date for a template which is effective from a particular date.	Yes
Effective End Date	Used to specify date for a template which is effective till a particular date.	No

- **GL Accounting Template Lines** — Used to specify the template lines in a GL accounting template. This section contains the following columns:

Column Name	Column Description	Mandatory (Yes or No)
Sequence No	Used to specify the sequence number.	Yes
Credit/Debit	Used to indicate whether template lines are of credit or debit.	Yes
Conditional Algorithm	Used to specify the algorithm which specifies that template line is valid or not.	No
Distribution Code	Used to indicate the distribution code which indicates the template associated with the charge.	Yes
User Defined Amount Field	Used to indicate the amount to be used in a template line.	Yes

Note:

If you want to specify more than one template lines, click the **Add (+)** icon corresponding to the sequence No and then specify the details.

However, if you want to remove a template line from the template, click the **Delete (🗑)** icon corresponding to the sequence No.

You can search for a conditional algorithm and distribution code by clicking the **search (🔍)** icon corresponding to the respective field.

At least one credit and one debit line is required while defining a template.

4. Modify the details of the template, if required.
5. Click **Save**.

The changes made to the GL Accounting template are saved.

Related Topics

For more information on...	See...
How to search for a GL Accounting Template	Searching for a GL Accounting Template on page 1883
GL Accounting Template screen	GL Accounting Template (Used for Searching) on page 1881
GL Accounting Template zone	GL Accounting Template on page 1887

Deleting a GL Accounting Template

Procedure

To delete a GL Accounting Template:

1. Search for the template in the **GL Accounting Template** screen.
2. In the **Search Results** section, click the link in the **GL Accounting Template Information** column corresponding to the template that you want to delete.

The **GL Accounting Template** screen appears.

3. Click the **Delete** button in the **GL Accounting Template** zone.

A message appears confirming whether you want to delete the template.

Note: The **Delete** button appears when the template is in the **Draft** or **Rejected** status.

4. Click **OK**.

The GL Accounting template is deleted.

Note:

You can delete a template when its status is **Draft**.

Related Topics

For more information on...	See...
How to search for a GL Accounting Template	Searching for a GL Accounting Template on page 1883
GL Accounting Template screen	GL Accounting Template (Used for Searching) on page 1881
GL Accounting Template zone	GL Accounting Template on page 1887

Submitting a GL Accounting Template

Prerequisites

To submit a GL Accounting Template, you should have:

- Process and GL Accounting template lines defined in the template.

Procedure

To submit a GL Accounting Template:

1. Search for the template in the **GL Accounting Template** screen.
2. In the **Search Results** section, click the link in the **GL Accounting Template Information** column corresponding to the template that you want to submit.

The **GL Accounting Template** screen appears.

3. Click the **Submit** button in the **GL Accounting Template** zone.

The system behaves in the following manner:

If...	Then...
Approval Required Flag is set to Yes in the C1-GLATSUB algorithm.	A To Do of the C1-GLAT To Do type is created and sent to the approver and the status of the template is changed to Approval In Progress .
Approval Required Flag is set to No in the C1-GLATSUB algorithm.	The template is created using the specified process and the status of the template is changed to Active .

Note:

The **Submit** button appears when the template is in the **Draft** or **Rejected** status.

Related Topics

For more information on...	See...
How to search for a GL Accounting Template	Searching for a GL Accounting Template on page 1883
GL Accounting Template screen	GL Accounting Template (Used for Searching) on page 1881
GL Accounting Template zone	GL Accounting Template on page 1887
How to edit a GL Accounting Template	Editing a GL Accounting Template on page 1890
How to delete a GL Accounting Template	Deleting a GL Accounting Template on page 1891

Approving a GL Accounting Template

You can view the number of GL Accounting templates which are pending for approval in the **GL Accounting Template** screen. The approver can review, and accordingly approve or reject the template based on the observations.

Note: The system will not allow you to approve or reject a template submitted by you.

Procedure

To approve a template:

1. Do either of the following:

If you want to...	Then...
Approve a GL Accounting Template through the GL Accounting template screen	<ol style="list-style-type: none"> 1. Search for the template in the GL Accounting template screen. 2. In the Search Results section, click the link in the GL Accounting Template Information column corresponding to the template which you want to review.
Approve a GL Accounting Template from the To Do List screen	<ol style="list-style-type: none"> 1. Click the Menu link in the Application toolbar. A list appears. 2. From the Main menu, select To Do and then click To Do List. The To Do Type for User Search window appears. 3. Enter C1-GLAT in the To Do Type field. 4. Click the Search button corresponding to the To Do Type field. The To Do List screen appears. 5. Select the Open option from the Filter by list to view all unassigned To Dos.

If you want to...	Then...
	6. Click the link in the Message column corresponding to the To Do of the GL Accounting template that you want to review.

The **GL Accounting Template** screen appears.

- Review the template details.
- Click the **Approve** button in the **GL Accounting Template** zone.

The system behaves in the following manner:

If you are...	Then...
Approving a GL Accounting template	The status of the template is changed to Active as specified in the GL Accounting template.

Note: The **Approve** button appears when the template is in the **Approval In Progress** or **Deactivation Approval In Progress** status.

Related Topics

For more information on...	See...
How to search for a GL Accounting Template	Searching for a GL Accounting Template on page 1883
GL Accounting Template screen	GL Accounting Template (Used for Searching) on page 1881
GL Accounting Template zone	GL Accounting Template on page 1887

Rejecting a GL Accounting Template

Prerequisites

To reject a GL Accounting template, you should have:

- Rejection reasons defined in the application

Note:

While rejecting a GL Accounting template, you need to specify the reason why you want to reject the template. You can select the appropriate rejection reason when you have defined the reasons for the **Rejected** status of the **C1-GLAT** business object in the **Status Reason** screen.

The system will not allow you to approve or reject a template submitted by you.

Procedure

To reject a GL Accounting template

- Do either of the following:

If you want to	Then
Reject a GL Accounting template through the GL Accounting Template screen	1. Search for the template in the GL Accounting Template screen.

If you want to	Then
	<ol style="list-style-type: none"> In the Search Results section, click the link in the GL Accounting Template Information column corresponding to the template which you want to review.
Reject a GL Accounting template from the To Do List screen	<ol style="list-style-type: none"> Click the Menu link in the Application toolbar. A list appears. From the Main menu, select To Do and then click To Do List. The To Do Type for User Search window appears. Enter C1-GLAT in the To Do Type field. Click the Search button corresponding to the To Do Type field. The To Do List screen appears. Select the Open option from the Filter by list to view all unassigned To Dos. Click the link in the Message column corresponding to the To Do of the template that you want to review.

The **GL Accounting Template** screen appears.

- Review the template details.
- Click the **Reject** button in the **GL Accounting Template** zone.

The **Reject GLAT Request** window appears. It contains following fields:

Field Name	Field Description	Mandatory (Yes or No)
Status Reason	Used to indicate the reason why you want to reject the template	Yes
Comments	Used to specify additional information while rejecting the template.	No

Note: The **Reject** button appears when:

- The template is in the **Approval In Progress** or **Deactivation Approval In Progress** status.
- A user with the approval To Do role is reviewing the template.

- Select the rejection reason from the **Status Reason** list.
- Click **Save**.

The status of the template is changed to **Rejected**.

Related Topics

For more information on...	See...
How to search for a GL Accounting Template	Searching for a GL Accounting Template on page 1883
GL Accounting Template screen	GL Accounting Template (Used for Searching) on page 1881
GL Accounting Template zone	GL Accounting Template on page 1887
How to approve a GL Accounting Template	Approving a GL Accounting Template on page 1893

Deactivating a GL Accounting Template

Prerequisites

To deactivate a GL Accounting template, you should have:

- Deactivation reasons defined in the application.

Note:

While deactivating a GL Accounting template, you need to specify the reason why you want to deactivate the template. You can select the appropriate deactivation reason when you have defined the reasons for the deactivation status of the **C1-GLAT** business object in the **Status Reason** screen.

Procedure

To deactivate a GL Accounting template:

1. Search for the template in the **GL Accounting Template** screen.
2. In the **Search Results** section, click the link in the **GL Accounting Template Information** column corresponding to the template that you want to deactivate.

The **GL Accounting Template** screen appears.

3. Click the **Deactivate** button in the **GL Accounting Template** zone.

Note: The **Deactivate** button appears when the template is in the **Active** status.

The **Deactivate GLAT Request** window appears. It contains the following fields:

Field Name	Field Description	Mandatory (Yes or No)
Status Reason	Used to indicate the reason for deactivating a template	Yes
Comments	Used to specify the additional comments for the deactivation of template.	No

4. Click **OK**.

The GL Accounting template status is changed to **Deactivation Approval In Progress**.

Related Topics

For more information on...	See...
How to search for a GL Accounting Template	Searching for a GL Accounting Template on page 1883
GL Accounting Template screen	GL Accounting Template (Used for Searching) on page 1881

For more information on...	See...
GL Accounting Template zone	GL Accounting Template on page 1887

Viewing the Log of a GL Accounting Template

Procedure

To view the log of a GL Accounting template:

1. Search for the template in the **GL Accounting template** screen.
2. In the **Search Results** section, click the link in the **GL Accounting Template Information** column corresponding to the template whose log you want to view.

The **GL Accounting Template** screen appears. It consists of the following tabs:

- **Main** – Displays information about the template. It contains the following zone:
 - **GL Accounting Template** – Displays the details of the template.
 - **Log** – Lists the complete trail of actions performed on the template. This tab contains the following zone:
 - **GL Accounting Template Log** – Displays the trail of actions performed on the particular template.

3. Click the **Log** tab.

The **GL Accounting Template Log** zone in the **Log** tab contains the following columns:

Column Name	Column Description
Date/Time	Displays the date and time when the action was performed on the template.
Details	Displays the details about the action performed on the template.
User	Indicates the user who has performed the action on the template.
Log Type	Indicates the type of log.
Related Object	Indicates the object or entity which is generated when the action is performed on the template.
Status Reason	Indicates the reason why the template was rejected or voided.

Note: You can manually add a log entry for the template by clicking the **Add Log Entry** link in the upper right corner of the **GL Accounting Template Log** zone.

Related Topics

For more information on...	See...
How to search for a GL Accounting Template	Searching for a GL Accounting Template on page 1883
How to add a log entry for a GL Accounting Template	Adding a Log Entry for a GL Accounting Template on page 1897

Adding a Log Entry for a GL Accounting Template

Procedure

To add a log entry for a GL Accounting Template:

1. Search for the template in the **GL Accounting Template** screen.
2. In the **Search Results** section, click the link in the **GL Accounting Template Information** column corresponding to the template whose log you want to edit.

The **GL Accounting Template** screen appears. It consists of the following tabs:

- **Main** – Displays information about the template. It contains the following zone:
 - **GL Accounting Template** – Displays the details of the template.
- **Log** – Lists the complete trail of actions performed on the template. This tab contains the following zone:
 - **GL Accounting Template Log** – Displays the trail of actions performed on the particular template.

3. Click the **Log** tab.

The **Log** tab appears.

4. Click the **Add Log Entry** link in the upper right corner of the **GL Accounting Template Log** zone.

The **Add GL Accounting Template Log** window appears. It contains the following fields:

Field Name	Field Description	Mandatory (Yes or No)
GL Accounting Template Information	Displays information about the template.	Not applicable
Log Details	Used to specify additional comments for the template.	Yes

5. Enter the comments in the **Log Details** field.
6. Click **Save**.

The log entry is added in the **GL Accounting Template Log** zone.

Related Topics

For more information on...	See...
How to search for a GL Accounting Template	Searching for a GL Accounting Template on page 1883

Chapter 29

Accrual

Topics:

- [Accrual Created through UI \(Without Approval\) Status Transition](#)
- [Accrual Created through UI \(With Approval\) Status Transition](#)
- [Accrual Created through Batch \(Without Approval\) Status Transition](#)
- [Accrual Created through Batch \(With Approval\) Status Transition](#)
- [Accrual Processes](#)
- [Accrual Cycle \(Used for Searching\)](#)
- [Accrual Cycle \(Used for Viewing\)](#)
- [Accrual Type \(Used for Searching\)](#)
- [Accrual Type \(Used for Viewing\)](#)
- [Accrual \(Used for Searching\)](#)
- [Accrual \(Used for Viewing\)](#)

Oracle Revenue Management and Billing enables you to calculate and create accrual for accounts. An accrual allows an entity to record expenses and revenues for which it expects to expend cash or receive cash, respectively, in a future reporting period.

The accrual is an adjustment which is created for the following:

- Revenues that have been earned but are not yet recorded in the books of accounts.
- Expenses that have been incurred but are not yet recorded in the book of accounts.

The system also enables you to reverse the accrual for accounts. You need to define whether the accounts belonging to a division are eligible for accrual or not. If a division is eligible for accrual, by default, all accounts belonging to the division are eligible for accrual. However, you can exclude an account from accrual, if required. To enable the accruals feature, you need to define the following:

- **Accrual Cycle** – You must specify the following information in the accrual cycle:
 - Dates when accrual should be calculated and created for the accounts where the accrual cycle is defined.
 - Accrual reversal period for each accrual date.

If a division is eligible for accrual, you need to specify the accrual cycle for the division. By default, all accounts belonging to a division will inherit the accrual cycle of the division. However, you can override the accrual cycle of an account

- **Accrual Type** – You must specify the following information in the accrual type:
 - Type of the accrual object that you want to create for posting the accrual amount. At present, the product enables you to create adjustments to record accruals for accounts in the system.
 - Whether you want to calculate the accrual based on the historical or actual data. If you want to calculate the accrual based on the historical data, you need to specify the number of historical bills that you want to consider for accrual calculation. The system will only consider the completed historical bills during accrual calculation. Besides specifying the historical bill count, you also need to specify the type of day (i.e. Business Day or Calendar Day) which is used to calculate the accrual amount. However, if you want to calculate the accrual based on the actual data, you need to specify whether trial bill or unbilled pass through billable charges

created through the Transaction Feed Management process should be considered to calculate the accrual amount.

- Whether you want to calculate accrual at the bill or bill segment level.
- Cancel reason that you want to use while reversing the accrual
- Algorithms that you want to use during the accrual calculation, creation, and reversal
- Whether any objects, such as adjustments created using a particular adjustment type, bill segments created for a particular price item, or adjustments' or bill segments' financial transactions where a particular distribution code is used, must be excluded during the accrual calculation.
- Divisions to which you want to associate the accrual type.

The accrual process includes the following sub-processes:

- **Accrual Calculation** – In this process, accounts that are eligible for accrual will have its accrual amount calculated on the basis of the accrual type configuration.
- **Accrual Creation** – In this process, on the basis of the calculated accrual amount and information configured on the accrual type, the accrual adjustment will be created.
- **Accrual Reversal** – In this process, reversal of accrual adjustments will be done to prevent double posting of revenue, once billing is done. On the basis of the accrual reversal schedule, an account with accrual adjustments will be selected for accrual reversal processing. For every frozen adjustment, a cancellation is done in order to reverse journal entries.

During the accrual process, an accrual goes through various statuses in its lifecycle. You can execute accrual process either using user interface (UI), or batch. For more information about the accrual statuses, see, [Accrual Created through UI \(Without Approval\) Status Transition](#) on page 1901, [Accrual Created through UI \(With Approval\) Status Transition](#) on page 1901, [Accrual Created through Batch \(Without Approval\) Status Transition](#) on page 1902, and [Accrual Created through Batch \(With Approval\) Status Transition](#) on page 1903

Note that the lifecycle of an accrual is driven by the business object using which the accrual is created. An accrual business object named **C1_ACCRUALS** is shipped with the product. The accrual feature explained in this document is articulated based on the lifecycle and logic defined in the **C1_ACCRUALS** business object.

Accrual Created through UI (Without Approval) Status Transition

The following figure graphically indicates how an accrual created from the user interface moves from one status to another when approval workflow is off:

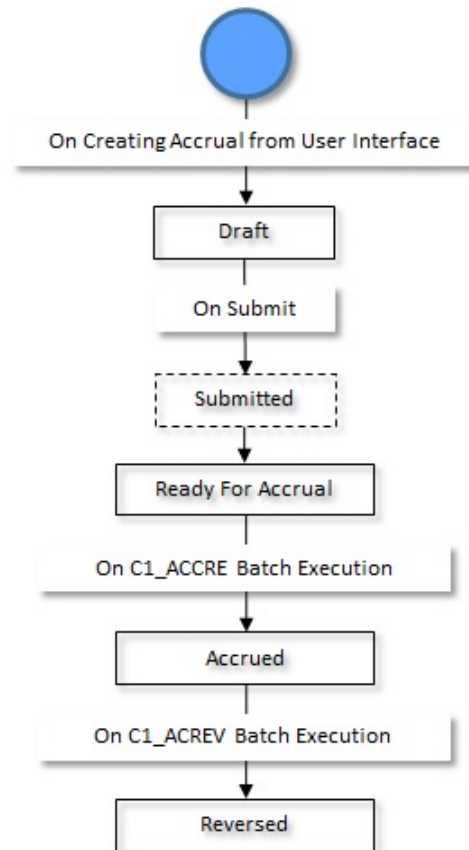

Accrual Created through UI (With Approval) Status Transition

The following figure graphically indicates how an accrual created from the user interface moves from one status to another when the approval workflow is on:

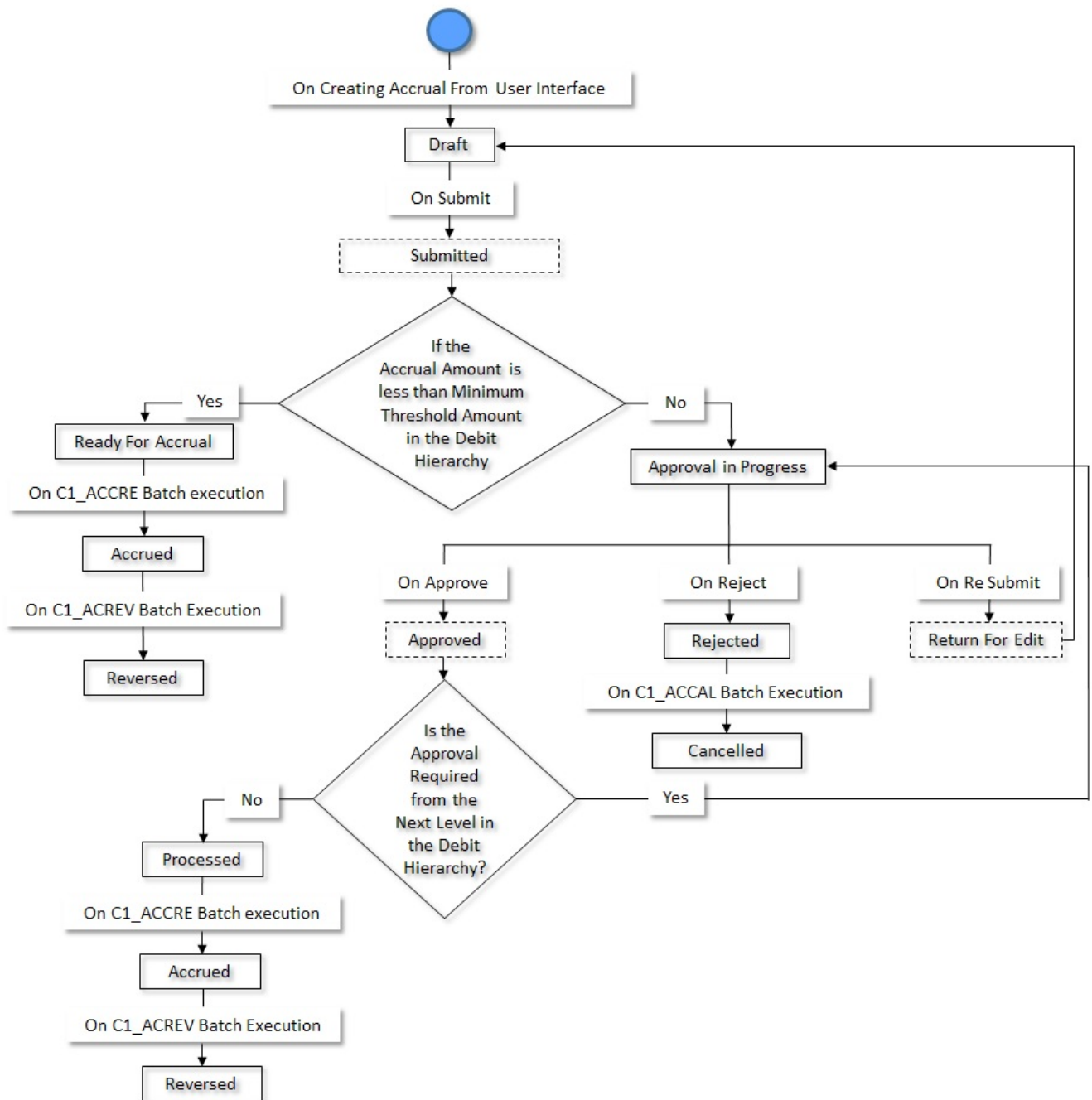

Accrual Created through Batch (Without Approval) Status Transition

The following figure graphically indicates how an accrual created through the batch moves from one status to another when the approval workflow is off:

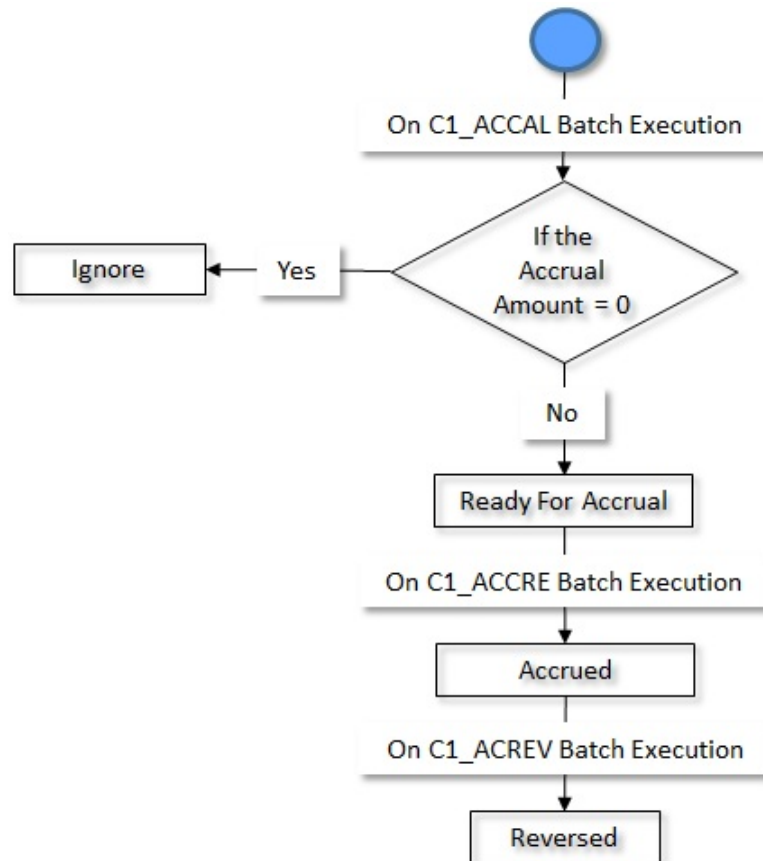

Note: For more information about the batches, refer *Oracle Revenue Management and Billing Batch Guide*.

Accrual Created through Batch (With Approval) Status Transition

The following figure graphically indicates how an accrual created through the batch moves from one status to another when the approval workflow is on:

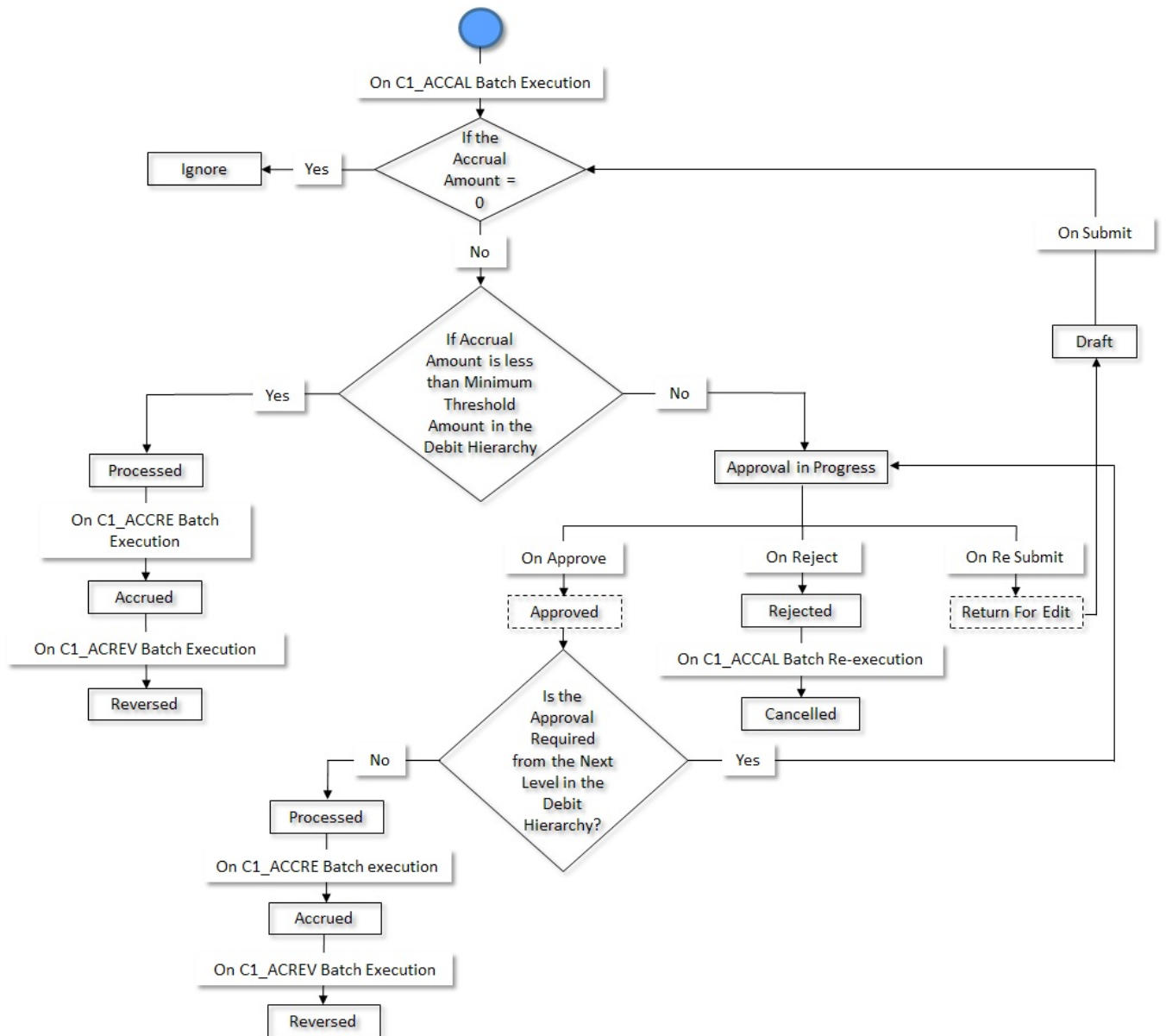

Note: For more information about the batches, refer *Oracle Revenue Management and Billing Batch Guide*.

Accrual Processes

An accrual allows an entity to record expenses and revenues for which it expects to expend cash or receive cash, respectively, in a future reporting period. Following are the accrual processes to implement accrual in the application:

- [Account's Eligibility Check for Accrual](#) on page 1904
- [Accrual Calculation](#) on page 1905
- [Accrual Creation](#) on page 1906
- [Accrual Reversal](#) on page 1906

Account's Eligibility Check for Accrual

The accrual eligibility process checks a number of account attributes to ensure that the accounts are eligible for accrual. The following table lists the internal process that identifies an account's eligibility for accrual. There will be a switch/indicator in the division and account levels that captures the information as given below:

Division Accrual (Yes/No)	Account Accrual (Yes/No)	Eligibility for Accrual (Yes/No)	Description
Yes	No	No	Account has the highest priority over division.
Yes	Blank	Yes	Division has the highest priority in the absence of account information.
Yes	Yes	Yes	Account has the highest priority over division.
No	Yes	No	If the division is set to no, ignore the account level switch.
No	No	No	If the division is set to no, ignore the account level switch.
No	Blank	No	If the division is set to no, ignore the account level switch.

Following accounts are considered for accrual eligibility:

1. The Invoicing Group's (IG) Master Account is the only account which is eligible for accrual.
2. The Invoice Construct Usage Account is not eligible for accrual.
3. You can only process the accrual eligible accounts for calculation purposes.

Accrual Calculation

The accrual calculation process calculates the accrual amount of only those accounts that are eligible for accrual. Depending upon the accrual type of those eligible accounts, an algorithm is created to calculate the accrual amount that is based on the following parameters:

- [Calculate Accrual at the Bill Level Based on Historical Data](#) on page 1905
- [Calculate Accrual at the Price Item Level Based on Historical Data](#) on page 1905
- [Calculate Accrual at the Bill Level Based on Actual Data](#) on page 1906
- [Calculate Accrual at the Price Item Level Based on Actual Data](#) on page 1906

Note: By default, all the adjustments (for bill level and bill segment level) are included in the accrual calculation. However, some adjustments from the calculation lines are excluded, through the look up references provided in the application.

Calculate Accrual at the Bill Level Based on Historical Data

The accounts eligible for accrual have their accrual amount calculated at the bill level based on the historical data. The number of historical bills to be considered for accrual calculation is based on the value configured in the accrual type of the eligible account.

For example, if there are two historical bills, the system considers the last two completed bills for accrual calculation. The accrual amount is the average of the bill segments and frozen adjustments on the last two bills. If the option from the Type of Day field is set as Business Day, the system does not consider the weekends and holidays during the accrual calculation. However, if the option from the Type of Day field is set as Calendar Day, the system considers the weekends and holidays during the accrual calculation.

Calculate Accrual at the Price Item Level Based on Historical Data

The accounts eligible for accrual have their accrual amount calculated at the price item level based on the historical data. The number of historical bills to be considered for accrual calculation is based on the value configured in the accrual type of the eligible account.

For example, if there are two historical bills, then the system considers the last two completed bills for accrual calculation. The accrual amount is the average of price items on the last two bills. If the option from the **Type of Day** field is set as **Business Day**, the system does not consider the weekends and holidays during the accrual calculation. However, if the option from the **Type of Day** is set as **Calendar Day**, the system considers the weekends and holidays during the accrual calculation.

Calculate Accrual at the Bill Level Based on Actual Data

The accounts eligible for accrual have their accrual amount calculated at the bill level based on the actual data. The actual data can be sourced from a trial bill or rated Transaction Feed Management transaction. The accrual source to be considered is based on the value configured in the accrual type of the account.

Following scenarios indicate how the accrual amount is calculated:

- If the accrual source is transaction feed and accrual amount is calculated at bill level; the accrual amount is the sum of unbilled pass through billable charges created for the account either manually or automatically through the Transaction Feed Management process and frozen adjustments of the account.
- If the accrual source is transaction feed and accrual amount is calculated at bill segment level; the accrual amount is the sum of unbilled pass through billable charges created for the account automatically through the Transaction Feed Management process.

Calculate Accrual at the Price Item Level Based on Actual Data

The accounts eligible for accrual have their accrual amount calculated at the price item level based on the actual data. The actual data can be sourced from a trial bill or rated Transaction Feed Management transaction. The accrual source to be considered is based on the value configured in the accrual type of the account.

Following scenarios indicate how the accrual amount is calculated:

- If the accrual source is trial bill and accrual amount is calculated at bill level; the accrual amount is the sum of price items and frozen adjustments on the latest trial bill.
- If the accrual source is trial bill and accrual amount is calculated at price item level; the accrual amount is the sum of price items on the latest trial bill.

Accrual Creation

The accrual creation takes place based on the calculated accrual amount and accrual type information which is used to create an accrual adjustment. You can create the adjustments for accruals through the **C1_ACCRE** batch process. The accruals which are either in the **Ready for Accrual** or **Processed** status are considered in this batch process. Based on the adjustment type defined in the accrual type, the system accordingly creates the accrual adjustment for the account. The status of the accrual is changed to **Accrued**.

Note:

For more information about the batch, refer to *Oracle Revenue Management and Billing Batch Guide*.

The system also enables you to manually create the accrual for an account. You can optionally configure the approval workflow process for accruals. The approval process is configured through the approval profile. The approval profile allows you to define the approval hierarchy. The debit approval hierarchy is used for approving the accrual. You can define an approval hierarchy where users with different To Do role at each level can approve or reject the accrual. This process continues till the approval is received from all levels in the hierarchy. Once users at all levels approve the accrual, the status of the accrual is changed to **Processed**. However, if an approver at any level in the hierarchy rejects the accrual, the status of the accrual is changed to **Rejected**.

Accrual Reversal

The reversal of accrual adjustments is done to prevent double posting of revenue, once the billing is done. On the basis of the accrual reversal schedule, an account with accrual adjustments is selected for the accrual reversal processing. For every frozen adjustment, a cancellation is done in order to reverse journal entries.

You can reverse the accrual through the **C1_ACREV** batch process. On reversing the accrual, the accrual adjustments are cancelled and the status of the accrual is changed to **Reversed**.

Note: For more information about the batch, refer to *Oracle Revenue Management and Billing Batch Guide*.

Accrual Cycle (Used for Searching)

The **Accrual Cycle** screen allows you to search for an accrual cycle using various search criteria. It also allows you to define an accrual cycle. It contains the following zone:

- [Search Accrual Cycle](#) on page 1907

Search Accrual Cycle

The **Search Accrual Cycle** zone allows you to search for an accrual cycle using various search criteria. It contains the following two sections:

- **Search Criteria** - The **Search Criteria** section contains the following fields:

Field Name	Field Description	Mandatory (Yes or No)
Accrual Cycle	Used to search a particular accrual cycle.	No
Description	Used to search an accrual cycles with a particular description.	No

Note: You must specify at least one search criterion while searching for an accrual cycle.

- **Search Results** - On clicking the **Search** button, the search results appear based on the specified search criteria. The **Search Results** section contains the following columns:

Column Name	Column Description
Accrual Cycle	Displays the name of accrual cycle.
Accrual Cycle Information	Displays information about the accrual cycle.
	Note: It has a link. On clicking the link, the Accrual Cycle screen appears where you can view the details of the respective accrual cycle.

Related Topics

For more information on...	See...
How to search for an accrual cycle	Searching for an Accrual Cycle on page 1907
How to view the details of an accrual cycle	Viewing the Accrual Cycle Details on page 1908
How to define an accrual cycle	Defining an Accrual Cycle on page 1908

Searching for an Accrual Cycle

Prerequisites

To search for an accrual cycle, you should have:

- Accrual cycles defined in the application

Procedure

To search for an accrual cycle:

1. Click the **Admin** link in the **Application** toolbar.
A list appears.
2. From the **Admin** menu, select **A** and then click **Accrual Cycle**.
The **Accrual Cycle** screen appears.
3. Enter the search criteria in the **Search Accrual Cycle** zone.

Note: ORMB search engine supports wildcard search, where you can substitute the percentage (%) symbol as a stand in for any word or letter in a search criteria. You can use the ‘%’ wildcard character in all input fields except the date and ID fields. The ‘%’ wildcard character is suffixed automatically at the end of the partial search criteria. Therefore, you may or may not specify the wildcard character at the end of the partial search criteria. However, you have to prefix the wildcard character manually wherever required.

4. Click **Search**.

A list of accrual cycles that meet the search criteria appear in the **Search Results** section.

Related Topics

For more information on...	See...
Accrual Cycle screen	Accrual Cycle (Used for Viewing) on page 1910
Accrual Cycle zone	Accrual Cycle on page 1910

Viewing the Accrual Cycle Details

Procedure

To view the details of an accrual cycle:

1. Search for an accrual cycle in the **Accrual Cycle** screen.
2. In the **Search Results** section, click the link in the **Accrual Cycle Information** column corresponding to the accrual cycle whose details you want to view.
The **Accrual Cycle** screen appears.
3. View the details of the accrual cycle in the **Accrual Cycle** zone.

Related Topics

For more information on...	See...
How to search for an accrual cycle	Searching for an Accrual Cycle on page 1907
Accrual Cycle zone	Accrual Cycle on page 1910

Defining an Accrual Cycle

Prerequisites

To define an accrual cycle, you should have:

- Accrual business object defined in the application.

Procedure

To define an accrual cycle:

1. Click the **Admin** link in the **Application** toolbar.

A list appears.

2. From the **Admin** menu, select **A** and then click **Accrual Cycle**.

The **Accrual Cycle** screen appears.

3. Click the **Add** button in the **Page Title** area of the **Accrual Cycle** screen.

The **Accrual Cycle** screen appears. It contains the following sections:

- **Main** – Used to specify basic details about the accrual cycle.
- **Schedule Periods** – Used to specify the schedule period of an accrual cycle for which the accrual is calculated.

The **Main** section contains the following fields:

Field Name	Field Description	Mandatory (Yes or No)
Accrual Cycle	Used to specify the accrual cycle.	Yes
Description	Used to specify the description for the accrual cycle.	Yes

4. Enter the required details in the **Main** section.
5. Add the schedule periods for the accrual cycle.
6. Click **Save**.

The accrual cycle is defined.

Related Topics

For more information on...	See...
Accrual Cycle screen	Accrual Cycle (Used for Searching) on page 1907
Accrual Cycle screen	Accrual Cycle (Used for Viewing) on page 1910
How to search for an accrual cycle	Searching for an Accrual Cycle on page 1907
How to add a schedule period in an accrual cycle	Adding a Schedule Period in an Accrual Cycle on page 1909

Adding a Schedule Period in an Accrual Cycle

Prerequisites

To add a schedule period in an accrual cycle, you should have:

- Accrual cycles (in which you want to add a schedule period) defined in the application

Procedure

To add a schedule period in an accrual cycle:

1. Ensure that the **Schedule Periods** section is expanded when you are defining or editing an accrual cycle.

The **Schedule Periods** section contains the following fields in a grid:

Field Name	Field Description	Mandatory (Yes or No)
Accrual Date	Used to specify the date from when the accrual creation process for an applicable account is initiated.	Yes

Field Name	Field Description	Mandatory (Yes or No)
Reversal Start Date	Used to specify the date from when the accrual reversal process starts.	Yes
	Note: The Reversal Start Date must be later than the Accrual Date . The Reversal Start Date cannot be later than the Reversal End Date .	
Reversal End Date	Used to specify the date till when the accrual reversal process ends.	Yes
	Note: The Reversal End Date cannot be earlier than the Reversal Start Date .	

- Enter the required details in the **Schedule Periods** section.
- If you want to add more than one schedule period in an accrual cycle, click the **Add (+)** icon and then repeat step 2.

Note: However, if you want to remove a schedule period from an accrual cycle, click the **Delete (🗑)** icon corresponding to the **Accrual Date** field.

- Click **Save**.

The schedule period is added in the accrual cycle.

Related Topics

For more information on...	See...
How to define an accrual cycle	Defining an Accrual Cycle on page 1908
How to edit an accrual cycle	Editing an Accrual Cycle on page 1911

Accrual Cycle (Used for Viewing)

The **Accrual Cycle** screen allows you to view the details of an accrual cycle. It also allows you to define, edit, or delete an accrual cycle. It contains the following zone:

- [Accrual Cycle](#) on page 1910

Accrual Cycle

The **Accrual Cycle** zone displays the details of an accrual cycle. It contains the following sections:

- Main** – Displays basic information about the accrual cycle. It contains the following fields:

Field Name	Field Description
Accrual Cycle	Displays the accrual cycle.
Description	Displays the description of the accrual cycle.

- **Schedule Periods** – Displays information about when the accrual creation process is initiated for the applicable accounts. It contains the following columns:

Column Name	Column Description
Accrual Date	Displays the date from when the accrual creation process for an applicable account is initiated.
Reversal Start Date	Displays the date from when the accrual reversal process starts.
Reversal End Date	Displays the date till when the accrual reversal process ends.

- **Record Actions** – The **Record Actions** section contains the following buttons:

Button Name	Button Description
Edit	Used to edit the details of an accrual cycle.
Delete	Used to delete an accrual cycle.

- **Record Information** – The **Record Information** section contains the following field:

Field Name	Field Description
Business Object	Indicates the business object using which the accrual cycle is created in the system. In addition, a context menu appears corresponding to this field which helps in navigating to other screens in the application.
	Note: It has a link. On clicking the link, the Business Object screen appears where you can view the details of the respective business object.

Related Topics

For more information on...	See...
How to search for an accrual cycle	Searching for an Accrual Cycle on page 1907
How to view the details of an accrual cycle	Viewing the Accrual Cycle Details on page 1908

Editing an Accrual Cycle

Procedure

To edit an accrual cycle:

1. Search for the accrual cycle in the **Accrual Cycle** screen.
2. In the **Search Results** section, click the link in the **Accrual Cycle Information** column corresponding to the accrual cycle whose details you want to edit.

The **Accrual Cycle** screen appears.

3. Click the **Edit** button in the **Accrual Cycle** zone.

The **Accrual Cycle** screen appears. It contains the following sections:

- **Main** – Used to specify basic details about the accrual cycle.
- **Schedule Periods** – Used to specify the schedule period of an accrual cycle for which the accrual is calculated.

The **Main** section contains the following fields:

Field Name	Field Description	Mandatory (Yes or No)
Accrual Cycle	Used to specify the accrual cycle.	Yes
Description	Used to specify the description for the accrual cycle.	Yes

4. Modify the required details in the **Main** section.
5. Add, edit, or remove the schedule period information from the accrual cycle.
6. Click **Save**.

The changes made to the accrual cycle are saved.

Note: You can edit an accrual cycle only when the accrual cycle is not referenced to an accrual type for creating an accrual.

Related Topics

For more information on...	See...
How to search for an accrual cycle	Searching for an Accrual Cycle on page 1907
Accrual Cycle screen	Accrual Cycle (Used for Viewing) on page 1910
Accrual Cycle zone	Accrual Cycle on page 1910
How to add a schedule period in an accrual cycle	Adding a Schedule Period in an Accrual Cycle on page 1909

Deleting an Accrual Cycle

Procedure

To delete an accrual cycle:

1. Search for the accrual cycle in the **Accrual Cycle** screen.
2. In the **Search Results** section, click the link in the **Accrual Cycle Information** column corresponding to the accrual cycle that you want to delete.

The **Accrual Cycle** screen appears.

3. Click the **Delete** button in the **Accrual Cycle** zone.

A message appears confirming whether you want to delete the accrual cycle.

4. Click **OK**.

The accrual cycle is deleted.

Note: You can delete an accrual cycle only when the accrual cycle is not referenced to an accrual type for creating an accrual.

Related Topics

For more information on...	See...
How to search for an accrual cycle	Searching for an Accrual Cycle on page 1907
Accrual Cycle screen	Accrual Cycle (Used for Viewing) on page 1910
Accrual Cycle zone	Accrual Cycle on page 1910

Accrual Type (Used for Searching)

The **Accrual Type** screen allows you to search for an accrual type using various search criteria. It also allows you to define an accrual type. It contains the following zone:

- [Search Accrual Type](#) on page 1913

Search Accrual Type

The **Search Accrual Type** zone allows you to search an accrual type using various search criteria. It contains the following two sections:

- **Search Criteria** – The **Search Criteria** section contains the following fields:

Field Name	Field Description	Mandatory (Yes or No)
Accrual Type	Used to search a particular accrual type.	No
Description	Used to search accrual types having a particular description.	No
Accrual Criteria	Used to search accrual types which are created to calculate accruals based on a particular bill criteria. The valid values are: <ul style="list-style-type: none"> • Actual - Used to search accrual types which are created to calculate accruals based on the actual bill data. • Historical - Used to search accrual types which are created to calculate accruals based on the historical bill data. 	No
Posting Method	Used to search accrual types which are created to calculate accruals at a particular level. The valid values are: <ul style="list-style-type: none"> • Bill Level - Used to search accrual types which are created to accrue the bill segments and adjustments of bills at the bill level. • Bill Distribution Code Level - Used to search accrual types which are created to accrue the bill segments and adjustments of bills at the distribution code level. • Price Item Level - Used to search accrual types which are created to accrue the bill segments and adjustments of bills at the price item level. • Price Item Distribution Code Level - Used to search accrual types which are created to accrue the bill segments of a particular price item at the distribution code level. 	No
Division	Used to search accrual types which are associated to a particular division.	No

Field Name	Field Description	Mandatory (Yes or No)
	Note: You can only view those divisions to which you have access in the Division list.	

Note: You must specify at least one search criterion while searching for an accrual type.

- **Search Results** – On clicking the **Search** button, the search results appear based on the specified search criteria. The **Search Results** section contains the following columns:

Column Name	Column Description
Accrual Type	Displays the accrual type.
Accrual Type Information	Displays information about the accrual type. Note: It has a link. On clicking the link, the Accrual Type screen appears where you can view the details of the respective accrual type.
Accrual Criteria	Indicates the bill criteria which is used to calculate the accrual.
Posting Method	Indicates the bill level at which the accrual is calculated.
Type of Day	Indicates the type of day which is used as a reference for calculating the accruals.
Division	Indicates the division to which the accrual type is associated.

Note: Pagination is used to display limited number of records in the **Search Results** section. You can use the navigation links, such as **Previous** and **Next** to navigate between pages.

Related Topics

For more information on...	See...
How to search for an accrual type	Searching for an Accrual Type on page 1914
How to view the details of an accrual type	Viewing the Accrual Type Details on page 1915

Searching for an Accrual Type

Procedure

To search for an accrual type:

1. Click the **Admin** link in the **Application** toolbar.
A list appears.
2. From the **Admin** menu, select **A** and then click **Accrual Type**.
The **Accrual Type** screen appears.
3. Enter the search criteria in the **Search Accrual Type** zone.

Note: ORMB search engine supports wildcard search, where you can substitute the percentage (%) symbol as a stand in for any word or letter in a search criteria. You can use the ‘%’ wildcard character in all input fields except the date and ID fields. The ‘%’ wildcard character is suffixed automatically at the end of the partial search criteria. Therefore, you may or may not specify the wildcard character at the end of the partial search criteria. However, you have to prefix the wildcard character manually wherever required.

4. Click **Search**.

A list of accrual types that meet the search criteria appears in the **Search Results** section.

Related Topics

For more information on...	See...
Accrual Type screen	Accrual Type (Used for Searching) on page 1913
Accrual Type zone	Accrual Type on page 1925

Viewing the Accrual Type Details

Procedure

To view the details of an accrual type:

1. Search for the accrual type in the **Accrual Type** screen.
2. In the **Search Results** section, click the link in the **Accrual Type Information** column corresponding to the accrual type whose details you want to view.

The **Accrual Type** screen appears. It contains the following zone:

- [Accrual Type](#) on page 1925

3. View the details of the accrual type in the **Accrual Type** zone.

Related Topics

For more information on...	See...
How to search for an accrual type	Searching for an Accrual Type on page 1914
Accrual Type screen	Accrual Type (Used for Viewing) on page 1925

Defining an Accrual Type

Prerequisites

To define an accrual type, you should have:

- Accrual type business object defined in the application.
- Accrual business object defined in the application.
- Adjustment types defined in the application (where the **Print by Default** and **Influence Next Bill Balance** check box is not selected).

Procedure

To define an accrual type:

1. Click the **Admin** link in the **Application** toolbar.
A list appears.
2. From the **Admin** menu, select **A** and then click **Accrual Type**.

The **Accrual Type** screen appears.

3. Click the **Add** button in the **Page Title** area of the **Accrual Type** screen.

The **Accrual Type** screen appears. It contains the following sections:

- **Main** – Used to specify basic details about the accrual type.
- **Algorithms** – Used to associate algorithms with the accrual type.
- **Objects to Exclude** – Used to specify the entities that you want to exclude while accrual calculation.
- **Divisions** – Used to specify the divisions to which the accrual type can be associated.
- **Characteristics** – Used to define a list of characteristics for the accrual type.

The **Main** section contains the following fields:

Field Name	Field Description	Mandatory (Yes or No)
Accrual Type	Used to specify the accrual type.	Yes
Description	Used to specify the description for the accrual type.	Yes
Accrual Object	Used to indicate the type of accrual object that you want to create while posting the accrual details. The valid values are: <ul style="list-style-type: none"> • Adjustment • Custom <div style="border: 1px solid black; padding: 5px; margin-top: 5px;"> <p>Note: At present, you can only create adjustments to record the accruals for the accounts in the application.</p> </div>	Yes
Adjustment Type	Used to indicate the adjustment type using which the adjustment must be created while posting the accrual details.. <div style="border: 1px solid black; padding: 5px; margin-top: 5px;"> <p>Note: The Search (🔍) icon appears corresponding to the Adjustment Type field. On clicking the Search icon, the Adjustment Type Search window appears. On specifying the adjustment type, the description of the adjustment type appears corresponding to the Adjustment Type field. The Adjustment Type field appears only when you select the Adjustment option from the Accrual Object field.</p> </div>	No
Accrual Criteria	Used to indicate the bill criteria using which you want to calculate the accrual. The valid values are:	Yes

Field Name	Field Description	Mandatory (Yes or No)
	<ul style="list-style-type: none"> • Actual - Used to indicate whether you want to calculate accruals based on the actual bill data. • Historical - Used to indicate whether you want to calculate accruals based on the historical bill data. 	
Accrual Source	Used to indicate the source of data that you want to use for calculating the accruals that are based on the actual data. The valid values are: <ul style="list-style-type: none"> • Transaction Feed • Trial Bill 	Yes (Conditional)
	Note: This field is required for calculating accruals using the actual data.	
	Note: This field appears only when you select the Actual option from the Accrual Criteria field.	
Historical Bill Count	Used to specify the number of historical bills that you want to consider for calculating the accrual.	Yes (Conditional)
	Note: This field appears only when you select the Historical option from the Accrual Criteria field.	Note: This field is required for calculating accruals using the historical data.
Accrual Request Business Object	Used to indicate the business object using which you want to create the accrual request.	Yes
	Note: The Search (🔍) icon appears corresponding to this field. On clicking the Search icon, the Business Object Search window appears. On specifying the business object, the description of the business object appears corresponding to the Accrual Request Business Object field.	
Approval Required	Used to indicate whether approval is required for the accruals which are created using the accrual type.	No
Approval Profile	Used to indicate the approval profile which you want to use for approving the accruals which are created using the accrual type.	Yes (Conditional)
	Note: This field is required for approving the accruals.	
	Note: This field appears only when the Approval Required check box is selected.	
Hierarchical Approval	Used to indicate whether multi-level or single-level approval is required for the accruals which are created using the accrual type.	Yes (Conditional)

Field Name	Field Description	Mandatory (Yes or No)
	<p>Note: This field appears only when the Approval Required check box is selected.</p>	<p>Note: This field is required for specifying the hierarchy using which you want to approve the accruals.</p>
<p>Submitter To Do Type</p>	<p>Used to indicate the To Do task assigned to the To Do type for the approver who can resubmitting the accrual for approval</p> <p>Note:</p> <p>The Search (🔍) icon appears corresponding to this field. On clicking the Search icon, the To Do Type Search window appears.</p> <p>On specifying the submitter To Do type, the description of the submitter To Do type appears corresponding to the Submitter To Do Type field.</p> <p>The Submitter To Do Type field appears only when the Approval Required check box is selected.</p>	<p>Yes (Conditional)</p> <p>Note: This field is required for approving the accruals.</p>
<p>Submitter To Do Role</p>	<p>Used to indicate the To Do role of the approver who can resubmit the accrual for approval.</p> <p>Note: This field appears only when the Approval Required check box is selected.</p>	<p>Yes (Conditional)</p> <p>Note: This field is required for approving the accruals.</p>
<p>Type of Day</p>	<p>Used to indicate the type of day for which you want to calculate the accrual amount.</p> <ul style="list-style-type: none"> • Business Day • Calendar Day <p>Note:</p> <p>If the Business Day option is selected, the system calculates the accrual amount using the following formula:</p> <p>Accrual amount = (Sum of resulting bill amount / Total number of business days from previous bills) * Number of business days for the current billing cycle.</p> <p>If the Calendar Day option is selected, the system calculates the accrual amount using the following formula:</p> <p>Accrual amount = (Sum of bill amount / Total number of calendar days of previous bills) * Number of calendar days for the current billing cycle.</p>	<p>Yes</p>

Field Name	Field Description	Mandatory (Yes or No)
Posting Method	<p>Used to indicate the level at which you want to calculate the accruals. The valid values are:</p> <ul style="list-style-type: none"> • Bill Level - Used to indicate that the accrual is created to calculate the bill segments and adjustments of bills at the bill level. • Bill Distribution Code Level - Used to indicate that the accrual is created to calculate the bill segments and adjustments of bills at the distribution code level. • Price Item Level - Used to indicate that the accrual is created to calculate the bill segments and adjustments of bills at the price item level. • Price Item Distribution Code Level - Used to indicate that the accrual is created to calculate the bill segments of a particular price item at the distribution code level. 	Yes
Proration Required	<p>Used to indicate whether you want to prorate the accrual amount for the trail bills and historical bill segments for the recurring and non-recurring charges using different posting methods. It is calculated using the below formula:</p> <p>Expected accrual amount for each price item = (Sum of resulting bill segment amount / Total number of days) * Number of days in the accrual cycle</p> <p>Note: This field appears in the following scenarios:</p> <ul style="list-style-type: none"> • When the Actual and the Trial Bill options are selected from the Accrual Criteria and the Accrual Source fields respectively. • When the Historical option is selected from the Accrual Criteria field. 	No
Calculation Lines Required	Used to indicate whether you want to view the bill segments and adjustments which are used for calculating the accrual amount.	No

Field Name	Field Description	Mandatory (Yes or No)															
	<p>Note:</p> <p>You can view the accrual calculation lines in the Accrual screen only when the following conditions are satisfied:</p> <ul style="list-style-type: none"> • Accrual is created using the batch process and not manually from the user interface. • Accrual is created using an accrual type with either of the following combinations: <table border="1" data-bbox="704 569 1143 915"> <thead> <tr> <th>Accrual Criteria</th> <th>Accrual Source</th> <th>Posting Method</th> </tr> </thead> <tbody> <tr> <td>Historical</td> <td>-</td> <td>Bill Level</td> </tr> <tr> <td>Historical</td> <td>-</td> <td>Price Item Level</td> </tr> <tr> <td>Actual</td> <td>Trial Bill</td> <td>Bill Level</td> </tr> <tr> <td>Actual</td> <td>Trial Bill</td> <td>Price Item Level</td> </tr> </tbody> </table> <ul style="list-style-type: none"> • When the Do you want to insert detail level calculation? parameter in the Accrual Calculation (C1_ACCR_CAL) algorithm is set to Y. <p>The Calculation Lines Required check box is by default selected and cannot be unchecked if you select the Bill Distribution Code Level or the Price Item Distribution Code Level option from the Posting Method field.</p>	Accrual Criteria	Accrual Source	Posting Method	Historical	-	Bill Level	Historical	-	Price Item Level	Actual	Trial Bill	Bill Level	Actual	Trial Bill	Price Item Level	
Accrual Criteria	Accrual Source	Posting Method															
Historical	-	Bill Level															
Historical	-	Price Item Level															
Actual	Trial Bill	Bill Level															
Actual	Trial Bill	Price Item Level															
Price Item Accrual Criteria Required	Used to indicate whether accrual criteria is required for calculating accrual at the price item level.	No															
Cancel Reason	<p>Used to indicate the cancel reason that you want to use while reversing the accrual. The valid values are:</p> <ul style="list-style-type: none"> • Broken Payment Arrangement • Credit Note • Enter <p>Note: The list includes only those values which are specified in the ACCR_CAN_RSN_CD lookup field.</p>	No															
Contract Type	Used to indicate the contract type whose contract exists on the accounts.	Yes															

Field Name	Field Description	Mandatory (Yes or No)
	Note: The Search (🔍) icon appears corresponding to this field. On clicking the Search icon, the Contract Type Search window appears where you can select the required contract type.	
Applicable for Account	Used to indicate whether the Accrual Type is used to calculate accruals at the account level. Note: If you do not select the Applicable for Account check box, the system will consider the accrual type to calculate accruals at the division level.	Yes (Conditional) Note: This field is required for indicating the accrual type can be associated to an account and not the division for calculating accruals.

4. Enter the required details in the **Main** section.
5. Associate algorithms with the accrual type in the **Algorithms** section, if required.
6. Exclude the entities which are not required for calculating the accrual using the accrual type in the **Objects to Exclude** section, if required.
7. Associate a list of divisions to which you want to associate the accrual type in the **Divisions** section, if required.
8. Define a list of characteristics for the accrual type in the **Characteristics** section, if required.
9. Click **Save**.

The accrual type is defined.

Related Topics

For more information on...	See...
Accrual Type screen	Accrual Type (Used for Searching) on page 1913
Accrual Type screen	Accrual Type (Used for Viewing) on page 1925
How to associate an algorithm with an accrual type	Associating an Algorithm with an Accrual Type on page 1921
How to exclude an entity from an accrual type	Excluding an Entity from an Accrual Type on page 1923
How to associate a division with an accrual type	Associating a Division with an Accrual Type on page 1924
How to define a characteristic for an accrual type	Defining a Characteristic for an Accrual Type

Associating an Algorithm with an Accrual Type

Prerequisites

To associate an algorithm with an accrual type, you should have:

- System events defined in the application
- Algorithms defined for the system events

Procedure

To associate an algorithm with an accrual type:

1. Ensure that the **Algorithms** section is expanded in the **Accrual Type** screen when you are defining, editing, or copying an **Accrual Type**.

The **Algorithms** section contains the following fields in a grid:

Field Name	Field Description	Mandatory (Yes or No)
System Event	<p>Used to indicate the system event for which the algorithm is executed. The valid values are:</p> <ul style="list-style-type: none"> • Accrual Calculation - Used to attach an algorithm which is triggered for calculating an accrual. • Accrual Creation - Used to attach an algorithm which is triggered for creating an accrual request. • Accrual Eligibility - Used to attach an algorithm which is triggered to verify the eligibility of the accrual. • Accrual Post Calculation - Used to attach an algorithm which is triggered for undertaking the post calculation activities for the accrual amount. • Accrual Post Processing - Used to attach an algorithm which is triggered for undertaking some postprocessing activities on the accrual amount. • Accrual Pre Processing - Used to attach an algorithm which is triggered for undertaking some preprocessing activities on the accrual amount. • Accrual Reversal - Used to attach an algorithm which is triggered for the accrual reversal process. • Accrual Reversal Post Processing - Used to attach an algorithm which is triggered for undertaking some postprocessing activities on the accrual reversal process. • Accrual Reversal Pre Processing - Used to attach an algorithm which is triggered for undertaking some preprocessing activities on the accrual reversal process. 	<p>Yes (Conditional)</p> <p>Note: This field is required while associating an algorithm with the accrual type.</p>
Sequence	<p>Used to specify the order in which the algorithms with the same system event must be executed.</p>	<p>Yes (Conditional)</p> <p>Note: This field is required while associating an algorithm with the accrual type.</p>

Field Name	Field Description	Mandatory (Yes or No)
Algorithm	Used to specify the algorithm that you want to execute on the system event.	Yes (Conditional)
	<p>Note:</p> <p>The Search (🔍) icon appears corresponding to the Algorithm field. On clicking the Search (🔍) icon, the Algorithm Search window appears.</p> <p>On specifying the algorithm, the description of the algorithm appears corresponding to the Algorithm field.</p>	<p>Note: This field is required while associating an algorithm with the accrual type.</p>

- Enter the required details in the **Algorithms** section.
- If you want to associate more than one algorithm to the accrual type, click the **Add** (+) icon and then repeat step 2.

Note: However, if you want to disassociate an algorithm from the accrual type, click the **Delete** (🗑️) icon corresponding to the algorithm.

- Click **Save**.

The algorithm is associated with an accrual type.

Related Topics

For more information on...	See...
How to define an accrual type	Defining an Accrual Type on page 1915
How to edit an accrual type	Editing an Accrual Type on page 1929
How to copy an accrual type	Copying an Accrual Type

Excluding an Entity from an Accrual Type

Procedure

To exclude an entity from an accrual type:

- Ensure that the **Objects To Exclude** section is expanded in the **Accrual Type** screen when you are defining, editing, or copying an **Accrual Type**.

The **Objects To Exclude** section contains the following fields in a grid:

Field Name	Field Description	Mandatory (Yes or No)
Entity Type	<p>Used to indicate the type of entity. The valid values are:</p> <ul style="list-style-type: none"> Adjustment Type Distribution Code Price Item 	Yes (Conditional)
		<p>Note: This field is required while excluding an entity from the accrual type.</p>

Field Name	Field Description	Mandatory (Yes or No)
Sequence	Used to specify the order in which the entities must be excluded from the accrual type.	Yes (Conditional) Note: This field is required while excluding an entity from the accrual type.
Entity	Used to indicate the value for the selected entity type. Note: On selecting a predefined entity type, the Search (🔍) icon appears corresponding to the Entity field. On clicking the Search (🔍) icon, you can search for a predefined entity value. On specifying the entity, the description of the entity appears corresponding to the Entity field. By default, the Entity field is disabled. It is enabled only when you select a predefined entity type from the Entity Type field.	Yes (Conditional) Note: This field is required while excluding an entity from the accrual type.

- Enter the required details in the **Objects To Exclude** section.
- If you want to exclude more than one entity from the accrual type, click the **Add** (+) icon and then repeat step 2.

Note: However, if you want to remove an excluded entity from the accrual type, click the **Delete** (🗑️) icon corresponding to the entity.

- Click **Save**.

The entity is excluded from the accrual type.

Related Topics

For more information on...	See...
How to define an accrual type	Defining an Accrual Type on page 1915
How to edit an accrual type	Editing an Accrual Type on page 1929
How to copy an accrual type	Copying an Accrual Type

Associating a Division with an Accrual Type

Prerequisites

To associate a division with an accrual type, you should have:

- Divisions defined in the application.

Procedure

To associate a division with an accrual type:

1. Ensure that the **Divisions** section is expanded in the **Accrual Type** screen when you are defining, editing, or copying an **Accrual Type**.

The **Divisions** section contains the following fields in a grid:

Fields Name	Fields Description	Mandatory (Yes or No)
Effective Date	Used to specify the date from when the accrual type is effective for the division.	Yes (Conditional)
		Note: This field is required while associating a division with an accrual type.
Division	Used to indicate division to which you want to associate the accrual type.	Yes (Conditional)
		Note: This field is required while associating a division with an accrual type.

2. Enter the required details in the **Divisions** section.
3. If you want to associate more than one division with the accrual type, click the **Add (+)** icon and then repeat step 2.

Note: However, if you want to disassociate a division from the accrual type, click the **Delete (🗑)** icon corresponding to the division.

4. Click **Save**.

The division is associated with the accrual type.

Related Topics

For more information on...	See...
How to define an accrual type	Defining an Accrual Type on page 1915
How to edit an accrual type	Editing an Accrual Type on page 1929
How to copy an accrual type	Copying an Accrual Type

Accrual Type (Used for Viewing)

The **Accrual Type** screen allows you to view the details of an accrual type. It also allows you to define, edit, copy, or delete an accrual type. It contains the following zone:

- [Accrual Type](#) on page 1925

Accrual Type

The **Accrual Type** zone displays the details of an accrual type. It contains the following sections:

- **Main** – Displays basic information about the accrual type. It contains the following fields:

Field Name	Field Description
Accrual Type	Displays the accrual type.
Description	Displays the description of the accrual type.

Field Name	Field Description
Accrual Object	Indicates the type of accrual object that you want to create while posting the accrual details. The valid values are: <ul style="list-style-type: none"> • Adjustment • Custom
Adjustment Type	Indicates the adjustment type using which the adjustment must be created while posting the accrual details. Note: It has a link. On clicking the link, the Adjustment Type screen appears where you can view the details of the respective adjustment type.
Accrual Criteria	Indicates the bill criteria using which you want to calculate the accrual. The valid values are: <ul style="list-style-type: none"> • Actual - Indicates whether you want to calculate accruals based on the actual bill data. • Historical - Indicates whether you want to calculate accruals based on the historical bill data.
Accrual Source	Indicates the source of data that you want to use for calculating the accruals that are based on the actual data. The valid values are: <ul style="list-style-type: none"> • Transaction Feed • Trial Bill
Historical Bill Count	Displays the number of historical bills that you want to consider for calculating the accrual.
Accrual Request Business Object	Indicates the business object using which you want to create the accrual request.
Approval Required	Indicates whether approval is required for the accruals which are created using the accrual type.
Approval Profile	Indicates the approval profile which you want to use for approving the accruals which are created using the accrual type.
Hierarchical Approval	Indicates whether multi-level or single-level approval is required for the accruals which are created using the accrual type.
Submitter To Do Type	Indicates the To Do task assigned to the To Do type for the approver who can resubmitting the accrual for approval
Submitter To Do Role	Indicates the To Do role of the approver who can resubmit the accrual for approval.
Type of Day	Indicates the type of day for which you want to calculate the accrual amount. <ul style="list-style-type: none"> • Business Day • Calendar Day
Posting Method	Indicates the level at which you want to calculate the accruals. The valid values are: <ul style="list-style-type: none"> • Bill Level - Indicates that the accrual is created to calculate the bill segments and adjustments of bills at the bill level.

Field Name	Field Description
	<ul style="list-style-type: none"> • Bill Distribution Code Level - Indicates that the accrual is created to calculate the bill segments and adjustments of bills at the distribution code level. • Price Item Level - Indicates that the accrual is created to calculate the bill segments and adjustments of bills at the price item level. • Price Item Distribution Code Level - Indicates that the accrual is created to calculate the bill segments of a particular price item at the distribution code level.
Proration Required	Indicates whether you want to prorate the accrual amount for the trail bills which have recurring bill segments.
Calculation Lines Required	Indicates whether you want to view the bill segments and adjustments which are used for calculating the accrual amount.
Price Item Accrual Criteria Required	Indicates whether accrual criteria is required for calculating accrual at the price item level.
Cancel Reason	Indicates the cancel reason that you want to use while reversing the accrual. The valid values are: <ul style="list-style-type: none"> • Broken Payment Arrangement • Credit Note • Enter
Contract Type	Indicates the contract type whose contract exists on the accounts.
Applicable for Account	Indicates whether the Accrual Type is used to calculate accruals at the account level.

- **Algorithms** – Lists the algorithms that are associated with the accrual type. It contains the following columns:

Column Name	Column Description
System Event	Indicates the system event for which the algorithm is executed. The valid values are: <ul style="list-style-type: none"> • Accrual Calculation - Used to indicate the algorithm which is triggered for calculating an accrual. • Accrual Creation - Used to indicate the algorithm which is triggered for creating an accrual request. • Accrual Eligibility - Used to indicate the algorithm which is triggered to verify the eligibility of the accrual. • Accrual Post Calculation - Used to indicate the algorithm which is triggered for undertaking the post calculation activities for the accrual amount. • Accrual Post Processing - Used to indicate the algorithm which is triggered for undertaking some postprocessing activities on the accrual amount. • Accrual Pre Processing - Used to indicate the algorithm which is triggered for undertaking some preprocessing activities on the accrual amount.

Column Name	Column Description
	<ul style="list-style-type: none"> • Accrual Reversal - Used to indicate the algorithm which is triggered for the accrual reversal process. • Accrual Reversal Post Processing - Used to indicate the algorithm which is triggered for undertaking some postprocessing activities on the accrual reversal process. • Accrual Reversal Pre Processing - Used to indicate the algorithm which is triggered for undertaking some preprocessing activities on the accrual reversal process.
Sequence	Displays the order in which the algorithms with the same system event must be executed.
Algorithm	Displays the algorithm that is executed on the system event.
	Note: It has a link. On clicking the link, the Algorithm screen appears where you can view the details of the respective algorithm.

- **Objects to Exclude** – Lists the entities that are excluded from the accrual type for calculating the accrual. It contains the following columns:

Column Name	Column Description
Entity Type	Indicates the type of entity. The valid values are: <ul style="list-style-type: none"> • Adjustment Type • Distribution Code • Price Item
Sequence	Displays the order in which the entities are excluded from the accrual type.
Entity	Indicates the value for the selected entity type.

- **Divisions** – Lists the divisions which are associated with the accrual type. It contains the following columns:

Column Name	Column Description
Effective Date	Displays the date from when the accrual type is effective for the division.
Division	Indicates the division which you want to associate with the accrual type.

- **Characteristics** – Lists the characteristics of the accrual type. It contains the following columns:

Column Name	Column Description
Effective Date	Displays the date from when the characteristic is effective for the accrual type.
Characteristic Type	Indicates the characteristic type.
Characteristic Value	Displays the value of the characteristic type.

- **Record Actions** – The **Record Actions** section contains the following buttons:

Button Name	Button Description
Edit	Used to edit the details of the accrual type.

Button Name	Button Description
Delete	Used to delete the accrual type.
Duplicate	Used to create a new accrual type using an existing accrual type.

- **Record Information** – The **Record Information** section contains the following field:

Field Name	Field Description
Business Object	Indicates the business object using which the accrual type is created in the system. In addition, a context menu appears corresponding to this field which helps in navigating to other screens in the application.
	Note: It has a link. On clicking the link, the Business Object screen appears where you can view the details of the respective business object.

Related Topics

For more information on...	See...
How to search for an accrual type	Searching for an Accrual Type on page 1914
Accrual Type screen	Accrual Type (Used for Viewing) on page 1925
How to view the details of an accrual type	Viewing the Accrual Type Details on page 1915

Editing an Accrual Type

Prerequisites

To edit an accrual type, you should have:

- Accrual type business object defined in the application.
- Accrual business object defined in the application.
- Adjustment types defined in the application (where the **Print by Default** and **Influence Next Bill Balance** check box is not selected).

Procedure

To edit an accrual type:

1. Search for the accrual type in the **Accrual Type** screen.
2. In the **Search Results** section, click the link in the **Accrual Type Information** column corresponding to the accrual type whose details you want to edit.

The **Accrual Type** screen appears.

3. Click the **Edit** button in the **Accrual Type** zone.

The **Accrual Type** screen appears. It contains the following sections:

- **Main** – Used to specify basic details about the accrual type.
- **Algorithms** – Used to associate algorithms with the accrual type.
- **Objects to Exclude** – Used to specify the entities that you want to exclude while accrual calculation.
- **Divisions** – Used to specify the divisions to which the accrual type can be associated.
- **Characteristics** – Used to define a list of characteristics for the accrual type.

The **Main** section contains the following fields:

Field Name	Field Description	Mandatory (Yes or No)
Accrual Type	Used to specify the accrual type.	Not applicable
Description	Used to specify the description for the accrual type.	Yes
Accrual Object	<p>Used to indicate the type of accrual object that you want to create while posting the accrual details. The valid values are:</p> <ul style="list-style-type: none"> • Adjustment • Custom <p>Note: At present, you can only create adjustments to record the accruals for the accounts in the application.</p>	Yes
Adjustment Type	<p>Used to indicate the adjustment type using which the adjustment must be created while posting the accrual details..</p> <p>Note: The Search (🔍) icon appears corresponding to the Adjustment Type field. On clicking the Search icon, the Adjustment Type Search window appears. On specifying the adjustment type, the description of the adjustment type appears corresponding to the Adjustment Type field. The Adjustment Type field appears only when you select the Adjustment option from the Accrual Object field.</p>	No
Accrual Criteria	<p>Used to indicate the bill criteria using which you want to calculate the accrual. The valid values are:</p> <ul style="list-style-type: none"> • Actual - Used to indicate whether you want to calculate accruals based on the actual bill data. • Historical - Used to indicate whether you want to calculate accruals based on the historical bill data. 	Yes
Accrual Source	<p>Used to indicate the source of data that you want to use for calculating the accruals that are based on the actual data. The valid values are:</p> <ul style="list-style-type: none"> • Transaction Feed • Trial Bill 	<p>Yes (Conditional)</p> <p>Note: This field is required for calculating accruals using the actual data.</p>

Field Name	Field Description	Mandatory (Yes or No)
	Note: This field appears only when you select the Actual option from the Accrual Criteria field.	
Historical Bill Count	Used to specify the number of historical bills that you want to consider for calculating the accrual.	Yes (Conditional)
	Note: This field appears only when you select the Historical option from the Accrual Criteria field.	Note: This field is required for calculating accruals using the historical data.
Accrual Request Business Object	Used to indicate the business object using which you want to create the accrual request. Note: The Search (🔍) icon appears corresponding to this field. On clicking the Search icon, the Business Object Search window appears. On specifying the business object, the description of the business object appears corresponding to the Accrual Request Business Object field.	Yes
Approval Required	Used to indicate whether approval is required for the accruals which are created using the accrual type.	No
Approval Profile	Used to indicate the approval profile which you want to use for approving the accruals which are created using the accrual type.	Yes (Conditional)
	Note: This field appears only when the Approval Required check box is selected.	Note: This field is required for approving the accruals.
Hierarchical Approval	Used to indicate whether multi-level or single-level approval is required for the accruals which are created using the accrual type.	Yes (Conditional)
	Note: This field appears only when the Approval Required check box is selected.	Note: This field is required for specifying the hierarchy using which you want to approve the accruals.
Submitter To Do Type	Used to indicate the To Do task assigned to the To Do type for the approver who can resubmitting the accrual for approval	Yes (Conditional)
		Note: This field is required for approving the accruals.

Field Name	Field Description	Mandatory (Yes or No)
	<p>Note:</p> <p>The Search (🔍) icon appears corresponding to this field. On clicking the Search icon, the To Do Type Search window appears.</p> <p>On specifying the submitter To Do type, the description of the submitter To Do type appears corresponding to the Submitter To Do Type field.</p> <p>The Submitter To Do Type field appears only when the Approval Required check box is selected.</p>	
Submitter To Do Role	<p>Used to indicate the To Do role of the approver who can resubmit the accrual for approval.</p> <p>Note: This field appears only when the Approval Required check box is selected.</p>	<p>Yes (Conditional)</p> <p>Note: This field is required for approving the accruals.</p>
Type of Day	<p>Used to indicate the type of day for which you want to calculate the accrual amount.</p> <ul style="list-style-type: none"> • Business Day • Calendar Day <p>Note:</p> <p>If the Business Day option is selected, the system calculates the accrual amount using the following formula:</p> <p>Accrual amount = (Sum of resulting bill amount / Total number of business days from previous bills) * Number of business days for the current billing cycle.</p> <p>If the Calendar Day option is selected, the system calculates the accrual amount using the following formula:</p> <p>Accrual amount = (Sum of bill amount / Total number of calendar days of previous bills) * Number of calendar days for the current billing cycle.</p>	Yes
Posting Method	<p>Used to indicate the level at which you want to calculate the accruals. The valid values are:</p> <ul style="list-style-type: none"> • Bill Level - Used to indicate that the accrual is created to calculate the bill segments and adjustments of bills at the bill level. • Bill Distribution Code Level - Used to indicate that the accrual is created 	Yes

Field Name	Field Description	Mandatory (Yes or No)
	<p>to calculate the bill segments and adjustments of bills at the distribution code level.</p> <ul style="list-style-type: none"> • Price Item Level - Used to indicate that the accrual is created to calculate the bill segments and adjustments of bills at the price item level. • Price Item Distribution Code Level - Used to indicate that the accrual is created to calculate the bill segments of a particular price item at the distribution code level. 	
Proration Required	<p>Used to indicate whether you want to prorate the accrual amount for the trail bills and historical bill segments for the recurring and non-recurring charges using different posting methods. It is calculated using the below formula:</p> <p>Expected accrual amount for each price item = (Sum of resulting bill segment amount / Total number of days) * Number of days in the accrual cycle</p> <p>Note: This field appears in the following scenarios:</p> <ul style="list-style-type: none"> • When the Actual and the Trial Bill options are selected from the Accrual Criteria and the Accrual Source fields respectively. • When the Historical option is selected from the Accrual Criteria field. 	No
Calculation Lines Required	Used to indicate whether you want to view the bill segments and adjustments which are used for calculating the accrual amount.	No

Field Name	Field Description	Mandatory (Yes or No)															
	<p>Note:</p> <p>You can view the accrual calculation lines in the Accrual screen only when the following conditions are satisfied:</p> <ul style="list-style-type: none"> • Accrual is created using the batch process and not manually from the user interface. • Accrual is created using an accrual type with either of the following combinations: <table border="1" data-bbox="704 569 1143 978"> <thead> <tr> <th>Accrual Criteria</th> <th>Accrual Source</th> <th>Posting Method</th> </tr> </thead> <tbody> <tr> <td>Historical</td> <td>-</td> <td>Bill Level</td> </tr> <tr> <td>Historical</td> <td>-</td> <td>Bill Segment Level</td> </tr> <tr> <td>Actual</td> <td>Trial Bill</td> <td>Bill Level</td> </tr> <tr> <td>Actual</td> <td>Trial Bill</td> <td>Bill Segment Level</td> </tr> </tbody> </table> <ul style="list-style-type: none"> • When the Do you want to insert detail level calculation? parameter in the Accrual Calculation (C1_ACCR_CAL) algorithm is set to Y. <p>The Calculation Lines Required check box is by default selected and cannot be unchecked if you select the Bill Distribution Code Level or the Price Item Distribution Code Level option from the Posting Method field.</p>	Accrual Criteria	Accrual Source	Posting Method	Historical	-	Bill Level	Historical	-	Bill Segment Level	Actual	Trial Bill	Bill Level	Actual	Trial Bill	Bill Segment Level	
Accrual Criteria	Accrual Source	Posting Method															
Historical	-	Bill Level															
Historical	-	Bill Segment Level															
Actual	Trial Bill	Bill Level															
Actual	Trial Bill	Bill Segment Level															
Price Item Accrual Criteria Required	Used to indicate whether accrual criteria is required for calculating accrual at the price item level.	No															
Cancel Reason	<p>Used to indicate the cancel reason that you want to use while reversing the accrual. The valid values are:</p> <ul style="list-style-type: none"> • Broken Payment Arrangement • Credit Note • Enter <p>Note: The list includes only those values which are specified in the ACCR_CAN_RSN_CD lookup field.</p>	No															
Contract Type	Used to indicate the contract type whose contract exists on the accounts.	Yes															

Field Name	Field Description	Mandatory (Yes or No)
	Note: The Search (🔍) icon appears corresponding to this field. On clicking the Search icon, the Contract Type Search window appears where you can select the required contract type.	
Applicable for Account	Used to indicate whether the Accrual Type is used to calculate accruals at the account level. Note: If you do not select the Applicable for Account check box, the system will consider the accrual type to calculate accruals at the division level. This field is disabled when you are editing an account level accrual type (i.e. when the Applicable for Account field check box is selected).	Yes (Conditional) Note: This field is required for indicating the accrual type can be associated to an account and not the division for calculating accruals.

4. Modify the required details in the **Main** section.
5. Associate or disassociate algorithms from the accrual type.
6. Add, edit, or remove the excluded entities from the accrual type.
7. Associate or disassociate divisions from the accrual type.
8. Define, edit, or remove characteristics from the accrual type.
9. Click **Save**.

The changes made to the accrual type are saved.

Note: You can edit an accrual type only when the accrual type is not yet used for creating an accrual.

Related Topics

For more information on...	See...
How to search for an accrual type	Searching for an Accrual Type on page 1914
Accrual Type screen	Accrual Type (Used for Viewing) on page 1925
How to associate an algorithm with an accrual type	Associating an Algorithm with an Accrual Type on page 1921
How to exclude an entity from an accrual type	Excluding an Entity from an Accrual Type on page 1923
How to associate a division with an accrual type	Associating a Division with an Accrual Type on page 1924
How to define a characteristic for an accrual type	Defining a Characteristic for an Accrual Type

Deleting an Accrual Type

Procedure

To delete an accrual type:

1. Search for the accrual type in the **Accrual Type** screen.

- In the **Search Results** section, click the link in the **Accrual Type Information** column corresponding to the accrual type that you want to delete.

The **Accrual Type** screen appears.

- Click the **Delete** button in the **Accrual Type** zone.

A message appears confirming whether you want to delete the accrual type.

- Click **OK**.

An accrual type is deleted.

Note: You can delete an accrual type only when the accrual type is not yet used for creating an accrual.

Related Topics

For more information on...	See...
How to search for an accrual type	Searching for an Accrual Type on page 1914
Accrual Type screen	Accrual Type (Used for Searching) on page 1913
Accrual Type screen	Accrual Type (Used for Viewing) on page 1925
Accrual Type zone	Accrual Type on page 1925

Accrual (Used for Searching)

The **Accrual** screen allows you to search for an accrual using various search criteria. It also allows you to define an accrual manually. It contains the following zone:

- [Search Accrual](#) on page 1936

Search Accrual

The **Search Accrual** zone allows you to search for an accrual. It contains the following two sections:

- Search Criteria** – The **Search Criteria** section contains the following fields:

Field Name	Field Description	Mandatory (Yes or No)
Search By	Used to indicate whether you want to search for an accrual using the accrual details. The valid value is: <ul style="list-style-type: none"> Accrual Details 	Not applicable
Account ID	Used to indicate whether you want to search for accruals belonging to a particular account. Note: The Search (🔍) icon appears corresponding to this field. On clicking the Search icon, the Account Search window appears where you can specify the account whose accrual details you want to view.	No
Division	Used to indicate whether you want to search for accruals associated with a particular division.	No

Field Name	Field Description	Mandatory (Yes or No)
	Note: You can only view those divisions to which you have access in the Division list.	
Accrual Type	Used to search for accruals which are created using a particular accrual type.	No
Posting Method	Used to indicate whether you want to search for accruals which are calculated at a particular level. The valid values are: <ul style="list-style-type: none"> • Bill Level - Used to indicate whether you want to search for accruals whose bill segments and adjustments of bills are calculated at the bill level. • Bill Distribution Code Level - Used to indicate whether you want to search for accruals whose bill segments and adjustments of bills are calculated at the distribution code level. • Price Item Level - Used to indicate whether you want to search for accruals whose bill segments and adjustments of bills are calculated at the at the price item level. • Price Item Distribution Code Level - Used to indicate whether you want to search for accruals whose bill segments of a particular price item are calculated at the distribution code level. 	No
Accrual Cycle	Used to search for accruals which are created using a particular accrual cycle.	No
Creation Date From	Used to indicate whether you want to search for accruals which are created from a particular date onwards.	No
Accrual Creation Mode	Used to indicate whether you want to search for accruals which are created using a particular mode. The valid values are: <ul style="list-style-type: none"> • Batch - Used to indicate whether you want to search for accruals which are created in the system using the batch mode. • Manual - Used to indicate whether you want to search for accruals which are created manually in the system. 	No
Creation Date To	Used to search accruals which are created till a particular date.	No
Status	Used to search for accruals with a particular status. The valid values are:	No

Field Name	Field Description	Mandatory (Yes or No)
	<ul style="list-style-type: none"> • Ready For Accrual • Accrued • Reversed • Approval In Progress • Cancelled • Draft • Ignore • Processed • Rejected 	

Note: You must specify at least one search criterion while searching for an accrual.

- **Search Results** – On clicking the **Search** button, the search results appear based on the specified search criteria. The **Search Results** section contains the following columns:

Column Name	Column Description
Accrual Information	Displays the concatenated string of information about the accrual separated by a comma (,). Note: It has a link. On clicking the link, the Accrual screen appears where you can view the details of the respective accrual.
Division	Indicates the division to which the accrual account belongs.
Accrual Type	Indicates the accrual type using which the accrual is created for the account in the system.
Posting Method	Indicates the level at which the accrual is calculated for the account.
Accrual Creation Mode	Indicates the creation mode using which the accrual is created for the account in the system.
Status	Displays the current status of the accrual.
Create Date/Time	Displays the date and time when the accrual is created in the system.

Note: Pagination is used to display limited number of records in the **Search Results** section. You can use the navigation links, such as **Previous** and **Next** to navigate between pages.

Related Topics

For more information on...	See...
How to search for an accrual	Searching for an Accrual on page 1938
How to view the details of an accrual	Viewing the Accrual Details on page 1939

Searching for an Accrual

Procedure

To search for an accrual :

1. Click the **Menu** link in the **Application** toolbar.
A list appears.
2. From the **Main** menu, select **Accounting and Receivable** and then click **Accrual**.
A sub-menu appears.
3. Click the **Search** option from the **Accrual** sub-menu.
The **Accrual** screen appears.
4. Enter the search criteria in the **Search Accrual** zone.

Note: ORMB search engine supports wildcard search, where you can substitute the percentage (%) symbol as a stand in for any word or letter in a search criteria. You can use the ‘%’ wildcard character in all input fields except the date and ID fields. The ‘%’ wildcard character is suffixed automatically at the end of the partial search criteria. Therefore, you may or may not specify the wildcard character at the end of the partial search criteria. However, you have to prefix the wildcard character manually wherever required.

5. Click **Search**.
A list of accruals that meet the search criteria appears in the **Search Results** section.

Related Topics

For more information on...	See...
Accrual screen	Accrual (Used for Searching) on page 1936
Accrual zone	Accrual on page 1945

Viewing the Accrual Details

Procedure

To view the details of an accrual:

1. Search for the accrual in the **Accrual** screen.
2. In the **Search Results** section, click the link in the **Accrual Information** column corresponding to the accrual whose details you want to view.

The **Accrual** screen appears. It contains the following tabs:

- [Accrual - Main](#) on page 1945
- [Accrual - Log](#) on page 1949

3. Ensure that the **Main** tab is selected.
4. View the details of the accrual in the **Accrual** zone.

Related Topics

For more information on...	See...
How to search for an accrual	Searching for an Accrual on page 1938
Accrual screen	Accrual (Used for Searching) on page 1936
Accrual screen	Accrual (Used for Viewing) on page 1944
Accrual zone	Accrual on page 1945

Defining an Accrual

Prerequisites

To define an accrual, you should have:

- Account (for which you want to define the accrual) defined in the application.
- Accrual-specific active contract associated with the account.
- Batch **C1_ACCRE** defined in the application, if an accrual creation takes place through a batch.
- Algorithm **C1_ACCR_CRE** defined for accrual creation in the application.
- Algorithm **C1_ACCR_CAL** defined for accrual calculation in the application.
- Algorithm **C1_ACCR_REV** defined for accrual reversal in the application.
- Accrual type associated with the division to which the account belongs or accrual type associated with the account for accrual calculation.
- Characteristic types defined in the application (where the characteristic entity is set to **Accrual**).

Procedure

To define an accrual:

1. Click the **Menu** link in the **Application** toolbar.
A list appears.
2. From the **Main** menu, select **Accounting and Receivable** and then click **Accrual**.
A sub-menu appears.
3. Click the **Add** option from the **Accrual** sub menu.

The **Accrual** screen appears. It contains the following sections:

- **Main** – Used to specify basic details about the accrual.
- **Characteristics** – Used to specify the detail-specific characteristics for an accrual.
- **Accrual Details** – Used to specify the accrual details for an accrual.

The **Main** section contains the following fields:

Field Name	Field Description	Mandatory (Yes or No)
Account ID	Used to specify the account for which you want to define an accrual. Note: The Search (🔍) icon appears corresponding to the this field. On clicking the Search icon, the Account Search window appears. On specifying the account, the description of the account appears corresponding to the Account ID field.	Yes
Contract	Indicates the accrual-specific active contract that is associated with the account.	Not applicable

Field Name	Field Description	Mandatory (Yes or No)
	<p>Note:</p> <p>This field is populated automatically when you specify the account in the Account ID field.</p> <p>It is a read-only field and cannot be edited.</p>	
Reversal Start Date	<p>Used to specify the date from when the accrual reversal process starts.</p> <p>Note:</p> <p>The Reversal Start Date must be later than the Accrual Date.</p> <p>The Reversal Start Date cannot be later than the Reversal End Date.</p>	Yes
Reversal End Date	<p>Used to specify the date till when the accrual reversal process ends.</p> <p>Note: The Reversal End Date cannot be earlier than the Reversal Start Date.</p>	Yes
Posting Method	<p>Indicates the level at which the accrual is calculated for the account. The valid values are:</p> <ul style="list-style-type: none"> • Bill Level - Indicates that the accrual is created to calculate the bill segments and adjustments of bills at the bill level. • Bill Distribution Code Level - Indicates that the accrual is created to calculate the bill segments and adjustments of bills at the distribution code level. • Price Item Level - Indicates that the accrual is created to calculate the bill segments and adjustments of bills at the price item level. • Price Item Distribution Code Level - Indicates that the accrual is created to calculate the bill segments of a particular price item at the distribution code level. <p>Note:</p> <p>This field is populated automatically when you specify the account in the Account ID field.</p> <p>It is a read-only field and cannot be edited.</p>	Not applicable

Field Name	Field Description	Mandatory (Yes or No)
Accrual Type	Indicates the accrual type associated with the account.	Not applicable
	<p>Note:</p> <p>This field is populated automatically when you specify the account in the Account ID field.</p> <p>It is a read-only field and cannot be edited.</p>	
Accrual Creation Mode	Indicates the method using which the accrual is created for the account in the system. The valid values are: <ul style="list-style-type: none"> • Batch - Indicates whether the accrual is created using the batch mode. • Manual - Indicates whether the accrual is created manually in the system. 	Not applicable
	<p>Note:</p> <p>This field is populated automatically when you specify the account in the Account ID field.</p> <p>It is a read-only field and cannot be edited.</p>	
Currency	Indicates the currency using which the accrual is calculated for the account in the system.	Not applicable
	<p>Note:</p> <p>This field is populated automatically when you specify the account in the Account ID field.</p> <p>It is a read-only field and cannot be edited.</p>	
Comments	Used to specify additional information about the accrual.	No

Tip: Alternatively, you can access the **Accrual** screen by clicking the **Add** button in the **Page Title** area of the **Accrual** screen.

4. Define detail-specific characteristics for the accrual, if required.
5. Add details about the accrual, if required.
6. Click **Save**.
7. The accrual is defined.

Related Topics

For more information on...	See...
How to define a characteristic for an accrual	Defining a Characteristic for an Accrual on page 1943
How to add the details for an accrual	Adding the Details for an Accrual on page 1944

Defining a Characteristic for an Accrual

Prerequisites

To define a characteristic for an accrual, you should have:

- Characteristic types defined in the application (where the characteristic entity is set to **Accrual**).

Procedure

To define a characteristic for an accrual:

1. Ensure that the **Characteristics** section is expanded when you are defining or editing an accrual.

The **Characteristics** section contains the following fields in a grid:

Column Name	Column Description	Mandatory (Yes or No)
Accrual Detail Sequence	Used to specify the sequence in which the accrual processing must be executed.	Not applicable
	Note: It is a read-only field and cannot be edited.	
Effective Date	Used to specify the date from when the characteristic is effective for an accrual.	Yes (Conditional)
		Note: This field is required when you are defining a characteristic for an accrual.
Characteristic Type	Used to indicate the characteristic type.	Yes (Conditional)
	Note: The list includes only those characteristic types where the characteristic entity is set to Accrual .	Note: This field is required when you are defining a characteristic for an accrual.
Characteristic Value	Used to specify the value for the characteristic type.	Yes (Conditional)
	<p>Note:</p> <p>If you select a predefined characteristic type, the Search (🔍) icon appears corresponding to the Characteristic Value field. On clicking the Search icon, the Predefined Characteristic Search window appears.</p> <p>On specifying the value for a predefined characteristic type, the description of the characteristic value appears corresponding to the Characteristic Value field.</p>	Note: This field is required when you are defining a characteristic for an accrual.

2. Enter the required details in the **Characteristics** section.
3. If you want to define more than one characteristic for an accrual., click the **Add** (+) icon and then repeat step 2.

Note: However, if you want to remove a characteristic from an accrual, click the **Delete** (🗑️) icon corresponding to the characteristic.

4. Click **Save**.

The characteristics are defined for an accrual..

Related Topics

For more information on...	See...
How to define an accrual	Defining an Accrual on page 1939
How to edit an accrual	Editing an Accrual on page 1953

Adding the Details for an Accrual

Procedure

To add the details for an accrual:

1. Ensure that **Accrual Details** section is expanded when you are defining or editing an accrual.

The **Accrual Details** section contains the following fields in a grid:

Column Name	Column Description	Mandatory (Yes or No)
Price Item	Used to indicate the price item for an accrual.	Yes (Conditional)
	Note: The Search (🔍) icon appears corresponding to the Price Item field. On clicking the Search icon, the Price Item Search window appears.	Note: This field is required when the price item information is not defined for the accrual contract.
Amount	Used to specify the accrual amount.	Yes
Override Reason	Used to specify the override reason for the accrual.	No

2. Enter the required details in the **Accrual Details** section.
3. Click **Save**.

The accrual details are defined for an accrual.

Related Topics

For more information on...	See...
How to define an accrual	Defining an Accrual on page 1939
How to edit an accrual	Editing an Accrual on page 1953

Accrual (Used for Viewing)

The **Accrual** screen allows you to do the following:

- View the details of an accrual
- Define an accrual manually
- Edit an accrual

- Submit an accrual for approval
- Approve, Reject, and Re-Submit an accrual
- Delete an accrual
- View the accrual calculation lines

The **Accrual** screen contains the following tabs:

- [Accrual - Main](#) on page 1945
- [Accrual Log](#) on page 1949

Accrual - Main

The **Main** tab displays information about the accrual. It contains the following zones:

- [Accrual](#) on page 1945
- [Accrual Details](#) on page 1948
- [Accrual Calculation Lines](#) on page 1949

Accrual

The **Accrual** zone displays the details of an accrual. It contains the following sections:

- **Main** – Displays basic information about the accrual. It contains the following fields:

Field Name	Field Description
Accrual Information	Displays the concatenated string of information about the accrual separated by a comma (,).
Account Information	Displays the concatenated string of information about the account for which the accrual is created separated by a comma (,). In addition, a context menu appears corresponding to this field which helps in navigating to other screens in the application. Note: It has a link. On clicking the link, the Account screen appears where you can view the details of the respective account.
Contract Information	Displays the accrual-specific active contract that is associated with the account. In addition, a context menu appears corresponding to this field which helps in navigating to other screens in the application. Note: It has a link. On clicking the link, the Contract screen appears where you can view the details of the respective contract.
Division	Indicates the division which is associated with the accrual.
Status	Indicates the current status of the accrual. The valid values are: <ul style="list-style-type: none"> • Draft • Approval In Progress • Ready For Accrual • Accrued • Accrual Reversed • Rejected • Processed

Field Name	Field Description
	<ul style="list-style-type: none"> Ignore Cancelled
Accrual Cycle	Indicates the accrual cycle associated with the deal type which is used for creating the accrual.
Accrual Date	Displays the date on which the accrual is processed for the account.
Reversal Start Date	Displays the date from when the accrual reversal process starts for the account.
Reversal End Date	Displays the date till when the accrual reversal process ends for the account.
Accrual Type	Indicates the accrual type using which the accrual is calculated for the account.
Accrual Creation Mode	Displays the creation mode using which the accrual is calculated. <ul style="list-style-type: none"> Batch - Indicates whether the accrual is created using the batch mode. Manual - Indicates whether the accrual is created manually in the system.
Posting Method	Displays the level at which the accrual is calculated for the account. The valid values are: <ul style="list-style-type: none"> Bill Level - Indicates that the accrual is created to calculate the bill segments and adjustments of bills at the bill level. Bill Distribution Code Level - Indicates that the accrual is created to calculate the bill segments and adjustments of bills at the distribution code level. Price Item Level - Indicates that the accrual is created to calculate the bill segments and adjustments of bills at the price item level. Price Item Distribution Code Level - Indicates that the accrual is created to calculate the bill segments of a particular price item at the distribution code level.
Accrual Amount	Displays the accrual amount.

- **Characteristics** – Lists the detail-specific characteristics defined for the accrual. It contains the following fields:

Field Name	Field Description
Accrual Detail Sequence	Displays the sequence of the accrual detail.
Effective Date	Displays the date from when the characteristic is effective for the accrual detail.
Characteristic Type	Indicates the characteristic type.
Characteristic Value	Displays the value of the characteristic type.

- **Record Actions** – The **Record Actions** section contains the following buttons:

Button Name	Button Description
Edit	Used to edit the details of an accrual.
	Note: The Edit button appears only when the accrual is in the Draft or Ready for Accrual status.
Delete	Used to delete an accrual.
	Note: The Delete button appears only when the accrual is in the Draft or Ready for Accrual status.
Return to Draft	Used to send the accrual in the Draft status for editing.
	Note: The Return to Draft button appears only when the accrual is in the Ready for Accrual status.
Submit	Used to submit an accrual for approval.
	Note: The Submit button appears only when the accrual is in the Draft status.
Approve	Used to approve the accrual.
	Note: The Approve button appears only when the accrual is in the Approval in Progress status.
Reject	Used to reject the accrual.
	Note: The Reject button appears only when the accrual is in the Approval in Progress status.
Re Submit	Used to resubmit the accrual for specific changes.
	Note: The Re Submit button appears only when the accrual is in the Approval in Progress status.

- **Record Information** – The **Record Information** section contains the following fields:

Field Name	Field Description
Business Object	Indicates the business object using which the accrual is created in the system. In addition, a context menu appears corresponding to this field which helps in navigating to other screens in the application.
	Note: It has a link. On clicking the link, the Business Object screen appears where you can view the details of the respective business object.
Status Date/Time	Displays the date and time when the accrual status is updated in the system.
Create Date/Time	Displays the date and time when the accrual is created in the system.

Related Topics

For more information on...	See...
How to search for an accrual	Searching for an Accrual on page 1938
How to view the details of an accrual	Viewing the Accrual Details on page 1939

Accrual Details

The **Accrual Details** zone displays the details of an accrual. It contains the following columns:

Column Name	Column Description
Sequence Number	Displays the sequence in which the accrual detail is considered for accrual calculation.
Price Item	Displays the price item that is defined for the accrual calculation. Note: It contains a link. On clicking the link, the Price Item screen appears where you can view the details of the respective accrual adjustment.
Amount	Displays the accrual amount.
Override Reason	Displays the reason why the price item or the accrual amount is overridden in case if the accrual is edited.
Adjustment Information	Displays information about the adjustment that is created using the accrual creation batch. Note: It contains a link. On clicking the link, the Adjustment screen appears where you can view the details of the respective adjustment.

On clicking the **Broadcast** (📡) icon corresponding to an accrual detail, the **Accrual Calculation Lines** zone appears where you can view a list of calculation lines for the respective accrual detail.

Note:

The **Accrual Calculation Lines** zone appears only when the following conditions are satisfied:

- The **Calculation Lines Required** check box is selected for the accrual type which is associated with the accrual.
- Accrual is created using the batch process and not manually from the user interface.
- Accrual is created using an accrual type with either of the following combinations:

Accrual Criteria	Accrual Source	Posting Method
Historical	-	Bill Level
Historical	-	Price Item Level
Actual	Trial Bill	Bill Level
Actual	Trial Bill	Price Item Level

- When the **Do you want to insert detail level calculation?** parameter in the **Accrual Calculation (C1_ACCR_CAL)** algorithm is set to Y.

Related Topics

For more information on...	See...
How to search for an accrual	Searching for an Accrual on page 1938

For more information on...	See...
How to view the details of an accrual	Viewing the Accrual Details on page 1939

Accrual Calculation Lines

The **Accrual Calculation** zone displays the calculation lines generated after the accrual creation batch is executed for a particular accrual detail. It contains the following columns:

Column Name	Column Description
Entity Information	Displays the concatenated string of information about the entity separated by a comma (,) for which the calculation line is created.
Entity Type	Indicates the type of the entity.
Inclusion Amount	Displays the amount calculated for the specific entity for accrual.
Bill Cycle Days	Displays the number of days after which the accrual calculation is done for the entity.
Historical Calculation Days	Displays the historical days for which the accrual calculation is done for the entity.
Bill Information	Displays the concatenated string of information about the bill separated by a comma (,). In addition, a context menu appears corresponding to this field which helps in navigating to other screens in the application. Note: It has a link. On clicking the link, the Bill screen appears where you can view the details of the respective bill.
Recurring Charge Calculation Days	Displays the number of days after which the recurring charge is calculated for the entity.
Recurring Charge Total Days	Displays the total number of days for which the recurring charge is calculated for the entity.

By default, the **Accrual Calculation Lines** zone does not appear in the **Accrual** screen. It appears when you click the **Broadcast** (📡) icon corresponding to the accrual detail in the **Accrual Details** zone.

Related Topics

For more information on...	See...
How to search for an accrual	Searching for an Accrual on page 1938
How to view the details of an accrual	Viewing the Accrual Details on page 1939
Accrual Details zone	Accrual Details on page 1948

Accrual - Log

The **Log** tab lists the complete trail of actions performed on the accrual. It consists of the following zone:

- [Accrual Log](#) on page 1949

Accrual Log

The **Accrual Log** zone lists the complete trail of actions performed on the accrual. It contains the following columns:

Column Name	Column Description
Date/Time	Displays the date and time when the action was performed on the accrual.
Details	Displays the details about the action performed on the accrual.
User	Indicates the user who has performed the action on the accrual.
Log Type	Indicates the type of log.
Related Object	Indicates the object or entity which is created when the action is performed on the accrual.

Note:

You can manually add a log entry for the accrual by clicking the **Add Log Entry** link in the upper right corner of the **Accrual Log** zone.

Related Topics

For more information on...	See...
How to view the log of an accrual	Viewing the Log of an Accrual on page 1950
How to add a log entry for an accrual	Adding a Log Entry for an Accrual on page 1950

Viewing the Log of an Accrual**Procedure**

To view the log of an accrual:

1. Search for the accrual in the **Accrual** screen.
2. In the **Search Results** section, click the link in the **Accrual Information** column corresponding to the accrual whose log you want to view.
The **Accrual** screen appears.
3. Click the **Log** tab.
The **Log** tab appears.
4. View the complete trail of actions performed on the accrual in the **Accrual Log** zone.

Related Topics

For more information on...	See...
How to search for an accrual	Searching for an Accrual on page 1938
Accrual screen	Accrual (Used for Viewing) on page 1944
Accrual - Log tab	Accrual - Log on page 1949
Accrual Log zone	Accrual Log on page 1949

Adding a Log Entry for an Accrual**Procedure**

To add a log entry for an accrual:

1. Search for the accrual in the **Accrual** screen.

- In the **Search Results** section, click the link in the **Accrual Information** column corresponding to the accrual for which you want to add a log entry.

The **Accrual** screen appears.

- Click the **Log** tab.

The **Log** tab appears.

- Click the **Add Log Entry** link in the upper right corner of the **Accrual Log** zone.

The **Add Accrual Log** window appears. It contains the following fields:

Field Name	Field Description	Mandatory (Yes or No)
Accrual Information	Displays the concatenated string of information about the accrual separated by a comma (,).	Not applicable
Log Details	Used to specify the reason for creating a new log entry for the accrual.	Yes

- Enter the required details in the **Log Details** field.
- Click **Save**.

The log entry is added for the accrual.

Related Topics

For more information on...	See...
How to search for an accrual	Searching for an Accrual on page 1938
Accrual screen	Accrual (Used for Viewing) on page 1944
Accrual - Log tab	Accrual - Log on page 1949
Accrual Log zone	Accrual Log on page 1949

Approving an Accrual

Procedure

To approve an accrual:

- Search for the accrual in the **Accrual** screen.
- In the **Search Results** section, click the link in the **Accrual Information** column corresponding to the accrual that you want to approve.

The **Accrual** screen appears. It consists of the following tabs:

- Ensure that the **Main** tab is selected.
- Click the **Approve** button in the **Accrual** zone.

The status of the accrual is changed to **Processed**.

Note: The **Approve** button appears only when the accrual is in the **Approval in Progress** status.

Related Topics

For more information on...	See...
How to search for an accrual	Searching for an Accrual on page 1938

For more information on...	See...
Accrual screen	Accrual (Used for Viewing) on page 1944
Accrual - Main tab	Accrual - Main on page 1945
Accrual zone	Accrual on page 1945

Rejecting an Accrual

Procedure

To reject an accrual:

1. Search for the accrual in the **Accrual** screen.
2. In the **Search Results** section, click the link in the **Accrual Information** column corresponding to the accrual that you want to reject.

The **Accrual** screen appears. It consists of the following tabs:

3. Ensure that the **Main** tab is selected.
4. Click the **Reject** button in the **Accrual** zone.

The **Accrual** window appears. It contains the following fields:

Field Name	Field Description	Mandatory (Yes or No)
Status Reason	Used to indicate the reason why you want to reject the payment request.	Yes
Comments	Used to specify additional information for rejecting the accrual.	No

Note: The **Reject** button appears only when the accrual is in the **Approval in Progress** status.

5. Enter the required details in the **Accrual** window.
6. Click **Save**.

The status of the accrual is changed to **Rejected**.

Related Topics

For more information on...	See...
How to search for an accrual	Searching for an Accrual on page 1938
Accrual screen	Accrual (Used for Viewing) on page 1944
Accrual - Main tab	Accrual - Main on page 1945
Accrual zone	Accrual on page 1945

Resubmitting an Accrual

Procedure

To resubmit an accrual:

1. Search for the accrual in the **Accrual** screen.
2. In the **Search Results** section, click the link in the **Accrual Information** column corresponding to the accrual that you want to resubmit.

The **Accrual** screen appears.

3. Ensure that the **Main** tab is selected.
4. Click the **Re Submit** button in the **Accrual** zone.

The **Resubmit Accrual** window appears. It contains the following field:

Field Name	Field Description	Mandatory (Yes or No)
Comments	Used to specify details about resubmitting the accrual.	Yes

Note: The **Re Submit** button appears only when the accrual is in the **Approval in Progress** status.

5. Click **Save**.

The status of the accrual is changed to **Draft**.

Related Topics

For more information on...	See...
How to search for an accrual	Searching for an Accrual on page 1938
Accrual screen	Accrual (Used for Viewing) on page 1944
Accrual - Main tab	Accrual - Main on page 1945
Accrual zone	Accrual on page 1945

Editing an Accrual

Prerequisites

To edit an accrual, you should have:

- Account (for which you want to define the accrual) defined in the application.
- Accrual-specific active contract associated with the account.
- Batch **C1_ACCRE** defined in the application, if an accrual creation takes place through a batch.
- Algorithm **C1_ACCR_CAL** defined for accrual calculation in the application.
- Algorithm **C1_ACCR_REV** defined for accrual reversal in the application.
- Accrual type associated with the division to which the account belongs or accrual type associated with the account for accrual calculation.
- Characteristic types defined in the application (where the characteristic entity is set to **Accrual**).

Procedure

To edit an accrual:

1. Search for the accrual in the **Accrual** screen.
2. In the **Search Results** section, click the link in the **Accrual Information** column corresponding to the accrual whose details you want to edit.

The **Accrual** screen appears.

3. Ensure that the **Main** tab is selected.
4. Click the **Edit** button in the **Accrual** zone

The **Accrual** screen appears. It contains the following sections:

- **Main** – Used to specify basic details about the accrual. It contains the following fields:

Field Name	Field Description	Mandatory (Yes or No)
Account ID	Used to search a particular account.	Yes
	Note: It is a read-only field and cannot be edited.	
Contract	Used to specify the accrual contract of the account.	Not applicable
	Note: It is a read-only field and cannot be edited.	
Accrual Cycle	Used to specify the accrual cycle for the account.	Not applicable
	Note: It is a read-only field and cannot be edited.	
Posting Method	Used to specify the posting method used for an accrual.	Not applicable
	Note: It is a read-only field and cannot be edited.	
Accrual Type	Used to specify the type of an accrual.	Not applicable
	Note: It is a read-only field and cannot be edited.	
Accrual Creation Mode	Used to specify the creation method of an accrual.	Not applicable
	Note: It is a read-only field and cannot be edited.	
Currency	Used to specify the currency used for calculating the accrual.	Not applicable
	Note: It is a read-only field and cannot be edited.	
Comments	Used to specify the comments for an accrual.	No

5. Add, edit, or remove the detail-specific characteristics from the accrual, if required.
6. Add, edit, or remove the details of the accrual.
7. Click **Save**.

The changes made to the accrual are saved.

Note:

You can edit an accrual only when it is in the **Ready for Accrual** status.

While editing an accrual which is created through a batch process, the system allows you to edit only the accrual amount of the bill or the price item in the **Accrual Details** zone. Whereas, if you are editing an accrual which is created manually, the system allows you to edit the price item code as well as the accrual amount of the price item or the bill in the **Accrual Details** zone. The override reason is mandatory when you are editing a manually created accrual in the system.

Related Topics

For more information on...	See...
Accrual screen	Accrual (Used for Searching) on page 1936
Accrual screen	Accrual (Used for Viewing) on page 1944
Accrual - Main tab	Accrual - Main on page 1945
Accrual zone	Accrual on page 1945
How to define a characteristic for an accrual	Defining a Characteristic for an Accrual on page 1943
How to add the details for an accrual	Adding the Details for an Accrual on page 1944

Deleting an Accrual**Procedure**

To delete an accrual:

1. Search for the accrual in the **Accrual** screen.
2. In the **Search Results** section, click the link in the **Accrual Information** column corresponding to the accrual that you want to delete.

The **Accrual** screen appears.

3. Ensure that the **Main** tab is selected.
4. Click the **Delete** button in the **Accrual** zone.

A message appears confirming whether you want to delete the accrual.

5. Click **OK**.

The accrual is deleted.

Note: You can delete an accrual only when it is created manually in the system and is in the **Draft** or **Ready for Accrual** status.

Related Topics

For more information on...	See...
How to search for an accrual	Searching for an Accrual on page 1938
Accrual screen	Accrual (Used for Viewing) on page 1944
Accrual - Main tab	Accrual - Main on page 1945
Accrual zone	Accrual on page 1945

Chapter 30

Payment Agreement Request

Topics:

- [Payment Agreement Request \(Without Approval\) Status Transition](#)
- [Payment Agreement Request \(With Approval\) Status Transition](#)
- [Prerequisites](#)
- [Algorithms Used in C1-PaymentAgreementRequest](#)
- [Payment Agreement Request Type](#)
- [Payment Agreement Request \(Used for Searching\)](#)
- [Payment Agreement Request \(Used for Viewing\)](#)

Oracle Revenue Management and Billing provides the ability to schedule payments in installments for a set of unpaid bills of an account through a payment agreement request. Let us understand this with the help of an example. The following bills of the account A1 are unpaid:

- B1 (Bill Amount – 100\$, Unpaid Amount - 75\$)
- B2 (Bill Amount – 250\$, Unpaid Amount – 125\$)
- B3 (Bill Amount – 150\$, Unpaid Amount – 150\$)

Through a payment agreement request, you can schedule payments for these three bills in various installments. For example, you can schedule the following payments for the account A1:

Schedule Date	Schedule Amount
01-Jan-2017	100
15-Jan-2017	100
01-Feb-2017	100
15-Feb-2017	50

While creating a payment agreement request, you need to specify the payment agreement request type using which you want to create the payment agreement request. It is the payment agreement request type which helps the system to determine:

- The business object using which the payment agreement request should be created
- Whether the approval is required for the payment agreement request

You can only add completed bills of the account which are unpaid in a payment agreement request. Once a payment agreement request is created for an account, the status of the payment agreement request is set to **Draft**. You can then edit or delete the payment agreement request, if required. Once you add the unpaid bills of the account, you can submit the payment agreement request. On submitting a payment agreement request, the status of the payment agreement request is set to **Active**.

You can optionally configure the system to use the approval workflow process for a payment agreement request. If the **Approval Required** flag is set to **Yes** in a payment agreement request type, then on submitting the respective payment agreement request, the approval workflow process creates a To Do for the approver to review the payment agreement request. Once the approver approves the payment agreement request, the status of the payment agreement request is set to **Active**. The approver can approve, reject, or resubmit the payment

agreement request. When the payment agreement request is resubmitted to the submitter, the status of the payment agreement request is set to **Draft**.

Even if the approval workflow is configured for a payment agreement request type, you can skip the approval workflow for a payment agreement request. The system enables you to skip the approval workflow for a payment agreement request until you exceed the maximum limit defined in the **C1-PASUBMIT** algorithm. You can define the following parameters in the **C1-PA-SUBMIT** algorithm:

- Number of days to consider in past to check whether any payment agreement request with a particular status exist in the specified duration (for example, 365)
- Maximum number of payment agreement requests which can be activated without approval (for example, 1)
- Status in which payment agreement request should exist in the specified duration (for example, Broken Promise)

In the above example, on clicking the **Submit** button, the system will check how many payment agreement requests for the account in the last 365 days exist in the **Broken Promise** status. If the system finds one or more than one payment agreement requests in the **Broken Promise** status in the last 365 days, the approval workflow process creates a To Do for the approver to review the payment agreement request. However, if the system does not find any payment agreement request in the **Broken Promise** status in the last 365 days, the payment agreement request is not sent for approval and the status of the payment agreement request is directly changed to **Active**.

When the **Payment Agreement Request Periodic Monitor (C1-PAREQ)** batch is invoked, the system checks whether there are any payment agreement requests in the **Active** status. If there is a payment agreement request in the **Active** status, the system checks whether the total unpaid amount of the bills is equal to zero and whether each bill is fully matched. If so, the status of the payment agreement request is changed to **Kept Promise**. However, if the total unpaid amount of the bills is not equal to zero, the system checks whether the current date is later than the schedule date and does not fall within the grace period. If so, the system checks whether total unpaid amount is greater than the total future schedule amount. If so, the status of the payment agreement request is changed to **Broken Promise**. However, if the current date is earlier than the schedule date or falls within the grace period, or the total unpaid amount is less than the total future schedule amount, the status of payment agreement request remains in **Active**. The system enables you to edit a payment agreement request which is in the **Active** status.

While defining a payment agreement request, you need to specify the payment method through which the payment will be done and whether the payment will be done through the payor or third party payor account. If the **Auto Pay** flag is set to **Yes** for a payment method, you need to also specify the automatic payment option using which the automatic payment should be created on the schedule date. One more batch named **Generate Auto Pay for Payment Agreement (C1-APPAB)** is introduced in this release. When the **Generate Auto Pay for Payment Agreement (C1-APPAB)** batch is invoked, the system checks whether there are any payment agreement requests in the **Active** status. If so, whether the account for which the payment agreement request is created is eligible for automatic payment and the defer auto pay date (if any) defined for the account is earlier than the batch business date. If so, the system checks whether the extract date of the unpaid bill (with the earliest due date) is earlier than the schedule date.

If so, the system creates the automatic payment for the unpaid bill on the schedule date. However, if the account is not eligible for automatic payment, or the defer auto pay date is equal to or later than batch business date, or the extract date is equal to or later than the schedule date, the automatic payment is not generated for the account.

During the payment agreement request process, a payment agreement request creation goes through various statuses in its lifecycle. For more information about the payment agreement request statuses, see [Payment Agreement Request \(Without Approval\) Status Transition](#) on page 1960 and [Payment Agreement Request \(With Approval\) Status Transition](#) on page 1960. If the payment agreement request type is without approval then payment agreement status will automatically move from draft to active. The approval configuration algorithm **C1-PA-APPEXT** decides whether the request will be sent for approval or not. If the payment agreement request type is with approval then payment agreement will be sent for approval depending on:

- The number of days checked for approval workflow
- Payment agreement statuses (active, broken, kept) to be considered
- The maximum number of payment agreements allowed

Note: The lifecycle of a payment agreement request creation is driven by the respective business object using which the request is created. The payment agreement request feature explained in this document is articulated based on the lifecycle and logic defined in the business objects.

For more information on how to setup the payment agreement request process, see [Prerequisites](#) on page 1961.

Payment Agreement Request (Without Approval) Status Transition

The following figure graphically indicates how a payment agreement request moves from one status to another when approval workflow is off:

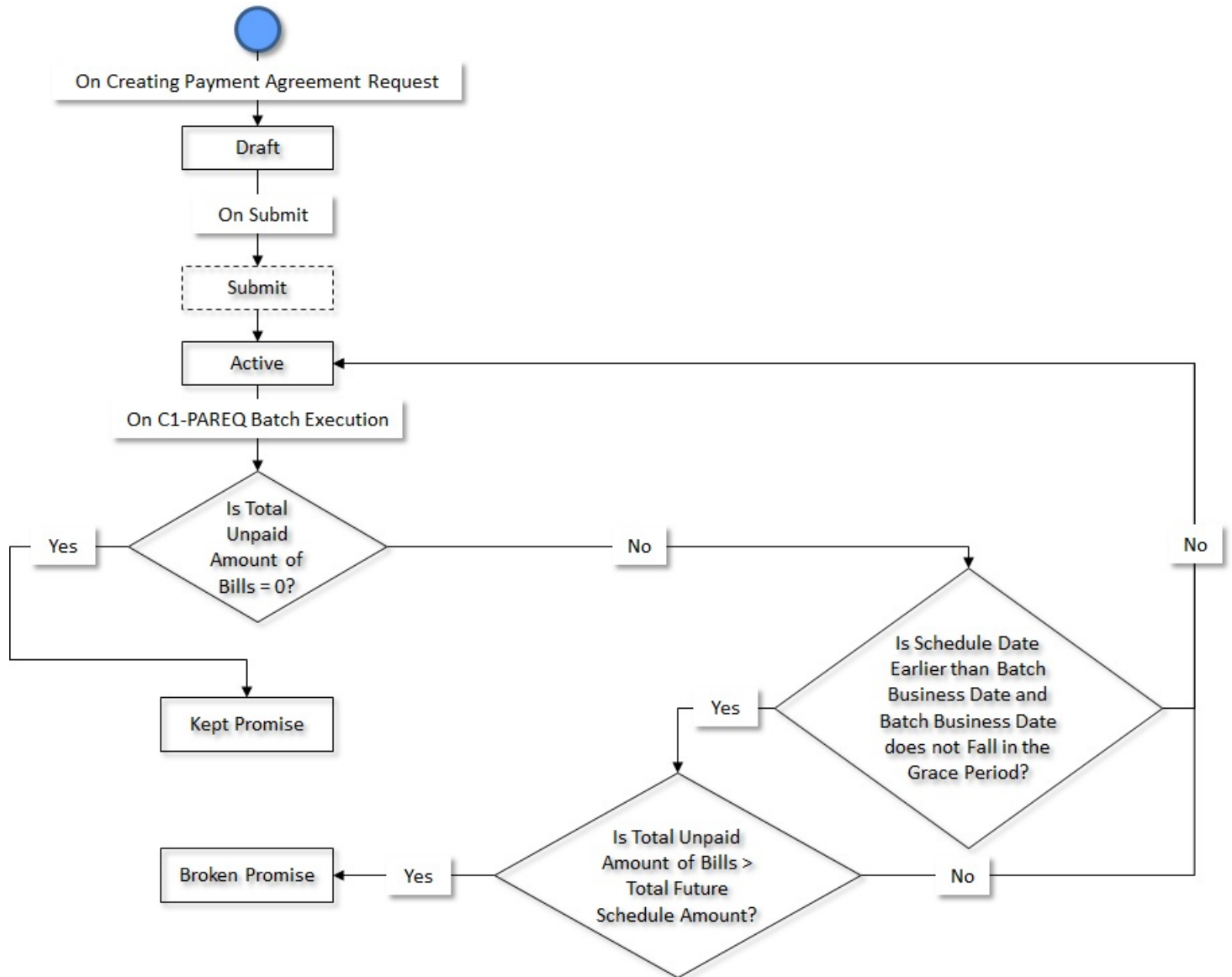

Payment Agreement Request (With Approval) Status Transition

The following figure graphically indicates how a payment agreement request moves from one status to another when approval workflow is on:

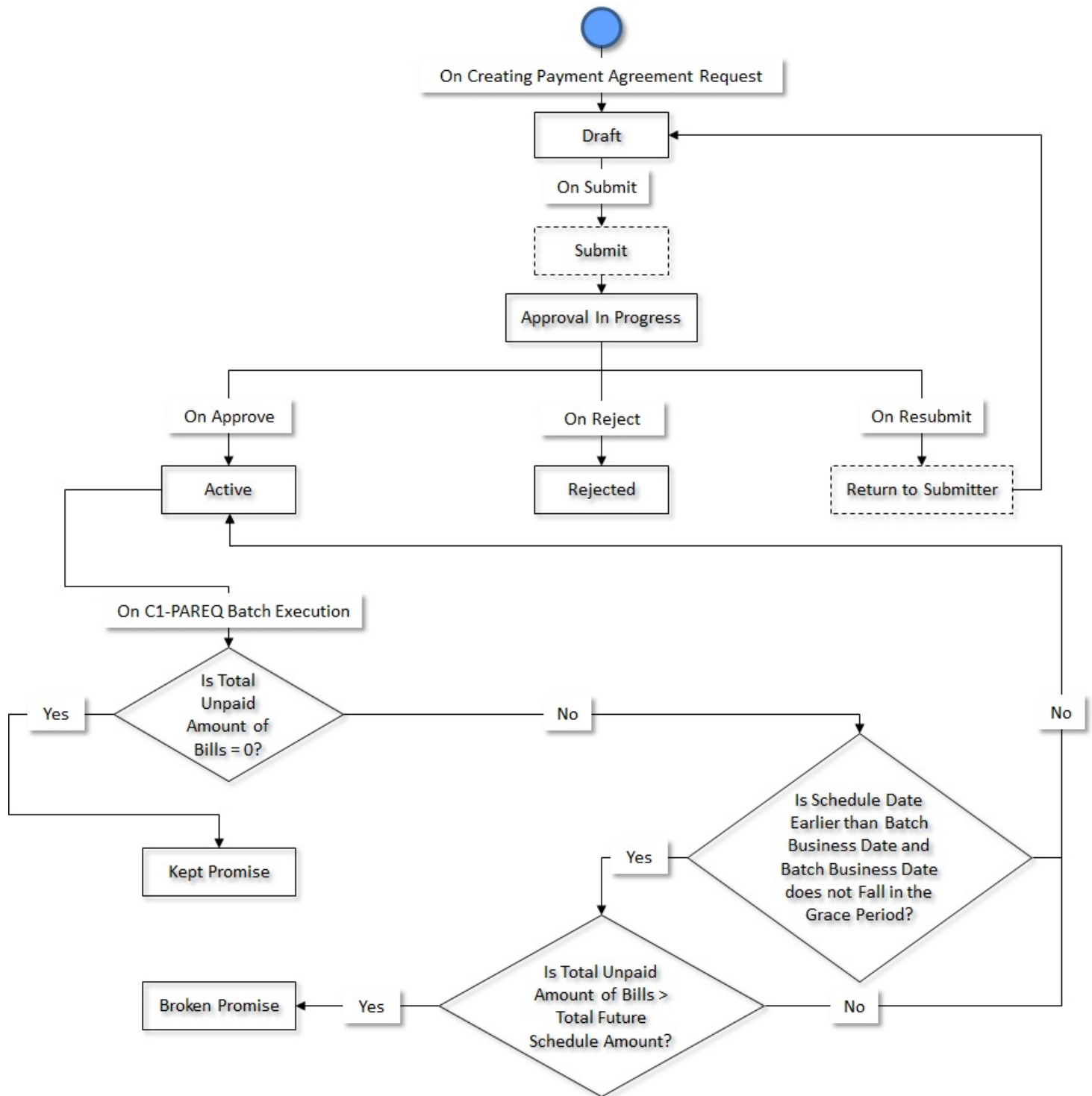

Prerequisites

To setup the payment agreement request process, you need to do the following:

- Define the required payment agreement request types in the system
- Define the required characteristic types where the characteristic entity is set to **Payment Agreement Request**

- Define the required characteristic types where the characteristic entity is set to **Payment Agreement Request Type**
- Define the required pay methods for **Payment Agreement Request**
- Define the required third party payors for **Payment Agreement Request**
- Create an algorithm using the **C1-PA-INFO** algorithm type if you want to create Payment Agreement Requests using the payment agreement request information.
- Define the kept promise status reason for the **C1-PaymentAgreementRequest** business object
- Define the broken promise status reason for the **C1-PaymentAgreementRequest** business object
- Defined rejected status reason for the **C1-PaymentAgreementRequest** business object
- Assign the **C1-PAREQ** To Do type to a To Do role whose users must receive To Do generated while submitting or resubmitting a payment agreement request for approval
- The **Payment Agreement Request Periodic Monitor (C1-PAREQ)** batch process to monitor the payment agreement request and move the request to next stage

Algorithms Used in C1-PaymentAgreementRequest

The following table lists the algorithms which are attached to the **C1-PaymentAgreementRequest** business object:

System Event	Algorithm	Algorithm Type	Description
Information	C1-PA-INFO	C1-PA-INFO	Refer to C1-PA-INFO on page 1962
Pre-Processing	C1-PA-PRE	C1-PA-PRE	Refer to C1-PA-PRE on page 1963
Validation	C1-PA-VAL	C1-PA-VAL	Refer to C1-PA-PRE on page 1963

The following table lists the algorithms which are used in the lifecycle of the **C1-PaymentAgreementRequest** business object:

Status	System Event	Algorithm	Algorithm Type	Description
Submit	Enter	C1-PA-SUBMIT	C1-PA-SUBMIT	Refer to C1-PA-SUBMIT on page 1963
Approval Progress	In Enter	C1-PA-APPENT	C1-PA-APPENT	Refer to C1-PA-APPENT on page 1963
Approval Progress	In Exit	C1-PA-APPEXT	C1-PA-APPEXT	Refer to C1-PA-APPEXT on page 1963
Return to Submitter	Enter	C1-PA-RESUB	C1-PA-RESUB	Refer to C1-PA-RESUB on page 1963
Active	Monitor	C1-PA-MONTR	C1-PA-MONTR	Refer to C1-MONTR on page 1963
Active	Enter	C1-PA-ACTENT	C1-PA-ACTENT	Refer to C1-ACTENT on page 1963

C1-PA-INFO

This algorithm generates the payment agreement request information string which appears throughout the application. This algorithm concatenates the following fields:

- Payment Agreement Request Type Description

- Payment Agreement Request Status Description
- Payment Agreement Request ID

C1-PA-PRE

This Algorithm is used to avoid the concurrency issue for payment agreement.

C1-PA-SUBMIT

This Algorithm is used to validate payment agreement request.

C1-PA-APPENT

This algorithm creates **To Do** based on the **Approval To Do Type** configured in Payment Agreement Request Type.

C1-PA-APPEXT

This algorithm checks whether an approver is associated with the approval **To Do Role** specified in the **Payment Agreement Request Type**. It does not allow the submitter to approve or reject the payment agreement request.

C1-PA-RESUB

This algorithm is invoked on **Re-Submit** button. It moves the status of Payment Agreement Request into **Draft**. A 'To Do' will be generated for the user as submitter whose **To Do Type** and **To Do Role** are fetched from Payment Agreement Request Type.

C1-MONTR

This algorithm is invoked from the **Payment Agreement Request Periodic Monitor (C1-PAREQ)** batch. It changes the status of the payment request from **Active** to **KP** (Kept Promise) or **BP** (Broken Promise) based on payment received.

C1-ACTENT

This algorithm will validate Payment Agreement Request before activation.

Payment Agreement Request Type

Oracle Revenue Management and Billing allows you to define, edit, copy and delete a payment agreement request type using which you can pay current unpaid debt bills in multiple installments whose payment amount is greater than zero. A payment agreement provide flexibility in payment of installment amount and schedule of payment.

The **C1-PaymentAgreementRequest** business object is created for payment agreement maintenance.

The **Payment Agreement Request Type** screen consists of the following zones:

- [Payment Agreement Request Type List](#) on page 1963
- [Payment Agreement Request Type](#) on page 1964

Payment Agreement Request Type List

The **Payment Agreement Request Type List** zone lists payment agreement request types that are already defined in the system. It contains the following columns:

Column Name	Column Description
Payment Agreement Request Type	Displays the payment agreement request type.

Column Name	Column Description
Description	Displays the description of the payment agreement request type.
Edit	On clicking the Edit (✎) icon, the Payment Agreement Request Type screen appears where you can edit the details of the payment agreement request type.
Duplicate	On clicking the Duplicate (📄) icon, the Payment Agreement Request Type screen appears where you can define a payment agreement request type using an existing payment agreement request type.
Delete	On clicking the Delete (🗑) icon, you can delete the payment agreement request type. Note: You can delete a payment agreement request type when you have not created a payment agreement request using the payment agreement request type.

On clicking the **Broadcast** (📡) icon corresponding to a payment agreement request type, the **Payment Agreement Request Type** zone appears with the details of the respective payment agreement request type.

Related Topics

For more information on...	See...
How to define a payment agreement request type	Defining a Payment Agreement Request Type on page 1967
How to define a characteristic for a payment agreement request type	Defining a Characteristic for a Payment Agreement Request Type on page 1969
How to edit a payment agreement request type	Editing a Payment Agreement Request Type on page 1970
How to copy a payment agreement request type	Copying a Payment Agreement Request Type on page 1973
How to delete a payment agreement request type	Deleting a Payment Agreement Request Type on page 1975
How to view the details of a payment agreement request type	Viewing the Payment Agreement Request Type Details on page 1976

Payment Agreement Request Type

The **Payment Agreement Request Type** zone displays the details of the payment agreement request type. This zone contains the following sections:

- **Main** – This section provides basic information about the payment agreement request type. It contains the following fields:

Field Name	Field Description
Payment Agreement Request Type	Displays the payment agreement request type.
Description	Displays the description of the payment agreement request type.
Payment Agreement Request Business Object	Indicates the business object that will be used to create the payment agreement request. In addition, a context menu appears corresponding to this field which helps in navigating to other screens in the application. Note: It has a link. On clicking the link, the Business Object screen appears where you can view the details of the respective business object.
Detailed Description	Displays additional information about the payment agreement request type.

Field Name	Field Description
Status	<p>Indicates the status of the payment agreement request type. The valid values are:</p> <ul style="list-style-type: none"> • Active • Inactive
Status Change Notification Type	<p>Indicates the notification type on the status change of payment agreement request type. The valid values are:</p> <ul style="list-style-type: none"> • Alert • To Do • Both
Approval Required	<p>Indicates whether approval is required while creating payment agreement request using the payment agreement request type.</p>
Approval To Do Type	<p>Indicates that the To Do entry of the specified To Do type must be created when you submit the payment agreement request for approval.</p> <div style="border: 1px solid black; padding: 5px;"> <p>Note:</p> <p>This field appears when the Approval Required check box is selected.</p> <p>It has a link. On clicking the link, the To Do Type screen appears with the details of the respective To Do type.</p> <p>The Search (🔍) icon appears corresponding to this field. On clicking the Search icon, the To Do Type Search window appears.</p> </div>
Approval To Do Role	<p>Indicates that users with the specified To Do role can only approve or reject the payment agreement request submitted for approval.</p> <div style="border: 1px solid black; padding: 5px;"> <p>Note:</p> <p>This field appears when the Approval Required check box is selected.</p> <p>It has a link. On clicking the link, the To Do Role screen appears with the details of the respective To Do role.</p> </div>
Submitter To Do Type	<p>Indicates the To Do type for the submitter when the payment agreement request type is resubmitted by the approver.</p> <div style="border: 1px solid black; padding: 5px;"> <p>Note:</p> <p>This field appears when the Approval Required check box is selected.</p> <p>It has a link. On clicking the link, the To Do Type screen appears with the details of the respective To Do type.</p> <p>The Search (🔍) icon appears corresponding to this field. On clicking the Search icon, the To Do Type Search window appears.</p> </div>
Submitter To Do Role	<p>Indicates the To Do role of the submitter when the payment agreement request type is resubmitted by the approver.</p>

Field Name	Field Description
	<p>Note:</p> <p>This field appears when the Approval Required check box is selected.</p> <p>It has a link. On clicking the link, the To Do Role screen appears with the details of the respective To Do role.</p>

- **Characteristics** – This section lists the characteristics of the payment agreement request type. It contains the following columns:

Column Name	Column Description	Mandatory (Yes Or No)
Characteristic Type	Indicates the characteristic type.	No
Characteristic Value	Displays the value of the characteristic type.	No

- **Record Actions** – This section contains the following buttons:

Button Name	Button Description
Edit	Used to edit the details of the payment agreement request type.
Delete	Used to delete the payment agreement request type.
	<p>Note: You can delete a payment agreement request type when you have not created a payment agreement request using the payment agreement request type.</p>
Duplicate	Used to create a new payment agreement request type using an existing payment agreement request type.

- **Record Information** – This section contains the following fields:

Field Name	Field Description
Business Object	Indicates the business object using which the payment agreement request type is created. In addition, a context menu appears corresponding to this field which helps in navigating to other screens in the application.
	<p>Note: It has a link. On clicking the link, the Business Object screen appears where you can view the details of the respective business object.</p>

By default, the **Payment Agreement Request Type** zone does not appear in the **Payment Agreement Request Type** screen. It appears when you click the **Broadcast** () icon corresponding to a payment agreement request type in the **Payment Agreement Request Type List** zone.

Related Topics

For more information on...	See...
How to define a payment agreement request type	Defining a Payment Agreement Request Type on page 1967
How to define a characteristic for a payment agreement request type	Defining a Characteristic for a Payment Agreement Request Type on page 1969
How to edit a payment agreement request type	Editing a Payment Agreement Request Type on page 1970

For more information on...	See...
How to copy a payment agreement request type	Copying a Payment Agreement Request Type on page 1973
How to delete a payment agreement request type	Deleting a Payment Agreement Request Type on page 1975
How to view the details of a payment agreement request type	Viewing the Payment Agreement Request Type Details on page 1976

Defining a Payment Agreement Request Type

Prerequisites

To define a payment agreement request type, you should have:

- Payment agreement request business objects defined in the application
- The Payment Agreement Request Information algorithm is defined using the **C1-PA-INFO** algorithm type
- **C1-PAREQ** To Do Type assigned to a To Do role whose users must receive To Do generated while submitting a payment agreement request for approval.

Procedure

To define a payment agreement request type:

1. Click the **Admin** link in the **Application** toolbar.
A list appears.
2. From the **Admin** menu, select **P** and then click **Payment Agreement Request Type**.
A sub-menu appears.
3. Click the **Add** option from the **Payment Agreement Request Type** sub-menu.

The **Select Business Object** screen appears. It contains the following field:

Field Name	Field Description	Mandatory (Yes or No)
Payment Agreement Request Type Business Object	Used to indicate the business object that you want to use to create the payment agreement request type.	Yes

Tip: Alternatively, you can access the **Select Business Object** screen by clicking the **Add** button in the **Page Title** area of the **Payment Agreement Request Type** screen.

Note: The **Select Business Object** screen appears when there are multiple payment agreement request type business objects defined in the application. If there is only one payment agreement request type business object defined in the application, the **Payment Agreement Request Type** screen appears.

4. Select the required payment agreement request type business object from the respective field.
5. Click **OK**.

The **Payment Agreement Request Type** screen appears. It contains the following sections:

- **Main** – Used to specify basic details about the payment agreement request type.
- **Characteristics** – Used to define the characteristics for the payment agreement request type.

The **Main** section contains the following fields:

Field Name	Field Description	Mandatory (Yes or No)
Payment Agreement Request Type	Used to specify the payment agreement request type.	Yes
Business Object	Indicates the payment agreement request type business object used while defining the payment agreement request type.	Not applicable
Description	Used to specify the description for the payment agreement request type.	Yes
Payment Agreement Request Business Object	Used to indicate the business object that you want to use while creating the payment agreement request.	Yes
Detailed Description	Used to specify additional information about the payment agreement request type.	No
Status	Used to indicate the status of the payment agreement request type. The valid values are: <ul style="list-style-type: none"> Active Inactive 	Yes
Status Change Notification Type	Used to indicate the notification type on the status change of payment agreement request type. The valid values are: <ul style="list-style-type: none"> Alert To Do Both 	No
Approval Required	Used to indicate whether approval is required for creating payment agreement request using the payment agreement request type.	No
Approval To Do Type	Used to indicate that To Do of the specified To Do type must be created when you submit the payment agreement request for approval. <p>Note: This field appears when the Approval Required check box is selected.</p>	Yes (Conditional) <p>Note: This field is required when the Approval Required option is selected.</p>
Approval To Do Role	Used to indicate that users with the specified To Do role can only approve the payment agreement request submitted for approval. <p>Note: This field appears when the Approval Required check box is selected.</p>	Yes (Conditional) <p>Note: This field is required when the Approval Required option is selected.</p> <p>The list will include only those To Do roles which are associated with the To Do type specified in the Approval To Do Type field.</p>

Field Name	Field Description	Mandatory (Yes or No)
Submitter To Do Type	Used to indicate the To Do type for the submitter when the payment agreement request is resubmitted by the approver.	Yes (Conditional)
	Note: This field appears when the Approval Required check box is selected.	Note: This field is required when the Approval Required option is selected.
Submitter To Do Role	Used to indicate the To Do role for the submitter when the payment agreement request is resubmitted by the approver.	Yes (Conditional)
	Note: This field appears when the Approval Required check box is selected.	Note: This field is required when the Approval Required option is selected. The list will include only those To Do roles which are associated with the To Do type specified in the Submitter To Do Type field.

6. Enter the required details.
7. Define characteristics for the payment agreement request type, if required.
8. Click **Save**.

The payment agreement request type is defined.

Related Topics

For more information on...	See...
Payment Agreement Request Type screen	Payment Agreement Request Type on page 1963
Payment Agreement Request Type List zone	Payment Agreement Request Type List on page 1963
How to define a characteristic for a payment agreement request type	Defining a Characteristic for a Payment Agreement Request Type on page 1969

Defining a Characteristic for a Payment Agreement Request Type

Prerequisites

To define a characteristic for a payment agreement request type, you should have:

- Characteristic types defined in the application (where the characteristic entity is set to Payment Agreement Request Type)

Procedure

To define a characteristic for a payment agreement request type:

1. Ensure that the **Characteristics** section is expanded when you are defining, editing, or copying a payment agreement request type.

The **Characteristics** section contains the following fields:

Field Name	Field Description	Mandatory (Yes or No)
Characteristic Type	Used to indicate the characteristic type.	Yes (Conditional)
	Note: The list includes only those characteristic types where the characteristic entity is set to Payment Agreement Request Type.	Note: This field is required when you are defining a characteristic for the payment agreement request type.
Characteristic Value	Used to specify the value for the characteristic type.	Yes (Conditional)
	Note: On specifying the value for a predefined characteristic type, the description of the characteristic value appears corresponding to the Characteristic Value field.	Note: This field is required when you are defining a characteristic for the payment agreement request type.

- Enter the required details.

Note: If you select a predefined characteristic type, the **Search** (🔍) icon appears corresponding to the **Characteristic Value** field. On clicking the **Search** icon, you can search for a predefined characteristic value.

- If you want to define more than one characteristic for the payment agreement request type, click the **Add** (+) icon and then repeat step 2.

Note: However, if you want to remove a characteristic from the payment agreement request type, click the **Delete** (🗑️) icon corresponding to the characteristic.

Related Topics

For more information on...	See...
How to define a payment agreement request type	Defining a Payment Agreement Request Type on page 1967
How to edit a payment agreement request type	Editing a Payment Agreement Request Type on page 1970
How to copy a payment agreement request type	Copying a Payment Agreement Request Type on page 1973

Editing a Payment Agreement Request Type

Prerequisites

To edit a payment agreement request type, you should have:

- Payment agreement request business objects defined in the application
- The Payment Agreement Request Information algorithm is defined using the **C1-PA-INFO** algorithm type
- C1-PAREQ** To Do Type assigned to a To Do role whose users must receive To Do generated while submitting a payment agreement request for approval.

Procedure

To edit a payment agreement request type:

- Click the **Admin** link in the **Application** toolbar.

A list appears.

- From the **Admin** menu, select **P** and then click **Payment Agreement Request Type**.

A sub-menu appears.

- Click the **Search** option from the **Payment Agreement Request Type** sub-menu.

The **Payment Agreement Request Type** screen appears.

- In the **Payment Agreement Request Type List** zone, click the **Edit**  icon in the **Edit** column corresponding to the payment agreement request type whose details you want to edit.

The **Payment Agreement Request Type** screen appears. It contains the following sections:

- **Main** – Used to specify basic details about the payment agreement request type.
- **Characteristics** – Used to define the characteristics for the payment agreement request type.

The **Main** section contains the following fields:

Field Name	Field Description	Mandatory (Yes or No)
Payment Agreement Request Type	Displays the payment agreement request type.	Not applicable
Business Object	Indicates the payment agreement request type business object used while defining the payment agreement request type.	Not applicable
Description	Used to specify the description for the payment agreement request type.	Yes
Upload Request Business Object	Used to specify the business object that you want to use while creating the payment agreement request.	Yes
Detailed Description	Used to specify additional information about the payment agreement request type.	No
Status	Used to indicate the status of the payment request type. The valid values are: <ul style="list-style-type: none"> • Active • Inactive 	Yes
Status Change Notification Type	Used to indicate the notification type on the status change of payment agreement request type. The valid values are: <ul style="list-style-type: none"> • Alert • To Do • Both 	No
Approval Required	Used to indicate whether approval is required for editing payment agreement request using the payment agreement request type.	Yes
Approval To Do Type	Used to indicate that To Do of the specified To Do type must be created when you submit the payment agreement request for approval.	Yes (Conditional)
		Note: This field is required when the Approval Required check box is selected.

Field Name	Field Description	Mandatory (Yes or No)
	Note: The Search (🔍) icon appears corresponding to this field. On clicking the Search icon, the To Do Type Search window appears.	
Approval To Do Role	Used to indicate that users with the specified To Do role can only approve the upload request submitted for approval. Note: This field appears when the Approval Required check box is selected.	Yes (Conditional) Note: This field is required when the Approval Required check box is selected.
Submitter To Do Type	Used to indicate the To Do type for the submitter when the payment agreement request is resubmitted by the approver. Note: This field appears when the Approval Required check box is selected. The Search (🔍) icon appears corresponding to this field. On clicking the Search icon, the To Do Type Search window appears	Yes (Conditional) Note: This field is required when the Approval Required check box is selected.
Submitter To Do Role	Used to indicate the To Do role for the submitter when the payment agreement request is resubmitted by the approver. Note: This field appears when the Approval Required check box is selected.	Yes (Conditional) Note: This field is required when the Approval Required check box is selected.

Tip: Alternatively, you can click the **Edit** button in the **Payment Agreement Request Type** zone to edit the details of the payment agreement request type.

5. Modify the required details.

Note: You can search for a **Approval To Do Type** and **Submitter To Do Type** by clicking the **Search** (🔍) icon corresponding to the respective field.

6. Define, edit, or remove characteristics of the payment agreement request type, if required.

7. Click **Save**.

The changes made to the payment agreement request type are saved.

Related Topics

For more information on...	See...
Payment Agreement Request Type screen	Payment Agreement Request Type on page 1963
Payment Agreement Request Type List zone	Payment Agreement Request Type List on page 1963
Payment Agreement Request Type zone	Payment Agreement Request Type on page 1964
How to define a characteristic for a payment agreement request type	Defining a Characteristic for a Payment Agreement Request Type on page 1969

Copying a Payment Agreement Request Type

Instead of creating a payment agreement request type from scratch, you can create a new payment agreement request type using an existing payment agreement request type. This is possible through copying a payment agreement request type. On copying a payment agreement request type, the details including the characteristics are copied to the new payment agreement request type. You can then edit the details, if required.

Prerequisites

To copy a payment agreement request type, you should have:

- Payment agreement request type (whose copy you want to create) defined in the application
- Payment agreement request business objects defined in the application
- The Payment Agreement Request Information algorithm is defined using the **C1-PA-INFO** algorithm type
- **C1-PAREQ** To Do Type assigned to a To Do role whose users must receive To Do generated while submitting a payment agreement request for approval

Procedure

To copy a payment agreement request type:

1. Click the **Admin** link in the **Application** toolbar.

A list appears.

2. From the **Admin** menu, select **P** and then click **Payment Agreement Request Type**.

A sub-menu appears.

3. Click the **Search** option from the **Payment Agreement Request Type** sub-menu.

The **Payment Agreement Request Type** screen appears.

4. In the **Payment Agreement Request Type List** zone, click the **Duplicate**  icon in the **Duplicate** column corresponding to the payment agreement request type whose copy you want to create.

The **Payment Agreement Request Type** screen appears. It contains the following sections:

- **Main** – Used to specify basic details about the payment agreement request type.
- **Characteristics** – Used to define the characteristics for the payment agreement request type.

The **Main** section contains the following fields:

Field Name	Field Description	Mandatory (Yes or No)
Payment Agreement Request Type	Used to specify the payment agreement request type.	Yes
Business Object	Indicates the payment agreement request type business object used while defining the payment agreement request type (whose copy you want to create).	Not applicable
Description	Used to specify the description for the payment agreement request type.	Yes
Payment Agreement Request Business Object	Used to specify the business object that you want to use while creating the payment agreement request.	Yes
Detailed Description	Used to specify additional information about the payment agreement request type.	No

Field Name	Field Description	Mandatory (Yes or No)
Status	Used to indicate the status of the payment agreement request type. The valid values are: <ul style="list-style-type: none"> Active Inactive 	Yes
Status Change Notification Type	Used to indicate the notification type on the status change of payment agreement request type. The valid values are: <ul style="list-style-type: none"> Alert To Do Both 	No
Approval Required	Used to indicate whether approval is required while creating payment agreement request using the payment agreement request type.	Yes
Approval To Do Type	Used to indicate that To Do of the specified To Do type must be created when you submit the payment agreement request for approval.	Yes (Conditional)
	<p>Note: This field appears when the Approval Required check box is selected.</p> <p>The Search (🔍) icon appears corresponding to this field. On clicking the Search icon, the To Do Type Search window appears.</p>	<p>Note: This field is required when the Approval Required check box is selected.</p>
Approval To Do Role	Used to indicate that users with the specified To Do role can only approve the payment agreement request submitted for approval.	Yes (Conditional)
	<p>Note: This field appears when the Approval Required check box is selected.</p>	<p>Note: This field is required when the Approval Required check box is selected.</p>
Submitter To Do Type	Used to indicate the To Do type for the submitter when the payment agreement request is resubmitted by the approver.	Yes (Conditional)
	<p>Note: This field appears when the Approval Required check box is selected.</p> <p>The Search (🔍) icon appears corresponding to this field. On clicking the Search icon, the To Do Type Search window appears.</p>	<p>Note: This field is required when the Approval Required check box is selected.</p>
Submitter To Do Role	Used to indicate the To Do role for the submitter when the payment agreement request is resubmitted by the approver.	Yes (Conditional)
	<p>Note: This field appears when the Approval Required check box is selected.</p>	<p>Note: This field is required when the Approval Required check box is selected.</p>

Tip: Alternatively, you can click the **Duplicate** button in the **Payment Agreement Request Type** zone to create a copy of the payment agreement request type.

5. Enter the required details.
6. Define, edit, or remove characteristics of the payment agreement request type, if required.
7. Click **Save**.

The new payment agreement request type is defined.

Related Topics

For more information on...	See...
Payment Agreement Request Type screen	Payment Agreement Request Type on page 1963
Payment Agreement Request Type List zone	Payment Agreement Request Type List on page 1963
Payment Agreement Request Type zone	Payment Agreement Request Type on page 1964
How to define a characteristic for a payment agreement request type	Defining a Characteristic for a Payment Agreement Request Type on page 1969

Deleting a Payment Agreement Request Type

Procedure

To delete a payment agreement request type:

1. Click the **Admin** link in the **Application** toolbar.
A list appears.
2. From the **Admin** menu, select **P** and then click **Payment Agreement Request Type**.
A sub-menu appears.
3. Click the **Search** option from the **Payment Agreement Request Type** sub-menu.
The **Payment Agreement Request Type** screen appears.
4. In the **Payment Agreement Request Type List** zone, click the **Delete** (🗑️) icon in the **Delete** column corresponding to the payment agreement request type that you want to delete.
A message appears confirming whether you want to delete the payment agreement request type.

Note: You can delete a payment agreement request type when you have not created a payment agreement request using the payment agreement request type.

Tip: Alternatively, you can click the **Delete** button in the **Payment Agreement Request Type** zone to delete the payment agreement request type.

5. Click **OK**.
The payment agreement request type is deleted.

Related Topics

For more information on...	See...
Payment Agreement Request Type screen	Payment Agreement Request Type on page 1963
Payment Agreement Request Type List zone	Payment Agreement Request Type List on page 1963

For more information on...	See...
Payment Agreement Request Type zone	Payment Agreement Request Type on page 1964

Viewing the Payment Agreement Request Type Details

Procedure

To view the details of a payment agreement request type:

1. Click the **Admin** link in the **Application** toolbar.
A list appears.
2. From the **Admin** menu, select **P** and then click **Payment Agreement Request Type**.
A sub-menu appears.
3. Click the **Search** option from the **Payment Agreement Request Type** sub-menu.
The **Payment Agreement Request Type** screen appears.
4. In the **Payment Agreement Request Type List** zone, click the **Broadcast** () icon corresponding to the payment agreement request type whose details you want to view.
The **Payment Agreement Request Type** zone appears.
5. View the details of the payment agreement request type in the **Payment Agreement Request Type** zone.

Related Topics

For more information on...	See...
Payment Agreement Request Type screen	Payment Agreement Request Type on page 1963
Payment Agreement Request Type List zone	Payment Agreement Request Type List on page 1963
Payment Agreement Request Type zone	Payment Agreement Request Type on page 1964

Payment Agreement Request (Used for Searching)

The **Payment Agreement Request** screen allows you to search for a payment agreements for unpaid bills by searching through Bill ID or through Payment Agreement Request ID. Through this screen, you can navigate to the following screens:

- [Payment Agreement Request \(Used for Viewing\)](#) on page 1985

This screen consists of the following zones:

- [Search Payment Agreement Request](#) on page 1976
- [Bill Details](#) on page 1980

Search Payment Agreement Request

The **Search Payment Agreement Request** zone allows you to search for a payment agreement request using various search criteria. This zone contains the following two sections:

- **Search Criteria** – The **Search Criteria** section contains the following fields:

Field Name	Field Description	Mandatory (Yes or No)
Search By	Used to indicate whether you want to search for a payment agreement request using request or bill details. The valid values are: <ul style="list-style-type: none"> Request Details Bill Details 	Yes
	Note: By default, the Request Details option is selected.	
Payment Agreement Request ID	Used to search a particular payment agreement request.	No
	Note: This field appears when you select the Request Details option from the Search By list.	
Created From	Used to search payment agreement requests which are created from a particular date onwards.	No
	Note: This field appears when you select the Request Details option from the Search By list.	
To	Used to search payment agreement requests which are created till a particular date.	No
	Note: This field appears when you select the Request Details option from the Search By list.	
Payment Agreement Request Type	Used to search payment agreement requests which are created using a particular payment agreement request type.	No
	Note: This field appears when you select the Request Details option from the Search By list.	
Status	Used to search payment agreement requests with a particular status. The valid values are: <ul style="list-style-type: none"> Active Approval In Progress Broken Promise Draft Kept Promise Rejected Return to Submitter 	No
	Note: This field appears when you select the Request Details option from the Search By list.	
Account ID	Used to search for unpaid bills of a particular account.	No

Field Name	Field Description	Mandatory (Yes or No)
	<p>Note:</p> <p>This field appears when you select the Request Details option from the Search By list.</p> <p>You can search for a account ID by clicking the Search (🔍) icon corresponding to the field.</p>	
Person ID	<p>Used to search the person ID based on which you want to search for bills of a person.</p> <p>Note:</p> <p>This field appears when you select the Request Details option from the Search By list.</p> <p>You can search for a person ID by clicking the Search (🔍) icon corresponding to the field.</p>	No
Bill ID	<p>Used to search a particular bill.</p> <p>Note:</p> <p>This field appears when you select the Bill Details option from the Search By list.</p> <p>You can search for a bill by clicking the Search (🔍) icon corresponding to the field.</p>	No
Bill Date From	<p>Used to search bills which are created from a particular date onwards.</p> <p>Note: This field appears when you select the Bill Details option from the Search By list.</p>	No
To	<p>Used to search bills which are created till a particular date.</p> <p>Note: This field appears when you select the Bill Details option from the Search By list.</p>	No
Alternate Bill ID	<p>Used to search a particular bill using the alternate bill ID.</p> <p>Note: This field appears when you select the Bill Details option from the Search By list.</p>	No

Note: You must specify at least one search criterion while searching for a payment agreement request.

- **Search Results** – On clicking the **Search** button, the search results appear based on the specified search criteria. The **Search Results** section contains the following columns:

Column Name	Column Description
Create Date/Time	Displays the date and time when the payment agreement request was created in the system.
Payment Agreement Request Information	Displays information about the payment agreement request.
	Note: It has a link. On clicking the link, the Payment Agreement Request screen appears where you can view the details of the respective payment agreement request.
Schedule Amount	Displays the amount that the customer has agreed to pay on the scheduled date.
Status	Indicates the status of the payment agreement request. The valid values are: <ul style="list-style-type: none"> • Active • Approval In Progress • Broken Promise • Draft • Kept Promise • Rejected • Return to Submitter
Last Updated Date/Time	Displays the most recent updated date and time of the payment agreement request.
Total Unpaid Amount	Displays the total unpaid amount for debit bills.
	Note: Total Unpaid Amount should be equal to total Schedule Amount .
Person Information	Displays information about the person. In addition, this column has a context menu which helps in navigating to other screens in the application.
	Note: It has a link. On clicking the link, the Person screen appears where you can view the details of the respective person.
Account Information	Displays information about the account. In addition, this column has a context menu which helps in navigating to other screens in the application.
	Note: It has a link. On clicking the link, the Account screen appears where you can view the details of the respective account.

Note: Pagination is used to display limited number of records in the **Search Results** section. You can use the navigation links, such as **Previous** and **Next** to navigate between pages.

Related Topics

For more information on...	See...
How to search for a payment agreement request	Searching for a Payment Agreement Request on page 1980
How to create a payment agreement request	Creating a Payment Agreement Request on page 1981
How to view the details of a payment agreement request	Viewing the Payment Agreement Request Details on page 1984

Bill Details

The **Bill Details** zone lists unpaid debt bill details. You will not find any records in this zone if the payment agreement request list does not have any unpaid bills assigned to it. This zone contains the following columns:

Column Name	Column Description
Bill Information	Indicates the bill against which the payment agreement request is created. In addition, this column has a context menu which helps in navigating to other screens in the application. Note: It has a link. On clicking the link, the Bill screen appears with the details of the respective bill.
Original Bill Amount	Displays the bill amount when the bill was generated.
Current Bill Balance	Displays the outstanding amount.
Due Date	Displays the due date of the bill.

By default, the **Bill Details** zone does not appear in the **Payment Agreement Request** screen. It appears when you click the **Broadcast** (📡) icon corresponding to the payment agreement request in the **Search Payment Agreement Request** zone.

You can change the layout of this zone. For more information on how to change the layout, see [Changing the Layout](#) on page 4300.

Related Topics

For more information on...	See...
How to view bills added in the payment agreement request	Viewing the Bills Added in the Payment Agreement Request on page 1984

Searching for a Payment Agreement Request

Prerequisites

To search for a payment agreement request, you should have:

- Payment agreement request types defined in the application

Procedure

To search for a payment agreement request:

1. Click the **Menu** link in the **Application** toolbar.
A list appears.
2. From the **Main** menu, select **Delinquency Management** and then click **Payment Agreement Request**.
A sub-menu appears.
3. Click the **Search** option from the **Payment Agreement Request** sub-menu.
The **Payment Agreement Request** screen appears.
4. Enter the search criteria in the **Search Payment Agreement Request** zone.

Note: ORMB search engine supports wildcard search, where you can substitute the percentage (%) symbol as a stand in for any word or letter in a search criteria. You can use the ‘%’ wildcard character in all input fields except the date and ID fields. The ‘%’ wildcard character is suffixed automatically at the end of the partial search criteria. Therefore, you may or may not specify the wildcard character at the end of the partial search criteria. However, you have to prefix the wildcard character manually wherever required.

5. Click **Search**.

A list of payment agreement requests that meet the search criteria appears in the **Search Results** section.

Related Topics

For more information on...	See...
Payment Agreement Request screen	Payment Agreement Request (Used for Searching) on page 1976
Search Payment Agreement Request zone	Search Payment Agreement Request on page 1976

Creating a Payment Agreement Request

Prerequisites

To create a payment agreement request, you should have:

- Payment agreement request types defined in the application

Procedure

To create a payment agreement request:

1. Click the **Menu** link in the **Application** toolbar.
A list appears.
2. From the **Main** menu, select **Delinquency Management** and then click **Payment Agreement Request**.
A sub-menu appears.
3. Click the **Add** option from the **Payment Agreement Request** sub-menu.

The **Add Payment Agreement Request** screen appears. It contains the following fields:

Field Name	Field Description	Mandatory (Yes or No)
Payment Agreement Request Type	Used to indicate the payment agreement request type using which you want to create the payment agreement request.	Yes
Account ID	Used to search for unpaid bills of a particular account. The Search (🔍) icon appears corresponding to this field. On clicking the Search icon, the Account Search window appears.	Yes

Tip: Alternatively, you can access the **Add Payment Agreement Request** screen by clicking the **Add** button in the **Page Title** area of the **Payment Agreement Request** screen.

4. Select the required payment agreement request type and account ID from the respective fields.
5. Click **OK**.

The **Payment Request** screen appears.

Related Topics

For more information on...	See...
Search Payment Agreement Request zone	Search Payment Agreement Request on page 1976
Payment Agreement Request screen	Payment Agreement Request (Used for Searching) on page 1976

Defining a Characteristic for a Payment Agreement Request**Prerequisites**

To define a characteristic for a payment agreement request:

- Characteristic types defined in the application (where the characteristic entity is set to **Payment Agreement Request**)

Procedure

To define a characteristic for a Payment Agreement Request:

1. Ensure that the **Characteristics** section is expanded when you are editing, submitting, approving, rejecting or resubmitting a payment agreement.

The **Characteristics** section contains the following fields:

Field Name	Field Description	Mandatory (Yes or No)
Effective Date	Used to indicate the date from when the characteristic is effective for the payment agreement request.	Yes (Conditional) Note: This field is required when you are defining a characteristic for the payment agreement request.
Characteristic Type	Used to indicate the characteristic type. Note: The list includes only those characteristic types where the characteristic entity is set to Payment Agreement Request.	Yes (Conditional) Note: This field is required when you are defining a characteristic for the payment agreement request.
Characteristic Value	Used to specify the value for the characteristic type. Note: On specifying the value for a predefined characteristic type, the description of the characteristic value appears corresponding to the Characteristic Value field.	Yes (Conditional) Note: This field is required when you are defining a characteristic for the payment agreement request.

2. Enter the required details.

Note: If you select a predefined characteristic type, the **Search** (🔍) icon appears corresponding to the **Characteristic Value** field. On clicking the **Search** icon, you can search for a predefined characteristic value.

3. If you want to define more than one characteristic for the payment agreement request, click the **Add** (+) icon and then repeat step 2.

Note: However, if you want to remove a characteristic from the payment agreement request, click the **Delete** (🗑️) icon corresponding to the characteristic.

Related Topics

For more information on...	See...
How to create a payment agreement request	Creating a Payment Agreement Request on page 1981
How to edit a payment agreement request	Editing a Payment Agreement Request on page 1991

Defining Payment Schedule for a Payment Agreement Request

Prerequisites

To define payment schedule for a payment agreement request:

- Scheduled date, sum of installments for overdue or unpaid bills defined in the application for which the payment is scheduled is set to **Payment Agreement Request**

Procedure

To define payment schedule for a Payment Agreement Request:

- Ensure that the **Payment Schedule** section is expanded when you are editing, submitting, approving, rejecting or resubmitting a payment agreement.

The **Payment Schedule** section contains the following fields:

Field Name	Field Description	Mandatory (Yes or No)
Schedule Date	Used to indicate the date schedule for the payment.	Yes (Conditional)
		Note: This field is required when you are defining a payment schedule for the payment agreement request.
Schedule Amount	Used to indicate the amount scheduled for overdue or unpaid bills to be paid in installments.	Yes (Conditional)
	Note: This field appears when you select a Schedule Date for the payment schedule.	Note: This field is required when you select a Schedule Date for the payment schedule.
Auto Pay ID	Used to indicate the auto pay id of the payor.	No
	Note: This field appears when you select auto pay method option for Pay Method . The Search (🔍) icon appears corresponding to this field. On clicking the Search icon, the Auto Pay ID Search window appears.	

2. Enter the required details.

Note: If you select a auto pay method option for **Pay Method**, the **Search** (🔍) icon appears corresponding to the **Auto Pay ID** field. On clicking the **Search** icon, you can search for a **Payor Account ID**.

3. If you want to define more than one payment schedule for the payment agreement request, click the **Add** (+) icon and then repeat step 2.

Note: However, if you want to remove a payment schedule from the payment agreement request, click the **Delete** (🗑️) icon corresponding to the payment schedule.

Related Topics

For more information on...	See...
How to create a payment agreement request	Creating a Payment Agreement Request on page 1981
How to edit a payment agreement request	Editing a Payment Agreement Request on page 1991

Viewing the Bills Added in the Payment Agreement Request

Procedure

To view the bills added in the payment agreement request:

1. Search for the payment agreement request in the **Payment Agreement Request** screen.
2. In the **Search Results** section, click the **Broadcast** (📡) icon corresponding to the payment agreement request whose bill details you want to view.

The **Bill Details** zone appears.

Note: Bill are added in **Search Bills** zone on the **Bills** tab.

Related Topics

For more information on...	See...
How to create a payment agreement request	Creating a Payment Agreement Request on page 1981

Viewing the Payment Agreement Request Details

Procedure

To view the details of a payment agreement request:

1. Search for the payment agreement request in the **Payment Agreement Request** screen.
2. In the **Search Results** section, click the link in the **Payment Agreement Request Information** column corresponding to the payment agreement request whose details you want to view.

The **Payment Agreement Request** screen appears. It consists of the following tabs:

- **Main** – This tab contains the following three zones:
 - **Payment Agreement Request** – Displays the details of the payment agreement request.
 - **Bill Details** – Lists the unpaid bill details of the payment agreement request.
 - **Payment Schedule** – Lists the payment scheduled for unpaid bill amount of the payment agreement request.

- **Log** – This tab lists the complete trail of actions performed on the payment request.
3. View the details of the payment agreement request in the **Payment Agreement Request** zone.
 4. View the bill details of the unpaid amount bills of payment agreement request in the **Bill Details** zone.
 5. View the payment schedule details of payment agreement request in the **Payment Schedule** zone.

Related Topics

For more information on...	See...
How to search for a payment agreement request	Searching for a Payment Agreement Request on page 1980
Payment Agreement Request screen	Payment Agreement Request (Used for Viewing) on page 1985
Payment Agreement Request zone	Payment Agreement Request on page 1986
Bill Details zone	Bill Details on page 1988
Payment Schedule zone	Payment Schedule on page 1989

Payment Agreement Request (Used for Viewing)

Once you create a payment agreement request type, the **Payment Agreement Request** screen allows you to:

- Edit the details of a payment agreement request along with bill details and payment schedule
- Delete a payment agreement request
- View the details of a payment agreement request
- View the bills added in a payment agreement request
- Define a payment schedule in a payment agreement request
- Submit a payment agreement request for approval
- Approve or reject a payment agreement request
- Resubmit a payment agreement request
- Filter an overdue bills of an account
- Add an overdue bill in a payment agreement request
- View the log of a payment agreement request
- Add a log entry for a payment agreement request

This screen consists of the following tabs:

- **Main** – This tab contains the following three zones:
 - **Payment Agreement Request** – Displays the details of the payment agreement request.
 - **Bill Details** – Lists the bill details of the payment agreement request.
 - **Payment Schedule** – Lists the payment schedule details of the bills for the payment agreement request.
- **Bills** – This tab lists the unpaid bill amount details for the same account.

Note: This tab will be displayed when the payment agreement is in Draft status.

- **Log** – This tab lists the complete trail of actions performed on the payment agreement request.

Payment Agreement Request - Main

The **Main** tab on the **Payment Agreement Request** contains the following zones:

- [Payment Agreement Request](#) on page 1986
- [Bill Details](#) on page 1988
- [Payment Schedule](#) on page 1989

Payment Agreement Request

The **Payment Agreement Request** zone displays the details of the payment agreement request. This zone contains the following sections:

- **Main** – This section provides basic information about the payment agreement request. It contains the following fields:

Field Name	Field Description
Payment Agreement Request Information	Displays information about the payment agreement request.
Payment Agreement Request Type	Indicates the payment agreement request type using which the payment agreement request is created. Note: It has a link. On clicking the link, the Payment Agreement Request Type screen appears where you can view the details of the payment agreement request type.
Account Information	Displays information about the account for which the payment agreement request is created. In addition, a context menu appears corresponding to this field which helps in navigating to other screens in the application. Note: It has a link. On clicking the link, the Account screen appears where you can view the details of the respective account.
Status	Indicates the status of the payment agreement request. The valid values are: <ul style="list-style-type: none"> • Active • Draft • Approval In Progress • Broken Promise • Kept Promise • Rejected
Payor Account ID	Displays the payment agreement requests which are created for a particular payor account. In addition, a context menu appears corresponding to this field which helps in navigating to other screens in the application. Note: It has a link. On clicking the link, the Account screen appears where you can view the details of the respective account.
Pay Method	Displays the method of payment of amount.
Total Unpaid Amount	Displays the unpaid amount for selected bills.

Field Name	Field Description
Total Future Schedule Amount	Displays the total schedule amount.

- **Characteristics** – This section lists the characteristics of the payment of selected bills. It contains the following columns:

Column Name	Column Description
Effective Date	Displays the date from when the characteristic is effective for the payment agreement request.
Characteristic Type	Indicates the characteristic type.
Characteristic Value	Displays the value of the characteristic type.

- **Record Actions** – This section contains the following buttons:

Column Name	Column Description
Edit	Used to edit the details of the payment agreement request.
	Note: The Edit button appears when the payment agreement request is in the Active or Draft status.
Delete	Used to delete the payment agreement request.
	Note: The Delete button appears when the payment agreement request is in the Draft status.
Submit	Used to submit the payment agreement request for approval.
	Note: The Submit button appears when the payment agreement request is in the Draft status.
Approve	Used to approve the payment agreement request.
	Note: The Approve button appears when: <ul style="list-style-type: none"> • The payment agreement request is in the Approval In Progress status. • A user with the approval To Do role is reviewing the payment agreement request.
Reject	Used to reject the payment agreement request.
	Note: The Reject button appears when: <ul style="list-style-type: none"> • The payment agreement request is in the Approval In Progress status. • A user with the approval To Do role is reviewing the payment agreement request.
Resubmit	Used to change the status of the payment agreement request to Draft .

Column Name	Column Description
	<p>Note: The Resubmit button appears when:</p> <ul style="list-style-type: none"> The payment agreement request is in the Approval In Progress status. A user with the approval To Do role is reviewing the payment agreement request.

- **Record Information** – This section contains the following fields:

Field Name	Field Description
Business Object	<p>Indicates the business object using which the payment agreement request is created. In addition, a context menu appears corresponding to this field which helps in navigating to other screens in the application.</p> <p>Note: It has a link. On clicking the link, the Business Object screen appears where you can view the details of the respective business object.</p>
Status Date/Time	Displays the date and time when the payment agreement request status is updated.
Create Date/Time	Displays the date and time when the payment agreement request is created.

Bill Details

The **Bill Details** zone displays the bill details of the payment agreement request. This zone contains the following columns:

Column Name	Column Description
Bill Information	<p>Displays additional information about the bill. In addition, this column has a context menu which helps in navigating to other screens in the application.</p> <p>Note: It has a link. On clicking the link, the Bill screen appears with the details of the respective bill.</p>
Bill Amount	Displays the bill amount when the bill was generated.
Due Date	Displays the due date of the bill.
Unpaid Amount	Displays the amount which is eligible for payment against the bill.
Overdue Process Information	<p>Displays the overdue process information about the bill.</p> <p>Note: It has a link. On clicking the link, the Overdue Process screen appears with details of the overdue process of the bill.</p>

This zone contains the **Delete** button. This button appears when the payment agreement request is in the **Draft** status. It is used to delete bills of payment agreement request.

Note: One payment agreement request will have complete status debit bills of only one account. All bills under one payment agreement will be of same currency. Once payment agreement request is active, bills added under the request cannot be deleted.

Note: Pagination is used to display limited number of records in the **Search Results** section. You can use the navigation links, such as **Previous** and **Next** to navigate between pages.

Payment Schedule

The **Payment Schedule** zone displays the payments scheduled for the bills of the payment agreement request. This zone contains the following columns:

Column Name	Column Description
Schedule Date	Displays the schedule date for payment of bills amount in installments.
Schedule Amount	Displays the scheduled amount for bills payment in installments.
Auto Pay ID	Displays the automatic payment ID.

Note: Pagination is used to display limited number of records in the **Search Results** section. You can use the navigation links, such as **Previous** and **Next** to navigate between pages.

Payment Agreement Request - Bills

The **Bills** tab on the **Payment Agreement Request** contains the following zone:

- [Search Bills](#) on page 1989

Note: This tab is appears when the payment agreement request is in the **Draft** status.

Search Bills

The **Search Bills** zone allows you to search for all overdue bills for the account of a payment agreement request using various search criteria. This zone contains the following two sections:

- **Search Criteria** – The **Search Criteria** section contains the following fields:

Field Name	Field Description	Mandatory (Yes or No)
Search By	Used to indicate whether you want to search for a payment agreement request using bill details.	Yes
	Note: By default, the Bill Details option is selected.	
Bill ID	Used to search for a particular bill.	No
	Note: The Search (🔍) icon appears corresponding to this field. On clicking the Search icon, the Bill Search window appears.	
Bill Date From	Used to search bills which are created from a particular date onwards.	No
To	Used to search bills which are created till a particular date.	No

Note: You must specify at least one search criterion while searching for the bill details.

- **Search Results** – On clicking the **Search** button, the search results appear based on the specified search criteria. The **Search Results** section contains the following columns:

Column Name	Column Description
Bill ID	Displays the bill ID.

Column Name	Column Description
Bill Information	Displays additional information about the bill. In addition, this column has a context menu which helps in navigating to other screens in the application. Note: It has a link. On clicking the link, the Bill screen appears with the details of the respective bill.
Unpaid Amount	Displays the amount which is eligible for payment agreement request against the bill.
Overdue Process Information	Displays the overdue process information for the bill.

This zone contains the **Add** button. It is used to add bill details of payment agreement request.

Note: Pagination is used to display limited number of records in the **Search Results** section. You can use the navigation links, such as **Previous** and **Next** to navigate between pages.

Note: One payment agreement request will have complete status debit bills of only one account. All bills under one payment agreement will be of same currency. Bills which are part of another payment agreement request and which is not in completed status will not be available for selection.

Related Topics

For more information on...	See...
How to search for a payment agreement request	Searching for a Payment Agreement Request on page 1980
How to create a payment agreement request	Creating a Payment Agreement Request on page 1981
How to view the details of a payment agreement request	Viewing the Payment Agreement Request Details on page 1984

Payment Agreement Request - Log

The **Log** tab on the **Payment Agreement Request** screen contains the following zone:

- [Payment Agreement Request Log](#) on page 1990

Payment Agreement Request Log

The **Payment Agreement Request Log** zone on the **Payment Agreement Request** screen lists the complete trail of actions performed on the payment agreement request. This zone contains the following columns:

Column Name	Column Description
Date/Time	Displays the date and time when the action was performed on the payment agreement request.
Details	Displays the details about the action performed on the payment agreement request.
User	Indicates the user who has performed the action on the payment agreement request.
Log Type	Indicates the type of log.
Related Object	Indicates the object or entity which is generated when the action is performed on the payment agreement request.
Status Reason	Displays the status reason of action performed on the payment agreement request.

Column Name	Column Description
Old Payment Schedule	Displays the details of old payment schedule.

Note: You can manually add a log entry for the payment agreement request by clicking the **Add Log Entry** link in the upper right corner of the **Payment Agreement Request Log** zone.

The **Add Payment Agreement Request Log** window appears. Enter **Log Details** and click **Save**. The payment agreement request log is added.

Related Topics

For more information on...	See...
How to view the log of a payment agreement request	Viewing the Log of a Payment Agreement Request on page 2001
How to add the log for a payment agreement request	Adding a Log Entry for a Payment Agreement Request on page 2002

Editing a Payment Agreement Request

Procedure

To edit a payment agreement request:

1. Search for the payment agreement request in the **Payment Agreement Request** screen.
2. In the **Search Results** section, click the link in the **Payment Agreement Request Information** column corresponding to the payment agreement request whose details you want to edit.

The **Payment Agreement Request** screen appears.

3. Click the **Edit** button in the **Payment Agreement Request** zone.

Note: The **Edit** button appears only when the payment agreement request is in the **Active** or **Draft** status.

The **Payment Agreement Request** screen appears. It contains the following sections:

- **Main** – Used to specify basic details about the payment agreement request. This section contains the following fields:

Field Name	Field Description	Mandatory (Yes or No)
Payment Agreement Request Information	Displays information about the payment agreement request.	Not applicable
Payment Agreement Request Type	Indicates the payment agreement request type using which the payment agreement request is created.	Not applicable
Account Information	Used to indicate the account for which you want to create the payment agreement request.	Yes
Third Party Payor	Used to specify the third party payor. Note: The values appears for selection only if the third party payor check box is selected.	No
Payor Account ID	Displays the account ID of selected Third Party Payor .	Not applicable

Field Name	Field Description	Mandatory (Yes or No)
Pay Method	Used to indicate the payment method.	Yes
	Note: The valid values differ with respect to the description added for respective pay method in the Pay Method screen.	
Comments	Used to specify additional details about the payment agreement request.	No
Total Unpaid Amount	Displays the sum of unpaid amount of the bills.	Not applicable
Total Future Schedule Amount	Displays the sum of future schedule amount.	Not applicable

- **Bill Details** – Used to specify the bill details in the payment agreement request. This section contains the following column:

Column Name	Column Description	Mandatory (Yes or No)
Bill ID	Used to search a particular bill.	Yes
	Note: The Search (🔍) icon appears corresponding to the field. On clicking the Search icon, the Bill Search window appears. Bill details are displayed corresponding to the searched bill id.	

If you want to define more than one bill details for the payment agreement request, click the **Add** (+) icon.

Note: However, if you want to remove a bill detail from the payment agreement request, click the **Delete** (🗑️) icon corresponding to the bill ID.

- **Payment Schedule** – Used to specify the payment schedule details in the payment agreement request. This screen contains the following columns:

Column Name	Column Description	Mandatory (Yes or No)
Schedule Date	Used to specify the schedule date for payment of schedule amount in the form of installments.	Yes
Schedule Amount	Used to specify the schedule amount to be paid in terms of installments.	Yes
Auto Pay ID	Used to search for auto pay ID.	Yes (Conditional)
	Note: This field can be edited when the Pay Method is selected for electronic payment of schedule amount. The Search (🔍) icon appears corresponding to the field. Auto pay details are displayed corresponding to the searched auto pay id.	

If you want to define more than one payment schedules for the payment agreement request, click the **Add** (+) icon.

Note: However, if you want to remove a payment schedule from the payment agreement request, click the **Delete** (🗑️) icon corresponding to the schedule date.

- **Characteristics** – Used to define the characteristics for the payment tender. This section contains the following fields:

Field Name	Field Description	Mandatory (Yes or No)
Effective Date	Used to specify the date from when the characteristic is effective for the payment agreement request.	Yes (Conditional) Note: This field is required when you are defining a characteristic for the payment agreement request.
Characteristic Type	Used to indicate the characteristic type. Note: The list includes only those characteristic types where the characteristic entity is set to Payment Agreement Request .	Yes (Conditional) Note: This field is required when you are defining a characteristic for the payment agreement request.
Characteristic Value	Used to specify the value for the characteristic type. Note: On specifying the value for a predefined characteristic type, the description of the characteristic value appears corresponding to the Characteristic Value field.	Yes (Conditional) Note: This field is required when you are defining a characteristic for the payment agreement request.

4. Add or modify the details of the payment agreement request, if required.
5. Define, edit, or remove characteristics of the payment agreement request, if required.
6. Click **Save**.

The changes made to the payment agreement request are saved.

Note: Approval is not required for modifications done on an active payment agreement request.

Related Topics

For more information on...	See...
How to search for a payment agreement request	Searching for a Payment Agreement Request on page 1980
Payment Agreement Request screen	Payment Agreement Request (Used for Viewing) on page 1985
Payment Agreement Request zone	Payment Agreement Request on page 1986
How to define a characteristic for a payment agreement request	Defining a Characteristic for a Payment Agreement Request on page 1982

Deleting a Payment Agreement Request

Procedure

To delete a payment agreement request:

1. Search for the payment agreement request in the **Payment Agreement Request** screen.
2. In the **Search Results** section, click the link in the **Payment Agreement Request Information** column corresponding to the payment request that you want to delete.

The **Payment Agreement Request** screen appears.

3. Click the **Delete** button in the **Payment Agreement Request** zone.

A message appears confirming whether you want to delete the payment agreement request.

Note: The Delete button appears when the payment agreement request is in the Draft status.

4. Click **OK**.

The payment agreement request is deleted.

Related Topics

For more information on...	See...
How to search for a payment agreement request	Searching for a Payment Agreement Request on page 1980
Payment Agreement Request screen	Payment Agreement Request (Used for Viewing) on page 1985
Payment Agreement Request zone	Payment Agreement Request on page 1986
Bill Details zone	Bill Details on page 1988
Payment Schedule zone	Payment Schedule on page 1989

Submitting a Payment Agreement Request**Prerequisites**

To submit a payment agreement request, you should have:

- Payment Agreement Request Types defined in the request.

Procedure

To submit a payment agreement request:

1. Search for the payment agreement request in the **Payment Agreement Request** screen.
2. In the **Search Results** section, click the link in the **Payment Agreement Request Information** column corresponding to the payment agreement request that you want to submit.

The **Payment Agreement Request** screen appears.

3. Click the **Submit** button in the **Payment Agreement Request** zone.

The system behaves in the following manner:

If...	Then
The Approval Required check box is selected in the payment agreement request type using which the payment agreement request is created.	A To Do of the To Do Type is created for the payment agreement request entity and sent to the approver. Status of the payment agreement request is changed to Approval In Progress . C1-PAREQ is the to do type for Payment Agreement Request.

If...	Then
The Approval Required check box is not selected in the payment agreement request type using which the payment agreement request is created.	The payment agreement request is created using the specified payment agreement request types and the status of the payment agreement request is changed to as specified in the payment agreement request type.

Note:

The **Submit** button appears when the payment agreement request is in the **Draft** status.

For more information about the **Payment Agreement Request Periodic Monitor (C1-PAREQ)** batch, refer to Oracle Revenue Management and Billing Batch Guide.

Related Topics

For more information on...	See...
How to search for a payment agreement request	Searching for a Payment Agreement Request on page 1980
Payment Agreement Request screen	Payment Agreement Request (Used for Viewing) on page 1985
Payment Agreement Request zone	Payment Agreement Request on page 1986

Removing an Overdue Bill from a Payment Agreement Request**Prerequisites**

To remove an overdue bill from a payment agreement request, you should have:

- Bill details should be available to be removed from payment agreement request

Procedure

To delete a bill detail from payment agreement request:

1. Search for the payment agreement request in the **Payment Agreement Request** screen which is in **Draft** status.
2. In the **Search Results** section, click the link in the **Payment Agreement Request Information** column corresponding to the payment agreement request whose details you want to view.

By default, the **Main** tab of the **Payment Agreement Request** screen appears.

3. List of bill details are displayed in the **Bill Details** zone.
4. Select the check box corresponding to the bill which you want to delete from the payment agreement request.

You can delete more than one bill from the payment agreement request at the same time.

5. Click **Delete**.

A message appears indicating that selected bills have been successfully deleted from the payment agreement request.

6. Click **OK**.

Note that the bill is added in the **Search Bills** zone in the **Bills** tab.

Note: Bills in **Active** status cannot be deleted.

Related Topics

For more information on...	See...
How to search for a payment agreement request	Searching for a Payment Agreement Request on page 1980

For more information on...	See...
How to create a payment agreement request	Creating a Payment Agreement Request on page 1981
Bill Details zone	Bill Details on page 1988
Search Bills zone	Search Bills on page 1989

Approving a Payment Agreement Request

You can view the number of payment agreement requests which are pending for approval in the **Payment Agreement Request** screen. The approver can review, and accordingly approve or reject the payment agreement request based on the observations.

Note: The system will not allow you to approve or reject a payment agreement request submitted by you.

Procedure

To approve a payment agreement request:

1. Do either of the following:

If you want to	Then
Approve a payment agreement request through the Payment Agreement Request screen	<ol style="list-style-type: none"> 1. Search for the payment agreement request in the Payment Agreement Request screen. 2. In the Search Results section, click the link in the Payment Agreement Request Information column corresponding to the payment agreement request which you want to review.
Approve a payment agreement request from the To Do List screen	<ol style="list-style-type: none"> 1. Click the Menu link in the Application toolbar. A list appears. 2. From the Main menu, select To Do and then click To Do List. The To Do Type for User Search window appears. 3. Enter the to do type C1-PAREQ in the To Do Type field for the entity payment agreement request. 4. Click the Search button corresponding to the To Do Type field. The To Do List screen appears. 5. Select the Open option from the Filter by list to view all unassigned To Dos. 6. Click the link in the Message column corresponding to the To Do of the payment agreement request that you want to review.

The **Payment Agreement Request** screen appears.

2. Review the payment agreement request details.
3. Click the **Approve** button in the **Payment Agreement Request** zone.

The system behaves in the following manner:

If you are...	Then
Approving a payment agreement request	The status of the payment agreement request is changed to Approval In Progress as specified in the payment agreement request type.

Note: The **Approve** button appears when:

- The payment agreement request is in the **Approval In Progress** status.
- A user with the approval To Do role is reviewing the payment agreement request.

Related Topics

For more information on...	See...
Payment Agreement Request screen	Payment Agreement Request (Used for Viewing) on page 1985
Payment Agreement Request zone	Payment Agreement Request on page 1986
How to search for a payment agreement request	Searching for a Payment Agreement Request on page 1980

Rejecting a Payment Agreement Request

Prerequisites

To reject a payment agreement request, you should have:

- Rejection reasons defined in the application

Note:

While rejecting a payment agreement request, you need to specify the reason why you want to reject the payment agreement request. You can select the appropriate rejection reason when you have defined the reasons for the **Rejected** status of the **C1-PaymentAgreementRequest** business object in the **Status Reason** screen.

The system will not allow you to approve or reject a payment agreement request submitted by you.

Procedure

To reject a payment agreement request:

1. Do either of the following:

If you want to	Then
Reject a payment agreement request through the Payment Agreement Request screen	<ol style="list-style-type: none"> 1. Search for the payment agreement request in the Payment Agreement Request screen. 2. In the Search Results section, click the link in the Payment Agreement Request Information column corresponding to the payment request which you want to review.

If you want to	Then
Reject a payment agreement request from the To Do List screen	<ol style="list-style-type: none"> 1. Click the Menu link in the Application toolbar. A list appears. 2. From the Main menu, select To Do and then click To Do List. The To Do Type for User Search window appears. 3. Enter the to do type C1-PAREQ in the To Do Type field for the entity payment agreement request. 4. Click the Search button corresponding to the To Do Type field. The To Do List screen appears. 5. Select the Open option from the Filter by list to view all unassigned To Dos. 6. Click the link in the Message column corresponding to the To Do of the payment agreement request that you want to review.

The **Payment Agreement Request** screen appears.

2. Review the payment agreement request details.
3. Click the **Reject** button in the **Payment Agreement Request** zone.

The **Reject Payment Request** window appears. It contains following fields:

Field Name	Field Description	Mandatory (Yes or No)
Status Reason	Used to indicate the reason why you want to reject the payment agreement request.	Yes
Comments	Used to specify additional information while rejecting the payment agreement request.	No

Note: The **Reject** button appears when:

- The payment agreement request is in the **Approval In Progress** status.
- A user with the approval To Do role is reviewing the payment agreement request.

4. Select the rejection reason from the **Status Reason** list.
5. Click **Save**.

The status of the payment agreement request is changed to **Rejected**.

Related Topics

For more information on...	See...
How to search for a payment agreement request	Searching for a Payment Agreement Request on page 1980

For more information on...	See...
Payment Agreement Request screen	Payment Agreement Request (Used for Viewing) on page 1985
Payment Agreement Request zone	Payment Agreement Request on page 1986

Resubmitting a Payment Agreement Request

Prerequisites

To resubmit a payment agreement request, you should have:

- Entities added in the payment agreement request which is submitted for approval.

Procedure

To resubmit a payment agreement request:

1. Search for the payment agreement request in the **Payment Agreement Request** screen.
2. In the **Search Results** section, click the link in the **Payment Agreement Request Information** column corresponding to the payment agreement request that you want to resubmit.

The **Payment Agreement Request** screen appears.

3. Click the **Resubmit** button in the **Payment Agreement Request** zone.

The **Resubmit Payment Agreement Request** screen appears.

Note: The **Resubmit** button appears when the payment agreement request is in the **Approval In Progress** status.

A To Do of the **C1-PAREQ** To Do type is created and sent to the request submitter using the submitter TO DO Role and the status of the payment agreement request is changed to **Draft**.

4. Enter the comments in the respective field and click **Save**.

Note: While resubmitting, To Do will be sent to the submitter of the request using the submitter To Do Role mapped on the payment agreement request type and the request will be moved to Draft status. The submitter can do necessary changes and re submit the request. Log will be maintained when the approver sends the request back to submitter.

Related Topics

For more information on...	See...
How to search for a payment agreement request	Searching for a Payment Agreement Request on page 1980
Payment Agreement Request screen	Payment Agreement Request (Used for Viewing) on page 1985
Payment Agreement Request zone	Payment Agreement Request on page 1986
How to submit a payment agreement request	Submitting a Payment Agreement Request on page 1994

Filtering Overdue Bills of an Account

The **Search Bills** zone lists bills that are overdue for an account. You will not find any records in this zone if the payment agreement request does not have overdue bills in the account. This zone contains the following fields as search criteria:

Field Name	Field Description	Mandatory (Yes or No)
Search By	Used to indicate whether you want to search for a payment agreement request using bill details.	Yes
	Note: By default, the Bill Details option is selected.	

Field Name	Field Description	Mandatory (Yes or No)
Bill ID	Used to search for a particular bill.	No
	Note: The Search (🔍) icon appears corresponding to the field. On clicking the Search icon, the Bill Search window appears.	
Bill Date From	Used to search bills which are created from a particular date onwards.	No
To	Used to search bills which are created till a particular date.	No

By default, the **Search Bills** zone appears in the **Bills** tab of **Payment Agreement Request** screen. By default, the **Filter** area is visible. You can hide the **Filter** area by clicking the **Filters** (🔼) icon in the upper right corner of this zone.

By default, the search results section displays the following columns:

Column Name	Column Description
Bill ID	Displays the bill ID.
Bill Information	Displays additional information about the bill. In addition, this column has a context menu which helps in navigating to other screens in the application.
	Note: It has a link. On clicking the link, the Bill screen appears with the details of the respective bill.
Unpaid Amount	Displays the amount which is eligible for payment agreement request against the bill.
Overdue Process Information	Displays the overdue process information for the bill.

Related Topics

For more information on...	See...
Bills tab	Payment Agreement Request - Bills on page 1989
Bill Details zone	Bill Details on page 1988
How to add an overdue bill in a payment agreement request	Adding an Overdue Bill in a Payment Agreement Request on page 2000

Adding an Overdue Bill in a Payment Agreement Request

Prerequisites

To add an overdue bill in a payment agreement request, you should have:

- Overdue bills should be available for accounts to add in payment agreement request

Procedure

To add an overdue bill in a payment agreement request:

Note: A bill with outstanding amount greater than zero which is not part of an overdue process will be allowed to be added in a payment agreement request. While a bill with negative outstanding amount will not be allowed to be added in a payment agreement request.

1. Search for the payment agreement request in the **Payment Agreement Request** screen which is in **Draft** or **Active** status.
2. In the **Search Results** section, click the link in the **Payment Agreement Request Information** column corresponding to the payment agreement request whose details you want to view.
The **Payment Agreement Request** screen appears.
3. Click the **Bills** tab.
The **Bills** tab appears.
4. Enter the search criteria in the **Search Bills** zone.
In the **Search Results** section, list of bills meeting the search criteria are displayed.
5. Select the check box corresponding to the bill which you want to add to the payment agreement request from the **Search Results** section.
You can add more than one bill to the payment agreement request at the same time.
6. Click **Add**.
A message appears indicating that selected bills have been successfully added to the payment agreement request.
7. Click **OK**.
Note that the bill is added in the **Bill Details** zone in the **Main** tab.

Related Topics

For more information on...	See...
How to search for a payment agreement request	Searching for a Payment Agreement Request on page 1980
How to create a payment agreement request	Creating a Payment Agreement Request on page 1981
Search Bills zone	Search Bills on page 1989
Bill Details zone	Bill Details on page 1988

Viewing the Log of a Payment Agreement Request

Procedure

To view the log of a payment agreement request:

1. Search for the payment agreement request in the **Payment Agreement Request** screen.
2. In the **Search Results** section, click the link in the **Payment Agreement Request Information** column corresponding to the payment agreement request whose log you want to view.

The **Payment Agreement Request** screen appears. It consists of the following tabs:

- **Main** – This tab contains the following three zones:
 - **Payment Agreement Request** – Displays the details of the payment agreement request.
 - **Bill Details** – Lists the bill details of the payment agreement request.
 - **Payment Schedule** – Lists the payment schedule details of the bills for the payment agreement request.
- **Bills** – This tab lists the unpaid bill amount details for the same account.

Note: This tab will be displayed when the payment agreement is in **Draft** status.

- **Log** – This tab lists the complete trail of actions performed on the payment agreement request.

3. Click the **Log** tab.

The **Payment Agreement Request Log** zone in the **Log** tab contains the following columns:

Column Name	Column Description
Date/Time	Displays the date and time when the action was performed on the payment agreement request.
Details	Displays the details about the action performed on the payment agreement request.
User	Indicates the user who has performed the action on the payment agreement request.
Log Type	Indicates the type of log.
Related Object	Indicates the object or entity which is generated when the action is performed on the payment agreement request.
Status Reason	Indicates the reason why the payment agreement request was rejected.
Old Payment Schedule	Displays the details of old payment schedule.

Note: You can manually add a log entry for the payment agreement request by clicking the **Add Log Entry** link in the upper right corner of the **Payment Agreement Request Log** zone.

Related Topics

For more information on...	See...
How to search for a payment agreement request	Searching for a Payment Agreement Request on page 1980
How to add a log entry for a payment agreement request	Adding a Log Entry for a Payment Agreement Request on page 2002

Adding a Log Entry for a Payment Agreement Request

Procedure

To add a log entry for a payment agreement request:

1. Search for the payment agreement request in the **Payment Agreement Request** screen.
2. In the **Search Results** section, click the link in the **Payment Agreement Request Information** column corresponding to the payment agreement request whose log you want to edit.

The **Payment Agreement Request** screen appears. It consists of the following tabs:

- **Main** – This tab contains the following three zones:
 - **Payment Agreement Request** – Displays the details of the payment agreement request.
 - **Bill Details** – Lists the bill details of the payment agreement request.
 - **Payment Schedule** – Lists the payment schedule details of the bills for the payment agreement request.
- **Bills** – This tab lists the unpaid bill amount details for the same account.

Note: This tab will be displayed when the payment agreement is in **Draft** status.

- **Log** – This tab lists the complete trail of actions performed on the payment agreement request.

3. Click the **Log** tab.

The **Log** tab appears.

- Click the **Add Log Entry** link in the upper right corner of the **Payment Agreement Request Log** zone.

The **Add Payment Agreement Request Log** window appears. It contains the following fields:

Field Name	Field Description	Mandatory (Yes or No)
Payment Agreement Request Information	Displays information about the payment agreement request.	Not applicable
Log Details	Used to specify additional comments for the payment agreement request.	Yes

- Enter the comments in the **Log Details** field.
- Click **Save**.

The log entry is added in the **Payment Agreement Request Log** zone.

Related Topics

For more information on...	See...
How to search for a payment agreement request	Searching for a Payment Agreement Request on page 1980

Chapter 31

Dispute Request

Topics:

- [Dispute Request \(Without Approval\) Status Transition](#)
- [Dispute Request \(With Approval\) Status Transition](#)
- [Prerequisites](#)
- [Algorithms Used in C1-DisputeRequest](#)
- [Dispute Request Type](#)
- [Dispute Request \(Used for Searching\)](#)
- [Dispute Request \(Used for Viewing\)](#)

Oracle Revenue Management and Billing allows you to create a dispute request for an account. Through a dispute request, the dispute against a particular bill, bill segment, and/or adjustment is tracked and closed. While creating a dispute request, you need to specify the dispute request type using which you want to create the dispute request. It is the dispute request type which helps the system to determine:

- The business object using which the dispute request should be created
- Whether the dispute request must be approved before creating adjustments to settle a dispute against a bill, bill segment, or adjustment
- Approval profile using which the dispute request must be approved
- Whether multi-level or single-level approval is required for a dispute request
- Whether debit or credit hierarchy must be used for approval when the dispute request amount is zero
- Default adjustment type using which adjustments must be created

You can add completed bills, its bill segments, and adjustments in the dispute request. In other words, at present, the system enables you to resolve the dispute against a bill, bill segment, and adjustment. If the dispute is against a bill, the system, by default, sets the dispute amount and does not allow you to change the dispute amount. The dispute amount is set to the original bill amount because the original bill amount and dispute amount must be equal. However, if the original bill amount is positive, then the dispute amount is set to negative, and vice versa. If the dispute is against a bill segment or adjustment, you can change the dispute amount, if required.

Once a dispute request is created, the status of the dispute request is set to Draft. You can then edit or delete the dispute request, if required. Once you add the bills, bill segments, or adjustments in a dispute request, you can submit the dispute request. On submitting a dispute request, the system behaves in the following manner:

Dispute Against	Type of Bill	Stop Auto Pay (Yes or No)	Behavior
Bill	Fully Paid	Not applicable	The system does the following: <ol style="list-style-type: none">1. Creates the adjustment using the specified adjustment type for the bill.

Dispute Against	Type of Bill	Stop Auto Pay (Yes or No)	Behavior
			<ol style="list-style-type: none"> 2. Swaps the adjustment onto the next bill.
Bill	Unpaid	Yes	<p>The system does the following:</p> <ol style="list-style-type: none"> 1. Stops the automatic payment created for the current bill. 2. A characteristic is defined on the current bill indicating the date till when the bill should not be considered by the Overdue Monitor (C1-ADMOV) batch. <div data-bbox="1122 688 1471 804" style="border: 1px solid black; padding: 5px;"> <p>Note: The above step (2) occurs when the approval is required for the dispute request.</p> </div> <ol style="list-style-type: none"> 3. Reopens the current bill of the account. 4. Creates the adjustment using the specified adjustment type for the bill and swaps the adjustment onto the current bill. 5. Completes and freeze the current bill.
Bill	Unpaid	No	<p>The system does the following:</p> <ol style="list-style-type: none"> 1. Creates the adjustment using the specified adjustment type for the bill. 2. Swaps the adjustment onto the current or next bill depending on the value defined for the Adjustment on Next Bill parameter in an algorithm created using the C1-ENTERADJ algorithm type.
Bill	Partially Paid	Not applicable	<p>The system does the following:</p> <ol style="list-style-type: none"> 1. Creates two adjustments using the specified adjustment type for the bill. 2. Swaps one adjustment onto the current bill and another adjustment onto the next bill.

Dispute Against	Type of Bill	Stop Auto Pay (Yes or No)	Behavior
			<p>Example: A dispute is raised against a bill (Bill Amount – 100, Dispute Amount – 100, and Unpaid Amount - 50), then one adjustment (with the adjustment amount 50) is swap on the current bill and another adjustment (with the adjustment amount 50) is swap on the next bill.</p>
Bill Segment	Fully Paid	Not applicable	<p>The system does the following:</p> <ol style="list-style-type: none"> 1. Creates the adjustment using the specified adjustment type for the bill segment. 2. Swaps the adjustment onto the next bill.
Bill Segment	Unpaid	Yes	<p>The system does the following:</p> <ol style="list-style-type: none"> 1. Stops the automatic payment created for the current bill. 2. A characteristic is defined on the current bill indicating the date till when the bill should not be considered by the Overdue Monitor (C1-ADMOV) batch. <div style="border: 1px solid black; padding: 5px; margin: 10px 0;"> <p>Note: The above step (2) occurs when the approval is required for the dispute request.</p> </div> <ol style="list-style-type: none"> 3. Reopens the current bill of the account. 4. Creates the adjustment using the specified adjustment type for the bill segment and swaps the adjustment onto the current bill. 5. Completes and freeze the current bill.
Bill Segment	Unpaid	No	<p>The system does the following:</p> <ol style="list-style-type: none"> 1. Creates the adjustment using the specified adjustment type for the bill segment. 2. Swaps the adjustment onto the current or next bill depending on the value

Dispute Against	Type of Bill	Stop Auto Pay (Yes or No)	Behavior
			defined for the Adjustment on Next Bill parameter in an algorithm created using the C1-ENTERADJ algorithm type.
Bill Segment	Partially Paid	Not applicable	<p>The system does the following:</p> <ol style="list-style-type: none"> 1. Creates two adjustments using the specified adjustment type for the bill segment. 2. Swaps one adjustment onto the current bill and another adjustment onto the next bill. <p>Example: A dispute is raised against a bill segment (Bill Segment Amount – 100, Dispute Amount – 100, and Unpaid Bill Segment Amount - 50), then one adjustment (with the adjustment amount 50) is swap on the current bill and another adjustment (with the adjustment amount 50) is swap on the next bill.</p>
Adjustment	Fully Paid	Not applicable	<p>The system does the following:</p> <ol style="list-style-type: none"> 1. Creates the adjustment using the specified adjustment type for the adjustment (against which you have raised a dispute). 2. Swaps the adjustment onto the next bill.
Adjustment	Unpaid	Yes	<p>The system does the following:</p> <ol style="list-style-type: none"> 1. Stops the automatic payment created for the current bill. 2. A characteristic is defined on the current bill indicating the date till when the bill should not be considered by the Overdue Monitor (C1-ADMOV) batch. <div style="border: 1px solid black; padding: 5px; margin: 10px 0;"> <p>Note: The above step (2) occurs when the approval is required for the dispute request.</p> </div> <ol style="list-style-type: none"> 3. Reopens the current bill of the account.

Dispute Against	Type of Bill	Stop Auto Pay (Yes or No)	Behavior
			<ol style="list-style-type: none"> 4. Creates the adjustment using the specified adjustment type for the adjustment (against which you have raised a dispute) and swaps the adjustment onto the current bill. 5. Completes and freeze the current bill.
Adjustment	Unpaid	No	<p>The system does the following:</p> <ol style="list-style-type: none"> 1. Creates the adjustment using the specified adjustment type for the adjustment (against which you have raised a dispute). 2. Swaps the adjustment onto the current or next bill depending on the value defined for the Adjustment on Next Bill parameter in an algorithm created using the C1-ENTERADJ algorithm type.
Adjustment	Partially Paid	Not applicable	<p>The system does the following:</p> <ol style="list-style-type: none"> 1. Creates two adjustments using the specified adjustment type for the adjustment (against which you have raised a dispute). 2. Swaps one adjustment onto the current bill and another adjustment onto the next bill. <p>Example: A dispute is raised against an adjustment (Adjustment Amount – 100, Dispute Amount – 100, and Unpaid Adjustment Amount - 50), then one adjustment (with the adjustment amount 50) is swap on the current bill and another adjustment (with the adjustment amount 50) is swap on the next bill.</p>

Finally, the status of the dispute request is changed to **Processed**. You can optionally configure the system to use the approval workflow process for a dispute request. If the **Approval Required** flag is set to **Yes** in a dispute request type, then on submitting the respective dispute request, the approval workflow process creates a To Do for the approver to review the dispute request. Once the

approver approves the dispute request, the system behaves as mentioned in the above table. The approver can approve, reject, or resubmit the dispute request. When the dispute request is resubmitted to the submitter, the submitter can edit, cancel, or submit the dispute request.

The approval process is configured through the approval profile. The approval profile allows you to define the debit and credit hierarchy. If the dispute request amount is negative, the credit hierarchy in the approval profile is used for approval. However, if the dispute request amount is positive, the debit hierarchy in the approval profile is used for approval. You can either opt to use single-level or multi-level approval for the dispute requests.

During the dispute request process, a dispute request creation goes through various statuses in its lifecycle. For more information about the dispute request statuses, see [Dispute Request \(Without Approval\) Status Transition](#) on page 2011 and [Dispute Request \(With Approval\) Status Transition](#) on page 2011.

Note: The lifecycle of a dispute request creation is driven by the respective business object using which the request is created. The dispute request feature explained in this document is articulated based on the lifecycle and logic defined in the business objects.

For more information on how to setup the dispute request process, see [Prerequisites](#) on page 2012.

Dispute Request (Without Approval) Status Transition

The following figure graphically indicates how a dispute request moves from one status to another when approval workflow is off:

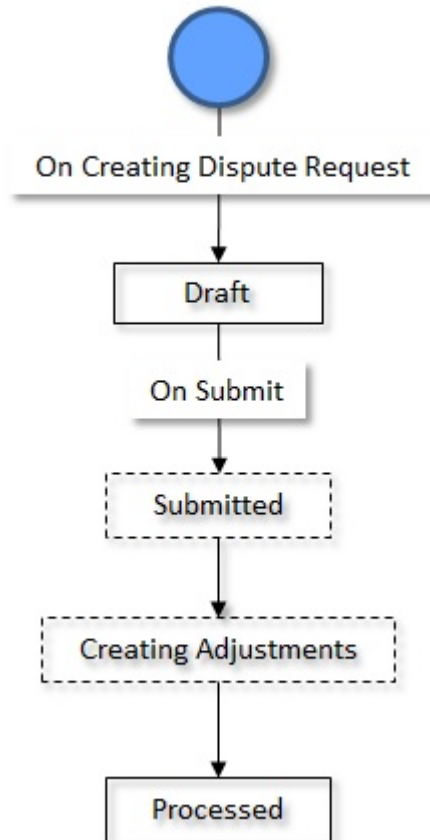

Dispute Request (With Approval) Status Transition

The following figure graphically indicates how a dispute request moves from one status to another when approval workflow is on:

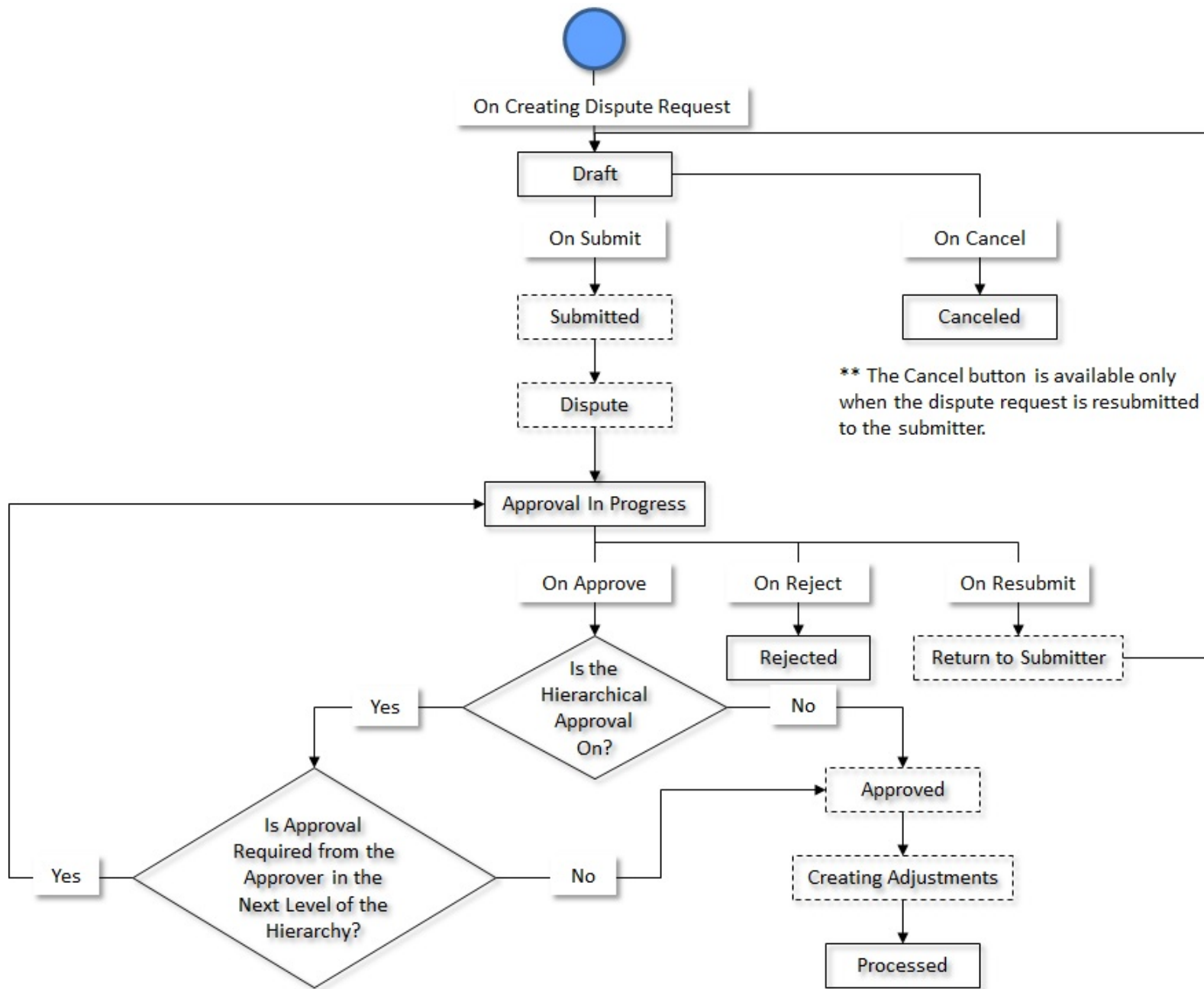

Prerequisites

To setup the dispute request process, you need to do the following:

- Define the required refund request types in the system
- Define the required adjustment types (for creating dispute adjustments) where A/P request type is defined
- Define the required characteristic types where the characteristic entity is set to **Dispute Request Type**
- Define the required characteristic types where the characteristic entity is set to **Dispute Request**
- Define rejected status reasons for the **C1-DisputeRequest** business object

- Assign the **C1-DSPSB** To Do type to a To Do role whose users must receive To Do generated while submitting a dispute request for approval
- Define the required approval profiles with the credit/debit hierarchy and **C1_DISAP** To Do type
- Create an algorithm using the **C1-DSPTRQINF** algorithm type if you want to create Dispute Requests using the dispute request information.
- Define an algorithm of the **C1-ADI-INFO** algorithm type and attach to the **Adjustment Information** system event in the **Algorithms** tab of the **Installation Options – Framework** screen

Algorithms Used in C1-DisputeRequest

The following table lists the algorithms which are attached to the **C1-DisputeRequest** business object:

System Event	Algorithm	Algorithm Type	Description
Information	C1-DSPTRQINF	C1-DSPTRQINF	This algorithm generates the dispute request information string which appears throughout the application. It concatenates the following fields: <ul style="list-style-type: none"> • Dispute Request Type Description • Dispute Request Status Description • Dispute Request ID
Validation	C1-DSPTVADN	C1-DSPTVADN	This algorithm validates following: Draft status validations: <ul style="list-style-type: none"> • At-least one entity should be selected to submit a dispute. Dispute Request with at-least one Bill or Bill Line Item should be added for submission • Dispute amount cannot be zero or null • If a bill is already present in dispute request and request is not in final status then user should not be allowed to add same bill in another dispute request • Disputed Amount should be equal to bill outstanding amount if bill Line item contain multiple contracts

The following table lists the algorithms which are used in the lifecycle of the **C1-DisputeRequest** business object:

Status	System Event	Algorithm	Algorithm Type	Description
Submitted	Enter	C1-DISPUTSUB	C1-DISPUTSUB	This algorithm checks the following: <ul style="list-style-type: none"> • Whether the approval is required for the dispute request. If the approval is required for a dispute request, the status of the dispute request is changed to Approval In Progress. However, if the approval is not required for a dispute request, the status of the dispute request is changed to Creating Adjustment.

Status	System Event	Algorithm	Algorithm Type	Description
				<ul style="list-style-type: none"> At least one entity, such as payment event, payment, or credit bill line item (such as credit bill segment or adjustment) is selected in the dispute request. Whether the approval profile attached to the Dispute Request Type has the credit hierarchy and To Do Type defined.
Submitted	Enter	C1-DPTSTAUPY	C1-DPTSTAUPY	<p>This algorithm is used to stop auto pay on bill.</p> <p>Parameter – Characteristic Type</p> <p>Characteristic Type is used to add the characteristic which is stamped on the bill to postpone overdue process</p>
Dispute	Monitor	F1-AT-RQJ	F1-GEN-BOMNJ	<p>This algorithm type transitions business object current state to the input Next Status or to the status related to the input Next Transition Condition. Either one but not both soft parameters may be specified. If both soft parameters are not specified, the business object will be transitioned to the default next status specified on lifecycle. Algorithms of this algorithm type may be defined for any business object status as its monitor algorithm.</p>
Dispute	Enter	C1-DPTSTAUPY	C1-DPTSTAUPY	<p>This algorithm is used to stop auto pay on bill.</p> <p>Parameter – Characteristic Type</p> <p>Characteristic Type is used to add the characteristic which is stamped on the bill to postpone overdue process</p>
Creating Adjustments	Monitor	F1-AT-RQJ	F1-GEN-BOMNJ	<p>This algorithm type transitions business object current state to the input Next Status or to the status related to the input Next Transition Condition. Either one but not both soft parameters may be specified. If both soft parameters are not specified, the business object will be transitioned to the default next status specified on lifecycle. Algorithms of this algorithm type may be defined for any business object status as its monitor algorithm.</p>
Creating Adjustments	Enter	C1-ENTERADJS	C1-ENTERADJ	<p>This algorithm is executed on submit or on approve of an dispute request. It creates the adjustments which will be swapped on the current or next bill.</p> <p>Adjustment are created with below logic</p> <p>Unpaid Bill logic</p> <ul style="list-style-type: none"> If stop auto pay switch is No and auto pay exist then create adjustment on next bill

Status	System Event	Algorithm	Algorithm Type	Description
				<ul style="list-style-type: none"> • If stop auto pay switch is Yes then perform below step <ul style="list-style-type: none"> • If bill cannot be reopen or adjustment need to be created on next bill then create adjustment on next bill • If approval is configured then create to do for manual creation of auto pay (Auto Pay is stopped while submitting the request) • Else <ul style="list-style-type: none"> • create adjustment on current bill <ul style="list-style-type: none"> • if approval is configured then <ul style="list-style-type: none"> • Bill reopen and complete (Auto Pay is stopped while submitting the request) • Delete overdue char from bill

Status	System Event	Algorithm	Algorithm Type	Description
				<ul style="list-style-type: none"> • Else <ul style="list-style-type: none"> • Stop auto pay • Reopen and complete <p>Paid Bill logic</p> <ul style="list-style-type: none"> • Adjustment will be created on next bill <p>Partial Bill Logic</p> <ul style="list-style-type: none"> • Adjustment will be created to balance current bill and another adjustment will be created for remaining amount and it will be stamped on next bill. • If dispute adjustment will increase the debit or credit balance then adjustment will be stamped on next bill. <p>There are four parameters for this algorithm.</p> <p>Parameter 1 – Adjustment on Next Bill (Required)</p> <ul style="list-style-type: none"> • Adjustments should be swapped on the current or next bill. It is used only for unpaid bill.

Status	System Event	Algorithm	Algorithm Type	Description
				<p>Parameter 2 – Match Type Entity Flag (Required)</p> <ul style="list-style-type: none"> Valid values for this parameter are BILL, BSEG and SA. This parameter defines the open item at which the match events are to be created. For bills which are not paid yet, new match events will be created based on the value of this parameter. Based on the flag defined Match Events are created as follows, <ul style="list-style-type: none"> If the Match Type Flag is BILL, then all FTs on a bill have the same Match Event. If the Match Type Flag is BSEG, then each line item (bill segment or adjustment) on the bill will have a unique match event. If the Match Type Flag is SA, then line items belonging to the same contract within a bill will have the same match event. <p>Parameter 3 – To Do Type</p> <ul style="list-style-type: none"> To Do will be sent to the user if bill can't be reopen and auto pay has been stopped.

Status	System Event	Algorithm	Algorithm Type	Description
				<p>Parameter 4 – Characteristic Type</p> <ul style="list-style-type: none"> Characteristic Type is used to remove the characteristic which is stamped on the bill to postpone overdue process
Approval Progress	In Enter	C1-DSPTAPP	C1-DSPTAPP	<p>This algorithm creates the following:</p> <ul style="list-style-type: none"> A To Do using the To Do type specified in the approval profile which is attached to the dispute request type. The To Do is sent to the appropriate users in the approval hierarchy depending on whether hierarchical approval is required or not. A log entry is added when a To Do is created using the To Do type.
Approval Progress	In Exit	F1-TODOCOMPL	F1-TODOCOMPL	<p>This algorithm type completes To Do entries that are linked to an object when the object exits a given state. The system finds all open To Do entries with drill keys for the current</p>

Status	System Event	Algorithm	Algorithm Type	Description
				business object's primary key, and completes them, unless the To Do entry's type has been configured with an Exclude To Do Type Characteristic Type indicating that it should not be automatically completed.
Approved	Enter	C1-DSPAPPRVD	C1-DSPAPPRVD	This algorithm is triggered when the approver clicks the Approve button. It checks whether the approval is required from users at the next level in the approval hierarchy. If the approval is required from the next level in the approval hierarchy, the status of the dispute request is changed to Approval In Progress and the algorithm attached to the Approval In Progress status is invoked. If further approval is not required, the status of the dispute request is changed to Creating Adjustment .
Return to Submitter	Enter	C1-DSPTRSUB	C1-DSPTRSUB	This algorithm is invoked on Re-Submit button. It moves the status of Dispute Request into Draft . A To Do will be generated for the user as submitter whose To Do Type and To Do Role are fetched from Dispute Request Type .
Rejected	Enter	C1-DSPTRJ	C1-DSPTRJ	This algorithm is executed when on reject. Parameter 1 – To Do Type <ul style="list-style-type: none"> To Do will be sent to the user if bill can't be reopen and auto pay has been stopped. Parameter 2 – Characteristic Type <ul style="list-style-type: none"> Characteristic Type is used to remove the characteristic which is stamped on the bill to postpone overdue process
Canceled	Enter	C1-DSPTRJ	C1-DSPTRJ	This algorithm is executed when on reject. Parameter 1 – To Do Type <ul style="list-style-type: none"> To Do will be sent to the user if bill can't be reopen and auto pay has been stopped. Parameter 2 – Characteristic Type <ul style="list-style-type: none"> Characteristic Type is used to remove the characteristic which is stamped on the bill to postpone overdue process

Dispute Request Type

Oracle Revenue Management and Billing allows you to define:

- **Dispute Request Type** – It is used to create a dispute request. You can define multiple dispute request types in the system. A dispute request type helps the system to determine:
 - Whether the dispute request must be approved before creating dispute adjustments in the system

- Approval profile using which the dispute request must be approved
- Whether multi-level or single-level approval is required while creating dispute adjustments in the system
- Adjustment type using which the dispute adjustment must be created when the total dispute amount is less than the minimum dispute amount
- Default adjustment type using which dispute adjustments must be created

While defining a dispute request type where approval workflow is required, you need to select the **Approval Required** check box. If the **Approval Required** check box is selected, the dispute request (which is created using the dispute request type) is sent for approval before creating the dispute adjustments. However, if the **Approval Required** check box is not selected, the dispute adjustments are created immediately on submitting a dispute request. The approval process is configured through the approval profile. The approval profile allows you to define the approval hierarchy. You can define a debit and credit hierarchy in the approval profile using the threshold amount. The debit approval hierarchy and credit approval hierarchy is used for approving dispute request. Therefore, while defining an approval profile for dispute, you need to define credit and debit hierarchy and set the To Do Type to **C1-DISAP**.

You can define an approval hierarchy where users with different To Do role at each level can approve or reject the dispute request. For example, you can define an approval profile called A1 with two levels of approval. At the first level, a user with the *Manager* To Do role will approve or reject the dispute request, and at the second level, a user with the *Senior Manager* To Do role will approve or reject the dispute request. On submitting a dispute request where approval is required, a notification in the form of To Do is sent to all users with the To Do role defined at the first level in the hierarchy. Once the request is approved at the first level, a notification is sent to all users with the To Do role defined at the next level in the hierarchy. This process continues till the approval is received from all levels in the hierarchy. Once users at all levels approve the dispute request, the dispute adjustments are created. However, if an approver at any level in the hierarchy rejects the request, the dispute adjustments are not created.

The approval hierarchy is controlled by the threshold amount. For example, you define an approval profile called A1 with two levels of approval – First Level (Threshold Amount: 300, To Do Role: *Manager*) and Second Level (Threshold Amount: 500, To Do Role: *Senior Manager*). Now, if the total dispute amount is equal to 300 or less than 500, then the approval is required only from the first level in the hierarchy and not from the second level in the hierarchy. However, if the total dispute amount is equal to or greater than 500, then the approval is required from the first level and then from the second level in the hierarchy. But, if the total dispute amount is less than 300, then the approval is not required from any levels in the hierarchy. The system will automatically approve the dispute request and create the dispute adjustments.

The system supports both single-level and multi-level approval process while approving dispute request. If the **Hierarchical Approval** check box is selected while defining a dispute request type, the approval hierarchy defined in the approval profile is followed based on the threshold limit. However, if the **Hierarchical Approval** check box is not selected while defining a dispute request type, the approval is required only from the approval level where the total dispute amount falls within the threshold limit. Let us understand this with the help of some examples.

Dispute Request Type	Approval Profile	Approval Hierarchy	Hierarchical Approval								
D1	Dispute Analyst	<p>Credit Hierarchy</p> <table border="1"> <thead> <tr> <th>Threshold Amount</th> <th>To Do Role</th> </tr> </thead> <tbody> <tr> <td>\$500</td> <td>Senior Analyst</td> </tr> <tr> <td>\$750</td> <td>Manager</td> </tr> <tr> <td>\$1500</td> <td>Senior Manager</td> </tr> </tbody> </table>	Threshold Amount	To Do Role	\$500	Senior Analyst	\$750	Manager	\$1500	Senior Manager	Yes
Threshold Amount	To Do Role										
\$500	Senior Analyst										
\$750	Manager										
\$1500	Senior Manager										
D2	Dispute Analyst	Credit Hierarchy	No								

Dispute Request Type	Approval Profile	Approval Hierarchy		Hierarchical Approval
		Threshold Amount	To Do Role	
		\$500	Senior Analyst	
		\$750	Manager	
		\$1500	Senior Manager	
D3	Dispute Analyst	Debit Hierarchy		Yes
		Threshold Amount	To Do Role	
		\$100	Senior Analyst	
		\$200	Manager	
		\$300	Senior Manager	
D4	Dispute Analyst	Debit Hierarchy		No
		Threshold Amount	To Do Role	
		\$100	Senior Analyst	
		\$200	Manager	
		\$300	Senior Manager	

The following table indicates how the system will behave in different dispute scenarios:

Dispute Request	Dispute Request Type	Total Refund Amount (\$)	Comments
DR1	D1	200	This dispute request is automatically approved by the system because the total dispute amount is less than \$500.
DR2	D1	750	The To Do is sent for approval to the following users in the specified order: <ol style="list-style-type: none"> 1. Users with the Senior Analyst To Do role 2. Users with the Manager To Do role This is because the total dispute amount is either equal to \$750 or less than \$1500 and hierarchical approval is required.
DR3	D1	2000	The To Do is sent for approval to the following users in the specified order: <ol style="list-style-type: none"> 1. Users with the Senior Analyst To Do role 2. Users with the Manager To Do role 3. Users with the Senior Manager To Do role



Dispute Request	Dispute Request Type	Total Refund Amount (\$)	Comments
			This is because the total dispute amount is greater than \$1500 and hierarchical approval is required.
DR4	D2	200	This dispute request is automatically approved by the system because the total dispute amount is less than \$500.
DR5	D2	750	The To Do is sent for approval to users with the Manager To Do role. This is because the total dispute amount is either equal to \$750 or less than \$1500 and hierarchical approval is not required.
DR6	D2	2000	The To Do is sent for approval to users with the Senior Manager To Do role. This is because the total dispute amount is greater than \$1500 and hierarchical approval is not required.
DR7	D3	90	This dispute request is automatically approved by the system because the total dispute amount is less than \$100.
DR8	D3	250	The To Do is sent for approval to the following users in the specified order: <ul style="list-style-type: none"> 1. Users with the Senior Analyst To Do role 2. Users with the Manager To Do role This is because the total dispute amount is either equal to \$200 or less than \$300 and hierarchical approval is required.
DR9	D3	500	The To Do is sent for approval to the following users in the specified order: <ul style="list-style-type: none"> 1. Users with the Senior Analyst To Do role 2. Users with the Manager To Do role 3. Users with the Senior Manager To Do role This is because the total dispute amount is greater than \$300 and hierarchical approval is required.
DR10	D4	90	This dispute request is automatically approved by the system because the total dispute amount is less than \$100.
DR11	D4	250	The To Do is sent for approval to users with the Manager To Do role. This is because the total dispute amount is either equal to \$200 or less than \$300 and hierarchical approval is not required.
DR12	D4	500	The To Do is sent for approval to users with the Senior Manager To Do role. This is because the total dispute amount is greater than \$300 and hierarchical approval is not required.

The **Dispute Request Type** screen allows you to define, edit, delete, and copy a dispute request type. This screen consists of the following zones:

- [Dispute Request Type List](#) on page 2021
- [Dispute Request Type](#) on page 2021

Dispute Request Type List

The **Dispute Request Type List** zone lists dispute request types that are already defined in the system. It contains the following columns:

Column Name	Column Description
Dispute Request Type	Displays the dispute request type.
Description	Displays the description of the dispute request type.
Edit	On clicking the Edit () icon, the Dispute Request Type screen appears where you can edit the details of the dispute request type.
Duplicate	On clicking the Duplicate () icon, the Dispute Request Type screen appears where you can define a dispute request type using an existing dispute request type.
Delete	On clicking the Delete () icon, you can delete the dispute request type. Note: You can delete a dispute request type when you have not created a dispute request using the dispute request type.

On clicking the **Broadcast** () icon corresponding to dispute request type, the **Dispute Request Type** zone appears with the details of the respective dispute request type.

Related Topics

For more information on...	See...
How to define a dispute request type	Defining a Dispute Request Type on page 2024
How to edit a dispute request type	Editing a Dispute Request Type on page 2027
How to copy a dispute request type	Copying a Dispute Request Type on page 2031
How to delete a dispute request type	Deleting a Dispute Request Type on page 2030
How to view the details of a dispute request type	Viewing the Dispute Request Type Details on page 2033

Dispute Request Type

The **Dispute Request Type** zone displays the details of the dispute request type. This zone consists of the following sections:

- **Main** – This section provides basic information about the dispute request type. It contains the following fields:

Field Name	Field Description
Dispute Request Type	Displays the dispute request type.
Description	Displays the description of the dispute request type.
Dispute Request Business Object	Indicates the business object that will be used to create the dispute request. In addition, a context menu appears corresponding to this field which helps in navigating to other screens in the application.

Field Name	Field Description
	<p>Note: It has a link. On clicking the link, the Business Object screen appears where you can view the details of the respective business object.</p>
Detailed Description	Displays additional information about the dispute request type.
Status	<p>Indicates the status of the dispute request type. The valid values are:</p> <ul style="list-style-type: none"> • Active • Inactive
Default Adjustment Type	<p>Indicates the adjustment type using which the dispute adjustment must be created.</p> <p>Note: It has a link. On clicking the link, the Adjustment Type screen appears where you can view the details of the respective adjustment type.</p>
Approval Required	Indicates whether approval is required while creating the dispute adjustments using the dispute request type.
Approval Profile	<p>Indicates the approval profile which must be used to define approval hierarchy for the dispute request type.</p> <p>Note: This field appears when the Approval Required check box is selected.</p> <p>It has a link. On clicking the link, the Approval Profile screen appears where you can view the details of the respective approval profile.</p>
Hierarchical Approval	<p>Indicates whether multi-level or single approval is required while creating the dispute adjustments using the dispute request type.</p> <p>Note: This field appears when the Approval Required check box is selected.</p>
Zero Threshold Amount Hierarchy	Indicates that based on the approval profile hierarchy, To Do Type from the hierarchy (credit/debit) will be picked up.
Submitter To Do Type	<p>Indicates the To Do type for the submitter when the dispute request type is resubmitted by the approver.</p> <p>Note: This field appears when the Approval Required check box is selected.</p> <p>It has a link. On clicking the link, the To Do Type screen appears where you can view the details of the respective To Do type.</p>
Submitter To Do Role	Indicates the To Do role for the submitter when the dispute request type is resubmitted by the approver.

Field Name	Field Description
	<p>Note:</p> <p>This field appears when the Approval Required check box is selected.</p> <p>It has a link. On clicking the link, the To Do Role screen appears where you can view the details of the respective To Do role.</p>

- **Characteristics** – This section lists the characteristics of the dispute request type. It contains the following columns:

Column Name	Column Description
Characteristic Type	Indicates the characteristic type.
Characteristic Value	Displays the value of the characteristic type.

- **Record Actions** – This section contains the following buttons:

Button Name	Button Description
Edit	Used to edit the details of the dispute request type.
Delete	Used to delete the dispute request type.
	Note: You can delete a dispute request type when you have not created a dispute request using the dispute request type.
Duplicate	Used to create a new dispute request type using an existing dispute request type.

- **Record Information** – This section contains the following fields:

Field Name	Field Description
Business Object	Indicates the business object using which the dispute request type is created. In addition, a context menu appears corresponding to this field which helps in navigating to other screens in the application.
	Note: It has a link. On clicking the link, the Business Object screen appears where you can view the details of the respective business object.

By default, the **Dispute Request Type** zone does not appear in the **Dispute Request Type** screen. It appears when you click the **Broadcast** () icon corresponding to the dispute request type in the **Dispute Request Type List** zone.

Related Topics

For more information on...	See...
How to define a dispute request type	Defining a Dispute Request Type on page 2024
How to edit a dispute request type	Editing a Dispute Request Type on page 2027
How to copy a dispute request type	Copying a Dispute Request Type on page 2031
How to delete a dispute request type	Deleting a Dispute Request Type on page 2030
How to view the details of a dispute request type	Viewing the Dispute Request Type Details on page 2033

Defining a Dispute Request Type

Prerequisites

To define a dispute request type, you should have:

- Dispute request business objects defined in the application
- Approval profiles defined in the application
- Adjustment types with and without A/P request type defined in the application

Procedure

To define a dispute request type:

1. Click the **Admin** link in the **Application** toolbar.
A list appears.
2. From the **Admin** menu, select **D** and then click **Dispute Request Type**.
A sub-menu appears.
3. Click the **Add** option from the **Dispute Request Type** sub-menu.

The **Select Business Object** screen appears. It contains the following fields:

Field Name	Field Description	Mandatory (Yes or No)
Dispute Request Type Business Object	Used to indicate the business object that you want to use to create the dispute request type.	Yes

Tip: Alternatively, you can access the **Select Business Object** screen by clicking the **Add** button in the **Page Title** area of the **Dispute Request Type** screen.

Note: The **Select Business Object** screen appears when there are multiple dispute request type business objects defined in the application. If there is only one dispute request type business object defined in the application, the **Dispute Request Type** screen appears.

4. Select the required dispute request type business object from the respective field.
5. Click **OK**.

The **Dispute Request Type** screen appears. It contains the following sections:

- **Main** – Used to specify basic details about the dispute request type.
- **Characteristics** – Used to define the characteristics for the dispute request type.

The **Main** section contains the following fields:

Field Name	Field Description	Mandatory (Yes or No)
Dispute Request Type	Used to specify the dispute request type.	Yes
Business Object	Indicates the dispute request type business object used while defining the dispute request type.	Not applicable
Description	Used to specify the description for the dispute request type.	Yes

Field Name	Field Description	Mandatory (Yes or No)
Dispute Request Business Object	Used to indicate the business object that you want to use while creating the dispute request.	Yes
Detailed Description	Used to specify additional information about the dispute request type.	No
Status	<p>Used to indicate the status of the dispute request type. The valid values are:</p> <ul style="list-style-type: none"> Active Inactive <p>Note: You cannot change the status of a dispute request type to Inactive if there are dispute requests which are created using the dispute request type and are currently in the Draft or Approval In Progress status.</p>	Yes
Default Adjustment Type	<p>Used to indicate the adjustment type using which the dispute adjustment must be created.</p> <p>Note: The Search (🔍) icon appears corresponding to this field. On clicking the Search icon, the Adjustment Type Search window appears.</p>	Yes
Approval Required	Used to indicate whether approval is required while creating the dispute adjustments using the dispute request type.	No
Approval Profile	<p>Used to indicate the approval profile which must be used to define approval hierarchy for the dispute request type.</p> <p>Note: This field appears when the Approval Required check box is selected.</p>	Yes (Conditional)
Hierarchical Approval	<p>Used to indicate whether multi-level or single-level approval is required while creating the dispute adjustments using the dispute request type.</p> <p>Note: This field appears when the Approval Required check box is selected.</p>	No
Zero Threshold Amount Hierarchy	Used to indicate that based on the approval profile hierarchy, To Do Type from the hierarchy will be selected. The valid values are:	No

Field Name	Field Description	Mandatory (Yes or No)
	<ul style="list-style-type: none"> Credit Debit 	
Submitter To Do Type	Used to indicate the To Do type for the submitter when the dispute request is resubmitted by the approver.	Yes (Conditional)
	<p>Note: This field appears when the Approval Required check box is selected.</p> <p>The Search (🔍) icon appears corresponding to this field. On clicking the Search icon, the To Do Type Search window appears.</p>	<p>Note: This field is required when the Approval Required check box is selected.</p>
Submitter To Do Role	Used to indicate the To Do role for the submitter when the dispute request is resubmitted by the approver.	Yes (Conditional)
	<p>Note: This field appears when the Approval Required check box is selected.</p>	<p>Note: This field is required when the Approval Required check box is selected.</p>

Note:

When the threshold amount is equal to zero for the request then based on the value in **Zero Threshold Amount Hierarchy**, the to do type will be picked from the **Approval Profile** hierarchy to send notification.

Only when the **Approval Required** checkbox is selected, you will be able to select **Hierarchical Approval** and **Approval Profile** to be used. If hierarchical approval is not selected, the request has to be approved by a single approver (highest level approver determined by the dispute amount and approval profile).

- Enter the required details depending on whether you want to define dispute request type.
- Define characteristics for the dispute request type, if required.
- Click **Save**.

The dispute request type is defined.

Related Topics

For more information on...	See...
Dispute Request Type screen	Dispute Request Type on page 2017
Dispute Request Type List zone	Dispute Request Type List on page 2021
How to define a characteristic for a dispute request type	Defining a Characteristic for a Dispute Request Type on page 2026

Defining a Characteristic for a Dispute Request Type**Prerequisites**

To define a characteristic for a dispute request type, you should have:

- Characteristic types defined in the application (where the characteristic entity is set to **Dispute Request Type**)

Procedure

To define a characteristic for a dispute request type:

1. Ensure that the **Characteristics** section is expanded when you are defining, editing, or copying a dispute request type.

The **Characteristics** section contains the following fields:

Field Name	Field Description	Mandatory (Yes or No)
Characteristic Type	Used to indicate the characteristic type.	Yes (Conditional)
	Note: The list includes only those characteristic types where the characteristic entity is set to Dispute Request Type .	Note: This field is required when you are defining a characteristic for the dispute request type.
Characteristic Value	Used to specify the value for the characteristic type.	Yes (Conditional)
	Note: On specifying the value for a predefined characteristic type, the description of the characteristic value appears corresponding to the Characteristic Value field.	Note: This field is required when you are defining a characteristic for the dispute request type.

2. Enter the required details.

Note: If you select a predefined characteristic type, the **Search** (🔍) icon appears corresponding to the **Characteristic Value** field. On clicking the **Search** icon, you can search for a predefined characteristic value.

3. If you want to define more than one characteristic for the dispute request type, click the **Add** (+) icon and then repeat step 2.

Note: However, if you want to remove a characteristic from the dispute request type, click the **Delete** (🗑️) icon corresponding to the characteristic.

Related Topics

For more information on...	See...
How to define a dispute request type	Defining a Dispute Request Type on page 2024
How to edit a dispute request type	Editing a Dispute Request Type on page 2027
How to copy a dispute request type	Copying a Dispute Request Type on page 2031

Editing a Dispute Request Type

Prerequisites

To edit a dispute request type, you should have:

- Dispute request business objects defined in the application

- Approval profiles defined in the application
- Adjustment types with and without A/P request type defined in the application

Procedure

To edit a dispute request type:

1. Click the **Admin** link in the **Application** toolbar.
A list appears.
2. From the **Admin** menu, select **D** and then click **Dispute Request Type**.
A sub-menu appears.
3. Click the **Search** option from the **Dispute Request Type** sub-menu.
The **Dispute Request Type** screen appears.
4. In the **Dispute Request Type List** zone, click the **Edit**  icon in the **Edit** column corresponding to the dispute request type whose details you want to edit.

The **Dispute Request Type** screen appears. It contains the following sections:

- **Main** – Used to specify basic details about the dispute request type.
- **Characteristics** – Used to define the characteristics for the dispute request type.

The **Main** section contains the following fields:

Field Name	Field Description	Mandatory (Yes or No)
Dispute Request Type	Displays the dispute request type.	Not applicable
Business Object	Indicates the dispute request type business object used while defining the dispute request type.	Not applicable
Description	Used to specify the description for the dispute request type.	Yes
Dispute Request Business Object	Used to indicate the business object that you want to use while creating the dispute request.	Yes
Detailed Description	Used to specify additional information about the dispute request type.	No
Status	Used to indicate the status of the dispute request type. The valid values are: <ul style="list-style-type: none"> • Active • Inactive <div style="border: 1px solid black; padding: 5px; margin-top: 10px;"> <p>Note: You cannot change the status of a dispute request type to Inactive if there are dispute requests which are created using the dispute request type and are currently in the Draft or Approval In Progress status.</p> </div>	Yes
Default Adjustment Type	Used to indicate the adjustment type using which the dispute adjustment is created.	Yes

Field Name	Field Description	Mandatory (Yes or No)
	Note: The Search (🔍) icon appears corresponding to this field. On clicking the Search icon, the Adjustment Type Search window appears.	
Approval Required	Used to indicate whether approval is required while creating the dispute adjustments using the dispute request type.	No
Approval Profile	Used to indicate the approval profile which must be used to define approval hierarchy for the dispute request type. Note: This field appears when the Approval Required check box is selected.	Yes (Conditional) Note: This field is required when the Approval Required check box is selected.
Hierarchical Approval	Used to indicate whether multi-level or single-level approval is required while creating the dispute adjustments using the dispute request type. Note: This field appears when the Approval Required check box is selected.	No
Zero Threshold Amount Hierarchy	Used to indicate that based on the approval profile hierarchy, To Do Type from the hierarchy is selected. The valid values are: <ul style="list-style-type: none"> • Credit • Debit 	No
Submitter To Do Type	Used to indicate the To Do type for the submitter when the dispute request is resubmitted by the approver. Note: This field appears when the Approval Required check box is selected. The Search (🔍) icon appears corresponding to this field. On clicking the Search icon, the To Do Type Search window appears.	Yes (Conditional) Note: This field is required when the Approval Required check box is selected.
Submitter To Do Role	Used to indicate the To Do role for the submitter when the dispute request is resubmitted by the approver.	Yes (Conditional)

Field Name	Field Description	Mandatory (Yes or No)
	Note: This field appears when the Approval Required check box is selected.	Note: This field is required when the Approval Required check box is selected.

Tip: Alternatively, you can click the **Edit** button in the **Dispute Request Type** zone to edit the details of the dispute request type.

5. Modify the details, if required.
6. Define, edit, or remove characteristics of the dispute request type, if required.
7. Click **Save**.

The changes made to the dispute request type are saved.

Related Topics

For more information on...	See...
Dispute Request Type screen	Dispute Request Type on page 2017
Dispute Request Type List zone	Dispute Request Type List on page 2021
Dispute Request Type zone	Dispute Request Type on page 2021
How to define a characteristic for a dispute request type	Defining a Characteristic for a Dispute Request Type on page 2026

Deleting a Dispute Request Type

Procedure

To delete a dispute request type:

1. Click the **Admin** link in the **Application** toolbar.
A list appears.
2. From the **Admin** menu, select **D** and then click **Dispute Request Type**.
A sub-menu appears.
3. Click the **Search** option from the **Dispute Request Type** sub-menu.
The **Dispute Request Type** screen appears.
4. In the **Dispute Request Type List** zone, click the **Delete** (🗑️) icon in the **Delete** column corresponding to the dispute request type that you want to delete.
A message appears confirming whether you want to delete the dispute request type.

Note: You can delete a dispute request type when you have not defined a dispute request using the dispute request type.

Tip: Alternatively, you can click the **Delete** button in the **Dispute Request Type** zone to delete the dispute request type.

5. Click **OK**.
The dispute request type is deleted.

Related Topics

For more information on...	See...
Dispute Request Type screen	Dispute Request Type on page 2017
Dispute Request Type List zone	Dispute Request Type List on page 2021
Dispute Request Type zone	Dispute Request Type on page 2021

Copying a Dispute Request Type

Instead of creating a dispute request type from scratch, you can create a new dispute request type using an existing dispute request type. This is possible through copying a dispute request type. On copying a dispute request type, the details including the characteristics are copied to the new dispute request type. You can then edit the details, if required.

Prerequisites

To copy a dispute request type, you should have:

- Dispute request type (whose copy you want to create) defined in the application
- Dispute request business objects defined in the application
- Approval profiles defined in the application
- Adjustment types with and without A/P request type defined in the application

Procedure

To copy a dispute request type:

1. Click the **Admin** link in the **Application** toolbar.
A list appears.
2. From the **Admin** menu, select **D** and then click **Dispute Request Type**.
A sub-menu appears.
3. Click the **Search** option from the **Dispute Request Type** sub-menu.
The **Dispute Request Type** screen appears.
4. In the **Dispute Request Type List** zone, click the **Duplicate** () icon in the **Duplicate** column corresponding to the dispute request type whose copy you want to create.

The **Dispute Request Type** screen appears. It contains the following sections:

- **Main** – Used to specify basic details about the dispute request type.
- **Characteristics** – Used to define the characteristics for the dispute request type.

The **Main** section contains the following fields:

Field Name	Field Description	Mandatory (Yes or No)
Dispute Request Type	Used to specify the dispute request type.	Yes
Business Object	Indicates the dispute request type business object used while defining the dispute request type.	Not applicable
Description	Used to specify the description for the dispute request type.	Yes

Field Name	Field Description	Mandatory (Yes or No)
Dispute Request Business Object	Used to indicate the business object that you want to use while creating the dispute request.	Yes
Detailed Description	Used to specify additional information about the dispute request type.	No
Status	Used to indicate the status of the dispute request type. The valid values are: <ul style="list-style-type: none"> Active Inactive <p>Note: You cannot change the status of a dispute request type to Inactive if there are dispute requests which are created using the dispute request type and are currently in the Draft or Approval In Progress status.</p>	Yes
Default Adjustment Type	Used to indicate the adjustment type using which the dispute adjustment must be created. <p>Note: The Search (🔍) icon appears corresponding to this field. On clicking the Search icon, the Adjustment Type Search window appears.</p>	Yes
Approval Required	Used to indicate whether approval is required while creating the dispute adjustments using the dispute request type.	No
Approval Profile	Used to indicate the approval profile which must be used to define approval hierarchy for the dispute request type. <p>Note: This field appears when the Approval Required check box is selected.</p>	Yes (Conditional) <p>Note: This field is required when the Approval Required check box is selected.</p>
Hierarchical Approval	Used to indicate whether multi-level or single-level approval is required while creating the dispute adjustments using the dispute request type. <p>Note: This field appears when the Approval Required check box is selected.</p>	No
Zero Threshold Amount Hierarchy	Used to indicate that based on the approval profile hierarchy, To Do Type from the hierarchy will be selected. The valid values are:	No

Field Name	Field Description	Mandatory (Yes or No)
	<ul style="list-style-type: none"> Credit Debit 	
Submitter To Do Type	Used to indicate the To Do type for the submitter when the dispute request is resubmitted by the approver.	Yes (Conditional) Note: This field is required when the Approval Required check box is selected.
	Note: This field appears when the Approval Required check box is selected. The Search (🔍) icon appears corresponding to this field. On clicking the Search icon, the To Do Type Search window appears.	
Submitter To Do Role	Used to indicate the To Do role for the submitter when the dispute request is resubmitted by the approver.	Yes (Conditional) Note: This field is required when the Approval Required check box is selected.
	Note: This field appears when the Approval Required check box is selected.	

Tip: Alternatively, you can click the **Duplicate** button in the **Dispute Request Type** zone to create a copy of the dispute request type.

- Enter the required details.
- Define, edit, or remove characteristics of the dispute request type, if required.
- Click **Save**.

The new dispute request type is defined.

Related Topics

For more information on...	See...
Dispute Request Type screen	Dispute Request Type on page 2017
Dispute Request Type List zone	Dispute Request Type List on page 2021
Dispute Request Type zone	Dispute Request Type on page 2021
How to define a characteristic for a dispute request type	Defining a Characteristic for a Dispute Request Type on page 2026

Viewing the Dispute Request Type Details

Procedure

To view the details of a dispute request type:

- Click the **Admin** link in the **Application** toolbar.

A list appears.

2. From the **Admin** menu, select **D** and then click **Dispute Request Type**.
A sub-menu appears.
3. Click the **Search** option from the **Dispute Request Type** sub-menu.
The **Dispute Request Type** screen appears.
4. In the **Dispute Request Type List** zone, click the **Broadcast** (📡) icon corresponding to the dispute request type whose details you want to view.
The **Dispute Request Type** zone appears.
5. View the details of the dispute request type in the **Dispute Request Type** zone.

Related Topics

For more information on...	See...
Dispute Request Type screen	Dispute Request Type on page 2017
Dispute Request Type List zone	Dispute Request Type List on page 2021
Dispute Request Type zone	Dispute Request Type on page 2021

Dispute Request (Used for Searching)

The **Dispute Request** screen allows you to search for a dispute request using various search criteria. It also allows you to create a dispute request. Through this screen, you can navigate to the following screen:

- [Dispute Request \(Used for Viewing\)](#) on page 2042

This screen consists of the following zone:

- [Search Dispute Request](#) on page 2034

Search Dispute Request

The **Search Dispute Request** zone allows you to search for dispute requests using various search criteria. This zone contains the following two sections:

- **Search Criteria** – The **Search Criteria** section contains the following fields:

Field Name	Field Description	Mandatory (Yes or No)
Search By	Used to indicate whether you want to search for a dispute request using request, person, account or bill details. The valid values are: <ul style="list-style-type: none"> • Request Details – Used when you want to search for dispute requests. • Person, Account, or Bill Details – Used when you want to search for person, account, or bill requests. <p>Note: By default, the Request Details option is selected.</p>	Yes
Dispute Request Type	Used to search dispute requests which are created using a particular dispute request type.	No

Field Name	Field Description	Mandatory (Yes or No)
	Note: This field appears when you select the Request Details option from the Search By list.	
Status	Used to search dispute requests with a particular status. The valid values are: <ul style="list-style-type: none"> • Approval In Progress • Cancelled • Draft • Processed • Rejected Note: This field appears when you select the Request Details option from the Search By list.	No
User ID	Used to search dispute requests which are created by a particular user. Note: This field appears when you select the Request Details option from the Search By list.	No
Created From	Used to search dispute requests which are created from a particular date onwards. Note: This field appears when you select the Request Details option from the Search By list.	No
To	Used to search dispute requests which are created till a particular date. Note: This field appears when you select the Request Details option from the Search By list.	No
Dispute Request ID	Used to search a particular dispute request. Note: This field appears when you select the Request Details option from the Search By list.	No
Account ID	Used to search dispute requests which are created for a particular account. Note: The Search (🔍) icon appears corresponding to the field. On clicking the Search icon, the Account Search window appears.	No
Dispute Reason	Used to search dispute requests which are created using a particular dispute reason for the bill. Note: This field appears only when you select the Request Details option from the Search By list.	No

Field Name	Field Description	Mandatory (Yes or No)
Person ID	Used to search dispute requests which are created for a particular person.	No
	<p>Note:</p> <p>This field appears when you select the Person, Account, or Bill Details option from the Search By list.</p> <p>The Search (🔍) icon appears corresponding to the field. On clicking the Search icon, the Person Search window appears.</p>	
Bill ID	Used to search dispute requests which includes bill segments or adjustments of a particular bill.	No
	<p>Note:</p> <p>This field appears only when you select the Person, Account, or Bill Details option from the Search By list.</p> <p>The Search (🔍) icon appears corresponding to the field. On clicking the Search icon, the Bill Search window appears.</p>	
Alternate Bill ID	Used to search dispute requests which are created for a particular bill using the alternate bill ID.	No
	<p>Note: This field appears when you select the Person, Account, or Bill Details option from the Search By list.</p>	
Bill Date From	Used to search dispute requests which includes bill segments or adjustments of bills which are created from a particular date onwards.	No
	<p>Note: This field appears when you select the Person, Account, or Bill Details option from the Search By list.</p>	
To	Used to search dispute requests which includes bill segments or adjustments of bills which are created till a particular date.	No
	<p>Note: This field appears when you select the Person, Account, or Bill Details option from the Search By list.</p>	

Note: You must specify at least one search criterion while searching for a dispute request.

- **Search Results** – On clicking the **Search** button, the search results appear based on the specified search criteria. The **Search Results** section contains the following columns:

Column Name	Column Description
Create Date Time	Displays the date and time when the dispute request is created.
Dispute Request Information	Displays information about the dispute request. Note: It has a link. On clicking the link, the Dispute Request screen appears depending on whether the request is for dispute.
Status	Indicates the status of the dispute request.
Account Information	Displays additional information about the account for which the dispute request is created. Note: It has a link. On clicking the link, the Account screen appears with the details of the respective account.
Created By	Indicates the user who has created the dispute request.

Related Topics

For more information on...	See...
How to search for a dispute request	Searching for a Dispute Request on page 2037
How to view the details of a dispute request	Viewing the Dispute Request Details on page 2038
How to create a dispute request	Creating a Dispute Request on page 2039

Searching for a Dispute Request

Prerequisites

To search for a dispute request, you should have:

- Dispute request types defined in the application

Procedure

To search for a dispute request:

1. Click the **Menu** link in the **Application** toolbar.
A list appears.
2. From the **Main** menu, select **Accounting and Receivable** and then click **Dispute Request**.
A sub-menu appears.
3. Click the **Search** option from the **Dispute Request** sub-menu.
The **Dispute Request** screen appears.
4. Enter the search criteria in the **Search Dispute Request** zone.

Note: ORMB search engine supports wildcard search, where you can substitute the percentage (%) symbol as a stand in for any word or letter in a search criteria. You can use the '%' wildcard character in all input fields except the date and ID fields. The '%' wildcard character is suffixed automatically at the end of the partial search criteria. Therefore, you may or may not specify the wildcard character at the end of the partial search criteria. However, you have to prefix the wildcard character manually wherever required.

5. Click **Search**.

A list of dispute requests that meet the search criteria appears in the **Search Results** section.

Related Topics

For more information on...	See...
Dispute Request screen	Dispute Request (Used for Viewing) on page 2042
Search Dispute Request zone	Search Dispute Request on page 2034

Viewing the Dispute Request Details**Procedure**

To view the details of a dispute request:

1. Search for the dispute request in the **Dispute Request** screen.
2. In the **Search Results** section, click the link in the **Dispute Request Information** column corresponding to the dispute request whose details you want to view.

The **Dispute Request** screen appears. It consists of the following tabs:

- **Main** – Displays information about the dispute request. It contains the following zones:
 - **Dispute Request** – Displays the details of the dispute request.
 - **Dispute Details** – Lists the entities, such as auto payment events, and/or credit bill line items (such as credit bill segments and adjustments), of the account which must be disputed.
 - **Dispute Adjustments** – Displays the adjustment details of dispute request.

Note: This zone appears when you click the Broadcast () icon corresponding to the entity type as **Bill** in the **Dispute Details** zone and when the status is **Processed**.

- **Previous Dispute Requests** – Displays the details of the bill which must be disputed.

Note: This zone appears when you click the Broadcast () icon corresponding to the entity type as **Bill** in the **Dispute Details** zone.

- **Bills** – Used to search bills with credit line items, such as credit bill segments and adjustments, that you want to dispute.
 - **Log** – Lists the complete trail of actions performed on the dispute request.
3. View the details of the dispute request in the **Dispute Request** zone.
 4. View the entities such as auto payment events, and/or credit bill line items (such as credit bill segments and adjustments), of the account which must be disputed in the **Dispute Details** zone.
 5. View the adjustment details of dispute request in the **Dispute Adjustments** zone.
 6. View the details of the bill which must be disputed in the **Previous Dispute Requests** zone.

Related Topics

For more information on...	See...
Dispute Request screen	Dispute Request (Used for Viewing) on page 2042
Dispute Request zone	Dispute Request on page 2043
Dispute Details zone	Dispute Details on page 2045
Dispute Adjustments zone	Dispute Adjustments on page 2045
Previous Dispute Requests zone	Previous Dispute Requests on page 2046

For more information on...	See...
How to search for a dispute request	Searching for a Dispute Request on page 2037

Creating a Dispute Request

Prerequisites

To create a dispute request, you should have:

- Dispute request types defined in the application

Procedure

To create a dispute request:

1. Do either of the following:

If you want to	Then
Define a dispute request from the Account Receivable Central screen	<ol style="list-style-type: none"> 1. Click the Menu link in the Application toolbar. A list appears. 2. From the Main menu, select Accounting and Receivable and then click Account Receivable Central. The Account Receivable Central screen appears. 3. Search for the bill in the Account Receivable Central screen. 4. In the Search Results section, select the required bill and then click Dispute. <p>Note: Only one bill at a time is allowed to select for Dispute Request from the Account Receivable Central screen.</p>
Define a dispute request from the Dispute Request screen	<ol style="list-style-type: none"> 1. Click the Menu link in the Application toolbar. A list appears. 2. From the Main menu, select Accounting and Receivable and then click Dispute Request. A sub-menu appears. 3. Click the Add option from the Dispute Request sub-menu.

The **Select Dispute Request Type** screen appears. It contains the following fields:

Field Name	Field Description	Mandatory (Yes or No)
Dispute Request Type	Used to indicate the request type using which you want to create the dispute request.	Yes

Field Name	Field Description	Mandatory (Yes or No)
Account ID	Used to search dispute requests which are created for a particular account.	Yes
	Note: The Search (🔍) icon appears corresponding to this field. On clicking the Search icon, the Account Search window appears.	
Dispute Reason	Used to indicate the dispute requests which are created using a particular dispute reason for the bill.	Yes

Tip: Alternatively, you can access the **Select Dispute Request Type** screen by clicking the **Add** button in the **Page Title** area of the **Dispute Request** screen.

2. Select the required dispute request type from the respective field.
3. Click **Save**.

The dispute request is defined and the status of the dispute request is set to **Draft**. The **Dispute Request** screen appears where you can view the details of the dispute request. It contains the following tabs:

Note: The dispute request can be created only for bill with zero outstanding amount.

- **Main** – Displays information about the dispute request. It contains the following zones:
 - **Dispute Request** – Displays the details of the dispute request.
 - **Dispute Details** – Lists the entities, such as auto payment events, and/or credit bill line items (such as credit bill segments and adjustments), of the account which must be disputed.
 - **Dispute Adjustments** – Displays the adjustment details of dispute request.

Note: This zone appears when you click the Broadcast (📡) icon corresponding to the entity type as **Bill** in the **Dispute Details** zone and when the status is **Processed**.

- **Previous Dispute Requests** – Displays the details of the bill which must be disputed.

Note: This zone appears when you click the Broadcast (📡) icon corresponding to the entity type as **Bill** in the **Dispute Details** zone.

- **Bills** – Used to search bills with credit line items, such as credit bill segments and adjustments, that you want to dispute.
 - **Log** – Lists the complete trail of actions performed on the dispute request.
4. Add auto payment events, or credit bill line items that you want to dispute.
 5. Edit the dispute amount of each entity, if required.
 6. Define characteristics for the dispute request, if required.

Related Topics

For more information on...	See...
Dispute Request screen	Dispute Request (Used for Viewing) on page 2042
Account Receivable Central screen	Account Receivable Central on page 1538

For more information on...	See...
How to add a bill line item to the dispute request	Adding a Bill Line Item to the Dispute Request on page 2060
How to edit a dispute request	Editing a Dispute Request on page 2050
How to define a characteristic for a dispute request	Defining a Characteristic for a Dispute Request on page 2041

Defining a Characteristic for a Dispute Request

Prerequisites

To define a characteristic for a dispute request, you should have:

- Characteristic types defined in the application (where the characteristic entity is set to **Dispute Request**)

Procedure

To define a characteristic for a dispute request:

- Search for the dispute request in the **Dispute Request** screen.
- In the **Search Results** section, click the link in the **Dispute Request Information** column corresponding to the dispute request whose details you want to edit.

The **Dispute Request** screen appears.

- Click the **Edit** button in the **Dispute Request** zone.

The **Dispute Request** screen appears.

Note: The **Edit** button appears when the dispute request is in the **Draft** status.

- Ensure that the **Characteristics** section is expanded when you are editing the dispute request.

The **Characteristics** section contains the following fields:

Field Name	Field Description	Mandatory (Yes or No)
Effective Date	Used to specify the date from when the characteristic is effective for the dispute request.	Yes (Conditional)
		Note: This field is required when you are defining a characteristic for the dispute request.
Characteristic Type	Used to indicate the characteristic type. Note: The list includes only those characteristic types where the characteristic entity is set to Dispute Request .	Yes (Conditional)
		Note: This field is required when you are defining a characteristic for the dispute request.
Characteristic Value	Used to specify the value for the characteristic type. Note: On specifying the value for a predefined characteristic type, the description of the characteristic value appears corresponding to the Characteristic Value field.	Yes (Conditional)
		Note: This field is required when you are defining a characteristic for the dispute request.

5. Enter the required details in the **Characteristics** section.

Note: If you select a predefined characteristic type, the **Search** (🔍) icon appears corresponding to the **Characteristic Value** field. On clicking the **Search** icon, you can search for a predefined characteristic value.

6. If you want to define more than one characteristic for the dispute request, click the **Add** (+) icon and then repeat step 5.

Note: However, if you want to remove a characteristic from the dispute request, click the **Delete** (🗑️) icon corresponding to the characteristic.

Related Topics

For more information on...	See...
How to search for a dispute request	Searching for a Dispute Request on page 2037
How to create a dispute request	Creating a Dispute Request on page 2039

Dispute Request (Used for Viewing)

Once you create a dispute request, the **Dispute Request** screen allows you to:

- Edit and delete a dispute request
- View the details of a dispute request
- Submit a dispute request for approval
- Approve or reject a dispute request
- View the log of a dispute request
- Add a log entry for a dispute request

This screen consists of the following tabs:

- **Main** – Displays information about the dispute request. It contains the following zones:
 - **Dispute Request** – Displays the details of the dispute request.
 - **Dispute Details** – Lists the entities, such as auto payment events, and/or credit bill line items (such as credit bill segments and adjustments), of the account which must be disputed.
 - **Dispute Adjustments** – Displays the adjustment details of dispute request.

Note: This zone appears when you click the Broadcast (📡) icon corresponding to the entity type as **Bill** in the **Dispute Details** zone and when the status is **Processed**.

- **Previous Dispute Requests** – Displays the details of the bill which must be disputed.

Note: This zone appears when you click the Broadcast (📡) icon corresponding to the entity type as **Bill** in the **Dispute Details** zone.

- **Bills** – Used to search bills with credit line items, such as credit bill segments and adjustments, that you want to dispute. It contains the following zones:
 - **Search Bills** – Lists completed bills of the account which are either with credit balance or have one or more credit line items, such as bill segments and adjustments. You can filter the bills using various search criteria.
 - **Bill Line Items** – Lists the debit and credit bill segments and adjustments of the bill.

This tab appears when the dispute request is in the **Draft** status.

- **Log** – Lists the complete trail of actions performed on the dispute request.

Dispute Request - Main

The **Main** tab displays information about the dispute request. It contains the following zones:

- [Dispute Request](#) on page 2043
- [Dispute Details](#) on page 2045
- [Dispute Adjustments](#) on page 2045
- [Previous Dispute Requests](#) on page 2046

Dispute Request

The **Dispute Request** zone displays the details of the dispute request. This zone contains the following sections:

- **Main** – This section provides basic information about the dispute request. It contains the following fields:

Field Name	Field Description
Dispute Request Information	Displays information about the dispute request.
Dispute Request Type	Indicates the dispute request type using which the dispute request is created. Note: It has a link. On clicking the link, the Dispute Request Type screen appears where you can view the details of the dispute request type.
Status	Indicates the status of the refund request. The valid values are: <ul style="list-style-type: none"> • Draft • Approval In Progress • Cancelled • Rejected • Processed
Dispute Reason	Indicates the reason why the dispute request is rejected.
Account Information	Indicates the account for which the dispute request is created. Note: It has a link. On clicking the link, the Account screen appears where you can view the details of the respective account.
Comments	Displays additional information about the dispute request.

- **Characteristics** – Lists the characteristics defined for the dispute request. It contains the following fields:

Field Name	Field Description
Effective Date	Indicates the date from when the characteristic is effective for the dispute request.
Characteristic Type	Indicates the characteristic type.
Characteristic Value	Displays the value of the characteristic type.

- **Record Actions** – This section contains the following buttons:

Button Name	Button Description
Edit	Used to edit the details of the dispute request.
	Note: The Edit button appears when the dispute request is in the Draft status.
Delete	Used to delete the dispute request.
	Note: The Delete button appears when the dispute request is in the Draft status.
Submit	Used to submit the dispute request for approval.
	Note: The Submit button appears when the dispute request is in the Draft status.
Cancel	Used to cancel the dispute request resubmitted for approval.
	Note: The Cancel button appears when the dispute request is in the Draft status.
Approve	Used to approve the dispute request.
	Note: The Approve button appears when: <ul style="list-style-type: none"> • The dispute request is in the Approval In Progress status. • A user with the approval To Do role is reviewing the dispute request.
Reject	Used to reject the dispute request.
	Note: The Reject button appears when: <ul style="list-style-type: none"> • The dispute request is in the Approval In Progress status. • A user with the approval To Do role is reviewing the dispute request.
Re Submit	Used to resubmit the dispute request to the submitter.
	Note: The Re-Submit button appears when the dispute request is in the Approval In Progress status.

- **Record Information** – This section contains the following fields:

Field Name	Field Description
Business Object	Indicates the business object using which the dispute request is created. In addition, a context menu appears corresponding to this field which helps in navigating to other screens in the application.
	Note: It has a link. On clicking the link, the Business Object screen appears where you can view the details of the respective business object.
Status Date/Time	Displays the date and time when the dispute request status is updated
Create Date/Time	Displays the date and time when the dispute request is created.

Dispute Details

The **Dispute Details** zone lists the credit/debit bill line items (such as bill segments and adjustments) that you have added to the dispute request. This zone contains the following columns:

Column Name	Column Description
Entity Type	Indicates whether the entity is a bill, bill segment, or an adjustment.
Entity ID	Displays the entity ID.
Currency	Indicates the currency in which the entity was created.
Dispute Amount	Displays the entity amount.
Adjustment Type	Indicates the adjustment type using which the dispute adjustment must be created. Note: By default, the adjustment type specified in the dispute request type appears in this column. You can change the adjustment type, if required, by editing the dispute request. It has a link. On clicking the link, the Adjustment Type screen appears where you can view the details of the respective adjustment.
Stop Auto Pay	Displays whether to stop auto payment or not. The valid values are: <ul style="list-style-type: none"> • Yes • No
Entity Information	Displays information about the entity. In addition, a context menu appears corresponding to this field which helps in navigating to other screens in the application. Note: It has a link. On clicking the link, the respective entity screen appears with the details of the respective entity.

Note:

On clicking the Broadcast () icon corresponding to the entity type as **Bill**, the **Dispute Adjustments** and **Previous Dispute Requests** zones appears with the details of the respective bill.

The **Dispute Details** zone appears when the status is **Processed**.

Dispute Amount currency will be same as bill or invoice currency. It cannot be zero or null. It will be less than or equal to the original, outstanding bill amount, or bill line item amount if the bill line item contains multiple contract.

In addition to above columns, this screen contains following buttons:

Button Name	Button Description
Edit	Used to edit the details of bill line items.
Delete	Used to delete the bill line items.

Dispute Adjustments

The **Dispute Adjustments** zone lists the adjustment details of dispute request. This zone contains the following columns:

Column Name	Column Description
Adjustment Information	Displays information about the adjustments in dispute request.
	Note: It has a link. On clicking the link, the respective Adjustment screen appears with the details of adjustment for respective entity.
Adjustment Amount	Displays the adjustment amount.

Note:

On clicking the Broadcast () icon corresponding to the entity type as **Bill**, the **Dispute Adjustments** zone appears with the details of the respective bill.

The **Dispute Adjustments** zone appears when the status is **Processed**.

Dispute Adjustment Amount cannot be zero or null, it should be delta amount.

Related Topics

For more information on...	See...
Dispute Request screen	Dispute Request (Used for Viewing) on page 2042
Dispute Request zone	Dispute Request on page 2043
Dispute Details zone	Dispute Details on page 2045
Previous Dispute Requests zone	Previous Dispute Requests on page 2046
How to search for a dispute request	Searching for a Dispute Request on page 2037

Previous Dispute Requests

The **Previous Dispute Requests** zone lists the details of bills that must be disputed. It displays the disputed amount for the bill or bill line items in previous requests. This zone contains the following columns:

Column Name	Column Description
Create Date Time	Displays the date and time dispute was created.
Dispute Request Information	Displays the dispute request ID.
	Note: It has a link. On clicking the link, the respective Dispute Request screen appears.
Entity Type	Indicates whether the entity is a bill, bill segment or an adjustment.
Entity ID	Displays the entity ID.
Dispute Amount	Displays the amount that must be disputed.
Status	Indicates the status of the dispute request. The valid values are: <ul style="list-style-type: none"> • Approval In Progress • Canceled • Draft • Processed • Rejected

Column Name	Column Description
Account Information	Displays information about the account. In addition, this column has a context menu which helps in navigating to other screens in the application. Note: It has a link. On clicking the link, the Account screen appears with details of the respective account.
Created By	Indicates the user who has created the dispute request.

Note: On clicking the Broadcast () icon corresponding to the entity type as **Bill**, the **Previous Dispute Requests** zone appears with the details of the respective bill.

Related Topics

For more information on...	See...
Dispute Request screen	Dispute Request (Used for Viewing) on page 2042
Dispute Request zone	Dispute Request on page 2043
Dispute Details zone	Dispute Details on page 2045
Dispute Adjustments zone	Dispute Adjustments on page 2045
How to search for a dispute request	Searching for a Dispute Request on page 2037

Dispute Request - Bills

The **Bills** tab allows you to search bills with credit/debit line items, such as credit/debit bill segments and adjustments, that you want to dispute. It contains the following zones:

- [Search Bills](#) on page 2047
- [Bill Line Items](#) on page 2048

Search Bills

The **Search Bills** zone lists completed bills of the account which are either with credit/debit balance or have one or more credit/debit line items, such as bill segments and adjustments. You can filter the bills using various search criteria. This zone contains the following two sections:

- **Search Criteria** – The **Search Criteria** section contains the following fields:

Field Name	Field Description	Mandatory (Yes or No)
Search By	Used to indicate that you want to search for a bill using the bill details. The valid values are: <ul style="list-style-type: none"> • Bill Details • Bill and Price Item Details Note: By default, the Bill Details option is selected.	Yes
Bill ID	Used to search a particular bill. Note: The Search () icon appears corresponding to this field. On clicking the Search icon, the Bill Search window appears.	No

Field Name	Field Description	Mandatory (Yes or No)
Price Item	Used to search bills which are created for a particular price item. Note: This field appears when you select Bill and Price Item Details option from the Search By list. You can search for a price item by clicking the Search (🔍) icon corresponding to the field. On clicking the Search icon, the Price Item Search window appears.	No
Bill Date From	Used to search bills which are created from a particular date onwards.	No
To	Used to search bills which are created till a particular date.	No

- **Search Results** – On clicking the **Search** button, the search results are filtered based on the specified search criteria. The **Search Results** section contains the following columns:

Column Name	Column Description
Bill ID	Displays the bill ID.
Bill Information	Displays additional information about the bill. In addition, this column has a context menu which helps in navigating to other screens in the application. Note: It has a link. On clicking the link, the Bill screen appears with the details of the respective bill.
Bill Amount	Displays the total bill amount.

If you want to dispute a bill with credit/debit balance and all credit/debit line items, you need to select the check box corresponding to the bill and then click the **Add** button in the **Search Results** section. All credit/debit bill segments and adjustments of the bill are added in the **Dispute Details** zone on the **Main** tab. However, if you select a bill (with credit/debit balance) which contains one or more credit/debit line items or if you select a bill (with credit/debit balance) which contains one or more credit/debit line items, the system will not allow you to add the credit/debit line items by directly adding the bill. In such case, you need to individually select the credit/debit bill segments and adjustments of the bill and then add them to the dispute request.

Note:

If a dispute request is currently in progress for a credit/debit bill segment or adjustment of a bill, those bills of the account are not listed in the **Search Bills** zone. In addition, a bill with all credit line items are not listed in the **Search Bills** zone.

Multiple bill of same account can be added to the dispute request. Multiple bill line items of any bill can also be added to the dispute request.

Related Topics

For more information on...	See...
How to add a bill line item to the dispute request	Adding a Bill Line Item to the Dispute Request on page 2060

Bill Line Items

The **Bill Line Items** zone lists the debit and credit bill segments and adjustments of the bill. This zone contains the following columns:

Column Name	Column Description
Entity ID	Displays the bill segment or adjustment ID.
Entity Type	Indicates whether the entity is a bill segment or an adjustment.
Entity Information	Displays additional information about the bill segment or adjustment. If the entity is a bill segment, the context menu appears in the column which helps in navigating to other screens in the application.
	Note: It has a link. If the entity is a bill segment then on clicking the link, the Bill Segment screen appears with the details of the respective bill segment. However, if the entity is an adjustment then on clicking the link, the Adjustment screen appears where you can view the details of the respective adjustment.
Entity Amount	Displays the bill segment or adjustment amount.
Currency	Displays the currency in which the amount is billed.
Contract Information	Displays additional information about the contract against which the bill segment or adjustment is created. In addition, this column has a context menu which helps in navigating to other screens in the application.
	Note: It has a link. On clicking the link, the Contract screen appears where you can view the details of the respective contract.

You can select one or more credit/debit bill segments or adjustments and click the **Add** button in this zone to add selected credit/debit bill segments or adjustments to the dispute request.

By default, the **Bill Line Items** zone does not appear in the **Bills** tab. It appears only when you click the **Broadcast** (📡) icon corresponding to the bill in the **Search Bills** zone.

Related Topics

For more information on...	See...
How to add a bill line item to the dispute request	Adding a Bill Line Item to the Dispute Request on page 2060

Dispute Request - Log

The **Log** tab contains the following zone:

- [Dispute Request Log](#) on page 2049

Dispute Request Log

The **Dispute Request Log** zone lists the complete trail of actions performed on the dispute request. This zone contains the following columns:

Column Name	Column Description
Date/Time	Displays the date and time when the action was performed on the dispute request.
Details	Displays the details about the action performed on the dispute request.
User	Indicates the user who has performed the action on the dispute request.
Log Type	Indicates the type of log.

Column Name	Column Description
Related Object	Indicates the object or entity which is generated when the action is performed on the dispute request.
Status Reason	Displays the status reason of action performed on the dispute request.

Note: You can manually add a log entry for the dispute request by clicking the **Add Log Entry** link in the upper right corner of the **Dispute Request Log** zone.

The **Add Request Log** window appears. Enter **Log Details** and click **Save**. The dispute request log is added.

Related Topics

For more information on...	See...
How to view the log of a dispute request	Viewing the Log of a Dispute Request on page 2062

Editing a Dispute Request

Prerequisites

To edit a dispute request, you should have:

- Adjustment types with A/P request type defined in the application

Procedure

To edit a dispute request:

1. Search for the dispute request in the **Dispute Request** screen.
2. In the **Search Results** section, click the link in the **Dispute Request Information** column corresponding to the dispute request whose details you want to edit.

The **Dispute Request** screen appears.

3. Click the **Edit** button in the **Dispute Request** zone.

The **Dispute Request** screen appears. It contains the following section:

Field Name	Field Description	Mandatory (Yes or No)
Dispute Request Type	Displays information about the dispute request.	Not applicable
Dispute Reason	Used to indicate the dispute requests which are created using a particular dispute reason for the bill.	Yes
Account Information	Indicates the account for which the dispute request is created.	Not applicable
Comments	Used to specify additional information about the dispute request.	No

In addition, this screen contains the following two sections:

- **Characteristics** – Used to define the characteristics for the dispute request. It contains the following fields:

Field Name	Field Description	Mandatory (Yes or No)
Effective Date	Used to specify the date from when the characteristic is effective for the dispute request.	Yes (Conditional)
		Note: This field is required when you are defining a characteristic for the dispute request.
Characteristic Type	Used to indicate the characteristic type.	Yes (Conditional)
	Note: The list includes only those characteristic types where the characteristic entity is set to Dispute Request .	Note: This field is required when you are defining a characteristic for the dispute request.
Characteristic Value	Used to specify the value for the characteristic type.	Yes (Conditional)
	Note: On specifying the value for a predefined characteristic type, the description of the characteristic value appears corresponding to the Characteristic Value field.	Note: This field is required when you are defining a characteristic for the dispute request.

- Modify the details of the dispute request, if required.

Note: If you select a predefined characteristic type, the **Search** (🔍) icon appears corresponding to the **Characteristic Value** field. On clicking the **Search** icon, you can search for a predefined characteristic value.

- Define, edit, or remove characteristics of the dispute request, if required.
- Click **Save**.

The changes made to the dispute request are saved.

Related Topics

For more information on...	See...
How to search for a dispute request	Searching for a Dispute Request on page 2037
Dispute Request screen	Dispute Request (Used for Viewing) on page 2042
Dispute Request zone	Dispute Request on page 2043
How to define a characteristic for a dispute request	Defining a Characteristic for a Dispute Request on page 2041

Deleting a Dispute Request

Procedure

To delete a dispute request:

- Search for the dispute request in the **Dispute Request** screen.
- In the **Search Results** section, click the link in the **Dispute Request Information** column corresponding to the dispute request that you want to delete.

The **Dispute Request** screen appears.

3. Click the **Delete** button in the **Dispute Request** zone.

A message appears confirming whether you want to delete the dispute request.

Note: The **Delete** button appears when the dispute request is in the **Draft** status.

4. Click **OK**.

The dispute request is deleted.

Related Topics

For more information on...	See...
How to search for a dispute request	Searching for a Dispute Request on page 2037
Dispute Request screen	Dispute Request (Used for Viewing) on page 2042
Dispute Request zone	Dispute Request on page 2043

Submitting a Dispute Request

Prerequisites

To submit a dispute request, you should have:

- Credit/debit bill line items added in the dispute request

Procedure

To submit a dispute request:

1. Search for the dispute request in the **Dispute Request** screen.
2. In the **Search Results** section, click the link in the **Dispute Request Information** column corresponding to the dispute request that you want to submit.

The **Dispute Request** screen appears.

3. Click the **Submit** button in the **Dispute Request** zone.

The system behaves in the following manner:

If...	Then
The Approval Required and Hierarchical Approval check boxes are selected in the dispute request type using which the dispute request is created	A To Do of the C1-DSPSB To Do type is created and sent to the approver at the first level in the approval hierarchy, and the status of the dispute request is changed to Approval In Progress .
The Approval Required check box is selected, but the Hierarchical Approval check box is not selected in the dispute request type using which the dispute request is created	A To Do of the C1-DSPSB To Do type is created and sent to the approver at the hierarchy level where the total dispute amount falls within the threshold limit. In addition, the status of the dispute request is changed to Approval In Progress .
The Approval Required check box is not selected in the dispute request type using which the dispute request is created	The dispute adjustments are created using the specified adjustment types and the status of the dispute request is changed to Processed .

Note:

The **Submit** button appears when the dispute request is in the **Draft** status.

Dispute request with atleast one bill or bill line item has to be added for submission.

Related Topics

For more information on...	See...
How to search for a dispute request	Searching for a Dispute Request on page 2037
Dispute Request screen	Dispute Request (Used for Viewing) on page 2042
Dispute Request zone	Dispute Request on page 2043

Approving a Dispute Request

You can view the number of dispute requests which are pending for approval in the **Dispute Request** screen. The approver can review, and accordingly approve or reject the dispute request based on the observations.

Note: The system will not allow you to approve or reject a dispute request submitted by you.

Procedure

To approve a dispute request:

1. Do either of the following:

If you want to	Then
Approve a dispute request through the Dispute Request screen	<ol style="list-style-type: none"> 1. Search for the dispute request in the Dispute Request screen. 2. In the Search Results section, click the link in the Dispute Request Information column corresponding to the dispute request which you want to review.
Approve a dispute request from the To Do List screen	<ol style="list-style-type: none"> 1. Click the Menu link in the Application toolbar. A list appears. 2. From the Main menu, select To Do and then click To Do List. The To Do Type for User Search window appears. 3. Enter C1_DISAP in the To Do Type field. 4. Click the Search button corresponding to the To Do Type field. The To Do List screen appears. 5. Select the Open option from the Filter by list to view all unassigned To Dos.

If you want to	Then
	6. Click the link in the Message column corresponding to the To Do of the dispute request that you want to review.

The **Dispute Request** screen appears.

2. Review the dispute request details.
3. Click the **Approve** button in the **Dispute Request** zone.

The system behaves in the following manner:

If...	Then
The Hierarchical Approval check box is not selected in the dispute request type using which the dispute request is created	The refund adjustments are created using the specified adjustment types and the status of the refund request is changed to Processed .

Note: The **Approve** button appears when:

- The dispute request is in the **Approval In Progress** status.
- A user with the approval To Do role is reviewing the dispute request.

Related Topics

For more information on...	See...
How to search for a dispute request	Searching for a Dispute Request on page 2037
Dispute Request screen	Dispute Request (Used for Viewing) on page 2042
Dispute Request zone	Dispute Request on page 2043

Rejecting a Dispute Request

Prerequisites

To reject a dispute request, you should have:

- Rejection reasons defined in the application

Note:

While rejecting a dispute request, you need to specify the reason why you want to reject the dispute request. You can select the appropriate rejection reason when you have defined the reasons for the **Rejected** status of the **C1-DisputeRequest** business object in the **Status Reason** screen.

The system will not allow you to approve or reject a dispute request submitted by you.

Procedure

To reject a dispute request:

1. Do either of the following:

If you want to	Then
Reject a dispute request through the Dispute Request screen	<ol style="list-style-type: none"> 1. Search for the dispute request in the Dispute Request screen. 2. In the Search Results section, click the link in the Dispute Request Information column corresponding to the dispute request which you want to review.
Reject a dispute request from the To Do List screen	<ol style="list-style-type: none"> 1. Click the Menu link in the Application toolbar. A list appears. 2. From the Main menu, select To Do and then click To Do List. The To Do Type for User Search window appears. 3. Enter C1-DISAP in the To Do Type field. 4. Click the Search button corresponding to the To Do Type field. The To Do List screen appears. 5. Select the Open option from the Filter by list to view all unassigned To Dos. 6. Click the link in the Message column corresponding to the To Do of the dispute request that you want to review.

The **Dispute Request** screen appears.

2. Review the dispute request details.
3. Click the **Reject** button in the **Dispute Request** zone.

The **Reject Dispute Request** window appears. It contains following fields:

Field Name	Field Description	Mandatory (Yes or No)
Status Reason	Used to indicate the reason why you want to reject the dispute request.	Yes
Comments	Used to specify additional information while rejecting the dispute request.	No

Note: The **Reject** button appears when:

- The dispute request is in the **Approval In Progress** status.
- A user with the approval To Do role is reviewing the dispute request.

4. Select the rejection reason from the **Status Reason** list.
5. Click **Save**.

The status of the dispute request is changed to **Rejected**.

Related Topics

For more information on...	See...
How to search for a dispute request	Searching for a Dispute Request on page 2037
Dispute Request screen	Dispute Request (Used for Viewing) on page 2042
Dispute Request zone	Dispute Request on page 2043

Resubmitting a Dispute Request

Prerequisites

To resubmit a dispute request, you should have:

- Entities added in the dispute request which is submitted for approval.

Procedure

To resubmit a dispute request:

1. Search for the dispute request in the **Dispute Request** screen.
2. In the **Search Results** section, click the link in the **Dispute Request Information** column corresponding to the dispute request that you want to resubmit.

The **Dispute Request** screen appears.

3. Click the **Re Submit** button in the **Dispute Request** zone.

The **Resubmit Dispute Request** screen appears.

Note: The **Resubmit** button appears when the dispute request is in the **Approval In Progress** status.

A To Do of the **C1-DSPSB To Do** type is created and sent to the request submitter using the submitter TO DO Role and the status of the dispute request is changed to **Draft**.

4. Enter the comments in the respective field and click **Save**.

Note: While resubmitting, To Do will be sent to the submitter of the request using the submitter To Do Role mapped on the dispute request type and the request will be moved to Draft status. The submitter can do necessary changes and re-submit the request. Log will be maintained when the approver sends the request back to submitter.

Related Topics

For more information on...	See...
How to search for a dispute request	Searching for a Dispute Request on page 2037
Dispute Request screen	Dispute Request (Used for Viewing) on page 2042
Dispute Request zone	Dispute Request on page 2043
How to submit a dispute request	Submitting a Dispute Request on page 2052

Editing the Dispute Details

Prerequisites

To edit the dispute details, you should have:

- Adjustment types with A/P request type defined in the application

Procedure

To edit the dispute details:

1. Search for the dispute request in the **Dispute Request** screen.
2. In the **Search Results** section, click the link in the **Dispute Request Information** column corresponding to the dispute request whose bill line item details you want to edit.

The **Dispute Request** screen appears.

3. Select the bill whose details you want to edit in the **Dispute Details** zone and click the **Edit** button available in the upper left corner of this zone.

The **Edit Dispute Details** screen appears.

Note: A bill line item from the dispute request can be edited when the dispute request is in the **Draft** status.

The **Edit Dispute Details** screen contains the following fields:

Field Name	Field Description	Mandatory (Yes or No)
Dispute Request ID	Displays the dispute request ID.	Not applicable
Account Information	Displays additional information about the account.	Not applicable

In addition to these fields, this screen contains following columns:

Column Name	Column Description
Entity Type	Indicates the entity type. The valid values are <ul style="list-style-type: none"> • Adjustments • Bill • Bill Segment
Entity ID	Displays the entity ID.
Entity Information	Displays the entity information.
Dispute Amount	Indicates the amount that must be disputed.
Currency	Displays the currency in which the entity was created.
Adjustment Type	Displays the adjustment type using which the dispute adjustment must be created.
Stop Auto Pay	Displays whether auto pay needs to be stopped for the entity of the dispute request.

4. Modify the details of the bill line items.
 5. Click **Save**.
- The changes made to the dispute bill line items are saved.

Related Topics

For more information on...	See...
Dispute Request screen	Dispute Request (Used for Viewing) on page 2042
Dispute Request zone	Dispute Request on page 2043

For more information on...	See...
How to search for a dispute request	Searching for a Dispute Request on page 2037

Deleting a Bill from the Dispute Request

Procedure

To delete a bill from the dispute request:

1. Search for the dispute request in the **Dispute Request** screen.
2. In the **Search Results** section, click the link in the **Dispute Request Information** column corresponding to the dispute request whose bill you want to delete.

The **Dispute Request** screen appears.

3. In the **Dispute Details** zone, select the bills and click the **Delete** button available in the upper left corner of this zone.

A message appears confirming whether you want to delete the bill from the dispute request.

Note: You can delete bill from the dispute request when the request is in the **Draft** status.

4. Click **OK**.

The selected bill gets deleted from the dispute request.

Related Topics

For more information on...	See...
Dispute Request screen	Dispute Request (Used for Viewing) on page 2042
Dispute Request zone	Dispute Request on page 2043
How to search for a dispute request	Searching for a Dispute Request on page 2037

Viewing the Bill Line Items

Procedure

To view the bill line items of a dispute request:

1. Search for the dispute request in the **Dispute Request** screen.
2. In the **Search Results** section, click the link in the **Dispute Request Information** column corresponding to the dispute request whose log you want to view.

The **Dispute Request** screen appears. It consists of the following tabs:

- **Main** – Displays information about the dispute request. It contains the following zones:
 - **Dispute Request** – Displays the details of the dispute request.
 - **Dispute Details** – Lists the entities, such as auto payment events, and/or credit bill line items (such as credit bill segments and adjustments), of the account which must be disputed.
 - **Dispute Adjustments** – Displays the adjustment details of dispute request.

Note: This zone appears when you click the Broadcast () icon corresponding to the entity type as **Bill** in the **Dispute Details** zone and when the status is **Processed**.

- **Previous Dispute Requests** – Displays the details of the bill which must be disputed.

Note: This zone appears when you click the Broadcast () icon corresponding to the entity type as **Bill** in the **Dispute Details** zone.

- **Bills** – Used to search bills with credit line items, such as credit bill segments and adjustments, that you want to dispute. It contains the following zones:
 - **Search Bills** – Lists completed bills of the account which are either with credit balance or have one or more credit line items, such as bill segments and adjustments. You can filter the bills using various search criteria.

Note: Filter the bills, if required, in the **Search Bills** zone.

- **Bill Line Items** – Lists the debit and credit bill segments and adjustments of the bill.

Note: This zone appears when you click the Broadcast () icon corresponding to the entity type as **Bill** in the **Search Bills** zone.

This tab appears when the dispute request is in the **Draft** status.

- **Log** – Lists the complete trail of actions performed on the dispute request.

3. View the details of the bill line items in the **Bill Line Items** zone.

Related Topics

For more information on...	See...
How to search for a dispute request	Searching for a Dispute Request on page 2037
Dispute Request screen	Dispute Request (Used for Viewing) on page 2042
Search Bills zone	Search Bills on page 2047
How to add a bill line item to a dispute request	Adding a Bill Line Item to the Dispute Request on page 2060
Bill Line Items zone	Bill Line Items on page 2048

Adding a Bill to the Dispute Request

You can dispute the credit/debit bills to the account.

Prerequisites

To add a credit/debit bill to the dispute request, you should have:

- Completed bills for the account with one or more credit/debit line items

Procedure

To add a credit/debit bill to the dispute request:

1. Click the **Bills** tab in the **Dispute Request** screen.

The **Bills** tab appears.

2. Filter the bills, if required, in the **Search Bills** zone.

Note: If a dispute request is currently in progress for a credit/debit bill segment or adjustment of a bill, those bills of the account are not listed in the **Search Bills** zone.

3. Do either of the following:

If...	Then...
A bill has all credit/debit line items and you want to add the credit/debit bill to the dispute request	<ol style="list-style-type: none"> 1. In the Search Bills zone, select the bills that you want to dispute. 2. Click the Add button available at the upper left corner of the Search Bills zone.
A bill has credit balance and one or more debit line items and you want to add the credit bill to the dispute request	<ol style="list-style-type: none"> 1. In the Search Bills zone, select the bills that you want to dispute. 2. Click the Add button available at the upper left corner of the Search Bills zone.

4. Click **Add**.

A message appears indicating that the selected bills are added to the dispute request.

Note: If you select a bill (with credit balance) which contains one or more debit line items or if you select a bill (with debit balance) which contains one or more credit line items, the system will not allow you to add the credit line items by directly adding the bill. In such case, you need to individually select the credit bill segments and adjustments of the bill and then add them to the dispute request.

5. Click **OK**.

Note that all the credit/debit bill segments or adjustments of the bills are added in the **Dispute Details** zone on the **Main** tab.

Note: Irrespective of whether you select a credit/debit bill, or credit/debit bill segments or adjustments, the credit/debit bill segments or adjustments are added in the **Dispute Details** zone. The credit/debit bill is not added to the **Dispute Details** zone.

Related Topics

For more information on...	See...
How to create a dispute request	Creating a Dispute Request on page 2039

Adding a Bill Line Item to the Dispute Request

You can dispute the credit/debit bill line items, such as bill segments and adjustments, to the account. While adding a credit/debit bill line item to the dispute request, you can either:

- Directly add all credit/debit line items of a bill to the dispute request by adding the bill which has all bill segments and adjustments in credit
- Individually add a credit bill segment or adjustment of a bill (with one or more credit/debit line items) to the dispute request

Prerequisites

To add a credit/debit bill line item to the dispute request, you should have:

- Completed bills for the account with one or more credit/debit line items

Procedure

To add a credit/debit bill line item to the dispute request:



1. Click the **Bills** tab in the **Dispute Request** screen.

The **Bills** tab appears.

- Filter the bills, if required, in the **Search Bills** zone.

Note: If a dispute request is currently in progress for a credit/debit bill segment or adjustment of a bill, those bills of the account are not listed in the **Search Bills** zone. In addition, a bill with all debit line items are not listed in the **Search Bills** zone.

- Do either of the following:

If...	Then...
A bill has all credit line items and you want to add a particular credit bill line item to the dispute request	<ol style="list-style-type: none"> In the Search Bills zone, click the Broadcast  icon corresponding to the bill whose line items you want to view. The Bill Line Items zone appears. Select the check box corresponding to the credit bill segment or adjustment that you want to dispute.
A bill has credit balance and one or more debit line items	<ol style="list-style-type: none"> In the Search Bills zone, click the Broadcast  icon corresponding to the bill whose line items you want to view. The Bill Line Items zone appears. Select the check box corresponding to the credit bill segment or adjustment that you want to dispute.
A bill has debit balance and one or more credit line items	<ol style="list-style-type: none"> In the Search Bills zone, click the Broadcast  icon corresponding to the bill whose line items you want to view. The Bill Line Items zone appears. Select the check box corresponding to the credit bill segment or adjustment that you want to dispute.

- Click **Add**.

A message appears indicating that the selected bill segments or adjustments are added to the dispute request.

Note: If you select a bill (with credit balance) which contains one or more debit line items or if you select a bill (with debit balance) which contains one or more credit line items, the system will not allow you to add the credit line items by directly adding the bill. In such case, you need to individually select the credit bill segments and adjustments of the bill and then add them to the dispute request.

- Click **OK**.

Note that the credit bill segments or adjustments are added in the **Dispute Details** zone on the **Main** tab.

Note:

Irrespective of whether you select a credit/debit bill, or credit/debit bill segments or adjustments, the credit/debit bill segments or adjustments are added in the **Dispute Details** zone. The credit bill is not added to the **Dispute Details** zone.

The system will not allow you to add a debit line item to the **Dispute Details** zone.

Related Topics

For more information on...	See...
How to create a dispute request	Creating a Dispute Request on page 2039

Viewing the Log of a Dispute Request**Procedure**

To view the log of a dispute request:

1. Search for the dispute request in the **Dispute Request** screen.
2. In the **Search Results** section, click the link in the **Dispute Request Information** column corresponding to the dispute request whose log you want to view.

The **Dispute Request** screen appears. It consists of the following tabs:

- **Main** – Displays information about the dispute request. It contains the following zones:
 - **Dispute Request** – Displays the details of the dispute request.
 - **Dispute Details** – Lists the entities, such as auto payment events, and/or credit bill line items (such as credit bill segments and adjustments), of the account which must be disputed.
 - **Dispute Adjustments** – Displays the adjustment details of dispute request.

Note: This zone appears when you click the Broadcast () icon corresponding to the entity type as **Bill** in the **Dispute Details** zone and when the status is **Processed**.

- **Previous Dispute Requests** – Displays the details of the bill which must be disputed.

Note: This zone appears when you click the Broadcast () icon corresponding to the entity type as **Bill** in the **Dispute Details** zone.

- **Bills** – Used to search bills with credit line items, such as credit bill segments and adjustments, that you want to dispute. It contains the following zones:
 - **Search Bills** – Lists completed bills of the account which are either with credit balance or have one or more credit line items, such as bill segments and adjustments. You can filter the bills using various search criteria.
 - **Bill Line Items** – Lists the debit and credit bill segments and adjustments of the bill.

This tab appears when the dispute request is in the **Draft** status.

- **Log** – Lists the complete trail of actions performed on the dispute request.
3. Click the **Log** tab.
 4. View the log of the dispute request in the **Dispute Request Log** zone.

Note: You can manually add a log entry for the dispute request by clicking the **Add Log Entry** link in the upper right corner of the **Dispute Request Log** zone.

Related Topics

For more information on...	See...
How to search for a dispute request	Searching for a Dispute Request on page 2037
How to add a log entry for a dispute request	Adding a Log Entry for a Dispute Request on page 2063
Dispute Request Log zone	Dispute Request Log on page 2049

Adding a Log Entry for a Dispute Request

Procedure

To add a log entry for a dispute request:

1. Search for the dispute request in the **Dispute Request** screen.
2. In the **Search Results** section, click the link in the **Dispute Request Information** column corresponding to the dispute request whose log you want to edit.

The **Dispute Request** screen appears. It consists of the following tabs:

- **Main** – Displays information about the dispute request. It contains the following zones:
 - **Dispute Request** – Displays the details of the dispute request.
 - **Dispute Details** – Lists the entities, such as auto payment events, and/or credit bill line items (such as credit bill segments and adjustments), of the account which must be disputed.
 - **Dispute Adjustments** – Displays the adjustment details of dispute request.

Note: This zone appears when you click the Broadcast () icon corresponding to the entity type as **Bill** in the **Dispute Details** zone and when the status is **Processed**.

- **Previous Dispute Requests** – Displays the details of the bill which must be disputed.

Note: This zone appears when you click the Broadcast () icon corresponding to the entity type as **Bill** in the **Dispute Details** zone.

- **Bills** – Used to search bills with credit line items, such as credit bill segments and adjustments, that you want to dispute. It contains the following zones:
 - **Search Bills** – Lists completed bills of the account which are either with credit balance or have one or more credit line items, such as bill segments and adjustments. You can filter the bills using various search criteria.
 - **Bill Line Items** – Lists the debit and credit bill segments and adjustments of the bill.

This tab appears when the dispute request is in the **Draft** status.

- **Log** – Lists the complete trail of actions performed on the dispute request.
3. Click the **Log** tab.

The **Log** tab appears.
 4. Click the **Add Log Entry** link in the upper right corner of the **Dispute Request Log** zone.

The **Add Request Log** window appears. It contains the following fields:

Field Name	Field Description	Mandatory (Yes or No)
Request Information	Displays information about the dispute request.	Not applicable
Log Details	Used to specify additional comments for the dispute request.	Yes

5. Enter the comments in the **Log Details** field.

6. Click **Save**.

The log entry is added in the **Dispute Request Log** zone.

Related Topics

For more information on...	See...
How to search for a dispute request	Searching for a Dispute Request on page 2037

Chapter

32

Earnings Credit Rate

Topics:

- [Prerequisites](#)
- [Financial Transaction Distribution Object Status Transition](#)
- [Algorithms Used in C1-FTDIST](#)
- [Earnings Credit Rate Eligibility](#)
- [Financial Transaction Distribution Type](#)
- [Financial Transaction Distribution Rule](#)
- [Expiration Cycle Extendable Lookup](#)
- [Extendable Lookup \(Expiration Cycle\)](#)
- [Distribution Hierarchy Extendable Lookup](#)
- [Extendable Lookup \(Distribution Hierarchy\)](#)
- [Financial Transaction Distribution Object Extendable Lookup](#)
- [Extendable Lookup \(Financial Transaction Distribution Object\)](#)
- [Financial Transaction Distribution \(Used for Searching\)](#)
- [Financial Transaction Distribution \(Used for Viewing\)](#)

Oracle Revenue Management and Billing enables you to generate the earnings credit rate (ECR) when the account is eligible for earnings credit rate and is associated with a contract of a contract type where the **Financial Transaction Distribution Object** characteristic is defined. In other words, the system enables you to create the financial transaction distribution (ECR) object when the adjustment and/or bill segment financial transaction created against an ECR contract is frozen. The status of the financial transaction distribution object is set to **Pending**.

To enable the Earnings Credit Rate (ECR) feature, you need to setup the following:

- **Financial Transaction Distribution Type** – A financial transaction distribution type is an object which controls the distribution of a credit and debit bill segment or adjustment financial transaction. It is associated to a contract type through a financial transaction distribution object. It helps the system to determine:
 - Whether it is defined for adjustment or bill segment financial transactions whose credit or debit amount should be distributed.
 - The type of adjustment (such as transfer adjustment) should be created when the credit or debit amount on the financial transaction distribution object is distributed.
 - The financial transaction distribution rule using which the credit or debit amount on the financial transaction distribution object should be distributed.
 - Whether the credit or debit amount on the financial transaction distribution object should be used to offset an adjustment or bill segment of the same account (where ECR is earned), another account of the customer (for whom ECR is earned), or the account identified as per the distribution hierarchy.
 - Whether the credit or debit amount on the financial transaction distribution object should be written off when it is equal to or less than the write off threshold amount.
 - The type of adjustment that should be created when the credit or debit amount on the financial transaction distribution object is written off.
 - The type of adjustment that should be created when the credit or debit amount on the financial transaction distribution object is expired.

- The type of adjustment that should be created when the excess credit amount on the financial transaction distribution object is refunded at the end of the year.
- The business object using which the financial transaction distribution object should be created.
- **Financial Transaction Distribution Rule** – A financial transaction distribution rule is associated with one or more financial transaction distribution types. It helps the system to determine:
 - The method using which the credit or debit amount on the financial transaction distribution object should be distributed. If the distribution method is set to **Fee Based**, the system will distribute the credit or debit amount on the financial transaction distribution object to offset fees starting from the highest to lowest amount. If the distribution method is set to **Priority Based**, the system will distribute the credit or debit amount on the financial transaction distribution object to the accounts in the order of their account distribution priority. If the distribution method is set to **Weighted Average**, the system will distribute the credit or debit amount on the financial transaction distribution object to the accounts in the weighted average ratio.
 - The distribution hierarchy using which the accounts, to which the credit or debit amount on the financial transaction distribution object should be distributed, should be derived.
 - The priority in which the objects, such as adjustments of a particular adjustment type or bill segments created for a particular price item, should be offset using the credit or debit amount on the financial transaction distribution object.
 - The objects, such as adjustments of a particular adjustment type or bill segments created for a particular price item, should be excluded from offsetting.
 - Algorithms that should be used to select the accounts, interpret the order of distribution, and then distribute the credit or debit amount.
- **Expiration Cycle** – An expiration cycle is an extendable lookup reference object which indicates the frequency at which the financial transaction distribution object created for the account should be expired (i.e. after two months or 45 days from the date of creation). You can associate an expiration cycle with one or more accounts.
- **Distribution Hierarchy** – A distribution hierarchy is an extendable lookup reference object which indicates the list of hierarchies that should be considered while deriving accounts for offsetting the credit or debit amount on the financial transaction distribution object. The valid hierarchy lists are:
 - **IGA Member Accounts Same Division** – If this option is selected, the system will first offset the credit or debit amount on the financial transaction distribution object against the source account, other accounts of the source customer, and then against other member accounts of an invoicing group in which the source account is also a member account.
 - **Person Relationship (Child) Same Division** – If this option is selected, the system will first offset the credit or debit amount on the

financial transaction distribution object against the source account, other accounts of the source customer, and then against the child persons' accounts who are related to the parent person (i.e. source customer) using a particular relationship type and belongs to the same division.

- **Person Relationship (Child) Other Division** – If this option is selected, the system will first offset the credit or debit amount on the financial transaction distribution object against the source account, other accounts of the source customer, and then against the child persons' accounts who are related to the parent person (i.e. source customer) using a particular relationship type and belongs to a different division.
- **Person Relationship (Parent) Same Division** – If this option is selected, the system will first offset the credit or debit amount on the financial transaction distribution object against the source account, other accounts of the source customer, and then against the parent persons' accounts who are related to the child person (i.e. source customer) using a particular relationship type and belongs to the same division.
- **Person Relationship (Parent) Other Division** – If this option is selected, the system will first offset the credit or debit amount on the financial transaction distribution object against the source account, other accounts of the source customer, and then against the parent persons' accounts who are related to the child person (i.e. source customer) using a particular relationship type and belongs to a different division.

You can associate a distribution hierarchy with one or more financial transaction distribution rules.

- **Financial Transaction Distribution Object** – A financial transaction distribution type is associated to a contract type through a financial transaction distribution object. You can include multiple financial transaction distribution types in a financial transaction distribution object. You can associate a financial transaction distribution object to one or more contract types.
- **Earnings Credit Rate Eligibility** – You can define earnings credit rate eligibility for each account in the system. It helps the system to determine:
 - Whether the account is eligible for generating earnings credit rate (i.e. financial transaction distribution object).
 - Whether the credit or debit amount on the financial transaction distribution object can be offset against the source account, other accounts of the source customer, or against the accounts identified in the distribution hierarchy.
 - The priority in which the account should be considered while distributing the credit or debit amount on the financial transaction distribution object.
 - The expiration cycle for the account.

The following two batches are introduced in this release:

- **Financial Transaction Distribution Monitor (C1-FTDPR)** – It is used to monitor or check whether there are any financial transaction distribution objects in the Pending status. If there is a financial transaction

distribution object in the Pending status, the system validates the financial transaction distribution object and changes the status of the financial transaction distribution object to Validated. From the Validated status, the status of the financial transaction distribution object is changed to either of the following:

- **Refund** (when there is excess credit amount on the financial transaction distribution object at the end of the year and the source account belongs to a particular customer class where refund is allowed).
- **Write Off** (when the credit or debit amount on the financial transaction distribution object is equal to or less than the write off threshold amount)
- **Expire** (when the credit or debit amount on the financial transaction distribution object is expired)

Accordingly, the refund, write off, and expire adjustments are created. However, if none of the above conditions are met, the status of the financial transaction distribution object remains as **Validated**.

- **FT Distribution Single Threaded Transition Batch (C1-FTDTS)** – It is used to monitor or check whether there are any financial transaction distribution objects in the Validated status. If there is a financial transaction distribution object in the Validated status, the system changes the status of the financial transaction distribution object to **Apply Rule** and executes the algorithm attached to the **Apply Rule** system event on the financial transaction distribution rule version which is effective on the batch business date. Once the credit or debit distribution array of accounts is created, the status of the financial transaction distribution object is changed to **Distributed** and then the algorithm attached to the Distribute system event on the financial transaction distribution rule version which is effective on the batch business date is executed. On the credit or debit amount distribution, two adjustments are created – one against the source contract and another against the bill segment or adjustment's contract to which the amount is distributed. Once the credit or debit amount on the financial transaction distribution object is fully distributed, the status of the financial transaction distribution object is changed to **Complete**. However, if the credit or debit amount on the financial transaction distribution object is not yet fully distributed, the status of the financial transaction distribution object is changed to **Validated**.

Prerequisites

To setup the earnings credit rate process, you need to do the following:

- Add the earnings credit rate to the eligible accounts.
- Define the required financial transaction distribution types in the system.
- Define the required financial transaction distribution rules in the system.
- Define the following extendable lookup reference objects in the system:
 - Expiration Cycle
 - Distribution Hierarchy
 - Financial transaction distribution object

Financial Transaction Distribution Object Status Transition

The following figure graphically indicates how a financial transaction distribution object is created in the system:

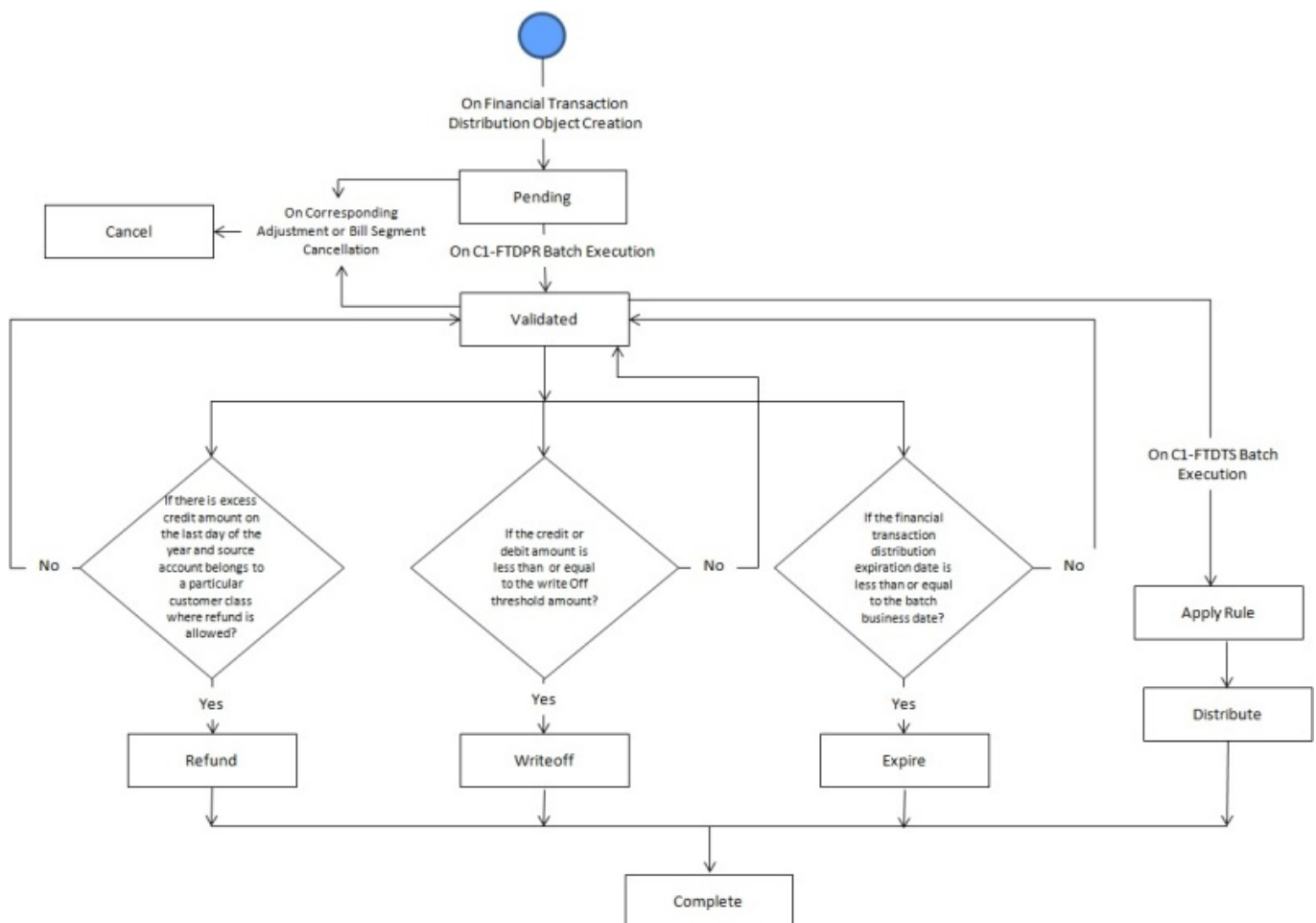

Note: For more information about the batches, refer *Oracle Revenue Management and Billing Batch Guide*.

Algorithms Used in C1-FTDIST

The following table lists the algorithms which are attached to the **C1-FTDIST** business object:

System Event	Algorithm	Algorithm Type	Description																																
Information	C1-FTDISTINF	C1-FTDISTINF	<p>This algorithm formats the FT Distribution that appears throughout the system. It concatenates the fields and separator specified as algorithm parameters. Possible fields are:</p> <table border="1"> <thead> <tr> <th>Field</th> <th>Description</th> </tr> </thead> <tbody> <tr> <td>ACCT_ID</td> <td>Account ID</td> </tr> <tr> <td>ADJ_ID</td> <td>Adjustment ID</td> </tr> <tr> <td>BO_STATUS_CD</td> <td>Status</td> </tr> <tr> <td>BO_STATUS_REASON_CD</td> <td>Status Reason</td> </tr> <tr> <td>BSEG_ID</td> <td>Bill Segment ID</td> </tr> <tr> <td>BUS_OBJ_CD</td> <td>Business Object</td> </tr> <tr> <td>CRE_DTTM</td> <td>Creation Date/Time</td> </tr> <tr> <td>EXPIRATION_DT</td> <td>Expiration Date</td> </tr> <tr> <td>FT_DISTRIBUTION_ID</td> <td>FT Distribution</td> </tr> <tr> <td>FT_DIST_TYPE_CD</td> <td>FT Distribution Type</td> </tr> <tr> <td>FT_ID</td> <td>FT ID</td> </tr> <tr> <td>ILM_DT</td> <td>ILM Date</td> </tr> <tr> <td>SA_ID</td> <td>SA ID</td> </tr> <tr> <td>STATUS_UPD_DTTM</td> <td>Status Update Date/Time</td> </tr> <tr> <td>TOT_AMT</td> <td>Payoff Amount</td> </tr> </tbody> </table>	Field	Description	ACCT_ID	Account ID	ADJ_ID	Adjustment ID	BO_STATUS_CD	Status	BO_STATUS_REASON_CD	Status Reason	BSEG_ID	Bill Segment ID	BUS_OBJ_CD	Business Object	CRE_DTTM	Creation Date/Time	EXPIRATION_DT	Expiration Date	FT_DISTRIBUTION_ID	FT Distribution	FT_DIST_TYPE_CD	FT Distribution Type	FT_ID	FT ID	ILM_DT	ILM Date	SA_ID	SA ID	STATUS_UPD_DTTM	Status Update Date/Time	TOT_AMT	Payoff Amount
Field	Description																																		
ACCT_ID	Account ID																																		
ADJ_ID	Adjustment ID																																		
BO_STATUS_CD	Status																																		
BO_STATUS_REASON_CD	Status Reason																																		
BSEG_ID	Bill Segment ID																																		
BUS_OBJ_CD	Business Object																																		
CRE_DTTM	Creation Date/Time																																		
EXPIRATION_DT	Expiration Date																																		
FT_DISTRIBUTION_ID	FT Distribution																																		
FT_DIST_TYPE_CD	FT Distribution Type																																		
FT_ID	FT ID																																		
ILM_DT	ILM Date																																		
SA_ID	SA ID																																		
STATUS_UPD_DTTM	Status Update Date/Time																																		
TOT_AMT	Payoff Amount																																		
Validation	C1-VALFTDIST	C1-VALFTDIST	<p>This algorithm validates the Business Object - Financial Transaction Distribution, which includes:</p> <ul style="list-style-type: none"> Adjustment ID or Bill Segment ID must be supplied. 																																

The following table lists the algorithms which are used in the lifecycle of the **C1-FTDIST** business object:

Status	System Event	Algorithm	Algorithm Type	Description
In Progress	Monitor	F1-AT-RQJ	F1-GEN-BOMNJ	This algorithm type transitions business object current state to the input Next Status or to the status related to the input Next Transition

Status	System Event	Algorithm	Algorithm Type	Description
				Condition. Either one but not both soft parameters may be specified. If both soft parameters are not specified, the business object will be transitioned to the default next status specified on lifecycle. Algorithms of this algorithm type may be defined for any business object status as its monitor algorithm.
Validate	Monitor	C1-FTDVALIDT	C1-FTDVALIDT	<p>This algorithm transitions the FT Distribution record from validate to any of the following statuses based on certain conditions:</p> <ul style="list-style-type: none"> • It transitions to Expire status (based on Parameter Expire Status Transition Condition) when the credit is not fully distributed and process date is before or on the same day as the Expiration Date defined in the record. • It transitions to Write Off status (based on Parameter Write Off Status Transition Condition) when the Total Amount is less than or equal to the Write Off Threshold defined in the FT Distribution Type linked to the record. It also uses Parameter Handle Negative or Positive for Write Off. If the Parameter is Negative and the Payoff Amount of the record is negative or the Parameter is Positive and the Payoff Amount of the record is positive, then proceed with Write Off. • It transitions to Refund status (based on Parameter Refund Status Transition Condition) when the Parameter Refund at End of Year is Y and the record's source account's customer class is equal to Parameter Applicable Customer Class for Refund. If none of the conditions are met, the record remains at Validate status.

Status	System Event	Algorithm	Algorithm Type	Description
				If none of the conditions are met, the record remains at Validate status.
Apply Rule	Monitor	F1-AT-RQJ	F1-GEN-BOMNJ	This algorithm type transitions business object current state to the input Next Status or to the status related to the input Next Transition Condition. Either of the one soft parameters may be specified. If both the soft parameters are not specified, the business object will be transitioned to the default next status specified on lifecycle. Algorithms of this algorithm type may be defined for any business object status as its monitor algorithm.
Apply Rule	Enter	C1-FTDAPRL	C1-FTDAPRL	This algorithm will call the pre-processing and apply rule algorithms that are configured in the effective rule version of the FT Distribution Rule of the Financial Transaction Distribution record's FT Distribution Type.
Distributed	Enter	C1-FTDDIST	C1-FTDDIST	This algorithm will trigger the distribute algorithms configured in the effective rule version of the FT Distribution Rule linked to the FT Distribution Type of the Financial Transaction Distribution record. After invoking the algorithms, the FT Distribution amount is compared to the sum of the distribution amounts with frozen transfer adjustments in the list. If the amounts are equal, the FT Distribution record is transitioned to Complete (based on the Parameter Complete Status Transition Condition). Otherwise, it is transitioned back to Validate (based on the Validate Status Transition Condition).
Expire	Monitor	F1-AT-RQJ	F1-GEN-BOMNJ	This algorithm type transitions business object current state to the input Next Status or to the status related to the input Next Transition Condition. Either one but not both soft parameters may be specified. If both soft parameters are not specified, the business object will be transitioned to the default next status specified on lifecycle. Algorithms of this algorithm type may be defined

Status	System Event	Algorithm	Algorithm Type	Description
				for any business object status as its monitor algorithm.
Expire	Enter	C1-FTDEXP	C1-FTDEXP	This algorithm expires credit amount by creating an expiration adjustment defined in the FT Distribution Type. The Expiration Adjustment created will have a characteristic of type Parameter Financial Transaction Distribution Characteristic Type and value equal to the FT Distribution ID. The FT Distribution record will have a characteristic of type Write off Adjustment with value equal to the Expiration Adjustment ID.
Refund	Monitor	F1-AT-RQJ	F1-GEN-BOMNJ	This algorithm type transitions business object current state to the input Next Status or to the status related to the input Next Transition Condition. Either of the one soft parameters may be specified. If both the soft parameters are not specified, the business object will be transitioned to the default next status specified on lifecycle. Algorithms of this algorithm type may be defined for any business object status as its monitor algorithm.
Refund	Enter	C1-FTDREFUND	C1-FTDREFUND	This algorithm refunds the credit amount by creating a refund adjustment defined in the FT Distribution Type. The Refund Adjustment will be linked to the Refund Contract (with type equal to Parameter Refund Contract Type) attached to the source Account of the FT Distribution. The Refund Adjustment will be linked to the FT Distribution via a characteristic with type Parameter Financial Transaction Distribution Characteristic Type. Also, the FT Distribution record will have a characteristic of type Refund Adjustment with value equal to the Refund Adjustment ID.
Write Off	Monitor	F1-AT-RQJ	F1-GEN-BOMNJ	This algorithm type transitions business object current state to the input Next Status or to the status related to the input Next Transition Condition. Either one but not both soft parameters may be specified. If both soft parameters are not

Status	System Event	Algorithm	Algorithm Type	Description
				specified, the business object will be transitioned to the default next status specified on lifecycle. Algorithms of this algorithm type may be defined for any business object status as its monitor algorithm.
Write Off	Enter	C1-FTDWRTOFF	C1-FTDWRTOFF	This algorithm writes off the credit amount by creating a write off adjustment defined in the FT Distribution Type. The Write off Adjustment created will have a characteristic of type Parameter Financial Transaction Distribution Characteristic Type and value equal to the FT Distribution ID. The FT Distribution record will have a characteristic of type Write Off Adjustment with value equal to the Write Off Adjustment ID.
Cancel	Enter	C1-FTDCANCEL	C1-FTDCANCEL	This algorithm will cancel all the transfer adjustments listed in the Financial Transaction Distribution record's Distribution List. The cancel reason code will be copied or taken from the original Distribution Object's cancel reason. If it is not provided, it will use the parameter Default Cancel Reason.
Complete	Enter	C1-FTDCOMP	C1-FTDCOMP	This algorithm will trigger the post-processing algorithms configured in the effective rule version of the FT Distribution Rule linked to the FT Distribution Type of the Financial Transaction Distribution record.

Earnings Credit Rate Eligibility

This screen allows you to add earnings credit rate eligibility for each account in the system and helps you to determine the following:

- Whether the account is eligible for generating earnings credit rate (i.e. financial transaction distribution object).
- Whether the credit or debit amount on the financial transaction distribution object can be offset against the source account, other accounts of the source customer, or against the accounts identified in the distribution hierarchy.
- The priority in which the account should be considered while distributing the credit or debit amount on the financial transaction distribution object.
- The expiration cycle for the account.

This screen contains the following zone:

- [Earnings Credit Rate Eligibility](#) on page 2075

Earnings Credit Rate Eligibility

The **Earnings Credit Rate Eligibility** zone allows you to add earnings credit rate eligibility for each account in the system.

This zone contains the following fields:

Field Name	Field Description	Mandatory (Yes or No)
Earnings Credit Rate ID	Displays the earnings credit rate ID.	Not applicable
Account ID	Used to search for a particular account. Note: The Search (🔍) icon appears corresponding to this field. On clicking the Search icon, the Account Search window appears.	Yes
Earnings Credit Rate Eligible	Used to define whether an earned credit rate can be calculated and created for the account or not.	No
Offset Eligibility	Used to define whether the credit or debit amount on the financial transaction distribution object can be offset against the source account, other accounts of the source customer, or against the accounts identified in the distribution hierarchy.	No
Offset Distribution Type	Used to search the financial transaction distribution type which would be used to offset the credit or debit amount from another account. If this field is left blank, then the financial transaction distribution type for the earning credit rate source account will be used. Note: This field is enabled when the Offset Eligibility check box is selected. This field is enabled when the Offset Eligibility check box is selected. The Search (🔍) icon appears corresponding to this field. On clicking the Search icon, the Financial Transaction Offset Distribution Type FK Search window appears.	No
Account Distribution Priority	Used to indicate the priority in which the account should be considered while distributing the credit or debit amount on the financial transaction distribution object.	No
Expiration Cycle	Used to indicate the expiration cycle for the account.	Yes

Related Topics

For more information on...	See...
How to define earnings credit rate eligibility for an account	Defining Earnings Credit Rate Eligibility for an Account on page 2076

Defining Earnings Credit Rate Eligibility for an Account

Prerequisites

To define an earnings credit rate eligibility for an account, you should have:

- Accounts defined in the application.
- Expiration cycle defined in the application.
- Financial transaction distribution type defined in the application.

Procedure

To define earnings credit rate eligibility for an account:

1. Click the **Menu** link in the **Application** toolbar.

A list appears.

2. From the **Main** menu, select **Customer Management** and then click **Earnings Credit Rate Eligibility**.

The **Earnings Credit Rate Eligibility** screen appears. It contains the following section:

- **Main** – Used to add the basic details about the earnings credit rate eligibility for an account. This section contains the following fields:

Field Name	Field Description	Mandatory (Yes or No)
Earnings Credit Rate ID	Displays the earnings credit rate ID.	Not applicable
Account ID	Used to search for a particular account. Note: The Search (🔍) icon appears corresponding to this field. On clicking the Search icon, the Account Search window appears.	Yes
Earnings Credit Rate Eligible	Used to define whether an earned credit rate can be calculated and created for the account or not.	No
Offset Eligibility	Used to define whether the credit or debit amount on the financial transaction distribution object can be offset against the source account, other accounts of the source customer, or against the accounts identified in the distribution hierarchy.	No
Offset Distribution Type	Used to search the financial transaction distribution type which would be used to offset the credit or debit amount from another account. If this field is left blank, then the financial transaction distribution type for the earning credit rate source account will be used.	No

Field Name	Field Description	Mandatory (Yes or No)
	<p>Note:</p> <p>This field is enabled when the Offset Eligibility check box is selected. This field is enabled when the Offset Eligibility check box is selected.</p> <p>The Search (🔍) icon appears corresponding to this field. On clicking the Search icon, the Financial Transaction Offset Distribution Type FK Search window appears.</p>	
Account Distribution Priority	Used to indicate the priority in which the account should be considered while distributing the credit or debit amount on the financial transaction distribution object.	No
Expiration Cycle	Used to indicate the expiration cycle for the account.	Yes

3. Enter the required details.

4. Click **Save**.

The earnings credit rate eligibility is defined for the account.

Related Topics

For more information on...	See...
Earnings Credit Rate Eligibility screen	Earnings Credit Rate Eligibility on page 2074

Financial Transaction Distribution Type

The **Financial Transaction Distribution Type** screen allows you to define, edit, copy, and delete a financial transaction distribution object type.

This screen contains the following zones:

- [Financial Transaction Distribution Type List](#) on page 2077
- [Financial Transaction Distribution Type](#) on page 2078

Financial Transaction Distribution Type List

The **Financial Transaction Distribution Type List** zone allows you to view the list of financial transaction distribution types that are already defined in the system.

This zone contains the following columns:

Column Name	Column Description
FT Distribution Type	Displays the financial transaction distribution type.
Description	Displays the description of the financial transaction distribution type.

Column Name	Column Description
	Note: It has a link. On clicking the link, the Financial Transaction Distribution Type zone appears with the details of the respective financial transaction distribution type.
Related Transaction BO	Displays the corresponding transaction business object. In addition, this column has a context menu which helps in navigating to other screens in the application. Note: It has a link. On clicking the link, the Business Object screen appears with the details of the respective business object.
FT Adjustment Type	Displays the adjustment type used in the financial transaction adjustment.
Distribution Object Type	Displays the financial transaction object type used in distributing the credit.
Edit	On clicking the Edit (✎) icon, the FT Distribution Type screen appears where you can edit the details of the financial transaction distribution type.
Duplicate	On clicking the Duplicate (📄) icon, the FT Distribution Type screen appears where you can define a financial transaction distribution type using an existing financial transaction distribution type.
Delete	On clicking the Delete (🗑) icon, you can delete the financial transaction distribution type.

On clicking the **Broadcast** (📡) icon corresponding to the financial transaction distribution type, the **Financial Transaction Distribution Type** zone appears with the details of the respective financial transaction distribution type.

You can filter the list using the **Financial Transaction Distribution Type**, **Description**, or **Financial Transaction Object Type** fields available in the **Filter** area. By default, the **Filter** area is hidden. You can view the **Filter** area by clicking the **Filters** (🔍) icon in the upper right corner of this zone.

Related Topics

For more information on...	See...
Financial Transaction Distribution Type zone	Financial Transaction Distribution Type on page 2078
How to define a financial transaction distribution type	Defining a Financial Transaction Distribution Type on page 2081
How to edit a financial transaction distribution type	Editing a Financial Transaction Distribution Type on page 2085
How to copy a financial transaction distribution type	Copying a Financial Transaction Distribution Type on page 2088
How to delete a financial transaction distribution type	Deleting a Financial Transaction Distribution Type on page 2087
How to view the details of a financial transaction distribution type	Viewing the Financial Transaction Distribution Type Details on page 2091

Financial Transaction Distribution Type

The **Financial Transaction Distribution Type** zone displays the details of the financial transaction distribution types that are already defined in the system. This zone contains the following sections:

- **Main** – This section provides basic information about the financial transaction distribution type. It contains the following fields:

Field Name	Field Description
FT Distribution Type	Displays the financial transaction distribution type.
Description	Displays the description of the financial transaction distribution type.
FT Object Type	Indicates the business object that will be used to create the financial transaction distribution type. Note: It has a link. On clicking the link, the Business Object screen appears where you can view the details of the respective business object.
FT Adjustment Type	Displays the adjustment type used in the financial transaction adjustment.
Distribution Object Type	Displays the financial transaction object type used in distributing the credit.
Distribution Adjustment Type	Displays the adjustment type which is used for distribution if the Transfer Adjustment option is selected from the Distribution Object Type list. Note: It has a link. On clicking the link, the Adjustment Type screen appears where you can view the details of the respective adjustment type.
FT Distribution Rule	Displays the financial transaction distribution rule to be used for distributing the credit or debit in an account. Note: It has a link. On clicking the link, the Financial Transaction Distribution Rule screen appears where you can view the details of the respective financial transaction distribution rule.
Write Off Threshold Amount	Displays the minimum credit amount for write off. Any amount specified in this field is assumed to be negative. For example, a value of "2" is treated as "-2". Such that if the credit is only "-2", then this will be written off instead of distributing it to offset.
Write Off Adjustment Type	Displays the adjustment type used for write off. Note: It has a link. On clicking the link, the Adjustment Type screen appears where you can view the details of the respective adjustment type.
Expiration Adjustment Type	Displays the adjustment type used for expiration. Note: It has a link. On clicking the link, the Adjustment Type screen appears where you can view the details of the respective adjustment type.

Field Name	Field Description
Refund Adjustment Type	Displays the adjustment type used for refund.
	Note: It has a link. On clicking the link, the Adjustment Type screen appears where you can view the details of the respective adjustment type.
Offset Indicator	Displays whether the financial transaction distribution type is applicable when an account in a hierarchy is using an excess credit from the account credit source to offset its own debt or not.
Related Transaction BO	Displays the object using which financial transaction object is created. In addition, this column has a context menu which helps in navigating to other screens in the application.
	Note: It has a link. On clicking the link, the Business Object screen appears where you can view the details of the respective business object.

- **Characteristics** – This section lists the characteristics of the financial transaction distribution type. It contains the following columns:

Column Name	Column Description
Characteristic Type	Indicates the characteristic type.
Characteristic Value	Displays the value of the characteristic type.

- **Record Actions** – This section contains the following buttons:

Button Name	Button Description
Edit	Used to edit the details of the financial transaction distribution type.
Delete	Used to delete the financial transaction distribution type.
Duplicate	Used to create a new financial transaction distribution type using an existing financial transaction distribution type.

- **Record Information** – This section contains the following fields:

Field Name	Field Description
Business Object	Indicates the business object using which the financial transaction distribution type is created. In addition, a context menu appears corresponding to this field which helps in navigating to other screens in the application.
	Note: It has a link. On clicking the link, the Business Object screen appears where you can view the details of the respective business object.

By default, the **Financial Transaction Distribution Type** zone does not appear in the **Financial Transaction Distribution Type** screen. It appears when you click the **Broadcast** () icon corresponding to the financial transaction distribution type in the **Financial Transaction Distribution Type List** zone.

Related Topics

For more information on...	See...
How to define a financial transaction distribution type	Defining a Financial Transaction Distribution Type on page 2081
How to edit a financial transaction distribution type	Editing a Financial Transaction Distribution Type on page 2085
How to copy a financial transaction distribution type	Copying a Financial Transaction Distribution Type on page 2088
How to delete a financial transaction distribution type	Deleting a Financial Transaction Distribution Type on page 2087
How to view the details of a financial transaction distribution type	Viewing the Financial Transaction Distribution Type Details on page 2091

Defining a Financial Transaction Distribution Type

Prerequisites

To define a financial transaction distribution type, you should have:

- Financial transaction distribution objects defined in the application.
- Adjustment types defined in the application.
- Financial transaction distribution rule defined in the application.
- Required characteristics defined in the application.

Procedure

To define a financial transaction distribution type:

1. Click the **Admin** link in the **Application** toolbar.
A list appears.
2. From the **Admin** menu, select **F** and then click **Financial Transaction Distribution Type**.
A sub-menu appears.
3. Click the **Add** option from the **Financial Transaction Distribution Type** sub-menu.

The **Financial Transaction Distribution Type** screen appears. It contains the following sections:

- **Main** – Used to specify basic details of the financial transaction distribution type.
- **Characteristics** – Used to define the characteristics for the financial transaction distribution type.

Main – This section contains the following fields:

Field Name	Field Description	Mandatory (Yes or No)
Financial Transaction Distribution Type	Used to specify the financial transaction distribution type.	Yes
Description	Used to specify the description of the financial transaction distribution type.	Yes
FT Object Type	Used to indicate the business object that will be used to create the financial transaction distribution type. The valid values are: <ul style="list-style-type: none"> • Adjustment 	Yes

Field Name	Field Description	Mandatory (Yes or No)
	<ul style="list-style-type: none"> Bill Segment 	
FT Adjustment Type	Used to indicate the adjustment type used in the financial transaction adjustment.	Yes (Conditional)
	Note: By default, this field is disabled. This field gets enabled when you select Adjustment option from the FT Object Type list.	Note: This field is required when you are selecting the Adjustment option for the FT Object Type list.
Distribution Object Type	Used to indicate the financial transaction object type used in distribution.	Yes
Distribution Adjustment Type	Used to indicate the adjustment type which is used for distribution if the Transfer Adjustment option is selected from the Distribution Object Type list.	No
FT Distribution Rule	Used to indicate the financial transaction distribution rule to be used for distributing the credit or debit in an account.	No
	Note: The Search (🔍) icon appears corresponding to this field. On clicking the Search icon, the Financial Transaction Offset Distribution Type FK Search window appears.	
Offset Indicator	Used to indicate whether the financial transaction distribution type is applicable when an account in a hierarchy is using an excess credit from the account credit source to offset its own debt or not.	No
Write Off Threshold Amount	Used to specify the minimum credit amount for write off.	Yes (Conditional)
		Note: This field is required when you do not check the Offset Indicator check box.
Write Off Adjustment Type	Used to indicate the adjustment type used for write off.	Yes (Conditional)
		Note: This field is required when you do not check the Offset Indicator check box.
	Note: The Search (🔍) icon appears corresponding to this field. On clicking the Search icon, the Adjustment Type Search window appears.	

Field Name	Field Description	Mandatory (Yes or No)
Expiration Adjustment Type	Used to indicate the adjustment type used for expiration.	Yes (Conditional)
	Note: The Search (🔍) icon appears corresponding to this field. On clicking the Search icon, the Adjustment Type Search window appears.	Note: This field is required when you do not check the Offset Indicator check box.
Refund Adjustment Type	Used to indicate the adjustment type used for refund.	Yes (Conditional)
	Note: The Search (🔍) icon appears corresponding to this field. On clicking the Search icon, the Adjustment Type Search window appears.	Note: This field is required when you do not check the Offset Indicator check box.
Related Transaction BO	Used to indicate the object using which financial transaction object is created.	Yes
	Note: The Search (🔍) icon appears corresponding to this field. On clicking the Search icon, the Financial Transaction Business Object Search window appears.	

Characteristics – This section contains the following columns:

Column Name	Column Description	Mandatory (Yes or No)
Characteristic Type	Used to indicate the characteristic type.	Yes (Conditional)
		Note: This field is required when you are defining a characteristic for the financial transaction distribution type.
Characteristic Value	Used to specify the value for the characteristic type.	Yes (Conditional)
	Note: On specifying the value for a predefined characteristic type, the description of the characteristic value appears corresponding to the Characteristic Value field.	Note: This field is required when you are defining a characteristic for the financial transaction distribution type.

Tip: Alternatively, you can access the **Financial Transaction Distribution Type** screen by clicking the **Add** button in the **Page Title** area of the **Financial Transaction Distribution Type** screen.

4. Enter the required details.
5. Define characteristics for the financial transaction distribution type, if required.
6. Click **Save**.

The financial transaction distribution type is defined.

Related Topics

For more information on...	See...
Financial Transaction Distribution Type screen	Financial Transaction Distribution Type on page 2077
How to define a characteristic for a financial transaction distribution type	Defining a Characteristic for a Financial Transaction Distribution Type on page 2084

Defining a Characteristic for a Financial Transaction Distribution Type**Procedure**

To define a characteristic for a financial transaction distribution type:

1. Ensure that the **Characteristics** section is expanded when you are defining, editing, or copying a financial transaction distribution type.

The **Characteristics** section contains the following fields:

Field Name	Field Description	Mandatory (Yes or No)
Characteristic Type	Used to indicate the characteristic type.	Yes (Conditional) Note: This field is required when you are defining a characteristic for the financial transaction distribution type.
Characteristic Value	Used to specify the value for the characteristic type. Note: On specifying the value for a predefined characteristic type, the description of the characteristic value appears corresponding to the Characteristic Value field.	Yes (Conditional) Note: This field is required when you are defining a characteristic for the financial transaction distribution type.

2. Enter the required details.

Note: If you select a predefined characteristic type, the **Search** (🔍) icon appears corresponding to the **Characteristic Value** field. On clicking the **Search** icon, you can search for a predefined characteristic value.

3. If you want to define more than one characteristic for the financial transaction distribution type, click the **Add** (+) icon and then repeat step 2.

Note: However, if you want to remove a characteristic from the financial transaction distribution type, click the **Delete** (🗑️) icon corresponding to the characteristic.

Related Topics

For more information on...	See...
How to define a financial transaction distribution type	Defining a Financial Transaction Distribution Type on page 2081

For more information on...	See...
How to edit a financial transaction distribution type	Editing a Financial Transaction Distribution Type on page 2085
How to copy a financial transaction distribution type	Copying a Financial Transaction Distribution Type on page 2088

Editing a Financial Transaction Distribution Type

Procedure

To edit a financial transaction distribution type:

1. Click the **Admin** link in the **Application** toolbar.
A list appears.
2. From the **Admin** menu, select **F** and then click **Financial Transaction Distribution Type**.
A sub-menu appears.
3. Click the **Search** option from the **Financial Transaction Distribution Type** sub-menu.
The **Financial Transaction Distribution Type** screen appears.
4. In the **Financial Transaction Distribution Type List** zone, click the **Edit** (✎) icon in the **Edit** column corresponding to the financial transaction distribution type whose details you want to edit.

The **FT Distribution Type** screen appears. It contains the following sections:

- **Main** — Used to specify basic details about the financial transaction distribution type.
- **Characteristics** — Used to define the characteristics for the financial transaction distribution type.

The **Main** section contains the following fields:

Field Name	Field Description	Mandatory (Yes or No)
Financial Transaction Distribution Type	Used to specify the financial transaction distribution type.	Yes
Description	Used to specify the description of the financial transaction distribution type.	Yes
FT Object Type	Used to indicate the business object that will be used to create the financial transaction distribution type. The valid values are: <ul style="list-style-type: none"> • Adjustment • Bill Segment 	Yes
FT Adjustment Type	Used to indicate the adjustment type used in the financial transaction adjustment.	Yes (Conditional)
	Note: By default, this field is disabled. This field gets enabled when you select Adjustment option from the FT Object Type list.	Note: This field is required when you are selecting the Adjustment option for the FT Object Type list.

Field Name	Field Description	Mandatory (Yes or No)
Distribution Object Type	Used to indicate the financial transaction object type used in distribution.	Yes
Distribution Adjustment Type	Used to indicate the adjustment type which is used for distribution if the Transfer Adjustment option is selected from the Distribution Object Type list.	No
FT Distribution Rule	Used to indicate the financial transaction distribution rule to be used for distributing the credit or debit in an account.	No
	Note: The Search (🔍) icon appears corresponding to this field. On clicking the Search icon, the Financial Transaction Offset Distribution Type FK Search window appears.	
Offset Indicator	Used to indicate whether the financial transaction distribution type is applicable when an account in a hierarchy is using an excess credit from the account credit source to offset its own debt or not.	No
Write Off Threshold Amount	Used to specify the minimum credit amount for write off.	Yes (Conditional)
		Note: This field is required when you do not check the Offset Indicator check box.
Write Off Adjustment Type	Used to indicate the adjustment type used for write off.	Yes (Conditional)
		Note: This field is required when you do not check the Offset Indicator check box.
Expiration Adjustment Type	Used to indicate the adjustment type used for expiration.	Yes (Conditional)
		Note: This field is required when you do not check the Offset Indicator check box.
Refund Adjustment Type	Used to indicate the adjustment type used for refund.	Yes (Conditional)

Field Name	Field Description	Mandatory (Yes or No)
	Note: The Search (🔍) icon appears corresponding to this field. On clicking the Search icon, the Adjustment Type Search window appears.	Note: This field is required when you do not check the Offset Indicator check box.
Related Transaction BO	Used to indicate the object using which financial transaction object is created. Note: The Search (🔍) icon appears corresponding to this field. On clicking the Search icon, the Financial Transaction Business Object Search window appears.	Yes

- Modify the details of the financial transaction distribution type.
- Define, edit, or remove characteristics of the financial transaction distribution type, if required.
- Click **Save**.

The changes made to the financial transaction distribution type are saved.

Related Topics

For more information on...	See...
Financial Transaction Distribution Type screen	Financial Transaction Distribution Type on page 2077
How to define a characteristic for a financial transaction distribution type	Defining a Characteristic for a Financial Transaction Distribution Type on page 2084

Deleting a Financial Transaction Distribution Type

Procedure

To delete a financial transaction distribution type:

- Click the **Admin** link in the **Application** toolbar.
A list appears.
- From the **Admin** menu, select **F** and then click **Financial Transaction Distribution Type**.
A sub-menu appears.
- Click the **Search** option from the **Financial Transaction Distribution Type** sub-menu.
The **Financial Transaction Distribution Type** screen appears.
- In the **Financial Transaction Distribution Type List** zone, click the **Delete** (🗑️) icon in the **Delete** column corresponding to the financial transaction distribution type that you want to delete.
A message appears confirming whether you want to delete the financial transaction distribution type.

Tip: Alternatively, you can click the **Delete** button in the **Financial Transaction Distribution Type** zone to delete the financial transaction distribution type.

- Click **OK**.

The financial transaction distribution type is deleted.

Related Topics

For more information on...	See...
Financial Transaction Distribution Type screen	Financial Transaction Distribution Type on page 2077
Financial Transaction Distribution Type List zone	Financial Transaction Distribution Type List on page 2077
Financial Transaction Distribution Type zone	Financial Transaction Distribution Type on page 2078

Copying a Financial Transaction Distribution Type

Instead of creating a financial transaction distribution type from scratch, you can create a new financial transaction distribution type using an existing financial transaction distribution type. This is possible through copying a financial transaction distribution type. On copying a financial transaction distribution type, the details including the characteristics are copied to the new financial transaction distribution type. You can then edit the details, if required.

Prerequisites

To copy a financial transaction distribution type, you should have:

- Financial transaction distribution type (whose copy you want to create) defined in the application
- Financial transaction distribution type business objects defined in the application

Procedure

To copy a financial transaction distribution type:

1. Click the **Admin** link in the **Application** toolbar.
A list appears.
2. From the **Admin** menu, select **F** and then click **Financial Transaction Distribution Type**.
A sub-menu appears.
3. Click the **Search** option from the **Financial Transaction Distribution Type** sub-menu.
The **Financial Transaction Distribution Type** screen appears.
4. In the **Financial Transaction Distribution Type List** zone, click the **Duplicate**  icon in the **Duplicate** column corresponding to the financial transaction distribution type whose copy you want to create.

The **Financial Transaction Distribution Type** screen appears. It contains the following sections:

- **Main** — Used to specify basic details about the financial transaction distribution type.
- **Characteristics** — Used to define the characteristics for the financial transaction distribution type.

The **Main** section contains the following fields:

Field Name	Field Description	Mandatory (Yes or No)
Financial Transaction Distribution Type	Used to specify the financial transaction distribution type.	Yes
Description	Used to specify the description of the financial transaction distribution type.	Yes
FT Object Type	Used to indicate the business object that will be used to create the financial	Yes

Field Name	Field Description	Mandatory (Yes or No)
	<p>transaction distribution type. The valid values are:</p> <ul style="list-style-type: none"> • Adjustment • Bill Segment 	
FT Adjustment Type	Used to indicate the adjustment type used in the financial transaction adjustment.	Yes (Conditional)
	Note: By default, this field is disabled. This field gets enabled when you select Adjustment option from the FT Object Type list.	Note: This field is required when you are selecting the Adjustment option for the FT Object Type list.
Distribution Object Type	Used to indicate the financial transaction object type used in distribution.	Yes
Distribution Adjustment Type	Used to indicate the adjustment type which is used for distribution if the Transfer Adjustment option is selected from the Distribution Object Type list.	No
FT Distribution Rule	Used to indicate the financial transaction distribution rule to be used for distributing the credit or debit in an account.	No
	Note: The Search (🔍) icon appears corresponding to this field. On clicking the Search icon, the Financial Transaction Offset Distribution Type FK Search window appears.	
Offset Indicator	Used to indicate whether the financial transaction distribution type is applicable when an account in a hierarchy is using an excess credit from the account credit source to offset its own debt or not.	No
Write Off Threshold Amount	Used to specify the minimum credit amount for write off.	Yes (Conditional)
		Note: This field is required when you do not check the Offset Indicator check box.
Write Off Adjustment Type	Used to indicate the adjustment type used for write off.	Yes (Conditional)

Field Name	Field Description	Mandatory (Yes or No)
	Note: The Search (🔍) icon appears corresponding to this field. On clicking the Search icon, the Adjustment Type Search window appears.	Note: This field is required when you do not check the Offset Indicator check box.
Expiration Adjustment Type	Used to indicate the adjustment type used for expiration. Note: The Search (🔍) icon appears corresponding to this field. On clicking the Search icon, the Adjustment Type Search window appears.	Yes (Conditional) Note: This field is required when you do not check the Offset Indicator check box.
Refund Adjustment Type	Used to indicate the adjustment type used for refund. Note: The Search (🔍) icon appears corresponding to this field. On clicking the Search icon, the Adjustment Type Search window appears.	Yes (Conditional) Note: This field is required when you do not check the Offset Indicator check box.
Related Transaction BO	Used to indicate the object using which financial transaction object is created. Note: The Search (🔍) icon appears corresponding to this field. On clicking the Search icon, the Financial Transaction Business Object Search window appears.	Yes

Tip: Alternatively, you can click the **Duplicate** button in the **Financial Transaction Distribution Type** zone to create a copy of the financial transaction distribution type

5. Enter the required details.
6. Define, edit, or remove characteristics of the financial transaction distribution type, if required.
7. Click **Save**.

The new financial transaction distribution type is defined.

Related Topics

For more information on...	See...
Financial Transaction Distribution Type screen	Financial Transaction Distribution Type on page 2077
Financial Transaction Distribution Type List zone	Financial Transaction Distribution Type List on page 2077
Financial Transaction Distribution Type zone	Financial Transaction Distribution Type on page 2078
How to define a characteristic for a financial transaction distribution type	Defining a Characteristic for a Financial Transaction Distribution Type on page 2084

Viewing the Financial Transaction Distribution Type Details

Procedure

To view the details of a financial transaction distribution type:

1. Click the **Admin** link in the **Application** toolbar.
A list appears.
2. From the **Admin** menu, select **F** and then click **Financial Transaction Distribution Type**.
A sub-menu appears.
3. Click the **Search** option from the **Financial Transaction Distribution Type** sub-menu.
The **Financial Transaction Distribution Type** screen appears.
4. In the **Financial Transaction Distribution Type List** zone, click the **Broadcast** () icon corresponding to the financial transaction distribution type whose details you want to view.
The **Financial Transaction Distribution Type** zone appears.
5. View the details of the financial transaction distribution type in the **Financial Transaction Distribution Type** zone.

Related Topics

For more information on...	See...
Financial Transaction Distribution Rule screen	Financial Transaction Distribution Rule on page 2091
Financial Transaction Distribution Rule List zone	Financial Transaction Distribution Rule List on page 2092

Financial Transaction Distribution Rule

Once you create a financial transaction distribution rule, the **Financial Transaction Distribution Rule** screen allows you to:

- Edit the details of a financial transaction distribution rule
- Copy a financial transaction distribution rule
- Delete a financial transaction distribution rule
- View the details of a financial transaction distribution rule
- Add the financial transaction distribution rule version
- Edit the details of a financial transaction distribution rule version
- Copy a financial transaction distribution rule version
- Include or exclude objects from a financial transaction distribution rule version
- Associate or dissociate algorithms from a financial transaction distribution rule version
- Delete a financial transaction distribution rule version
- View the details of a financial transaction distribution rule version



This screen consists of following zones:

- [Financial Transaction Distribution Rule List](#) on page 2092
- [Financial Transaction Distribution Rule](#) on page 2093
- [Financial Transaction Distribution Rule Version List](#) on page 2094
- [Financial Transaction Distribution Rule Version](#) on page 2095

Financial Transaction Distribution Rule List

The **Financial Transaction Distribution Rule List** zone allows you to view the list of financial transaction distribution rules that are already defined in the system.

This zone contains the following columns:

Column Name	Column Description
FT Distribution Rule	Displays the financial transaction distribution rule.
Description	Displays the description of the financial transaction distribution rule.
Distribution Method	Indicates the principle for distributing credit for accounts other than the credit or debit source account. The valid values are: <ul style="list-style-type: none"> • Fee Based • Priority Based • Weighted Average
Distribution Hierarchy	Indicates the hierarchy of accounts in which the distribution needs to be made.
Edit	On clicking the Edit () icon, the Financial Transaction Distribution Rule screen appears where you can edit the details of the financial transaction distribution rule.
Duplicate	On clicking the Duplicate () icon, the Financial Transaction Distribution Rule screen appears where you can define a financial transaction distribution rule using an existing financial transaction distribution rule.
Delete	On clicking the Delete () icon, you can delete the financial transaction distribution rule.

On clicking the **Broadcast** () icon corresponding to the financial transaction distribution rule, the **Financial Transaction Distribution Rule** and **Financial Transaction Distribution Rule Version List** zones appear with the details of the respective financial transaction distribution rule and financial transaction distribution rule version.

You can filter the list using the **FT Distribution Rule**, **Description**, **Effective Date**, and **Distribution Method** fields available in the **Filter** area. By default, the **Filter** area is hidden. You can view the **Filter** area by clicking the **Filters** () icon in the upper right corner of this zone.

Related Topics



For more information on...	See...
How to define a financial transaction distribution rule	Defining a Financial Transaction Distribution Rule on page 2097
How to edit a financial transaction distribution rule	Editing a Financial Transaction Distribution Rule on page 2098

For more information on...	See...
How to copy a financial transaction distribution rule	Copying a Financial Transaction Distribution Rule on page 2100
How to delete a financial transaction distribution rule	Deleting a Financial Transaction Distribution Rule on page 2099
How to view the details of a financial transaction distribution rule	Viewing the Financial Transaction Distribution Rule Details on page 2101
How to view the list of a financial transaction distribution rule version	Viewing the Financial Transaction Distribution Rule Version List on page 2102

Financial Transaction Distribution Rule

The **Financial Transaction Distribution Rule** zone allows you to view the details of financial transaction distribution rule. This zone contains the following sections:

- **Main** – This section displays the details of the financial transaction distribution rule. It contains the following columns:

Column Name	Column Description
FT Distribution Rule	Displays the financial transaction distribution rule.
Description	Displays the description of the financial transaction distribution rule.
Detailed Description	Displays the additional information about the financial transaction distribution rule.
Distribution Method	Indicates the principle for distributing credit for the accounts other than the credit or debit source account. The valid values are: <ul style="list-style-type: none"> • Fee Based • Priority Based • Weighted Average
Distribution Hierarchy	Indicates the hierarchy of accounts in which the distribution needs to be made.
Edit	On clicking the Edit () icon, the Financial Transaction Distribution Rule screen appears where you can edit the details of the financial transaction distribution rule.
Duplicate	On clicking the Duplicate () icon, the Financial Transaction Distribution Rule screen appears where you can define a financial transaction distribution rule using an existing financial transaction distribution rule.
Delete	On clicking the Delete () icon, you can delete the financial transaction distribution rule.

- **Record Actions** – This section contains the following buttons:

Button Name	Button Description
Edit	Used to edit the details of the financial transaction distribution rule
Delete	Used to delete the financial transaction distribution rule.

Button Name	Button Description
Duplicate	Used to create a new financial transaction distribution rule using an existing financial transaction distribution rule.

- **Record Information** – This section contains the following fields:

Field Name	Field Description
Business Object	Indicates the business object using which the financial transaction distribution rule is created. In addition, a context menu appears corresponding to this field which helps in navigating to other screens in the application.
	Note: It has a link. On clicking the link, the Business Object screen appears where you can view the details of the respective business object.

By default, the **Financial Transaction Distribution Rule** zone does not appear in the **Financial Transaction Distribution Rule** screen. It appears when you click the **Broadcast** () icon corresponding to the financial transaction distribution rule of the **Financial Transaction Distribution Rule List** zone.

Related Topics

For more information on...	See...
How to define a financial transaction distribution rule	Defining a Financial Transaction Distribution Rule on page 2097
How to edit a financial transaction distribution rule	Editing a Financial Transaction Distribution Rule on page 2098
How to copy a financial transaction distribution rule	Copying a Financial Transaction Distribution Rule on page 2100
How to delete a financial transaction distribution rule	Deleting a Financial Transaction Distribution Rule on page 2099
How to view the details of a financial transaction distribution rule	Viewing the Financial Transaction Distribution Rule Details on page 2101

Financial Transaction Distribution Rule Version List

The **Financial Transaction Distribution Rule Version List** zone allows you to view the list of financial transaction distribution rule version that are already defined in the system and are used as the basis for credit distribution.

This zone contains the following columns:

Column Name	Column Description
Effective Date	Displays the date from when the financial transaction distribution rule version is effective for the respective financial transaction distribution rule.
Description	Displays the description of the associated financial transaction distribution rule.
Edit	On clicking the Edit () icon, the Financial Transaction Distribution Rule Version screen appears where you can edit the details of the financial transaction distribution rule version.

Column Name	Column Description
Duplicate	On clicking the Duplicate (📄) icon, the Financial Transaction Distribution Rule Version screen appears where you can define a financial transaction distribution rule version using an existing financial transaction distribution rule version.
Delete	On clicking the Delete (🗑️) icon, you can delete the financial transaction distribution version.

By default, the **Financial Transaction Distribution Rule Version** zone does not appear in the **Financial Transaction Distribution Rule** screen. It appears only when you click the **Broadcast** (📡) icon corresponding to the financial transaction distribution rule of the **Financial Transaction Distribution Rule List** zone.

You can filter the list using the **Description** or **Effective Date** fields available in the **Filter** area. By default, the **Filter** area is hidden. You can view the **Filter** area by clicking the **Filters** (🔍) icon in the upper right corner of this zone.

Related Topics

For more information on...	See...
Financial Transaction Distribution Rule Version zone	Financial Transaction Distribution Rule Version on page 2095
How to define a financial transaction distribution rule version	Defining a Financial Transaction Distribution Rule Version on page 2102
How to edit a financial transaction distribution rule version	Editing a Financial Transaction Distribution Rule Version on page 2108
How to copy a financial transaction distribution rule version	Copying a Financial Transaction Distribution Rule Version on page 2111
How to delete a financial transaction distribution rule version	Deleting a Financial Transaction Distribution Rule Version on page 2111
How to view the details of a financial transaction distribution rule version	Viewing the Financial Transaction Distribution Rule Version Details on page 2114

Financial Transaction Distribution Rule Version

The **Financial Transaction Distribution Rule Version** zone allows you to view the details of the financial transaction distribution rule version. This zone contains the following sections:

- **Main** – This section displays the details of the financial transaction distribution rule version. It contains the following columns:

Column Name	Column Description
Effective Date	Displays the date from when the financial transaction distribution rule version is effective for the respective financial transaction distribution rule.
Version Description	Displays the description of the financial transaction distribution rule version.
Detailed Description	Displays the additional information about the financial transaction distribution rule version.

- **Included Objects** – This section displays the list of object that are included for credit distribution. It contains the following columns:

Column Name	Column Description
Sequence	Displays the sequence in which the objects should be included in the financial transaction distribution rule version.
Priority	Displays the sequence of objects for the credit or debit distribution within an account.
Object Type	Displays the type of object.
Value	<p>Displays the value of the object type.</p> <p>Note:</p> <p>It has a link. On clicking the link, respective object type screen appears with the details of the respective object type.</p> <p>The Search (🔍) icon appears corresponding to this field. On clicking the Search icon, the Adjustment Type Search window appears.</p>
Bill Status	Displays the status of the bill.

- **Excluded Objects** – This section displays the list of object that are excluded from credit distribution. It contains the following columns:

Column Name	Column Description
Sequence	Displays the sequence in which the objects should be excluded from the financial transaction distribution rule version.
Object Type	Displays the type of object.
Value	<p>Displays the value of the object type.</p> <p>Note:</p> <p>It has a link. On clicking the link, respective object type screen appears with the details of the respective object type.</p> <p>The Search (🔍) icon appears corresponding to this field. On clicking the Search icon, the Financial Transaction Business Object Search window appears.</p>

- **Algorithms** – This section displays the list of algorithms that are included. It contains the following columns:

Column Name	Column Description
System Event	Indicates the system event on which the algorithm must be executed.
Sequence	Displays the order in which the algorithms for each system event must be executed.
Algorithm	<p>Displays the algorithm code.</p> <p>Note: It has a link. On clicking the link, Algorithm screen appears with the details of the respective algorithm.</p>

- **Record Actions** – This section contains the following buttons:

Button Name	Button Description
Edit	Used to edit the details of the financial transaction distribution rule version.
Delete	Used to delete the financial transaction distribution rule version.
Duplicate	Used to create a new financial transaction distribution rule version using an existing financial transaction distribution rule version.

- **Record Information** – This section contains the following fields:

Field Name	Field Description
Business Object	Indicates the business object using which the financial transaction distribution rule version is created. In addition, a context menu appears corresponding to this field which helps in navigating to other screens in the application. Note: It has a link. On clicking the link, the Business Object screen appears with the details of the respective business object.

By default, the **Financial Transaction Distribution Rule Version** zone does not appear in the **Financial Transaction Distribution Rule** screen. It appears only when you click the **Broadcast** (📡) icon corresponding to the financial transaction distribution rule version of the **Financial Transaction Distribution Rule Version List** zone.

Related Topics

For more information on...	See...
How to edit a financial transaction distribution rule version	Editing a Financial Transaction Distribution Rule Version on page 2108
How to copy a financial transaction distribution rule version	Copying a Financial Transaction Distribution Rule Version on page 2111
How to delete a financial transaction distribution rule version	Deleting a Financial Transaction Distribution Rule Version on page 2111

Defining a Financial Transaction Distribution Rule

Prerequisites

To define a financial transaction distribution rule, you should have:

- Distribution method and hierarchy defined in the application.

Procedure

To define a financial transaction distribution rule:

1. Click the **Admin** link in the **Application** toolbar.
A list appears.
2. From the **Admin** menu, select **F** and then click **Financial Transaction Distribution Rule**.
A sub-menu appears.
3. Click the **Add** option from the **Financial Transaction Distribution Rule** sub-menu.

The **Financial Transaction Distribution Rule** screen appears. It contains the following section:

- **Main** – Used to specify basic details about the financial transaction distribution rule.

Main – This section contains the following fields:

Field Name	Field Description	Mandatory (Yes or No)
FT Distribution Rule	Used to specify the financial transaction distribution rule.	Yes
Description	Used to specify the description of the financial transaction distribution rule.	Yes
Detailed Description	Used to specify the additional information about the financial transaction distribution rule.	No
Distribution Method	Used to indicate the principle for distributing credit for accounts other than the credit or debit source account. The valid values are: <ul style="list-style-type: none"> • Fee Based • Priority Based • Weighted Average 	Yes
Distribution Hierarchy	Used to indicate the hierarchy of accounts in which the distribution needs to be made.	No

Tip: Alternatively, you can access the **Financial Transaction Distribution Rule** screen by clicking the **Add** button in the **Page Title** area of the **Financial Transaction Distribution Rule** screen.

4. Enter the required details.
5. Click **Save**.

The financial transaction distribution rule is defined.

Related Topics

For more information on...	See...
Financial Transaction Distribution Rule screen	Financial Transaction Distribution Rule on page 2091
Financial Transaction Distribution Rule zone	Financial Transaction Distribution Rule on page 2093

Editing a Financial Transaction Distribution Rule

Procedure

To edit a financial transaction distribution rule:

1. Click the **Admin** link in the **Application** toolbar.
A list appears.
2. From the **Admin** menu, select **F** and then click **Financial Transaction Distribution Rule**.
A sub-menu appears.
3. Click the **Search** option from the **Financial Transaction Distribution Rule** sub-menu.
The **Financial Transaction Distribution Rule** screen appears.

4. In the **Financial Transaction Distribution Rule List** zone, click the **Edit**  icon in the **Edit** column corresponding to the financial transaction distribution rule whose details you want to edit.

The **Financial Transaction Distribution Rule** screen appears. It contains the following section:

- **Main** – Used to specify basic details about the financial transaction distribution rule.

Main – This section contains the following fields:

Field Name	Field Description	Mandatory (Yes or No)
FT Distribution Rule	Used to specify the financial transaction distribution rule.	Yes
Description	Used to specify the description of the financial transaction distribution rule.	Yes
Detailed Description	Used to specify the additional information about the financial transaction distribution rule.	No
Distribution Method	Used to indicate the principle for distributing credit for accounts other than the credit or debit source account. The valid values are: <ul style="list-style-type: none"> • Fee Based • Priority Based • Weighted Average 	Yes
Distribution Hierarchy	Used to indicate the hierarchy of accounts in which the distribution needs to be made.	No

Tip: Alternatively, you can click the **Edit** button in the **Financial Transaction Distribution Rule** zone to edit the details of the financial transaction distribution rule.

5. Modify the details of the financial transaction distribution rule.
6. Click **Save**.

The changes made to the financial transaction distribution rule are saved.

Related Topics

For more information on...	See...
Financial Transaction Distribution Rule screen	Financial Transaction Distribution Rule on page 2091
Financial Transaction Distribution Rule List zone	Financial Transaction Distribution Rule List on page 2092

Deleting a Financial Transaction Distribution Rule

Procedure

To delete a financial transaction distribution rule:

1. Click the **Admin** link in the **Application** toolbar.

A list appears.

- From the **Admin** menu, select **F** and then click **Financial Transaction Distribution Rule**.

A sub-menu appears.

- Click the **Search** option from the **Financial Transaction Distribution Rule** sub-menu.

The **Financial Transaction Distribution Rule** screen appears.

- In the **Financial Transaction Distribution Rule List** zone, click the **Delete** () icon in the **Delete** column corresponding to the financial transaction distribution rule that you want to delete.

A message appears confirming whether you want to delete the financial transaction distribution rule.

Tip: Alternatively, you can click the **Delete** button in the **Financial Transaction Distribution Rule** zone to delete the financial transaction distribution rule.

- Click **OK**.

The financial transaction distribution rule is deleted.

Related Topics

For more information on...	See...
Financial Transaction Distribution Rule screen	Financial Transaction Distribution Rule on page 2091
Financial Transaction Distribution Rule List zone	Financial Transaction Distribution Rule List on page 2092

Copying a Financial Transaction Distribution Rule

Instead of creating a financial transaction distribution rule from scratch, you can create a new financial transaction distribution rule using an existing financial transaction distribution rule. This is possible through copying a financial transaction distribution rule. On copying a financial transaction distribution rule, the details are copied to the new financial transaction distribution rule. You can then edit the details, if required.

Prerequisites

To copy a financial transaction distribution rule, you should have:

- Financial transaction distribution rule (whose copy you want to create) defined in the application
- Financial transaction distribution rule business objects defined in the application

Procedure

To copy a financial transaction distribution rule:

- Click the **Admin** link in the **Application** toolbar.

A list appears.

- From the **Admin** menu, select **F** and then click **Financial Transaction Distribution Rule**.

A sub-menu appears.

- Click the **Search** option from the **Financial Transaction Distribution Rule** sub-menu.

The **Financial Transaction Distribution Rule** screen appears.

- In the **Financial Transaction Distribution Rule List** zone, click the **Duplicate** () icon in the **Duplicate** column corresponding to the financial transaction distribution rule whose copy you want to create.

The **Financial Transaction Distribution Rule** screen appears. It contains the following section:

- Main** – Used to specify basic details about the financial transaction distribution rule.

Main – This section contains the following fields:

Field Name	Field Description	Mandatory (Yes or No)
FT Distribution Rule	Used to specify the financial transaction distribution rule.	Yes
Description	Used to specify the description of the financial transaction distribution rule.	Yes
Detailed Description	Used to specify the additional information about the financial transaction distribution rule.	No
Distribution Method	Used to indicate the principle for distributing credit for accounts other than the credit or debit source account. The valid values are: <ul style="list-style-type: none"> • Fee Based • Priority Based • Weighted Average 	Yes
Distribution Hierarchy	Used to indicate the hierarchy of accounts in which the distribution needs to be made.	No

Tip: Alternatively, you can click the **Duplicate** button in the **Financial Transaction Distribution Rule** zone to create a copy of the financial transaction distribution rule.

5. Enter the required details.
6. Click **Save**.

The new financial transaction distribution rule is defined.

Related Topics

For more information on...	See...
Financial Transaction Distribution Rule screen	Financial Transaction Distribution Rule on page 2091
Financial Transaction Distribution Rule List zone	Financial Transaction Distribution Rule List on page 2092

Viewing the Financial Transaction Distribution Rule Details

Procedure

To view the details of a financial transaction distribution rule:

1. Click the **Admin** link in the **Application** toolbar.
A list appears.
2. From the **Admin** menu, select **F** and then click **Financial Transaction Distribution Rule**.
A sub-menu appears.
3. Click the **Search** option from the **Financial Transaction Distribution Rule** sub-menu.

The **Financial Transaction Distribution Rule** screen appears.

4. In the **Financial Transaction Distribution Rule List** zone, click the **Broadcast** () icon corresponding to the financial transaction distribution rule whose details you want to view.

The **Financial Transaction Distribution Rule** and **Financial Transaction Distribution Rule Version List** zones appear.

5. View the details of the financial transaction distribution rule in the **Financial Transaction Distribution Rule** zone.

Related Topics

For more information on...	See...
Financial Transaction Distribution Rule screen	Financial Transaction Distribution Rule on page 2091
Financial Transaction Distribution Rule List zone	Financial Transaction Distribution Rule List on page 2092

Viewing the Financial Transaction Distribution Rule Version List

Procedure

To view the list of a financial transaction distribution rule version list:

1. Click the **Admin** link in the **Application** toolbar.
A list appears.
2. From the **Admin** menu, select **F** and then click **Financial Transaction Distribution Rule**.
A sub-menu appears.
3. Click the **Search** option from the **Financial Transaction Distribution Rule** sub-menu.
The **Financial Transaction Distribution Rule** screen appears.
4. In the **Financial Transaction Distribution Rule List** zone, click the **Broadcast** () icon corresponding to the financial transaction distribution rule whose details you want to view.
The **Financial Transaction Distribution Rule** and **Financial Transaction Distribution Rule Version List** zones appear.
5. View the list of the financial transaction distribution rule version in the **Financial Transaction Distribution Rule Version List** zone.

Related Topics

For more information on...	See...
Financial Transaction Distribution Rule screen	Financial Transaction Distribution Rule on page 2091
Financial Transaction Distribution Rule List zone	Financial Transaction Distribution Rule List on page 2092

Defining a Financial Transaction Distribution Rule Version

Prerequisites

To define a financial transaction distribution rule version, you should have:

- Financial transaction distribution rule defined in the application.
- Object types and algorithms defined in the application.

Procedure

To define a financial transaction distribution rule version:

1. Click the **Admin** link in the **Application** toolbar.

A list appears.

2. From the **Admin** menu, select **F** and then click **Financial Transaction Distribution Rule**.

A sub-menu appears.

3. Click the **Search** option from the **Financial Transaction Distribution Rule** sub-menu.

The **Financial Transaction Distribution Rule** screen appears.

4. In the **Financial Transaction Distribution Rule List** zone, click the **Broadcast** () icon corresponding to the financial transaction distribution rule whose details you want to edit.

The **Financial Transaction Distribution Rule** and **Financial Transaction Distribution Rule Version List** zone appears.

5. Click the **Add** link in the upper right corner of the **Financial Transaction Distribution Rule Version List** zone.

The **Financial Transaction Distribution Rule Version** screen appears. It contains the following sections:

- **Main** – Used to specify basic details about the financial transaction distribution rule version.
- **Included Objects** – Used to include the objects in financial transaction distribution rule version.
- **Excluded Objects** – Used to exclude the objects in financial transaction distribution rule version.
- **Algorithms** – Used to define the algorithms that are added for financial transaction distribution rule version.

The **Main** section contains the following fields:

Field Name	Field Description	Mandatory (Yes or No)
FT Distribution Rule	Displays the financial transaction distribution rule.	Not applicable
Effective Date	Used to specify the date from when the financial transaction distribution rule version is effective for the respective financial transaction distribution rule.	Yes
Business Object	Displays the business object using which financial transaction distribution rule version is created.	Not applicable
Version Description	Used to specify the description of the financial transaction distribution rule version.	Yes
Detailed Description	Used to specify the additional information about the financial transaction distribution rule version.	No

The **Included Objects** section contains the following columns:

Column Name	Column Description	Mandatory (Yes or No)
Sequence	Used to specify the sequence in which the objects should be included in the financial transaction distribution rule version.	No
Priority	Used to specify the sequence of objects for the credit or debit distribution within an account.	No
Object Type	Used to indicate the type of object.	No
Value	Used to specify the value of the object type. Note: It has a link. On clicking the link, respective object type screen appears with the details of the respective object type. The Search  icon appears corresponding to this field. On clicking the Search icon, the Adjustment Type Search window appears.	No
Bill Status	Used to indicate the status of the bill.	No

Note: If you include object, then all the fields are mandatory.

The **Excluded Objects** section contains the following columns:

Column Name	Column Description	Mandatory (Yes or No)
Sequence	Used to specify the sequence in which the objects should be excluded from the financial transaction distribution rule version.	No
Object Type	Used to indicate the type of object.	No
Value	Used to specify the value of the object type. Note: It has a link. On clicking the link, respective object type screen appears with the details of the respective object type. The Search  icon appears corresponding to this field. On clicking the Search icon, the Adjustment Type Search window appears.	No

Note: If you exclude object, then all the fields are mandatory.

The **Algorithms** section contains the following columns:

Column Name	Column Description	Mandatory (Yes or No)
System Event	Used to indicate the system event on which the algorithm must be executed.	No
Sequence	Used to specify the order in which the algorithms for each system event must be executed.	No
Algorithm	Used to specify the algorithm code. Note: It has a link. On clicking the link, Algorithm screen appears with the details of the respective algorithm. The Search (🔍) icon appears corresponding to this field. On clicking the Search icon, the Algorithm Search window appears.	No

Note: While defining a financial transaction distribution rule version, you can either include or exclude objects from it.

6. Enter the required details.
7. Include or exclude the object types, if required.
8. Add the algorithms, if required.
9. Click **Save**.

The financial transaction distribution rule version is defined.

Related Topics

For more information on...	See...
Financial Transaction Distribution Rule screen	Financial Transaction Distribution Rule on page 2091
Including objects in a financial transaction distribution rule version	Including Objects in a Financial Transaction Distribution Rule Version on page 2105
Excluding objects from a financial transaction distribution rule version	Excluding Objects in a Financial Transaction Distribution Rule Version on page 2106
Associating algorithms with a financial transaction distribution rule version	Associating Algorithms with a Financial Transaction Distribution Rule Version on page 2107

Including Objects in a Financial Transaction Distribution Rule Version

Procedure

To include objects in a financial transaction distribution rule version:

1. Click the **Admin** link in the **Application** toolbar.
A list appears.
2. From the **Admin** menu, select **F** and then click **Financial Transaction Distribution Rule**.

A sub-menu appears.

- Click the **Search** option from the **Financial Transaction Distribution Rule** sub-menu.

The **Financial Transaction Distribution Rule** screen appears.

- In the **Financial Transaction Distribution Rule List** zone, click the **Broadcast** () icon corresponding to the financial transaction distribution rule whose details you want to edit.

The **Financial Transaction Distribution Rule** and **Financial Transaction Distribution Rule Version List** zones appear.

- In the **Financial Transaction Distribution Rule Version List** zone, click the **Edit** () icon in the **Edit** column corresponding to the financial transaction distribution rule version whose details you want to edit.

The **Financial Transaction Distribution Rule Version** screen appears.

- Ensure that the **Included Objects** section is expanded when you are editing the financial transaction distribution rule version.
- Enter the required details in the **Included Objects** section.

Note: If you select a predefined object type, the **Search** () icon appears corresponding to the **Value** field. On clicking the **Search** icon, you can search for a predefined object value.

- If you want to include more than one object in the financial transaction distribution rule version, click the **Add** () icon and then repeat step 7.

Note: However, if you want to remove an included object from the financial transaction distribution rule version, click the **Delete** () icon corresponding to the object.

Related Topics

For more information on...	See...
Financial Transaction Distribution Rule screen	Financial Transaction Distribution Rule on page 2091
How to define financial transaction distribution rule version	Defining a Financial Transaction Distribution Rule Version on page 2102
How to exclude objects from a financial transaction distribution rule version	Excluding Objects in a Financial Transaction Distribution Rule Version on page 2106

Excluding Objects in a Financial Transaction Distribution Rule Version

Procedure

To exclude objects from a financial transaction distribution rule version:

- Click the **Admin** link in the **Application** toolbar.
A list appears.
- From the **Admin** menu, select **F** and then click **Financial Transaction Distribution Rule**.
A sub-menu appears.
- Click the **Search** option from the **Financial Transaction Distribution Rule** sub-menu.
The **Financial Transaction Distribution Rule** screen appears.

- In the **Financial Transaction Distribution Rule List** zone, click the **Broadcast** (📡) icon corresponding to the financial transaction distribution rule whose details you want to edit.

The **Financial Transaction Distribution Rule** and **Financial Transaction Distribution Rule Version List** zones appear.

- In the **Financial Transaction Distribution Rule Version List** zone, click the **Edit** (✎) icon in the **Edit** column corresponding to the financial transaction distribution rule version whose details you want to edit.

The **Financial Transaction Distribution Rule Version** screen appears.

- Ensure that the **Excluded Objects** section is expanded when you are editing the financial transaction distribution rule version.

- Enter the required details in the **Excluded Objects** section.

Note: If you select a predefined object type, the **Search** (🔍) icon appears corresponding to the **Value** field. On clicking the **Search** icon, you can search for a predefined object value.

- If you want to exclude more than one object in the financial transaction distribution rule version, click the **Add** (+) icon and then repeat step 7.

Note: However, if you want to remove an excluded object from the financial transaction distribution rule version, click the **Delete** (🗑) icon corresponding to the object.

Related Topics

For more information on...	See...
Financial Transaction Distribution Rule screen	Financial Transaction Distribution Rule on page 2091
How to include objects to a financial transaction distribution rule version	Including Objects in a Financial Transaction Distribution Rule Version on page 2105

Associating Algorithms with a Financial Transaction Distribution Rule Version

Prerequisites

To associate algorithms with a financial transaction distribution rule version, you should have:

- Algorithms defined in the application.

Procedure

To associate algorithms with a financial transaction distribution rule version:

- Click the **Admin** link in the **Application** toolbar.
A list appears.
- From the **Admin** menu, select **F** and then click **Financial Transaction Distribution Rule**.
A sub-menu appears.
- Click the **Search** option from the **Financial Transaction Distribution Rule** sub-menu.
The **Financial Transaction Distribution Rule** screen appears.
- In the **Financial Transaction Distribution Rule List** zone, click the **Broadcast** (📡) icon corresponding to the financial transaction distribution rule whose details you want to edit.

The **Financial Transaction Distribution Rule** and **Financial Transaction Distribution Rule Version List** zone appears.

- In the **Financial Transaction Distribution Rule Version List** zone, click the **Edit** (✎) icon in the **Edit** column corresponding to the financial transaction distribution rule version whose details you want to edit.

The **Financial Transaction Distribution Rule Version** screen appears.

- Ensure that the **Algorithms** section is expanded when you are editing the financial transaction distribution rule version.
- Enter the required details in the **Algorithms** section.

Note: On clicking the **Search** (🔍) icon corresponding to the **Algorithm** column, you can search for a predefined algorithm.

- If you want to associate more than one algorithm to the financial transaction distribution rule version, click the **Add** (+) icon and then repeat step 5.

Note: However, if you want to disassociate an algorithm from the financial transaction distribution rule version, click the **Delete** (🗑) icon corresponding to the algorithm.

Related Topics

For more information on...	See...
Financial Transaction Distribution Rule screen	Financial Transaction Distribution Rule on page 2091
How to edit a financial transaction distribution rule version	Editing a Financial Transaction Distribution Rule Version on page 2108

Editing a Financial Transaction Distribution Rule Version

Procedure

To edit a financial transaction distribution rule version:

- Click the **Admin** link in the **Application** toolbar.
A list appears.
- From the **Admin** menu, select **F** and then click **Financial Transaction Distribution Rule**.
A sub-menu appears.
- Click the **Search** option from the **Financial Transaction Distribution Rule** sub-menu.
The **Financial Transaction Distribution Rule** screen appears.
- In the **Financial Transaction Distribution Rule List** zone, click the **Broadcast** (📡) icon corresponding to the financial transaction distribution rule whose details you want to edit.

The **Financial Transaction Distribution Rule** and **Financial Transaction Distribution Rule Version List** zone appears.

- In the **Financial Transaction Distribution Rule Version List** zone, click the **Edit** (✎) icon in the **Edit** column corresponding to the financial transaction distribution rule version whose details you want to edit.

The **Financial Transaction Distribution Rule Version** screen appears. It contains the following sections:

- Main** – Used to specify basic details about the financial transaction distribution rule version.
- Included Objects** – Used to include the objects in financial transaction distribution rule version.

- **Excluded Objects** – Used to exclude the objects in financial transaction distribution rule version.
- **Algorithms** – Used to define the algorithms in the financial transaction distribution rule version.

The **Main** section contains the following fields:

Field Name	Field Description	Mandatory (Yes or No)
FT Distribution Rule	Displays the financial transaction distribution rule.	Not applicable
Effective Date	Used to specify the date from when the financial transaction distribution rule version is effective for the respective financial transaction distribution rule.	Yes
Business Object	Displays the business object using which financial transaction distribution rule version is created.	Not applicable
Version Description	Used to specify the description of the financial transaction distribution rule version.	Yes
Detailed Description	Used to specify the additional information about the financial transaction distribution rule version.	No

The **Included Objects** section contains the following columns:

Column Name	Column Description	Mandatory (Yes or No)
Sequence	Used to specify the sequence in which the objects should be included in the financial transaction distribution rule version.	No
Priority	Used to specify the sequence of objects for the credit or debit distribution within an account.	No
Object Type	Used to indicate the type of object.	No
Value	Used to specify the value of the object type.	No
	Note: It has a link. On clicking the link, respective object type screen appears with the details of the respective object type.	
Bill Status	Used to indicate the status of the bill.	No

Note: If you include object, then all the fields are mandatory.

The **Excluded Objects** section contains the following columns:

Column Name	Column Description	Mandatory (Yes or No)
Sequence	Used to specify the sequence in which the objects should be excluded from	No

Column Name	Column Description	Mandatory (Yes or No)
	the financial transaction distribution rule version.	
Object Type	Used to indicate the type of object.	No
Value	Used to specify the value of the object type.	No
	Note: It has a link. On clicking the link, respective object type screen appears with the details of the respective object type.	

Note: If you exclude object, then all the fields are mandatory.

The **Algorithms** section contains the following columns:

Column Name	Column Description	Mandatory (Yes or No)
System Event	Used to indicates the system event on which the algorithm must be executed.	No
Sequence	Used to specify the order in which the algorithms for each system event must be executed.	No
Algorithm	Used to specify the algorithm code.	No
	Note: It has a link. On clicking the link, Algorithm screen appears with the details of the respective algorithm.	

Note: While defining a financial transaction distribution rule version, you can either include or exclude objects from it.

6. Modify the details of the financial transaction distribution rule version.
7. Modify the included or excluded objects from the financial transaction distribution rule version, if required.
8. Edit the algorithms, if required
9. Click **Save**.

The changes made to the financial transaction distribution rule version are saved.

Related Topics

For more information on...	See...
Financial Transaction Distribution Rule screen	Financial Transaction Distribution Rule on page 2091
Financial Transaction Distribution Rule Version List zone	Financial Transaction Distribution Rule Version List on page 2094
Financial Transaction Distribution Rule Version zone	Financial Transaction Distribution Rule Version on page 2095

Deleting a Financial Transaction Distribution Rule Version

Procedure

To delete a financial transaction distribution rule:

1. Click the **Admin** link in the **Application** toolbar.

A list appears.

2. From the **Admin** menu, select **F** and then click **Financial Transaction Distribution Rule**.

A sub-menu appears.

3. Click the **Search** option from the **Financial Transaction Distribution Rule** sub-menu.

The **Financial Transaction Distribution Rule** screen appears.

4. In the **Financial Transaction Distribution Rule List** zone, click the **Broadcast** (🔊) icon corresponding to the financial transaction distribution rule whose details you want to edit.

The **Financial Transaction Distribution Rule** and **Financial Transaction Distribution Rule Version List** zone appears.

5. In the **Financial Transaction Distribution Rule Version List** zone, click the **Delete** (🗑️) icon in the **Delete** column corresponding to the financial transaction distribution rule version that you want to delete.

A message appears confirming whether you want to delete the financial transaction distribution rule version.

6. Click **OK**.

The financial transaction distribution rule version is deleted.

Related Topics

For more information on...	See...
Financial Transaction Distribution Rule screen	Financial Transaction Distribution Rule on page 2091
Financial Transaction Distribution Rule Version List zone	Financial Transaction Distribution Rule Version List on page 2094
Financial Transaction Distribution Rule Version zone	Financial Transaction Distribution Rule Version on page 2095

Copying a Financial Transaction Distribution Rule Version

Instead of creating a financial transaction distribution rule version from scratch, you can create a new financial transaction distribution rule version using an existing financial transaction distribution rule version. This is possible through copying a financial transaction distribution rule version. On copying a financial transaction distribution rule version, the details are copied to the new financial transaction distribution rule. You can then edit the details, if required.

Prerequisites

To copy a financial transaction distribution rule, you should have:

- Financial transaction distribution rule version (whose copy you want to create) defined in the application
- Financial transaction distribution rule version business objects defined in the application

Procedure

To copy a financial transaction distribution rule:

1. Click the **Admin** link in the **Application** toolbar.

A list appears.

2. From the **Admin** menu, select **F** and then click **Financial Transaction Distribution Rule**.

A sub-menu appears.

3. Click the **Search** option from the **Financial Transaction Distribution Rule** sub-menu.

The **Financial Transaction Distribution Rule** screen appears.

4. In the **Financial Transaction Distribution Rule List** zone, click the **Broadcast** () icon corresponding to the financial transaction distribution rule whose details you want to edit.

The **Financial Transaction Distribution Rule** and **Financial Transaction Distribution Rule Version List** zone appears.

5. In the **Financial Transaction Distribution Rule Version List** zone, click the **Duplicate** () icon in the **Duplicate** column corresponding to the financial transaction distribution rule version whose copy you want to create.

The **Financial Transaction Distribution Rule Version** screen appears. It contains the following sections:

- **Main** – Used to specify basic details about the financial transaction distribution rule version.
- **Included Objects** – Used to include the objects in financial transaction distribution rule version.
- **Excluded Objects** – Used to exclude the objects in financial transaction distribution rule version.
- **Algorithms** – Used to define the algorithms in the financial transaction distribution rule version.

Main – This section contains the following fields:

Field Name	Field Description	Mandatory (Yes or No)
FT Distribution Rule	Displays the financial transaction distribution rule.	Not applicable
Effective Date	Used to specify the date from when the financial transaction distribution rule version is effective for the respective financial transaction distribution rule.	Yes
Business Object	Displays the business object using which financial transaction distribution rule version is created.	Not applicable
Version Description	Used to specify the description of the financial transaction distribution rule version.	Yes
Detailed Description	Used to specify the additional information about the financial transaction distribution rule version.	No

Note: If you include object, then all the fields are mandatory.

Included Objects – This section contains the following columns:

Column Name	Column Description	Mandatory (Yes or No)
Sequence	Used to specify the sequence in which the objects should be included in the	No

Column Name	Column Description	Mandatory (Yes or No)
	financial transaction distribution rule version.	
Priority	Used to specify the sequence of objects for the credit or debit distribution within an account.	No
Object Type	Used to indicate the type of object.	No
Value	Used to specify the value of the object type. Note: It has a link. On clicking the link, respective object type screen appears with the details of the respective object type. The Search (🔍) icon appears corresponding to this field. On clicking the Search icon, the Adjustment Type Search window appears.	No
Bill Status	Used to indicate the status of the bill.	No

Excluded Objects – This section contains the following columns:

Column Name	Column Description	Mandatory (Yes or No)
Sequence	Used to specify the sequence in which the objects should be excluded from the financial transaction distribution rule version.	No
Object Type	Used to indicate the type of object.	No
Value	Used to specify the value of the object type. Note: It has a link. On clicking the link, respective object type screen appears with the details of the respective object type. The Search (🔍) icon appears corresponding to this field. On clicking the Search icon, the Adjustment Type Search window appears.	No

Note: If you exclude object, then all the fields are mandatory.

Algorithms – This section contains the following columns:

Column Name	Column Description	Mandatory (Yes or No)
System Event	Used to indicates the system event on which the algorithm must be executed.	No
Sequence	Used to specify the order in which the algorithms for each system event must be executed.	No
Algorithm	Used to specify the algorithm code. Note: It has a link. On clicking the link, Algorithm screen appears with the details of the respective algorithm. The Search (🔍) icon appears corresponding to this field. On clicking the Search icon, the Algorithm Search window appears.	No

Note: While defining a financial transaction distribution rule version, you can either include or exclude objects from it.

6. Enter the required details.
7. Define, edit, or remove objects from the financial transaction distribution rule version , if required.
8. Associate or dissociate the algorithms from the financial transaction distribution rule version, if required
9. Click **Save**.

The new financial transaction distribution rule version is defined.

Related Topics

For more information on...	See...
Financial Transaction Distribution Rule screen	Financial Transaction Distribution Rule on page 2091
Financial Transaction Distribution Rule Version List zone	Financial Transaction Distribution Rule Version List on page 2094
Financial Transaction Distribution Rule Version zone	Financial Transaction Distribution Rule Version on page 2095

Viewing the Financial Transaction Distribution Rule Version Details

Procedure

To view the details of a financial transaction distribution rule version:

1. Click the **Admin** link in the **Application** toolbar.
A list appears.
2. From the **Admin** menu, select **F** and then click **Financial Transaction Distribution Rule**.
A sub-menu appears.

- Click the **Search** option from the **Financial Transaction Distribution Rule** sub-menu.

The **Financial Transaction Distribution Rule** screen appears.

- In the **Financial Transaction Distribution Rule List** zone, click the **Broadcast** (📡) icon corresponding to the financial transaction distribution rule whose details you want to view.

The **Financial Transaction Distribution Rule** and **Financial Transaction Distribution Rule Version List** zone appears.

- In the **Financial Transaction Distribution Rule Version List** zone, click the **Broadcast** (📡) icon corresponding to the financial transaction distribution rule version whose details you want to view.

The **Financial Transaction Distribution Rule Version** zone appears.

- View the details of the financial transaction distribution rule version in the **Financial Transaction Distribution Rule Version** zone.

Related Topics

For more information on...	See...
Financial Transaction Distribution Rule screen	Financial Transaction Distribution Rule on page 2091
Financial Transaction Distribution Rule Version List zone	Financial Transaction Distribution Rule Version List on page 2094
Financial Transaction Distribution Rule Version zone	Financial Transaction Distribution Rule Version on page 2095

Expiration Cycle Extendable Lookup

The **Expiration Cycle Extendable Lookup** screen allows you to search for an expiration cycle. An expiration cycle is an extendable lookup reference object which indicates the frequency at which the financial transaction distribution object created for the account should be expired (i.e. after two months or 45 days from the date of creation). You can associate an expiration cycle with one or more accounts. This screen contains the following zone:

- [Extendable Lookup Search](#) on page 2115

Extendable Lookup Search

The **Extendable Lookup Search** zone allows you to search the details of expiration cycle business object. This zone contains the following two sections:

- Search Criteria** – This section contains the following fields:

Field Name	Field Description
Business Object	Used to search the expiration cycle business object.
Description	Used to search the expiration cycle business object with a particular description.

- Search Results** – On clicking the **Search** button, the search results appear based on the specified search criteria. The **Search Results** section contains the following columns:

Column Name	Column Description
Business Object	Displays the business objects.

Column Name	Column Description
Description	Displays description of the business object.
	Note: It has a link. On clicking the link, the Extendable Lookup screen appears where you can view the details of the respective business object.

Note: You must specify at least one search criterion while searching for the expiration cycle business object.

Related Topics

For more information on...	See...
Extendable Lookup screen	Expiration Cycle Extendable Lookup on page 2115
How to search for an expiration cycle	Searching for an Expiration Cycle Extendable Lookup on page 2116

Searching for an Expiration Cycle Extendable Lookup

Prerequisites

To search for an expiration cycle extended lookup, you should have:

- Expiration cycle extended lookup defined in the application.

Procedure

To search for an expiration cycle extended lookup:

1. Click the **Admin** link in the **Application** toolbar.
A list appears.
2. From the **Admin** menu, select **E** and then click **Extendable Lookup**.
The **Extendable Lookup Query** screen appears.
3. Search for **C1-EXPCYCLE** business object.
4. In the **Search Results** section, click the **Description** link corresponding to the **C1-EXPCYCLE** business object.
The **Extended Lookup** screen appears.
5. View the list of expiration cycle extended lookup values in the **Extendable Lookup Value List** zone.

Note:

You must specify at least one search criterion while searching for an expiration cycle extended lookup.

ORMB search engine supports wildcard search, where you can substitute the percentage (%) symbol as a stand in for any word or letter in a search criteria. The '%' wildcard character is suffixed automatically at the end of the partial search criteria. Therefore, you may or may not specify the wildcard character at the end of the partial search criteria. However, you have to prefix the wildcard character manually wherever required.

Related Topics

For more information on...	See...
Expiration Cycle Extendable Lookup screen	Expiration Cycle Extendable Lookup on page 2115
Extendable Lookup screen	Extendable Lookup (Expiration Cycle) on page 2117

For more information on...	See...
Extendable Lookup Value List zone	Extendable Lookup Value List on page 2117

Extendable Lookup (Expiration Cycle)

Once you create an expiration cycle, the **Extendable Lookup** (Expiration Cycle) screen allows you to:

- Edit the details of an expiration cycle
- Copy an expiration cycle
- Delete an expiration cycle
- View the details of an expiration cycle

This screen contains the following zones:

- [Extendable Lookup Value List](#) on page 2117
- [Extendable Lookup Value](#) on page 2118

Extendable Lookup Value List

The **Extendable Lookup Value List** zone allows you to view the list of expiration cycle extended lookup values that are already defined in the system.

This zone contains the following columns:

Column Name	Column Description
Value	Displays the expiration cycle extended lookup value.
Description	Displays the description of the expiration cycle extended lookup value.
Detailed Description	Displays the additional information about the expiration cycle extended lookup value.
Owner	Displays the owner of the expiration cycle extended lookup value.
Edit	On clicking the Edit (✎) icon, the Expiration Cycle screen appears where you can edit the details of the expiration cycle extended lookup value.
Duplicate	On clicking the Duplicate (📄) icon, the Expiration Cycle screen appears where you can define a expiration cycle extended lookup value using an existing expiration cycle extended lookup value.
Delete	On clicking the Delete (🗑) icon, you can delete the expiration cycle extended lookup value.

On clicking the **Broadcast** (📡) icon corresponding to the expiration cycle extended lookup value, the **Extendable Lookup Value** zone appear with the details of the respective expiration cycle extended lookup value.

You can filter the list using the **Value** or **Description** fields available in the **Filter** area. By default, the **Filter** area is hidden. You can view the **Filter** area by clicking the **Filters** (🔍) icon in the upper right corner of this zone.

Related Topics

For more information on...	See...
Extendable Lookup Value zone	Extendable Lookup Value on page 2118
How to edit an expiration cycle	Editing an Expiration Cycle on page 2120
How to copy an expiration cycle	Copying an Expiration Cycle on page 2122
How to delete an expiration cycle	Deleting an Expiration Cycle on page 2121
How to view the details of an expiration cycle	Viewing the Expiration Cycle Details on page 2123

Extendable Lookup Value

The **Extendable Lookup Value** zone allows you to view the details of the expiration cycle extended lookup value. This zone contains the following section:

- **Main** – This section allows you to view the details of the expiration cycle extended lookup value. It contains the following fields:

Field Name	Field Description
Expiration Cycle	Displays the expiration cycle extended lookup value.
Description	Displays the description of the expiration cycle extended lookup value.
Override Description	Displays the overridden description of the expiration cycle extended lookup value.
Detailed Description	Displays the additional information about the expiration cycle extended lookup value.
Status	Displays the status of expiration cycle extended lookup value.
Duration Unit	Displays the duration unit of the expiration cycle extended lookup value.
Duration Value	Displays the period till when the expiration cycle extended lookup value is active.
Consider Holiday	Displays whether to consider holidays or not while calculating the duration value.

- **Record Actions** – This section contains the following buttons:

Button Name	Button Description
Edit	Used to edit the details of the expiration cycle extended lookup value.
Delete	Used to delete the expiration cycle extended lookup value.
Duplicate	Used to create a new expiration cycle extended lookup value using an existing expiration cycle extended lookup value.

- **Record Information** – This section contains the following fields:

Field Name	Field Description
Business Object	Indicates the business object using which the expiration cycle extended lookup value is created. In addition, a context menu appears corresponding to this field which helps in navigating to other screens in the application.

Field Name	Field Description
	Note: It has a link. On clicking the link, the Business Object screen appears with the details of the respective business object.
Owner	Indicates the person or entity that created the expiration cycle business object.

By default, the **Extendable Lookup Value** zone does not appear in the **Extendable Lookup** screen. It appears when you click the **Broadcast** (📡) icon corresponding to the extendable lookup value of the **Extendable Lookup Value List** zone.

Related Topics

For more information on...	See...
How to edit an expiration cycle	Editing an Expiration Cycle on page 2120
How to copy an expiration cycle	Copying an Expiration Cycle on page 2122
How to delete an expiration cycle	Deleting an Expiration Cycle on page 2121

Defining an Expiration Cycle

Procedure

To define an expiration cycle:

1. Click the **Admin** link in the **Application** toolbar.
A list appears.
2. From the **Admin** menu, select **E** and then click **Extended Lookup**.
The **Extended Lookup Query** screen appears.
3. Search for **C1-EXPCYCLE** business object.
4. In the **Search Results** section, click the **Description** link corresponding to the **C1-EXPCYCLE** business object.
The **Extended Lookup** screen appears.
5. Click the **Add** button in the **Page Title** area of the **Extended Lookup** screen.
The **Expiration Cycle** screen appears. It contains the following section:
 - **Main** – Used to specify basic details about the expiration cycle.

Main – This section contains the following fields:

Field Name	Field Description	Mandatory (Yes or No)
Expiration Cycle	Used to specify the value of expiration cycle.	Yes
Description	Used to specify the description of the expiration cycle.	Yes
Override Description	Used to specify the override description of the expiration cycle.	No
Detailed Description	Used to specify the additional information about the expiration cycle.	No

Field Name	Field Description	Mandatory (Yes or No)
Status	Used to indicate the status of the expiration cycle.	No
Duration Unit	Used to indicate the duration unit of the expiration cycle.	Yes
Duration Value	Used to indicate the period till when the expiration cycle is active.	Yes
Consider Holiday	Used to indicate whether to consider the holiday while calculating the duration value.	No

6. Enter the required details.
7. Click **Save**.

The expiration cycle is defined.

Related Topics

For more information on...	See...
Extended Lookup (expiration cycle) screen	Extendable Lookup (Expiration Cycle) on page 2117

Editing an Expiration Cycle

Procedure

To edit an expiration cycle:

1. Search for the **C1-EXPCYCLE** business object in the **Extended Lookup Query** screen.
2. In the **Search Results** section, click the **Description** link corresponding to the **C1-EXPCYCLE** business object.

The **Extended Lookup** screen appears.

3. In the **Extended Lookup Value List** zone, click the **Edit** (✎) icon in the **Edit** column corresponding to the extended lookup value whose details you want to edit.

The **Expiration Cycle** screen appears. It contains the following section:

- **Main** – Used to specify basic details about the expiration cycle.

The **Main** section contains the following fields:

Field Name	Field Description	Mandatory (Yes or No)
Expiration Cycle	Used to specify the value of expiration cycle.	Yes
Description	Used to specify the description of the expiration cycle.	Yes
Override Description	Used to specify the override description of the expiration cycle.	No
Detailed Description	Used to specify the additional information about the expiration cycle.	No

Field Name	Field Description	Mandatory (Yes or No)
Status	Used to indicate the status of the expiration cycle.	No
Duration Unit	Used to indicate the duration unit of the expiration cycle.	Yes
Duration Value	Used to indicate the period till when the expiration cycle is active.	Yes
Consider Holiday	Used to indicate whether to consider the holiday while calculating the duration value.	No

Tip: Alternatively, you can click the **Edit** button in the **Extended Lookup Value** zone to edit the details of the expiration cycle.

4. Modify the details, if required.
5. Click **Save**.

The changes made to the expiration cycle are saved.

Related Topics

For more information on...	See...
Expiration Cycle Extended Lookup screen	Expiration Cycle Extendable Lookup on page 2115
Extended Lookup screen	Extendable Lookup (Expiration Cycle) on page 2117
Extended Lookup Value zone	Extendable Lookup Value on page 2118

Deleting an Expiration Cycle

Procedure

To delete an expiration cycle:

1. Search for the **C1-EXPCYCLE** business object in the **Extended Lookup Query** screen.
2. In the **Search Results** section, click the **Description** link corresponding to the **C1-EXPCYCLE** business object.

The **Extended Lookup** screen appears.

3. In the **Extended Lookup Value List** zone, click the , click the **Delete** (🗑️) icon in the **Delete** column corresponding to the expiration cycle that you want to delete.

A message appears confirming whether you want to delete the expiration cycle.

Tip: Alternatively, you can click the **Delete** button in the **Extended Lookup Value** zone to delete the expiration cycle.

4. Click **OK**.

The expiration cycle is deleted.

Related Topics

For more information on...	See...
Expiration Cycle Extended Lookup screen	Expiration Cycle Extendable Lookup on page 2115
Extended Lookup screen	Extendable Lookup (Expiration Cycle) on page 2117
Extended Lookup Value zone	Extendable Lookup Value on page 2118

Copying an Expiration Cycle

Instead of creating an expiration cycle from scratch, you can create a new expiration cycle using an existing expiration cycle. This is possible through copying an expiration cycle. On copying an expiration cycle, the details are copied to the new expiration cycle. You can then edit the details, if required.

Prerequisites

To copy an expiration cycle, you should have:

- Expiration cycle (whose copy you want to create) defined in the application
- Expiration cycle business objects defined in the application

Procedure

To copy an expiration cycle:

1. Click the **Admin** link in the **Application** toolbar.
A list appears.
2. From the **Admin** menu, select **E** and then click **Extended Lookup**.
The **Extended Lookup Query** screen appears.
3. Search for **C1-EXPCYCLE** business object.
4. In the **Search Results** section, click the **Description** link corresponding to the **C1-EXPCYCLE** business object.
The **Extended Lookup** screen appears.
5. In the **Extended Lookup Value List** zone, click the **Duplicate**  icon in the **Duplicate** column corresponding to the expiration cycle whose copy you want to create.

The **Expiration Cycle** screen appears. It contains the following section:

- **Main** – Used to specify basic details about the expiration cycle.

Main – This section contains the following fields:

Field Name	Field Description	Mandatory (Yes or No)
Expiration Cycle	Used to specify the value of expiration cycle.	Yes
Description	Used to specify the description of the expiration cycle.	Yes
Override Description	Used to specify the override description of the expiration cycle.	No
Detailed Description	Used to specify the additional information about the expiration cycle.	No
Status	Used to indicate the status of the expiration cycle.	No

Field Name	Field Description	Mandatory (Yes or No)
Duration Unit	Used to indicate the duration unit of the expiration cycle.	Yes
Duration Value	Used to indicate the period till when the expiration cycle is active.	Yes
Consider Holiday	Used to indicate whether to consider the holiday while calculating the duration value.	No

Tip: Alternatively, you can click the **Duplicate** button in the **Extended Lookup Value** zone to create a copy of the expiration cycle.

- Enter the required details.
- Click **Save**.

The new expiration cycle is defined.

Related Topics

For more information on...	See...
Expiration Cycle Extended Lookup screen	Expiration Cycle Extendable Lookup on page 2115
Extended Lookup screen	Extendable Lookup (Expiration Cycle) on page 2117
Extended Lookup Value zone	Extendable Lookup Value on page 2118

Viewing the Expiration Cycle Details

Procedure

To view the details of a expiration cycle:

- Click the **Admin** link in the **Application** toolbar.
A list appears.
- From the **Admin** menu, select **E** and then click **Extended Lookup**.
The **Extended Lookup Query** screen appears.
- Search for **C1-EXPCYCLE** business object.
The **Extended Lookup** screen appears.
- In the **Extended Lookup Value List** zone, click the **Broadcast** () icon corresponding to the expiration cycle whose details you want to view.
The **Extended Lookup Value** zone appears.
- View the details of the expiration cycle extended lookup values in the **Extended Lookup Value** zone.

Related Topics

For more information on...	See...
Expiration Cycle Extended Lookup screen	Expiration Cycle Extendable Lookup on page 2115
Extended Lookup screen	Extendable Lookup (Expiration Cycle) on page 2117
Extended Lookup Value zone	Extendable Lookup Value on page 2118

Distribution Hierarchy Extendable Lookup

The **Distribution Hierarchy Extendable Lookup** screen allows you to search for a distribution hierarchy. A distribution hierarchy is an extendable lookup reference object which indicates the list of hierarchies that should be considered while deriving accounts for offsetting the credit or debit amount on the financial transaction distribution object. This screen contains the following zone:

- [Extendable Lookup Search](#) on page 2124

Extendable Lookup Search

The **Extendable Lookup Search** zone allows you to search the details of distribution hierarchy business object. This zone contains the following two sections:

- **Search Criteria** - This section contains the following fields:

Field Name	Field Description
Business Object	Used to search the distribution hierarchy business object.
Description	Used to search the distribution hierarchy business object with a particular description.

- **Search Results** - On clicking the **Search** button, the search results appear based on the specified search criteria. The **Search Results** section contains the following columns:

Column Name	Column Description
Business Object	Displays the business object.
Description	Displays information about the business object. Note: It has a link. On clicking the link, the Extendable Lookup screen appears where you can view the details of the respective business object.

Note: You must specify at least one search criterion while searching for the distribution hierarchy business object.

Related Topics

For more information on...	See...
Extendable Lookup screen	Extendable Lookup (Distribution Hierarchy) on page 2125
How to search for a distribution hierarchy	Searching for a Distribution Hierarchy Extendable Lookup on page 2124

Searching for a Distribution Hierarchy Extendable Lookup

Prerequisites

To search for a distribution hierarchy extended lookup, you should have:

- Distribution hierarchy extended lookup defined in the application.

Procedure

To search for a distribution hierarchy extended lookup:

1. Click the **Admin** link in the **Application** toolbar.

A list appears.

- From the **Admin** menu, select **E** and then click **Extendable Lookup**.

The **Extendable Lookup Query** screen appears.

- Search for **C1-HIERARCHY** business object.

- In the **Search Results** section, click the **Description** link corresponding to the **C1-HIERARCHY** business object.

The **Extended Lookup** screen appears.

- View the list of distribution hierarchy extended lookup values in the **Extendable Lookup Value List** zone.

Note:

You must specify at least one search criterion while searching for a distribution hierarchy extended lookup.

ORMB search engine supports wildcard search, where you can substitute the percentage (%) symbol as a stand in for any word or letter in a search criteria. The '%' wildcard character is suffixed automatically at the end of the partial search criteria. Therefore, you may or may not specify the wildcard character at the end of the partial search criteria. However, you have to prefix the wildcard character manually wherever required.

Related Topics

For more information on...	See...
Distribution Hierarchy Extendable Lookup screen	Distribution Hierarchy Extendable Lookup on page 2124
Extendable Lookup screen	Extendable Lookup (Distribution Hierarchy) on page 2125
Extendable Lookup Value List zone	Extendable Lookup Value List on page 2125

Extendable Lookup (Distribution Hierarchy)

The **Extendable Lookup** (Distribution Hierarchy) screen allows you to add, edit, copy, and delete a distribution hierarchy. This screen contains the following zones:

- [Extendable Lookup Value List](#) on page 2125
- [Extendable Lookup Value](#) on page 2126

Extendable Lookup Value List

The **Extendable Lookup Value List** zone allows you to view the list of distribution hierarchy extended lookup values that are already defined in the system.

This zone contains the following columns:

Column Name	Column Description
Value	Displays the distribution hierarchy extended lookup value.
Description	Displays the description of the distribution hierarchy extended lookup value.
Detailed Description	Displays the additional information about distribution hierarchy extended lookup value.
Owner	Displays the person or entity that created the distribution hierarchy extended lookup value.

Column Name	Column Description
Edit	On clicking the Edit (✎) icon, the Distribution Hierarchy screen appears where you can edit the details of the distribution hierarchy extended lookup value.
Duplicate	On clicking the Duplicate (📄) icon, the Distribution Hierarchy screen appears where you can define a distribution hierarchy extended lookup value using an existing distribution hierarchy extended lookup value.
Delete	On clicking the Delete (🗑) icon, you can delete the distribution hierarchy extended lookup value.

On clicking the **Broadcast** (📡) icon corresponding to the distribution hierarchy extended lookup value, the **Extendable Lookup Value** zone appear with the details of the respective distribution hierarchy extended lookup value.

You can filter the list using the **Value** or **Description** fields available in the **Filter** area. By default, the **Filter** area is hidden. You can view the **Filter** area by clicking the **Filters** (🔍) icon in the upper right corner of this zone.

Related Topics

For more information on...	See...
How to edit a distribution hierarchy	Editing a Distribution Hierarchy on page 2129
How to copy a distribution hierarchy	Copying a Distribution Hierarchy on page 2130
How to delete a distribution hierarchy	Deleting a Distribution Hierarchy on page 2130
How to view the details of a distribution hierarchy	Viewing the Distribution Hierarchy Details on page 2132

Extendable Lookup Value

The **Extendable Lookup Value** zone allows you to view the details of the distribution hierarchy extended lookup value. This zone consists of the following section:

- **Main** - This section lists the distribution hierarchy extended lookup values. It contains the following fields:

Field Name	Field Description
Hierarchy Code	Displays the unique hierarchy code.
Parent Person Relationship Type	Displays the person relationship type used for going in parent hierarchy.
Child Person Relationship Type	Displays the person relationship type used for going in child hierarchy.
Description	Displays the description of the distribution hierarchy extended lookup value.
Override Description	Displays the overridden description of the distribution hierarchy extended lookup value.
Detailed Description	Displays the additional information about the distribution hierarchy extended lookup value.
Status	Displays the status of the distribution hierarchy extended lookup value.

- **Hierarchy List** - This section lists the hierarchy of the distribution. It contains the following columns:

Column Name	Column Description
Sequence	Displays the order of priority according to which the distribution will be made in hierarchy.
Value	Displays the value of hierarchy.

- **Record Actions** - This section contains the following buttons:

Button Name	Button Description
Edit	Used to edit the details of the distribution hierarchy extended lookup value.
Delete	Used to delete the distribution hierarchy extended lookup value.
Duplicate	Used to create a new distribution hierarchy extended lookup value using an existing distribution hierarchy extended lookup value.

- **Record Information** - This section contains the following fields:

Field Name	Field Description
Business Object	Indicates the business object using which the distribution hierarchy extended lookup value is created. In addition, a context menu appears corresponding to this field which helps in navigating to other screens in the application.
	Note: It has a link. On clicking the link, the Business Object screen appears with the details of the respective business object.
Owner	Indicates the person or entity that created the distribution hierarchy business object.

By default, the **Extendable Lookup Value** zone does not appear in the **Extendable Lookup** screen. It appears when you click the **Broadcast** () icon corresponding to the extendable lookup value of the **Extendable Lookup Value List** zone.

Related Topics

For more information on...	See...
How to edit a distribution hierarchy	Editing a Distribution Hierarchy on page 2129
How to copy a distribution hierarchy	Copying a Distribution Hierarchy on page 2130
How to delete a distribution hierarchy	Deleting a Distribution Hierarchy on page 2130
How to view the details of a distribution hierarchy	Viewing the Distribution Hierarchy Details on page 2132

Defining a Distribution Hierarchy

Procedure

To define a distribution hierarchy:

1. Click the **Admin** link in the **Application** toolbar.
A list appears.
2. From the **Admin** menu, select **E** and then click **Extended Lookup**.
The **Extended Lookup Query** screen appears.
3. Search for **C1-HIERARCHY** business object.

- In the **Search Results** section, click the **Description** link corresponding to the **C1-HIERARCHY** business object.

The **Extended Lookup** screen appears.

- Click the **Add** button in the **Page Title** area of the **Extended Lookup** screen.

The **Hierarchy** screen appears. It contains the following sections:

- **Main** – Used to specify basic details about the distribution hierarchy.
- **Hierarchy List** – Used to specify the hierarchy of the distribution.

Main – This section contains the following fields:

Field Name	Field Description	Mandatory (Yes or No)
Hierarchy Code	Displays the unique hierarchy code.	Yes
Parent Person Relationship Type	Displays the person relationship type used for going in parent hierarchy.	No
Child Person Relationship Type	Displays the person relationship type used for going in child hierarchy.	No
Description	Displays the description of the distribution hierarchy extended lookup value.	Yes
Override Description	Displays the overridden description of the distribution hierarchy extended lookup value.	No
Detailed Description	Displays the additional information about the distribution hierarchy extended lookup value.	No
Status	Displays the status of the distribution hierarchy extended lookup value.	No

Hierarchy List – This section contains the following columns:

Column Name	Column Description	Mandatory (Yes or No)
Sequence	Used to indicate the order of priority according to which the distribution will be made in hierarchy.	Yes
Value	Used to specify the value of hierarchy.	Yes

Note:

You must specify at least one hierarchy list while defining a distribution hierarchy.

If you want to specify more than one hierarchy within the hierarchy list, click the **Add (+)** icon in the **Hierarchy List** section and then specify the details. However, if you want to remove a hierarchy from the hierarchy list, click the **Delete (🗑)** icon corresponding to the hierarchy.

- Enter the required details.
- Click **Save**.

The distribution hierarchy is defined.

Related Topics

For more information on...	See...
Extended Lookup screen	Extendable Lookup (Distribution Hierarchy) on page 2125

Editing a Distribution Hierarchy**Procedure**

To edit a distribution hierarchy:

1. Search for the **C1-HIERARCHY** business object in the **Extended Lookup Query** screen.
2. In the **Search Results** section, click the **Description** link corresponding to the **C1-HIERARCHY** business object.

The **Extended Lookup** screen appears.

3. In the **Extended Lookup Value List** zone, click the **Edit** (✎) icon in the **Edit** column corresponding to the extended lookup value whose details you want to edit.

The **Hierarchy** screen appears. It contains the following sections:

- **Main** – Used to specify basic details about the distribution hierarchy.
- **Hierarchy List** – Used to specify the hierarchy of the distribution.

Main – This section contains the following fields:

Field Name	Field Description	Mandatory (Yes or No)
Hierarchy Code	Displays the unique hierarchy code.	Yes
Parent Person Relationship Type	Displays the person relationship type used for going in parent hierarchy.	No
Child Person Relationship Type	Displays the person relationship type used for going in child hierarchy.	No
Description	Displays the description of the distribution hierarchy extended lookup value.	Yes
Override Description	Displays the overridden description of the distribution hierarchy extended lookup value.	No
Detailed Description	Displays the additional information about the distribution hierarchy extended lookup value.	No
Status	Displays the status of the distribution hierarchy extended lookup value.	No

Hierarchy List – This section contains the following columns:

Column Name	Column Description	Mandatory (Yes or No)
Sequence	Used to indicate the order of priority according to which the distribution will be made in hierarchy.	Yes

Column Name	Column Description	Mandatory (Yes or No)
Value	Used to specify the value of hierarchy.	Yes

Note:

You must specify at least one hierarchy list while defining a distribution hierarchy.

If you want to specify more than one hierarchy within the hierarchy list, click the **Add** (+) icon in the **Hierarchy List** section and then specify the details. However, if you want to remove a hierarchy from the hierarchy list, click the **Delete** (🗑️) icon corresponding to the hierarchy.

Tip: Alternatively, you can click the **Edit** button in the **Extended Lookup Value** zone to edit the details of the distribution hierarchy.

4. Modify the details, if required.
5. Add to the hierarchy list, if required.
6. Click **Save**.

The changes made to the distribution hierarchy are saved.

Related Topics

For more information on...	See...
Extended Lookup screen	Extendable Lookup (Distribution Hierarchy) on page 2125

Deleting a Distribution Hierarchy**Procedure**

To delete a distribution hierarchy:

1. Search for the **C1-HIERARCHY** business object in the **Extended Lookup Query** screen.
2. In the **Search Results** section, click the **Description** link corresponding to the **C1-HIERARCHY** business object.

The **Extended Lookup** screen appears.

3. In the **Extended Lookup Value List** zone, click the **Delete** (🗑️) icon in the **Delete** column corresponding to the distribution hierarchy that you want to delete.

A message appears confirming whether you want to delete the distribution hierarchy.

Tip: Alternatively, you can click the **Delete** button in the **Extended Lookup Value** zone to delete the distribution hierarchy.

4. Click **OK**.

The distribution hierarchy is deleted.

Related Topics

For more information on...	See...
Extended Lookup screen	Extendable Lookup (Distribution Hierarchy) on page 2125

Copying a Distribution Hierarchy

Instead of creating a distribution hierarchy from scratch, you can create a new distribution hierarchy using an existing distribution hierarchy. This is possible through copying a distribution hierarchy. On copying a distribution hierarchy, the details are copied to the new distribution hierarchy. You can then edit the details, if required.

Prerequisites

To copy a distribution hierarchy, you should have:

- Distribution hierarchy(whose copy you want to create) defined in the application
- Distribution hierarchy business object defined in the application

Procedure

To copy a distribution hierarchy:

1. Click the **Admin** link in the **Application** toolbar.
A list appears.
2. From the **Admin** menu, select **E** and then click **Extended Lookup**.
The **Extended Lookup Query** screen appears.
3. Search for **C1-HIERARCHY** business object.
4. In the **Search Results** section, click the **Description** link corresponding to the **C1-HIERARCHY** business object.
The **Extended Lookup** screen appears.
5. In the **Extended Lookup Value List** zone, click the **Duplicate**  icon in the **Duplicate** column corresponding to the distribution hierarchy whose copy you want to create.

The **Hierarchy** screen appears. It contains the following sections:

- **Main** – Used to specify basic details about the distribution hierarchy.
- **Hierarchy List** – Used to specify the hierarchy list of distribution.

Main – This section contains the following fields:

Field Name	Field Description	Mandatory (Yes or No)
Hierarchy Code	Displays the unique hierarchy code.	Yes
Parent Person Relationship Type	Displays the person relationship type used for going in parent hierarchy.	No
Child Person Relationship Type	Displays the person relationship type used for going in child hierarchy.	No
Description	Displays the description of the distribution hierarchy extended lookup value.	Yes
Override Description	Displays the overridden description of the distribution hierarchy extended lookup value.	No
Detailed Description	Displays the additional information about the distribution hierarchy extended lookup value.	No
Status	Displays the status of the distribution hierarchy extended lookup value.	No

Hierarchy List – This section contains the following columns:

Column Name	Column Description	Mandatory (Yes or No)
Sequence	Used to indicate the order of priority according to which the distribution will be made in hierarchy.	Yes
Value	Used to specify the value of hierarchy.	Yes

Note:

You must specify at least one hierarchy list while defining a distribution hierarchy.

If you want to specify more than one hierarchy within the hierarchy list, click the **Add** (+) icon in the **Hierarchy List** section and then specify the details. However, if you want to remove a hierarchy from the hierarchy list, click the **Delete** (🗑️) icon corresponding to the hierarchy.

Tip: Alternatively, you can click the **Duplicate** button in the **Extended Lookup Value** zone to create a copy of the distribution hierarchy.

6. Enter the required details.
7. Add to the hierarchy list, if required.
8. Click **Save**.

The new distribution hierarchy is defined.

Related Topics

For more information on...	See...
Extended Lookup screen	Extendable Lookup (Distribution Hierarchy) on page 2125

Viewing the Distribution Hierarchy Details

Procedure

To view the details of a distribution hierarchy:

1. Click the **Admin** link in the **Application** toolbar.
A list appears.
2. From the **Admin** menu, select **E** and then click **Extended Lookup**.
The **Extended Lookup Query** screen appears.
3. Search for **C1-HIERARCHY** business object.
4. In the **Search Results** section, click the **Description** link corresponding to the **C1-HIERARCHY** business object.
The **Extended Lookup** screen appears.
5. In the **Extended Lookup Value List** zone, click the **Broadcast** (📡) icon corresponding to the distribution hierarchy extended lookup value whose details you want to view.
The **Extended Lookup Value** zone appears.
6. View the details of the distribution hierarchy in the **Extended Lookup Value** zone.

Related Topics

For more information on...	See...
Extended Lookup screen	Extendable Lookup (Distribution Hierarchy) on page 2125
Extended Lookup Value List zone	Extendable Lookup Value List on page 2125
Extended Lookup Value zone	Extendable Lookup Value on page 2126

Financial Transaction Distribution Object Extendable Lookup

The **Financial Transaction Distribution Object Extendable Lookup** screen allows you to search for a financial transaction distribution object. A financial transaction distribution object is an extendable lookup reference object which handles all the information related to the transactional data for a credit or debit that will be distributed or in the middle of distribution. It contains the financial transaction source information, expiration dates of the credit, and recipients. This screen contains the following zone:

- [Extendable Lookup Search](#) on page 2133

Extendable Lookup Search

The **Extendable Lookup Search** zone allows you to search the details of financial transaction distribution object business object. This zone contains the following two sections:

- **Search Criteria** - This section contains the following fields:

Field Name	Field Description
Business Object	Used to search the financial transaction distribution object business object.
Description	Used to search the financial transaction distribution object business object with a particular description.

- **Search Results** - On clicking the **Search** button, the search results appear based on the specified search criteria. The **Search Results** section contains the following columns:

Column Name	Column Description
Business Object	Displays the business object.
Description	Displays information about the business object. Note: It has a link. On clicking the link, the Extendable Lookup screen appears where you can view the details of the respective business object.

Note: You must specify at least one search criterion while searching for the financial transaction distribution object business object.

Related Topics

For more information on...	See...
Extendable Lookup screen	Extendable Lookup (Financial Transaction Distribution Object) on page 2134
How to search for a financial transaction distribution object	Searching for a Financial Transaction Distribution Object on page 2144

Extendable Lookup (Financial Transaction Distribution Object)

The **Extendable Lookup** (Financial Transaction Distribution Object) screen allows you to add, edit, copy, and delete a financial transaction distribution object. This screen contains the following zones:

- [Extendable Lookup Value List](#) on page 2134
- [Extendable Lookup Value](#) on page 2135

Extendable Lookup Value List

The **Extendable Lookup Value List** zone allows you to view the list of financial transaction distribution object extended lookup values that are already defined in the system..

This zone contains the following columns:

Column Name	Column Description
Value	Displays the financial transaction distribution object extended lookup value.
Description	Displays the description of the financial transaction distribution object extended lookup value.
Detailed Description	Displays the additional information about financial transaction distribution object extended lookup value.
Owner	Displays the person or entity that created the financial transaction distribution object extended lookup value.
Edit	On clicking the Edit (✎) icon, the Financial Transaction Distribution Object screen appears where you can edit the details of the distribution financial transaction distribution object extended lookup value.
Duplicate	On clicking the Duplicate (📄) icon, the Financial Transaction Distribution Object screen appears where you can define a financial transaction distribution object extended lookup value using an existing financial transaction distribution object extended lookup value.
Delete	On clicking the Delete (🗑) icon, you can delete the financial transaction distribution object extended lookup value.

On clicking the **Broadcast** (📡) icon corresponding to the financial transaction distribution object extended lookup value, the **Extendable Lookup Value** zone appear with the details of the respective financial transaction distribution object extended lookup value.

You can filter the list using the **Value** or **Description** fields available in the **Filter** area. By default, the **Filter** area is hidden. You can view the **Filter** area by clicking the **Filters** (🔍) icon in the upper right corner of this zone.

Related Topics

For more information on...	See...
Extendable Lookup Value zone	Extendable Lookup Value on page 2135
How to edit a financial transaction distribution object	Editing a Financial Transaction Distribution Object on page 2137

For more information on...	See...
How to copy a financial transaction distribution object	Copying a Financial Transaction Distribution Object on page 2139
How to delete a financial transaction distribution object	Deleting a Financial Transaction Distribution Object on page 2139
How to view the details of a financial transaction distribution object	Viewing the Financial Transaction Distribution Object Details on page 2141

Extendable Lookup Value

The **Extendable Lookup Value** zone allows you to view the details of the financial transaction distribution object extended lookup value. This zone consists of the following sections:

- **Main** - This section lists the financial transaction distribution object extended lookup values. It contains the following fields:

Field Name	Field Description
Financial Transaction Distribution Object Code	Displays the financial transaction distribution object code.
Description	Displays the description of the financial transaction distribution object extended lookup value.
Override Description	Displays the overridden description of the financial transaction distribution object extended lookup value.
Detailed Description	Displays the additional information about the financial transaction distribution object extended lookup value.
Status	Displays the status of the financial transaction distribution object extended lookup value.

- **Financial Transaction Distribution Type List** - This section lists the financial transaction distribution types associated to a financial transaction distribution object. It contains the following column:

Column Name	Column Description
Financial Transaction Distribution Type	Lists the financial transaction distribution types to be associated to a financial transaction distribution object.
	Note: It has a link. On clicking the link, the Financial Transaction Distribution Type screen appears where you can view the details of the respective business object.

- **Record Actions** - This section contains the following buttons:

Button Name	Button Description
Edit	Used to edit the details of the financial transaction distribution object extended lookup value.
Delete	Used to delete the financial transaction distribution object extended lookup value.
Duplicate	Used to create a new financial transaction distribution object extended lookup value using an existing financial transaction distribution object extended lookup value.

- **Record Information** - This section contains the following fields:

Field Name	Field Description
Business Object	Indicates the business object using which the financial transaction distribution object extended lookup value is created. In addition, a context menu appears corresponding to this field which helps in navigating to other screens in the application. Note: It has a link. On clicking the link, the Business Object screen appears where you can view the details of the respective business object.
Owner	Indicates the person or entity that created the financial transaction distribution object.

By default, the **Extendable Lookup Value** zone does not appear in the **Extendable Lookup** screen. It appears when you click the **Broadcast** () icon corresponding to the extendable lookup value of the **Extendable Lookup Value List** zone.

Related Topics

For more information on...	See...
How to edit a financial transaction distribution object	Editing a Financial Transaction Distribution Object on page 2137
How to copy a financial transaction distribution object	Copying a Financial Transaction Distribution Object on page 2139
How to delete a financial transaction distribution object	Deleting a Financial Transaction Distribution Object on page 2139

Defining a Financial Transaction Distribution Object

Procedure

To define a financial transaction distribution object:

1. Click the **Admin** link in the **Application** toolbar.
A list appears.
2. From the **Admin** menu, select **E** and then click **Extended Lookup**.
The **Extended Lookup Query** screen appears.
3. Search for **C1-FTDISTOBJECT** business object.
4. In the **Search Results** section, click the **Description** link corresponding to the **C1-FTDISTOBJECT** business object.
The **Extended Lookup** screen appears.
5. Click the **Add** button in the **Page Title** area of the **Extended Lookup** screen.

The **Financial Transaction Distribution Object** screen appears. It contains the following sections:

- **Main** – Used to specify basic details about the distribution hierarchy.
- **Financial Transaction Distribution Type List** – Used to specify the financial transaction distribution types associated to a financial transaction distribution object.

Main – This section contains the following fields:

Field Name	Field Description	Mandatory (Yes or No)
Financial Transaction Distribution Object Code	Used to specify the financial transaction distribution object code.	Yes
Description	Used to specify the description of the financial transaction distribution object extended lookup value.	Yes
Override Description	Used to specify the override description of the financial transaction distribution object extended lookup value.	No
Detailed Description	Used to specify the additional information about the financial transaction distribution object extended lookup value.	No
Status	Used to indicate the status of the financial transaction distribution object extended lookup value.	No

Financial Transaction Distribution Type List – This section contains the following column:

Column Name	Column Description	Mandatory (Yes or No)
Financial Transaction Distribution Type	Used to indicate the financial transaction distribution type to be associated to a financial transaction distribution object.	Yes

Note:

You must specify at least one financial transaction distribution type while defining a financial transaction distribution object.

If you want to specify more than one financial transaction distribution type within the financial transaction distribution type list, click the **Add (+)** icon in the **Financial Transaction Distribution Type List** section and then specify the details. However, if you want to remove a financial transaction distribution type from the financial transaction distribution type list, click the **Delete (🗑)** icon corresponding to the financial transaction distribution type.

6. Enter the required details.
7. Click **Save**.

The financial transaction distribution object is defined.

Related Topics

For more information on...	See...
Extended Lookup screen	Extendable Lookup (Financial Transaction Distribution Object) on page 2134

Editing a Financial Transaction Distribution Object

Procedure

To edit a financial transaction distribution object:

1. Search for the **C1-FTDISTOBJECT** business object in the **Extended Lookup Query** screen.
2. In the **Search Results** section, click the **Description** link corresponding to the **C1-FTDISTOBJECT** business object.

The **Extended Lookup** screen appears.

3. In the **Extended Lookup Value List** zone, click the **Edit** (✎) icon in the **Edit** column corresponding to the extended lookup value whose details you want to edit.

The **Financial Transaction Distribution Object** screen appears. It contains the following sections:

- **Main** – Used to specify basic details about the financial transaction distribution object.
- **Financial Transaction Distribution Type List** – Used to specify the financial transaction distribution types associated to a financial transaction distribution object.

Main – This section contains the following fields:

Field Name	Field Description	Mandatory (Yes or No)
Financial Transaction Distribution Object Code	Used to specify the financial transaction distribution object code.	Yes
Description	Used to specify the description of the financial transaction distribution object extended lookup value.	Yes
Override Description	Used to specify the override description of the financial transaction distribution object extended lookup value.	No
Detailed Description	Used to specify the additional information about the financial transaction distribution object extended lookup value.	No
Status	Used to indicate the status of the financial transaction distribution object extended lookup value.	No

Financial Transaction Distribution Type List – This section contains the following columns:

Column Name	Column Description	Mandatory (Yes or No)
Financial Transaction Distribution Type	Used to indicate the financial transaction distribution type to be associated to a financial transaction distribution object.	Yes

Note:

You must specify at least one financial transaction distribution type while defining a financial transaction distribution object.

If you want to specify more than one financial transaction distribution type within the financial transaction distribution type list, click the **Add** (+) icon in the **Financial Transaction Distribution Type List** section and then specify the details. However, if you want to remove a financial transaction distribution type from the financial transaction distribution type list, click the **Delete** (🗑) icon corresponding to the financial transaction distribution type.

Tip: Alternatively, you can click the **Edit** button in the **Extended Lookup Value** zone to edit the details of the financial transaction distribution object.

4. Modify the details, if required.
5. Add financial transaction distribution type, if required.
6. Click **Save**.

The changes made to the financial transaction distribution object are saved.

Related Topics

For more information on...	See...
Extended Lookup screen	Extendable Lookup (Financial Transaction Distribution Object) on page 2134

Deleting a Financial Transaction Distribution Object

Procedure

To delete a financial transaction distribution object:

1. Search for the **C1-FTDISTOBJECT** business object in the **Extended Lookup Query** screen.
2. In the **Search Results** section, click the **Description** link corresponding to the **C1-FTDISTOBJECT** business object.

The **Extended Lookup** screen appears.

3. In the **Extended Lookup Value List** zone, click the **Delete** (🗑️) icon in the **Delete** column corresponding to the financial transaction distribution object that you want to delete.

A message appears confirming whether you want to delete the financial transaction distribution object.

Tip: Alternatively, you can click the **Delete** button in the **Extended Lookup Value** zone to delete the financial transaction distribution object.

4. Click **OK**.

The financial transaction distribution object is deleted.

Related Topics

For more information on...	See...
Extended Lookup screen	Extendable Lookup (Financial Transaction Distribution Object) on page 2134

Copying a Financial Transaction Distribution Object

Instead of creating a financial transaction distribution object from scratch, you can create a new financial transaction distribution object using an existing financial transaction distribution object: This is possible through copying a financial transaction distribution object. On copying a distribution hierarchy, the details are copied to the new financial transaction distribution object. You can then edit the details, if required.

Prerequisites

To copy a financial transaction distribution object, you should have:

- Financial transaction distribution object(whose copy you want to create) defined in the application

- Financial transaction distribution object business object defined in the application

Procedure

To copy a financial transaction distribution object:

1. Click the **Admin** link in the **Application** toolbar.

A list appears.

2. From the **Admin** menu, select **E** and then click **Extended Lookup**.

The **Extended Lookup Query** screen appears.

3. Search for **C1-FTDISTOBJECT** business object.

4. In the **Search Results** section, click the **Description** link corresponding to the **C1-FTDISTOBJECT** business object.

The **Extended Lookup** screen appears.

5. In the **Extended Lookup Value List** zone, click the **Duplicate** (📄) icon in the **Duplicate** column corresponding to the financial transaction distribution object whose copy you want to create.

The **Financial Transaction Distribution Object** screen appears. It contains the following sections:

- **Main** – Used to specify basic details about the financial transaction distribution object.
- **Financial Transaction Distribution Type List** – Used to specify the financial transaction distribution types associated to a financial transaction distribution object.

Main – This section contains the following fields:

Field Name	Field Description	Mandatory (Yes or No)
Financial Transaction Distribution Object Code	Used to specify the financial transaction distribution object code.	Yes
Description	Used to specify the description of the financial transaction distribution object extended lookup value.	Yes
Override Description	Used to specify the override description of the financial transaction distribution object extended lookup value.	No
Detailed Description	Used to specify the additional information about the financial transaction distribution object extended lookup value.	No
Status	Used to indicate the status of the financial transaction distribution object extended lookup value.	No

Financial Transaction Distribution Type List – This section contains the following columns:

Column Name	Column Description	Mandatory (Yes or No)
Financial Transaction Distribution Type	Used to indicate the financial transaction distribution type to be associated to a financial transaction distribution object.	Yes

Note:

You must specify at least one financial transaction distribution type while defining a financial transaction distribution object.

If you want to specify more than one financial transaction distribution type within the financial transaction distribution type list, click the **Add (+)** icon in the **Financial Transaction Distribution Type List** section and then specify the details. However, if you want to remove a financial transaction distribution type from the financial transaction distribution type list, click the **Delete (🗑)** icon corresponding to the financial transaction distribution type.

Tip: Alternatively, you can click the **Duplicate** button in the **Extended Lookup Value** zone to create a copy of the financial transaction distribution object.

6. Enter the required details.
7. Add financial transaction distribution type, if required.
8. Click **Save**.

The new financial transaction distribution object is defined.

Related Topics

For more information on...	See...
Extended Lookup screen	Extendable Lookup (Financial Transaction Distribution Object) on page 2134

Viewing the Financial Transaction Distribution Object Details**Procedure**

To view the details of a financial transaction distribution object:

1. Click the **Admin** link in the **Application** toolbar.
A list appears.
2. From the **Admin** menu, select **E** and then click **Extended Lookup**.
The **Extended Lookup Query** screen appears.
3. Search for **C1-FTDISTOBJECT** business object.
4. In the **Search Results** section, click the **Description** link corresponding to the **C1-FTDISTOBJECT** business object.
The **Extended Lookup** screen appears.
5. In the **Extended Lookup Value List** zone, click the **Broadcast (📡)** icon corresponding to the financial transaction distribution object extended lookup value whose details you want to view.
The **Extended Lookup Value** zone appears.
6. View the details of the financial transaction distribution object in the **Extended Lookup Value** zone.

Related Topics

For more information on...	See...
Extended Lookup screen	Extendable Lookup (Financial Transaction Distribution Object) on page 2134

For more information on...	See...
Extended Lookup Value List zone	Extendable Lookup Value List on page 2134
Extended Lookup Value zone	Extendable Lookup Value on page 2135

Financial Transaction Distribution (Used for Searching)

The **Financial Transaction Distribution** screen allows you to search a financial transaction distribution object using various search criteria. This screen contains the following zone:

- [Financial Transaction Distribution Search](#) on page 2142

Financial Transaction Distribution Search

The **Financial Transaction Distribution Search** zone allows you to search the details of the financial transaction distribution using various search criteria. This zone contains the following two sections:

- **Search Criteria** – This section contains the following fields:

Field Name	Field Description
Search By	Used to indicate whether you want to search for financial transaction distribution object using which of the following options: <ul style="list-style-type: none"> • FT Distribution Type/Status/Expiry Date • FT Distribution ID
FT Distribution ID	Used to specify the financial transaction distribution ID. Note: This field appears when you select the FT Distribution ID option from the Search By list.
FT Distribution Type	Used to indicate the financial transaction distribution type against which the object is created. Note: This field appears only when you select the FT Distribution Type/Status/Expiry Date option from the Search By list. The Search (🔍) icon appears corresponding to this field. On clicking the Search icon, the Financial Transaction Distribution Type FK Search window appears.
FT Object Type	Used to indicate the business object that was used to create the financial transaction distribution type. Note: This field appears when you select the FT Distribution Type/Status/Expiry Date option from the Search By list.
Contract	Used to specify the contract on which financial transaction distribution object is created.

Field Name	Field Description
	<p>Note:</p> <p>This field appears when you select the FT Distribution Type/Status/Expiry Date option from the Search By list.</p> <p>The Search (🔍) icon appears corresponding to this field. On clicking the Search icon, the Contract Search window appears.</p>
Expiration Date	<p>Used to specify the credit expiration date of the financial transaction distribution object.</p> <p>Note: This field appears when you select the FT Distribution Type/Status/Expiry Date option from the Search By list.</p>
Status	<p>Used to indicate the status of the financial transaction distribution object.</p> <p>Note: This field appears when you select the FT Distribution Type/Status/Expiry Date option from the Search By list.</p>

- **Search Results** — On clicking the **Search** button, the search results appear based on the specified search criteria. The **Search Results** section contains the following columns:

Column Name	Column Description
Information	<p>Indicates the information about the financial transaction distribution object.</p> <p>Note: It has a link. On clicking the link, the Financial Transaction Distribution screen appears with the details of the respective financial transaction distribution.</p>
Status	Indicates the status of financial transaction distribution object.
Financial Transaction Distribution Type	<p>Indicates the financial transaction distribution type information against which the object is created.</p> <p>Note: It has a link. On clicking the link, the Financial Transaction Distribution Type screen appears where you can view the details of the respective financial transaction distribution type.</p>
Contract	<p>Indicates the contract information on which the financial transaction distribution object is created.</p> <p>Note: It has a link. On clicking the link, the Contract screen appears with the details of the respective contract.</p>
Create Date Time	Displays the date and time when the financial transaction distribution object is created.
Expiration Date	Displays the expiration date of the financial transaction distribution object.

Related Topics

For more information on...	See...
Financial Transaction Distribution screen	Financial Transaction Distribution (Used for Viewing) on page 2145
How to search for a financial transaction distribution	Searching for a Financial Transaction Distribution Object on page 2144

Searching for a Financial Transaction Distribution Object

Prerequisites

To search for a financial transaction distribution, you should have:

- Financial transaction distribution types defined in the application.

Procedure

To search for a financial transaction distribution:

1. Click the **Menu** link in the **Application** toolbar.
A list appears.
2. From the **Main** menu, select **Accounting and Receivable** and then click **Financial Transaction Distribution**.
The **Financial Transaction Distribution** screen appears.
3. Enter the search criteria in the **Financial Transaction Distribution Search** zone depending on whether you want to search for a financial transaction distribution.

Note: ORMB search engine supports wildcard search, where you can substitute the percentage (%) symbol as a stand in for any word or letter in a search criteria. The '%' wildcard character is suffixed automatically at the end of the partial search criteria. Therefore, you may or may not specify the wildcard character at the end of the partial search criteria. However, you have to prefix the wildcard character manually wherever required. In case of **Financial Transaction Distribution ID**, wild card search is not supported.

Related Topics

For more information on...	See...
Financial Transaction Distribution screen	Financial Transaction Distribution (Used for Viewing) on page 2145
Financial Transaction Distribution Search zone	Financial Transaction Distribution Search on page 2142

Viewing the Financial Transaction Distribution Details

Procedure

To view the details of a financial transaction distribution :

1. Search for the financial transaction distribution in the **Financial Transaction Distribution** screen.
2. In the **Search Results** section, click the link in the **Information** column corresponding to the financial transaction distribution whose details you want to view.

The **Financial Transaction Distribution** screen appears. It consists of the following tabs:

- **Main** – Displays information about the financial transaction distribution. It contains the following zone:
 - **Financial Transaction Distribution** – Displays the details of the financial transaction distribution object.

- **Log** – Lists the complete trail of actions performed on the financial transaction distribution object.
3. View the details of the financial transaction distribution in the **Financial Transaction Distribution** zone.

Related Topics

For more information on...	See...
Financial Transaction Distribution Type screen	
Financial Transaction Distribution Search zone	

Financial Transaction Distribution (Used for Viewing)

The **Financial Transaction Distribution** screen allows you to view the details of the financial transaction distribution. This screen consists of the following tabs:

- [Financial Transaction Distribution - Main](#) on page 2145
- [Financial Transaction Distribution - Log](#) on page 2147

Financial Transaction Distribution - Main

The **Main** tab on the **Financial Transaction Distribution** screen contains the following zone:

- [Financial Transaction Distribution](#) on page 2145

Financial Transaction Distribution

The **Financial Transaction Distribution** zone displays the details of the financial transaction distribution types that are already defined in the system. This zone consists of the following sections:

- **Main** – This section provides basic information about the financial transaction distribution type. It contains the following fields:

Field Name	Field Description
Information	Indicates the information about the financial transaction distribution object.
FT Distribution Type	Displays the financial transaction distribution type. Note: It has a link. On clicking the link, the Financial Transaction Distribution Type screen appears with the details of the respective financial transaction distribution type. The Search (🔍) icon appears corresponding to this field. On clicking the Search icon, the Financial Transaction Distribution Type FK Search window appears.
Account	Indicates the account on which the financial transaction distribution object is distributed. In addition, a context menu appears corresponding to this field which helps in navigating to other screens in the application.

Field Name	Field Description
	<p>Note: It has a link. On clicking the link, the Account screen appears where you can view the details of the respective account.</p>
Contract	<p>Indicates the contract on which the financial transaction distribution object is distributed. In addition, a context menu appears corresponding to this field which helps in navigating to other screens in the application.</p> <p>Note:</p> <p>It has a link. On clicking the link, the Contract screen appears where you can view the details of the respective account.</p> <p>The Search (🔍) icon appears corresponding to this field. On clicking the Search icon, the Contract Search window appears.</p>
Status	Indicates the status of the financial transaction distribution object.
Financial Transaction ID	Displays the financial transaction ID.
Bill segment	<p>Indicates the bill segment information on which the financial transaction distribution object is distributed. a context menu appears corresponding to this field which helps in navigating to other screens in the application.</p> <p>Note: It has a link. On clicking the link, the Bill Segment screen appears where you can view the details of the respective bill segment.</p>
Amount	Displays the distributed amount.
Expiration Date	Displays the expiration date of the financial transaction distribution object.

- **Distribution List** – This section displays the distribution list of the financial transaction distribution object. It contains the following columns:

Column Name	Column Description
Account	<p>Indicates the account on which the financial transaction distribution object is distributed. In addition, a context menu appears corresponding to this field which helps in navigating to other screens in the application.</p> <p>Note: It has a link. On clicking the link, the Account screen appears where you can view the details of the respective account.</p>
Contract	<p>Indicates the contract on which the financial transaction distribution object is distributed. In addition, a context menu appears corresponding to this field which helps in navigating to other screens in the application.</p> <p>Note: It has a link. On clicking the link, the Contract screen appears where you can view the details of the respective account.</p>
Transfer Adjustment	Indicates the transfer adjustments made on the financial transaction distribution object.

Column Name	Column Description
Distribution Amount	Displays the distributed amount.

- **Characteristics** – This section lists the characteristics of the financial transaction distribution type. It contains the following columns:

Column Name	Column Description
Effective Date	Displays the date from when the characteristic is effective for the financial transaction distribution object.
Characteristic Type	Indicates the characteristic type.
Characteristic Value	Displays the value of the characteristic type.

- **Record Information** – This section contains the following fields:

Field Name	Field Description
Business Object	Indicates the business object using which the financial transaction distribution object is created. In addition, a context menu appears corresponding to this field which helps in navigating to other screens in the application. Note: It has a link. On clicking the link, the Business Object screen appears where you can view the details of the respective business object.
Status Date/Time	Displays the date and time when the financial transaction distribution object status is updated.
Create Date/Time	Displays the date and time when the financial transaction distribution object is created.

Related Topics

For more information on...	See...
How to search a financial transaction distribution	Searching for a Financial Transaction Distribution Object on page 2144
How to view the details of a financial transaction distribution	Viewing the Financial Transaction Distribution Details on page 2144

Financial Transaction Distribution - Log

The **Log** tab contains the following zone:

- [Financial Transaction Distribution Log](#) on page 2147

Financial Transaction Distribution Log

The **Financial Transaction Distribution Log** zone on the **Financial Transaction Distribution** screen lists the complete trail of actions performed on the financial transaction distribution object. This zone contains the following columns:

Column Name	Column Description
Date/Time	Displays the date and time when the action was performed on the financial transaction distribution object.
Details	Displays the details about the action performed on the financial transaction distribution object.

Column Name	Column Description
User	Indicates the user who has performed the action on the financial transaction distribution object.
Log Type	Indicates the type of log.
Related Object	Indicates the object or entity which is generated when the action is performed on the financial transaction distribution object.
Status Reason	Displays the status reason of action performed on the financial transaction distribution object.

Note: You can manually add a log entry for the financial transaction distribution object by clicking the **Add Log Entry** link in the upper right corner of the **Financial Transaction Distribution** zone.

The **Add Log Entry** window appears. Enter **Log Details** and click **Save**. The financial transaction distribution object log is added.

Related Topics

For more information on...	See...
How to view the log of a financial transaction distribution	Viewing the Log of a Financial Transaction Distribution on page 2148

Viewing the Log of a Financial Transaction Distribution

Procedure

To view the log of a financial transaction distribution:

1. Search for the financial transaction distribution object in the **Financial Transaction Distribution** screen.
2. In the **Search Results** section, click the link in the **Information** column corresponding to the financial transaction distribution object whose log you want to view.

The **Financial Transaction Distribution** screen appears. It consists of the following tabs:

- **Main** – Displays information about the financial transaction distribution. It contains the following zone:
 - **Financial Transaction Distribution** – Displays information about the financial transaction distribution object.
- **Log** – Lists the complete trail of actions performed on the financial transaction distribution object. This tab contains the following zone:
 - **Financial Transaction Distribution Log** – Displays the trail of actions performed on the particular financial transaction distribution object.

3. Click the **Log** tab.

4. View the log of a financial transaction distribution in the **Financial Transaction Distribution Log** zone.

Related Topics

For more information on...	See...
Financial Transaction Distribution Log zone	Financial Transaction Distribution Log on page 2147
How to search for a financial transaction distribution	Searching for a Financial Transaction Distribution Object on page 2144
How to add a log entry for a financial transaction distribution	Adding a Log Entry for a Financial Transaction Distribution on page 2149

Adding a Log Entry for a Financial Transaction Distribution

Procedure

To add a log entry for a financial transaction distribution:

1. Search for the financial transaction distribution object in the **Financial Transaction Distribution** screen.
2. In the **Search Results** section, click the link in the **Information** column corresponding to the financial transaction distribution whose log you want to edit.

The **Financial Transaction Distribution** screen appears. It consists of the following tabs:

- **Main** – Displays information about the financial transaction distribution. It contains the following zone:
 - **Financial Transaction Distribution** – Displays information about the financial transaction distribution object.
- **Log** – Lists the complete trail of actions performed on the financial transaction distribution object. This tab contains the following zone:
 - **Financial Transaction Distribution Log** – Displays the trail of actions performed on the particular financial transaction distribution object.

3. Click the **Log** tab.

The **Log** tab appears.

4. Click the **Add Log Entry** link in the upper right corner of the **Financial Transaction Distribution Log** zone.

The **Add Log Entry** window appears. It contains the following fields:

Field Name	Field Description	Mandatory (Yes or No)
Financial Transaction Distribution	Displays information about the financial transaction distribution object.	Not applicable
Log Details	Used to specify additional comments for the financial transaction distribution object.	Yes

5. Enter the comments in the **Log Details** field.
6. Click **Save**.

The log entry is added in the **Financial Transaction Distribution Log** zone.

Related Topics

For more information on...	See...
How to search for a financial transaction distribution	Searching for a Financial Transaction Distribution Object on page 2144

Chapter

33

Deferred Revenue Recognition

Topics:

- [Prerequisites](#)
- [Deferred Revenue Recognition Status Transition](#)
- [Algorithms Used in Deferred Revenue Recognition](#)
- [Deferred Revenue Recognition Template \(Used for Searching\)](#)
- [Deferred Revenue Recognition Template \(Used for Viewing\)](#)
- [Deferred Revenue Recognition \(Used for Searching\)](#)
- [Deferred Revenue Recognition \(Used for Viewing\)](#)

Most often, insurance company bill policies in installments, but Accounts Receivable (AR) and revenue for the total premium are booked as new business in the beginning of the policy term. Regulations, restrictions, or company policies may require that revenue for the total premium must be initially booked to the general ledger as deferred revenue. As time passes, the deferred revenue is realized as earned revenue. For example, the total premium for six months auto-policy (July 1 to Dec 31) is \$1200. When this new business is booked, the revenue of \$1200 is initially booked as deferred revenue. However, on July 31, August 31, September 30, October 31, November 30, and December 31, \$200 must be transferred from deferred revenue GL to earned revenue GL. In order to manage this process, adjustments are created that transfer amount from deferred revenue GL to earned revenue GL.

A deferred revenue recognition schedule determines when these deferred revenue recognition adjustments must be created and posted. On the recognition date, the deferred revenue recognition adjustment is created to transfer a portion of deferred revenue to earned revenue. The corresponding financial transaction does not impact customer's account balance.

You need to create a deferred revenue recognition template for each distribution code and contract type combination for which you want to create a deferred revenue recognition (when the bill segment and adjustment financial transactions created against the respective contracts are frozen). It is the deferred revenue recognition template which helps the system to determine:

- Adjustment type using which the adjustment should be created when the deferred revenue is recognized
- Whether the recognition amount and date in the deferred revenue recognition schedule are editable until recognized
- Whether the deferred revenue recognition schedule must be generated automatically or manually
- Whether the deferred revenue must be recognized daily, weekly, or monthly
- Whether the deferred revenue amount must be prorated when the recognition schedule is set to Monthly
- Algorithm using which the recognition lines in the deferred revenue recognition schedule should be created
- Algorithm using which the adjustment must be generated when the deferred revenue is recognized

During the deferred revenue recognition process, a deferred revenue recognition creation goes through various statuses in its lifecycle. For more information

about the deferred revenue recognition statuses, see [Deferred Revenue Recognition Status Transition](#) on page 2153.

Note: The lifecycle of a deferred revenue recognition creation is driven by the respective business object using which the deferred revenue recognition is generated. The deferred revenue recognition feature explained in this document is articulated based on the lifecycle and logic defined in the business objects.

For more information on how to setup the deferred revenue recognition process, see [Prerequisites](#) on page 2153.

Prerequisites

To setup the deferred revenue recognition feature, you need to do the following:

- Define the required deferred revenue recognition templates in the system.
- Define the required characteristic types where the characteristic entity is set to **Deferred Revenue Recognition**.
- Define the values for the following parameters in the **C1-REVRECITM** algorithm:
 - Use Calendar or Business Days (C or B)
 - Override Default Recognition Date (Y or N)
 - Override Default Weekly Recognition Day (Mon, Tue, Wed, Thu, Fri, Sat, Sun)
 - Override Default Monthly Recognition Date (1-31)
- Define the value for the **Use Contract Expiration Date (Y or N)** parameter in the **C1-REVRECSCH** algorithm.
- Define the value for the **Create Adjustments (Y or N)** parameter in the **C1-REVITMREC** algorithm.
- Set the batch control type of the **Deferred Revenue Recognition Periodic Monitor (C1-RRSMO)** batch to **Timed** and define the following attributes:
 - Time Interval
 - Timer Active
 - User ID
 - Batch Language
 - Email Address

Deferred Revenue Recognition Status Transition

The following figure graphically indicates how a deferred revenue recognition status transition moves from one status to another:

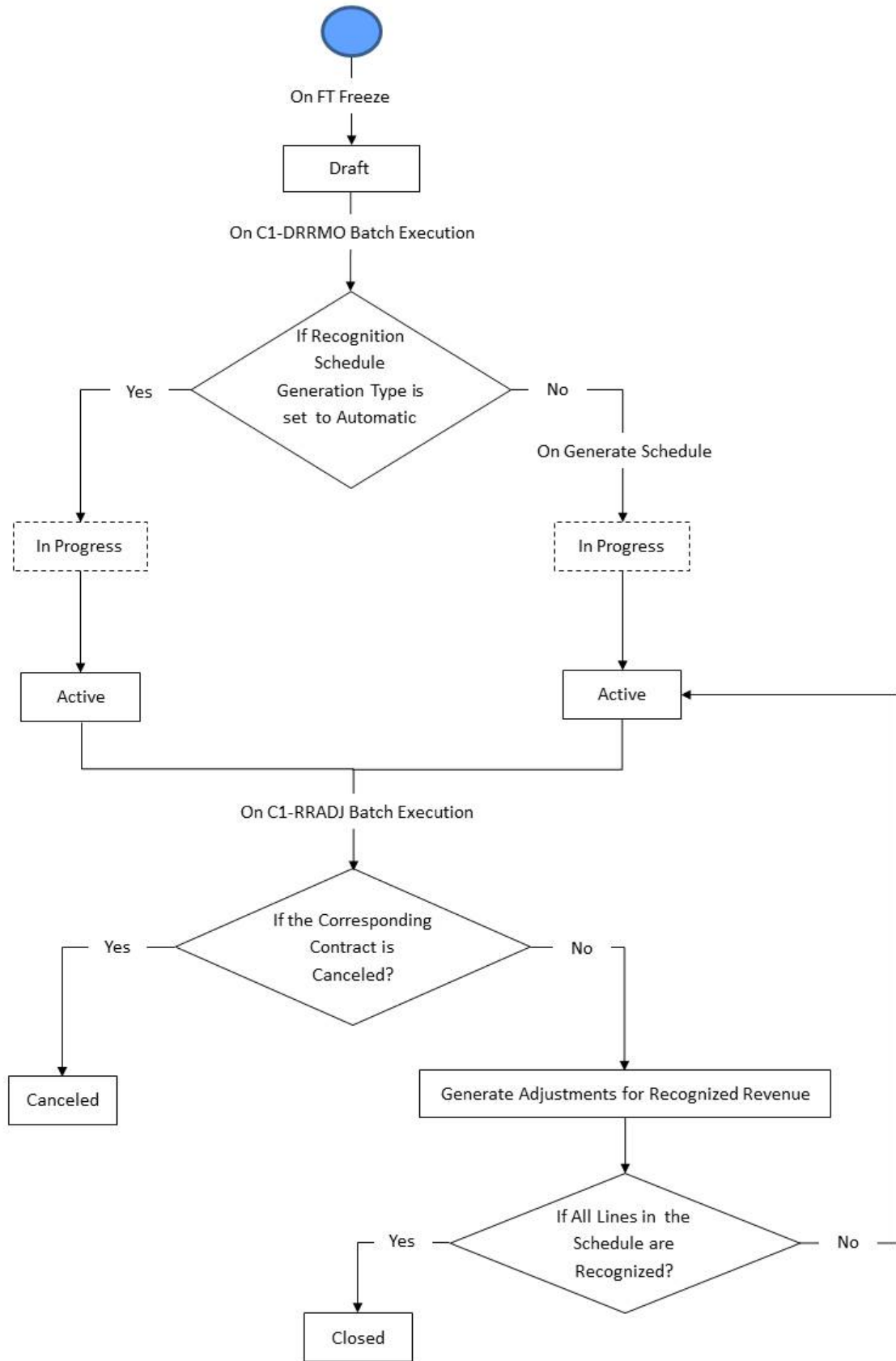

Algorithms Used in Deferred Revenue Recognition

The following table lists the algorithms which are used in the lifecycle of the business object:

Status	System Event	Algorithm	Algorithm Type	Description
		C1-REVRECSCH	C1-REVRECSCH	<p>This algorithm is invoked when the status of the bill segment and adjustment financial transactions created against the contracts (of the contract type to which the algorithm is attached) is set to Frozen. It checks whether an active deferred revenue recognition template exists for the distribution code and contract type combination. If so, it creates a deferred revenue recognition using the template and sets the status of the deferred revenue recognition to Draft. It then checks whether the type of the corresponding financial transaction is Bill Segment or Adjustment. If the type of the corresponding financial transaction is Bill Segment, it sets the valid until date of the deferred revenue recognition to the bill segment end date. However, if the type of the corresponding financial transaction is Adjustment, it checks whether the Use Contract Expiration Date (Y or N) parameter is set to Y or N. If the Use Contract Expiration Date (Y or N) parameter is set to Y, it sets the valid until date of the deferred revenue recognition to the contract expiration date. However, if the Use Contract Expiration Date (Y or N) parameter is set to N, it sets the valid until date of the deferred revenue recognition to the financial transaction arrears date. In addition, on creating the deferred revenue recognition, an appropriate log entry is added which you can view in the Deferred Revenue Recognition Log zone. It contains the following parameter:</p> <ul style="list-style-type: none"> • Use Contract Expiration Date (Y or N) – Used to indicate whether the valid until date must be set to the contract expiration date when the type of the corresponding financial transaction is Adjustment. The valid values are Y and N. This parameter is mandatory.
		C1-REVRECITM	C1-REVRECITM	<p>This algorithm creates schedule for the deferred revenue recognition. It considers the valid until date and accordingly creates the recognition lines within the schedule.</p>

Status	System Event	Algorithm	Algorithm Type	Description
				<p>If the recognition schedule is Weekly, by default, the recognition day is set to Mon (which means Monday of each week). However, if the recognition schedule is Monthly, by default, the recognition date is set to the last day of the month (i.e. 28, 29, 30, or 31) It contains the following parameters:</p> <ul style="list-style-type: none"> • Use Calendar or Business Days (C or B) - Used to indicate whether you want to use the calendar or business days while generating the recognition schedule. The business days are derived using the work calendar defined on the financial transaction. If you do not specify any value for this parameter, by default, it is set to C. This parameter is mandatory. • Override Default Recognition Date (Y or N) – Used to indicate whether you want to override the default weekly or monthly recognition date. The valid values are Y and N. This parameter is mandatory. • Override Default Weekly Recognition Day (Mon, Tue, Wed, Thu, Fri, Sat, Sun) – Used to indicate the day of the week when you want to recognize the deferred revenue. The valid values are Mon, Tue, Wed, Thu, Fri, Sat, and Sun. This parameter is required when you want to override the default weekly recognition day. • Override Default Monthly Recognition Date (1-31) - Used to indicate the day of the month when you want to recognize the deferred revenue. The valid values are 1, 2, 3, ..., 31. This parameter is required when you want to override the default monthly recognition date.
		C1-REVRECADJ	C1-REVRECADJ	<p>This algorithm creates deferred revenue recognition adjustment using the adjustment type defined on the respective deferred revenue recognition template. Before creating the deferred revenue recognition adjustment, it checks whether the contract for which the deferred revenue recognition is created is cancelled. If so, the status of the deferred revenue recognition is set</p>

Status	System Event	Algorithm	Algorithm Type	Description
				to Canceled. If all lines in the recognition schedule are recognized, the status of the deferred revenue recognition is set to Closed.
		C1-REVITMREC	C1-REVITMREC	<p>If this algorithm is attached in the deferred revenue recognition template, it is invoked while executing the C1-RRADJ batch. It contains the following parameter:</p> <ul style="list-style-type: none"> • Create Adjustments (Y or N) – Used to indicate whether the deferred revenue recognition adjustment must be created or not when the recognition date is earlier than or equal to the batch business date. The valid values are Y and N. This parameter is mandatory.
		C1-DRRTM-INF	C1-DRRTM-INF	<p>This algorithm generates the deferred revenue recognition template information string which appears throughout the application. It concatenates the following fields separated by a comma in the specified order:</p> <ol style="list-style-type: none"> 1. Deferred Revenue Recognition Template 2. Description
		C1-DRRTMPVAL	C1-DRRTMPVAL	<p>This algorithm validates the deferred revenue recognition template. It checks the following:</p> <ul style="list-style-type: none"> • Whether the data is specified in the mandatory fields, such as Deferred Revenue Recognition Template, Description, Status, Distribution Code, Contract Type, Adjustment Type, Recognition Schedule Generation Type, and Recognition Schedule. • Whether an algorithm is attached to the Create Deferred Revenue Recognition Schedule and Generate Deferred Revenue Recognition Adjustment system events. • Whether a deferred revenue recognition template already exists for the specified distribution code and contract type combination. • Whether special characters except underscore are specified in the

Status	System Event	Algorithm	Algorithm Type	Description
				<p>Deferred Revenue Recognition Template field.</p> <ul style="list-style-type: none"> Whether the high proration limit is between 0 to 31 and is greater than the low proration limit.>> Whether the low proration limit is between 0 to 31 and is less than the high proration limit. <p>In addition, it does not allow you to:</p> <ul style="list-style-type: none"> Delete a deferred revenue recognition template when it is used to create a deferred revenue recognition. Edit a deferred revenue recognition template when the corresponding deferred revenue recognition is in the Draft status. Inactivate a deferred revenue recognition template when the corresponding deferred revenue recognition is not in the Closed status. <p>You must attach this validation algorithm to the custom business object which is used to create a deferred revenue recognition template. Otherwise, erroneous results might occur.</p>
		C1-DRRSC-INF	C1-DRRSC-INF	<p>This algorithm generates the deferred revenue recognition information string which appears throughout the application. It concatenates the following fields separated by a comma in the specified order:</p> <ol style="list-style-type: none"> Deferred Revenue Recognition Template Deferred Revenue Recognition Status Distribution Code Deferred Revenue Recognition ID
		C1-REVMON	C1-REVMON	<p>This algorithm is invoked when the C1-DRRMO batch is executed. It checks whether there are any deferred revenue recognitions in the Draft status. If there is any deferred revenue recognition in the Draft status, it checks whether the recognition schedule generation type in the respective deferred revenue recognition template is set to Automatic or Manual. If the recognition schedule generation type is set to Automatic, the status</p>

Status	System Event	Algorithm	Algorithm Type	Description
				of the deferred revenue recognition is changed to In Progress. However, if the recognition schedule generation type is set to Manual, the status of the deferred revenue recognition remains as Draft.
		C1-REVRECINP	C1-REVRECINP	This algorithm creates an appropriate log entry when the status of the deferred revenue recognition is changed to In Progress. It invokes the algorithm attached to the Create Deferred Revenue Recognition Schedule system event of the respective deferred revenue recognition template. Once the recognition schedule is successfully created, the status of the deferred revenue recognition is changed to Active.
		C1-REVRECACT	C1-REVRECACT	<p>This algorithm transitions the current status to the specified status. You can specify the status to which you want the business object to transition in the following parameters:</p> <ul style="list-style-type: none"> • Next Status • Next Transition Condition <p>At a time, you can specify value for either the Next Status or Next Transition Condition parameter. If you don't specify any value for these parameters, the system will transition the business object to the default next status specified in its lifecycle. This algorithm creates an appropriate log entry when the status of the deferred revenue recognition is changed to Active.</p>

Deferred Revenue Recognition Template (Used for Searching)

The **Deferred Revenue Recognition** screen allows you to search for a deferred revenue recognition template using various search criteria. Through this screen, you can navigate to the following screen:

- [Deferred Revenue Recognition Template \(Used for Viewing\)](#) on page 2167

This screen consists of the following zone:

- [Search Deferred Revenue Recognition Template](#) on page 2159

Search Deferred Revenue Recognition Template

The **Search Deferred Revenue Recognition Template** zone allows you to search for a deferred revenue recognition template using various search criteria. It contains the following two sections:

- **Search Criteria** – The **Search Criteria** section contains the following fields:

Field Name	Field Description	Mandatory (Yes or No)
Deferred Revenue Recognition Template	Used to search the basic information about the deferred revenue recognition template.	Yes

Field Name	Field Description	Mandatory (Yes or No)
Description	Used to search the description of the deferred revenue recognition template.	No
Recognition Schedule	Used to search deferred revenue recognition with a particular schedule. The valid values are: <ul style="list-style-type: none"> • Daily • Monthly • Weekly 	No
Status	Used to indicate the deferred revenue recognition template with a particular status. The valid values are: <ul style="list-style-type: none"> • Active • Inactive 	No

Note: You must specify at least one search criterion while searching for a deferred revenue recognition template.

- **Search Results** – On clicking the **Search** button, the search results appear based on the specified search criteria. The **Search Results** section contains the following columns:

Column Name	Column Description
Deferred Revenue Recognition Template	Displays the deferred revenue recognition. Note: It has a link. On clicking the link, the Deferred Revenue Recognition Template screen appears where you can view the details of the respective deferred revenue recognition template.
Distribution Code	Indicates the distribution code associated with the rate component.
Contract Type	Displays the contract which is generated against a particular type of contract.
Recognition Schedule	Displays the schedule when the deferred revenue is recognized.

Related Topics

For more information on...	See...
How to view the details of a deferred revenue recognition template	Viewing the Deferred Revenue Recognition Template Details on page 2166
How to search for a deferred revenue recognition template	Searching for a Deferred Revenue Recognition Template on page 2160

Searching for a Deferred Revenue Recognition Template

Prerequisites

To search for a deferred revenue recognition template, you should have:

- Deferred revenue recognition template defined in the system.
- Deferred Revenue Recognition Schedule defined in the system.

Procedure

To search for a deferred revenue recognition template:

1. Click the **Admin** menu in the **Application** toolbar.
A list appears.
2. From the **Admin** menu, select **D** and then click **Deferred Revenue Recognition Template**.
The **Deferred Revenue Recognition Template** screen appears.
3. Enter the search criteria in the **Search Deferred Revenue Recognition Template** zone.

Note: ORMB search engine supports wildcard search, where you can substitute the percentage (%) symbol as a stand in for any word or letter in a search criteria. You can use the ‘%’ wildcard character in all input fields except the date and ID fields. The ‘%’ wildcard character is suffixed automatically at the end of the partial search criteria. Therefore, you may or may not specify the wildcard character at the end of the partial search criteria. However, you have to prefix the wildcard character manually wherever required.

4. Click **Search**.

A list of deferred revenue recognition templates that meet the search criteria appears in the **Search Results** section.

Related Topics

For more information on...	See...
Deferred Revenue Recognition Template screen	Deferred Revenue Recognition Template (Used for Searching) on page 2159
Search Deferred Revenue Recognition Template zone	Search Deferred Revenue Recognition Template on page 2159

Defining a Deferred Revenue Recognition Template

Prerequisites

To define a deferred revenue recognition template, you should have:

- Contract types defined in the system

Procedure

To define a deferred revenue recognition template:

1. Click the **Admin** menu in the **Application** toolbar.
A list appears.
2. From the **Admin** menu, select **D** and then click **Deferred Revenue Recognition Template**.
The **Deferred Revenue Recognition Template** screen appears.
3. Click the **Add** button in the **Page Title** area of the **Deferred Revenue Recognition Template** screen.

The **Deferred Revenue Recognition Template** screen appears. It contains the following sections:

- **Main** – Used to specify basic details about the deferred revenue recognition template.
- **Parameters** – Used to specify the various parameters for the deferred revenue recognition template.
- **Algorithms** – Used to associate algorithms with the deferred revenue recognition template.
- **Divisions** – Used to associate a deferred revenue recognition template with a division.
- **Characteristics** – Used to define the characteristics for the deferred revenue recognition template.

The **Main** section contains the following fields:

Field Name	Field Description	Mandatory (Yes or No)
Deferred Revenue Recognition Template	Used to specify the deferred revenue recognition template.	Yes
Description	Used to specify the description of the deferred revenue recognition template.	No
Status	Used to indicate the status of the deferred revenue recognition template. The valid values are: <ul style="list-style-type: none"> • Active • Inactive 	Yes

The **Parameters** section contains the following fields:

Field Name	Field Description	Mandatory (Yes or No)
Distribution Code	Used to indicate the distribution code associated with the deferred revenue recognition.	Yes
	Note: The Search (🔍 icon) appears corresponding to this field. On clicking the Search icon, the Distribution Code Search window appears.	
Contract Type	Used to indicate a particular type of contract.	Yes
	Note: The Search (🔍 icon) appears corresponding to this field. On clicking the Search icon, the Contract Type Search window appears.	
Adjustment Type	Used to indicate the adjustment type using which the adjustment must be created.	No
	Note: The Search (🔍 icon) appears corresponding to this field. On clicking the Search icon, the Adjustment Type Search window appears.	
Allow Editing	Used to allow editing of recognition schedule.	No
Generation Type	Used to indicate the type of deferred revenue recognition generation. The valid values are: <ul style="list-style-type: none"> • Automatic • Manual 	Yes (Conditional)
Recognition Schedule	Used to indicate the schedule of deferred revenue recognition generation. The valid values are: <ul style="list-style-type: none"> • Daily • Monthly • Weekly 	Yes
Allow Proration	Used to allow proration.	Yes

Field Name	Field Description	Mandatory (Yes or No)
	Note: The Allow Proration field appears when you select Recognition Schedule as Monthly .	
High Proration Limit (Days)	Used to specify whether deferred revenue amount must be prorated while revenue recognition. If the number of days from when the policy is enrolled to the end of the month (in which it is enrolled) is greater than the specified limit, then the amount is prorated. Note: This field appears when you check the tick-box for Allow Proration .	Yes (Conditional) Note: This field is required when the recognition schedule is selected as monthly and when the Allow Proration check box is selected.
Low Proration Limit (Days)	Used to specify whether deferred revenue amount must be prorated while revenue recognition. If the number of days from when the policy is enrolled to the end of the month (in which it is enrolled) is less than the specified limit, then the amount is prorated. Note: This field appears when you check the tick-box for Allow Proration .	Yes (Conditional) Note: This field is required when the recognition schedule is selected as monthly and when the Allow Proration check box is selected.

4. Enter the required details.
5. Associate algorithms with the deferred revenue recognition template, if required.
6. View the division to which the deferred revenue recognition template is associated in the **Divisions** section.
7. Define the characteristics specific to division to which the deferred revenue recognition template is associated in the **Characteristics** section.
8. Click **Save**.

The deferred revenue recognition template is created.

Related Topics

For more information on...	See...
Deferred Revenue Recognition Template screen	Deferred Revenue Recognition Template (Used for Searching) on page 2159
How to associate algorithms with the deferred revenue recognition template	Associating Algorithms with a Deferred Revenue Recognition Template on page 2163

Associating Algorithms with a Deferred Revenue Recognition Template

Procedure

To associate algorithms with a deferred revenue recognition template:

1. Ensure that the **Algorithms** section is expanded when you are defining or editing a deferred revenue recognition template.

The **Algorithms** section contains the following fields in a grid:

Field Name	Field Description	Mandatory (Yes or No)
System Event	Used to indicate the system event for an algorithm.	Yes
Sequence	Used to specify the sequence number.	Yes
	Note: On specifying the value for a predefined characteristic type, the description of the characteristic value appears corresponding to the Characteristic Value field.	
Algorithm	Used to associate an algorithm to the system event that you have selected.	Yes
	Note: The Search (🔍) icon appears corresponding to this field. On clicking the Search icon, the Algorithm Search window appears. On specifying the algorithm for a system event, the description of the algorithm appears corresponding to the Algorithm field.	

- Enter the required details in the **Algorithms** section.
- If you want to define more than one algorithm for the deferred revenue recognition template, click the **Add** (+) icon, and then repeat 2.

Note: However, if you want to remove an algorithm from the deferred revenue recognition template, click the **Delete** (🗑️) icon corresponding to the algorithm.

Related Topics

For more information on...	See...
How to define a deferred revenue recognition template	Defining a Deferred Revenue Recognition Template on page 2161
How to edit a deferred revenue recognition template	Editing a Deferred Revenue Recognition Template on page 2169

Associating Deferred Revenue Recognition Template With A Division

Prerequisites

To associate deferred revenue recognition template with a division, you should have:

- Divisions defined in the application

Procedure

To associate deferred revenue recognition template with a division:

- Ensure that the **Divisions** section is expanded when you are creating or editing a deferred revenue recognition template.

The **Divisions** section appears. It contains the following fields:

Field Name	Field Description	Mandatory (Yes or No)
Division	Used to indicate the division to which you want to associate the deferred revenue recognition template.	No
	Note: You can only view those divisions to which you have access in the Division list.	

- Select the required division from the list.
- If you want to associate the deferred revenue recognition template with more than one division, click the **Add (+)** icon and then repeat step 2.

Note: However, if you want to remove the deferred revenue recognition template from a division, click the **Delete** (🗑️) icon corresponding to the division.

- Click **Save**.

The deferred revenue recognition template is associated with the divisions.

Related Topics

For more information on...	See...
How to edit a deferred revenue recognition template	Editing a Deferred Revenue Recognition Template on page 2169
How to define a deferred revenue recognition template	Defining a Deferred Revenue Recognition Template on page 2161

Defining a Characteristic for a Deferred Revenue Recognition Template

Prerequisites

To define a characteristic for a deferred revenue recognition template, you should have:

- Characteristic types defined in the application (where the characteristic entity is set to **Deferred Revenue Recognition Template**)

Procedure

To define a characteristic for a deferred revenue recognition template:

- Ensure that the **Characteristics** section is expanded when you are defining or editing a deferred revenue recognition template.

The **Characteristics** section contains the following fields in a grid:

Field Name	Field Description	Mandatory (Yes or No)
Characteristic Type	Used to indicate the characteristic type.	Yes (Conditional)
		Note: This field is required when you are defining a characteristic for the deferred revenue recognition template.
Characteristic Value	Used to specify the value for the characteristic type.	Yes (Conditional)

Field Name	Field Description	Mandatory (Yes or No)
	Note: On specifying the value for a characteristic type, the description of the characteristic value appears corresponding to the Characteristic Valued field.	Note: This field is required when you are defining a characteristic for the deferred revenue recognition template.

- Enter the required details in the **Characteristics** section.
- If you want to define more than one characteristic for the deferred revenue recognition template, click the **Add (+)** icon and then repeat step 2.

Note: However, if you want to remove a characteristic from the deferred revenue recognition template, click the **Delete (🗑)** icon corresponding to the characteristic.

Related Topics

For more information on...	See...
How to edit a deferred revenue recognition template	Editing a Deferred Revenue Recognition Template on page 2169
How to define a deferred revenue recognition template	Defining a Deferred Revenue Recognition Template on page 2161

Viewing the Deferred Revenue Recognition Template Details

Procedure

To view the details of a deferred revenue recognition template:

- Click the **Admin** link in the **Application** toolbar.
A list appears.
- From the **Admin** menu, select **D** and then click **Deferred Revenue Recognition Template**.
The **Deferred Revenue Recognition Template** screen appears.
- Search for the deferred revenue recognition template in the **Deferred Revenue Recognition Template** screen.
- In the **Search Results** section, click the link in the **Deferred Revenue Recognition Template** column corresponding to the deferred revenue recognition template whose details you want to view.
The **Deferred Revenue Recognition Template** screen appears.
- View the details of the deferred revenue recognition template in the **Deferred Revenue Recognition Template** zone.

Related Topics

For more information on...	See...
Deferred Revenue Recognition Template screen	Deferred Revenue Recognition Template (Used for Searching) on page 2159
Deferred Revenue Recognition Template zone	Deferred Revenue Recognition Template on page 2167
How to search for a deferred revenue recognition template	Searching for a Deferred Revenue Recognition Template on page 2160

Deferred Revenue Recognition Template (Used for Viewing)

Once the deferred revenue recognition templates are created, the **Deferred Revenue Recognition Template** screen allows you to:

- Generate the deferred revenue recognition schedule
- View the details of a deferred revenue recognition template
- Edit a deferred revenue recognition template
- Delete a deferred revenue recognition template

This screen consists of the following zone:

- [Deferred Revenue Recognition Template](#) on page 2167

Deferred Revenue Recognition Template

The **Deferred Revenue Recognition Template** zone displays the details of the deferred revenue recognition template. It contains the following sections:

- **Main** – Displays basic information about the deferred revenue recognition template. It contains the following fields:

Field Name	Field Description
Deferred Revenue Recognition Template	Displays the deferred revenue recognition template
Description	Used to specify the description of the deferred revenue recognition template
Status	Used to indicate the status of the deferred revenue recognition template. The valid values are: <ul style="list-style-type: none"> • Active • Inactive

- **Parameters** – Displays the parameters used in the deferred revenue recognition template.

Field Name	Field Description
Distribution Code	Indicates the distribution code. Note: It has a link. On clicking the link, the Distribution Code screen appears where you can view the details of the respective distribution code.
Contract Type	Displays the Deferred Revenue Recognition Template which are generated against a particular type of contract.
Adjustment Type	Indicates the adjustment type using which the adjustment must be created. Note: It has a link. On clicking the link, the Adjustment Type screen appears where you can view the details of the respective adjustment type.
Generation Type	Displays the type of deferred revenue recognition template. The valid values are: <ul style="list-style-type: none"> • Manual

Field Name	Field Description
	<ul style="list-style-type: none"> Automatic
Allow Editing	Indicates the editing of recognition schedule.
Recognition Schedule	Indicates the schedule when the deferred revenue is recognized. The valid values are: <ul style="list-style-type: none"> Daily Monthly Weekly
Allow Proration	Used to allow proration. Note: The Allow Proration field appears when you select Recognition Schedule as Monthly .
High Proration Limit (Days)	Displays whether deferred revenue amount must be prorated while revenue recognition. If the number of days from when the policy is enrolled to the end of the month (in which it is enrolled) is greater than the specified limit, then the amount is prorated. Note: This field appears when you check the tick-box for Allow Proration .
Low Proration Limit (Days)	Displays whether deferred revenue amount must be prorated while revenue recognition. If the number of days from when the policy is enrolled to the end of the month (in which it is enrolled) is less than the specified limit, then the amount is prorated. Note: This field appears when you check the tick-box for Allow Proration .

- **Divisions** – Displays the associated deferred revenue recognition template with one or more divisions. It contains the following column:

Column Name	Column Description
Division	Displays the division to which you want to associate the deferred revenue recognition template.

- **Algorithms** – Lists the algorithms associated with the deferred revenue recognition template. It contains the following columns:

Column Name	Column Description	Mandatory (Yes or No)
System Event	Indicates the system event on which the algorithm must be executed	No
Sequence	Displays the sequence number.	No
Algorithm	Displays an algorithm that needs to be attached to the selected system event. Note: It has a link. On clicking the link, the Algorithm screen appears where you can view the details of the respective algorithm.	No

- **Characteristics** – Lists the characteristics defined for the deferred revenue recognition template. It contains the following fields:

Column Name	Column Description
Characteristic Type	Displays the characteristic type.
Characteristic Type	Displays the value of the characteristic type.

- **Record Actions** – This section contains the following buttons:

Button Name	Button Description
Edit	Used to define, edit, and remove algorithms of the deferred revenue recognition template. Note: The Edit button appears when the deferred revenue recognition template is in the Active status.
Delete	Used to delete the deferred revenue recognition template.

-
- **Record Information** – This section contains the following fields:

Field Name	Field Description
Business Object	Indicates the business object using which the deferred revenue recognition template is created. In addition, a context menu appears corresponding to this field which helps in navigating to other screens in the application. Note: It has a link. On clicking the link, the Business Object screen appears where you can view the details of the respective business object.

Editing a Deferred Revenue Recognition Template

Procedure

To edit a deferred revenue recognition template:

1. Search for the deferred revenue recognition template in the **Deferred Revenue Recognition Template** screen.
2. In the **Search Results** section, click the link in the **Deferred Revenue Recognition Template** column corresponding to the deferred revenue recognition template whose details you want to edit.

The **Deferred Revenue Recognition Template** screen appears.

3. Click the **Edit** button in the **Deferred Revenue Recognition Template** zone.

The **Deferred Revenue Recognition Template** screen appears.

Note: The **Edit** button appears when the deferred revenue recognition template is in the **Active** status.

4. Associate, edit, or remove algorithms from the deferred revenue recognition template, if required.
5. Define, edit, or remove characteristics of the deferred revenue recognition template, if required.
6. Associate deferred revenue recognition template with a division, if required.
7. Click **Save**.

The changes made to the deferred revenue recognition template are saved.

Related Topics

For more information on...	See...
Deferred Revenue Recognition Template screen	Deferred Revenue Recognition Template (Used for Viewing) on page 2167
Deferred Revenue Recognition Template zone	Deferred Revenue Recognition Template on page 2167
How to search for a deferred revenue recognition template	Searching for a Deferred Revenue Recognition Template on page 2160
How to associate algorithms with a deferred revenue recognition template	Associating Algorithms with a Deferred Revenue Recognition Template on page 2163

Deleting a Deferred Revenue Recognition Template**Procedure**

To delete a deferred revenue recognition template:

1. Search for the deferred revenue recognition template in the **Deferred Revenue Recognition Template** screen.
2. In the **Search Results** section, click the link in the **Deferred Revenue Recognition Template** column corresponding to the deferred revenue recognition template that you want to delete.

The **Deferred Revenue Recognition Template** screen appears.

3. Click the **Delete** button in the **Deferred Revenue Recognition Template** zone.

A message appears confirming whether you want to delete the deferred revenue recognition template.

4. Click **OK**.

The deferred revenue recognition template is deleted.

Related Topics

For more information on...	See...
Deferred Revenue Recognition Template screen	Deferred Revenue Recognition Template (Used for Viewing) on page 2167
Deferred Revenue Recognition Template zone	Deferred Revenue Recognition Template on page 2167
How to search for a deferred revenue recognition template	Searching for a Deferred Revenue Recognition Template on page 2160

Viewing the Deferred Revenue Recognition Template Details**Procedure**

To view the details of a deferred revenue recognition template:

1. Click the **Admin** link in the **Application** toolbar.

A list appears.

2. From the **Admin** menu, select **D** and then click **Deferred Revenue Recognition Template**.

The **Deferred Revenue Recognition Template** screen appears.

3. Search for the deferred revenue recognition template in the **Deferred Revenue Recognition Template** screen.

4. In the **Search Results** section, click the link in the **Deferred Revenue Recognition Template** column corresponding to the deferred revenue recognition template whose details you want to view.

The **Deferred Revenue Recognition Template** screen appears.

- View the details of the deferred revenue recognition template in the **Deferred Revenue Recognition Template** zone.

Related Topics

For more information on...	See...
Deferred Revenue Recognition Template screen	Deferred Revenue Recognition Template (Used for Searching) on page 2159
Deferred Revenue Recognition Template zone	Deferred Revenue Recognition Template on page 2167
How to search for a deferred revenue recognition template	Searching for a Deferred Revenue Recognition Template on page 2160

Deferred Revenue Recognition (Used for Searching)

The **Deferred Revenue Recognition** screen allows you to search for a deferred revenue recognition using various search criteria. Through this screen, you can navigate to the following screen:

- [Deferred Revenue Recognition \(Used for Viewing\)](#) on page 2176

This screen consists of the following zone:

- [Search Deferred Revenue Recognition](#) on page 2171

Search Deferred Revenue Recognition

The **Search Deferred Revenue Recognition** zone allows you to search for a deferred revenue recognition using various search criteria. It contains the following two sections:

- Search Criteria** – This section contains the following fields:

Field Name	Field Description	Mandatory (Yes or No)
Search By	Used to indicate whether you want to search for a deferred revenue recognition using the deferred revenue recognition, person, account, or policy details. The valid values are: <ul style="list-style-type: none"> Account Details Person Details Deferred Revenue Recognition Details Financial Transaction Details Policy Details 	Yes
	Note: By default, the Account Details option is selected.	
Person ID	Used to search deferred revenue recognition which are assigned to a particular person.	No
	Note: This field appears when you select the Person Details option from the Search By list.	

Field Name	Field Description	Mandatory (Yes or No)
Account ID	Used to search the account ID.	No
	Note: This field appears only when you select the Account Details option from the Search By list.	
Person Identifier Type	Used to select the identifier type based on which you want to search deferred revenue recognition through which the person's record is created or updated in the system.	Yes (Conditional) Note: If you specify the person identifier as a search criteria, you have to select the person identifier type.
Person Identifier	Used to specify the value for the person identifier type.	Yes (Conditional) Note: If you specify the person identifier type as a search criteria, you have to specify the person identifier.
Account Identifier Type	Used to specify the account identifier type of the account whose details you want to search.	Yes (Conditional) Note: If you specify the account identifier as a search criteria, you have to select the account identifier type.
	Note: This field appears when you select the Account Details option from the Search By list.	
Account Identifier	Used to specify the value of the account identifier.	Yes (Conditional) Note: If you specify the account identifier type as a search criteria, you have to specify the account identifier.
	Note: This field appears when you select the Account Details option from the Search By list.	
Contract ID	Used to specify the contract ID linked to the account.	No
	Note: This field appears when you select the Account Details option from the Search By list.	
Person Hierarchy	Used to indicate whether to display hierarchy of the person linked to a particular bill.	No
	Note: This field appears when you select the Person Details option from the Search By list.	
Status	Used to search deferred revenue recognition with a particular status. The valid values are: <ul style="list-style-type: none"> • Active • Closed • Canceled • Draft 	No

Field Name	Field Description	Mandatory (Yes or No)
	Note: This field appears when you select the Person Details, Account Details, or Deferred Revenue Recognition Details option from the Search By list.	
Deferred Revenue Recognition Template	Used to indicate the template used for deferred revenue recognition. Note: This field appears when you select the Person Details, Account Details, or Deferred Revenue Recognition Details option from the Search By list.	No
Valid Until Date	Used to specify the date till which the deferred revenue recognition is valid. Note: This field appears when you select the Person Details or Account Details option from the Search By list.	No
Deferred Revenue Recognition ID	Used to search a particular deferred revenue recognition Note: This field appears when you select the Deferred Revenue Recognition Details option from the Search By list.	No
Description	Used to specify the description of the deferred revenue recognition. Note: This field appears when you select the Deferred Revenue Recognition Details option from the Search By list.	No
Recognition Schedule	Used to search deferred revenue recognition with a particular schedule. The valid values are: <ul style="list-style-type: none"> • Daily • Monthly • Weekly Note: This field appears when you select the Deferred Revenue Recognition Details option from the Search By list.	No
Financial Transaction ID	Used to search deferred revenue recognition which are assigned to a particular financial transaction. Note: This field appears only when you select the Financial Transaction Details option from the Search By list.	
Policy Type	Used to indicate the type of policy.	Yes

Field Name	Field Description	Mandatory (Yes or No)
	Note: This field appears when you select the Policy Details option from the Search By list.	
Policy Number	Used to indicate the policy number. Note: This field appears when you select the Policy Details option from the Search By list.	No
Plan Number	Used to indicate the plan number of the policy. Note: This field appears when you select the Policy Details option from the Search By list.	No
Source System	Used to indicate the name of the external system from where the policy originated. Note: This field appears when you select the Policy Details option from the Search By list.	No
Start Date	Used to indicate the date from when the policy is effective. Note: This field appears when you select the Policy Details option from the Search By list.	No
End Date	Used to indicate the date till when the policy is effective. Note: This field appears when you select the Policy Details option from the Search By list.	No

Note: You must specify at least one search criterion while searching for a deferred revenue recognition.

- **Search Results** – On clicking the **Search** button, the search results appear based on the specified search criteria. The **Search Results** section contains the following columns:

Column Name	Column Description
Deferred Revenue Recognition Information	Displays information about the deferred revenue recognition. Note: It has a link. On clicking the link, the Deferred Revenue Recognition screen appears where you can view the details of the respective deferred revenue recognition.
Contract Information	Displays the basic information about the contract corresponding to the deferred revenue recognition. In addition, this column has a context menu which helps in navigating to other screens in the application. Note: It has a link. On clicking the link, the Contract screen appears where you can view the details of the respective contract.
Financial Transaction Information	Displays the basic information about the financial transaction corresponding to the deferred revenue recognition.

Column Name	Column Description
	Note: It has a link. On clicking the link, the Financial Transaction screen appears where you can view the details of the respective financial transaction.

Related Topics

For more information on...	See...
How to view the details of a deferred revenue recognition	Viewing the Deferred Revenue Recognition Details on page 2176
How to search for a deferred revenue recognition	Searching for a Deferred Revenue Recognition on page 2175

Searching for a Deferred Revenue Recognition

Prerequisites

To search for a deferred revenue recognition, you should have:

- Deferred Revenue Recognition Template defined in the application.
- Person identifier types defined in the application
- Account identifier types defined in the application
- Recognition Schedules defined in the application
- Source Systems defined in the application

Procedure

To search for a deferred revenue recognition:

1. Click the **Menu** link in the **Application** toolbar.
A list appears.
2. From the **Main** menu, select **Accounting and Receivable**.
A sub-menu appears.
3. Click the **Search** option from the **Deferred Revenue Recognition** sub-menu.
The **Deferred Revenue Recognition** screen appears.
4. Enter the search criteria in the **Search Deferred Revenue Recognition** zone.

Note: ORMB search engine supports wildcard search, where you can substitute the percentage (%) symbol as a stand in for any word or letter in a search criteria. You can use the ‘%’ wildcard character in all input fields except the date and ID fields. The ‘%’ wildcard character is suffixed automatically at the end of the partial search criteria. Therefore, you may or may not specify the wildcard character at the end of the partial search criteria. However, you have to prefix the wildcard character manually wherever required.

5. Click **Search**.

A list of deferred revenue recognition that meet the search criteria appears in the **Search Results** section.

Related Topics

For more information on...	See...
Deferred Revenue Recognition screen	Deferred Revenue Recognition (Used for Searching) on page 2171
Search Deferred Revenue Recognition zone	Search Deferred Revenue Recognition on page 2171

Viewing the Deferred Revenue Recognition Details

Procedure

To view the details of a deferred revenue recognition:

1. Search for the deferred revenue recognition in the **Deferred Revenue Recognition** screen.
2. In the **Search Results** section, click the link in the **Deferred Revenue Recognition Information** column corresponding to the deferred revenue recognition whose details you want to view.

The **Deferred Revenue Recognition** screen appears. It consists of the following tabs:

- [Deferred Revenue Recognition - Main](#) on page 2176
- [Deferred Revenue Recognition - Log](#) on page 2180

3. Ensure that the **Main** tab is selected.
4. View the details of the deferred revenue recognition in the **Deferred Revenue Recognition** zone.

Related Topics

For more information on...	See...
Deferred Revenue Recognition screen	Deferred Revenue Recognition (Used for Viewing) on page 2176
Search Deferred Revenue Recognition zone	Search Deferred Revenue Recognition on page 2171
How to search for a deferred revenue recognition	Searching for a Deferred Revenue Recognition on page 2175

Deferred Revenue Recognition (Used for Viewing)

The **Deferred Revenue Recognition** screen allows you to:

- View the details of a deferred revenue recognition
- Edit a deferred revenue recognition
- Generate the deferred revenue recognition schedule
- Add related deferred revenue recognitions
- Edit the details of a deferred revenue recognition schedule
- View the log of a deferred revenue recognition
- Add a log entry for a deferred revenue recognition

This screen consists of the following tabs:

- [Deferred Revenue Recognition - Main](#) on page 2176
- [Deferred Revenue Recognition - Log](#) on page 2180

Deferred Revenue Recognition - Main

The **Main** tab displays information about the deferred revenue recognition. It contains the following zones:

- [Deferred Revenue Recognition](#) on page 2177
- [Associated Deferred Revenue Recognitions](#) on page 2178
- [Recognition Schedule](#) on page 2179
- [Revenue Recognition Items](#) on page 2179

Deferred Revenue Recognition

The **Deferred Revenue Recognition** zone displays the details of the deferred revenue recognition. It contains the following sections:

- **Main** – Displays basic information about the deferred revenue recognition. It contains the following fields:

Field Name	Field Description
Deferred Revenue Recognition Information	Displays information about the deferred revenue recognition.
Deferred Revenue Recognition Template Information	Displays information about the deferred revenue recognition template. Note: It has a link. On clicking the link, the Deferred Revenue Recognition Template screen appears where you can view the details of the deferred revenue recognition template.
Distribution Code	Displays the distribution code which indicates the template associated with the deferred revenue recognition.
Financial Transaction Information	Displays the basic information about the financial transaction corresponding to the deferred revenue recognition. Note: It has a link. On clicking the link, the Financial Transaction Information screen appears where you can view the details of the financial transaction.
Total Revenue Deferred	Displays the total revenue deferred.
Total Revenue Recognized	Displays the total revenue recognized.
Status	Indicates the status of the deferred revenue recognition. The valid values are: <ul style="list-style-type: none"> • Active • Closed • Canceled • Draft

- **Related Deferred Revenue Recognitions** - Lists the related deferred revenue recognitions. It contains the following columns:

Column Name	Column Description
Deferred Revenue Recognition Information	Displays the basic information of the related Deferred Revenue Recognition Schedules (i.e. DRR Schedule of the BS/AD, corresponding to the BX/AX)
Create Date Time	Displays the date and time when the deferred revenue recognition is created.

Column Name	Column Description
Financial Transaction Information	Displays the basic information about the financial transaction corresponding to the deferred revenue recognition.

- **Record Actions** – This section contains the following buttons:

Button Name	Button Description
Edit	Used to define, edit and remove characteristics, related deferred revenue recognitions of the deferred revenue recognition.
	Note: The Edit button appears when the deferred revenue recognition is in the Active status.
Generate Schedule	Used to generate the deferred revenue recognition schedule.
	Note: The Generate Schedule button appears only when the deferred revenue recognition is in the Draft status.

- **Record Information** – This section contains the following fields:

Field Name	Field Description
Business Object	Indicates the business object using which the deferred revenue recognition is created. In addition, a context menu appears corresponding to this field which helps in navigating to other screens in the application.
	Note: It has a link. On clicking the link, the Business Object screen appears where you can view the details of the respective business object.
Create Date/Time	Displays the date and time when the deferred revenue recognition schedule is created.
Status Date/Time	Displays the date and time when the deferred revenue recognition status is updated.

- **Characteristics** – Lists the characteristics defined for the deferred revenue recognition. It contains the following columns:

Column Name	Column Description
Effective Date	Displays the date from when the characteristic is effective for the deferred revenue recognition.
Characteristic Type	Indicates the characteristic type.
Characteristic Value	Displays the value of the characteristic type.

Associated Deferred Revenue Recognitions

The **Associated Deferred Revenue Recognitions** zone Displays the basic information of the other schedules linked to the same **FT** having a separate **Schedule** due to the different **Distribution Code**. Purpose of this section is to show all the associated **Schedules** generated for a single **FT**. It contains the following columns:

Column Name	Column Description
Deferred Revenue Recognition Information	Displays information about the deferred revenue recognition.

Column Name	Column Description
	Note: It has a link. On clicking the link, the Deferred Revenue Recognition screen appears where you can view the details of the deferred revenue recognition.
Financial Transaction Information	Displays the basic information about the financial transaction corresponding to the deferred revenue recognition. Note: It has a link. On clicking the link, the Financial Transaction screen appears where you can view the details of the respective deferred revenue recognition.
Distribution Code	Displays the distribution code which indicates the template associated with the deferred revenue recognitions.
Deferred Revenue Recognition Template Information	Displays information about the deferred revenue recognition template. Note: It has a link. On clicking the link, the Deferred Revenue Recognition Template screen appears where you can view the details of the deferred revenue recognition template.
Status	Indicates the status of the associated deferred revenue recognition. The valid values are: <ul style="list-style-type: none"> • Active • Closed • Canceled

Recognition Schedule

The **Recognition Schedule** zone lists the adjustment information and the recognition amount of the deferred revenue recognition. It contains the following columns:

Column Name	Column Description
Recognition Date	Displays the date on which the recognition is scheduled.
Recognition Amount	Displays the amount of the recognition scheduled.
Adjustment Information	Displays information about the adjustments in recognition schedule.

This zone contains the **Edit** button. It is used to edit the details of recognition schedule

Note: This zone appears when the deferred revenue recognition is in the **Active** status.

Revenue Recognition Items

The **Revenue Recognition Items** zone displays the adjustment information about the recognition items. It contains the following columns:

Column Name	Column Description
Recognition Date	Displays the date on which the recognition is scheduled.
Recognition Amount	Displays the amount of the recognition scheduled.
Adjustment Information	Displays information about the adjustments in recognition schedule. “

Column Name	Column Description
	Note: It has a link. On clicking the link, the Adjustment screen appears where you can view the details of the deferred revenue recognition.

Deferred Revenue Recognition - Log

The **Log** tab contains the following zone:

- [Deferred Revenue Recognition Log](#) on page 2180

Deferred Revenue Recognition Log

The **Deferred Revenue Recognition Log** zone lists the complete trail of actions performed on the deferred revenue recognition. It contains the following columns:

Column Name	Column Description
Date/Time	Displays the date and time when the action was performed on the deferred revenue recognition
Details	Displays the details about the action performed on the deferred revenue recognition
User	Indicates the user who has performed the action on the deferred revenue recognition
Log Type	Indicates the type of log.
Related Object	Indicates the object or entity which is created when the action is performed on the deferred revenue recognition. Note: At present, no data appears in this column. The implementation team can build the custom logic to meet the business requirements.
Status Reason	Indicates the reason why the status of the deferred revenue recognition is changed. Note: At present, no data appears in this column. The implementation team can build the custom logic to meet the business requirements.

Note: You can manually add a log entry for the deferred revenue recognition by clicking the **Add Log Entry** link in the upper right corner of the **Deferred Revenue Recognition Log** zone.

Related Topics

For more information on...	See...
How to view the log of a deferred revenue recognition	Viewing the Log of a Deferred Revenue Recognition on page 2185
How to add a log entry for a deferred revenue recognition	Adding a Log Entry for a Deferred Revenue Recognition on page 2185

Editing a Deferred Revenue Recognition

Procedure

To edit a deferred revenue recognition:

1. Search for the deferred revenue recognition in the **Deferred Revenue Recognition** screen.

2. In the **Search Results** section, click the link in the **Deferred Revenue Recognition Information** column \orresponding to the deferred revenue recognition whose details you wa
The **Deferred Revenue Recognition** screen appears.
3. Click the **Edit** button in the **Deferred Revenue Recognition** zone.
The **Deferred Revenue Recognition** screen appears.

Note: The **Edit** button appears when the deferred revenue recognition is in the **Active** status.

4. Modify the required details in the **Main** section.
5. Define, edit, or remove related deferred revenue recognitions from the deferred revenue recognition, if required.
6. Define, edit, or remove characteristics of the deferred revenue recognition, if required.
7. Click **Save**.
The changes made to the deferred revenue recognition are saved.

Related Topics

For more information on...	See...
Deferred Revenue Recognition screen	Deferred Revenue Recognition (Used for Viewing) on page 2176
Deferred Revenue Recognition zone	Deferred Revenue Recognition on page 2177
How to search for a deferred revenue recognition	Searching for a Deferred Revenue Recognition on page 2175
How to add related deferred revenue recognitions	Adding Related Deferred Revenue Recognitions on page 2183
How to define the characteristics for a deferred revenue recognition	Defining a Characteristic for a Deferred Revenue Recognition on page 2182

Creating the Deferred Revenue Recognition Schedule

Prerequisites

To create the deferred revenue recognition schedule, you should have:

- Should have **Revenue Recognition Schedule Creation Algorithm** attached in the **DRR Template**

Procedure

To create the deferred revenue recognition schedule:

1. Search for the deferred revenue recognition in the **Deferred Revenue Recognition** screen.
2. In the **Search Results** section, click the link in the **Deferred Revenue Recognition Information** column corresponding to the deferred revenue recognition whose recognition schedule you want to generate.
The **Deferred Revenue Recognition** screen appears.
3. Click the **Generate Schedule** button in the **Deferred Revenue Recognition** zone.

Note: The **Generate Schedule** button appears when the deferred revenue recognition is in the **Draft** status.

The status of the deferred revenue recognition is changed to **Active**.

Related Topics

For more information on...	See...
Deferred Revenue Recognition screen	Deferred Revenue Recognition (Used for Viewing) on page 2176

For more information on...	See...
Deferred Revenue Recognition zone	Deferred Revenue Recognition on page 2177
How to search for a deferred revenue recognition	Searching for a Deferred Revenue Recognition on page 2175

Defining a Characteristic for a Deferred Revenue Recognition

Prerequisites

To define a characteristic for a deferred revenue recognition, you should have:

- Characteristic types defined in the application (where the characteristic entity is set to **Deferred Revenue Recognition**)

Procedure

To define a characteristic for a deferred revenue recognition:

1. Ensure that the **Characteristics** section is expanded when you are editing a deferred revenue recognition.

The **Characteristics** section contains the following fields in a grid:

Field Name	Field Description	Mandatory (Yes or No)
Effective Date	Used to specify the date from when the characteristic is effective for the deferred revenue recognition.	Yes (Conditional)
		Note: This field is required when you are defining a characteristic for the deferred revenue recognition.
Characteristic Type	Used to indicate the characteristic type.	Yes (Conditional)
	Note: The list includes only those characteristic types where the characteristic entity is set to Deferred Revenue Recognition .	Note: This field is required when you are defining a characteristic for the deferred revenue recognition.
Characteristic Value	Used to specify the value for the characteristic type.	Yes (Conditional)
	Note: On specifying the value for a characteristic type, the description of the characteristic value appears corresponding to the Characteristic Value field.	Note: This field is required when you are defining a characteristic for the deferred revenue recognition.

2. Enter the required details in the **Characteristics** section.

Note: If you select a characteristic type, the **Search** (🔍) icon appears corresponding to the **Characteristic Value** field. On clicking the **Search** icon, you can search for a characteristic value.

3. If you want to define more than one characteristic for the deferred revenue recognition, click the **Add** (+) icon and then repeat step 2.

Note: However, if you want to remove a characteristic from the deferred revenue recognition, click the **Delete** (🗑️) icon corresponding to the characteristic.

Related Topics

For more information on...	See...
How to edit a deferred revenue recognition	Editing a Deferred Revenue Recognition on page 2180

Adding Related Deferred Revenue Recognitions

Prerequisites

To add related deferred revenue recognitions, you should have:

- Deferred revenue recognition template defined in the system.

Procedure

To add related deferred revenue recognitions:

1. Ensure that the **Related Deferred Revenue Recognitions** section is expanded when you are editing a deferred revenue recognition.

The **Related Deferred Revenue Recognitions** section contains the following fields:

Field Name	Field Description	Mandatory (Yes or No)
Deferred Revenue Recognition ID	Used to specify the ID of the deferred revenue recognition.	Yes
	Note: The Search (🔍) icon appears corresponding to this field. On clicking the Search icon, the Deferred Revenue Recognition Search window appears.	
Create Date Time	Used to indicate the creation date and time of the deferred revenue recognition.	Yes
Financial Transaction ID	Used to specify the ID of the financial transaction corresponding to the deferred revenue recognition.	Yes
	Note: The Search (🔍) icon appears corresponding to this field. On clicking the Search icon, the Financial Transactions Search window appears.	

2. Enter the required details in the **Related Deferred Revenue Recognitions** section.
3. If you want to add more than one related deferred revenue recognition for the deferred revenue recognition, click the **Add** (+) icon and then repeat step 2.

Note: However, if you want to remove a related deferred revenue recognition from the deferred revenue recognition, click the **Delete** (🗑️) icon corresponding to the related deferred revenue recognition.

Related Topics

For more information on...	See...
How to edit a deferred revenue recognition	Editing a Deferred Revenue Recognition on page 2180

Editing the Deferred Revenue Recognition Schedule Details

Prerequisites

To edit the details of the deferred revenue recognition schedule, you should have:

- Should have **Allow Editing Switch** as **Yes** on deferred revenue recognition template.

Procedure

To edit the details of the deferred revenue recognition schedule:

1. Search for the deferred revenue recognition in the **Deferred Revenue Recognition** screen.
2. In the **Search Results** section, click the link in the **Deferred Revenue Recognition Information** column corresponding to the deferred revenue recognition whose deferred revenue recognition schedule details you want to edit.

The **Deferred Revenue Recognition** screen appears.

3. Select the recognition whose details you want to edit in the **Recognition Schedule** zone and click the **Edit** button available in the upper left corner above the table in this zone.

The **Edit Recognition Schedule** screen appears.

Note: A recognition schedule from the deferred revenue recognition can be edited when the deferred revenue recognition is in the **Active** status.

The **Edit Recognition Schedule** screen contains the following fields:

Field Name	Field Description
Deferred Revenue Recognition Information	Displays the information about the deferred revenue recognition.
Financial Transaction Information	Displays the information of the financial transaction corresponding to the deferred revenue recognition.

In addition to these fields, this screen contains following columns:

Column Name	Column Description	Mandatory (Yes or No)
Recognition Date	Used to display the date on which the deferred revenue is recognized.	Yes
Recognition Amount	Used to display the amount of the deferred revenue.	Yes
Adjustment ID	Used to display the adjustment id.	Not applicable

4. Modify the details of the recognition schedule.
5. If you want to define more than one recognition schedule for the deferred revenue recognition, click the **Add (+)** icon and then repeat step 4.

Note: However, if you want to remove a recognition schedule from the deferred revenue recognition, click the **Delete (🗑)** icon corresponding to the recognition schedule.

6. Click **Save**.

The changes made to the recognition schedule are saved.

Related Topics

For more information on...	See...
Recognition Schedule zone	Recognition Schedule on page 2179
How to search for a deferred revenue recognition	Searching for a Deferred Revenue Recognition on page 2175

Viewing the Log of a Deferred Revenue Recognition

Procedure

To view the log of a deferred revenue recognition:

1. Search for the deferred revenue recognition in the **Deferred Revenue Recognition** screen.
2. In the **Search Results** section, click the link in the **Deferred Revenue Recognition Information** column corresponding to the deferred revenue recognition whose log you want to view.

The **Deferred Revenue Recognition** screen appears. It consists of the following tabs:

- [Deferred Revenue Recognition - Main](#) on page 2176
- [Deferred Revenue Recognition - Log](#) on page 2180

3. Click the **Log** tab.

The **Log** tab appears.

4. View the complete trail of actions performed on the deferred revenue recognition in the **Deferred Revenue Recognition Log** zone.

Column Name	Column Description
Date/Time	Displays the date and time when the action was performed on the dispute request.
Details	Displays the details about the deferred revenue recognition log
User	Indicates the user who has performed deferred revenue recognition
Log Type	Indicates the type of log.
Related Object	Indicates the object or entity which is generated when the action is performed on the deferred revenue recognition
Status Reason	Displays the status reason of action performed on the deferred revenue recognition

Related Topics

For more information on...	See...
Deferred Revenue Recognition Log zone	Deferred Revenue Recognition Log on page 2180
How to search for a deferred revenue recognition	Searching for a Deferred Revenue Recognition on page 2175
How to add a log entry for a deferred revenue recognition	Adding a Log Entry for a Deferred Revenue Recognition on page 2185

Adding a Log Entry for a Deferred Revenue Recognition

Procedure

To add a log entry for a deferred revenue recognition:

1. Search for the deferred revenue recognition in the **Deferred Revenue Recognition** screen.
2. In the **Search Results** section, click the link in the **Deferred Revenue Recognition Information** column corresponding to the deferred revenue recognition whose log you want to edit.

The **Deferred Revenue Recognition** screen appears. It consists of the following tabs:

- [Deferred Revenue Recognition - Main](#) on page 2176
- [Deferred Revenue Recognition - Log](#) on page 2180

3. Click the **Log** tab.

The **Log** tab appears.

4. Click on the **Add Log Entry** link in the upper right corner of the **Deferred Revenue Recognition Log** zone.

The **Add Deferred Revenue Recognition Schedule Log** window appears. It contains the following fields:

Field Name	Field Description	Mandatory (Yes Or No)
Deferred Revenue Recognition Information	Displays information about the deferred revenue recognition.	Not applicable
Log Details	Used to specify additional comments for the deferred revenue recognition.	Yes

5. Enter the comments in the **Log Details** field.

6. Click **Save**.

The log entry is added in the **Deferred Revenue Recognition Log** zone.

Related Topics

For more information on...	See...
Deferred Revenue Recognition Log zone	Deferred Revenue Recognition Log on page 2180
How to search for a deferred revenue recognition	Searching for a Deferred Revenue Recognition on page 2175

Chapter 34

Product Lifecycle Management

Topics:

- *Prerequisites*
- *Product Status Transition through User Interface*
- *Product Status Transition through a Batch Process*
- *Product Version Status Transition*
- *Product Enrollment Status Transition through User Interface*
- *Product Enrollment Status Transition through a Batch Process*
- *Product Service (Used for Searching)*
- *Product Service (Used for Viewing)*
- *Product (Used for Searching)*
- *Product Version (Used for Viewing)*
- *Product (Used for Viewing)*
- *Product Enrollment (Used for Searching)*
- *Product Enrollment (Used for Viewing)*

Oracle Revenue Management and Billing facilitates a process of managing the entire lifecycle of a product from inception to service and then to retirement. The system allows you to create the following types of products:

- **Standard** - This type of product is a standalone product.
- **Packaged** - This type of a product is a bundle or group of products.
- **Informational** - This type of a product is used in the product hierarchy, but does not have its own pricing.

On creating a product, the status of the product is set to **Draft**. You can associate a product to one or more divisions. You can create a product to product relationship in the system. You can add product versions in the product. A product version is the entity which holds the following information:

- Product services which are offered with the product
- Price list from where the pricing for offered product services should be obtained.
- Eligibility criteria which must be satisfied when the account enrolls for the product.

The above information is captured when you create a product version for a standard product. However, when you create a product version for a packaged product, it holds the following information:

- Standard products which are offered in the packaged product.

Note: Some of these products might be compulsorily offered with the packaged product while some of the products might be optional.

- Standard products' services which are offered in the packaged product.

Note: Some of these product services might be compulsorily offered with the standard product while some of the product services might be optional.

- Add-on product services which are offered in the packaged product.
- Price list from where the pricing for offered product services and add-on product services should be obtained.
- Eligibility criteria which must be satisfied when the account enrolls for the packaged product.

A product version is effective from a particular date and its effective date must fall within the product date range. On creating a product version, the status of the product version is set to **In Progress**. You can activate a product when at least one of its product versions is in the **Finalized** status.

A product service can be associated to one or more price items. A product service can be offered with a product when it is associated with at least one price item in the system.

Once the product is activated, you can enroll the account for the product. On enrolling for a product, the system retrieves the product details from the product version which is effective on the system date. While enrolling for a standard product, you cannot remove mandatory product services from the product. However, you can enroll for optional product services which are offered with the product.

Similarly, while enrolling for a packaged product, you cannot remove mandatory products and product services from the packaged product. However, you can enroll for optional products and product services which are offered with the packaged product. While enrolling an account for a product, you can set the product enrollment priority for the account.

Once you create the product enrollment, the status of the enrollment is set to **Pending**. On submitting the product enrollment, the validation process is initiated. If all conditions are met, the status of the product enrollment is changed to **Enrolled**. You can unenroll for the product, whenever required.

You can retire a product, whenever required. The product, product version, and product enrollment goes through various statuses in their lifecycle.

The following batches are newly introduced for the Product Lifecycle Management feature:

- Product BO Monitor (C1-PRTRN)
- Product Enrollment Monitor (C1-ENTRN)

For more information on how to setup the product lifecycle management feature, see [Prerequisites](#) on page 2189.

Prerequisites

To setup the product lifecycle management feature, you need to do the following:

- Define the required customer and account in the system.
- Create an approval workflow group with a group name **PRODUCTPLM** for the product and product version.
- Define the feature configuration as **C1-PRODCH**.
- Define the sequence of execution of **C1-PROD-TDCC**, **C1-TRAN-RETR**, and **C1-PROD-ACTV** algorithms, in the **ACTIVE** status of the **C1_PRODUCT_BO** business object.
- Define the following parameters for the predefined **C1-PROD-TDCC** algorithm-type.
 - To Do Type1
 - Number of Days
 - Customer Contact
- Define the parameters for the predefined **C1-PRTRN** batch control.

Note: If the batch date is not defined while creating the batch control, system date is assigned as the batch date.

- Define at least one packaged or standard product for product enrollment purposes.
- Associate at least one price list with a product, when you are defining single or multiple product versions.

Product Status Transition through User Interface

The following figure graphically indicates how a product moves from one status to another through the user interface:

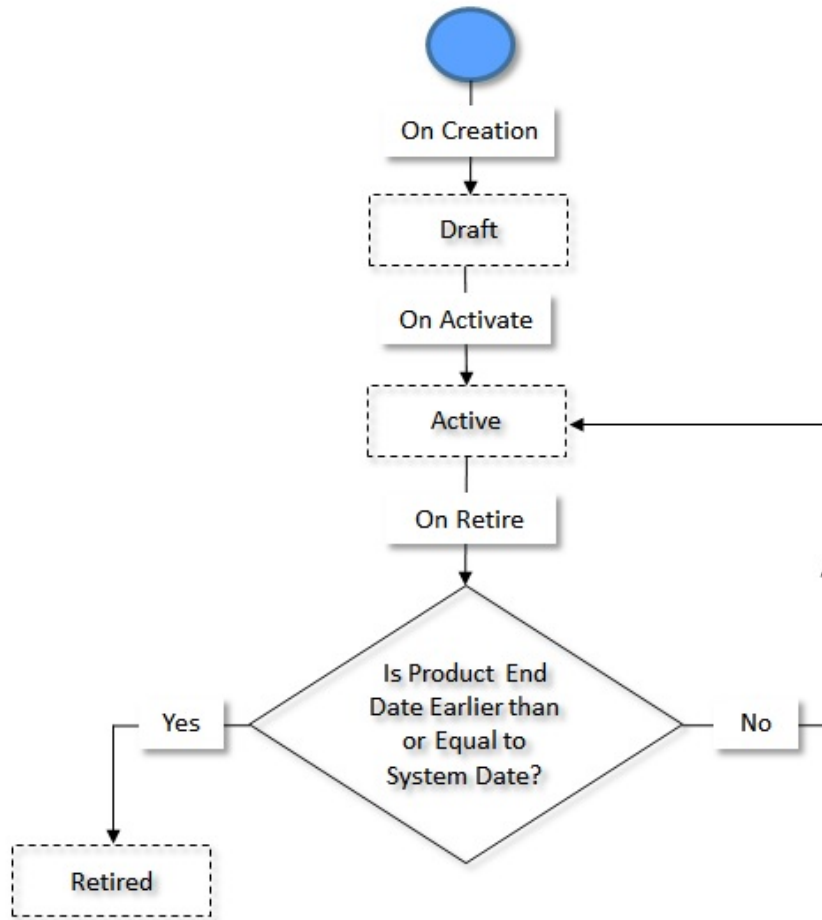

Product Status Transition through a Batch Process

The following figure graphically indicates how a product moves from one status to another through the **Product BO Monitor** batch:

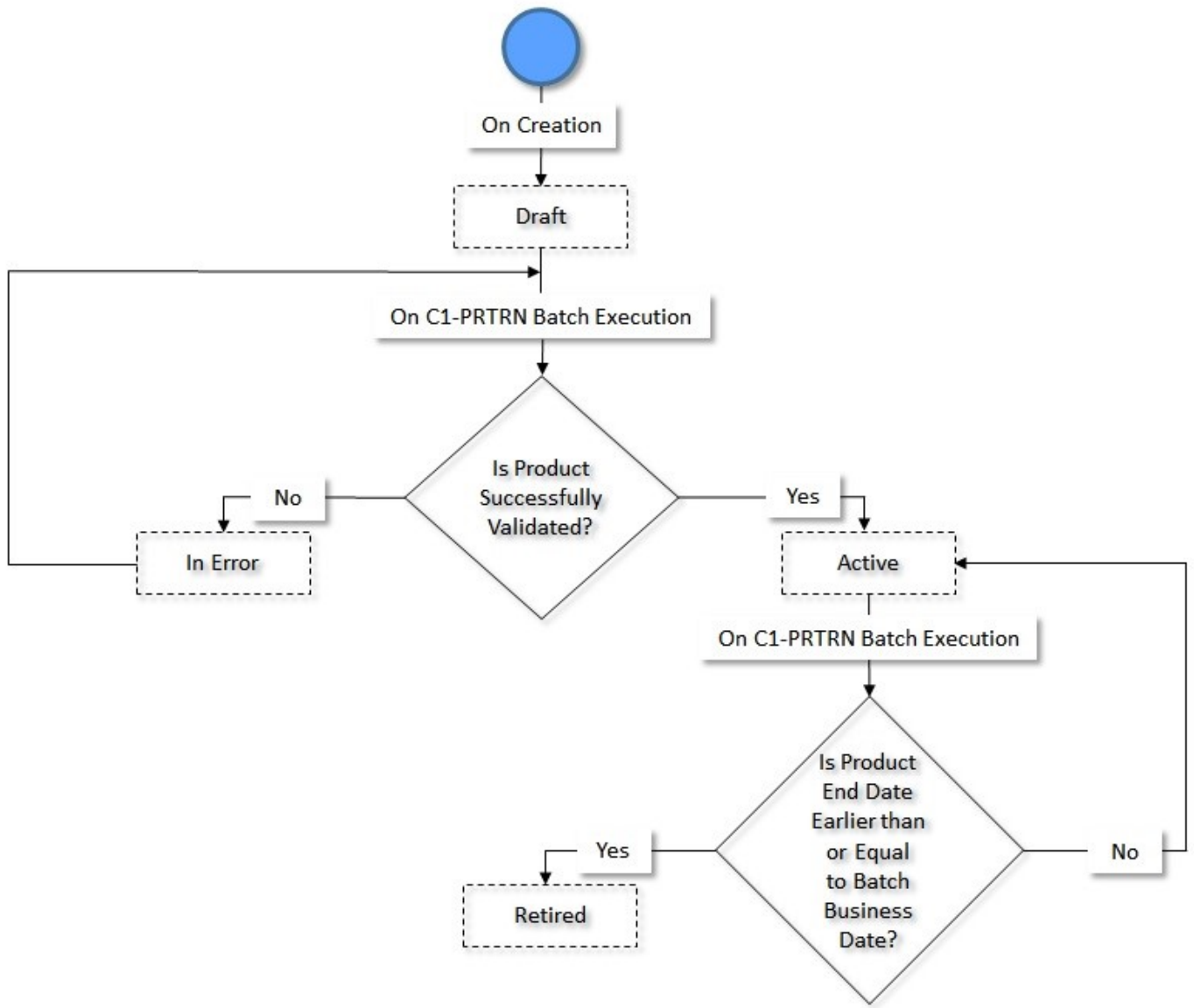

Product Version Status Transition

The following figure graphically indicates how a product version moves from one status to another in its lifecycle:

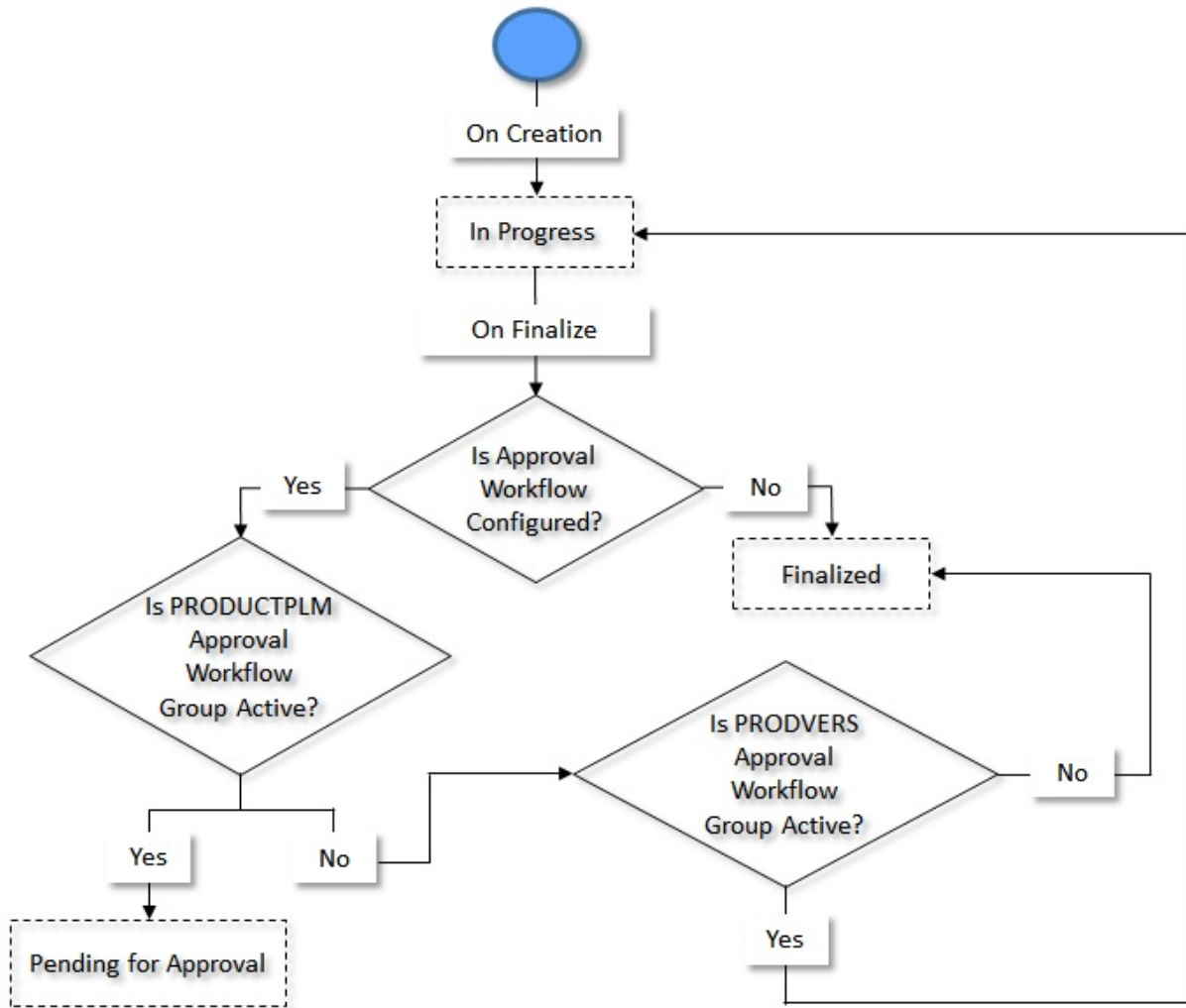

Product Enrollment Status Transition through User Interface

The following figure graphically indicates how a product enrollment moves from one status to another through the user interface:

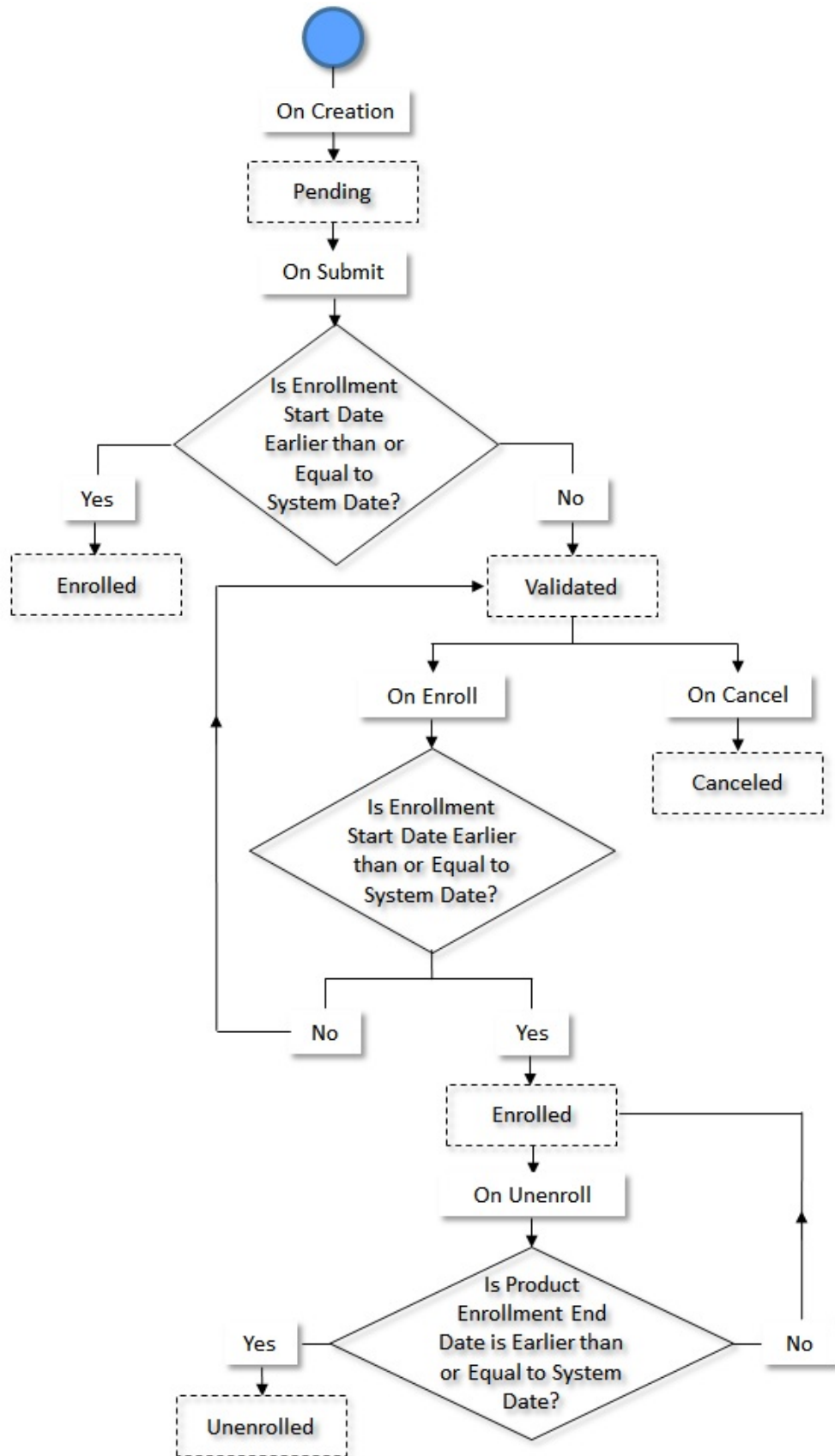

Product Enrollment Status Transition through a Batch Process

The following figure graphically indicates how a product enrollment moves from one status to another through the **Product Enrollment Monitor (C1-ENTRN)** batch:

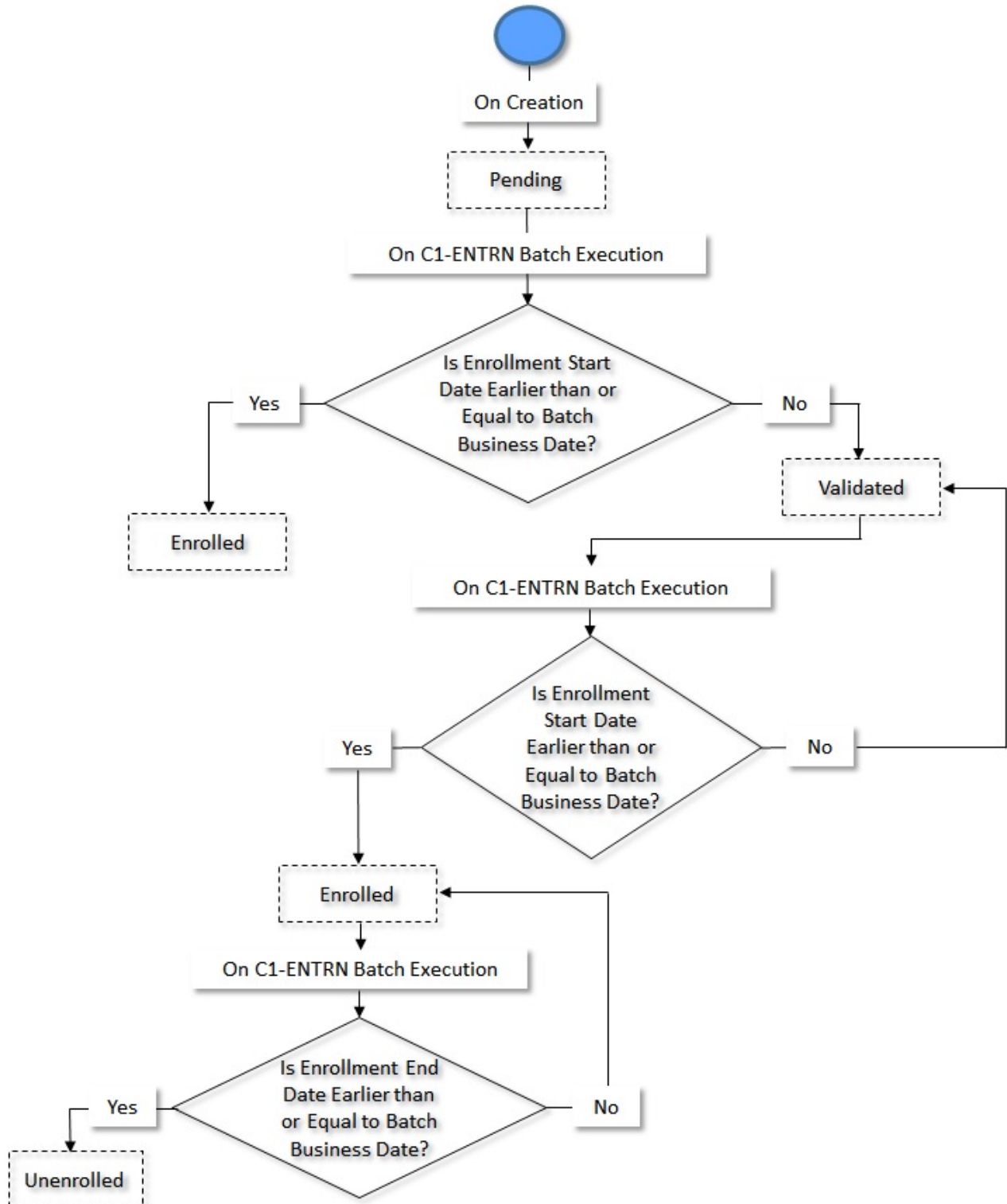

Product Service (Used for Searching)

The **Product Service** screen allows you to search for a product service using various search criteria. Through this screen, you can navigate to the following screen:

- [Product Service \(Used for Viewing\)](#) on page 2202

This screen consists of the following zone:

- [Search Product Service](#) on page 2195

For more information on...	See...
How to search for a product service	Searching for a Product Service on page 2196
How to view the details of a product service	Viewing the Product Service Details on page 2201

Search Product Service

The **Product Service Search** zone allows you to search for a product service using various search criteria. It contains the following two sections:

- **Search Criteria** - The **Search Criteria** section contains the following fields:

Field Name	Field Description	Mandatory (Yes or No)
Product Service	Used to search for a product service based on the unique user-defined product service.	No
Description	Used to specify the description of a product service.	No
Start Date	Used to search for product service which starts from a particular date onwards.	No
End Date	Used to search for product service which is created till a particular date.	No
Price Item Information	Used to search for product service for which a price item information is created or updated in the system.	No

Note: You must specify at least one search criterion while searching for a product service.

- **Search Results** - On clicking the **Search** button, the search results are filtered based on the specified search criteria. The **Search Results** section contains the following columns:

Column Name	Column Description
Product Service	Displays the service code of a product service.
Description	Displays the description of product service.
	Note: It has a link. On clicking the link, the Product Service screen appears where you can view the details of the respective product service.
Start Date	Displays the date from when the product service is effective.

Column Name	Column Description
End Date	Displays the date till when the product service is effective.

On clicking the **Broadcast** () icon corresponding to a service code, the **Price Items** zone appears with the details of the respective product service.

Related Topics

For more information on...	See...
How to search for a product service	Searching for a Product Service on page 2196
How to view the details of a product service	Viewing the Product Service Details on page 2201
Associated Price Item zone	Price Items on page 2203

Associated Price Items

The **Product Service Price Item** zone lists various price items that are associated with a service. It contains the following columns:

Column Name	Column Description
Price Item Information	Displays the price item information that is associated with a service. Note: It has a link. On clicking the link, the Price Item screen appears where you can view the details of the respective price item.
Start Date	Displays the date from when the product service will begin.
End Date	Displays the date till when the product service will be available.

Related Topics

For more information on...	See...
How to search for a product service	Searching for a Product Service on page 2196
How to view the price items associated with a product service	Viewing the Product Service Price Items on page 2197

Searching for a Product Service

Prerequisite

To search for a product service, you should have:

- Product Service defined in the application.
- Price Item defined in the application.

Procedure

To search for a product service:

1. From the **Main** menu, select **Pricing Management** and then click **Product Service**.
A sub-menu appears.
2. Click the **Search** option from the **Product Service** sub-menu.
The **Product Service** screen appears.

- Enter the search criteria in the [Search Product Service](#) on page 2195 zone.

Note: ORMB search engine supports wildcard search, where you can substitute the percentage (%) symbol as a stand in for any word or letter in a search criteria. You can use the ‘%’ wildcard character in all input fields except the date and ID fields. The ‘%’ wildcard character is suffixed automatically at the end of the partial search criteria. Therefore, you may or may not specify the wildcard character at the end of the partial search criteria. However, you have to prefix the wildcard character manually wherever required.

- Click **Search**.

A list of product services that meet the search criteria appear in the **Search Results** section.

Related Topics

For more information on...	See...
Search Product Service screen	Product Service (Used for Searching) on page 2195
Search Product Service zone	Search Product Service on page 2195

Viewing the Product Service Price Items

Procedure

To view the price items of the product:

- Search for a product service in the **Product Service** screen.
- In the **Search Results** section, click the **Broadcast** () icon corresponding to a service code whose details you want to view.

The **Price Items** zone appears. It contains the following columns:

Column Name	Column Description
Price Item	Displays the price item code that is set for each product service. Note: It has a link. On clicking the link, the Price Item screen appears where you can view the details of the respective price item.
Start Date	Displays the date from when the product service will begin.
End Date	Displays the date till when the product service will be available.

Related Topics

For more information on...	See...
Defining a Product Service	Defining a Product Service on page 2197
Searching a Product Service	Searching for a Product Service on page 2196
Viewing a Product Service	Viewing the Product Service Price Items on page 2197
Product Service Search screen	Product Service (Used for Searching) on page 2195
Product Service Search zone	Search Product Service on page 2195

Defining a Product Service

Prerequisites

To define a product service, you should have:

- Characteristic Type defined in the application (where the characteristic entity is set to **Product Service**)
- Price Item business object defined in the application.

Procedure

To define a product service:

1. Click the **Menu** link in the **Application** toolbar.

A list appears.

2. From the **Menu** list, select **Pricing Management**, and then click **Product Service**.

The sub-menu appears.

3. Click the **Add** option from the **Product Service** sub-menu.

The **Product Service** screen appears. It contains the following sections:

- **Main** - Used to specify basic details of the product service.
- **Characteristics** - Used to define the characteristics for a product service.
- **Price Items** - Used to define price item for a product service.

The **Main** section contains the following fields:

Field Name	Field Description	Mandatory (Yes or No)
Product Service	Used to specify the product service. Note: While defining a product service, ensure that at least one price item is associated with the product service.	Yes
Description	Used to specify the description of a product service.	Yes
Start Date	Used to specify the date from when the product service is effective. Note: The product service end date cannot be earlier than the product service start date.	Yes
End Date	Used to specify the date till when the product service is effective. Note: The product service end date cannot be earlier than the product service start date.	Yes

Note:

If the product service is used in one or more product versions, the product service's end date cannot be earlier than the product version's effective date.

4. Enter the required details in the **Main** section.

Note:

The Start Date field is mandatory.

5. Define the characteristics for a product service, if required.
6. Define the price item for a product service.

7. Click **Save**.

The product service is defined.

Related Topics

For more information on...	See...
Defining the characteristics for a product service	Defining a Characteristics for a Product Service on page 2200
Associating the product service with a Price Item	Associating a Product Service with a Price Item on page 2199

Associating a Product Service with a Price Item

Prerequisites

To associate a product service with a price item, you should have:

- Price Item business object defined in the application.

Procedure

To associate a product service with a price item:

1. Ensure that the **Price Items** section is expanded when you are defining, editing, or copying a product service.

The Price Item section contains the following fields:

Field Name	Field Description	Mandatory (Yes or No)
Price Item	Used to specify the price item which is associated with this product service. Note: The Search (🔍) icon appears corresponding to this field. On clicking the Search icon, the Price Item Search window appears.	No
Start Date	Used to specify the date from when the product service is effective.	No
End Date	Used to specify the date till when the product service is effective. Note: The price item end date cannot be earlier than the price item start date.	No

2. Enter the required details in the **Price Items** section.

Note: The product service is used in one or more product versions, and therefore the product service's start date cannot be later than the product version's effective date.

3. If you want to associate one or more price items with the product service, click the **Add** (+) icon and then repeat step 2. However, if you want to remove the price items from the product service, click the **Delete** (🗑️) icon corresponding to the price item.
4. Click **Save**.

Note:

You cannot associate the same price item multiple times with the product service.

You can remove a price item from the product service even though the product version is in the Finalized status. A To Do Type named **C1-SVCU1** gets created whenever any modifications are made to the product service.

You can associate a price item with a product service when the price item's date range is within the product service's date range.

If there are changes with respect to the price items associated with the product service, then you must create a new version for that product.

The product service is associated with the price item.

Related Topics

For more information on...	See...
Defining a product service	Defining a Product Service on page 2197
Editing a product service	Editing a Product Service on page 2203
Copying a product service	Copying a Product Service on page 2205

Defining a Characteristics for a Product Service**Prerequisites**

To define a characteristic for a product service, you should have:

- Characteristic Type defined in the application (where the characteristic entity is set to **Product Service**)

Procedure

To define a characteristic for a product service:

1. Ensure that the **Characteristics** section is expanded when you are defining, editing, or copying a product service.

The **Characteristics** section contains the following fields:

Field Name	Field Description	Mandatory (Yes or No)
Effective Date	Used to specify the date from when the characteristic is effective for the product service.	Yes (Conditional) Note: This field is required when you are defining a characteristic for the product service.
Characteristic Type	Used to indicate the characteristic type. Note: The list includes only those characteristic types where the characteristic entity is set to Product Service	Yes (Conditional) Note: This field is required when you are defining a characteristic for the product service.
Characteristic Value	Used to specify the value for the characteristic type.	Yes (Conditional)

Field Name	Field Description	Mandatory (Yes or No)
	<p>Note:</p> <p>If you select a predefined characteristic type, the Search (🔍) icon appears corresponding to the Characteristic Value field. On clicking the Search icon, you can search for a predefined characteristic value.</p> <p>On specifying the value for a predefined characteristic type, the description of the characteristic value appears corresponding to the Characteristic Value field.</p>	<p>Note: This field is required when you are defining a characteristic for the product service.</p>

2. Enter the required details in the **Characteristics** section.
3. If you want to define more than one characteristic for the product service, click the **Add (+)** *Icon* and then repeat step 2. However, if you want to remove a characteristic from the product service, click the **Delete (🗑)** icon corresponding to the characteristic.
4. Select an appropriate characteristic type from the **Characteristic Type** list.

Related Topics

For more information on...	See...
How to define a product service	Defining a Product Service on page 2197
How to edit a product service	Editing a Product Service on page 2203
How to copy a product service	Copying a Product Service on page 2205

Viewing the Product Service Details

Procedure

To view the details of the product service:

1. Search for a product service in the **Product Service** screen.
2. In the **Search Results** section, click the link in the **Description** column corresponding to the service code whose details you want to view.

The **Product Service** screen appears. It contains the following zones:

- **Product Service**
- **Associated Price Items**

3. View the product service details in the [Product Service](#) on page 2202 zone.

Related Topics

For more information on...	See...
Product Service screen	Product Service (Used for Viewing) on page 2202
Product Service zone	Product Service on page 2202
How to edit the product service details	Editing a Product Service on page 2203
How to delete the product service details	Deleting a Product Service on page 2204

For more information on...	See...
How to copy the product service details	Copying a Product Service on page 2205

Product Service (Used for Viewing)

The **Product Service** screen allows you to:

- View the details and characteristics of the product service
- Edit, Delete, and Copy the details of the product service
- View the product service business object
- View the price items that are associated with the product service

The **Product Service** screen consists of the following zones:

- [Product Service](#) on page 2202
- [Price Items](#) on page 2203

Product Service

The **Product Service** zone displays the details of the product service. It contains the following sections:

- **Main** - Displays the basic information about the product service. It contains the following fields:

Field Name	Field Description
Product Service	Displays the product service that is assigned to a product service.
Description	Displays the description of the product service.
Start Date	Displays the date when the product service starts.
End Date	Displays the date when the product service ends.

- **Characteristics** - Lists the characteristics defined for the product service. It contains the following columns:

Column Name	Column Description
Effective Date	Displays the date from when the characteristic is effective for the product service.
Characteristic Type	Indicates the characteristic type.
Characteristic Value	Displays the value of the characteristic type.

- **Record Actions** - This section contains the following buttons:

Button Name	Button Description
Edit	Used to edit the details of the product service.
Delete	Used to delete the product service.
Duplicate	Used to create a new product service using an existing product service information.

- **Record Information** - This section contains the following fields:

Field Name	Field Description
Business Object	Indicates the business object using which the product service is created. In addition, a context menu appears corresponding to this field which helps in navigating to other screens in the application.
	Note: It has a link. On clicking the link, the Business Object screen appears where you can view the details of the respective business object.

Price Items

The **Product Service Price Item** zone lists various price items that are associated with a service. It contains the following columns:

Column Name	Column Description
Price Item Information	Displays the price item information that is associated with a service.
	Note: It has a link. On clicking the link, the Price Item screen appears where you can view the details of the respective price item.
Start Date	Displays the date from when the product service will begin.
End Date	Displays the date till when the product service will be available.

Related Topics

For more information on...	See...
How to search for a product service	Searching for a Product Service on page 2196
How to view the details of a product service	Viewing the Product Service Details on page 2201

Editing a Product Service

Procedure

To edit a product service:

1. Search for the product service in the **Product Service**.
2. In the **Search Results** section, click the link in the **Description** column corresponding to the product service whose details you want to edit.

The **Product Service** screen appears.

3. Click the **Edit** button in the **Product Service** zone.

The **Product Service** screen appears.

Note: ORMB search engine supports wildcard search, where you can substitute the percentage (%) symbol as a stand in for any word or letter in a search criteria. You can use the ‘%’ wildcard character in all input fields except the date and ID fields. The ‘%’ wildcard character is suffixed automatically at the end of the partial search criteria. Therefore, you may or may not specify the wildcard character at the end of the partial search criteria. However, you have to prefix the wildcard character manually wherever required.

4. Modify the details of the product service in the main section, if required.
5. Modify the characteristics for a product service, if required.

6. Associate the price items with a product service, if required.
7. Click **Save**.

The changes made to the product service are saved.

Related Topics

For more information on...	See...
How to search for a product service	Searching for a Product Service on page 2196
How to view the details of a product service	Viewing the Product Service Details on page 2201
Product Service screen	Product Service (Used for Viewing) on page 2202
How to define a characteristic for a product service	Defining a Characteristics for a Product Service on page 2200
How to associate the price items with a product service	Associating a Product Service with a Price Item on page 2199

Deleting a Product Service

Procedure

To delete a product service:

1. Search for the product service in the **Product Service**.

Note: ORMB search engine supports wildcard search, where you can substitute the percentage (%) symbol as a stand in for any word or letter in a search criteria. You can use the ‘%’ wildcard character in all input fields except the date and ID fields. The ‘%’ wildcard character is suffixed automatically at the end of the partial search criteria. Therefore, you may or may not specify the wildcard character at the end of the partial search criteria. However, you have to prefix the wildcard character manually wherever required.

2. In the **Search Results** section, click the link in the **Description** column corresponding to the product service whose details you want to delete.

The **Product Service** screen appears.

3. Click the **Delete** button in the **Product Service** zone.

A message appears confirming whether you want to delete the product service.

Note: If the product service is associated with the product version, then the product service cannot be deleted.

4. Click **OK**.

The product service is deleted.

Related Topics

For more information on...	See...
How to search for a product service	Searching for a Product Service on page 2196
How to view the details of a product service	Viewing the Product Service Details on page 2201
Product Service screen	Product Service (Used for Viewing) on page 2202

Copying a Product Service

Instead of creating a product service from scratch, you can create a new product service using an existing product service. This is possible through copying a product service. On copying a product service, the details including the algorithms and characteristics are copied to the new product service. You can then edit the details, if required.

Prerequisites

To define a product service, you should have:

- Characteristic Type defined in the application (where the characteristic entity is set to **Product Service**)
- Price Item business object defined in the application.

Procedure

To define a product service:

1. Click the **Menu** link in the **Application** toolbar.
A list appears.
2. From the **Menu** list, select **Pricing Management**, and then click **Product Service**.
The sub-menu appears.
3. Click the **Search** option from the **Product Service** sub-menu.

The **Product Service** screen appears. It contains the following sections:

- **Main** - Used to specify basic details of the product service.
- **Characteristics** - Used to define the characteristics for a product service.
- **Price Items** - Used to define price item for a product service.

The **Main** section contains the following fields:

Field Name	Field Description	Mandatory (Yes or No)
Product Service	Used to specify the product service.	Yes
Description	Used to specify the description of a product service.	Yes
Start Date	Used to specify the date from when the product service is effective.	Yes
End Date	Used to specify the date till when the product service is effective.	Yes

Tip: Alternatively, you can click the **Duplicate** button in the **Record Actions** section, in the **Product Service** zone to create a copy of the product service.

4. Enter the required details in the **Main** section.
5. Define the characteristics for a product service, if required.
6. Define the price item for a product service, if required.
7. Click **Save**.

The new product service is defined.

Related Topics

For more information on...	See...
How to search for a product service	Searching for a Product Service on page 2196
How to view the details of a product service	Viewing the Product Service Details on page 2201
Product Service screen	Product Service (Used for Viewing) on page 2202
How to define a characteristic for a product service	Defining a Characteristics for a Product Service on page 2200
How to associate price items to a product service	Associating a Product Service with a Price Item on page 2199

Product (Used for Searching)

The **Product** screen allows you to search for a product using various search criteria. Through this screen, you can navigate to the following screen:

- [Product \(Used for Viewing\)](#) on page 2237

This screen consists of the following zone:

- [Search Product](#) on page 2206

For more information on...	See...
How to search for a product	Searching for a Product on page 2208
How to view the details of a product	Viewing the Product Details on page 2209

Search Product

The **Search Product** zone allows you to search for a product using various search criteria. It contains the following two sections:

- **Search Criteria** - The **Search Criteria** section contains the following fields:

Field Name	Field Description	Mandatory (Yes or No)
Product	Used to search for a particular product.	No
Description	Used to search products with a particular description.	No
Start Date	Used to search for products which are created from a particular date onwards.	No
End Date	Used to search for products which are created till a particular date.	No
Product Type	Used to search for products which are created using a particular product type. The valid values are: <ul style="list-style-type: none"> • Packaged • Informational • Standard 	No
Product Category	Used to search for products which are created using a specific category. The valid values are: <ul style="list-style-type: none"> • Checking • Loans 	No

Field Name	Field Description	Mandatory (Yes or No)
	<ul style="list-style-type: none"> Others Savings 	
Status	Used to search for products which are created using a specific status. The valid values are: <ul style="list-style-type: none"> Active Draft Error Retired 	No
Division	Used to search for products which belong to a specific division.	No
Product Manager's To Do Role	Used to search for products which belong to a specific Product Manager's To Do Role. <div style="border: 1px solid black; padding: 5px; margin-top: 10px;"> <p>Note:</p> <p>If you select a predefined To Do Role, the Search (🔍) icon appears corresponding to the Product Manager's To Do Role field. On clicking the Search icon, you can search for a predefined To Do value.</p> <p>On specifying the value for a predefined To Do Role, the description of the To Do Role value appears corresponding to the Product Manager's To Do Role field.</p> </div>	No

Note: You must specify at least one search criterion while searching for a product.

- **Search Results** - On clicking the **Search** button, the search results are filtered based on the specified search criteria. The **Search Results** section contains the following columns:

Column Name	Column Description
Product	Displays the code of the product.
Description	Displays the description of the product.
	Note: It has a link. On clicking the link, the Product screen appears with the details of the respective product.
Status	Displays the status of the product.
Product Type	Indicates the type of the product.
Product Category	Indicates the category of the product.
Start Date	Displays the date from when the product is effective.
End Date	Displays the date till when the product is effective.

On clicking the **Broadcast** (📢) icon corresponding to the product column, the **Product Version List** zone appears with the details of the respective product.

Related Topics

For more information on...	See...
How to search for a product	Searching for a Product on page 2208
How to view the details of a product	Viewing the Product Details on page 2209
Product Version List zone	Product Version List on page 2208

Product Version List

The **Product Version List** zone lists the information related to the product version.

Column Name	Column Description
Effective Date	Displays the date from when the product version is effective.
Description	Displays the description of the product version.
	Note: It has a link. On clicking the link, the Product Version screen appears where you can view the details of the respective product version.
Status	Displays the status of the product version.

Related Topics

For more information on...	See...
How to search for a product	Searching for a Product on page 2208
How to view the details of a product	Viewing the Product Details on page 2209
How to view the versions of a product	Viewing the Product Versions on page 2209

Searching for a Product

Prerequisite

To search for a product, you should have:

- Product Type defined in the application.
- Product Category defined in the application.
- Division defined in the application.
- Relationship Type defined in the application.

Procedure

To search for a product:

1. From the **Main** menu, select **Pricing Management** and then click **Product**.
A sub-menu appears.
2. Click the **Search** option from the **Product** sub-menu.
The **Product** screen appears.
3. Enter the search criteria in the **Search Product** zone.

Note: ORMB search engine supports wildcard search, where you can substitute the percentage (%) symbol as a stand in for any word or letter in a search criteria. You can use the ‘%’ wildcard character in all input fields except the date and ID fields. The ‘%’ wildcard character is suffixed automatically at the end of the partial search criteria. Therefore, you may or may not specify the wildcard character at the end of the partial search criteria. However, you have to prefix the wildcard character manually wherever required.

4. Click **Search**.

A list of products that meet the search criteria appear in the **Search Results** section.

Related Topics

For more information on...	See...
Search Product screen	Product (Used for Searching) on page 2206
Search Product zone	Search Product Service on page 2195

Viewing the Product Versions

Procedure

To view the details of the product version:

1. Search for a product in the **Product** screen.
2. In the **Search Results** section, click the **Broadcast** () icon corresponding to the product whose details you want to view.

The **Product Version List** screen appears. It contains the following zones:

- [Product Version List](#) on page 2208

3. View the product version details in the **Product Version** screen.

Related Topics

For more information on...	See...
How to search for a product	Searching for a Product on page 2208
Search Product screen	Product (Used for Searching) on page 2206
Search Product zone	Search Product on page 2206
Product Version List zone	Product Version List on page 2208

Viewing the Product Details

Procedure

To view the details of the product:

1. Search for a product in the **Product** screen.
2. In the **Search Results** section, click the link in the **Description** column corresponding to the product whose details you want to view.

The **Product Service** screen appears. It contains the following tabs:

- [Product - Main](#) on page 2238
- [Product - Log](#) on page 2240

Related Topics

For more information on...	See...
How to search for a product	Searching for a Product on page 2208

Viewing the Product Version Details

Procedure

To view the details of the product version:

1. Search for a product in the **Product** screen.
2. In the **Search Results** section, click the **Broadcast** () icon corresponding to the product whose details you want to view.

View the details of the product version in the [Product Version List](#) on page 2208

Related Topics

For more information on...	See...
How to search for a product	Searching for a Product on page 2208

Defining a Product

Prerequisites

To define a product, you should have:

- Product Type should be defined in the application.
- Product Category should be defined in the application.

Procedure

To define a product:

1. Click the **Menu** link in the **Application** toolbar.
A list appears.
2. From the **Menu** list, select **Pricing Management**, and then click **Product**.
The sub-menu appears.
3. Click the **Add** option from the **Product** sub-menu.

The **Product** screen appears. It contains the following sections:

- **Main** - Used to specify basic details of the product.
- **Divisions** - Used to define the characteristics for a product.
- **Product to Product Relationship** - Used to define product to product relationship for a product.
- **Characteristics** - Used to define the characteristics for a product.

The **Main** section contains the following fields:

Field Name	Field Description	Mandatory (Yes or No)
Product	Used to specify the product.	Yes
Description	Used to specify the description of a product.	Yes
Status	Displays the status of the product.	Yes

Field Name	Field Description	Mandatory (Yes or No)
	Note: Whenever a new product is added, it will have the status as Draft .	
Product Type	Used to indicate the type of a product.	Yes
Product Category	Used to indicate the category of a product.	Yes
Start Date	Used to specify the date from when the product is effective.	Yes
End Date	Used to specify the date till when the product is effective.	No
Compliance Number	Used to specify the compliance number received from the legal department.	No
Product Manager To Do Role	Used to specify all the To Do raised against this product that are further assigned to this product manager To Do role.	No

- Enter the required details in the **Main** section.

Note:

You cannot add or edit a product version when the product is in the Retired status.

The Start Date field is mandatory.

- Associate a division with a product, if required.
- Define the characteristics for a product, if required.

Note:

Ensure that the value is specified for the characteristic type option type in the C1-PRODCH feature configuration.

Ensure that a valid value is specified for the characteristic type.

- Define the price item for a product, if required.
- Click **Save**.

The product is defined.

Related Topics

For more information on...	See...
Associating a division with the product	Associating a Product with a Division on page 2211
Defining the product to product relationship	Defining a Product to Product Relationship on page 2212
Defining the characteristics for the product	Defining a Characteristics for a Product on page 2213

Associating a Product with a Division

Prerequisites

To associate product with a division, you should have:

- Division defined in the application.

Procedure

To associate product with a division:

1. Ensure that the **Divisions** section is expanded when you are defining, editing, or copying a product.

The Division section contains the following fields:

Field Name	Field Description	Mandatory (Yes or No)
Division	Used to specify the division of the product.	Yes

2. Enter the required details in the **Divisions** section.

Note:

At least one division must be associated with the product.

3. If you want to associate one or more divisions with the product, click the **Add (+)** icon and then repeat step 2.

Note:

However, if you want to remove the divisions from the product, click the **Delete (🗑)** icon corresponding to the product.

4. Click **Save**.

Note:

Ensure that the division associated with the product is associated to the price list.

You cannot remove the division from the product because the price list associated to the product version which is effective on (mention date) is associated to the division.

The divisions are associated with the product.

Related Topics

For more information on...	See...
Defining a product	Defining a Product on page 2210

Defining a Product to Product Relationship

Prerequisites

To define a product to product relationship, you should have:

- Relationship Type defined in the application.

Procedure

To define a product to product relationship:

1. Ensure that the **Product to Product Relationship** section is expanded when you are defining, editing, or copying a product.

The Product to Product Relationship section contains the following fields:

Field Name	Field Description	Mandatory (Yes or No)
Product	Used to specify the product.	Yes
Relationship Type	Used to indicate the relationship type with the product. The valid values are: <ul style="list-style-type: none"> Child product Parent product 	Yes
Effective Start Date	Used to specify the date from when the product to product relationship will begin.	No
Effective End Date	Used to specify the date till when the product to product relationship will be available.	No

- Define the details of the product in the main section, if required.

Note:

The product to product relationship start and end dates must be within the product's start and end dates.

- Define the division for a product, if required.

Note:

The division associated with the child product is not associated with the packaged product.

- Define the product to product relationship for a product, if required.

Note:

The child product that you want to add in the product version is not effective, as it must be in an active state.

- Define the characteristics for a product, if required.

- Click **Save**.

The product to product relationship is defined.

Related Topics

For more information on...	See...
How to define a product	Defining a Product on page 2210
How to associate a product with a division	Associating a Product with a Division on page 2211
How to define a characteristic for a product	Defining a Characteristics for a Product on page 2213

Defining a Characteristics for a Product**Prerequisites**

To define a characteristic for a product, you should have:

- Characteristic Type defined in the application (where the characteristic entity is set to **Product**)

Procedure

To define a characteristic for a product:

1. Ensure that the **Characteristics** section is expanded when you are defining, editing, or copying a product service.

The **Characteristics** section contains the following fields:

Field Name	Field Description	Mandatory (Yes or No)
Effective Date	Used to specify the date from when the characteristic is effective for the product.	Yes (Conditional)
		Note: This field is required when you are defining a characteristic for the product.
Characteristic Type	Used to indicate the characteristic type. The valid values are: <ul style="list-style-type: none"> • AP Product Type • FK Reference for Product • Stop Existing Enrollment on End Date 	Yes (Conditional)
		Note: This field is required when you are defining a characteristic for the product.
		Note: The list includes only those characteristic types where the characteristic entity is set to Product .
Characteristic Value	Used to specify the value for the characteristic type.	Yes (Conditional)
		Note: This field is required when you are defining a characteristic for the product.
	<p>Note:</p> <p>If you select a predefined characteristic type, the Search (🔍) icon appears corresponding to the Characteristic Value field. On clicking the Search icon, you can search for a predefined characteristic value.</p> <p>On specifying the value for a predefined characteristic type, the description of the characteristic value appears corresponding to the Characteristic Value field.</p>	

2. Enter the required details in the **Characteristics** section.

Note: The effective date of a characteristic cannot be earlier than the product start date and later than the product end date.

3. If you want to define more than one characteristic for the product service, click the **Add** (+) icon and then repeat step 2. However, if you want to remove a characteristic from the product service, click the **Delete** (🗑️) icon corresponding to the characteristic.
4. Select an appropriate characteristic type from the **Characteristic Type** list.

Related Topics

For more information on...	See...
How to define a product	Defining a Product on page 2210

For more information on...	See...
How to associate a product with a division	Associating a Product with a Division on page 2211
How to define a product to product relationship	Defining a Product to Product Relationship on page 2212

Defining a Product Version

Prerequisites

To define a product version, you should have:

- Product defined in the application.

Procedure

To define a product version:

1. Search for the product in the **Search Product** zone.
2. In the **Search Results** section, click the **Broadcast** () icon, corresponding to the product whose product version details you want to view.

The **Product Version List Search** zone appears

3. Click the **Add** link in the **Product Version List** zone.

The **Product Version** screen appears. It contains the following sub sections:

- **Main** - Used to specify the basic details of the product version.
- **Product Services** - Used to assign the product services to the product version.
- **Price Lists** - Used to associate the price lists with a product version.
- **Eligibility** - Used to specify the eligibility criteria for a product version.
- **Characteristics** - Used to define the characteristics for a product version.

The **Main** section contains the following fields:

Field Name	Field Description	Mandatory (Yes or No)
Product Type	Displays the product type.	Not applicable
Product	Displays the product code.	Not applicable
Effective Date	Used to specify the effective date from when the product version will be effective.	Yes
Status	Used to specify the status of the version.	Yes
	Note: It is a read-only field, and cannot be edited.	
Description	Used to specify the description for the version.	No
Terms and Conditions	Used to specify the terms and conditions for the version.	Yes

Field Name	Field Description	Mandatory (Yes or No)
	<p>Note:</p> <p>Click the Search (🔍) icon appearing corresponding to the Terms and Conditions field. On clicking the Search icon, you can search for a predefined terms and conditions.</p>	

Note:

The Effective Date field is mandatory.

- Enter the required details in the **Products and Services** and/or **Product Services** section.

Note:

If the product type is **Packaged** then **Products and Services** section appears. If the product type is **Standard** then **Product Services** section is displayed. If the else both of these sections do not appear.

You must have at least one product added in the product version.

You must have at least one product service added in the product version.

The effective date of a product version cannot be earlier than the product start date.

You must select the Inclusion check box when the product service is defined as mandatory in the effective product version.

You cannot add a product version when the product is in the Retired status.

The product that you want to add in the product version must be in the Active status.

- Enter the required details in the **Price List** section.

Note:

The pricing for the price item which is associated with the product service must be available in the price list.

- Enter the required details in the **Eligibility** section.
- Enter the required details in the **Characteristics** section.
- Click **Save**.

The product version is defined.

Related Topics

For more information on...	See...
How to add a product service to a product version	Adding a Product Service to a Product Version on page 2217
How to add a standard product to a product version	Adding a Standard Product to a Product Version on page 2218
How to add add-on services to a product version	Adding Add-on Services to a Product Version on page 2219
How to associate price list with a product version	Associating a Price List with a Product Version on page 2220

For more information on...	See...
How to define eligibility criteria for a product version	Defining Eligibility Criteria for a Product Version on page 2221
How to define a characteristic for a product version	Defining a Characteristic for a Product Version on page 2224

Adding a Product Service to a Product Version

Procedure

To add a product service to a product version:

1. Search for a product in the **Search Product** zone.
2. In the **Search Results** section, click the link in the **Description** column corresponding to the product whose details you want to view.

The **Product** screen appears. It consists of the following tabs:

- [Product - Main](#) on page 2238
- [Product - Log](#) on page 2240

3. Ensure that the **Main** tab is selected.
4. Click the **Add** link in the **Product Version** zone.

The **Product Version** screen appears.

5. Click the **Product Services** link mentioned in the **Sections** navigation panel.

The **Products** section appears. It contains the following fields:

Field Name	Field Description	Mandatory (Yes or No)
Products	Indicates the product code for the version.	Yes
	Note: Click the Search (🔍) icon appearing corresponding to the Products field. On clicking the Search icon, you can search for a predefined products.	
Product Service	Displays the product service for the version.	No
	Note: Once a product is selected using the Ora Search , it appears in the Products field, and its corresponding product service is displayed in the Product Service column.	
Mandatory	Used to indicate that the service is a mandatory option for the version.	Not applicable
	Note: The mandatory checkbox is already checked for a service code when the same service code field is checked as a Mandatory option from the Product Version screen.	

Field Name	Field Description	Mandatory (Yes or No)
Inclusion	Used to indicate the services that are enrolled for a version.	Yes (Conditional)
		Note: The inclusion checkbox must be checked, if the mandatory checkbox field has been already checked.

Note: The **Products** and the **Add-on Product** services section appear when the product searched is a **Packaged** product.

6. Enter the required details in the **Products** section.
7. If you want to add more than one product to the product version, click the **Add (+)** icon and then repeat step 6. However, if you want to remove a product from the **Products** section, click the **Delete (🗑)** icon corresponding to the product field.
8. Click **Save**.
The product service is added to the product version.

Related Topics

For more information on...	See...
How to add a product version	Defining a Product Version on page 2215
How to associate a price list with a product	Associating a Price List with a Product Version on page 2220
How to define eligibility criteria for a product version	Defining Eligibility Criteria for a Product Version on page 2221
How to define a characteristic for a product version	Defining a Characteristic for a Product Version on page 2224

Adding a Standard Product to a Product Version

Prerequisites

To add a standard product to a product version, you should have:

- Standard product should be defined in the application.

Procedure

To add a standard product to a product version:

1. Search for a product in the **Search Product** zone.
2. In the **Search Results** section, click the link in the **Description** column corresponding to the product whose details you want to view.

The **Product** screen appears. It consists of the following tabs:

- Product — Main
- Product — Log

3. Click the **Add** link in the **Product Version** zone.

The **Product Version** screen appears. It contains the following sections:

- **Main** - Used to specify the basic details of the product version.
- **Product Services** - Used to assign the product services to the product version.
- **Price List** - Used to associate the price list with a product version.
- **Eligibility** - Used to specify the eligibility criteria for a product version.
- **Characteristics** - Used to define the characteristics for a product version.

The **Product Services** section contains the following fields:

Field Name	Field Description	Mandatory (Yes or No)
Product Service	Displays the service code for the version.	No
	<p>Note:</p> <p>Click the Search (🔍) icon appearing corresponding to the Product Service field. On clicking the Search icon, you can search for a predefined product services.</p>	

4. Enter the required details in the main section, if required.
5. Associate a price list with a version, if required.
6. Define the eligibility criteria for a product version, if required.
7. Define the characteristics for a product version, if required.
8. Click **Save**.

The standard product is added to the product version.

Related Topics

For more information on...	See...
How to define a product version	Defining a Product Version on page 2215
How to add a product service with a product version	Adding a Product Service to a Product Version on page 2217
How to associate a price list with a product version	Associating a Price List with a Product Version on page 2220
How to define eligibility criteria for a product version	Defining Eligibility Criteria for a Product Version on page 2221
How to define a characteristic for a product version	Defining a Characteristic for a Product Version on page 2224

Adding Add-on Services to a Product Version

Procedure

To add-on services to a product version:

1. Search for a product in the **Search Product** zone.
2. In the **Search Results** section, click the link in the **Description** column corresponding to the product whose details you want to view.

The **Product** screen appears. It consists of the following tabs:

- Product — Main
 - Product — Log
3. Ensure that the **Main** tab is selected.
 4. Click the **Add** link in the **Product Version** zone.

The **Product Version** screen appears.

5. Click the **Product Services** link mentioned in the **Sections** navigation panel.

The **Add-on Product Services** section appears. It contains the following fields:

Field Name	Field Description	Mandatory (Yes or No)
Product Service	Displays the service code for the version.	No
	Note: Click the Search (🔍) icon appearing corresponding to the Product Service field. On clicking the Search icon, you can search for a predefined product services.	

6. If you want to add more than one product service to the product version, click the **Add** (+) icon. However, if you want to remove a product service from the **Add-on Product Services** section, click the **Delete** (🗑️) icon corresponding to the product service field.

7. Click **Save**.

The add-on product service is added to the product version.

Related Topics

For more information on...	See...
How to add a product to the product version	Defining a Product Version on page 2215
How to add a product service with a product version	Adding a Product Service to a Product Version on page 2217
How to associate a price list with a product version	Associating a Price List with a Product Version on page 2220
How to define eligibility criteria for a product version	Defining Eligibility Criteria for a Product Version on page 2221
How to define a characteristic for a product version	Defining a Characteristic for a Product Version on page 2224

Associating a Price List with a Product Version

Procedure

To associate a price list with a product version:

1. Search for a product in the **Search Product** zone.
2. In the **Search Results** section, click the link in the **Description** column corresponding to the product whose details you want to view.

The **Product** screen appears. It consists of the following tabs:

- [Product - Main](#) on page 2238
 - [Product - Log](#) on page 2240
3. Ensure that the **Main** tab is selected.
 4. Click the **Add** link in the **Product Version** zone.

The **Product Version** screen appears.

5. Click the **Product Services** link mentioned in the **Sections** navigation panel.

The **Price List** section appears. It contains the following fields:

Field Name	Field Description	Mandatory (Yes or No)
Price List ID	Indicates the price list that is to be associated with the product version.	Not applicable
	<p>Note:</p> <p>Click the Search (🔍) icon appearing corresponding to the Price List ID field. On clicking the Search icon, you can search for a predefined price lists.</p>	

6. If you want to add more than one price list to the product version, click the **Add** (+) icon. However, if you want to remove a price list from the **Price List** section, click the **Delete** (🗑️) icon corresponding to the product service field.
7. Click **Save**.

Note:

The division associated with the product must be associated to the price list.

The price list that you want to associate with the product version must be in the Active status.

The price list that you want to associate with the product version must be effective.

The price list is added to the product version.

Related Topics

For more information on...	See...
How to add a product to a product version	Defining a Product Version on page 2215
How to add a product service to a product version	Adding a Product Service to a Product Version on page 2217
How to define eligibility criteria for a product version	Defining Eligibility Criteria for a Product Version on page 2221
How to define a characteristic for a product version	Defining a Characteristic for a Product Version on page 2224

Defining Eligibility Criteria for a Product Version

Procedure

To associate a price list with a product version:

1. Search for a product in the **Search Product** zone.
2. In the **Search Results** section, click the link in the **Description** column corresponding to the product whose details you want to view.

The **Product** screen appears. It consists of the following tabs:

- [Product - Main](#) on page 2238
- [Product - Log](#) on page 2240

3. Ensure that the **Main** tab is selected.
4. Click the **Add** link in the **Product Version** zone.

The **Product Version** screen appears.

5. Click the **Product Services** link mentioned in the **Sections** navigation panel.

The **Eligibility** section appears. It contains the following fields:

Field Name	Field Description	Mandatory (Yes or No)
Criteria	Displays the criteria (📄) icon. By clicking the criteria icon, additional fields are displayed that allow you to enter various types of criteria.	Not applicable
Eligibility Type	Indicates the list of logical criteria that is checked during enrollment of the customer to the Product and Product Version. The valid value is: <ul style="list-style-type: none"> • Eligibility Rule 	No
Start Date	Used to specify the date from when the eligibility criteria will be effective.	Yes (Conditional) Note: This field is required when you have selected the eligibility criteria from the eligibility type dropdown.
End Date	Used to specify the date till when the eligibility criteria will be effective.	No
Description	Used to specify the description for the eligibility criteria.	No
Sequence	Used to specify the order in which the product version eligibility criteria should be executed.	Yes
Parameter	Indicates the parameter (on the left hand side) which is used in the pricing eligibility criteria.	No
Operator	Displays the relational operator to define the relation between the parameter name and value.	Yes
Parameter Value Type	Indicates the parameter value against which you want to compare the parameter.	No
Parameter	Indicates the parameter (on the right hand side) against which you want to compare the parameter (on the left hand side).	No
Is True	Indicates what happens when the condition is true (satisfied). The valid values are:	No

Field Name	Field Description	Mandatory (Yes or No)
	<ul style="list-style-type: none"> • Check Next Condition - Indicates that the condition with consecutive sequence number should be executed. • Rule Is False - Indicates that the action specified in the Rule False Action field should be executed. • Rule Is True - Indicates that the action specified in the Rule True Action field should be executed. 	
Is False	<p>Indicates what happens when the condition is false (not satisfied). The valid values are:</p> <ul style="list-style-type: none"> • Check Next Condition - Indicates that the condition with consecutive sequence number should be executed. • Rule Is False - Indicates that the action specified in the Rule False Action field should be executed. • Rule Is True - Indicates that the action specified in the Rule True Action field should be executed. 	No
Is Insufficient	<p>Indicates what happens when the data is insufficient. The valid values are:</p> <ul style="list-style-type: none"> • Check Next Condition - Indicates that the condition with consecutive sequence number should be executed. • Rule Is False - Indicates that the action specified in the Rule False Action field should be executed. • Rule Is True - Indicates that the action specified in the Rule True Action field should be executed. 	No

6. Enter the required details in the **Eligibility** section.
7. If you want to add more than one eligibility / criteria to the product version, click the **Add (+)** icon. However, if you want to remove a eligibility / criteria from the **Eligibility** section, click the **Delete (🗑)** icon corresponding to the criteria / sequence field.
8. Click **Save**.

Note:

You cannot define eligibility criteria for the product version when the eligibility criteria is already defined for the price list.

You cannot define an eligibility criteria whose start date is earlier than the product version effective date.

You cannot define multiple eligibility criteria for the product version with the overlapping date range.

The eligibility is defined for the product version.

Related Topics

For more information on...	See...
How to define a product version	Defining a Product Version on page 2215

For more information on...	See...
How to add a standard product to a product version	Adding a Standard Product to a Product Version on page 2218
How to add a product service to a product version	Adding a Product Service to a Product Version on page 2217
How to define a characteristic for a product version	Defining a Characteristic for a Product Version on page 2224

Defining a Characteristic for a Product Version

Procedure

To define a characteristic for a product version:

1. Search for a product in the **Search Product** zone.
2. In the **Search Results** section, click the link in the **Description** column corresponding to the product whose details you want to view.

The **Product** screen appears. It consists of the following tabs:

- Product — Main
- Product — Log

3. Ensure that the **Main** tab is selected.
4. Click the **Add** link in the **Product Version** zone.

The **Product Version** screen appears.

5. Click the **Product Services** link mentioned in the **Sections** navigation panel.

The **Characteristics** section appears. It contains the following fields:

Field Name	Field Description	Mandatory (Yes or No)
Effective Date	Used to specify the date from when the characteristic is effective for the product version.	Yes (Conditional)
		Note: This field is required when you are defining a characteristic for the price item or price item bundle.
Characteristic Type	Used to indicate the characteristic type.	Yes (Conditional)
		Note: The list includes only those characteristic types where the characteristic entity is set to Price Item.
Characteristic Value	Used to specify the value for the characteristic type.	Yes (Conditional)
		Note: On specifying the value for a predefined characteristic type, the description of the characteristic value appears corresponding to the Characteristic Value field.

6. Enter the required details in the **Characteristics** section.

7. If you want to add more than one characteristic to the product version, click the **Add (+)** icon. However, if you want to remove a characteristic from the **Characteristics** section, click the **Delete (🗑)** icon corresponding to the effective date field.
8. Click **Save**.

The characteristics are defined for the product version.

Related Topics

For more information on...	See...
How to add a product service to a product version	Adding a Product Service to a Product Version on page 2217
How to add a standard product to a product version	Adding a Standard Product to a Product Version on page 2218
How to add add-on services to a product version	Adding Add-on Services to a Product Version on page 2219
How to associate price list with a product version	Associating a Price List with a Product Version on page 2220
How to define eligibility criteria for a product version	Defining Eligibility Criteria for a Product Version on page 2221

Product Version (Used for Viewing)

Once you define a product version, the **Product Version** screen allows you to:

- Edit the details of a product version.
- Edit the details of a product and its services.
- Edit the price list details.
- Edit the eligibility details.
- Edit the characteristics details.

This screen consists of the following tabs:

- [Product Version - Main](#) on page 2226
- [Product Version - Log](#) on page 2232

For more information on...	See...
How to view the details of a product version	Viewing the Product Details on page 2209
How to add a product version	Defining a Product Version on page 2215
How to edit a product version	Editing a Product Version on page 2232
How to delete a product version	Deleting a Product Version on page 2233
How to copy a product version	Copying a Product Version on page 2234
How to finalize a product version	Finalizing a Product Version on page 2236

For more information on...	See...
How to view the log of a product version	Viewing the Log of a Product Version on page 2237

Product Version - Main

The **Product Version - Main** tab displays information about the product version and services. It contains the following zones:

- [Product Version](#) on page 2226
- [Services](#) on page 2229
- [Add-on Product Services](#) on page 2228
- [Price Items](#) on page 2203
- [Eligibility Criteria](#) on page 2230

Product Version

The **Product Version** zone displays the details of the product version. It contains the following sections:

- **Main** - Displays the basic information about the product version. It contains the following fields:

Field Name	Field Description
Product	Displays information about the product. Note: It has a link. On clicking the link, the Product screen appears where you can view the details of the product.
Effective Date	Displays the date from when the product version will be effective.
Product Type	Displays the type of product for which the product version is created.
Status	Displays the status of the product version.
Description	Displays the description of the product version.
Terms and Conditions	Displays the terms and conditions that are applicable for the product version.

- **Record Actions** - This section contains the following fields:

Button Name	Button Description
Edit	Used to edit the details of the product version. Note: The Edit button appears when the product version status is In Progress, Finalized, and Draft .
Delete	Used to delete the details of the product version. Note: The Delete button appears when the product version status is In Progress, Finalized, and Draft .
Duplicate	Used to create a new version using an existing product version. Note: The Duplicate button appears when the product version status is In Progress, Finalized, and Draft .

Button Name	Button Description
Finalized	Used to finalize all the changes and make the product Active .

- **Record Information** - This section contains the following fields:

Field Name	Field Description
Business Object	Indicates the business object using which the product version is created. In addition, a context menu appears corresponding to this field which helps in navigating to other screens in the application.
	Note: It has a link. On clicking the link, the Business Object screen appears where you can view the details of the respective business object.

- **Characteristics** - Lists the characteristics defined for the product version. It contains the following columns:

Column Name	Column Description
Effective Date	Displays the date from when the product version is effective.
Characteristic Type	Indicates the characteristic type.
Characteristic Value	Displays the value of the characteristic type.

- Enter the required details in the [Products](#) on page 2227 zone.
- Enter the required details in the [Product Services](#) on page 2228 zone.

Note: Products and Product Services section is displayed when the product type is selected as **Packaged** product from the [Search Product](#) on page 2206 zone in the **Product** screen.

- Enter the required details in the [Add-on Product Services](#) on page 2228 zone.
- Enter the required details in the [Services](#) on page 2229 zone.

Note: The services section appear when the product type is selected as a **Standard** product from the [Search Product](#) on page 2206 zone in the **Product** screen.

- Enter the required details in the [Price List](#) on page 2229 zone.
- Enter the required details in the [Eligibility Criteria](#) on page 2230 zone.

Products

The **Products** zone displays the details of the product. It contains the following fields:

Field Name	Field Description
Product	Displays the product service that is assigned to a product.
Effective Date	Displays the date from when the product is effective.
Description	Displays the description of the product

Related Topics

For more information on...	See...
Product Version - Main screen	Product Version - Main on page 2226
How to edit the product version	Editing a Product Version on page 2232

For more information on...	See...
How to delete the product version	Deleting a Product Version on page 2233
How to copy the product version	Copying a Product Version on page 2234
How to finalize a product version	Finalizing a Product Version on page 2236
How to view the log of a product version	Viewing the Log of a Product Version on page 2237

Product Services

The **Product Services** zone displays the services that are assigned to the product. It contains the following columns:

Column Name	Column Description
Service Code	Displays the unique code that is assigned to the product service.
Description	Displays the description of the product.
	Note: It has a link. On clicking the link, the Product Service screen appears where you can view the details of the respective add-on service.
Mandatory	Indicates whether the service is mandatory while defining the product version.
	Note: This field is displayed when the mandatory option is selected while defining or editing the product services.

Related Topics

For more information on...	See...
Product Version - Main screen	Product Version - Main on page 2226
How to edit the product version	Editing a Product Version on page 2232
How to delete the product version	Deleting a Product Version on page 2233
How to copy the product version	Copying a Product Version on page 2234
How to finalize a product version	Finalizing a Product Version on page 2236
How to view the log of a product version	Viewing the Log of a Product on page 2243

Add-on Product Services

The **Add-on Services** zone displays the additional services of the product. It contains the following columns:

Column Name	Column Description
Service Code	Displays the unique code assigned to the product service.
Description	Displays the description of the product.
	Note: It has a link. On clicking the link, the Product Service screen appears with the details of the respective add-on service.
Mandatory	Indicates whether the add-on service is mandatory while defining the product version.

Column Name	Column Description
	Note: This field is displayed when the mandatory option is selected while defining or editing the product services.

Related Topics

For more information on...	See...
Product Version - Main screen	Product Version - Main on page 2226
How to edit the product version	Editing a Product Version on page 2232
How to delete the product version	Deleting a Product Version on page 2233
How to copy the product version	Copying a Product Version on page 2234
How to finalize a product version	Finalizing a Product Version on page 2236
How to view the log of a product version	Viewing the Log of a Product on page 2243

Services

The **Services** zone displays the services that are assigned to the product. It contains the following columns:

Column Name	Column Description
Service Code	Displays the unique code that is assigned to the product service.
Description	Displays the description of the product. Note: It has a link. On clicking the link, the Product Service screen appears with the details of the respective add-on service.
Mandatory	Indicates whether the service is mandatory while defining the product version. Note: This field is displayed when the mandatory option is selected while defining or editing the product services.

Related Topics

For more information on...	See...
Product Version - Main screen	Product Version - Main on page 2226
How to edit the product version	Editing a Product Version on page 2232
How to delete the product version	Deleting a Product Version on page 2233
How to copy the product version	Copying a Product Version on page 2234
How to finalize a product version	Finalizing a Product Version on page 2236
How to view the log of a product version	Viewing the Log of a Product Version on page 2237

Price List

The **Price List** zone displays the price for each service that is covered by the product. It contains the following columns:

Columns Name	Column Description
Serial Number	Displays the auto-generated serial number for the price list information.
Price List Information	Displays the price of each price item that is covered by the product. Note: It has a link. On clicking the link, the Price List screen appears where you can view the details of the respective price item.

Related Topics

For more information on...	See...
Product Version - Main screen	Product Version - Main on page 2226
How to edit the product version	Editing a Product Version on page 2232
How to delete the product version	Deleting a Product Version on page 2233
How to copy the product version	Copying a Product Version on page 2234
How to finalize a product version	Finalizing a Product Version on page 2236
How to view the log of a product version	Viewing the Product Versions on page 2209

Eligibility Criteria

The **Eligibility Criteria** zone displays the list of criteria that decide the enrollment of the product towards an entity. It contains the following columns:

Column Name	Column Description
Eligibility Type	Indicates the eligibility type of the product service. The valid values are: <ul style="list-style-type: none"> Eligibility Rule
Effective Start Date	Displays the date from when the eligibility type is effective.
Effective End Date	Displays the date till when the eligibility type is effective.
Description	Displays the description of the eligibility type.
Sequence	Displays the sequence number.
Parameter	Displays the eligibility condition that is assigned to an entity. Note: The Search (🔍) icon appears corresponding to the Approval Level field. On clicking the search icon, the Approval Level Search search window appears.
Operator	Indicates various types of conditional operators used for eligibility criteria purposes. The valid values are: <ul style="list-style-type: none"> < <= <> = >

Column Name	Column Description
	<ul style="list-style-type: none"> • >= • Between • In • Like • Not In
Parameter Value Type	Indicates the value type of the parameter. The valid values are: <ul style="list-style-type: none"> • Parameter • Value
Parameter	Indicates the actual value that is assigned for an entity.
Parameter Value	Displays the actual value of the parameter that is assigned for an entity.
Is True	Indicates what should happen when the condition is true (satisfied). The valid values are: <ul style="list-style-type: none"> • Check Next Condition - Indicates that the condition with consecutive sequence number should be executed. • Rule Is False - Indicates that the action specified in the Rule False Action field should be executed. • Rule Is True - Indicates that the action specified in the Rule True Action field should be executed.
Is False	Indicates what should happen when the condition is false (not satisfied). The valid values are: <ul style="list-style-type: none"> • Check Next Condition - Indicates that the condition with consecutive sequence number should be executed. • Rule Is False - Indicates that the action specified in the Rule False Action field should be executed. • Rule Is True - Indicates that the action specified in the Rule True Action field should be executed.
Is Insufficient	Indicates what should happen when the data is insufficient. The valid values are: <ul style="list-style-type: none"> • Check Next Condition - Indicates that the condition with consecutive sequence number should be executed. • Rule Is False - Indicates that the action specified in the Rule False Action field should be executed. • Rule Is True - Indicates that the action specified in the Rule True Action field.

Related Topics

For more information on...	See...
Product Version - Main screen	Product Version - Main on page 2226
How to edit the product version	Editing a Product Version on page 2232
How to delete the product version	Deleting a Product Version on page 2233
How to copy the product version	Copying a Product Version on page 2234

For more information on...	See...
How to finalize a product version	Finalizing a Product Version on page 2236
How to view the log of a product version	Viewing the Log of a Product Version on page 2237

Product Version - Log

The **Product Version - Log** tab contains the following zone:

- [Product Version Log](#) on page 2232

Product Version Log

The **Product Version - Log** zone lists the complete trail of actions performed on the product version. It contains the following columns:

Column Name	Column Description
Date Time	Displays the date and time when the action was performed on the product version.
Details	Displays the details about the action performed on the product version.
User	Displays the user who has performed the action on the product version.
Log Type	Displays the type of log.
Related Object	Displays the object or entity that is generated when the action is performed on the product version.
Status Reason	Displays the status reason of action performed on the product version.

Editing a Product Version

Procedure

To edit a product version:

1. Search for the product in the **Search Product** zone.
2. In the **Search Results** section, click the **Broadcast** () icon, corresponding to the product column.
The **Product Version List** zone appears.
3. Click the link in the **Description** column, corresponding to the status column.
The **Product Version** screen appears.
4. Click the **Edit** button in the **Product Version** zone.
The **Product Version** screen appears.

Note: ORMB search engine supports wildcard search, where you can substitute the percentage (%) symbol as a stand in for any word or letter in a search criteria. You can use the '%' wildcard character in all input fields except the date and ID fields. The '%' wildcard character is suffixed automatically at the end of the partial search criteria. Therefore, you may or may not specify the wildcard character at the end of the partial search criteria. However, you have to prefix the wildcard character manually wherever required.

5. Modify the details of the product version in the main section, if required.

Note:

The effective date of a product version cannot be later than the product end date.

- Define, edit, or remove the products and/or services for a product version, if required.

Note:

You must select the Inclusion check box when the product service is defined as mandatory in the effective product version.

- Modify the price list for a product version, if required.
- Define, edit, or remove the eligibility for a product version, if required.
- Define, edit, or remove the characteristics for a product version, if required.
- Click **Save**.

Note:

You cannot edit the details of the product version except the characteristics when the product version is in the Finalized status.

The changes made to the product version are saved.

Related Topics

For more information on...	See...
How to add a product service to a product version	Adding a Product Service to a Product Version on page 2217
How to add a standard product to a product version	Adding a Standard Product to a Product Version on page 2218
How to add add-on services to a product version	Adding Add-on Services to a Product Version on page 2219
How to associate price list with a product version	Associating a Price List with a Product Version on page 2220
How to define eligibility criteria for a product version	Defining Eligibility Criteria for a Product Version on page 2221
How to define a characteristic for a product version	Defining a Characteristic for a Product Version on page 2224

Deleting a Product Version**Procedure**

To delete a product version:

- Search for the product in the **Search Product** zone.

Note: ORMB search engine supports wildcard search, where you can substitute the percentage (%) symbol as a stand in for any word or letter in a search criteria. You can use the '%' wildcard character in all input fields except the date and ID fields. The '%' wildcard character is suffixed automatically at the end of the partial search criteria. Therefore, you may or may not specify the wildcard character at the end of the partial search criteria. However, you have to prefix the wildcard character manually wherever required.

- In the **Search Results** section, click the **Broadcast** () icon, corresponding to the product column.
The **Product Version List** zone appears.
- Click the link in the **Description** column, corresponding to the status column.

The **Product Version** screen appears.

- Click the **Delete** button in the **Product Version** zone.

A message appears confirming whether you want to delete the product version.

- Click **OK**.

Note:

You cannot delete the product version which is in the Finalized status.

The product version is deleted.

Related Topics

For more information on...	See...
How to search for a product	Searching for a Product on page 2208

Copying a Product Version

Instead of creating a product version from scratch, you can create a new product version using an existing product version. This is possible through copying a product version. On copying a product version, the details including the algorithms and characteristics are copied to the new product version. You can then edit the details, if required.

Prerequisites

To copy a product version, you should have:

- Product and Product Type defined in the application.
- Product Status and Service Code defined in the application.
- Product Category, Division, and Product To Do Role defined in the application.
- Eligibility Type, Characteristic Type, Price List, and Terms and Conditions defined in the application.
- Parameter, Operator, Parameter Value Type, Is True, Is False, and Is Sufficient defined in the application.

Procedure

To copy a product version:

- Click the **Menu** link in the **Application** toolbar.
A list appears.
- From the **Menu** list, select **Pricing Management**, and then click **Product**.
The sub-menu appears.
- Click the **Search** option from the **Product** sub-menu.
The **Product** screen appears.
- In the **Search Results** section, click the **Broadcast** () icon corresponding to the product column whose version you want to copy.
The **Product Version List** zone appears.
- Click the link in the **Description** column, to view the details of the product version.
The **Product Version** screen appears.
- Click the **Duplicate** button in the **Record Actions** section.
The **Product Version** screen appears. It contains the following sections:

- **Main** - Used to specify basic details of the product version.
- **Products and Services** - Used to define the products and services for a product version.
- **Price List**
 - Used to define the Price List for the product version.
- **Eligibility**
 - Used to define the Eligibility for the product version.
- **Characteristics**
 - Used to define the Characteristics for the product version.

The **Main** section contains the following fields:

Field Name	Field Description	Mandatory (Yes or No)
Product Type	Displays the product type.	Not applicable
Product	Displays the product code.	Not applicable
Effective Date	Used to specify the effective date from when the product version will be effective.	Yes
Status	Used to specify the status of the version.	Yes
	Note: It is a read-only field, and cannot be edited.	
Description	Used to specify the description for the version.	No
Terms and Conditions	Used to specify the terms and conditions for the version.	Yes
	Note: Click the Search (🔍) icon appearing corresponding to the Terms and Conditions field. On clicking the Search icon, you can search for a predefined terms and conditions.	

7. Enter the required details in the **Products and Services** and/or **Product Services** section.

Note: If the product type is **Packaged** then **Products and Services** section appears. If the product type is **Standard** then **Product Services** section appears. If the product type is **Information Only** neither of these sections are displayed.

8. Enter the required details in the **Price List** section.
9. Enter the required details in the **Eligibility** section.
10. Enter the required details in the **Characteristics** section.
11. Click **Save**.

The new product service is defined.

Related Topics

For more information on...	See...
How to add a product service to a product version	Adding a Product Service to a Product Version on page 2217

For more information on...	See...
How to add a standard product to a product version	Adding a Standard Product to a Product Version on page 2218
How to add add-on services to a product version	Adding Add-on Services to a Product Version on page 2219
How to associate price list with a product version	Associating a Price List with a Product Version on page 2220
How to define eligibility criteria for a product version	Defining Eligibility Criteria for a Product Version on page 2221
How to define a characteristic for a product version	Defining a Characteristic for a Product Version on page 2224

Finalizing a Product Version

Prerequisites

To finalize a product version, you should have:

- Product Version status as In Progress

Procedure

To finalize a product version:

1. Search for the product in the **Product Search** screen.
2. In the **Search Results** section, click the **Broadcast** () icon corresponding to the product whose details you want to view.
The **Product Version List** screen appears.
3. In the **Product Version List** zone, click the link in the **Description** column, for that product version, whose product version log you want to view.
The **Product Version** screen appears.
4. Click the **Finalize** button in the **Product Version** zone.
The status of the product version is changed to **Finalized**.

Note:

You cannot finalize the product version when its effective date is earlier than the product start date.

Note:

The **Finalize** button appears when the product version is in the **In Progress** status.

Related Topics

For more information on...	See...
How to search for a product	Searching for a Product on page 2208
How to define a product version	Defining a Product Version on page 2215
How to copy a product version	Copying a Product Version on page 2234
How to delete a product version	Deleting a Product Version

Viewing the Log of a Product Version

Procedure

To view the log of a Product Version:

1. Search for the product in the **Product** screen.
2. In the **Search Results** section, click the **Broadcast** () icon corresponding to the product, whose product version log you want to view.

The **Product Version List** screen appears.

3. In the **Product Version List** zone, click the link in the **Description** column, for that product version, whose product version log you want to view.

The **Product Version** screen appears. It consists of the following tabs:

- [Product Version - Main](#) on page 2226
- [Product Version - Log](#) on page 2232

4. Click the **Log** tab.

The **Log** tab appears.

5. View the complete trail of actions performed on the product version in the **Product Version Log** zone.

Related Topics

For more information on...	See...
Product Version Log screen	Product Version - Log on page 2232
Product Version Log zone	Product Version Log on page 2232

Product (Used for Viewing)

The **Product** screen allows you to:

- View the details of the product
- View the division of the product
- View the product to product relationship
- View the characteristics of the product
- View the product version list of the product
- Edit the details of the product
- Retire a product
- Add a product version to the product

This screen contains the following tabs:

- [Product - Main](#) on page 2238
- [Product - Log](#) on page 2240

For more information on...	See...
How to edit the details of product	Editing a Product on page 2240

For more information on...	See...
How to create a copy of the product	Copying a Product on page 2241
How to retire a product	Retiring a Product on page 2243
How to define a product	Defining a Product on page 2210
How to define a product version	Defining a Product Version on page 2215

Product - Main

The **Product - Main** tab displays information about the product, division, product to product relationship, characteristics, and product version. It contains the following zones:

- [Product Details](#) on page 2238
- [Product Version List](#) on page 2208

Product Details

The **Product Details** zone displays the details of the product. It contains the following sections:

- **Main** - Displays the basic information about the product. It contains the following fields:

Field Name	Field Description
Product	Displays information about the product. Note: It has a link. On clicking the link, the Product screen appears where you can view the details of the product.
Description	Displays the description of the product version.
Status	Displays the status of the product version.
Product Type	Displays the type of product for which the product version is created.
Product Category	Displays the category to which the product is associated.
Start Date	Displays the date from when the product is effective.
End Date	Displays the date from till when the product is effective.
Compliance Number	Displays the number supplied by the legal department
Product Manager To Do Role	Displays all the To Dos that are raised against this product, and are assigned to this particular To Do Role.

- **Record Actions** - This section contains the following fields:

Button Name	Button Description
Edit	Used to edit the details of the product. Note: The Edit button appears when the product status is Active and Draft .
Duplicate	Used to create a new product using an existing product. Note: The Duplicate button appears when the product status is Active and Draft .

Button Name	Button Description
Retire	Used to indicate that the product is no longer available for use.
	Note: The Retire button appears only when the product status is Active .
Active	Used to activate the product.
	Note: The Active button appears when the product status is Draft .

- **Record Information** - This section contains the following fields:

Field Name	Field Description
Business Object	Indicates the business object using which the product version is created. In addition, a context menu appears corresponding to this field which helps in navigating to other screens in the application.
	Note: It has a link. On clicking the link, the Business Object screen appears where you can view the details of the respective business object.

- **Divisions** - Displays the division defined for the product. It contains the following columns:

Column Name	Column Description
Division	Displays the division to which the product belongs.
	Note: It has a link. On clicking the link, the Division screen appears where you can view the details of the division.

- **Product to Product Relationship** - Lists the characteristics of the product version. It contains the following columns:

Column Name	Column Description
Product	Displays the product with whom the relationship has to be made.
Relationship Type	Displays the type of relationship.
Effective Start Date	Displays the date from when the product to product relationship will be effective.
Effective End Date	Displays the date till when the product to product relationship will be effective.

- **Characteristics** - Lists the characteristics defined for the product version. It contains the following columns:

Column Name	Column Description
Effective Date	Displays the date from when the characteristics for the product will be effective.
Characteristic Type	Displays the characteristic type.
Characteristic Value	Displays the characteristic value.

Product Version List

The **Product Version List** zone lists the information related to the product version.

Column Name	Column Description
Effective Date	Displays the date from when the product version is effective.

Column Name	Column Description
Description	Displays the description of the product version.
	Note: It has a link. On clicking the link, the Product Version screen appears where you can view the details of the respective product version.
Status	Displays the status of the product version.

Related Topics

For more information on...	See...
How to search for a product	Searching for a Product on page 2208
How to view the details of a product	Viewing the Product Details on page 2209
How to view the versions of a product	Viewing the Product Versions on page 2209

Product - Log

The **Product - Log** tab contains the following zone:

- [Product Log](#) on page 2240

Product Log

The **Product Log** zone lists the complete trail of actions performed on the product. It contains the following columns:

Column Name	Column Description
Date/Time	Displays the date and time when the action was performed on the product.
Details	Displays the details about the action performed on the product.
User	Displays the user who has performed the action on the product.
Log Type	Displays the type of log.
Related Object	Displays the object or entity that is generated when the action is performed on the product.
Status Reason	Displays the status reason of action performed on the product.

Editing a Product

Procedure

To edit a product:

1. Search for the product in the **Search Product** zone.
2. In the **Search Results** section, click the link in the **Description** column, corresponding to the product column whose details you want to edit.

The **Product** screen appears.

Note: ORMB search engine supports wildcard search, where you can substitute the percentage (%) symbol as a stand in for any word or letter in a search criteria. You can use the ‘%’ wildcard character in all input fields except the date and ID fields. The ‘%’ wildcard character is suffixed automatically at the end of the partial search criteria. Therefore, you may or may not specify the wildcard character at the end of the partial search criteria. However, you have to prefix the wildcard character manually wherever required.

- Click the **Edit** button in the **Record Actions** zone.

The **Product** screen appears.

- Modify the details of the product in the main section, if required.

Note:

The product start date cannot be later than its product version's effective date.

The product end date cannot be earlier than its product version's effective date.

You cannot update the product type field because a product version is already defined for the product.

You cannot add or edit a product version when the product is in the Retired status.

- Define, edit, or remove the divisions for a product, if required.

Note:

You cannot remove the division from the product because an account from this division is already enrolled to the product.

You cannot remove the division from the packaged product because the child product is associated to the division.

- Define, edit, or remove the product to product relationship for a product, if required.

- Define, edit, or remove the characteristics for a product, if required.

Note:

You cannot change the value of the characteristic when the product is in the Active status. To change the value of the characteristic, the characteristic type should not be of **C1-STOPE** type.

- Click **Save**.

The changes made to the product are saved.

Related Topics

For more information on...	See...
How to define the characteristics for the product	Defining a Characteristics for a Product on page 2213
How to define product to product relationship	Defining a Product to Product Relationship on page 2212
How to associate the product with a division	Associating a Product with a Division on page 2211

Copying a Product

Instead of creating a product from scratch, you can create a new product using an existing product. This is possible through copying a product. On copying a product, the details including the algorithms and characteristics are copied to the new product. You can then edit the details, if required.

Prerequisites

To copy a product, you should have:

- Product, Product Type, Product Category, and Product Manager's To Do Role defined in the application.
- Division defined in the application.

- Relationship Type and Characteristic Type defined in the application.

Procedure

To copy a product:

1. Search for a product in the **Product** screen.
2. In the **Search Results** section, click the link in the **Description** column, corresponding to the product column, whose details you want to copy.

The **Product** screen appears.

3. Click the **Duplicate** button in the **Record Actions** section.

The **Product** screen appears.

4. Enter the required product details in the **Main** section, if required.
5. Define, edit, or remove the divisions for a product, if required.
6. Define, edit, or remove the product to product relationship for a product, if required.
7. Define, edit, or remove the characteristics for a product, if required.
8. Click **Save**.

The new product is defined.

Related Topics

For more information on...	See...
How to define a product	Defining a Product on page 2210
Associating a product with a division	Associating a Product with a Division on page 2211
How to define product to product relationship	Defining a Product to Product Relationship on page 2212
How to define a characteristic for a product	Defining a Characteristics for a Product on page 2213

Activating a Product

Prerequisites

To activate a product, you should have:

- Product must have the status as Draft.
- Product Version Status should be Finalized.

Procedure

To activate a product:

1. Search for a product in the **Product** screen.
2. In the **Search Results** section, click the link in the **Description** column, corresponding to the product column that needs to be activated.

The **Product** screen appears.

3. Click the **Active** button in the **Record Actions** section.

Note:

You can activate a product when there is at least one product version in the Finalized status.

The product is activated, as the status is changed from **Draft** to **Active**.

Related Topics

For more information on...	See...
How to edit the product details	Editing a Product on page 2240
How to create a copy of a product	Copying a Product on page 2241
How to retire a product	Retiring a Product on page 2243

Retiring a Product**Prerequisites**

To retire a product, you should have:

- Product Status must be Active.
- Product End Date less than equal to current date.

Procedure

To retire a product:

1. Search for a product in the **Product** screen.
2. In the **Search Results** section, click the link in the **Description** column, corresponding to the product column that needs to be activated.

The **Product** screen appears.

3. Click the **Retire** button in the **Record Actions** section.

The **Retire Product** screen appears.

4. Mention the **End Date** of the product.

Note:

The enrollments for the product, which you are retiring, are still effective.

5. Click **Save**.

The product is retired, as the status is changed from **Active** to **Retired**.

Note:

On retiring the product, the end date of the effective product enrollments is set to the system date.

Related Topics

For more information on...	See...
How to edit the product details	Editing a Product on page 2240
How to create a copy of a product	Copying a Product on page 2241

Viewing the Log of a Product

Procedure

To view the log of a Product:

1. Search for the product in the **Product** screen.
2. In the **Search Results** section, click the link in the **Description** column corresponding to the product, whose log you want to view.

The **Product** screen appears. It consists of the following tabs:

- [Product - Main](#) on page 2238
- [Product - Log](#) on page 2240

3. Click the **Log** tab.

The **Log** tab appears.

4. View the complete trail of actions performed on the product version in the **Product Log** zone.

Related Topics

For more information on...	See...
Product Log screen	Product - Log on page 2240
Product Log zone	Product Log on page 2240

Product Enrollment (Used for Searching)

The **Product Enrollment** screen allows you to search for a product enrollment using various search criteria. Through this screen, you can navigate to the following screen:

- [Product Enrollment \(Used for Viewing\)](#) on page 2255

This screen consists of the following zone:

- [Enrolled Products](#) on page 2246
- [Enrolled Standard Products](#) on page 2247
- [Enrolled Services](#) on page 2247
- [Enrolled Add-on Services](#) on page 2248

For more information on...	See...
How to search for a enrolled product	Searching for a Product Enrollment on page 2248
How to view the enrolled products	Viewing the Enrolled Products on page 2249
How to view the enrolled services	Viewing the Enrolled Services on page 2249

Search Enrollment

The **Search Enrollment** zone allows you to search for the enrolled products using various search criteria. It contains the following sections:

- **Search Criteria** - The **Search Criteria** section contains the following fields:

Field Name	Field Description	Mandatory (Yes or No)
Search By	Used to indicate whether you want to search for an enrolled product using the option of Product Enrollment. The valid values are: <ul style="list-style-type: none"> Product Enrollment 	Yes
	Note: By default, the Product Enrollment option is selected.	
Enrollment ID	Used to search an enrollment, based on the enrollment ID.	No
Account ID	Used to search an enrollment, based on the account ID.	No
Person ID	Used to search an enrollment, based on the person ID.	No
Product	Used to search an enrollment, based on the product ID.	No
Status	Used to search an enrollment with a particular status. The valid values are: <ul style="list-style-type: none"> Canceled Enrolled Error Pending Unenrolled Validated 	No
Start Date	Used to search enrollments which are initiated from a specific date.	No
Enrollment Channel	Used to search enrollments based on a enrollment source. The valid values are: <ul style="list-style-type: none"> Oracle Revenue Management and Billing 	No
End Date	Used to search enrollments which are initiated till a specific date.	No

Note: You must specify at least one search criterion while searching for an enrollment.

- **Search Results** - On clicking the **Search** button, the search results are filtered based on the specified search criteria. The **Search Results** section contains the following columns:

Column Name	Column Description
Enrollment ID	Displays the enrollment ID of the enrolled product.
	Note: It has a link. On clicking the link, the Product Enrollment screen appears where you can view the details of the respective enrolled product.
Account Information	Displays the account ID of the enrolled product.
	Note: It has a link. On clicking the link, the Account screen appears where you can view the details of the respective account.
Start Date	Displays the date from when the enrolled product is effective.

Column Name	Column Description
End Date	Displays the date till when the enrolled product is effective.

On clicking the **Broadcast** () icon corresponding to an enrollment ID, the **Enrolled Products** zone appears with the details of the products that are enrolled.

- **Enrolled Products** - The **Enrolled Products** section contains the following columns:

Column Name	Column Description
Product Type	Displays the type of product which is enrolled.
Product	Displays the name of the enrolled product.
Version Description	Displays the description of the enrolled product version. Note: It has a link. On clicking the link, the Product Version screen appears where you can view the details of the respective enrolled product.
Start Date	Displays the date from when the enrolled product is effective.
End Date	Displays the date till when the enrolled product is effective.

- **Enrolled Services** - The **Enrolled Services** section contains the following columns:

Column Name	Column Description
Service Code	Displays the type of service which is enrolled.
Description	Displays the description of the enrolled service. Note: It has a link. On clicking the link, the Product Service screen appears where you can view the details of the respective enrolled service.
Start Date	Displays the date from when the enrolled service is effective.
End Date	Displays the date till when the enrolled service is effective.

Related Topics

For more information on...	See...
How to view the product version details	Viewing the Product Version Details on page 2210
How to view the product service details	Viewing the Product Service Details on page 2201

Enrolled Products

The **Enrolled Products** zone displays the products that have been enrolled. It contains the following columns:

Columns Name	Column Description
Product Type	Displays the type of the product.
Product	Displays the name of the product.
Price List Information	Displays the description of the product.

Columns Name	Column Description
	Note: It has a link. On clicking the link, the Product Version screen appears where you can view the details of the respective product.
Start Date	Displays the date from when the enrollment is effective.
End Date	Displays the date till when the enrollment is effective.

Related Topics

For more information on...	See...
How to view the enrolled products	Viewing the Enrolled Products on page 2249
How to view the enrolled services	Viewing the Enrolled Services on page 2249
How to define a characteristic for product enrollment	Defining a Characteristic for a Product Enrollment on page 2255

Enrolled Services

The **Enrolled Services** zone displays the services that have been enrolled. It contains the following columns:

Columns Name	Column Description
Service Code	Displays the code of the enrolled service.
Description	Displays the description of the enrolled service. Note: It has a link. On clicking the link, the Product Service screen appears where you can view the details of the respective product.
Start Date	Displays the date from when the service enrollment is effective.
End Date	Displays the date till when the service enrollment is effective.

Related Topics

For more information on...	See...
How to view the enrolled products	Viewing the Enrolled Products on page 2249
How to view the enrolled services	Viewing the Enrolled Services on page 2249
How to define a characteristic for product enrollment	Defining a Characteristic for a Product Enrollment on page 2255
How to enroll an account for one for more products & services	Enrolling an Account for One or More Products and Services on page 2251
How to view the product priority of an account	Viewing the Product Priority of an Account on page 2254

Enrolled Standard Products

The **Enrolled Standard Products** zone displays the standard products that have been enrolled. It contains the following columns:

Columns Name	Column Description
Product	Displays the name of the enrolled product.

Columns Name	Column Description
Version Description	Displays the description of the enrolled service.
	Note: It has a link. On clicking the link, the Product Version screen appears with the version details of the respective product.
Start Date	Displays the date from when the enrolled technical product is effective.
End Date	Displays the date till when the enrolled technical product is effective.

Related Topics

For more information on...	See...
How to view the enrolled products	Viewing the Enrolled Products on page 2249
How to view the enrolled services	Viewing the Enrolled Services on page 2249
How to enroll an account for one or more products and services	Enrolling an Account for One or More Products and Services on page 2251

Enrolled Add-on Services

The **Enrolled Add-on Services** zone displays the standard products that have been enrolled. It contains the following columns:

Columns Name	Column Description
Service Code	Displays the code of the enrolled service.
Description	Displays the description of the enrolled service.
	Note: It has a link. On clicking the link, the Product Version screen appears with the version details of the respective product.
Start Date	Displays the date from when the enrolled add-on service is effective.
End Date	Displays the date till when the enrolled add-on service is effective.

Related Topics

For more information on...	See...
How to view the enrolled products	Viewing the Enrolled Products on page 2249
How to view the enrolled services	Viewing the Enrolled Services on page 2249
How to define a characteristic for product enrollment	Defining a Characteristic for a Product Enrollment on page 2255
How to enroll an account for one or more products and services	Enrolling an Account for One or More Products and Services on page 2251

Searching for a Product Enrollment

Prerequisite

To search for a product enrollment, you should have:

- Enrollment Details defined in the application.

- Account ID and Person ID defined in the application.
- Product and Status defined in the application.
- Enrollment defined in the application.

Procedure

To search for a product enrollment:

1. From the **Main** menu, select **Pricing Management** and then click **Product Enrollment**.
A sub-menu appears.
2. Click the **Search** option from the **Product Enrollment** sub-menu.
The **Product Enrollment** screen appears.
3. Enter the search criteria in the *Search Enrollment* on page 2244 zone.

Note: ORMB search engine supports wildcard search, where you can substitute the percentage (%) symbol as a stand in for any word or letter in a search criteria. You can use the ‘%’ wildcard character in all input fields except the date and ID fields. The ‘%’ wildcard character is suffixed automatically at the end of the partial search criteria. Therefore, you may or may not specify the wildcard character at the end of the partial search criteria. However, you have to prefix the wildcard character manually wherever required.

4. Click **Search**.

A list of enrolled products that meet the search criteria appear in the **Search Results** section.

Note: If you have specified any other search criterion other than the product enrollment ID, the system generates a message saying that the product enrollment ID is invalid.

Related Topics

For more information on...	See...
Search Enrollment screen	<i>Product Enrollment (Used for Searching)</i> on page 2244
Search Enrollment zone	<i>Search Enrollment</i> on page 2244

Viewing the Enrolled Products

Procedure

To view the enrolled products:

1. Search for an enrolled product in the **Product Enrollment** screen.
2. In the **Search Results** section, click the **Broadcast** (📡) icon corresponding to the enrollment ID whose enrolled products you want to view.
The **Enrolled Products** zone appears.
3. View the list of enrolled products in the **Enrolled Products** screen.

Related Topics

For more information on...	See...
Enrolled Products zone	<i>Enrolled Products</i> on page 2246
How to search for enrolled products	<i>Searching for a Product Enrollment</i> on page 2248

Viewing the Enrolled Services

Procedure

To view the enrolled services:

1. Search for an enrolled product in the **Product** screen.
2. In the **Search Results** section, click the **Broadcast** () icon corresponding to the enrollment ID whose enrolled products you want to view.

The **Enrolled Products** zone appears.

3. In the **Enrolled Products** zone, click the **Broadcast** () icon corresponding to the product type whose services you want to view.

The **Enrolled Services** zone appears.

Note: In case the product type is **Standard** and the **Broadcast** () icon is clicked from the **Enrolled Products** zone, the **Enrolled Services** zone appears.

Note: In case the product type is **Packaged** and **Broadcast** () icon is clicked from the **Enrolled Products** zone, and if there are services enrolled within the packaged product, the **Enrolled Services** zone appears.

4. View the list of enrolled products in the **Enrolled Services** screen.

Related Topics

For more information on...	See...
Enrolled Services zone	Enrolled Services on page 2247
How to search for enrolled products	Searching for a Product Enrollment on page 2248

Viewing the Standard Products Included in an Enrolled Product**Procedure**

To view the standard product included in an enrolled product:

1. Search for an enrolled product in the **Product** screen.
2. In the **Search Results** section, click the **Broadcast** () icon corresponding to the enrollment ID whose enrolled products you want to view.

The **Enrolled Products** zone appears.

3. Click the **Broadcast** () icon corresponding to the product type, whose enrolled standard products you want to view.

The **Enrolled Standard Products** zone appears.

4. View the list of the standard products that are enrolled in the **Enrolled Standard Products** screen.

Note: The Enrolled Standard Products zone appears only when the product is of **Business** type, displayed in the **Enrolled Products** zone.



Related Topics

For more information on...	See...
Enrolled Standard Products zone	Enrolled Standard Products on page 2247
How to search for enrolled products	Searching for a Product Enrollment on page 2248

Viewing the Add-on Services Enrolled with the Product

Procedure

To view the add-on services enrolled with the product:

1. Search for an enrolled product in the **Product** screen.
2. In the **Search Results** section, click the **Broadcast** () icon corresponding to the enrollment ID whose enrolled products you want to view.
The **Enrolled Products** zone appears.
3. Click the **Broadcast** () icon corresponding to the product type, whose enrolled add-on services products you want to view.
The **Enrolled Add-on Services** zone appears.
4. View the list of the add-on services that are enrolled in the **Enrolled Add-on Services** screen.

Related Topics

For more information on...	See...
Enrolled Add-on Services Products zone	Enrolled Add-on Services on page 2248
How to search for enrolled products	Searching for a Product Enrollment on page 2248

Enrolling an Account for One or More Products and Services

Prerequisites

To enroll an account for one or more products and services, you should have:

- Account Information defined in the application.
- Enrollment Channel defined in the application.
- Product defined in the application.
- Characteristic Type defined in the application.

Procedure

To enroll an account for one or more products and services:

1. Click the **Menu** link in the **Application** toolbar.
A list appears.
2. From the **Menu** list, select **Pricing Management**, and then click **Product Enrollment**.
The sub-menu appears.
3. Click the **Add** option from the **Product Enrollment** sub-menu.

The **Product Enrollment** screen appears. It contains the following sections:

- **Main** - Used to specify basic details of the account for product enrollment. It contains the following fields:

Field Name	Field Description	Mandatory (Yes or No)
Enrollment ID	Used to specify the enrollment ID once the product is defined for an enrollment.	Yes

Field Name	Field Description	Mandatory (Yes or No)
	Note: Enrollment ID is displayed when the product is added for enrollment.	
Account ID	Used to specify the account ID. Note: You can search for an account by clicking the Search (🔍) icon corresponding to the Account Information field.	Yes
Status	Displays the status of the product. Note: The product enrollment will always have the status as Pending .	No
Start Date	Used to specify the date from when the product enrollment is effective.	Yes
End Date	Used to specify the date till when the product enrollment is effective.	Yes
Enrollment Channel	Used to specify the source for product enrollment.	Yes
Comments	Used to specify the comments for product enrollment.	No

- **Product and Services** - Used to define products and services for a product. It contains the following fields:

Field Name	Field Description	Mandatory (Yes or No)
Product	Used to specify the product for enrollment. Note: You can search for a product by clicking the Search (🔍) icon corresponding to the Product field.	No
Start Date	Used to specify the date from when the product is effective.	No
End Date	Used to specify the date till when the product is effective.	No
Inclusion	Used to indicate whether the product is used for enrollment.	No
Standard Product	Displays the standard product which is included within the main product.	No
Start Date	Used to specify the date from when the standard product is effective.	No
End Date	Used to specify the date till when the standard product is effective.	No
Inclusion	Used to indicate whether the standard product is used for enrollment.	No
Services	Displays the service that is a part of the standard product.	No
Start Date	Used to specify the date from when the service is effective.	No
End Date	Used to specify the date till when the service is effective.	No
Inclusion	Used to indicate whether the service is used for enrollment.	No

Field Name	Field Description	Mandatory (Yes or No)
	Note: The inclusion check-box is already checked, if the service has been marked as Mandatory in the Product Version zone.	
Add on Services	Displays the add-on service which is a part of the packaged product.	No
Start Date	Used to specify the date from when the add-on service is effective.	No
End Date	Used to specify the date till when the add-on service is effective.	No
Inclusion	Used to indicate whether the add-on service is used for enrollment.	No

- **Product Priority** - Used to define the product priority for product enrollment.

Field Name	Field Description	Mandatory (Yes or No)
Enrollment ID	Displays the enrollment ID.	No
Packaged Products	Displays the packaged product which is added for enrollment.	No
Standard Products	Displays the standard product which is added for enrollment.	No
Product Enrolled Start Date	Displays the date from when the product's enrolled date is effective.	No
Product Enrolled End Date	Displays the date till when the product's enrolled date is effective.	No
Priority	Displays the priority of the product in terms of enrollment.	No

- **Characteristics** - Used to define the characteristics for a product enrollment.

Field Name	Field Description	Mandatory (Yes or No)
Effective Date	Used to specify the date from when the characteristic will be effective.	No
Characteristics Type	Used to indicate the characteristic type for a characteristic.	No
Characteristics Value	Used to indicate the characteristic value.	No

4. Enter the required details in the **Main** section.

Note:

The Start Date field is mandatory.

5. Enter the required details in the **Product and Services** section.

Note:

At least one product service must be added in the product version.

6. Enter the required details in the **Product Priority** section.

Note:

Ensure that priority for the product is specified.

7. Enter the required details in the **Characteristics** section.
8. Click **Save**.

Note:

You cannot enroll for a product where none of its product versions are effective within the enrollment date range.

You cannot enroll for a product where the product start date is later than the enrollment start date.

The enrollment start and end dates should be within the start and end dates of the product.

At least one product must be selected while enrolling products for an account.

At least one price item associated with the product service must be effective during enrollment.

The account is added for enrollment.

Related Topics

For more information on...	See...
How to enroll an account for one or more products and services	Enrolling an Account for One or More Products and Services on page 2251
How to view the product priority of an account	Viewing the Product Priority of an Account on page 2254
How to define the characteristics for a product enrollment	Defining a Characteristic for a Product Enrollment on page 2255

Viewing the Product Priority of an Account**Procedure**

To view the product priority of an account:

1. Search for a product enrollment in the **Product Enrollment** screen.
2. In the **Search Results** section, click the link in the **Enrollment ID** column whose details you want to view.

The **Product Enrollment** screen appears. It contains the following zones:

- [Product Enrollment](#) on page 2256
- [Enrolled Products](#) on page 2257

3. View the product priority details in the [Product Priority](#) on page 2260 zone.

Related Topics

For more information on...	See...
How to edit a product enrollment	Editing a Product Enrollment on page 2261

For more information on...	See...
How to copy a product enrollment	Copying a Product Enrollment on page 2262
How to unenroll a product enrollment	Unenrolling a Product Enrollment on page 2263

Defining a Characteristic for a Product Enrollment

Procedure

To define a characteristic for a product enrollment:

1. Search for an enrollment in the **Search Enrollment** zone.
2. Click the **Add** button in the **Page Title** area of **Product Enrollment** zone.
The **Product Enrollment** screen appears.
3. Click the **Characteristic** link from the **Section** group, located in the left-most area of the screen.
The **Characteristics** section appears. It contains the following fields:

Field Name	Field Description	Mandatory (Yes or No)
Effective Date	Used to specify the date from when the characteristic will be effective for enrollment.	No
Characteristics Type	Used to indicate the characteristic type for a characteristic.	No
Characteristics Value	Used to indicate the characteristic value.	No

4. Enter the required details in the **Characteristics** section.
5. If you want to add more than one characteristic to the product enrollment, click the **Add (+)** icon.
However, if you want to remove a characteristic from the enrollment, click the **Delete (🗑)** icon corresponding to the effective date field.
6. Click **Save**.
The characteristics are defined for the product enrollment.

Related Topics

For more information on...	See...
How to enroll an account for one or more products and services	Enrolling an Account for One or More Products and Services on page 2251
How to view the product priority of an account	Viewing the Product Priority of an Account on page 2254
How to define the characteristics for a product enrollment	Defining a Characteristic for a Product Enrollment on page 2255

Product Enrollment (Used for Viewing)

The **Product Enrollment** screen allows you to:

- View the details and characteristics of the enrollment

- Edit and delete the details of the enrollment
- Create a copy of the enrollment
- Submit the product for enrollment
- Unenroll the product from enrollment

This screen contains the following tabs:

- [Product Enrollment - Main](#) on page 2256
- [Product Enrollment - Log](#) on page 2260

For more information on...	See...
How to view the standard products included in an enrolled product	Viewing the Standard Products Included in an Enrolled Product on page 2250
How to edit the details of product enrollment	Editing a Product Enrollment on page 2261
How to unenroll a product enrollment	Unenrolling a Product Enrollment on page 2263
How to copy a product enrollment	Copying a Product Enrollment on page 2262

Product Enrollment - Main

The **Product Enrollment - Main** tab displays information about the product enrollment, services, and its priority. It contains the following zones:

- [Product Enrollment](#) on page 2256
- [Enrolled Products](#) on page 2257
- [Enrolled Services](#) on page 2258
- [Enrolled Standard Products](#) on page 2258
- [Enrolled Add-on Services](#) on page 2248
- [Product Priority](#) on page 2260

Product Enrollment

The **Product Enrollment** zone displays the details of the enrollment. It contains the following sections:

- **Main** - Displays the basic information about the enrollment. It contains the following fields:

Field Name	Field Description
Enrollment ID	Displays the enrollment ID.
Account Information	Displays information about the account. In addition, this column has a context menu () which helps in navigating to other screens in the application.
Status	Displays the status of the enrollment.
Start Date	Displays the date from when product enrollment is effective.
End Date	Displays the date till when product enrollment is effective.
Enrollment Channel	Indicates the channel which is used for product enrollment.
Comments	Displays the comments that are added for product enrollment.

- **Record Actions** - This section contains the following fields:

Button Name	Button Description
Edit	Used to edit the details of the product enrollment.
	Note: The Edit button appears when the product enrollment status is Enrolled , Cancelled , and Pending status.
Duplicate	Used to create a new product enrollment using an existing enrollment.
	Note: The Duplicate button appears when the product enrollment status is Enrolled , Cancelled , Pending , and Unenrolled .
Delete	Used to delete a product enrollment.
	Note: The Delete button appears when the product enrollment status is Canceled .
Unenroll	Used to unenroll already conducted product enrollment.
	Note: The Unenroll button appears when the product enrollment status is Enrolled .
Submit	Used to submit the product for an enrollment.
	Note: The Submit button appears when the product enrollment status is Pending .

- **Record Information** - This section contains the following fields:

Field Name	Field Description
Business Object	Indicates the business object using which the product enrollment is created. In addition, a context menu appears corresponding to this field which helps in navigating to other screens in the application.
	Note: It has a link. On clicking the link, the Business Object screen appears where you can view the details of the respective business object.

- **Characteristics** - Lists the characteristics defined for the product version. It contains the following columns:

Column Name	Column Description
Effective Date	Displays the date from when the characteristics are effective for product enrollment.
Characteristic Type	Displays the characteristic type.
Characteristic Value	Displays the characteristic value.

Enrolled Products

The **Enrolled Products** zone displays the products that have been enrolled. It contains the following columns:

Columns Name	Column Description
Product Type	Displays the type of the product.
Product	Displays the name of the product.
Version Description	Displays the description of the enrolled product version.

Columns Name	Column Description
	Note: It has a link. On clicking the link, the Product Version screen appears where you can view the details of the respective product version.
Start Date	Displays the date from when the enrollment is effective.
End Date	Displays the date till when the enrollment is effective.

Note: By default, the **Enrolled Services** zone does not appear. It appears when the product type is **Standard** and you click the **Broadcast** (📶) icon corresponding to the product type column.

Related Topics

For more information on...	See...
How to view the enrolled products	Viewing the Enrolled Products on page 2249
How to view the enrolled services	Viewing the Enrolled Services on page 2249

Enrolled Services

The **Enrolled Services** zone displays the services that have been enrolled. It contains the following columns:

Columns Name	Column Description
Service Code	Displays the code of the enrolled service.
Description	Displays the description of the enrolled service. Note: It has a link. On clicking the link, the Product Service screen appears where you can view the details of the respective product.
Start Date	Displays the date from when the service enrollment is effective.
End Date	Displays the date till when the service enrollment is effective.

Related Topics

For more information on...	See...
How to edit the details of product enrollment	Editing a Product Enrollment on page 2261
How to create a copy of product enrollment	Copying a Product Enrollment on page 2262
How to unenroll a product enrollment	Unenrolling a Product Enrollment on page 2263

Enrolled Standard Products

The **Enrolled Standard Products** zone displays the standard products that have been enrolled. It contains the following columns:

Columns Name	Column Description
Product	Displays the name of the enrolled product.
Version Description	Displays the version description of the enrolled service.

Columns Name	Column Description
	Note: It has a link. On clicking the link, the Product Version screen appears with the version details of the respective product.
Start Date	Displays the date from when the enrolled standard product is effective.
End Date	Displays the date till when the enrolled standard product is effective.

Note: By default, the **Enrolled Standard Products** zone does not appear. It appears when the product type is **Packaged**, and the **Broadcast** (📡) icon is clicked, corresponding to the product type column.

Related Topics

For more information on...	See...
How to view the enrolled products	Viewing the Enrolled Products on page 2249
How to view the enrolled product services	Viewing the Enrolled Services on page 2249
How to view the product priority for enrollment	Viewing the Product Priority of an Account on page 2254
How to enroll an account for one or more product services	Enrolling an Account for One or More Products and Services on page 2251

Enrolled Add-on Product Services

The **Enrolled Add-on Product Services** zone displays the standard products that have been enrolled. It contains the following columns:

Columns Name	Column Description
Product Service	Displays the add-on product enrolled service.
Description	Displays the description of the add-on product enrolled service. Note: It has a link. On clicking the link, the Product Service screen appears with the service details of the respective product.
Start Date	Displays the date from when the enrolled add-on product service is effective.
End Date	Displays the date till when the enrolled add-on product service is effective.

Note: By default, the **Enrolled Add-on Product Services** zone does not appear. It appears when the product type is **Packaged**, and the **Broadcast** (📡) icon is clicked, corresponding to the product type column.

Related Topics

For more information on...	See...
How to view the enrolled products	Viewing the Enrolled Products on page 2249
How to view the enrolled product services	Viewing the Enrolled Services on page 2249
How to view the product priority of an account	Viewing the Product Priority of an Account on page 2254

For more information on...	See...
How to enroll an account for one or more product services	Enrolling an Account for One or More Products and Services on page 2251
How to copy a product enrollment	Copying a Product Enrollment on page 2262

Product Priority

The **Product Priority** zone displays the products that have been assigned a priority for enrollment. It contains the following columns:

Columns Name	Column Description
Product Type	Displays the add-on product enrolled service.
Priority	Displays the priority assigned to the product in terms of enrollment.
Product	Displays the product that has an enrollment priority. Note: It has a link. On clicking the link, the Product screen appears with the product details of the respective product.
Start Date	Displays the date from when the product priority is effective.
End Date	Displays the date till when the product priority is effective.

Related Topics

For more information on...	See...
How to view the enrolled products	Viewing the Enrolled Products on page 2249
How to view the enrolled product services	Viewing the Enrolled Services on page 2249
How to view the product priority of an account	Viewing the Product Priority of an Account on page 2254
How to enroll an account for one or more product services	Enrolling an Account for One or More Products and Services on page 2251
How to copy a product enrollment	Copying a Product Enrollment on page 2262

Product Enrollment - Log

The **Product Enrollment - Log** tab contains the following zone:

- [Enrollment Log](#) on page 2260

Enrollment Log

The **Enrollment Log** zone lists the complete trail of actions performed in the product enrollment. It contains the following columns:

Column Name	Column Description
Creation Date Time	Displays the date and time when the action was performed in the product enrollment.
Details	Displays the details about the action performed in the product enrollment.
User	Displays the user who has performed the action in the product enrollment.

Column Name	Column Description
Log Type	Displays the type of log.
Related Object	Displays the object or entity that is generated when the action is performed in the product enrollment.
Status Reason	Displays the status reason of action performed in the product enrollment.

Viewing the Standard Products Included in an Enrolled Product

Procedure

To view the standard product included in an enrolled product:

1. Search for an enrolled product in the **Product** screen.
2. In the **Search Results** section, click the link in the **Enrollment ID** column whose details you want to view.

The **Product Enrollment** screen appears.

Note: To view the standard products that are included in an enrolled product, the product must be a **Packaged** product.

3. In the **Enrolled Products** zone, click the **Broadcast** () icon corresponding to the product type, whose enrolled standard products you want to view.

The **Enrolled Standard Products** zone appears.

4. View the list of the standard products that are enrolled in the **Enrolled Standard Products** screen.

Note: The **Enrolled Standard Products** zone appears when the product is of **Business** type, displayed in the **Enrolled Products** zone.

Related Topics

For more information on...	See...
Enrolled Standard Products zone	Enrolled Standard Products on page 2258
How to search for enrolled products	Searching for a Product Enrollment on page 2248

Editing a Product Enrollment

Procedure

To edit a product enrollment:

1. Search for the product in the **Search Enrollment** zone.

Note: ORMB search engine supports wildcard search, where you can substitute the percentage (%) symbol as a stand in for any word or letter in a search criteria. You can use the '%' wildcard character in all input fields except the date and ID fields. The '%' wildcard character is suffixed automatically at the end of the partial search criteria. Therefore, you may or may not specify the wildcard character at the end of the partial search criteria. However, you have to prefix the wildcard character manually wherever required.

2. Click the link in the **Enrollment ID** column, corresponding to the broadcast icon.

The **Product Enrollment** screen appears.

3. Click the **Edit** button in the **Product Enrollment** zone.

The **Product Enrollment** screen appears.

4. Modify the details of the product version in the main section, if required.
5. Define, edit, or remove the products and/or services for a product enrollment, if required.
6. Modify the product priority for a product enrollment, if required.

Note:

The priority for the enrolled product must be greater than zero (0).

7. Define, edit, or remove the characteristics for a product enrollment, if required.
8. Click **Save**.

Note:

You cannot edit the details of the product enrollment when it is in the enrolled status.

The changes made to the product enrollment are saved.

You cannot enroll for more than one product with the same product type and priority combination.

Copying a Product Enrollment

Instead of creating a product enrollment from scratch, you can create a new product enrollment using an existing enrollment. This is possible through copying a product enrollment. On copying a product enrollment, the details including the algorithms and characteristics are copied to the new product. You can then edit the details, if required.

Prerequisites

To copy a product enrollment, you should have:

- Account ID, Account Start and End Date, and Enrollment Channel defined in the application.
- Product and Characteristic Type defined in the application.

Procedure

To copy a product enrollment:

1. Search for a product in the **Product Enrollment** screen.
2. In the **Search Results** section, click the link in the **Description** column, corresponding to the product column, whose details you want to copy.

The **Product Enrollment** screen appears.

3. Click the **Duplicate** button in the **Record Actions** section.

The **Product Enrollment** screen appears.

4. Enter the required product details in the **Main** section, if required.
5. Define, edit, or remove the products and services, if required.
6. Define, edit, or remove the product priority, if required.
7. Define, edit, or remove the characteristics, if required.
8. Click **Save**.

The new product enrollment is defined.

Related Topics

For more information on...	See...
How to enroll an account for one or more products and services	Enrolling an Account for One or More Products and Services on page 2251
How to view the product priority of an account	Viewing the Product Priority of an Account on page 2254
How to define the characteristics for a product enrollment	Defining a Characteristic for a Product Enrollment on page 2255

Enrolling a Product Enrollment

Prerequisites

To enroll a product for an enrollment, you should have:

- Status of the product defined as Pending or Validated.
- Account Information defined in the application.
- Enrollment Channel defined in the application.
- Product defined in the application.
- Characteristic Type defined in the application.

Procedure

To enroll a product for an enrollment:

1. Search for the product in the **Search Enrollment** zone.
2. Click the link in the **Enrollment ID** column, corresponding to the broadcast icon.
The **Product Enrollment** screen appears.
3. Click the **Submit** button in the **Product Enrollment** zone.

The product status gets changed to **Enroll**.

Note: Once the submit button is clicked the ORMB application validates the account information, enrollment channel, product, and characteristic type field to ensure that they contain appropriate data. If any information is missing then an error message is displayed.

Related Topics

For more information on...	See...
How to enroll an account for one or more products and services	Enrolling an Account for One or More Products and Services on page 2251
How to edit a product enrollment	Editing a Product Enrollment on page 2261
How to copy a product enrollment	Copying a Product Enrollment on page 2262

Unenrolling a Product Enrollment

Prerequisites

To unenroll a product for an enrollment, you should have:

- Status of the product defined as enrolled.
- Account Information defined in the application.
- Enrollment Channel defined in the application.

- Product defined in the application.
- Characteristic Type defined in the application.

Procedure

To unenroll a product for an enrollment:

1. Search for the product in the **Search Enrollment** zone.
2. Click the link in the **Enrollment ID** column, corresponding to the broadcast icon.

The **Product Enrollment** screen appears.

3. Click the **Unenroll** button in the **Product Enrollment** zone.

The Unenroll Product Enrollment Pre Transition window appears. It contains the following fields:

Field Name	Field Description	Mandatory (Yes or No)
Enrollment ID	Displays the enrollment ID of the enrolled product.	Not applicable
Status	Displays the status of the enrolled product.	Not applicable
Start Date	Displays the start date of the enrolled product.	Not applicable
End Date	Displays the end date of the enrolled product.	No

Note: If the user manually performs the unenrollment process, the application will simply change the product enrollment status from **Enroll** to **Unenroll**. If in-case the **End Date** is not mentioned during the enrollment, the application keeps the **End Date** in an **Open** state. If the user does not performs the unenrollment process, then a batch named **C1-EXTRN** gets executed. This batch performs a check to ensure that the product end date and the business date make a match. If they both match, then all of the enrollments with relation to the product are unenrolled.

4. Click **Save**.

The product enrollment status is changed to **Unenroll**.

Related Topics

For more information on...	See...
How to enroll an account for one or more products and services	Enrolling an Account for One or More Products and Services on page 2251
How to edit a product enrollment	Editing a Product Enrollment on page 2261
How to copy a product enrollment	Copying a Product Enrollment on page 2262
How to search for a product enrollment	Searching for a Product Enrollment on page 2248

Viewing the Log of a Product Enrollment

Procedure

To view the log of a Product Enrollment:

1. Search for the product enrollment in the **Product Enrollment** screen.
2. In the **Search Results** section, click the **Enrollment ID** link corresponding to the broadcast icon, whose product enrollment log you want to view.

The **Product Enrollment** screen appears. It consists of the following tabs:

- [Product Enrollment - Main](#) on page 2256

- [Product Enrollment - Log](#) on page 2260
3. Click the **Log** tab.
The **Log** tab appears.
 4. View the complete trail of actions performed on the product enrollment in the **Product Enrollment Log** zone.

Related Topics

For more information on...	See...
How to search for a Product Enrollment	Searching for a Product Enrollment on page 2248

Chapter 35

Subscription Billing

Topics:

- *Prerequisites*
- *Subscription Type (Used for Searching)*
- *Subscription Type (Used for Viewing)*
- *Account Subscription (Used for Searching)*
- *Account Subscription (Used for Viewing)*

Oracle Revenue Management and Billing (ORMB) facilitates the service based billing wherein the customers pay a subscription price to have access to a product or service. For example, the customer may subscribe for newspaper service, cable service, internet service, video service (like Netflix, Amazon Prime Video), cloud service, and so on. The consumers may have to pay one or more charges with respect to the subscribed service. These charges can be one-time or recurring charges in nature.

In **ORMB**, you can carry out service based billing for an account by creating subscription on the account. While creating an account subscription, you need to specify the subscription type using which you want to create the account subscription. It is the subscription type which helps the system to determine:

- The business object using which the account subscription must be created in the system.
- The division and contract type for which the subscription type is created.
- The default duration for which the account subscription or service charge must be renewed when the automatic renewal option is selected.
- Whether the service charges should be prorated when the account subscription is suspended for a particular duration, or when one or more services or the entire account subscription is terminated.
- Whether already billed charges should be adjusted on the next bill in case of suspension and termination.
- The adjustment type using which the adjustments must be created when the account subscription is edited, suspended, or resumed.
- The adjustment type using which the adjustments must be created when one or more services or the entire account subscription is terminated.
- The services which the consumer can subscribe when the account subscription is created using the subscription type.
- The charges which can be charged when the consumer subscribes for a particular service.
- The distribution code for each charge which indicates the GL account to which the corresponding financial transaction must be posted.
- Whether the monthly recurring revenue is exempted for the service.
- The algorithm which must be executed when the account subscription is terminated, suspended, or resumed.

While creating an account subscription, the system allows you to use only those subscription types for the account which are defined for the division to which the account belongs and which are associated with the contract type whose

contract exists on the account. You can specify whether the account subscription must be automatically renewed for the default duration (which is specified in the subscription type). In case of subscription renewal, you can specify whether there is any cost escalation at the time of renewal. You can add services and its charges in the account subscription depending on the subscription type. The system allows you to indicate whether the charge is a one-time charge or a recurring charge. You can specify the frequency at which the recurring charges should be created for the subscribed services. In case of service charge renewal, you can specify whether there is any cost escalation at the time of renewal.

Once an account subscription is created, the status of the account subscription is set to **Draft**. You can then edit, delete, submit, or cancel the account subscription, if required. You can optionally configure approval workflow for the account subscription. On submitting an account subscription when the approval workflow is off, the status of the account subscription is changed to Active. However, on submitting an account subscription when the approval workflow is on, an approval transaction is created for the account subscription. Only when the approver approves the approval transaction, the status of the account subscription is changed to Active. Note that the status of the account subscription is changed to Active when the subscription start date is past dated. However, if the subscription start date is a future date, the status of the account subscription is changed to **Validated** irrespective of whether the approval workflow is on or off.

A new batch named **Account Subscription Periodic Monitor (C1-ASUBM)** batch is introduced in this release. It monitors or checks whether there are any account subscriptions in the **Validated** status. If there is an account subscription in the **Validated** status and its subscription start date is earlier than or equal to batch business date, the status of the account subscription is changed to **Active**. You can then edit the details, if required. However, while editing, you can only change end dates and add the services and charges in the account subscription. You cannot remove a service or charge from the account subscription once it is in the Active status. For more information on batch, see **Oracle Revenue Management and Billing Batch Guide**.

The system allows you to suspend the account subscription for a particular duration. While suspending the account subscription, you need to specify the suspension reason and suspension condition indicating whether fees should be charged or not for the suspended period. Based on the suspension condition and proration options defined, the system will accordingly update or cancel billable charges.

The system also allows you to terminate a particular service or all services at the same time. While terminating a service, you can specify the termination charges, if any. If the termination charges are specified, the adjustments will be created and posted accordingly on the next bill.

Prerequisites

To setup the subscription billing feature, you need to do the following:

- Define the required subscription billing types in the system.
- Define the required characteristic types where the characteristic entity is set to **Subscription Type**.
- Define the required characteristic types where the characteristic entity is set to **Account Subscription**.
- Define values for the option types in the feature configuration.
- Define values for the lookup field.
- Define predefined values for the characteristic type.
- Adjustment Type will be validated based on the adjustment type profile attached on the Contract Type.
- At least one subscription charge is mandatory, for each subscription service.
- An account with a division same as the division of the selected subscription type.
- An account with a unique contract ID on the contract type.
- At least one subscription service is mandatory, for each subscription type.

Related Topics

For more information on...	See...
Subscription Billing Overview	Subscription Billing on page 2267

Subscription Type (Used for Searching)

The **Subscription Type** screen allows you to search for the subscription type details using various search criteria. It contains the following zone:

- [Search Subscription Type](#) on page 2269

Through this screen, you can navigate to the following screen:

- [Subscription Type \(Used for Viewing\)](#) on page 2275

Search Subscription Type

The **Search Subscription Type** zone allows you to search for a subscription type using various search criteria. It contains the following two sections:

- **Search Criteria** – The **Search Criteria** section contains the following fields:

Field Name	Field Description	Mandatory (Yes or No)
Subscription Type	Used to search by a subscription type.	Yes
Description	Used to search a subscription type with a particular description.	No
Division	Used to search a subscription type which is associated with a particular division.	No
Contract Type	Used to specify the contract type to which the contract to which the subscription type belongs.	No

Field Name	Field Description	Mandatory (Yes or No)
	Note: The Search (🔍) icon appears corresponding to this field. On clicking the Search icon, the Contract Type Search window appears.	
Status	Used to search the subscription type with a particular status. The valid values are: <ul style="list-style-type: none"> Active Inactive 	No

Note: You must specify at least one search criterion while searching for a subscription type.

- **Search Results** – On clicking the **Search** button, the search results appear based on the specified search criteria. The **Search Results** section contains the following columns:

Column Name	Column Description
Subscription Information	Type Displays the basic information about the subscription type. Note: It has a link. On clicking the link, the Subscription Type screen appears where you can view the details of the respective subscription type.
Status	Indicates the status of the subscription type. The valid values are: <ul style="list-style-type: none"> Active Inactive
Division	Displays the division to which the subscription type belongs.
Contract Type	Displays the contract type that you want to associate with the subscription type.

Related Topics

For more information on...	See...
How to search for a subscription type	Searching for a Subscription Type on page 2270
How to view the details of a subscription type	Viewing the Subscription Type Details on page 2271

Searching for a Subscription Type

Prerequisites

To search for a subscription type, you should have:

- Subscription type business objects defined in the application
- Subscription Services defined in the application

Procedure

To search for a subscription type:

1. Click the **Admin** link in the **Application** toolbar.

A list appears.

- From the **Admin** menu, select **S** and then click **Subscription Type**.

The **Subscription Type** screen appears.

- Enter the search criteria in the **Search Subscription Type** zone.

Note: ORMB search engine supports wildcard search, where you can substitute the percentage (%) symbol as a stand in for any word or letter in a search criteria. You can use the ‘%’ wildcard character in all input fields except the date and ID fields. The ‘%’ wildcard character is suffixed automatically at the end of the partial search criteria. Therefore, you may or may not specify the wildcard character at the end of the partial search criteria. However, you have to prefix the wildcard character manually wherever required.

- Click **Search**.

A list of subscription types that meet the search criteria appears in the **Search Results** section.

Note: You must specify at least one search criterion while searching for a subscription type.

Related Topics

For more information on...	See...
Subscription Type screen	Subscription Type (Used for Searching) on page 2269
Search Subscription Type zone	Search Subscription Type on page 2269

Viewing the Subscription Type Details

Procedure

To view the subscription type details:

- Search for the subscription type in the **Subscription Type** screen.
- In the **Search Results** section, click the link in the **Subscription Type Information** column whose details you want to view.

The **Subscription Type** screen appears.

- View the details of the subscription type in the **Subscription Type** zone.

Related Topics

For more information on...	See...
Subscription Type screen	Subscription Type (Used for Viewing) on page 2275
Subscription Type zone	Subscription Type on page 2275
How to search for a subscription type	Searching for a Subscription Type on page 2270

Defining a Subscription Type

Prerequisites

To define a subscription type, you should have:

- Subscription type business objects defined in the application
- Subscription Services defined in the application

Procedure

To define a subscription type:

- Click the **Admin** link in the **Application** toolbar.

A list appears.

- From the **Admin** menu, select **S** and then click **Subscription Type**.

The **Subscription Type** screen appears.

- Enter the search criteria in the **Search Subscription Type** zone.
- Click **Add** button in the page title area of the **Subscription Type** screen.

The **Subscription Type** screen appears. It contains the following sections:

- **Main** – Used to specify basic details about the subscription services.
- **Subscription Services** – Used to specify the details of the subscription services.
- **Algorithms** – Used to specify the algorithms used in the subscription type.
- **Characteristics** – Used to define the characteristics for the subscription type.

The **Main** section contains the following fields:

Field Name	Field Description	Mandatory (Yes or No)
Subscription Type	Used to specify the subscription type.	Yes
Description	Used to specify the description for the subscription type.	Yes
Account Subscription Business Object	Used to indicate the business object using which you want to create a person when the corresponding account subscription is processed.	Yes
Detailed Description	Used to specify additional information about the subscription type.	No
Division	Used to indicate the division to which you want to associate the subscription type.	Yes
Contract Type	Used to indicate the Contract Type to which you want to associate the subscription type. Note: The Search (🔍) icon appears corresponding to this field. On clicking the Search icon, the Contract Type Search window appears.	Yes
Renewal Duration Type	Used to indicate the renewal cycle. The valid values are: <ul style="list-style-type: none"> • Day • Month • Week • Year 	Yes
Renewal Duration	Used to specify the duration of the renewal of the subscription.	Yes
Status	Used to indicate the status of the subscription type. The valid values are: <ul style="list-style-type: none"> • Active • Inactive 	Yes

Field Name	Field Description	Mandatory (Yes or No)
Prorate Charges	Indicates whether monthly subscription fee is prorated or not in the event the cancellation occurs in the middle of the month.	No
Adjust Billed Charges	Indicates the billed charges adjusted.	No
	Note: This field appears when you check the Prorate Charges check box.	
Adjustment Type	Used to indicate the adjustment type using which the adjustment must be created.	No
	Note: This field appears when you check the Prorate Charges and Adjust Billed Charges check box.	
Termination Adjustment Type	Used to indicate the adjustment type used for termination of the subscription service.	No
	Note: The Search (🔍) icon appears corresponding to this field. On clicking the Search icon, the Adjustment Type Search window appears.	

The **Subscription Services** section contains the following fields in a grid:

Field Name	Field Description	Mandatory (Yes or No)
Subscription Service	Used to specify the type of the subscription service.	Yes
Monthly Recurring Revenue (MRR) Exempted	Used to indicate whether the service type is exempted from MRR calculation.	No
Subscription Charge	Used to indicate charges related to the subscription service.	Yes
Distribution Code	Used to indicate distribution code linked to the service that will be used on the billable charge.	No
	Note: The Search (🔍) icon appears corresponding to this field. On clicking the Search icon, the Distribution Code Search window appears.	

The **Algorithms** section contains the following fields in a grid:

Field Name	Field Description	Mandatory (Yes or No)
System Event	Used to indicate the system event.	Yes
Sequence	Used to specify the sequence number.	Yes
Algorithm	Used to associate an algorithm to the system event that you have selected.	Yes

Field Name	Field Description	Mandatory (Yes or No)
	Note: The Search (🔍) icon appears corresponding to this field. On clicking the Search icon, the Algorithm Search window appears.	

5. Enter the required details in the **Main** section.
6. Add algorithms for the subscription type, if required.
7. Define characteristics for the subscription type, if required.
8. Click **Save**.

The subscription type is defined.

Related Topics

For more information on...	See...
Subscription Type screen	Subscription Type (Used for Viewing) on page 2275
Search Subscription Type zone	Search Subscription Type on page 2269
How to define a characteristic for a subscription type	Defining a Characteristic for a Subscription Type on page 2274

Defining a Characteristic for a Subscription Type

Prerequisites

To define a characteristic for a subscription type, you should have:

- Characteristic types defined in the application (where the characteristic entity is set to **Subscription Type**)

Procedure

To define a characteristic for a subscription type:

1. Ensure that the **Characteristics** section is expanded when you are defining, editing, or copying a subscription type.

The **Characteristics** section contains the following fields:

Field Name	Field Description	Mandatory (Yes or No)
Effective Date	Used to specify the date from when the characteristic is effective.	Yes (Conditional) Note: This field is required when you are defining a characteristic for a subscription type.
Characteristic Type	Used to specify the characteristic type.	Yes (Conditional) Note: This field is required when you are defining a characteristic for a subscription type.
Characteristic Value	Used to specify the value of characteristic type.	Yes (Conditional)

Field Name	Field Description	Mandatory (Yes or No)
	Note: On specifying the value for a predefined characteristic type, the description of the characteristic value appears corresponding to the Characteristic Value field.	Note: This field is required when you are defining a characteristic for a subscription type.

2. Enter the required details in the **Characteristics** section.

Note: If you select a predefined characteristic type, the **Search** (🔍) icon appears corresponding to the **Characteristic Value** field. On clicking the **Search** icon, you can search for a predefined characteristic value.

3. If you want to define more than one characteristic for the subscription type, click the **Add** (+) icon and then repeat step 2.

Note: However, if you want to remove a characteristic from the subscription type, click the **Delete** (🗑️) icon corresponding to the characteristic.

Related Topics

For more information on...	See...
How to define a subscription type	Defining a Subscription Type on page 2271
How to edit a subscription type	Editing a Subscription Type on page 2278
How to copy a subscription type	Copying a Subscription Type on page 2280

Subscription Type (Used for Viewing)

The **Subscription Type** screen allows you to define, edit, copy, and delete subscription type. It contains the following zone:

- [Subscription Type](#) on page 2275

Subscription Type

The **Subscription Type** zone displays the details of the subscription type. It contains the following sections:

- **Main** – Displays basic information about the subscription type. It contains the following fields:

Field Name	Field Description
Subscription Type	Displays the subscription type.
Description	Displays the description for the subscription type.
Account Subscription Business Object	Indicates the business object using which you want to create a person when the corresponding account subscription is processed. In addition, a context menu appears corresponding to this field which helps in navigating to other screens in the application.

Field Name	Field Description
	Note: It has a link. On clicking the link, the Business Object screen appears where you can view the details of the respective business object.
Detailed Description	Displays additional information about the subscription type.
Division	Indicates the division to which you want to associate the subscription type. Note: It has a link. On clicking the link, the Division screen appears where you can view the details of the respective division.
Contract Type	Indicates the Contract Type to which you want to associate the subscription type.
Renewal Duration Type	Indicates the renewal cycle. The valid values are: <ul style="list-style-type: none"> • Day • Month • Week • Year
Renewal Duration	Displays the duration of the renewal of the subscription.
Status	Indicates the status of the subscription type. The valid values are: <ul style="list-style-type: none"> • Active • Inactive Note: You cannot change the status of a Subscription Type to Inactive if there are account subscriptions that are created using the Subscription Type and are currently in the Draft or Approval In Progress status.
Prorate Charges	Indicates whether monthly subscription fee is prorated or not in the event the cancelation occurs in the middle of the month.
Adjust Billed Charges	Indicates the billed charges adjusted. Note: This field appears when you check the Prorate Charges check box.
Adjustment Type	Indicates the adjustment type using which the adjustment must be created. Note: This field appears when you check the Prorate Charges and Adjust Billed Charges check box. It has a link. On clicking the link, the Adjustment Type screen appears where you can view the details of the respective business object.
Termination Adjustment Type	Indicates the adjustment type used for termination of the subscription service.

- The **Subscription Services** section contains the following columns:

Column Name	Column Description
Subscription Service	Displays the type of the subscription service.

Column Name	Column Description
Monthly Recurring Revenue (MRR) Exempted	Indicates whether the service type is exempted from MRR calculation.
Subscription Charge	Indicates the charges related to the subscription service.
Distribution Code	Indicates the distribution code linked to the service that will be used on the billable charge.

- **Characteristics** – Lists the characteristics defined for the subscription type. It contains the following columns:

Column Name	Column Description
Effective Date	Displays the date from when the subscription is effective.
Characteristic Type	Indicates the characteristic type.
Characteristic Value	Displays the value of the characteristic type.

- **Record Actions** – This section contains the following buttons:

Button Name	Button Description
Edit	Used to edit the details of the subscription type.
Delete	Used to delete the subscription type. Note: You can delete an subscription type when you have not created an subscription type using the subscription type.
Duplicate	Used to create a new subscription type using an existing subscription type.

- **Record Information** – This section contains the following field:

Field Name	Field Description
Business Object	Indicates the business object using which the subscription type is created. In addition, a context menu appears corresponding to this field which helps in navigating to other screens in the application. Note: It has a link. On clicking the link, the Business Object screen appears where you can view the details of the respective business object.

- The **Algorithms** section contains the following columns:

Field Name	Field Description	Mandatory (Yes or No)
System Event	Displays the system event.	Yes
Sequence	Displays the sequence number.	Yes
Algorithm	Displays an algorithm associated to the system event that you have selected. Note: It has a link. On clicking the link, the Algorithm screen appears where you can view the details of the respective subscription type.	Yes

Related Topics

For more information on...	See...
How to edit an subscription type	Editing a Subscription Type on page 2278
How to copy an subscription type	Copying a Subscription Type on page 2280
How to delete an subscription type	Deleting a Subscription Type on page 2282
How to view the details of an subscription type	Viewing the Subscription Type Details on page 2271

Editing a Subscription Type**Procedure**

To edit a subscription type:

1. Search for the subscription type in the **Subscription Type** screen.
2. In the **Search Results** section, click the link in the **Subscription Type Information** column corresponding to the subscription type whose details you want to edit.

The **Subscription Type** screen appears.

3. Click the **Edit** button in the **Subscription Type** zone.

The **Subscription Type** screen appears. It contains the following sections:

- **Main** – Used to specify basic details about the subscription services.
- **Subscription Services** – Used to specify the details of the subscription services.
- **Algorithms** – Used to specify the algorithms used in the subscription type.
- **Characteristics** – Used to define the characteristics for the subscription type.

The **Main** section contains the following fields:

Field Name	Field Description	Mandatory (Yes or No)
Subscription Type	Used to specify the subscription type.	Yes
Description	Used to specify the description for the subscription type.	Yes
Account Subscription Business Object	Used to indicate the business object using which you want to create a person when the corresponding account subscription is processed.	Yes
Detailed Description	Used to specify additional information about the subscription type.	No
Division	Used to indicate the division to which you want to associate the subscription type.	Yes
Contract Type	Used to indicate the Contract Type to which you want to associate the subscription type.	Yes
Renewal Duration Type	Used to indicate the renewal cycle. The valid values are: <ul style="list-style-type: none"> • Day • Month • Week 	Yes

Field Name	Field Description	Mandatory (Yes or No)
	<ul style="list-style-type: none"> Year 	
Renewal Duration	Used to specify the duration of the renewal of the subscription.	Yes
Status	Used to indicate the status of the subscription type. The valid values are: <ul style="list-style-type: none"> Active Inactive 	Yes
Prorate Charges	Indicates whether monthly subscription fee is prorated or not in the event the cancelation occurs in the middle of the month.	No
Adjust Billed Charges	Indicates the billed charges adjusted.	No
	Note: This field appears when you check the Prorate Charges check box.	
Adjustment Type	Used to indicate the adjustment type using which the adjustment must be created.	No
	Note: This field appears when you check the Prorate Charges and Adjust Billed Charges check box.	
Termination Adjustment Type	Used to indicate the adjustment type used for termination of the subscription service.	No

The **Subscription Services** section contains the following fields in a grid:

Field Name	Field Description	Mandatory (Yes or No)
Subscription Service	Used to specify the type of the subscription service.	Yes
Monthly Recurring Revenue Exempted (MRR)	Used to indicate whether the service type is exempted from MRR calculation.	No
Subscription Charge	Used to indicate charges related to the subscription service.	Yes
Distribution Code	Used to indicate distribution code linked to the service that will be used on the billable charge.	No

The **Algorithms** section contains the following fields in a grid:

Field Name	Field Description	Mandatory (Yes or No)
System Event	Used to indicate the system event.	Yes
Sequence	Used to specify the sequence number.	Yes
Algorithm	Used to associate an algorithm to the system event that you have selected.	Yes

Field Name	Field Description	Mandatory (Yes or No)
	Note: The Search (🔍) icon appears corresponding to this field. On clicking the Search icon, the Algorithm Search window appears.	

4. Add algorithms for the subscription type, if required.
5. Define, edit, or remove characteristics of the subscription type, if required.
6. Click **Save**.

The changes made to the subscription type are saved.

Related Topics

For more information on...	See...
Subscription Type screen	Subscription Type (Used for Viewing) on page 2275
Subscription Type zone	Subscription Type on page 2275
How to search for a subscription type	Searching for a Subscription Type on page 2270
How to define a characteristic for a subscription type	Defining a Characteristic for a Subscription Type on page 2274

Copying a Subscription Type

Prerequisites

To copy a subscription type, you should have:

- Subscription type (whose copy you want to create) defined in the application
- Account Subscription business objects defined in the application

Procedure

To copy a subscription type:

1. Click the **Admin** link in the **Application** toolbar.
A list appears.
2. From the **Admin** menu, select **S** and then click **Subscription Type**.
The **Subscription Type** screen appears.
3. Enter the search criteria in the **Search Subscription Type** zone.
4. In the **Search Results** section, click the link in the **Subscription Type Information** column whose details you want to view.
5. Click the **Duplicate** button in the **Subscription Type** zone.

The **Subscription Type** screen appears. It contains the following sections:

- **Main** – Used to specify basic details about the subscription services.
- **Subscription Services** – Used to specify the details of the subscription services.
- **Algorithms** – Used to specify the algorithms used in the subscription type.
- **Characteristics** – Used to define the characteristics for the subscription type.

The **Main** section contains the following fields:

Field Name	Field Description	Mandatory (Yes or No)
Subscription Type	Used to specify the subscription type.	Yes
Description	Used to specify the description for the subscription type.	Yes
Account Subscription Business Object	Used to indicate the business object using which you want to create a person when the corresponding account subscription is processed.	Yes
Detailed Description	Used to specify additional information about the subscription type.	No
Division	Used to indicate the division to which you want to associate the subscription type.	Yes
Contract Type	Used to indicate the Contract Type to which you want to associate the subscription type.	Yes
Renewal Duration Type	Used to indicate the renewal cycle. The valid values are: <ul style="list-style-type: none"> • Day • Month • Week • Year 	Yes
Renewal Duration	Used to specify the duration of the renewal of the subscription.	Yes
Status	Used to indicate the status of the subscription type. The valid values are: <ul style="list-style-type: none"> • Active • Inactive 	Yes
Prorate Charges	Used to indicate whether monthly subscription fee is prorated or not in the event the cancelation occurs in the middle of the month.	No
Adjust Billed Charges	Used to indicate the billed charges adjusted.	No
	Note: This field appears when you check the Prorate Charges check box.	
Adjustment Type	Used to indicate the adjustment type using which the adjustment must be created.	No
	Note: This field appears when you check the Prorate Charges and Adjust Billed Charges check box.	
Termination Adjustment Type	Used to indicate the adjustment type used for termination of the subscription service.	No

The **Subscription Services** section contains the following fields in a grid:

Field Name	Field Description	Mandatory (Yes or No)
Subscription Service	Used to specify the type of the subscription service.	Yes
Monthly Recurring Revenue Exempted (MRR)	Used to indicate whether the service type is exempted from MRR calculation.	No
Subscription Charge	Used to indicate charges related to the subscription service.	Yes
Distribution Code	Used to indicate distribution code linked to the service that will be used on the billable charge.	No

The **Algorithms** section contains the following fields in a grid:

Field Name	Field Description	Mandatory (Yes or No)
System Event	Used to indicate the system event.	Yes
Sequence	Used to specify the sequence number.	Yes
Algorithm	Used to associate an algorithm to the system event that you have selected.	Yes
	Note: The Search (🔍) icon appears corresponding to this field. On clicking the Search icon, the Algorithm Search window appears.	

- Enter the required details in the **Main** section.
- Add algorithms for the subscription type, if required.
- Define characteristics for the subscription type, if required.
- Click **Save**.

The new subscription type is defined.

Related Topics

For more information on...	See...
Subscription Type screen	Subscription Type (Used for Searching) on page 2269
Subscription Type zone	Subscription Type on page 2275
How to define a characteristic for a subscription type	Defining a Characteristic for a Subscription Type on page 2274

Deleting a Subscription Type

Procedure

To delete a subscription type:

- Click the **Admin** link in the **Application** toolbar.
A list appears.
- From the **Admin** menu, select **S** and then click **Subscription Type**.
The **Subscription Type** screen appears.

3. Enter the search criteria in the **Search Subscription Type** zone.
4. In the **Search Results** section, click the link in the **Subscription Type Information** column whose details you want to view.
5. Click the **Delete** button in the **Subscription Type** zone.

A message appears confirming whether you want to delete the subscription type.

6. Click **OK**.

The subscription type is deleted.

Related Topics

For more information on...	See...
Subscription Type screen	Subscription Type (Used for Searching) on page 2269
Subscription Type zone	Subscription Type on page 2275

Account Subscription (Used for Searching)

The **Account Subscription** screen allows you to search for account details or the account subscription details using various search criteria. It contains the following zone:

- [Search Account Subscription](#)

Through this screen, you can navigate to the following screen:

- [Account Subscription \(Used for Viewing\)](#) on page 2289

Search Account Subscription

The **Search Account Subscription** zone displays the details of the account subscription. It contains the following sections:

- **Search Criteria** – The **Search Criteria** section contains the following fields:

Field Name	Field Description	Mandatory (Yes or No)
Search By	Used to indicate whether you want to search for an account subscription using account or account subscription. The valid values are: <ul style="list-style-type: none"> • Account Details • Account Subscription Details 	Yes
	Note: By default, the Account Details option is selected.	
Account ID	Used to search for a particular account. Note: The Search (🔍) icon appears corresponding to this field. On clicking the Search icon, the Account Search window appears.	No
Account Identifier Type	Used to specify the account identifier type.	No

Field Name	Field Description	Mandatory (Yes or No)
Account Identifier	Used to specify the account identifier of the account for which you want to create the billable charge.	No
Account Subscription ID	Used to specify the account subscription ID.	No
Subscription Start Date	Used to specify the start date of the account subscription.	Yes
Subscription Type	Used to specify the account subscription type.	No
	Note: The Search (🔍) icon appears corresponding to this field. On clicking the Search icon, the Subscription Type window appears.	
Subscription End Date	Used to specify the end date of the account subscription.	Yes
Status	Indicates the status of the account subscription. The valid values are: <ul style="list-style-type: none"> • Active • Canceled • Expired • Draft • Renewed • Suspended • Validated • Terminated 	Yes

- **Search Results** – On clicking the **Search** button, the search results appear based on the specified search criteria. The **Search Results** section contains the following columns:

Column Name	Column Description
Account Subscription Information	Displays the basic information about the account subscription.
	Note: It has a link. On clicking the link, the Account Subscription screen appears where you can view the details of the respective upload request.
Subscription Type Information	Displays the basic information about the subscription type.
	Note: It has a link. On clicking the link, the Subscription Type screen appears where you can view the details of the respective upload request.
Account Information	Displays the basic information about the account.
	Note: It has a link. On clicking the link, the Account screen appears where you can view the details of the respective upload request.

Searching for an Account Subscription

Prerequisites

To search for an account subscription, you should have:

- Subscription type defined in the application
- Subscription Services defined in the application

Procedure

To search for an account subscription:

1. Click the **Menu** link in the **Application** toolbar.
A list appears.
2. From the **Main** menu, select **Customer Management** and then click **Account Subscription**.
A sub-menu appears.
3. Click the **Search** option from the **Account Subscription** sub-menu.
The **Account Subscription** screen appears.
4. Enter the search criteria in the **Search Account Subscription** zone.

Note: ORMB search engine supports wildcard search, where you can substitute the percentage (%) symbol as a stand in for any word or letter in a search criteria. You can use the ‘%’ wildcard character in all input fields except the date and ID fields. The ‘%’ wildcard character is suffixed automatically at the end of the partial search criteria. Therefore, you may or may not specify the wildcard character at the end of the partial search criteria. However, you have to prefix the wildcard character manually wherever required.

5. Click **Search**.
A list of account subscriptions that meet the search criteria appears in the **Search Results** section.

Note: You must specify at least one search criterion while searching for an account subscription.

Related Topics

For more information on...	See...
Account Subscription screen	Account Subscription (Used for Searching) on page 2283
Search Account Subscription zone	Search Account Subscription on page 2283

Viewing the Account Subscription Details

Procedure

To view the details of the account subscription:

1. Search for the account subscription in the **Account Subscription** screen.
2. In the **Search Results** section, click the link in the **Account Subscription Information** column corresponding to the subscription type whose details you want to view.
The **Account Subscription** screen appears.
3. Ensure that the **Main** tab is selected.
4. View the details of the account subscription in the **Account Subscription** zone.

Related Topics

For more information on...	See...
Account Subscription zone	Account Subscription (Used for Viewing) on page 2289
Account Subscription screen	Account Subscription on page 2290

For more information on...	See...
How to search for an account subscription	Searching for an Account Subscription on page 2284

Defining an Account Subscription

Prerequisites

To define an account subscription, you should have:

- Subscription type business objects defined in the application
- Subscription Services defined in the application

Procedure

To define an account subscription:

1. Click the **Menu** link in the **Application** toolbar.
A list appears.
2. From the **Main** menu, select **Customer Management** and then click **Account Subscription**.
A sub-menu appears.
3. Click the **Add** option from the **Account Subscription** sub-menu.

The **Account Subscription** screen appears. It contains the following fields:

Field Name	Field Description	Mandatory (Yes or No)
Subscription Type	Used to search a particular subscription type.	Yes
	Note: The Search (🔍) icon appears corresponding to this field. On clicking the Search icon, the window appears.	
Account ID	Used to search a particular subscription type.	Yes
	Note: The Search (🔍) icon appears corresponding to this field. On clicking the Search icon, the Account Search window appears.	

Tip: Alternatively, you can access the **Account Subscription** screen by clicking the **Add** button in the page title area of the **Account Subscription** screen.

4. Click **OK**.

The **Account Subscription** screen appears. It contains the following sections:

- **Main** – Used to specify basic details about the subscription services.
- **Subscription Services and Charges** – Used to specify the details of the subscription services.
- **Characteristics** – Used to define the characteristics for the subscription type.

The **Main** section contains the following fields:

Field Name	Field Description	Mandatory (Yes or No)
Subscription Type Information	Displays the basic information about the subscription type.	Not applicable

Field Name	Field Description	Mandatory (Yes or No)
Account Information	Displays the basic information about the account linked to the subscription type.	Not applicable
Subscription Start Date	Used to specify the date from when the subscription is effective. Note: The subscription start date cannot be later than the subscription end date.	Yes
Subscription End Date	Used to specify the date till when the subscription is effective. Note: The subscription end date cannot be earlier than the subscription start date.	Yes
Automatic Renewal	Used to indicate whether you want to renew the subscription automatically.	No
Cost Escalation (in Percentage)	Note: This field appears when Automatic Renewal check box is selected.	No
Comments	Used to specify additional information about the account subscription.	No

The **Subscription Services and Charges** section contains the following fields in a grid:

Field Name	Field Description	Mandatory (Yes or No)
Subscription Service	Used to specify the type of the subscription service.	Yes
Service Start Date	Used to indicate whether the service type is exempted from MRR calculation.	No
Subscription Charge	Used to indicate charges related to the subscription service.	Yes
Service End Date	Used to indicate distribution code linked to the service that will be used on the billable charge.	No
Subscription Charge	Used to specify the type of the subscription charges.	Yes
Charge Amount	Used to specify the charges related to the subscription charge.	Yes
Charge Start Date	Used to specify the date from when the charges are effective.	Yes
Charge End Date	Used to specify the date till when the charges are effective.	Yes
One-Time Charge	Used to indicate whether you want to pay the subscription charges one-time.	No
Recurring Charge Frequency	Used to specify whether you want to pay the subscription charges on regular recurring basis.	No

Field Name	Field Description	Mandatory (Yes or No)
	Note: This field gets enabled when you select the check box corresponding to the One-Time Charge field.	
Automatic Renewal	Used to indicate whether you want to renew the subscription services and charges automatically.	No
Cost Escalation (in Percentage)	Used to indicate the percentage in which the subscription charge amount must increase when the automatic renewal of the subscription is triggered. Note: This field appears when Automatic Renewal check box is selected.	No
Description on Bill	Used to specify the description on the bill.	No

- Enter the required details in the **Main** section.
- Enter the required details in the **Subscription Services and Charges** section.
- Define characteristics for an account subscription, if required.
- Click **Save**.

The account subscription is defined.

Related Topics

For more information on...	See...
Account Subscription screen	Account Subscription (Used for Viewing) on page 2289
How to define a characteristic for a subscription type	Defining a Characteristic for an Account Subscription on page 2288

Defining a Characteristic for an Account Subscription

Prerequisites

To define a characteristic for an account subscription, you should have:

- Characteristic types defined in the application (where the characteristic entity is set to **Account Subscription**)

Procedure

To define a characteristic for an account subscription:

- Ensure that the **Characteristics** section is expanded when you are defining or editing an account subscription.

The **Characteristics** section contains the following fields:

Field Name	Field Description	Mandatory (Yes or No)
Effective Date	Used to specify the date from when the characteristic is effective.	Yes (Conditional) Note: This field is required when you are defining a characteristic for an account subscription.

Field Name	Field Description	Mandatory (Yes or No)
Characteristic Type	Used to specify the characteristic type.	Yes (Conditional)
		Note: This field is required when you are defining a characteristic for an account subscription.
Characteristic Value	Used to specify the value of characteristic type. Note: On specifying the value for a predefined characteristic type, the description of the characteristic value appears corresponding to the Characteristic Value field.	Yes (Conditional)
		Note: This field is required when you are defining a characteristic for an account subscription.

- Enter the required details in the **Characteristics** section.

Note: If you select a predefined characteristic type, the **Search** (🔍) icon appears corresponding to the **Characteristic Value** field. On clicking the **Search** icon, you can search for a predefined characteristic value.

- If you want to define more than one characteristic for an account subscription, click the **Add** (+) icon and then repeat step 2.

Note: However, if you want to remove a characteristic from an account subscription, click the **Delete** (🗑️) icon corresponding to the characteristic.

Related Topics

For more information on...	See...
How to define an account subscription	Defining an Account Subscription on page 2286
How to suspend an account subscription	Suspending an Account Subscription on page 2302
How to terminate an account subscription	Terminating an Account Subscription on page 2303

Account Subscription (Used for Viewing)

Once the subscription type is created, the **Account Subscription** screen allows you to:

- View the details of an account subscription
- View Edit the details of the subscription services
- Define, Edit and Delete the subscription services
- Suspend an account subscription
- Terminate an account subscription
- View the account subscription suspension history
- View the account subscription termination charges
- View the log of an account subscription

- Add a log entry an account subscription

This screen consists of the following tabs:

- [Account Subscription - Main](#) on page 2290
- [Account Subscription - Log](#) on page 2293

Account Subscription - Main

The **Main** tab displays information about the account subscription and subscription services. It contains the following zones:

- [Account Subscription](#) on page 2290
- [Subscription Services](#) on page 2292
- [Account Subscription Suspension History](#) on page 2293
- [Account Subscription Termination Charges](#) on page 2293

Account Subscription

The **Account Subscription** zone displays the details of the account subscription. It contains the following sections:

- **Main** – Displays the basic details of the account subscription. It contains the following fields:

Field Name	Field Description
Account Subscription Information	Displays the basic information about the account subscription.
Subscription Information Type	Displays the basic details of the subscription type. Note: It has a link. On clicking the link, the Subscription Type screen appears where you can view the details of the respective subscription type.
Account Information	In addition, a context menu appears corresponding to this field which helps in navigating to other screens in the application. Note: It has a link. On clicking the link, the Account screen appears where you can view the details of the respective account.
Subscription Start Date	Displays the subscription start date.
Subscription End Date	Displays the subscription end date.
Automatic Renewal	Indicates whether the automatic renewal of the subscription is opted.
Status	Displays the status of the account subscription. The valid values are: <ul style="list-style-type: none"> • Active • Canceled • Expired • Draft • Renewed • Suspended • Validated • Terminated

Field Name	Field Description
Comments	Displays the additional information about the account subscription.

- **Characteristics** – This section lists the characteristics of the account subscription. It contains the following columns:

Field Name	Field Description
Effective Date	Indicates the date from when the characteristic is effective for the account subscription.
Characteristic Type	Indicates the characteristic type.
Characteristic Value	Displays the value of the characteristic type.

- **Record Actions** – This section contains the following buttons:

Field Name	Field Description
Edit	Used to edit the details of the account subscription.
	Note: The Edit button appears when the account subscription is in the Active or Draft status.
Suspend	Used to suspend the account subscription.
	Note: The Suspend button appears when the account subscription is in the Active status.
Terminate	Used to terminate the account subscription service. Used to suspend the account subscription.
	Note: The Terminate button appears when the account subscription is in the Active or Suspended status.
Delete	Used to delete the account subscription.
	Note: The Delete button appears when the account subscription is in the Active or Suspended status.
Submit	Used to submit the account subscription details.
	Note: The Submit button appears when the account subscription is in the Draft status.
Cancel	Used to cancel the account subscription.
	Note: The Cancel button appears when the account subscription is in the Draft and Validated status.
Resume	Used to resume the account subscription service.
	Note: The Resume button appears when the account subscription is in the Suspended status.

- **Record Information** – This section contains the following fields:

Field Name	Field Description
Business Object	Indicates the business object using which the account subscription is created. In addition, a context menu appears corresponding to this field which helps in navigating to other screens in the application.

Field Name	Field Description
	Note: It has a link. On clicking the link, the Business Object screen appears where you can view the details of the respective business object.
Status Date Time	Displays the date and time when the account subscription status is updated.
Creation Date Time	Displays the date and time when the account subscription is created.

Subscription Services

The **Subscription Services** zone displays the details of the subscription services. It contains the following columns:

Column Name	Column Description
Sequence	Displays the sequence number.
Subscription Service	Displays the type of subscription service.
Service Start Date	Displays the date from when the subscription service is effective.
Service End Date	Displays the date till when the subscription service is effective.
Termination Date	Displays the date on which the subscription service is terminated.
Termination Reason	Displays the reason for the termination of subscription service.
Edit	Used to edit the details of the subscription service.
Delete	Used to delete the subscription service.

Subscription Service Charges

The **Subscription Service Charges** zone displays the details of the charges related to the subscription services. It contains the following columns:

Column Name	Column Description
Subscription Charge	Displays the charges related to the subscription service.
Charge Amount	Displays the charges related to the subscription charge.
Charge Start Date	Displays the date from when the charges are effective.
Charge End Date	Displays the date till when the charges are effective.
One-Time Charge	Indicates the one-time charges related to the subscription services. The valid values are: <ul style="list-style-type: none"> • Yes • No
Recurring Charge Frequency	Indicates the recurring charges paid for the subscription service. <p>Note: It appears when one-time charge option is selected.</p>
Automatic Renewal	Indicates whether the subscription service charges are set to automatic renewal. The valid values are: <ul style="list-style-type: none"> • Yes • No

Column Name	Column Description
Cost Escalation (in Percentage)	Displays the percentage in which the subscription charge amount must increase when the automatic renewal of the subscription is triggered.
	Note: This field appears when Automatic Renewal check box is set to Yes .
Description on Bill	Displays the description on the bill.

Subscription Service Charge Entities

The **Subscription Service Charge Entities** zone displays the details of the subscription service charge entities. It contains the following columns:

Column Name	Column Description
Entity Type	Indicates the entity type used in the subscription service charge.
Entity Information	Displays the basic entity information.
	Note: It has a link. On clicking the link, the Billable Charge ID screen appears where you can view the details of the respective contract.

Account Subscription Suspension History

The **Account Subscription Suspension History** zone displays the details of the account subscriptions which are suspended. It contains the following columns:

Column Name	Column Description
Suspension Start Date	Displays the suspension start date of the account subscription.
Suspension End Date	Displays the suspension end date of the account subscription.
Suspension Condition	Displays the condition for account subscription suspension.
Suspension Reason	Displays the reason for account subscription suspension.
Resume Date	Displays the date on which the account subscription is resumed.

Account Subscription Termination Charges

The **Account Subscription Termination Charges** zone displays the details of the termination charges of the account subscription. It contains the following columns:

Column Name	Column Description
Termination Charge Type	Indicates the type of account subscription termination charges.
Charge Amount	Indicates the charges for the termination of the account subscription.
Adjustment Information	Displays the information about the adjustment that is created using the adjustment record.
	Note: The Search (🔍) icon appears corresponding to this field. On clicking the Search icon, the Adjustment Type Search screen appears.

Account Subscription - Log

The **Log** tab contains the following zone:

- [Account Subscription Log](#) on page 2294

Account Subscription Log

The **Account Subscription Log** zone lists the complete trail of actions performed on the account subscription. It contains the following columns:

Column Name	Column Description
Creation Date Time	Displays the date and time when the action was performed on the account subscription.
Details	Displays the details about the action performed on the account subscription.
User	Indicates the user who has performed the action on the account subscription.
Log Type	Indicates the type of log.
Related Object	Indicates the object or entity which is created when the action is performed on the account subscription.
	Note: At present, no data appears in this column. The implementation team can build the custom logic to meet the business requirements.
Status Reason	Indicates the reason why the status of the account subscription is changed.
	Note: At present, no data appears in this column. The implementation team can build the custom logic to meet the business requirements.

Related Topics

For more information on...	See...
Account Subscription Log Tab	Account Subscription - Log on page 2293
How to view the log of an account subscription	Viewing the Log of an Account Subscription on page 2304

Adding Services and Charges in the Account Subscription

Prerequisites

To add services and charges in the account subscription, you should have:

- Subscription type business objects defined in the application
- Subscription Services defined in the application

Procedure

To add services and charges in the account subscription:

1. Search for the account subscription in the **Account Subscription** screen.

A list appears.

2. In the **Search Results** section, click the link in the **Account Subscription Information** column whose details you want to view.

The **Account Subscription** screen appears.

3. Click **Add** button in the upper right corner of the **Subscription Services** zone.

The **Account Subscription Services and Charges** screen appears, where you can add the subscription services. It contains the following fields in a grid:

Field Name	Field Description	Mandatory (Yes or No)
Subscription Service	Used to specify the type of the subscription service.	Yes
Service Start Date	Used to indicate whether the service type is exempted from MRR calculation.	Yes

In addition, **Account Subscription Services and Charges** screen contains the following fields in a grid:

Field Name	Field Description	Mandatory (Yes or No)
Subscription Charge	Used to indicate charges related to the subscription service.	Yes
Charge Amount	Used to specify the charges related to the subscription charge.	Yes
Charge Start Date	Used to specify the date from when the charges are effective.	Yes
Charge End Date	Used to specify the date till when the charges are effective.	Yes
One-Time Charge	Used to indicate the one-time charges related to the subscription services.	No
Recurring Charge Frequency	Used to indicate the recurring charges paid for the subscription service.	No
	Note: It appears when one-time charge option is selected.	
Automatic Renewal	Used to indicate whether the subscription service charges are set to automatic renewal.	No
Cost Escalation (in Percentage)	Used to specify percentage in which the subscription charge amount must increase when the automatic renewal of the subscription is triggered.	No
	Note: This field gets enabled when Automatic Renewal check box is selected.	
Description on Bill	Used to specify the description on the bill.	No

4. Enter the required details in the **Account Subscription Services and Charges** screen.
5. Click **Save**.

The services and charges are added in the account subscription.

Related Topics

For more information on...	See...
Account Subscription screen	Account Subscription (Used for Viewing) on page 2289
How to edit the subscription service details	Editing the Subscription Service Details on page 2298
How to delete a service from the account subscription	Deleting a Service from the Account Subscription on page 2299

Editing an Account Subscription

Procedure

To edit an account subscription:

1. Search for an account subscription in the **Account Subscription** screen.
2. In the **Search Results** section, click the link in the **Account Subscription Information** column corresponding to an account subscription whose details you want to edit.

The **Account Subscription** screen appears.

3. Click the **Edit** button in the **Account Subscription** zone.

The **Account Subscription** screen appears. It contains the following sections:

- **Main** – Used to specify basic details about the account subscription.
- **Account Subscription Suspension History** – Used to specify the suspension history of the account subscription.
- **Characteristics** – Used to define the characteristics for the account subscription.

The **Main** section contains the following fields:

Field Name	Field Description	Mandatory (Yes or No)
Account Subscription Information	Displays the basic information about the account subscription.	Not applicable
Subscription Type Information	Displays the basic information about the subscription type.	Not applicable
Account Information	Displays the basic information about the account.	Not applicable
Subscription Start Date	Displays the start date of the account subscription.	No
Subscription End Date	Displays the end date of the account subscription.	Yes
Automatic Renewal	Used to indicate whether you want the account subscription to be renewed automatically.	Yes
Comments	Used to specify additional information about the account subscription.	Yes

The **Account Subscription Suspension History** section contains the following columns:

Column Name	Column Description
Suspension Start Date	Used to specify the start date of the account subscription suspension.
Suspension End Date	Used to specify the end date of the account subscription suspension.
Suspension Condition	Used to indicate the condition of the account subscription suspension.
Suspension Reason	Used to indicate the reason of the account subscription suspension.

The **Characteristics** contains the following columns:

Column Name	Column Description
Effective Date	Used to indicate the date from when the characteristic is effective for the account subscription.
Characteristic Type	Used to indicate the characteristic type.
Characteristic Value	Used to specify the value of the characteristic type.

- Define, edit, or remove characteristics of the account subscription, if required.
- Click **Save**.

The changes made to the account subscription are saved.

Related Topics

For more information on...	See...
Account Subscription screen	Account Subscription (Used for Viewing) on page 2289
Search Account Subscription zone	Search Account Subscription on page 2283
How to search for an account subscription	Searching for an Account Subscription on page 2284

Deleting an Account Subscription

Procedure

To delete an account subscription:

- Search for an account subscription in the **Account Subscription** screen.
- In the **Search Results** section, click the link in the **Account Subscription Information** column corresponding to an account subscription whose details you want to delete.

The **Account Subscription** screen appears.

- Click the **Delete** button in the **Account Subscription** zone.

A message appears confirming whether you want to delete an account subscription.

- Click **OK**.

An account subscription is deleted.

Note: You can delete only those account subscriptions whose status is in **Draft** status.

Related Topics

For more information on...	See...
Account Subscription screen	Account Subscription (Used for Viewing) on page 2289
Account Subscription zone	Account Subscription on page 2290

Activating an Account Subscription

Procedure

To activate an account subscription:

- Search for an account subscription in the **Account Subscription** screen.

- In the **Search Results** section, click the link in the **Account Subscription Information** column corresponding to an account subscription whose details you want to edit.

The **Account Subscription** screen appears.

- Click the **Submit** button in the **Account Subscription** zone.

The **Account Subscription** screen gets activated.

Related Topics

For more information on...	See...
Account Subscription screen	Account Subscription (Used for Viewing) on page 2289
Account Subscription zone	Account Subscription on page 2290
How to search for an account subscription	Searching for an Account Subscription on page 2284

Canceling an Account Subscription

Procedure

To cancel an account subscription:

- Search for an account subscription in the **Account Subscription** screen.
- In the **Search Results** section, click the link in the **Account Subscription Information** column corresponding to an account subscription whose details you want to edit.

The **Account Subscription** screen appears.

- Click the **Cancel** button in the **Account Subscription** zone.

A message appears confirming whether you want to cancel an account subscription.

- Click **OK**.

An account subscription is canceled.

Note: You can cancel only those account subscriptions whose status is in **Draft** status.

Related Topics

For more information on...	See...
Account Subscription screen	Account Subscription (Used for Viewing) on page 2289
Account Subscription zone	Account Subscription on page 2290

Editing the Subscription Service Details

Procedure

To edit the subscription service details:

- Search for an account subscription in the **Account Subscription** screen.
- In the **Search Results** section, click the link in the **Account Subscription Information** column corresponding to an account subscription whose details you want to edit.

The **Account Subscription** screen appears.

- Click the **Edit** () icon in the **Subscription Services** zone.

The **Account Subscription Service Charges** screen appears. It contains the following fields:

Field Name	Field Description	Mandatory (Yes or No)
Subscription Service	Displays the type of subscription service.	Not applicable
Service Start Date	Displays the start date of the subscription service.	Not applicable
Service End Date	Used to indicate end date of the subscription service.	Yes
Termination Date	Displays the date on which the subscription service is terminated.	Not applicable
Termination Reason	Displays the reason for which the account subscription is terminated.	Not applicable

In addition, this section contains the following columns:

Column Name	Column Description	Mandatory (Yes or No)
Subscription Charge	Displays the subscription charge.	Not applicable
Charge Amount	Displays the charges related to the of the subscription service.	Not applicable
Charge Start Date	Displays the start date of the subscription charges.	Not applicable
Charge End Date	Used to indicate the end date of the subscription charges.	Yes
One-Time Charge	Displays whether the charges are one-time.	Not applicable
Recurring Charge Frequency	Displays the frequency of the recurring charges, if opted.	Not applicable

4. Click **Save**.

The changes made to the subscription service details are saved.

Related Topics

For more information on...	See...
Account Subscription screen	Account Subscription (Used for Viewing) on page 2289
Subscription Services zone	Subscription Services on page 2292

Deleting a Service from the Account Subscription

Procedure

To delete a service from the account subscription:

1. Search for an account subscription in the **Account Subscription** screen.
2. In the **Search Results** section, click the link in the **Account Subscription Information** column corresponding to an account subscription whose details you want to edit.

The **Account Subscription** screen appears.

3. Click the **Delete** (🗑️) icon in the **Subscription Services** zone.

A message appears confirming whether you want to delete the service from the account subscription.

4. Click **OK**.

A service is deleted from the account subscription.

Note: You cannot delete a service if there is only one service in the account subscription. In such cases, you must delete the account subscription.

Related Topics

For more information on...	See...
Account Subscription screen	Account Subscription (Used for Viewing) on page 2289
Subscription Services zone	Subscription Services on page 2292

Viewing the Charges of a Subscription Service**Procedure**

To view the charges of a subscription service:

1. Search for the account subscription in the **Account Subscription** screen.
2. In the **Search Results** section, click the link in the **Account Subscription Information** column corresponding to the account subscription whose log you want to view.

The **Account Subscription** screen appears.

3. Click the **Broadcast** (📡) icon corresponding to the subscription service whose charges you want to view.

The **Subscription Service Charges** zone appears.

4. View the details in the **Subscription Service Charges** zone.

Related Topics

For more information on...	See...
Account Subscription screen	Account Subscription (Used for Viewing) on page 2289
How to search for an account subscription	Searching for an Account Subscription on page 2284

Viewing Related Entities of a Subscription Service Charge**Procedure**

To view the related entities of a subscription service charge:

1. Search for the account subscription in the **Account Subscription** screen.
2. In the **Search Results** section, click the link in the **Account Subscription Information** column corresponding to the account subscription whose log you want to view.

The **Account Subscription** screen appears.

3. Click the **Broadcast** (📡) icon corresponding to the subscription service whose charges you want to view.

The **Subscription Service Charges** zone appears.

4. Click the **Broadcast** (📡) icon corresponding to the subscription charge whose details you want to view.

The **Subscription Service Charge Entities** zone appears.

5. View the details as required in the **Subscription Service Charge Entities** zone.

Related Topics

For more information on...	See...
Account Subscription screen	Account Subscription (Used for Viewing) on page 2289
Subscription Service Charges zone	Subscription Service Charges on page 2292
Subscription Service Charge Entities zone	Subscription Service Charge Entities on page 2293
How to search for an account subscription	Searching for an Account Subscription on page 2284

Viewing Suspension History of the Account Subscription**Procedure**

To view the suspension history of the account subscription:

1. Search for the account subscription in the **Account Subscription** screen.
2. In the **Search Results** section, click the link in the **Account Subscription Information** column corresponding to the account subscription whose log you want to view.
The **Account Subscription** screen appears.
3. Click the **Broadcast** (📡) icon corresponding to the subscription service whose charges you want to view.
The **Subscription Service Charges** zone appears.
4. Ensure that the **Account Subscription Suspension History** zone is expanded.
5. View the details as required in the **Account Subscription Suspension History** zone.

Related Topics

For more information on...	See...
Account Subscription screen	Account Subscription (Used for Viewing) on page 2289
Subscription Service Charges zone	Subscription Service Charges on page 2292
Subscription Service Charge Entities zone	Subscription Service Charge Entities on page 2293
How to search for an account subscription	Searching for an Account Subscription on page 2284

Viewing Termination Charges of the Account Subscription**Procedure**

To view the termination charges of the account subscription:

1. Search for the account subscription in the **Account Subscription** screen.
2. In the **Search Results** section, click the link in the **Account Subscription Information** column corresponding to the account subscription whose log you want to view.
The **Account Subscription** screen appears.
3. Click the **Broadcast** (📡) icon corresponding to the subscription service whose charges you want to view.

The **Subscription Service Charges** zone appears.

4. Ensure that the **Account Subscription Termination Charges** zone is expanded.
5. View the details as required in the **Account Subscription Termination Charges** zone.

Related Topics

For more information on...	See...
Account Subscription screen	Account Subscription (Used for Viewing) on page 2289
Subscription Service Charges zone	Subscription Service Charges on page 2292
Account Subscription Termination Charges zone	Account Subscription Termination Charges on page 2293
How to search for an account subscription	Searching for an Account Subscription on page 2284

Suspending an Account Subscription

Procedure

To suspend an account subscription:

1. Search for an account subscription in the **Account Subscription** screen.
2. In the **Search Results** section, click the link in the **Account Subscription Information** column corresponding to an account subscription whose details you want to edit.

The **Account Subscription** screen appears.

3. Click the **Suspend** button in the **Account Subscription** zone.

The **Account Subscription Suspension** window appears. It contains the following fields:

Field Name	Field Description	Mandatory (Yes or No)
Suspension Start Date	Used to specify the start date of the account subscription suspension.	Yes
Suspension End Date	Used to specify the end date of the account subscription suspension.	Yes
Suspension Condition	Used to specify the condition of the account subscription suspension.	Yes
Suspension Reason	Used to specify the reason of the account subscription suspension.	Yes

4. Click **Save**.

An account subscription is suspended.

Note: You can suspend only those account subscriptions whose status is in **Active** status.

Related Topics

For more information on...	See...
Account Subscription screen	Account Subscription (Used for Viewing) on page 2289

For more information on...	See...
Account Subscription zone	Account Subscription on page 2290

Terminating an Account Subscription

Procedure

To terminate an account subscription:

1. Search for an account subscription in the **Account Subscription** screen.
2. In the **Search Results** section, click the link in the **Account Subscription Information** column corresponding to an account subscription whose details you want to edit.

The **Account Subscription** screen appears.

3. Click the **Terminate** button in the **Account Subscription zone**.

The **Account Subscription Service Termination** window appears. It contains the following sections:

- **Main**
 - Used to specify basic details about the subscription services.
- **Termination Charges** – Used to specify the charges related to the termination of the account subscription services.

The **Main** section contains the following fields in a grid:

Field Name	Field Description	Mandatory (Yes or No)
Subscription Service	Used to indicate the type of subscription service.	Yes
Termination Date	Used to specify date of the termination subscription service.	Yes
Termination Reason	Used to specify reason of the termination subscription service.	Yes

The **Termination Charges** section contains the following fields in a grid:

Field Name	Field Description	Mandatory (Yes or No)
Termination Charge Type	Used to indicate the type of account subscription termination charges.	Yes
Charge Amount	Used to indicate the charges for the termination of the account subscription.	Yes
Termination Adjustment Type	Used to specify termination adjustment type.	Yes
	Note: The Search (🔍) icon appears corresponding to this field. On clicking the Search icon, the Adjustment Type Search screen appears.	

4. Click **Save**.

An account subscription is terminated.

Note: You can terminate only those account subscriptions whose status is in **Active** or **Suspended** status.

Related Topics

For more information on...	See...
Account Subscription screen	Account Subscription (Used for Viewing) on page 2289
Account Subscription zone	Account Subscription on page 2290

Resuming an Account Subscription

Procedure

To resume an account subscription:

1. Search for an account subscription in the **Account Subscription** screen.
2. In the **Search Results** section, click the link in the **Account Subscription Information** column corresponding to an account subscription whose details you want to edit.

The **Account Subscription** screen appears.

3. Click the **Resume** button in the **Account Subscription** zone.

The **Confirm Resume** window appears.

4. Click **OK**.

An account subscription is resumed.

Note: You can resume only those account subscriptions whose status is in **Suspended** status.

Related Topics

For more information on...	See...
Account Subscription screen	Account Subscription (Used for Viewing) on page 2289
Account Subscription zone	Account Subscription on page 2290

Viewing the Log of an Account Subscription

Procedure

To view the log of an account subscription:

1. Search for the account subscription in the **Account Subscription** screen.
2. In the **Search Results** section, click the link in the **Account Subscription Information** column corresponding to the account subscription whose log you want to view.

The **Account Subscription** screen appears.

3. Click the **Log** tab.

The **Log** tab appears.

4. View the complete trail of actions performed on the account subscription in the **Account Subscription Log** zone.

Related Topics

For more information on...	See...
Account Subscription screen	Account Subscription (Used for Viewing) on page 2289
Account Subscription Log zone	Account Subscription Log on page 2294

For more information on...	See...
How to search for an account subscription	Searching for an Account Subscription on page 2284

Chapter 36

Mass Pricing Update

Topics:

- [Prerequisites](#)
- [Mass Pricing Update Request \(Without Approval\) Status Transition](#)
- [Mass Pricing Update Request \(With Approval\) Status Transition](#)
- [Algorithms Used in C1-MassPricingReq](#)
- [Request Type](#)
- [Mass Pricing Update Request \(Used for Searching\)](#)
- [Mass Pricing Update Request \(Used for Viewing\)](#)
- [Mass Pricing Update Request](#)

Oracle Revenue Management and Billing provides the ability for mass price item pricing update. In other words, the system enables you to update multiple active price item pricing assigned to a person, account, price list, or product at the same time. You can search for the price assignments which you want to update using the following fields:

- Price Item
- Price Item Parameters
- Account ID
- Person ID
- Division
- Update Date
- Pricing Entity Type

On specifying the search criteria, the system fetches the number of entities on which the price item pricing is defined and the number of price assignments on a particular type of pricing entity. Once you select one or more price item pricing, you can create the mass pricing update request by clicking the **Mass Pricing Update** button. While creating a mass pricing update request, you need to specify the mass pricing update request type using which you want to create the mass pricing update request. It is the mass pricing update request type which helps the system to determine:

- The business object using which the mass pricing update request should be created in the system.
- Whether the approval is required for the mass pricing update request.
- Whether the mass pricing update must be performed in the deferred mode when the number of price assignments in the mass pricing update request exceeds the defer processing count.

Once the mass pricing update request type is selected, you need to specify the mass pricing update criteria, mass pricing update type, and rate value. Once a mass pricing update request is created in the **Draft** status, you can submit the mass pricing update request. On submitting a mass pricing update request, the status of the mass pricing update request is changed to either **Deferred Processing** or **Updating Price Assignments** depending on whether the number of price assignments in the mass pricing update request exceeds the defer processing count. If the status is changed to **Deferred Processing**, you need to click the **Submit Batch** button. On clicking the **Submit Batch** button, the system automatically creates a batch job using the **C1-GENRQ** batch control. While creating the batch job, it uses the values defined for the **Thread Count** and **Thread Pool Name** option types in the **C1-MASPRI** feature configuration.

Once the batch job is executed, the status of the mass pricing update request is changed to **Updating Price Assignments**. If a price assignment is referred in past, the existing price assignment is end dated and a new price assignment is created. However, if a price assignment is not yet referred in the system, the existing price assignment is updated. Once the price assignment is newly created or updated, the status of the record in the mass pricing update request is changed to **Processed**. However, if a price assignment is referred for a future date, the status of the record in the mass pricing update request is changed to **Error**. In addition, if any error occurs while updating an existing price assignment or creating a new price assignment, the status of the record in the mass pricing update request is changed to Error. Finally, the status of the mass pricing update request is changed to **Processed**.

You can optionally configure the approval workflow for the mass pricing update request. If the **Approval Required** field is set to **Yes** in the mass pricing update request type, the status of the mass pricing update request is changed to **Approval In Progress** when you submit the mass pricing update request. Once the approver approves the mass pricing update request, the status of the mass pricing update request is changed to either **Deferred Processing** or **Updating Price Assignments** depending on whether the number of price assignments in the mass pricing update request exceeds the defer processing count. However, if the approver rejects a mass pricing update request, the status of the mass pricing update request is changed to **Rejected**.

For more information on how to setup the mass pricing update process, see [Prerequisites](#) on page 2309.

Prerequisites

To setup the mass pricing update feature, you need to do the following:

- Define the required mass pricing update request types in the system.
- Set the **Mass Pricing Update (C1-MASPRI)** feature configuration
- Attach a currency conversion algorithm to the **Currency Conversion For Bill Segments** algorithm spot of the required divisions
- Define one To Do type for submitter and another To Do type for approver when the approval is required for a mass pricing update request
- Assign a To Do role to the required To Do types in the application

Related Topics

For more information on...	See...
How to setup the C1-MASPRI feature configuration	Setting the C1_MASPRI Feature Configuration on page 4331

Mass Pricing Update Request (Without Approval) Status Transition

The following figure graphically indicates how a mass pricing update request moves from one status to another when approval workflow is off:

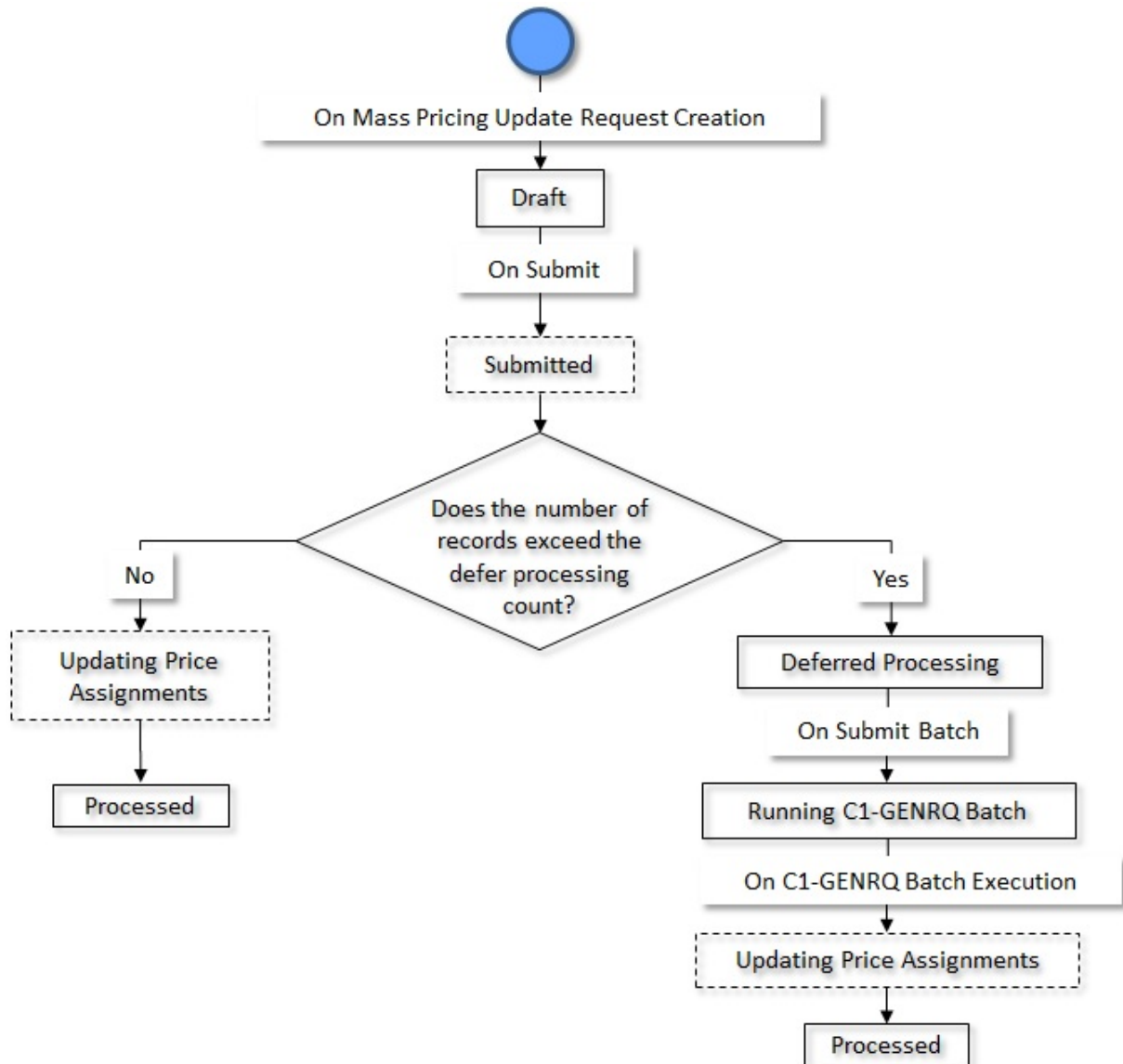

Mass Pricing Update Request (With Approval) Status Transition

The following figure graphically indicates how a mass pricing update request moves from one status to another when approval workflow is on:

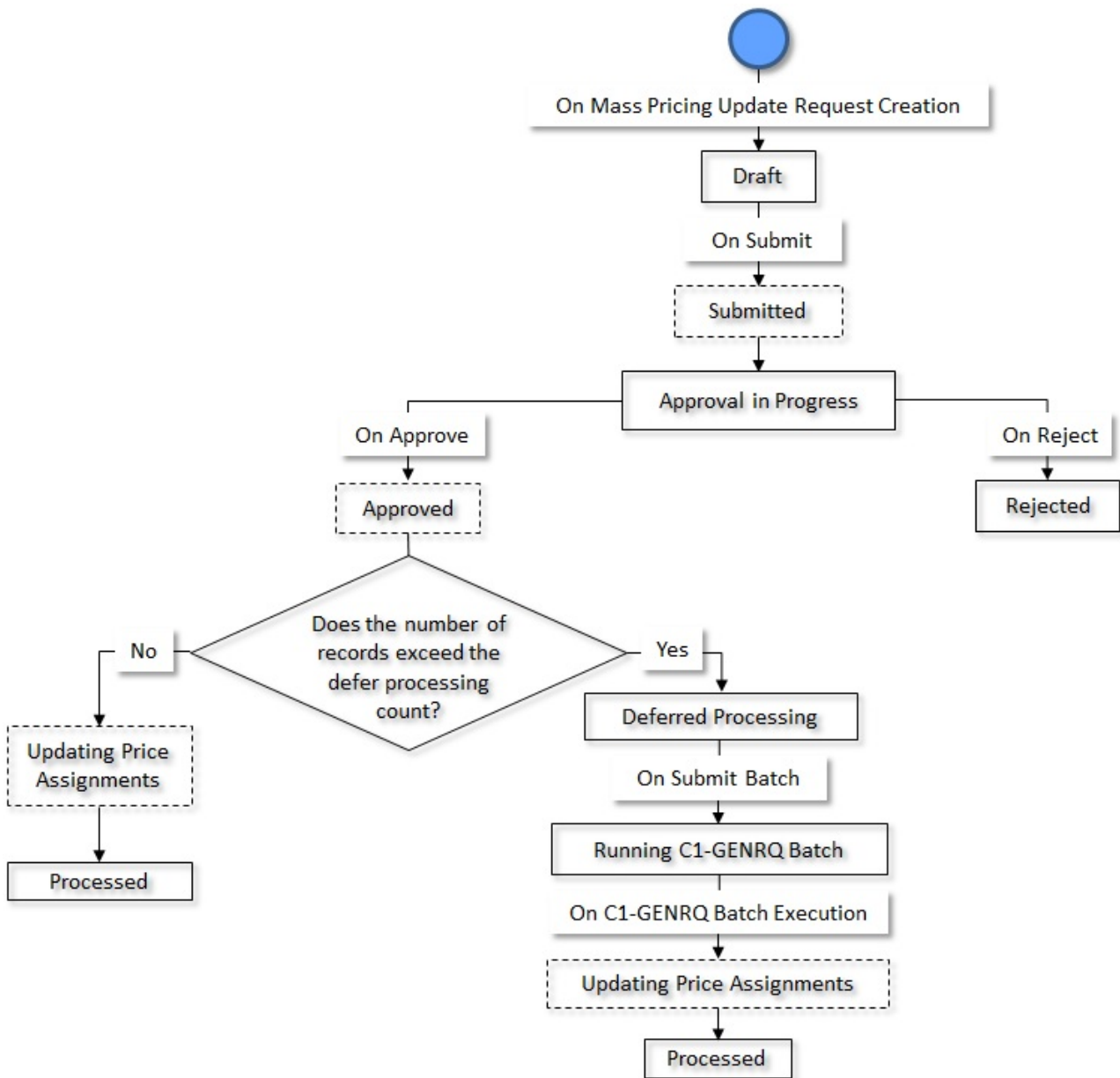

Algorithms Used in C1-MassPricingReq

The following table lists the algorithms which are attached to the **C1-MassPricingReq** business object:

System Event	Algorithm	Algorithm Type	Description
Information	C1-REQST-INF	C1-REQST-INF	Refer to C1-REQST-INF on page 2312
Validation	C1-MPRIVALDN	C1-MPRIVALDN	Refer to C1-MPRIVALDN on page 2312

The following table lists the algorithms which are used in the lifecycle of the **C1-MassPricingReq** business object:

Status	System Event	Algorithm	Algorithm Type	Description
Draft	-	-	-	-
Submitted	Enter	C1-MPRISUBMT	C1-MPRISUBMT	Refer to C1-MPRISUBMT on page 2312
Approval Progress in	Enter	C1-MPRIAPTD	C1-MPRIAPTD	Refer to C1-MPRIAPTD on page 2313
Approval Progress in	Exit	F1-TODOCOMPL	F1-TODOCOMPL	Refer to F1-TODOCOMPL on page 1453
Running C1-GENRQ Batch	Monitor	F1-AT-RQJ	F1-GEN-BOMNJ	Refer to F1-AT-RQJ on page 1560
Running C1-GENRQ Batch	Enter	C1-MPRIDEFER	C1-MPRIDEFER	Refer to C1-MPRIDEFER on page 2313
Deferred Processing	-	-	-	-
Approved	Enter	C1-MPRIAPRD	C1-MPRIAPRD	Refer to C1-MPRIAPRD on page 2313
Updating Price Assignments	Monitor	F1-AT-RQJ	F1-GEN-BOMNJ	Refer to F1-AT-RQJ on page 1560
Updating Price Assignments	Enter	C1-MPRIUPDPA	C1-MPRIUPDPA	Refer to C1-MPRIUPDPA on page 2313
Processed	-	-	-	-
Rejected	Enter	C1-MPRIRJTD	C1-MPRIRJTD	Refer to C1-MPRIRJTD on page 2314

C1-REQST-INF

This algorithm generates the request information string which appears throughout the application. It concatenates the following fields separated by a comma in the specified order:

1. Request Type Description
2. Request Status
3. Request ID

C1-MPRIVALDN

This algorithm is invoked when you create a mass pricing update request. It checks the following:

- Whether the mass pricing update criteria is specified.
- Whether the mass pricing update type is specified when the mass pricing update criteria is set to **Increase Price** or **Decrease Price**.
- Whether the rate value is specified when the mass pricing update criteria is set to **Increase Price** or **Decrease Price**.
- Whether the currency is specified when the mass pricing update criteria is set to **Increase Price** or **Decrease Price** and the mass pricing update type is set to **Absolute**.
- If any of the above conditions are not met, the system does not allow you to create the mass pricing update request.

C1-MPRISUBMT

This algorithm is invoked when you submit a mass pricing update request. If the approval workflow is configured on the respective mass pricing update request type, it changes the status of the mass pricing update request to **Approval in Progress**. However, if the approval workflow is not configured on the respective mass pricing update request type, it changes the status of the mass pricing update request to either **Deferred Processing** or **Updating Price Assignments** depending on whether the number of price assignments in the mass pricing update request exceeds the defer processing count.

C1-MPRIAPTD

This algorithm is invoked when the status of the mass pricing update request is changed to **Approval in Progress**. It creates a To Do using the approval To Do type which is specified in the respective mass pricing update request type. Once a To Do is created, it is assigned to all users with an approval To Do role which is specified in the respective mass pricing update request type.

F1-TODOCOMPL

This algorithm type completes the To Do entries that are linked to an object when the object exits the given status.

It finds and completes all open To Do entries where the business object's primary key is defined as a drill key. However, if the **Exclude To Do Entries From Auto Completion** characteristic is set to **Y** for the business object, the system does not automatically complete the respective To Do entry.

F1-AT-RQJ

This algorithm transitions the current status of the business object to the specified status. It contains the following parameters:

- **Next Status** – Used when you want to override the default next status specified in the lifecycle.
- **Next Transition Condition** – Used when you want to override the default next transition condition specified in the lifecycle.

At a time, you can specify value for either the **Next Status** or **Next Transition Condition** parameter. If you don't specify any value for these parameters, the system will transition the business object to the default next status specified in its lifecycle.

C1-MPRIDEFER

This algorithm is invoked when the status of the mass pricing update request is changed to **Running C1-GENRQ Batch**. It creates a batch job using the **C1-GENRQ** batch control. While creating the batch job, it uses the values defined in the **Thread Count** and **Thread Pool Name** option types of the **Mass Pricing Update (C1-MASPRI)** feature configuration. It also creates a log for the mass pricing update request which indicates the batch job ID.

C1-MPRIAPRD

This algorithm is invoked when you approve a mass pricing update request. If the number of price assignments in the mass pricing update request exceeds the defer processing count, the status of the mass pricing update request is changed to **Deferred Processing**. However, if the number of price assignments in the mass pricing update request does not exceed the defer processing count, the status of the mass pricing update request is changed to **Updating Price Assignments**.

C1-MPRIUPDPA

This algorithm is invoked when the status of the mass pricing update request is changed to **Updating Price Assignments**. If a price assignment is referred in past, this algorithm ends the existing price assignment and creates a new price assignment. However, if a price assignment is not yet referred in the system, this algorithm updates the existing price assignment. Once the price assignment is newly created or updated, the status of the record in the mass pricing update request is changed to **Processed**. However, if a price assignment is referred for a future date, the status of the record in the mass pricing update request is changed to **Error**. In addition, if any error occurs while updating an existing price assignment or creating a new price assignment, the status of the record in the mass pricing update request is changed

to **Error**. Note that if a price assignment is included multiple times in a mass pricing update request, the system will update the price assignment only once.

C1-MPRIRJTD

This algorithm is invoked when the status of the mass pricing update request is changed to **Rejected**. It creates a To Do using the submitter To Do type which is specified in the respective mass pricing update request type. Once a To Do is created, it is assigned to all users with a submitter To Do role which is specified in the respective mass pricing update request type.

Request Type

Oracle Revenue Management and Billing allows you to define a mass pricing update request type using which you can create mass pricing update requests. It is the mass pricing request type which helps the system to determine:

- The business object using which the mass pricing update request should be created in the system.
- Whether the approval is required for the mass pricing update request.
- Whether the mass pricing update must be performed in the deferred mode when the number of price assignments in the mass pricing update request exceeds the defer processing count.

The **Request Type** screen allows you to define, edit, copy, and delete a mass pricing update request type. It contains the following zones:

- [Request Type List](#) on page 2314
- [Request Type](#) on page 2315

Request Type List

The **Request Type List** zone lists the mass pricing update request types that are already defined in the system. It contains the following columns:

Column Name	Column Description
Request Type	Displays the mass pricing update request type.
Description	Displays the description of the mass pricing update request type.
Edit	On clicking the Edit (✎) icon, the Mass Pricing Request Type screen appears where you can edit the details of the mass pricing update request type.
Duplicate	On clicking the Duplicate (📄) icon, the Mass Pricing Request Type screen appears where you can define a new mass pricing update request type using an existing mass pricing update request type.
Delete	On clicking the Delete (🗑) icon, you can delete the mass pricing update request type. Note: You can delete the mass pricing update request type when you have not created a mass pricing update request using the mass pricing update request type.

On clicking the **Broadcast** (📡) icon corresponding to a mass pricing update request type, the **Request Type** zone appears with the details of the respective mass pricing update request type.

You can define a new mass pricing update request type by clicking the **Addlink** in the upper right corner of the **Request Type List** zone.

Related Topics

For more information on...	See...
How to edit a mass pricing update request type	Editing a Mass Pricing Update Request Type on page 2320
How to copy a mass pricing update request type	Copying a Mass Pricing Update Request Type on page 2323
How to delete a mass pricing update request type	Deleting a Mass Pricing Update Request Type on page 2326
How to view the details of a mass pricing update request type	Viewing the Mass Pricing Update Request Type Details on page 2327

Request Type

The **Request Type** zone displays the details of the mass pricing update request type. It contains the following sections:

- **Main** - Displays the basic information about the mass pricing update request type. It contains the following fields:

Field Name	Field Description
Request Type	Displays the mass pricing update request type.
Request Business Object	Indicates the business object using which you want to create a mass pricing update request. In addition, a context menu appears corresponding to this field which helps in navigating to other screens in the application. Note: It has a link. On clicking the link, the Business Object screen appears where you can view the details of the respective business object.
Description	Displays the description for the mass pricing update request type.
Detailed Description	Displays the additional information about the mass pricing update request type.
Status	Indicates the status of the mass pricing update request type. The valid values are: <ul style="list-style-type: none"> • Active • Inactive
Defer Processing Count	Indicates whether the price item pricing should be updated in the deferred mode (i.e. in the background) when the number of price assignments in a mass pricing update request exceeds the defer processing count. Note: Deferred mode means in the background when the Generic Request Periodic Monitor (C1-GENRQ) batch is invoked. You can configure the Generic Request Periodic Monitor (C1-GENRQ) batch such that it is executed at regular intervals. For more information about the Generic Request Periodic Monitor (C1-GENRQ) batch, refer to <i>Oracle Revenue Management and Billing Batch Guide</i> . If the number of price assignments in a mass pricing update request does not exceed the defer processing count, the system will process the mass pricing update request in real time (i.e. immediately).
Approval Required	Indicates whether approval is required before updating the price item pricing through a mass pricing update request.
Approval Type	Indicates the type of approval. The valid value is:

Field Name	Field Description
	<ul style="list-style-type: none"> Request Level Approval
Approval To Do Type	<p>Indicates that To Do entry of the specified To Do type must be created when you submit the mass pricing update request for approval.</p> <p>Note: This field appears when the Approval Required option is selected. It has a link. On clicking the link, the To Do Type screen appears where you can view the details of respective To Do type.</p>
Approval To Do Role	<p>Indicates that the users with the specified To Do role will receive the mass pricing update request when it is submitted for approval.</p> <p>Note: This field appears when the Approval Required option is selected. It has a link. On clicking the link, the To Do Role screen appears where you can view the details of respective To Do role.</p>
Submitter To Do Type	<p>Indicates that To Do entry of the specified To Do type must be created when an approver rejects a mass pricing update request.</p> <p>Note: This field appears when the Approval Required option is selected. It has a link. On clicking the link, the To Do Type screen appears where you can view the details of respective To Do type.</p>
Submitter To Do Role	<p>Indicates that the users with the specified To Do role will receive the mass pricing update request when it is rejected by an approver.</p> <p>Note: This field appears when the Approval Required option is selected. It has a link. On clicking the link, the To Do Role screen appears where you can view the details of respective To Do role.</p>

- Record Actions** - This section contains the following buttons:

Button Name	Button Description
Edit	Used to edit the details of the mass pricing update request type.
Delete	Used to delete the mass pricing update request type. Note: You can delete a mass pricing update request type when you have not created a mass pricing update request using the mass pricing update request type.
Duplicate	Used to create a new mass pricing update request type using an existing mass pricing update request type.

- Record Information** - This section contains the following field:

Field Name	Field Description
Business Object	Indicates the business object using which the mass pricing update request type is created. In addition, a context menu appears corresponding to this field which helps in navigating to other screens in the application.
	Note: It has a link. On clicking the link, the Business Object screen appears where you can view the details of the respective business object.

By default, the **Request Type** zone does not appear in the **Request Type** screen. It appears when you click the **Broadcast** (📡) icon corresponding to a mass pricing update request type in the **Request Type List** zone.

You can define a new mass pricing update request type by clicking the **Add** link in the upper right corner of this zone.

Related Topics

For more information on...	See...
How to edit a mass pricing update request type	Editing a Mass Pricing Update Request Type on page 2320
How to copy a mass pricing update request type	Copying a Mass Pricing Update Request Type on page 2323
How to delete a mass pricing update request type	Deleting a Mass Pricing Update Request Type on page 2326
How to view the details of a mass pricing update request type	Viewing the Mass Pricing Update Request Type Details on page 2327

Defining a Mass Pricing Update Request Type

Prerequisites

To define a mass pricing update request type, you should have:

- Mass pricing update request type business objects defined in the application.
- Mass pricing update request business objects defined in the application.
- One To Do type defined for submitter and another To Do type defined for approver when the approval is required for a mass pricing update request
- A To Do role assigned to the required To Do types in the application

Procedure

To define a mass pricing update request type:

1. Click the **Admin** link in the **Application** toolbar.
A list appears.
2. From the **Admin** menu, select **R** and then click **Request Type**.
A sub-menu appears.
3. Click the **Add** option from the **Request Type** sub-menu.

The **Select Business Object** screen appears. It contains the following field:

Field Name	Field Description	Mandatory (Yes or No)
Request Type Business Object	Used to indicate the business object using which you want to create the mass pricing update request type.	Yes

Field Name	Field Description	Mandatory (Yes or No)
	Note: You can create a mass pricing update request type using the Mass Pricing Request Type (C1-MassPricingReqType) business object.	

Note: Alternatively, you can access this screen by clicking the **Add** link in the upper right corner of the **Request Type List** zone.

4. Select the **Mass Pricing Request Type** business object from the respective field.
5. Click **OK**.

The **Mass Pricing Update Request Type** screen appears. It contains the following section:

- **Main** - Used to specify basic details about the mass pricing update request type. It contains the following fields:

Field Name	Field Description	Mandatory (Yes or No)
Request Type	Used to specify the mass pricing update request type.	Yes
Business Object	Indicates the business object using which you are defining the mass pricing update request type.	Not applicable
Request Business Object	Used to indicate the business object using which you want to create a mass pricing update request. The valid value is: <ul style="list-style-type: none"> • Mass Pricing Request 	Yes
Description	Used to specify the description for the mass pricing update request type.	Yes
Detailed Description	Used to specify the additional information about the mass pricing update request type.	No
Status	Used to indicate the status of the mass pricing update request type. The valid values are: <ul style="list-style-type: none"> • Active • Inactive 	Yes
Defer Processing Count	Used to indicate whether the price item pricing should be updated in the deferred mode (i.e. in the background) when the number of price assignments in a mass pricing update request exceeds the defer processing count.	No

Field Name	Field Description	Mandatory (Yes or No)
	<p>Note:</p> <p>Deferred mode means in the background when the Generic Request Periodic Monitor (C1-GENRQ) batch is invoked. You can configure the Generic Request Periodic Monitor (C1-GENRQ) batch such that it is executed at regular intervals. For more information about the Generic Request Periodic Monitor (C1-GENRQ) batch, refer to <i>Oracle Revenue Management and Billing Batch Guide</i>.</p> <p>If the number of price assignments in a mass pricing update request does not exceed the defer processing count, the system will process the mass pricing update request in real time (i.e. immediately).</p>	
Approval Required	Used to indicate whether approval is required before updating the price item pricing through a mass pricing update request.	No
Approval Type	<p>Used to indicate the type of approval. The valid value is:</p> <ul style="list-style-type: none"> Request Level Approval <p>Note: This field appears when the Approval Required option is selected.</p>	<p>Yes (Conditional)</p> <p>Note: This field is required when the Approval Required option is selected.</p>
Approval To Do Type	<p>Used to indicate that To Do entry of the specified To Do type must be created when you submit the mass pricing update request for approval.</p> <p>Note:</p> <p>The Search  icon appears corresponding to this field. On clicking the Search icon, the To Do Type Search window appears.</p> <p>The Approval To Do Type field appears when the Approval Required option is selected.</p>	<p>Yes (Conditional)</p> <p>Note: This field is required when the Approval Required option is selected.</p>
Approval To Do Role	Used to indicate that the users with the specified To Do role must receive the mass pricing update request for approval.	<p>Yes (Conditional)</p> <p>Note: This field is required when the Approval Required option is selected.</p>

Field Name	Field Description	Mandatory (Yes or No)
	<p>Note:</p> <p>This field appears when the Approval Required option is selected.</p> <p>The list includes only those To Do roles which are associated to the specified approval To Do type.</p>	
Submitter To Do Type	Used to indicate that To Do entry of the specified To Do type must be created when the approver rejects the mass pricing update request.	Yes (Conditional)
	<p>Note:</p> <p>The Search  icon appears corresponding to this field. On clicking the Search icon, the To Do Type Search window appears.</p> <p>The Submitter To Do Type field appears when the Approval Required option is selected.</p>	<p>Note: This field is required when the Approval Required option is selected.</p>
Submitter To Do Role	Used to indicate that the users with the specified To Do role must receive a To Do when the approver rejects the mass pricing update request.	Yes (Conditional)
	<p>Note:</p> <p>This field appears when the Approval Required option is selected.</p> <p>The list includes only those To Do roles which are associated to the specified submitter To Do type.</p>	<p>Note: This field is required when the Approval Required option is selected.</p>

6. Enter the required details in the **Main** section.

7. Click **Save**.

The mass pricing update request type is defined.

Related Topics

For more information on...	See...
Request Type screen	Request Type on page 2314
Request Type List zone	Request Type List on page 2314

Editing a Mass Pricing Update Request Type

Prerequisites

To edit a mass pricing update request type, you should have:

- Mass pricing update request business objects defined in the application.

Procedure

To edit a mass pricing update request type:

1. Click the **Admin** link in the **Application** toolbar.
A list appears.
2. From the **Admin** menu, select **R** and then click **Request Type**.
A sub-menu appears.
3. Click the **Search** option from the **Request Type** sub-menu.
The **Request Type** screen appears.
4. In the **Request Type List** zone, click the **Edit** () icon in the **Edit** column corresponding to the mass pricing update request type whose details you want to edit.

The **Mass Pricing Update Request Type** screen appears. It contains the following section:

- **Main** - Used to specify basic details about the mass pricing update request type. It contains the following fields:

Field Name	Field Description	Mandatory (Yes or No)
Request Type	Used to specify the mass pricing update request type.	Yes
Business Object	Indicates the business object using which you are defining the mass pricing update request type.	Not applicable
Request Business Object	Used to indicate the business object using which you want to create a mass pricing update request. The valid value is: <ul style="list-style-type: none"> • Mass Pricing Request 	Yes
Description	Used to specify the description for the mass pricing update request type.	Yes
Detailed Description	Used to specify the additional information about the mass pricing update request type.	No
Status	Used to indicate the status of the mass pricing update request type. The valid values are: <ul style="list-style-type: none"> • Active • Inactive 	Yes
Defer Processing Count	Used to indicate whether the price item pricing should be updated in the deferred mode (i.e. in the background) when the number of price assignments in a mass pricing update request exceeds the defer processing count.	No

Field Name	Field Description	Mandatory (Yes or No)
	<p>Note:</p> <p>Deferred mode means in the background when the Generic Request Periodic Monitor (C1-GENRQ) batch is invoked. You can configure the Generic Request Periodic Monitor (C1-GENRQ) batch such that it is executed at regular intervals. For more information about the Generic Request Periodic Monitor (C1-GENRQ) batch, refer to <i>Oracle Revenue Management and Billing Batch Guide</i>.</p> <p>If the number of price assignments in a mass pricing update request does not exceed the defer processing count, the system will process the mass pricing update request in real time (i.e. immediately).</p>	
Approval Required	Indicates whether approval is required before updating the price item pricing through a mass pricing update request.	No
Approval Type	<p>Indicates the type of approval. The valid value is:</p> <ul style="list-style-type: none"> Request Level Approval <p>Note: This field appears when the Approval Required option is selected.</p>	<p>Yes (Conditional)</p> <p>Note: This field is required when the Approval Required option is selected.</p>
Approval To Do Type	<p>Indicates that To Do entry of the specified To Do type must be created when you submit the mass pricing update request for approval.</p> <p>Note:</p> <p>The Search  icon appears corresponding to this field. On clicking the Search icon, the To Do Type Search window appears.</p> <p>The Approval To Do Type field appears when the Approval Required option is selected.</p>	<p>Yes (Conditional)</p> <p>Note: This field is required when the Approval Required option is selected.</p>
Approval To Do Role	<p>Indicates that the users with the specified To Do role must receive the mass pricing update request for approval.</p> <p>Note:</p> <p>This field appears when the Approval Required option is selected.</p> <p>The list includes only those To Do roles which are associated to the specified approval To Do type.</p>	<p>Yes (Conditional)</p> <p>Note: This field is required when the Approval Required option is selected.</p>

Field Name	Field Description	Mandatory (Yes or No)
Submitter To Do Type	Indicates that To Do entry of the specified To Do type must be created when the approver rejects the mass pricing update request.	Yes (Conditional) Note: This field is required when the Approval Required option is selected.
	Note: The Search  icon appears corresponding to this field. On clicking the Search icon, the To Do Type Search window appears. The Submitter To Do Type field appears when the Approval Required option is selected.	
Submitter To Do Role	Indicates that the users with the specified To Do role must receive a To Do when the approver rejects the mass pricing update request.	Yes (Conditional) Note: This field is required when the Approval Required option is selected.
	Note: This field appears when the Approval Required option is selected. The list includes only those To Do roles which are associated to the specified submitter To Do type.	

Tip: Alternatively, you can edit the details of a mass pricing update request type by clicking the **Edit** button in the **Request Type** zone.

5. Modify the required details in the **Main** section.
6. Click **Save**.

The changes made to the mass pricing update request type are saved.

Related Topics

For more information on...	See...
Request Type screen	Request Type on page 2314
Request Type List zone	Request Type List on page 2314
Request Type zone	Request Type on page 2315

Copying a Mass Pricing Update Request Type

Instead of creating a mass pricing update request type from scratch, you can create a new mass pricing update request type using an existing mass pricing update request type. This is possible through copying a mass pricing update request type. On copying a mass pricing update request type, the details including the characteristics are copied to the new mass pricing update request type. You can then edit the details, if required.

Prerequisites

To copy a mass pricing update request type, you should have:

- Mass pricing update request type (whose copy you want to create) defined in the application.

- Mass pricing update request business objects defined in the application.

Procedure

To copy a mass pricing update request type:

1. Click the **Admin** link in the **Application** toolbar.

A list appears.

2. From the **Admin** menu, select **R** and then click **Request Type**.

A sub-menu appears.

3. Click the **Search** option from the **Request Type** sub-menu.

The **Request Type** screen appears.

4. In the **Request Type List** zone, click the **Duplicate** () icon in the **Duplicate** column corresponding to the request type whose copy you want to create.

The **Mass Pricing Update Request Type** screen appears. It contains the following section:

- **Main** - Used to specify basic details about the mass pricing update request type. It contains the following fields:

Field Name	Field Description	Mandatory (Yes or No)
Request Type	Used to specify the mass pricing update request type.	Yes
Business Object	Indicates the business object using which you are defining the mass pricing update request type.	Not applicable
Request Business Object	Used to indicate the business object using which you want to create a mass pricing update request. The valid value is: <ul style="list-style-type: none"> • Mass Pricing Request 	Yes
Description	Used to specify the description for the mass pricing update request type.	Yes
Detailed Description	Used to specify the additional information about the mass pricing update request type.	No
Status	Used to indicate the status of the mass pricing update request type. The valid values are: <ul style="list-style-type: none"> • Active • Inactive 	Yes
Defer Processing Count	Used to indicate whether the price item pricing should be updated in the deferred mode (i.e. in the background) when the number of price assignments in a mass pricing update request exceeds the defer processing count.	No

Field Name	Field Description	Mandatory (Yes or No)
	<p>Note:</p> <p>Deferred mode means in the background when the Generic Request Periodic Monitor (C1-GENRQ) batch is invoked. You can configure the Generic Request Periodic Monitor (C1-GENRQ) batch such that it is executed at regular intervals. For more information about the Generic Request Periodic Monitor (C1-GENRQ) batch, refer to <i>Oracle Revenue Management and Billing Batch Guide</i>.</p> <p>If the number of price assignments in a mass pricing update request does not exceed the defer processing count, the system will process the mass pricing update request in real time (i.e. immediately).</p>	
Approval Required	Used to indicate whether approval is required before updating the price item pricing through a mass pricing update request.	No
Approval Type	<p>Used to indicate the type of approval. The valid value is:</p> <ul style="list-style-type: none"> • Request Level Approval <p>Note: This field appears when the Approval Required option is selected.</p>	<p>Yes (Conditional)</p> <p>Note: This field is required when the Approval Required option is selected.</p>
Approval To Do Type	<p>Used to indicate that To Do entry of the specified To Do type must be created when you submit the mass pricing update request for approval.</p> <p>Note:</p> <p>The Search (🔍) icon appears corresponding to this field. On clicking the Search icon, the To Do Type Search window appears.</p> <p>The Approval To Do Type field appears when the Approval Required option is selected.</p>	<p>Yes (Conditional)</p> <p>Note: This field is required when the Approval Required option is selected.</p>
Approval To Do Role	<p>Used to indicate that the users with the specified To Do role must receive the mass pricing update request for approval.</p> <p>Note:</p> <p>This field appears when the Approval Required option is selected.</p> <p>The list includes only those To Do roles which are associated to the specified approval To Do type.</p>	<p>Yes (Conditional)</p> <p>Note: This field is required when the Approval Required option is selected.</p>

Field Name	Field Description	Mandatory (Yes or No)
Submitter To Do Type	Used to indicate that To Do entry of the specified To Do type must be created when the approver rejects the mass pricing update request.	Yes (Conditional) Note: This field is required when the Approval Required option is selected.
	Note: The Search (🔍) icon appears corresponding to this field. On clicking the Search icon, the To Do Type Search window appears. The Submitter To Do Type field appears when the Approval Required option is selected.	
Submitter To Do Role	Used to indicate that the users with the specified To Do role must receive a To Do when the approver rejects the mass pricing update request.	Yes (Conditional) Note: This field is required when the Approval Required option is selected.
	Note: This field appears when the Approval Required option is selected. The list includes only those To Do roles which are associated to the specified submitter To Do type.	

Tip: Alternatively, you can copy a mass pricing update request type by clicking the **Duplicate** button in the **Request Type** zone.

- Enter the required details in the **Main** section.
- Click **Save**.

The new mass pricing update request type is defined.

Related Topics

For more information on...	See...
Request Type screen	Request Type on page 2314
Request Type List zone	Request Type List on page 2314
Request Type zone	Request Type on page 2315

Deleting a Mass Pricing Update Request Type

Procedure

To delete a mass pricing update request type:

- Click the **Admin** link in the **Application** toolbar.
A list appears.
- From the **Admin** menu, select **R** and then click **Request Type**.
A sub-menu appears.
- Click the **Search** option from the **Request Type** sub-menu.

The **Request Type** screen appears.

- In the **Request Type List** zone, click the **Delete** (🗑️) icon in the **Delete** column corresponding to the mass pricing update request type that you want to delete.

A message appears confirming whether you want to delete the mass pricing update request type.

Note: You can delete a mass pricing update request type when you have not created a mass pricing update request using the mass pricing update request type.

Tip: Alternatively, you can delete a mass pricing update request type by clicking the **Delete** button in the **Request Type** zone.

- Click **OK**.

The mass pricing update request type is deleted.

Related Topics

For more information on...	See...
Request Type screen	Request Type on page 2314
Request Type List zone	Request Type List on page 2314
Request Type zone	Request Type on page 2315

Viewing the Mass Pricing Update Request Type Details

Procedure

To view the details of a mass pricing update request type:

- Click the **Admin** link in the **Application** toolbar.
A list appears.
- From the **Admin** menu, select **R** and then click **Request Type**.
A sub-menu appears.
- Click the **Search** option from the **Request Type** sub-menu.
The **Request Type** screen appears.
- In the **Request Type List** zone, click the **Broadcast** (📡) icon corresponding to the mass pricing update request type whose details you want to view.
The **Request Type** zone appears.
- View the details of the mass pricing update request type in the **Request Type** zone.

Related Topics

For more information on...	See...
Request Type screen	Request Type on page 2314
Request Type List zone	Request Type List on page 2314
Request Type zone	Request Type on page 2315

Mass Pricing Update Request (Used for Searching)

The **Mass Pricing Update Request** screen allows you to search for a mass pricing update request using various search criteria. It contains the following zone:

- [Search Mass Pricing Update Request](#) on page 2328

Related Topics

For more information on...	See...
How to search for a mass pricing update request	Searching for a Mass Pricing Update Request on page 2329
How to view the details of a mass pricing update request	Viewing the Mass Pricing Update Request Type Details on page 2330
How to create a mass pricing update request	Creating a Mass Pricing Update Request on page 2330

Search Mass Pricing Update Request

The **Search Mass Pricing Update Request** zone allows you to search for a mass pricing update request using various search criteria. It contains the following two sections:

- **Search Criteria** - The **Search Criteria** section contains the following fields:

Field Name	Field Description	Mandatory (Yes or No)
Created From	Used to search mass pricing update requests which are created from a particular date onwards.	No
Status	Used to search mass pricing update requests with a particular status. The valid values are: <ul style="list-style-type: none"> • Approval in Progress • Deferred Processing • Draft • Processed • Rejected • Running C1-GENRQ Batch 	No
Created Until	Used to search mass pricing update requests which are created till a particular date.	No
User ID	Used to search mass pricing update requests which are created by a particular user.	No
Request Type	Used to search mass pricing update requests which are created using a particular mass pricing update request type.	No
Request ID	Used to search a particular mass pricing update request.	No

Note: You must specify at least one search criterion while searching a mass pricing update request.

- **Search Result** - On clicking the **Search** button, the search results appear based on the specified search criteria. The **Search Result** section contains the following columns:

Column Name	Column Description
Creation Date Time	Displays the date and time when the mass pricing update request is created.
Request Information	Displays information about the mass pricing update request. Note: It has a link. On clicking the link, the Mass Pricing Update Request screen appears where you can view the details of the respective mass pricing update request.
Status	Indicates the status of the mass pricing update request. The valid values are: <ul style="list-style-type: none"> • Approval in Progress • Deferred Processing • Draft • Processed • Rejected • Running C1-GENRQ Batch
Created By	Indicates the user who has created the mass pricing update request.

Note: Pagination is used to display limited number of records in the **Search Results** section. You can use the navigation links, such as **Previous** and **Next** to navigate between pages.

Related Topics

For more information on...	See...
How to search for a mass pricing update request	Searching for a Mass Pricing Update Request on page 2329
How to view the details of a mass pricing update request	Viewing the Mass Pricing Update Request Type Details on page 2330
How to create a mass pricing update request	Creating a Mass Pricing Update Request on page 2330

Searching for a Mass Pricing Update Request

Prerequisites

To search for a mass pricing update request, you should have:

- Mass pricing update request types defined in the application

Procedure

To search for a mass pricing update request:

1. Click the **Menu** link in the **Application** toolbar.
A list appears.
2. From the **Main** menu, select **Pricing Management** and then click **Mass Pricing Update Request**.

A sub-menu appears.

3. Click the **Search** option from the **Mass Pricing Update Request** sub-menu.

The **Mass Pricing Update Request** screen appears.

4. Enter the search criteria in the **Search Mass Pricing Update Request** zone.

Note: ORMB search engine supports wildcard search, where you can substitute the percentage (%) symbol as a stand in for any word or letter in a search criteria. You can use the ‘%’ wildcard character in all input fields except the date and ID fields. The ‘%’ wildcard character is suffixed automatically at the end of the partial search criteria. Therefore, you may or may not specify the wildcard character at the end of the partial search criteria. However, you have to prefix the wildcard character manually wherever required.

5. Click **Search**.

A list of mass pricing update requests that meet the search criteria appears in the **Search Results** section.

Related Topics

For more information on...	See...
Mass Pricing Update Request screen	Mass Pricing Update Request (Used for Searching) on page 2327
Search Mass Pricing Update Request zone	Search Mass Pricing Update Request on page 2328

Viewing the Mass Pricing Update Request Type Details

Procedure

To view the details of a mass pricing update request:

1. Search for the mass pricing update request in the **Mass Pricing Update Request** screen.
2. In the **Search Results** section, click the link in the **Request Information** column corresponding to the mass pricing update request whose details you want to view.

The **Mass Pricing Update Request** screen appears.

3. Ensure that the **Main** tab is selected.
4. View the details of the mass pricing update request in the **Mass Pricing Update Request** zone.
5. View the list of price assignments which are included in the mass pricing update request in the **Price Assignments** zone.

Related Topics

For more information on...	See...
How to search for a mass pricing update request	Searching for a Mass Pricing Update Request on page 2329
Mass Pricing Update Request zone	Mass Pricing Update Request (Used for Viewing) on page 2334
Mass Pricing Update Request screen	Mass Pricing Update Request on page 2335
Price Assignments zone	Price Assignments on page 2337

Creating a Mass Pricing Update Request

Prerequisites

To define a mass pricing update request, you should have:

- Mass pricing update request types defined in the application
- A currency conversion algorithm attached to the **Currency Conversion For Bill Segments** algorithm spot of the respective division

Procedure

To define a mass pricing update request:

1. Click the **Menu** link in the **Application** toolbar.
A list appears.
2. From the **Main** menu, select **Pricing Management** and then click **Mass Pricing Update Request**.
A sub-menu appears.
3. Click the **Add** option from the **Mass Pricing Update Request** sub-menu.
The **Mass Pricing Update Request** screen appears.
4. Search for the required price assignments which you want to update in the **Search Price Assignments** zone.
5. Do either of the following:

If you want to...	Then...
Update all price assignments of a particular pricing entity type	<ol style="list-style-type: none"> 1. Select the check box corresponding to the respective pricing entity type. 2. Click Mass Pricing Update.
Update all price assignments of one or more pricing entity type	<ol style="list-style-type: none"> 1. Select the check box corresponding to the respective pricing entity types. 2. Click Mass Pricing Update.
Update all price assignments of all pricing entity types	<ol style="list-style-type: none"> 1. Select the check box corresponding to all pricing entity types. 2. Click Mass Pricing Update.
Update the price item pricing assigned to a particular person	<ol style="list-style-type: none"> 1. Select the check box corresponding to the Customer Agreed pricing entity type. The Customer Agreed Price Assignments zone appears. 2. Select the check box corresponding to the required price item pricing that you want to update in the Customer Agreed Price Assignments zone. 3. Click Mass Pricing Update.
Update the price item pricing assigned to a particular account	<ol style="list-style-type: none"> 1. Select the check box corresponding to the Account Agreed pricing entity type.

If you want to...	Then...
	<p>The Account Agreed Price Assignments zone appears.</p> <ol style="list-style-type: none"> <li data-bbox="846 289 1401 415">2. Select the check box corresponding to the required price item pricing that you want to update in the Account Agreed Price Assignments zone. <li data-bbox="846 443 1192 474">3. Click Mass Pricing Update.
Update the price item pricing assigned to a particular price list	<ol style="list-style-type: none"> <li data-bbox="846 548 1401 611">1. Select the check box corresponding to the Price List pricing entity type. <p>The Price list Price Assignments zone appears.</p> <ol style="list-style-type: none"> <li data-bbox="846 684 1401 779">2. Select the check box corresponding to the required price item pricing that you want to update in the Price list Price Assignments zone. <li data-bbox="846 806 1192 837">3. Click Mass Pricing Update.
Update the price item pricing assigned to a particular price list associated to a particular product	<ol style="list-style-type: none"> <li data-bbox="846 894 1401 957">1. Select the check box corresponding to the Product pricing entity type. <p>The Product Price list Price Assignments zone appears.</p> <ol style="list-style-type: none"> <li data-bbox="846 1062 1401 1188">2. Select the check box corresponding to the required price item pricing that you want to update in the Product Price list Price Assignments zone. <li data-bbox="846 1215 1192 1247">3. Click Mass Pricing Update.

The **Select Request Type** screen appears. It contains the following field:

Field Name	Field Description	Mandatory (Yes or No)
Mass Pricing Update Request Type	Used to indicate the mass pricing update request type using which you want to create a mass pricing update request.	Yes

6. Select the required mass pricing update request type from the respective field.

7. Click **OK**.

The **Mass Pricing Update Request** screen appears. It contains the following fields:

Field Name	Field Description	Mandatory (Yes or No)
Request Information	Displays information about the mass pricing update request.	Not applicable
Mass Pricing Update Criteria	Used to indicate whether you want to increase or decrease the rate in the price item pricing or whether	Yes

Field Name	Field Description	Mandatory (Yes or No)
	<p>you want to forcibly end the price item pricing on the update date. The valid values are:</p> <ul style="list-style-type: none"> • Decrease Price • End Date Price • Increase Price 	
Mass Pricing Update Type	<p>Used to indicate whether you want to increase or decrease the rate by an absolute value or in percentage. The valid values are:</p> <ul style="list-style-type: none"> • Absolute • Percentage 	<p>Yes (Conditional)</p> <p>Note: This field is required when the mass pricing update criteria is set to Increase Price or Decrease Price.</p>
	<p>Note: This field appears when the mass pricing update criteria is set to Increase Price or Decrease Price.</p>	
Rate Value	<p>Used to specify the rate by which you want to increase or decrease the price.</p>	<p>Yes (Conditional)</p> <p>Note: This field is required when the mass pricing update criteria is set to Increase Price or Decrease Price.</p>
	<p>Note:</p> <p>This field appears when the mass pricing update criteria is set to Increase Price or Decrease Price.</p> <p>You cannot specify a negative value or zero in the Rate Value field.</p>	
Currency	<p>Used to indicate the currency in which the rate is specified.</p>	<p>Yes (Conditional)</p> <p>Note: This field is required when the mass pricing update type is set to Absolute.</p>
	<p>Note:</p> <p>This field appears when the mass pricing update type is set to Absolute.</p> <p>If the pricing currency is different from the currency which is specified in the mass pricing update request, the system does the currency conversion using the algorithm which is attached to the Currency Conversion For Bill Segments algorithm spot of the respective division.</p>	
Update Date	<p>Displays the date when you want to update the price assignments. The system fetches the price assignments which are effective on the update date. If you want to forcibly end a price item pricing through the mass pricing update request, the end date in the price item pricing is set to the update date. However, if you want to increase or decrease the rate in a price item pricing through the mass pricing update request, the system behaves in the following manner:</p>	Not applicable

Field Name	Field Description	Mandatory (Yes or No)
	<ul style="list-style-type: none"> If a price assignment is referred in past, the existing price assignment is end dated and a new price assignment is created. If a price assignment is not yet referred in the system, the existing price assignment is updated. 	
	<p>Note: You cannot update a price assignment through a mass pricing update request when the start or end date of the price assignment is equal to the update date.</p>	

- Enter the required details in the **Mass Pricing Update Request** screen.
- Click **Save**.

The mass pricing update request is defined in the **Draft** status. And, the status of all price assignment records in the mass pricing update request is set to **Pending**.

Related Topics

For more information on...	See...
Mass Pricing Update Request screen	Mass Pricing Update Request on page 2349
Search Price Assignments zone	Search Price Assignments on page 2350

Mass Pricing Update Request (Used for Viewing)

The **Mass Pricing Update Request** screen allows you to:

- View the details of a mass pricing update request
- Edit the details of a mass pricing update request
- Delete a mass pricing update request
- Submit a mass pricing update request for processing
- Approve or reject a mass pricing update request
- Submit a batch job for a mass pricing update request
- View the log of a mass pricing update request
- Add a log entry for a mass pricing update request

It consists of the following tabs:

- [Mass Pricing Update Request - Main](#) on page 2334
- [Mass Pricing Update Request - Log](#) on page 2337

Mass Pricing Update Request - Main

The **Main** tab displays information about the mass pricing update request. It contains the following zones:

- [Mass Pricing Update Request](#) on page 2335
- [Price Assignments](#) on page 2337

Mass Pricing Update Request

The **Mass Pricing Update Request** zone displays the details of the mass pricing update request. It contains the following sections:

- **Main** - Displays basic information about the mass pricing update request. It contains the following fields:

Field Name	Field Description
Request Information	Displays information about the mass pricing update request.
Mass Pricing Update Request Type	Indicates the mass pricing update request type using which the mass pricing update request is created. Note: It has a link. On clicking the link, the Request Type screen appears where you can view the details of the respective mass pricing update request type.
Status	Indicates the status of the mass pricing update request. The valid values are: <ul style="list-style-type: none"> • Approval in Progress • Deferred Processing • Draft • Processed • Rejected • Running C1-GENRQ Batch
Mass Pricing Update Criteria	Indicates whether you want to increase or decrease the rate in the price item pricing or whether you want to forcibly end the price item pricing on the update date. The valid values are: <ul style="list-style-type: none"> • Decrease Price • End Date Price • Increase Price
Mass Pricing Update Type	Indicates whether you want to increase or decrease the rate by an absolute value or in percentage. The valid values are: <ul style="list-style-type: none"> • Absolute • Percentage Note: This field appears when the mass pricing update criteria is set to Increase Price or Decrease Price .
Rate Value	Displays the rate by which you want to increase or decrease the price. Note: This field appears when the mass pricing update criteria is set to Increase Price or Decrease Price .
Currency	Indicates the currency in which the rate is specified. Note: This field appears when the mass pricing update type is set to Absolute .
Update Date	Displays the date when you want to update the price assignments.

- **Statistics** - Displays summarized information about the records which are included in the mass pricing update request. It contains the following fields:

Field Name	Field Description
Total Records	Displays the total number of price assignments which are included in the mass pricing update request.
Processed Records	Displays the total number of price assignments which are successfully updated through the mass pricing update request.
Error Records	Displays the total number of price assignments which could not be updated through the mass pricing update request.

- **Record Actions** - This section contains the following buttons:

Button Name	Button Description
Edit	Used to edit the details of the mass pricing update request.
	Note: The Edit button appears when the mass pricing update request is in the Draft status.
Delete	Used to delete the mass pricing update request.
	Note: The Delete button appears when the mass pricing update request is in the Draft status.
Submit	Used to submit the mass pricing update request for updating the price assignments.
	Note: The Submit button appears when the mass pricing update request is in the Draft status.
Submit Batch	Used to generate a batch job using the Generic Request Periodic Monitor (C1-GENRQ) batch control.
	Note: The Submit Batch button appears when the mass pricing update request is in the Deferred Processing status.
Approve	Used to approve the mass pricing update request.
	Note: The Approve button appears when: <ul style="list-style-type: none"> • The mass pricing update request is in the Approval in Progress status. • A user with the approval To Do role is reviewing the mass pricing update request.
Reject	Used to reject the mass pricing update request.
	Note: The Reject button appears when: <ul style="list-style-type: none"> • The mass pricing update request is in the Approval in Progress status. • A user with the approval To Do role is reviewing the mass pricing update request.

- **Record Information** - This section contains the following fields:

Field Name	Field Description
Business Object	Indicates the business object using which the mass pricing update request is created. In addition, a context menu appears corresponding to the Business Object field which helps in navigating to other screens in the application. Note: It has a link. On clicking the link, the Business Object screen appears where you can view the details of the respective business object.
Status Date Time	Displays the date and time when the mass pricing update request status is updated.
Creation Date Time	Displays the date and time when the mass pricing update request is created.

Price Assignments

The **Price Assignments** zone lists the price assignments which you want to update through the mass pricing update request. It contains the following columns:

Column Name	Column Description
Pricing Information	Displays information about the price item pricing. Note: It has a link. On clicking the link, the Price Item Pricing screen appears where you can view the details of the respective price item pricing.
Pricing Parameters	Displays a comma-separated list of parameter values using which the price item pricing is defined. Note: The order in which parameter values appear in this field is controlled by the display order (which is defined while associating a parameter with a price item).
Entity ID	Indicates the entity to which the price item pricing is assigned.
Pricing Entity Type	Indicates the type of entity on which the price assignment is done. The valid values are: <ul style="list-style-type: none"> • Account Agreed • Customer Agreed • Price List • Product
Mass Pricing Update Status	Indicates the status of the price assignment record which is included in the mass pricing update request. The valid values are: <ul style="list-style-type: none"> • Pending • Processed • Error

Note: Pagination is used to display limited number of records in the **Search Results** section. You can use the navigation links, such as **Previous** and **Next** to navigate between pages.

Mass Pricing Update Request - Log

The **Log** tab contains the following zone:

- [Mass Pricing Update Request Log](#) on page 2338

Mass Pricing Update Request Log

The **Mass Pricing Update Request Log** zone lists the complete trail of actions performed on the mass pricing update request. It contains the following columns:

Column Name	Column Description
Creation Date Time	Displays the date and time when the action was performed on the mass pricing update request.
Details	Displays the details of the action performed on the mass pricing update request.
User	Indicates the user who has performed the action on the mass pricing update request.
Log Type	Indicates the type of log.
Related Object	Indicates the object or entity which is created when the action is performed on the mass pricing update request.
	Note: At present, no data appears in this column. The implementation team can build the custom logic to meet the business requirements.
Status Reason	Indicates the reason why the status of the mass pricing update request is changed.
	Note: At present, no data appears in this column. The implementation team can build the custom logic to meet the business requirements.

Note: You can manually add a log entry for the mass pricing update request by clicking the **Add Log Entry** link in the upper right corner of the **Mass Pricing Update Request Log** zone.

Related Topics

For more information on...	See...
How to view the log of a mass pricing update request	Viewing the Log of a Mass Pricing Update Request on page 2348
How to add a log entry for a mass pricing update request	Adding a Log Entry for a Mass Pricing Update Request on page 2348

Creating a Mass Pricing Update Request

Prerequisites

To define a mass pricing update request, you should have:

- Mass pricing update request types defined in the application
- A currency conversion algorithm attached to the **Currency Conversion For Bill Segments** algorithm spot of the respective division

Procedure

To define a mass pricing update request:

1. Click the **Menu** link in the **Application** toolbar.
A list appears.
2. From the **Main** menu, select **Pricing Management** and then click **Mass Pricing Update Request**.
A sub-menu appears.

- Click the **Add** option from the **Mass Pricing Update Request** sub-menu.

The **Mass Pricing Update Request** screen appears.

- Search for the required price assignments which you want to update in the **Search Price Assignments** zone.
- Do either of the following:

If you want to...	Then...
Update all price assignments of a particular pricing entity type	<ol style="list-style-type: none"> Select the check box corresponding to the respective pricing entity type. Click Mass Pricing Update.
Update all price assignments of one or more pricing entity type	<ol style="list-style-type: none"> Select the check box corresponding to the respective pricing entity types. Click Mass Pricing Update.
Update all price assignments of all pricing entity types	<ol style="list-style-type: none"> Select the check box corresponding to all pricing entity types. Click Mass Pricing Update.
Update the price item pricing assigned to a particular person	<ol style="list-style-type: none"> Select the check box corresponding to the Customer Agreed pricing entity type. The Customer Agreed Price Assignments zone appears. Select the check box corresponding to the required price item pricing that you want to update in the Customer Agreed Price Assignments zone. Click Mass Pricing Update.
Update the price item pricing assigned to a particular account	<ol style="list-style-type: none"> Select the check box corresponding to the Account Agreed pricing entity type. The Account Agreed Price Assignments zone appears. Select the check box corresponding to the required price item pricing that you want to update in the Account Agreed Price Assignments zone. Click Mass Pricing Update.
Update the price item pricing assigned to a particular price list	<ol style="list-style-type: none"> Select the check box corresponding to the Price List pricing entity type. The Price list Price Assignments zone appears.

If you want to...	Then...
	<ol style="list-style-type: none"> 2. Select the check box corresponding to the required price item pricing that you want to update in the Price list Price Assignments zone. 3. Click Mass Pricing Update.
Update the price item pricing assigned to a particular price list associated to a particular product	<ol style="list-style-type: none"> 1. Select the check box corresponding to the Product pricing entity type. The Product Price list Price Assignments zone appears. 2. Select the check box corresponding to the required price item pricing that you want to update in the Product Price list Price Assignments zone. 3. Click Mass Pricing Update.

The **Select Request Type** screen appears. It contains the following field:

Field Name	Field Description	Mandatory (Yes or No)
Mass Pricing Update Request Type	Used to indicate the mass pricing update request type using which you want to create a mass pricing update request.	Yes

6. Select the required mass pricing update request type from the respective field.
7. Click **OK**.

The **Mass Pricing Update Request** screen appears. It contains the following fields:

Field Name	Field Description	Mandatory (Yes or No)
Request Information	Displays information about the mass pricing update request.	Not applicable
Mass Pricing Update Criteria	Used to indicate whether you want to increase or decrease the rate in the price item pricing or whether you want to forcibly end the price item pricing on the update date. The valid values are: <ul style="list-style-type: none"> • Decrease Price • End Date Price • Increase Price 	Yes
Mass Pricing Update Type	Used to indicate whether you want to increase or decrease the rate by an absolute value or in percentage. The valid values are: <ul style="list-style-type: none"> • Absolute • Percentage 	Yes (Conditional)
		Note: This field is required when the mass pricing update criteria is set to Increase Price or Decrease Price .

Field Name	Field Description	Mandatory (Yes or No)
	Note: This field appears when the mass pricing update criteria is set to Increase Price or Decrease Price .	
Rate Value	Used to specify the rate by which you want to increase or decrease the price. Note: This field appears when the mass pricing update criteria is set to Increase Price or Decrease Price . You cannot specify a negative value or zero in the Rate Value field.	Yes (Conditional) Note: This field is required when the mass pricing update criteria is set to Increase Price or Decrease Price .
Currency	Used to indicate the currency in which the rate is specified. Note: This field appears when the mass pricing update type is set to Absolute . If the pricing currency is different from the currency which is specified in the mass pricing update request, the system does the currency conversion using the algorithm which is attached to the Currency Conversion For Bill Segments algorithm spot of the respective division.	Yes (Conditional) Note: This field is required when the mass pricing update type is set to Absolute .
Update Date	Displays the date when you want to update the price assignments. The system fetches the price assignments which are effective on the update date. If you want to forcibly end a price item pricing through the mass pricing update request, the end date in the price item pricing is set to the update date. However, if you want to increase or decrease the rate in a price item pricing through the mass pricing update request, the system behaves in the following manner: <ul style="list-style-type: none"> • If a price assignment is referred in past, the existing price assignment is end dated and a new price assignment is created. • If a price assignment is not yet referred in the system, the existing price assignment is updated. Note: You cannot update a price assignment through a mass pricing update request when the start or end date of the price assignment is equal to the update date.	Not applicable

8. Enter the required details in the **Mass Pricing Update Request** screen.

9. Click **Save**.

The mass pricing update request is defined in the **Draft** status. And, the status of all price assignment records in the mass pricing update request is set to **Pending**.

Related Topics

For more information on...	See...
Mass Pricing Update Request screen	Mass Pricing Update Request on page 2349
Search Price Assignments zone	Search Price Assignments on page 2350

Editing a Mass Pricing Update Request

Procedure

To edit a mass pricing update request:

1. Search for the mass pricing update request in the **Mass Pricing Update Request** screen.
2. In the **Search Results** section, click the link in the **Request Information** column corresponding to the mass pricing update request whose details you want to edit.

The **Mass Pricing Update Request** screen appears.

3. Ensure that the **Main** tab is selected.
4. Click the **Edit** button in the **Mass Pricing Update Request** zone.

The **Mass Pricing Update Request** screen appears. It contains the following fields:

Field Name	Field Description	Mandatory (Yes or No)
Request Information	Displays information about the mass pricing update request.	Not applicable
Mass Pricing Update Criteria	Used to indicate whether you want to increase or decrease the rate in the price item pricing or whether you want to forcibly end the price item pricing on the update date. The valid values are: <ul style="list-style-type: none"> • Decrease Price • End Date Price • Increase Price 	Yes
Mass Pricing Update Type	Used to indicate whether you want to increase or decrease the rate by an absolute value or in percentage. The valid values are: <ul style="list-style-type: none"> • Absolute • Percentage 	Yes (Conditional)
	Note: The Mass Pricing Update Type field appears when the mass pricing update criteria is set to Increase Price or Decrease Price .	Note: The Mass Pricing Update Type field is required when the mass pricing update criteria is set to Increase Price or Decrease Price .
Rate Value	Used to specify the rate by which you want to increase or decrease the price.	Yes (Conditional)

Field Name	Field Description	Mandatory (Yes or No)
	<p>Note:</p> <p>The Rate Value field appears when the mass pricing update criteria is set to Increase Price or Decrease Price.</p> <p>You cannot specify a negative value or zero in the Rate Value field.</p>	<p>Note: The Rate Value field is required when the mass pricing update criteria is set to Increase Price or Decrease Price.</p>
Currency	<p>Used to indicate the currency in which the rate is specified.</p> <p>Note:</p> <p>The Currency field appears when the mass pricing update type is set to Absolute.</p> <p>If the pricing currency is different from the currency which is specified in the mass pricing update request, the system does the currency conversion using the algorithm which is attached to the Currency Conversion For Bill Segments algorithm spot of the respective division.</p>	<p>Yes (Conditional)</p> <p>Note: The Currency field is required when the mass pricing update type is set to Absolute.</p>
Update Date	<p>Displays the date when you want to update the price assignments. The system fetches the price assignments which are effective on the update date. If you want to forcibly end a price item pricing through the mass pricing update request, the end date in the price item pricing is set to the update date. However, if you want to increase or decrease the rate in a price item pricing through the mass pricing update request, the system behaves in the following manner:</p> <ul style="list-style-type: none"> • If a price assignment is referred in past, the existing price assignment is end dated and a new price assignment is created. • If a price assignment is not yet referred in the system, the existing price assignment is updated. <p>Note: You cannot update a price assignment through a mass pricing update request when the start or end date of the price assignment is equal to the update date.</p>	Not applicable

Note: The **Edit** button appears when the mass pricing update request is in the **Draft** status.

5. Modify the required details in the **Mass Pricing Update Request** screen.
6. Click **Save**.

The changes made to the mass pricing update request are saved.

Related Topics

For more information on...	See...
How to search for a mass pricing update request	Searching for a Mass Pricing Update Request on page 2329
Mass Pricing Update Request screen	Mass Pricing Update Request (Used for Viewing) on page 2334
Mass Pricing Update Request zone	Mass Pricing Update Request on page 2335

Deleting a Mass Pricing Update Request**Procedure**

To delete a mass pricing update request:

1. Search for the mass pricing update request in the **Mass Pricing Update Request** screen.
2. In the **Search Results** section, click the link in the **Request Information** column corresponding to the mass pricing update request that you want to delete.

The **Mass Pricing Update Request** screen appears.

3. Ensure that the **Main** tab is selected.
4. Click the **Delete** button in the **Mass Pricing Update Request** zone.

A message appears confirming whether you want to delete the mass pricing update request.

Note: The **Delete** button in the **Mass Pricing Update Request** zone appears when the mass pricing update request is in the **Draft** status.

Note: The **Delete** button appears when the mass pricing update request is in the **Draft** status.

5. Click **OK**.

The mass pricing update request is deleted.

Related Topics

For more information on...	See...
How to search for the mass pricing update request	Searching for a Mass Pricing Update Request on page 2329
Mass Pricing Update Request screen	Mass Pricing Update Request (Used for Viewing) on page 2334
Mass Pricing Update Request zone	Mass Pricing Update Request on page 2335

Submitting a Mass Pricing Update Request**Procedure**

To submit a mass pricing update request:

1. Search for the mass pricing update request in the **Mass Pricing Update Request** screen.
2. In the **Search Results** section, click the link in the **Request Information** column corresponding to the mass pricing update request that you want to submit.

The **Mass Pricing Update Request** screen appears.

3. Ensure that the **Main** tab is selected.
4. Click the **Submit** button in the **Mass Pricing Update Request** zone.

The system behaves in the following manner:

If...	Then...
The Approval Required option is selected in the mass pricing update request type using which the mass pricing update request is created	The status of the mass pricing update request is changed to Approval in Progress . A To Do is created using the approval To Do type which is specified in the mass pricing update request type. Once a To Do is created, it is assigned to all users with an approval To Do role which is specified in the mass pricing update request type.
The Approval Required option is not selected in the mass pricing update request type and the number of price assignments in the mass pricing update request exceeds the defer processing count	The status of the mass pricing update request is changed to Deferred Processing .
The Approval Required option is not selected in the mass pricing update request type and the number of price assignments in the mass pricing update request does not exceed the defer processing count	<p>The status of the mass pricing update request is changed to Updating Price Assignments. If a price assignment is referred in past, the existing price assignment is end dated and a new price assignment is created. However, if a price assignment is not yet referred in the system, the existing price assignment is updated. Once the price assignment is newly created or updated, the status of the record in the mass pricing update request is changed to Processed. However, if a price assignment is referred for a future date, the status of the record in the mass pricing update request is changed to Error. In addition, if any error occurs while updating an existing price assignment or creating a new price assignment, the status of the record in the mass pricing update request is changed to Error. Finally, the status of the mass pricing update request is changed to Processed.</p> <p>Note: If a price assignment is included multiple times in a mass pricing update request, the system will update the price assignment only once.</p>

Note: The **Submit** button appears when the mass pricing update request is in the **Draft** status.

Related Topics

For more information on...	See...
How to search for a mass pricing update request	Searching for a Mass Pricing Update Request on page 2329
Mass Pricing Update Request screen	Mass Pricing Update Request (Used for Viewing) on page 2334
Mass Pricing Update Request zone	Mass Pricing Update Request on page 2335

Generating a Batch Job for a Mass Pricing Update Request

Procedure

To generate a batch job for a mass pricing update request:

1. Search for the mass pricing update request in the **Mass Pricing Update Request** screen.
2. In the **Search Results** section, click the link in the **Request Information** column corresponding to the mass pricing update request for which you want to submit a batch job.

The **Mass Pricing Update Request** screen appears.

3. Ensure that the **Main** tab is selected.
4. Click the **Submit Batch** button in the **Mass Pricing Update Request** zone.

A batch job is created using the **C1-GENRQ** batch control. While creating the batch job, it uses the values defined in the **Thread Count** and **Thread Pool Name** option types of the **Mass Pricing Update (C1-MASPRI)** feature configuration. In addition, a log is created for the mass pricing update request which indicates the batch job ID. Finally, the status of the mass pricing update request is changed to **Running C1-GENRQ Batch**.

Note: The **Submit Batch** button appears when the mass pricing update request is in the **Deferred Processing** status.

Related Topics

For more information on...	See...
How to search for a mass pricing update request	Searching for a Mass Pricing Update Request on page 2329
Mass Pricing Update Request screen	Mass Pricing Update Request (Used for Viewing) on page 2334
Mass Pricing Update Request zone	Mass Pricing Update Request on page 2335
How to set the Mass Pricing Update (C1-MASPRI) feature configuration	Setting the C1_MASPRI Feature Configuration on page 4331

Approving a Mass Pricing Update Request

Procedure

To approve a mass pricing update request:

1. Search for the mass pricing update request in the **Mass Pricing Update Request** screen.
2. In the **Search Results** section, click the link in the **Request Information** column corresponding to the mass pricing update request whose details you want to review.

The **Mass Pricing Update Request** screen appears.

3. Ensure that the **Main** tab is selected.
4. Click the **Approve** button in the **Mass Pricing Update Request** zone.

The system behaves in the following manner:

If...	Then...
The number of price assignments in the mass pricing update request exceeds the defer processing count	The status of the mass pricing update request is changed to Deferred Processing .
The number of price assignments in the mass pricing update request does not exceed the defer processing count	The status of the mass pricing update request is changed to Updating Price Assignments . If a price assignment is referred in past, the existing price assignment is end dated and a new price assignment is created. However, if a price assignment is not yet

If...	Then...
	<p>referred in the system, the existing price assignment is updated. Once the price assignment is newly created or updated, the status of the record in the mass pricing update request is changed to Processed. However, if a price assignment is referred for a future date, the status of the record in the mass pricing update request is changed to Error. In addition, if any error occurs while updating an existing price assignment or creating a new price assignment, the status of the record in the mass pricing update request is changed to Error. Finally, the status of the mass pricing update request is changed to Processed.</p> <p>Note: If a price assignment is included multiple times in a mass pricing update request, the system will update the price assignment only once.</p>

Note:

The mass pricing update request is in the **Approval In Progress** status.

A user with the approval To Do role is reviewing the mass pricing update request.

The system will not allow you to approve or reject a mass pricing update request submitted by you.

Related Topics

For more information on...	See...
How to search for a mass pricing update request	Searching for a Mass Pricing Update Request on page 2329
Mass Pricing Update Request screen	Mass Pricing Update Request (Used for Viewing) on page 2334
Mass Pricing Update Request zone	Mass Pricing Update Request on page 2335

Rejecting a Mass Pricing Update Request**Procedure**

To reject a mass pricing update request:

1. Search for the mass pricing update request in the **Mass Pricing Update Request** screen.
2. In the **Search Results** section, click the link in the **Request Information** column corresponding to the mass pricing update request whose details you want to review.

The **Mass Pricing Update Request** screen appears.

3. Ensure that the **Main** tab is selected.
4. Click the **Reject** button in the **Mass Pricing Update Request** zone.

The status of the mass pricing update request is changed to **Rejected**. A To Do is created using the submitter To Do type which is specified in the mass pricing update request type. Once a To Do is created, it is assigned to all users with a submitter To Do role which is specified in the mass pricing update request type.

Note:

The mass pricing update request is in the **Approval In Progress** status.

A user with the approval To Do role is reviewing the mass pricing update request.

The system will not allow you to approve or reject a mass pricing update request submitted by you.

Related Topics

For more information on...	See...
How to search for a mass pricing update request	Searching for a Mass Pricing Update Request on page 2329
Mass Pricing Update Request screen	Mass Pricing Update Request (Used for Viewing) on page 2334
Mass Pricing Update Request zone	Mass Pricing Update Request on page 2335

Viewing the Log of a Mass Pricing Update Request**Procedure**

To view the log of a mass pricing update request:

1. Search for the mass pricing update request in the **Mass Pricing Update Request** screen.
2. In the **Search Results** section, click the link in the **Request Information** column corresponding to the mass pricing update request whose log you want to view.

The **Mass Pricing Update Request** screen appears.

3. Click the **Log** tab.

The **Log** tab appears.

4. View the complete trail of actions performed on the mass pricing update request in the **Mass Pricing Update Request Log** zone.

Related Topics

For more information on...	See...
How to search for a mass pricing update request	Searching for a Mass Pricing Update Request on page 2329
How to add a log entry for a mass pricing update request	Adding a Log Entry for a Mass Pricing Update Request on page 2348
Mass Pricing Update Request screen	Mass Pricing Update Request (Used for Viewing) on page 2334
Mass Pricing Update Request Log zone	Mass Pricing Update Request Log on page 2338

Adding a Log Entry for a Mass Pricing Update Request**Procedure**

To add a log entry for a mass pricing update request:

1. Search for the mass pricing update request in the **Mass Pricing Update Request** screen.

- In the **Search Results** section, click the link in the **Request Information** column corresponding to the mass pricing update request whose log you want to edit.

The **Mass Pricing Update Request** screen appears.

- Click the **Log** tab.

The **Log** tab appears.

- Click the **Add Log Entry** link in the upper right corner of this zone.

The **Add Request Log** window appears. It contains the following fields:

Field Name	Field Description	Mandatory (Yes or No)
Request Information	Displays information about the mass pricing update request.	Not applicable
Log Details	Used to specify additional comments for the mass pricing update request.	Yes

- Enter the comments in the **Log Details** field.

- Click **Save**.

The log entry is added in the **Mass Pricing Update Request Log** zone.

Related Topics

For more information on...	See...
How to search for a mass pricing update request	Searching for a Mass Pricing Update Request on page 2329
Mass Pricing Update Request screen	Mass Pricing Update Request (Used for Viewing) on page 2334
Mass Pricing Update Request Log zone	Mass Pricing Update Request Log on page 2338

Mass Pricing Update Request

The **Mass Pricing Update Request** screen allows you to search for price assignments using various search criteria. The search results (i.e. price assignments) are grouped based on the pricing entity type, such as **Account Agreed**, **Customer Agreed**, **Price List**, and **Product**. You can then create a mass pricing update request for the following:

- All price assignments of a particular pricing entity type
- All price assignments of one or more pricing entity type
- All price assignments of all pricing entity types
- A price item pricing assigned to a particular person, account, or price list
- A price item pricing assigned to a price list which is associated to a product
- One or more price assignments of a person, account, or price list
- One or more price assignments of a price list which is associated to a product

It contains the following zones:

- [Search Price Assignments](#) on page 2350
- [Account Agreed Price Assignments](#) on page 2352
- [Customer Agreed Price Assignments](#) on page 2353
- [Price List Price Assignments](#) on page 2353

- [Product Price List Price Assignments](#) on page 2354

Search Price Assignments

The **Search Price Assignments** zone allows you to search for active price assignments on different pricing entity type. It contains the following sections:

- **Search Criteria** – The **Search Criteria** section contains the following fields:

Field Name	Field Description	Mandatory (Yes or No)
Price Item	Used to search pricing which is defined for a particular price item.	Yes
	Note: The Search (🔍) icon appears corresponding to the Price Item field. On clicking the Search icon, the Price Item Search window appears.	
Account ID	Used to search pricing which is assigned to a particular account.	No
	Note: The Search (🔍) icon appears corresponding to the Account ID field. On clicking the Search icon, the Account Search window appears.	
Person ID	Used to search pricing which is assigned to a particular person.	No
	Note: The Search (🔍) icon appears corresponding to the Person ID field. On clicking the Search icon, the Person Search window appears.	
Division	Used to search pricing which belongs to a particular division.	Yes
	Note: You can only view those divisions to which you have access in the Division list.	
Update Date	Used to search pricing which is effective on a particular date.	Yes
	Note: By default, this field is set to the current date. The update date cannot be earlier than the system date.	
Pricing Entity Type	Used to search pricing which is defined on a particular type of entity. The valid values are: <ul style="list-style-type: none"> • Account Agreed • Customer Agreed 	No

Field Name	Field Description	Mandatory (Yes or No)
	<ul style="list-style-type: none"> Price List Product 	
	<p>Note: This field appears when you click the Advanced Search link available in the right side of the Search Price Assignments zone.</p>	

In addition, it contains the **Price Item Parameters** section which has the following fields:

Field Name	Field Description	Mandatory (Yes or No)
Parameter	Used to search pricing which is defined using a particular parameter.	No
	<p>Note: The Search (🔍) icon appears corresponding to the Parameter field. On clicking the Search icon, the Parameter Search window appears.</p>	
Parameter Value	Used to search pricing which is defined using a particular parameter value.	Yes (Conditional)
	<p>Note: If the value type of the parameter is Adhoc or Predefined, the Search (🔍) icon appears corresponding to the Parameter Value field. On clicking the Search icon, the Parameter Value Search window appears.</p>	<p>Note: This field is required when you are searching for price assignments which are created using a particular parameter.</p>

Note: If you want to add more than one parameter while searching for price assignments, click the **Add** (+) icon and then specify the parameter and parameter value. However, if you want to remove a parameter and parameter value combination from the search criteria, click the **Delete** (🗑️) icon corresponding to the parameter and parameter value combination.

- **Search Result** - On clicking the **Search** button, the search results appear based on the specified search criteria. The **Search Result** section contains the following columns:

Column Name	Column Description
Pricing Entity Type	Indicates the type of entity on which the price item pricing is defined. The valid values are: <ul style="list-style-type: none"> Account Agreed Customer Agreed Price List Product
Pricing Entity Count	Indicates the number of entities on which the price item pricing is defined.
Price Assignment Count	Indicates the number of price assignments on a particular type of pricing entity.

Note: Pagination is used to display limited number of records in the **Search Results** section. You can use the navigation links, such as **Previous** and **Next** to navigate between pages.

In addition, it contains the following button:

Button Name	Button Description
Mass Pricing Update	Used to create a mass pricing update request.

On clicking the **Broadcast** (📡) icon corresponding to a pricing entity type, the **Account Agreed Price Assignments**, **Customer Agreed Price Assignments**, **Price List Price Assignments**, or **Product Price List Price Assignments** zone appears depending on the pricing entity type.

A check box appears corresponding to each pricing entity type. On selecting the check box, you can create a mass pricing update request for all price assignments which are done on the respective pricing entity type. You can also create a mass pricing update request for all price assignments which are done on one or more pricing entity types at the same time. In addition, you can select the check box corresponding to the column header. This indicates that you want to create a mass pricing update request for all price assignments which are done on all pricing entity types.

Account Agreed Price Assignments

The **Account Agreed Price Assignments** zone lists the active pricing of a price item which is assigned to an account. It contains the following columns:

Column Name	Column Description
Account Information	Indicates the account to which the price item pricing is assigned. In addition, the Account Information column has a context menu which helps in navigating to other screens in the application. Note: It has a link. On clicking the link, the Account screen appears where you can view the details of the respective account.
Account Identifier Type	Indicates the primary identifier type of the account.
Account Identifier	Indicates the account to which the price item pricing is assigned.
Pricing Information	Displays information about the price item pricing. Note: It has a link. On clicking the link, the Price Item Pricing screen appears where you can view the details of respective price item pricing.
Pricing Parameters	Displays a comma-separated list of parameter values using which the price item pricing is defined. Note: The order in which parameter values appear in this field is controlled by the display order (which is defined while associating a parameter with a price item).

Note: Pagination is used to display limited number of records in the **Search Results** section. You can use the navigation links, such as **Previous** and **Next** to navigate between pages.

In addition, it contains the following button:

Button Name	Button Description
Mass Pricing Update	Used to create a mass pricing update request.

A check box appears corresponding to each price assignment. On selecting the check box, you can create a mass pricing update request for the price assignment. You can select multiple price assignments at the same time. You can also select the check box corresponding to the column header. This indicates that you want to create a mass pricing update request for all price assignments which are defined at the account level.

Customer Agreed Price Assignments

The **Customer Agreed Price Assignments** zone lists the active pricing of a price item which is assigned to a person. It contains the following columns:

Column Name	Column Description
Person Information	Indicates the person to whom the price item pricing is assigned. In addition, the Person Information column has a context menu which helps in navigating to other screens in the application. Note: It has a link. On clicking the link, the Person screen appears where you can view the details of the respective person.
Person Identifier Type	Indicates the primary identifier type of a person.
Person Identifier	Indicates the person to whom the price item pricing is assigned.
Pricing Information	Displays information about the price item pricing. Note: It has a link. On clicking the link, the Price Item Pricing screen appears where you can view the details of respective price item pricing.
Pricing Parameters	Displays a comma-separated list of parameter values using which the price item pricing is defined. Note: The order in which parameter values appear in this field is controlled by the display order (which is defined while associating a parameter with a price item).

Note: Pagination is used to display limited number of records in the **Search Results** section. You can use the navigation links, such as **Previous** and **Next** to navigate between pages.

In addition, it contains the following button:

Button Name	Button Description
Mass Pricing Update	Used to create a mass pricing update request.

A check box appears corresponding to each price assignment. On selecting the check box, you can create a mass pricing update request for the price assignment. You can select multiple price assignments at the same time. You can also select the check box corresponding to the column header. This indicates that you want to create a mass pricing update request for all price assignments which are defined at the person level.

Price List Price Assignments

The **Price List Price Assignments** zone lists the active pricing of a price item which is assigned to a price list. It contains the following columns:

Column Name	Column Description
Price List Information	Indicates the price list to which the price item pricing is assigned. In addition, this column has a context menu which helps in navigating to other screens in the application.

Column Name	Column Description
	Note: It has a link. On clicking the link, the Price List screen appears where you can view the details of the respective price list.
Pricing Information	Displays information about the price item pricing. Note: It has a link. On clicking the link, the Price Item Pricing screen appears where you can view the details of respective price item pricing.
Pricing Parameters	Displays a comma-separated list of parameter values using which the price item pricing is defined. Note: The order in which parameter values appear in this field is controlled by the display order (which is defined while associating a parameter with a price item).

Note: Pagination is used to display limited number of records in the **Search Results** section. You can use the navigation links, such as **Previous** and **Next** to navigate between pages.

In addition, it contains the following button:

Button Name	Button Description
Mass Pricing Update	Used to create a mass pricing update request.

A check box appears corresponding to each price assignment. On selecting the check box, you can create a mass pricing update request for the price assignment. You can select multiple price assignments at the same time. You can also select the check box corresponding to the column header. This indicates that you want to create a mass pricing update request for all price assignments which are defined in the price lists.

Product Price List Price Assignments

The **Product Price List Price Assignments** zone lists the active pricing of a price item which is added in the price lists associated with the products. It contains the following columns:

Column Name	Column Description
Product	Displays information about the product.
Product Version	Displays information about the effective product version.
Price List Information	Indicates the price list associated with the product to which the price item pricing is assigned. In addition, this column has a context menu which helps in navigating to other screens in the application. Note: It has a link. On clicking the link, the Price List screen appears where you can view the details of respective price list.
Pricing Information	Displays information about the price item pricing. Note: It has a link. On clicking the link, the Price Item Pricing screen appears where you can view the details of respective price item pricing.
Pricing Parameters	Displays a comma-separated list of parameter values using which the price item pricing is defined.

Column Name	Column Description
	Note: The order in which parameter values appear in the Pricing Parameters field is controlled by the display order (which is defined while associating a parameter with a price item).

Note: Pagination is used to display limited number of records in the **Search Results** section. You can use the navigation links, such as **Previous** and **Next** to navigate between pages.

In addition, it contains the following button:

Button Name	Button Description
Mass Pricing Update	Used to create a mass pricing update request.

A check box appears corresponding to each price assignment. On selecting the check box, you can create a mass pricing update request for the price assignment. You can select multiple price assignments at the same time. You can also select the check box corresponding to the column header. This indicates that you want to create a mass pricing update request for all price assignments which are defined in the price lists associated with the products.

Searching for Price Assignments on a Pricing Entity

Prerequisites

To search for price assignments on a pricing entity, you should have:

- Price items, accounts, persons, and divisions defined in the application
- Price item associated with the required division
- Access to the required division

Procedure

To search for price assignments on a pricing entity:

1. Click the **Menu** link in the **Application** toolbar.
A list appears.
2. From the **Main** menu, select **Pricing Management** and then click **Mass Pricing Update Request**.
A sub-menu appears.
3. Click the **Add** option from the **Mass Pricing Update Request** sub-menu.
The **Mass Pricing Update Request** screen appears.
4. Enter the search criteria in the **Search Price Assignments** zone.

Note: ORMB search engine supports wildcard search, where you can substitute the percentage (%) symbol as a stand in for any word or letter in a search criteria. You can use the ‘%’ wildcard character in all input fields except the date and ID fields. The ‘%’ wildcard character is suffixed automatically at the end of the partial search criteria. Therefore, you may or may not specify the wildcard character at the end of the partial search criteria. However, you have to prefix the wildcard character manually wherever required.

5. Click **Search**.

The number of price assignments on the following types of pricing entity are listed in the **Search Results** section:

- Account Agreed
- Customer Agreed
- Price List

- Product

Related Topics

For more information on...	See...
Mass Pricing Update Request screen	Mass Pricing Update Request on page 2349
Search Price Assignments zone	Search Price Assignments on page 2350

Viewing the Price Assignments Defined at the Account Level

Procedure

To view the price assignments defined at the account level:

1. Search for price assignments in the **Mass Pricing Update Request** screen.
2. In the **Search Results** section, click the **Broadcast** (📡) icon corresponding to the **Account Agreed** pricing entity type whose details you want to view.
The **Account Agreed Price Assignments** zone appears.
3. View the price item pricing assigned to the accounts in the **Account Agreed Price Assignments** zone.

Related Topics

For more information on...	See...
How to search for price assignments on a pricing entity	Searching for Price Assignments on a Pricing Entity on page 2355
Account Agreed Price Assignments zone	Account Agreed Price Assignments on page 2352

Viewing the Price Assignments Defined at the Person Level

Procedure

To view the price assignments defined at the person level:

1. Search for price assignments in the **Mass Pricing Update Request** screen.
2. In the **Search Results** section, click the **Broadcast** (📡) icon corresponding to the **Customer Agreed** pricing entity type whose details you want to view.
The **Customer Agreed Price Assignments** zone appears.
3. View the price item pricing assigned to the persons in the **Customer Agreed Price Assignments** zone.

Related Topics

For more information on...	See...
How to search for price assignments on a pricing entity	Searching for Price Assignments on a Pricing Entity on page 2355
Customer Agreed Price Assignments zone	Customer Agreed Price Assignments on page 2353

Viewing the Price Assignments Defined on the Price Lists

Procedure

To view the price assignments defined on the price lists:

1. Search for price assignments in the **Mass Pricing Update Request** screen.
2. In the **Search Results** section, click the **Broadcast** () icon corresponding to the **Price List** pricing entity type whose details you want to view.
The **Price List Price Assignments** zone appears.
3. View the price item pricing assigned to the price lists in the **Price List Price Assignments** zone.

Related Topics

For more information on...	See...
How to search for price assignments on a pricing entity	Searching for Price Assignments on a Pricing Entity on page 2355
Price List Price Assignments zone	Price List Price Assignments on page 2353

Viewing the Price Assignments Defined on the Price Lists Associated to the Products

Procedure

To view the price assignments defined on the price lists which are associated to the products:

1. Search for price assignments in the **Mass Pricing Update Request** screen.
2. In the **Search Results** section, click the **Broadcast** () icon corresponding to the **Product** pricing entity type whose details you want to view.
The **Product Price List Price Assignments** zone appears.
3. View the price item pricing assigned to the price lists which are associated to the products in the **Product Price List Price Assignments** zone.

Related Topics

For more information on...	See...
How to search for price assignments on a pricing entity	Searching for Price Assignments on a Pricing Entity on page 2355
Product Price List Price Assignments zone	Product Price List Price Assignments on page 2354

Chapter 37

Price Item, Parameter, and SQI Upload

Topics:

- [Uploading a Price Item File in the XML Format](#)
- [Uploading a Price Item File in the CSV Format](#)
- [C1-PRCITM-PR](#)
- [C1-PRICEUPL](#)
- [XML File Format for Uploading Price Items](#)
- [Sample XML Format for Uploading Price Items](#)
- [CSV File Format for Uploading Price Items](#)
- [Sample CSV Format for Uploading Price Items](#)
- [Uploading a Parameter File in the XML Format](#)
- [Uploading a Parameter File in the CSV Format](#)
- [XML File Format for Uploading Parameters](#)
- [Sample XML Format for Uploading Parameters](#)
- [CSV File Format for Uploading Parameters](#)
- [Sample CSV Format for Uploading Parameters](#)
- [Uploading an SQI File in the XML Format](#)
- [Uploading an SQI File in the CSV Format](#)
- [XML File Format for Uploading Service Quantity Identifiers \(SQIs\)](#)

There might be situations when the customer wants to move the price item, parameter, and service quantity identifier information from the legacy system to Oracle Revenue Management and Billing (ORMB). In such situations, you can use the **Price Item, Parameter, and SQI Upload** feature in ORMB to create new price items or edit the existing price items using the **File Upload Interface** utility. You can also use the **Price Item, Parameter, and SQI Upload** feature to create new parameters and SQIs using the **File Upload Interface** utility. However, at present, you cannot edit the existing parameters and SQIs using the **Price Item, Parameter, and SQI Upload** feature. You can only edit the existing parameters and SQIs from the respective user interface.

Note: If you want to edit an existing price item in the system, you must provide all details of the price item and not just the details which you want to update. This is because the **File Upload Interface** utility supports the **Replace** operation and not the **Edit** operation while editing the price item.

You can upload the price item, parameter, and SQI files in the XML or CSV format using the **File Upload Interface** utility. You can specify the following in the XML and CSV files along with the basic details of the price item:

- Parameters and divisions which you want to associate with the price item
- Characteristics for the price item
- Division-specific characteristics for the price item
- Division-specific SQIs for the price item
- Details of the price item relationship

Note: While uploading the price item file, you need to ensure that the parameters and service quantity identifiers mentioned in the price item file are already present in the system.

You can upload the price items, parameters, and SQIs from the same file or from individual files based on the business requirements. For more information, refer to [Uploading Price Items, Parameters, and SQIs from the Same File](#) on page 2423.

At present, the system does not allow you to configure the approval process for the **Price Item, Parameter, and SQI Upload** feature. Therefore, you must ensure that the files are pre-approved before uploading them in the system.

- *Sample XML Format for Uploading Service Quantity Identifiers (SQIs)*
- *CSV File Format for Uploading Service Quantity Identifiers (SQIs)*
- *Sample CSV Format for Uploading SQIs*
- *Uploading Price Items, Parameters, and SQIs from the Same File*

Uploading a Price Item File in the XML Format

To upload a price item file in the XML format using the **File Upload Interface** utility, you need to do the following:

1. Define a file request type for uploading price items in the XML format
2. Upload the price item file
3. Create or update the price items in the system

Related Topics

For more information on...	See...
How to define a file request type for uploading price items in the XML format	Defining a File Request Type for Uploading Price Items in the XML Format on page 2361
How to upload a price item file	Uploading a Price Item File on page 2361
How to create or update the price items in the system	Creating or Updating Price Items on page 2362

Defining a File Request Type for Uploading Price Items in the XML Format

Procedure

To define a file request type for uploading price items in the XML format:

1. Click the **Admin** link in the **Application** toolbar.
A list appears.
 2. From the **Admin** menu, select **F** and then click **File Request Type**.
A sub-menu appears.
 3. Click the **Add** option from the **File Request Type** sub-menu.
The **File Request Type** screen appears.
 4. Enter the file request type and description in the respective fields.
 5. Ensure that the **Extensible Markup Language** option is selected from the **File Format** list.
 6. Attach an algorithm created using the **C1-FRHVA** algorithm type to the **File Validation Algorithm** field.
 7. In the **Services** section, enter the required sequence number.
 8. Select the **Business Object** option from the **Service Type** list.
 9. Enter the **C1_PRICEITEM_BO** business object or custom price item business object in the **Service Name** field.
 10. Attach an algorithm created using the **C1-PRCITM-PR** algorithm type to the **Pre-Processing Algorithm** field corresponding to the price item business object.
- Note:** For more information about the **C1-PRCITM-PR** algorithm, refer to [C1-PRCITM-PR](#) on page 2363.
11. Select the **Add** or **Replace** option from the **Operation** list depending on whether you want to create new price items or edit the existing price items using the file request type.
 12. Click **Save**.

The file request type is defined for uploading price items in the XML format.

Uploading a Price Item File

You can upload a price item file using the **File Transformation and Upload (C1-FTRAN)** batch. While executing this batch, you must specify a file request type which is defined for uploading the price item files in the XML format. For more information about the batch, refer to *Oracle Revenue Management and Billing Batch Guide*.

Creating or Updating Price Items

You can create or edit the price items in the system using the **File Request Processing (C1-FREQP)** batch. While executing this batch, you must specify a file request type which is defined for uploading the price item files in the XML format. For more information about the batch, refer to *Oracle Revenue Management and Billing Batch Guide*.

Uploading a Price Item File in the CSV Format

To upload a price item file in the CSV format using the **File Upload Interface** utility, you need to do the following:

1. Define a file request type for uploading price items in the CSV format
2. Upload the price item file
3. Create or update the price items in the system

Related Topics

For more information on...	See...
How to define a file request type for uploading price items in the CSV format	Defining a File Request Type for Uploading Price Items in the CSV Format on page 2362
How to upload a price item file	Uploading a Price Item File on page 2363
How to create or update the price items in the system	Creating or Updating Price Items on page 2363

Defining a File Request Type for Uploading Price Items in the CSV Format

Procedure

To define a file request type for uploading price items in the CSV format:

1. Click the **Admin** link in the **Application** toolbar.
A list appears.
2. From the **Admin** menu, select **F** and then click **File Request Type**.
A sub-menu appears.
3. Click the **Add** option from the **File Request Type** sub-menu.
The **File Request Type** screen appears.
4. Enter the file request type and description in the respective fields.
5. Select the **Data Transformation Required** option.
The **File Format** field is enabled.
6. Select the **Comma Separated Values** option from the **File Format** list.
7. Enter `csv` in the **File Extension** field.
8. Attach an algorithm created using the **C1-FRHVA** algorithm type to the **File Validation Algorithm** field.
9. Attach an algorithm created using the **C1-FRTA** algorithm type to the **Data Transformation Algorithm** field.
10. In the **Services** section, enter the required sequence number.
11. Select the **Business Object** option from the **Service Type** list.

12. Enter the **C1_PRICEITEM_BO** business object or custom price item business object in the **Service Name** field.
13. Attach an algorithm created using the **C1-PRCITM-PR** algorithm type to the **Pre-Processing Algorithm** field corresponding to the price item business object.

Note: For more information about the **C1-PRCITM-PR** algorithm, refer to [C1-PRCITM-PR](#) on page 2363.

14. Select the **Add** or **Replace** option from the **Operation** list depending on whether you want to create new price items or edit the existing price items using the file request type.
15. If you have included a header in the CSV file, add the appropriate details in the **Header Transformation** section.
16. Similarly, if you have included a footer in the CSV file, add the appropriate details in the **Footer Transformation** section.
17. In the **Field Transformation** section, specify the following details:

Field Name	Field Description	Mandatory (Yes or No)
Sequence	Used to indicate the data field in the CSV record which you want to upload in the system.	Yes
Field Name	Used to indicate the field for which the data is uploaded in the system.	Yes
Map Field XPath	Used to specify the XPath of the field where you want to store the data field from the CSV record.	Yes

For example,

Sequence	Field Name	Map Field XPath
1	PRICEITEMCODE	C1_PRICEITEM_BO/priceItemCode
2	DESCRIPTION	C1_PRICEITEM_BO/description

18. Click **Save**.

The file request type is defined for uploading price items in the CSV format.

Uploading a Price Item File

You can upload a price item file using the **File Transformation and Upload (C1-FTRAN)** batch. While executing this batch, you must specify a file request type which is defined for uploading the price item files in the CSV format. For more information about the batch, refer to *Oracle Revenue Management and Billing Batch Guide*.

Creating or Updating Price Items

You can create or edit the price items in the system using the **File Request Processing (C1-FREQP)** batch. While executing this batch, you must specify a file request type which is defined for uploading the price item files in the CSV format. For more information about the batch, refer to *Oracle Revenue Management and Billing Batch Guide*.

C1-PRCITM-PR

The **C1-PRCITM-PR** algorithm does the following:

- Defaults the following fields which are required to create the price item, but are not provided by the legacy system:

Field Name	Condition	Default Value	Default Value Description
Price Item Usage	-	PRBL	Pricing and Billing
Price Item Type	Price Item Usage = PRBL	FEES	Fees
Bundle	-	No	No
Bundle Type	Price Item Usage = PRIC, Price Item Type = FEES and Bundle = Yes	REGU	Regular
Price Item Status	-	ACTV	Active
Global Price List	-	No	No

- Generates the price item parameter group using the parameter codes and parameter values for each the price item relationship.
- Validates whether the division, SQI, price item characteristic types, division-specific price item characteristic type, and parameters are already defined in the system.

Related Topics

For more information on...	See...

C1-PRICEUPL

The **C1-PRICEUPL** algorithm does the following:

- Defaults the following fields which are required to create the parameter, but are not provided by the legacy system:

Field Name	Condition	Default Value
Parameter Usage	Source Entity = TRN	Price Item

Related Topics

For more information on...	See...

XML File Format for Uploading Price Items

Before uploading a price item file through the **File Upload Interface** utility, you need to ensure that the XML file contains the following tags:

Tag Name	Tag Description	Mandatory (Yes or No)
C1_PRICEITEM_BO	Used to specify the details of the price item or price item bundle whose record you want to create or update in the system.	Yes
priceItemCode	Used to specify the price item or price item bundle.	Yes

Tag Name	Tag Description	Mandatory (Yes or No)
description	Used to specify the description for the price item or price item bundle.	Yes
priceItemAvailFor	<p>Used to indicate whether the price item or price item bundle is used for only pricing or pricing and billing. The valid values are:</p> <ul style="list-style-type: none"> • PRIC - Enables you to use the price item or price item bundle for only pricing. • PRBL - Enables you to use the price item or price item bundle for pricing and billing. 	Yes
priceItemType	<p>Used to indicate the type of the price item or price item bundle. If the price item or price item bundle is used for only pricing, the valid values are:</p> <ul style="list-style-type: none"> • FEES • RATE <p>However, if the price item or price item bundle is used for the pricing and billing, the valid value is:</p> <ul style="list-style-type: none"> • FEES 	Yes
piStatusFlag	<p>Used to indicate the status of the price item or price item bundle. The valid values are:</p> <ul style="list-style-type: none"> • ACTV - Enables you to set the price item or price item bundle to Active. • INAC - Enables you to set the price item or price item bundle to Inactive. 	Yes
bundleSw	<p>Used to indicate whether you want to define a price item bundle. The valid values are:</p> <ul style="list-style-type: none"> • Y • N 	Yes
bundleTypeFlg	<p>Used to indicate the type of the price item bundle. If the price item bundle is available for pricing and billing, the valid values are:</p> <ul style="list-style-type: none"> • PHAN - Enables you to create a phantom price item bundle. • REGU - Enables you to create a regular price item bundle. • RTIO - Enables you to create a ratio price item bundle. <p>However, if the price item bundle is available for only pricing and the price item type is set to FEES, the valid value is:</p> <ul style="list-style-type: none"> • REGU - Enables you to create a regular price item bundle. 	Yes (Conditional)
		<p>Note: This data is required when you are creating a price item bundle.</p>

Tag Name	Tag Description	Mandatory (Yes or No)						
	Note: You cannot define a price item bundle when it is available for only pricing and when the price item type is set to RATE .							
asgnGlobalPISw	Used to indicate whether the price item or price item bundle can be assigned to a global price list. The valid values are: <ul style="list-style-type: none"> • Y • N 	Yes						
saType	Used to indicate the contract type that you want to associate with the price item or price item bundle.	Yes (Conditional) <p>Note: This data is required when the price item or price item bundle is used for pricing and billing.</p>						
priceItemParm	Used to specify the details of the parameter which you want to associate with the price item or price item bundle.	No						
startDate	You can use this tag within the following tags: <table border="1" data-bbox="570 957 1154 1528"> <thead> <tr> <th>If this tag is used within...</th> <th>Then the purpose of the version tag is...</th> </tr> </thead> <tbody> <tr> <td>priceItemParm</td> <td>Used to specify the date from when the parameter is effective for the price item or price item bundle.</td> </tr> <tr> <td>priceItemRel</td> <td>Used to specify the date from when the price item or price item bundle is associated with the parent price item or added to the price item or price item bundle.</td> </tr> </tbody> </table>	If this tag is used within...	Then the purpose of the version tag is...	priceItemParm	Used to specify the date from when the parameter is effective for the price item or price item bundle.	priceItemRel	Used to specify the date from when the price item or price item bundle is associated with the parent price item or added to the price item or price item bundle.	Yes (Conditional) <p>Note: This data is required when you want to do either of the following:</p> <ul style="list-style-type: none"> • Associate a parameter with the price item or price item bundle • Associate a price item or price item bundle with the parent price item • Add a price item or price item bundle to the price item bundle
If this tag is used within...	Then the purpose of the version tag is...							
priceItemParm	Used to specify the date from when the parameter is effective for the price item or price item bundle.							
priceItemRel	Used to specify the date from when the price item or price item bundle is associated with the parent price item or added to the price item or price item bundle.							
endDate	You can use this tag within the following tags: <table border="1" data-bbox="570 1619 1154 1873"> <thead> <tr> <th>If this tag is used within...</th> <th>Then the purpose of the version tag is...</th> </tr> </thead> <tbody> <tr> <td>priceItemParm</td> <td>Used to specify the date till when the parameter is effective for the price item or price item bundle.</td> </tr> </tbody> </table>	If this tag is used within...	Then the purpose of the version tag is...	priceItemParm	Used to specify the date till when the parameter is effective for the price item or price item bundle.	No		
If this tag is used within...	Then the purpose of the version tag is...							
priceItemParm	Used to specify the date till when the parameter is effective for the price item or price item bundle.							

Tag Name	Tag Description		Mandatory (Yes or No)
	If this tag is used within...	Then the purpose of the version tag is...	
	priceItemRel	Used to specify the date till when the price item or price item bundle is associated with the parent price item or added to the price item or price item bundle.	
priceParmCode	<p>Used to indicate the parameter that you want to associate with the price item or price item bundle.</p> <p>Note: You must specify a parameter which is already defined in the system. The system allows you to specify only those parameters where the parameter usage is set to Price Item.</p>		<p>Yes (Conditional)</p> <p>Note: This data is required when you want to associate a parameter with the price item or price item bundle.</p>
overridePriceParmLabel	Used to specify a business label for the parameter. If the business label is defined for a parameter, the business label appears instead of the parameter name.		No
displayOrder	Used to indicate the order in which the parameter and its value should be displayed in the price item parameter information string across the application.		<p>Yes (Conditional)</p> <p>Note: This data is required when you want to associate a parameter with the price item or price item bundle.</p>
parmUsageFlg	<p>Used to indicate whether you want to use the parameter for aggregation and/or for defining the price item pricing. The valid values are:</p> <ul style="list-style-type: none"> • AGG - Indicates that you want to use the parameter for aggregating transactions. • PRI - Indicates that you want to use the parameter for aggregating transactions and defining the price item pricing. 		<p>Yes (Conditional)</p> <p>Note: This data is required when you want to associate a parameter with the price item or price item bundle.</p>
isRequired	<p>Used to indicate whether the parameter is mandatory while defining the price item pricing. The valid values are:</p> <ul style="list-style-type: none"> • Y • N 		No

Tag Name	Tag Description	Mandatory (Yes or No)
priorityNum	Used to indicate the priority in which optional parameters should be considered while determining best fit price for the price item or price item bundle.	Yes (Conditional) Note: This data is required when you want to associate an optional parameter with the price item or price item bundle.
priceItemParmVal	Used to specify a list of predefined parameter values which are valid for the price item or price item bundle. Note: The data should be added in this tag when the value type of the parameter is set to Predefined .	No
priceParmVal	Used to indicate the predefined parameter value which you can use for the price item or price item bundle while defining the pricing.	Yes (Conditional) Note: This data is required when you want to define valid predefined parameter values for the price item or price item bundle.
divPriceitem	Used to specify a list of divisions which you want to associate with the price item or price item bundle.	Yes
division	Used to indicate the division to which you want to associate the price item or price item bundle.	Yes
priceItemSqi	Used to specify a list of division-specific SQIs for the price item or price item bundle.	No
serviceQuantityIdentifier	Used to indicate the SQI to which you want to associate the price item or price item bundle in the division.	Yes (Conditional) Note: This data is required when you want to define a division-specific SQI for the price item or price item bundle.
sqlFragment	At present, the data from this tag is not stored in the system. If you want to use this tag, you need to implement a custom logic to meet the requirements.	Not applicable
sqiCalcAlgCd	At present, the data from this tag is not stored in the system. If you want to use this tag, you need to implement a custom logic to meet the requirements.	Not applicable
allowIncrUpdateSw	At present, the data from this tag is not stored in the system. If you want to use this tag, you need to implement a custom logic to meet the requirements.	Not applicable
divPriceItemChar	Used to specify a list of division-specific characteristics for the price item or price item bundle.	No
characteristicType	You can use this tag within the following tags:	Yes (Conditional)

Tag Name	Tag Description		Mandatory (Yes or No)						
	If this tag is used within...	Then the purpose of the version tag is...	<p>Note: This data is required when you want to do the following:</p> <ul style="list-style-type: none"> • Define a characteristic for the price item or price item bundle • Define a division-specific characteristic for the price item or price item bundle • Define a relationship-specific characteristic for the price item or price item bundle 						
divPriceItemChar	Used to specify a characteristic type when you are defining a division-specific characteristic for the price item or price item bundle.								
priceItemChar	Used to specify a characteristic type for the price item or price item bundle.								
priceItemRelCharacteristic	Used to specify a characteristic type when you are defining a relationship-specific characteristic for the price item or price item bundle.								
	<p>Note: You must specify a characteristic type which is already defined in the system. If you are defining a characteristic for:</p> <ul style="list-style-type: none"> • A Price Item - You must specify a characteristic type where the characteristic entity is set to Price Item. • A Price Item in a specific division - You must specify a characteristic type where the characteristic entity is set to Division/Price Item Combination. • A Price Item Relationship - You must specify a characteristic type where the characteristic entity is set to Price Item Relationship. 								
effectiveDate	<p>You can use this tag within the following tags:</p> <table border="1" data-bbox="570 1549 1154 1940"> <thead> <tr> <th data-bbox="570 1549 889 1633">If this tag is used within...</th> <th data-bbox="889 1549 1154 1633">Then the purpose of the version tag is...</th> </tr> </thead> <tbody> <tr> <td data-bbox="570 1633 889 1877">divPriceItemChar</td> <td data-bbox="889 1633 1154 1877">Used to specify the date from when the price item or price item bundle characteristic is effective for the division.</td> </tr> <tr> <td data-bbox="570 1877 889 1940">priceItemChar</td> <td data-bbox="889 1877 1154 1940">Used to specify the date from when</td> </tr> </tbody> </table>		If this tag is used within...	Then the purpose of the version tag is...	divPriceItemChar	Used to specify the date from when the price item or price item bundle characteristic is effective for the division.	priceItemChar	Used to specify the date from when	Yes (Conditional)
If this tag is used within...	Then the purpose of the version tag is...								
divPriceItemChar	Used to specify the date from when the price item or price item bundle characteristic is effective for the division.								
priceItemChar	Used to specify the date from when								

Tag Name	Tag Description		Mandatory (Yes or No)
	If this tag is used within...	Then the purpose of the version tag is...	<p>Note: This data is required when you want to do the following:</p> <ul style="list-style-type: none"> Define a characteristic for the price item or price item bundle Define a division-specific characteristic for the price item or price item bundle Define a relationship-specific characteristic for the price item or price item bundle
	the characteristic is effective for the price item or price item bundle.		
priceItemRelCharacteristic	Used to specify the date from when the relationship-specific characteristic is effective for the price item or price item bundle.		
characteristicValue	If this tag is used within...	Then the purpose of the version tag is...	<p>Yes (Conditional)</p> <p>Note: This data is required when you want to do the following:</p> <ul style="list-style-type: none"> Define a characteristic for the price item or price item bundle Define a division-specific characteristic for the price item or price item bundle Define a relationship-specific characteristic for the price item or price item bundle
divPriceItemChar	Used to specify the value for characteristic type when you are defining a division-specific characteristic for the price item or price item bundle.		
priceItemChar	Used to specify the value for the characteristic type when you are defining a characteristic for the price item or price item bundle.		
priceItemRelCharacteristic	Used to specify the value for the characteristic type when you are defining a relationship-specific characteristic for the price item or price item bundle.		
priceItemChar	Used to specify a list of characteristics for the price item or price item bundle.		No

Tag Name	Tag Description	Mandatory (Yes or No)
priceItemRel	Used to specify a list of price items or price item bundles that you want to associate with the parent price item or add to the price item bundle.	No
priceItemChildCd	Used to indicate the price item or price item bundle that you want to associate with the parent price item or add to the price item bundle.	Yes (Conditional) Note: This data is required when you want to do either of the following: <ul style="list-style-type: none"> Associate a price item or price item bundle with the parent price item Add a price item or price item bundle to the price item bundle
startDate	Used to specify the date from when you want to associate the price item or price item bundle with the parent price item or add the price item or price item bundle to the price item bundle.	Yes (Conditional) Note: This data is required when you want to do either of the following: <ul style="list-style-type: none"> Associate a price item or price item bundle with the parent price item Add a price item or price item bundle to the price item bundle
endDate	Used to specify the date till when you want to associate the price item or price item bundle with the parent price item or add the price item or price item bundle to the price item bundle.	No
priceItemReTypeFlg	Used to indicate how the price item or price item bundle is related to the parent price item or price item bundle. The valid values are: <ul style="list-style-type: none"> BNDL - Enables you to set the relationship type to Bundle. CG - Enables you to set the relationship type to Custom. DENB - Enables you to set the relationship type to Denominator. NUMB - Enables you to set the relationship type to Numerator. OTHR - Enables you to set the relationship type to Other. 	Yes (Conditional) Note: This data is required when you want to do either of the following: <ul style="list-style-type: none"> Associate a price item or price item bundle with the parent price item Add a price item or price item bundle to the price item bundle

Tag Name	Tag Description	Mandatory (Yes or No)
	<ul style="list-style-type: none"> • PROD - Enables you to set the relationship type to Price Item. • SVC - Enables you to set the relationship type to Service. • SVCG - Enables you to set the relationship type to Service Group. <p>Note: You must use the OTHR, CG, PROD, SVC, or SVCG relationship type while associating a price item or price item bundle to the parent price item. However, you must use the BNDL relationship type while adding a price item or price item bundle in the regular and phantom price item bundles. However, you can use the DENB and NUMB relationship type while adding a price item or price item bundle in the ratio price item bundles.</p>	
priceItemParmGroup	Used to specify the parameter and its value based on which you want to determine pricing for the price item or price item bundle.	No
priceParmCode	Used to specify the parameter using which you want to determine the pricing for the price item or price item bundle. Note: You must specify a parameter which is associated with the price item or price item bundle and whose parameter usage is set to Pricing . You cannot specify any special character except underscore (_) in the parameter name.	Yes (Conditional) Note: This data is required when you want to determine the pricing for the price item or price item bundle using a parameter.
priceParmVal	Used to specify the parameter value using which you want to determine the pricing for the price item or price item bundle. Note: You can specify any special characters except ampersand (&), comma (,), underscore (_), equal to (=), tilde (~), and semi-colon(;) in the parameter value.	Yes (Conditional) Note: This data is required when you want to determine the pricing for the price item or price item bundle using a parameter.
priceItemRelCharacteristic	Used to specify a list of relationship-specific characteristics for the price item or price item bundle.	No

Note: When you want to edit the existing price items using the **File Upload Interface** utility, you need to provide all details of the price item and not just the details which you want to update. This is because the system supports replace operation and not the edit operation while editing the price items.

Related Topics

For more information on...	See...
How to define a price item or price item bundle	Defining a Price Item or Price Item Bundle on page 361

For more information on...	See...
How to associate a price item or price item bundle with a parameter	Associating a Parameter with a Price Item or Price Item Bundle on page 369
How to associate a price item or price item bundle with a division	Associating a Price Item or Price Item Bundle with a Division on page 374
How to associate a price item or price item bundle with an SQI in a particular division	Associating an SQI with a Price Item or Price Item Bundle for a Division on page 377
How to define a characteristic for a price item or price item bundle in a particular division	Defining a Division-Specific Characteristic for a Price Item or Price Item Bundle on page 379
How to define a characteristic for a price item or price item bundle	Defining a Characteristic for a Price Item or Price Item Bundle on page 392
How to define valid predefined parameter values for a price item or price item bundle	Defining the Valid Predefined Parameter Values for a Price Item or Price Item Bundle on page 372
How to associate a price item or price item bundle with a parent price item	Associating a Price Item or Price Item Bundle with a Parent Price Item on page 424
How to add a price item or price item bundle to a price item bundle	Adding a Price Item or Price Item Bundle to a Price Item Bundle on page 426
Sample XML Format for Uploading Price Items	Sample XML Format for Uploading Price Items on page 2373

Sample XML Format for Uploading Price Items

Using the below example, you can create the following price items:

Price Items	Related Price Item	Relationship Type
Overdraft Returned	-	-
Additional Negative Balance Fees	-	-
Overdraft Assistance	Overdraft Returned	Service
	Additional Negative Balance Fees	Service Group

Note: The system will create the above price items when the required contract types, parameters, predefined parameter values, divisions, SQIs, characteristic types, predefined characteristic values are defined in the application.

```
<root>
<request>
<payload>
<Cl_PRICEITEM_BO>
  <priceItemCode>OVRDTRD</priceItemCode>
  <description>Overdraft Returned</description>
  <priceItemAvailFor>PRBL</priceItemAvailFor>
  <priceItemType></priceItemType>
  <piStatusFlag>ACTV</piStatusFlag>
  <priceItemTypeFlg></priceItemTypeFlg>
  <bundleSw>N</bundleSw>
  <bundleTypeFlg></bundleTypeFlg>
  <asgnGlobalPlSw>N</asgnGlobalPlSw>
  <saType>SAVINGS</saType>
  <priceItemParm>
```

```

<startDate>2019-01-01</startDate>
<endDate></endDate>
<priceParmCode>COUNTRY</priceParmCode>
<overridePriceParmLabel></overridePriceParmLabel>
<displayOrder>1</displayOrder>
<parmUsageFlg>PRI</parmUsageFlg>
<isRequired>Y</isRequired>
<priorityNum></priorityNum>
<priceItemParmVal>
  <priceParmVal>USA</priceParmVal>
  <priceParmVal>SWE</priceParmVal>
  <priceParmVal>CHE</priceParmVal>
  <priceParmVal>IND</priceParmVal>
  <priceParmVal>LKA</priceParmVal>
  <priceParmVal>MEX</priceParmVal>
  <priceParmVal>CHN</priceParmVal>
  <priceParmVal>JPN</priceParmVal>
</priceItemParmVal>
</priceItemParm>
<priceItemParm>
  <startDate>2019-01-01</startDate>
  <endDate></endDate>
  <priceParmCode>CURRENCY</priceParmCode>
  <overridePriceParmLabel></overridePriceParmLabel>
  <displayOrder>2</displayOrder>
  <parmUsageFlg>AGG</parmUsageFlg>
  <isRequired>N</isRequired>
  <priorityNum>1</priorityNum>
  <priceItemParmVal>
    <priceParmVal>USD</priceParmVal>
    <priceParmVal>GBP</priceParmVal>
    <priceParmVal>EUR</priceParmVal>
    <priceParmVal>INR</priceParmVal>
    <priceParmVal>LKR</priceParmVal>
    <priceParmVal>PESO</priceParmVal>
    <priceParmVal>YUAN</priceParmVal>
    <priceParmVal>YEN</priceParmVal>
  </priceItemParmVal>
</priceItemParm>
<divPriceitem>
  <division>DIV001</division>
  <priceItemSqi>
    <serviceQuantityIdentifier>ACCTBAL</serviceQuantityIdentifier>
    <sqlFragment></sqlFragment>
    <sqiCalcAlgCd></sqiCalcAlgCd>
    <allowIncrUpdateSw></allowIncrUpdateSw>
  </priceItemSqi>
  <priceItemSqi>
    <serviceQuantityIdentifier>AVGDBAL</serviceQuantityIdentifier>
    <sqlFragment></sqlFragment>
    <sqiCalcAlgCd></sqiCalcAlgCd>
    <allowIncrUpdateSw></allowIncrUpdateSw>
  </priceItemSqi>
  <divPriceItemChar>
    <characteristicType>OVERDRTPLAN</characteristicType>
    <effectiveDate>2019-01-01</effectiveDate>
    <characteristicValue>LINECRD</characteristicValue>
  </divPriceItemChar>
</divPriceitem>
<divPriceitem>
  <division>DIV002</division>
  <priceItemSqi>
    <serviceQuantityIdentifier>ACCTBAL</serviceQuantityIdentifier>
    <sqlFragment></sqlFragment>

```

```

    <sqiCalcAlgCd></sqiCalcAlgCd>
    <allowIncrUpdateSw></allowIncrUpdateSw>
  </priceItemSqi>
  <divPriceItemChar>
    <characteristicType>OVERDRTPLAN</characteristicType>
    <effectiveDate>2019-01-01</effectiveDate>
    <characteristicValue>LKDPTACT</characteristicValue>
  </divPriceItemChar>
</divPriceitem>
<priceItemChar>
  <characteristicType>ACCTTYPE</characteristicType>
  <effectiveDate>2019-01-01</effectiveDate>
  <characteristicValue>SAVINGS</characteristicValue>
</priceItemChar>
<priceItemRel>
  <priceItemChildCd></priceItemChildCd>
  <startDate></startDate>
  <endDate></endDate>
  <priceItemReTypeFlg></priceItemReTypeFlg>
  <priceItemParmGroup>
    <priceParmCode></priceParmCode>
    <priceParmVal></priceParmVal>
  </priceItemParmGroup>
  <priceItemRelCharacteristic>
    <effectiveDate></effectiveDate>
    <characteristicType></characteristicType>
    <characteristicValue></characteristicValue>
  </priceItemRelCharacteristic>
</priceItemRel>
</C1_PRICEITEM_BO>
<C1_PRICEITEM_BO>
  <priceItemCode>ADDNGFEE</priceItemCode>
  <description>Additional Negative Balance Fees</description>
  <priceItemAvailFor>PRBL</priceItemAvailFor>
  <priceItemType></priceItemType>
  <piStatusFlag>ACTV</piStatusFlag>
  <priceItemTypeFlg></priceItemTypeFlg>
  <bundleSw>N</bundleSw>
  <bundleTypeFlg></bundleTypeFlg>
  <asgnGlobalPlSw>N</asgnGlobalPlSw>
  <saType>SAVINGS</saType>
  <priceItemParm>
    <startDate>2019-01-01</startDate>
    <endDate></endDate>
    <priceParmCode>COUNTRY</priceParmCode>
    <overridePriceParmLabel></overridePriceParmLabel>
    <displayOrder>1</displayOrder>
    <parmUsageFlg>PRI</parmUsageFlg>
    <isRequired>Y</isRequired>
    <priorityNum></priorityNum>
    <priceItemParmVal>
      <priceParmVal>USA</priceParmVal>
      <priceParmVal>SWE</priceParmVal>
      <priceParmVal>CHE</priceParmVal>
      <priceParmVal>IND</priceParmVal>
      <priceParmVal>LKA</priceParmVal>
      <priceParmVal>MEX</priceParmVal>
      <priceParmVal>CHN</priceParmVal>
      <priceParmVal>JPN</priceParmVal>
    </priceItemParmVal>
  </priceItemParm>
  <priceItemParm>
    <startDate>2019-01-01</startDate>
    <endDate></endDate>

```

```

    <priceParmCode>CURRENCY</priceParmCode>
    <overridePriceParmLabel></overridePriceParmLabel>
    <displayOrder>2</displayOrder>
    <parmUsageFlg>AGG</parmUsageFlg>
    <isRequired>N</isRequired>
    <priorityNum>1</priorityNum>
    <priceItemParmVal>
      <priceParmVal>USD</priceParmVal>
      <priceParmVal>GBP</priceParmVal>
      <priceParmVal>EUR</priceParmVal>
      <priceParmVal>INR</priceParmVal>
      <priceParmVal>LKR</priceParmVal>
      <priceParmVal>PESO</priceParmVal>
      <priceParmVal>YUAN</priceParmVal>
      <priceParmVal>YEN</priceParmVal>
    </priceItemParmVal>
  </priceItemParm>
  <divPriceitem>
    <division>DIV001</division>
    <priceItemSqi>
      <serviceQuantityIdentifier>OVDLMT</
serviceQuantityIdentifier>
      <sqlFragment></sqlFragment>
      <sqiCalcAlgCd></sqiCalcAlgCd>
      <allowIncrUpdateSw></allowIncrUpdateSw>
    </priceItemSqi>
    <divPriceItemChar>
      <characteristicType>OVERDRTPPLAN</characteristicType>
      <effectiveDate>2019-01-01</effectiveDate>
      <characteristicValue>LINECRD</characteristicValue>
    </divPriceItemChar>
  </divPriceitem>
  <priceItemChar>
    <characteristicType>ACCTTYPE</characteristicType>
    <effectiveDate>2019-01-01</effectiveDate>
    <characteristicValue>SAVINGS</characteristicValue>
  </priceItemChar>
  <priceItemRel>
    <priceItemChildCd></priceItemChildCd>
    <startDate></startDate>
    <endDate></endDate>
    <priceItemReTypeFlg></priceItemReTypeFlg>
    <priceItemParmGroup>
      <priceParmCode></priceParmCode>
      <priceParmVal></priceParmVal>
    </priceItemParmGroup>
    <priceItemRelCharacteristic>
      <effectiveDate></effectiveDate>
      <characteristicType></characteristicType>
      <characteristicValue></characteristicValue>
    </priceItemRelCharacteristic>
  </priceItemRel>
</C1_PRICEITEM_BO>
<C1_PRICEITEM_BO>
  <priceItemCode>OVRDFT</priceItemCode>
  <description>Overdraft Assistance</description>
  <priceItemAvailFor>PRBL</priceItemAvailFor>
  <priceItemType></priceItemType>
  <piStatusFlag>ACTV</piStatusFlag>
  <bundleSw>N</bundleSw>
  <bundleTypeFlg></bundleTypeFlg>
  <asgnGlobalPlSw>N</asgnGlobalPlSw>
  <saType>SAVINGS</saType>
</priceItemParm>

```

```

<startDate>2019-01-01</startDate>
<endDate></endDate>
<priceParmCode>COUNTRY</priceParmCode>
<overridePriceParmLabel></overridePriceParmLabel>
<displayOrder>1</displayOrder>
<parmUsageFlg>PRI</parmUsageFlg>
<isRequired>Y</isRequired>
<priorityNum></priorityNum>
<priceItemParmVal>
  <priceParmVal>USA</priceParmVal>
  <priceParmVal>SWE</priceParmVal>
  <priceParmVal>CHE</priceParmVal>
  <priceParmVal>IND</priceParmVal>
  <priceParmVal>LKA</priceParmVal>
  <priceParmVal>MEX</priceParmVal>
  <priceParmVal>CHN</priceParmVal>
  <priceParmVal>JPN</priceParmVal>
</priceItemParmVal>
</priceItemParm>
<priceItemParm>
  <startDate>2019-01-01</startDate>
  <endDate></endDate>
  <priceParmCode>CURRENCY</priceParmCode>
  <overridePriceParmLabel></overridePriceParmLabel>
  <displayOrder>2</displayOrder>
  <parmUsageFlg>AGG</parmUsageFlg>
  <isRequired>N</isRequired>
  <priorityNum>1</priorityNum>
  <priceItemParmVal>
    <priceParmVal>USD</priceParmVal>
    <priceParmVal>GBP</priceParmVal>
    <priceParmVal>EUR</priceParmVal>
    <priceParmVal>INR</priceParmVal>
    <priceParmVal>LKR</priceParmVal>
    <priceParmVal>PESO</priceParmVal>
    <priceParmVal>YUAN</priceParmVal>
    <priceParmVal>YEN</priceParmVal>
  </priceItemParmVal>
</priceItemParm>
<divPriceitem>
  <division>DIV001</division>
  <priceItemSqi>
    <serviceQuantityIdentifier>ACCTBAL</serviceQuantityIdentifier>
    <sqlFragment></sqlFragment>
    <sqlCalcAlgCd></sqlCalcAlgCd>
    <allowIncrUpdateSw></allowIncrUpdateSw>
  </priceItemSqi>
  <priceItemSqi>
    <serviceQuantityIdentifier>AVGDBAL</serviceQuantityIdentifier>
    <sqlFragment></sqlFragment>
    <sqlCalcAlgCd></sqlCalcAlgCd>
    <allowIncrUpdateSw></allowIncrUpdateSw>
  </priceItemSqi>
  <divPriceItemChar>
    <characteristicType>OVERDRTPLAN</characteristicType>
    <effectiveDate>2019-01-01</effectiveDate>
    <characteristicValue>LINECRD</characteristicValue>
  </divPriceItemChar>
</divPriceitem>
<divPriceitem>
  <division>DIV002</division>
  <priceItemSqi>
    <serviceQuantityIdentifier>ACCTBAL</serviceQuantityIdentifier>
    <sqlFragment></sqlFragment>

```

```

        <sqiCalcAlgCd></sqiCalcAlgCd>
        <allowIncrUpdateSw></allowIncrUpdateSw>
    </priceItemSqi>
    <divPriceItemChar>
        <characteristicType>OVERDRTPLAN</characteristicType>
        <effectiveDate>2019-01-01</effectiveDate>
        <characteristicValue>LKDPTACT</characteristicValue>
    </divPriceItemChar>
</divPriceitem>
<priceItemChar>
    <characteristicType>ACCTTYPE</characteristicType>
    <effectiveDate>2019-01-01</effectiveDate>
    <characteristicValue>SAVINGS</characteristicValue>
</priceItemChar>
<priceItemRel>
    <priceItemChildCd>OVRDTRD</priceItemChildCd>
    <startDate>2019-01-01</startDate>
    <endDate></endDate>
    <priceItemReTypeFlg>SVC</priceItemReTypeFlg>
    <priceItemParmGroup>
        <priceParmCode>COUNTRY</priceParmCode>
        <priceParmVal>INDIA</priceParmVal>
    </priceItemParmGroup>
    <priceItemParmGroup>
        <priceParmCode>CURRENCY</priceParmCode>
        <priceParmVal>INR</priceParmVal>
    </priceItemParmGroup>
    <priceItemRelCharacteristic>
        <effectiveDate>2019-01-01</effectiveDate>
        <characteristicType>APPRD</characteristicType>
        <characteristicValue>Y</characteristicValue>
    </priceItemRelCharacteristic>
</priceItemRel>
<priceItemRel>
    <priceItemChildCd>ADDNGFEE</priceItemChildCd>
    <startDate>2019-01-01</startDate>
    <endDate></endDate>
    <priceItemReTypeFlg>SVCG</priceItemReTypeFlg>
    <priceItemParmGroup>
        <priceParmCode>COUNTRY</priceParmCode>
        <priceParmVal>INDIA</priceParmVal>
    </priceItemParmGroup>
    <priceItemParmGroup>
        <priceParmCode>CURRENCY</priceParmCode>
        <priceParmVal>INR</priceParmVal>
    </priceItemParmGroup>
    <priceItemRelCharacteristic>
        <effectiveDate>2019-01-01</effectiveDate>
        <characteristicType>APPRD</characteristicType>
        <characteristicValue>Y</characteristicValue>
    </priceItemRelCharacteristic>
</priceItemRel>
</C1_PRICEITEM_BO>
</payload>
</request>
</root>

```

Related Topics

For more information on...	See...
XML File Format for Uploading Price Items	XML File Format for Uploading Price Items on page 2364

CSV File Format for Uploading Price Items

Before uploading a price item file through the **File Upload Interface** utility, you need to ensure that the CSV file contains the following data:

Data	Description	Mandatory (Yes or No)
Price Item	Used to specify the price item or price item bundle.	Yes
Description	Used to specify the description for the price item or price item bundle.	Yes
Price Item Usage	Used to indicate whether the price item or price item bundle is used for only pricing or pricing and billing. The valid values are: <ul style="list-style-type: none"> • PRIC - Enables you to use the price item or price item bundle for only pricing. • PRBL - Enables you to use the price item or price item bundle for pricing and billing. 	Yes
Price Item Type	Used to indicate the type of the price item or price item bundle. If the price item or price item bundle is used for only pricing, the valid values are: <ul style="list-style-type: none"> • FEES • RATE However, if the price item or price item bundle is used for the pricing and billing, the valid value is: <ul style="list-style-type: none"> • FEES 	Yes
Status	Used to indicate the status of the price item or price item bundle. The valid values are: <ul style="list-style-type: none"> • ACTV - Enables you to set the price item or price item bundle to Active. • INAC - Enables you to set the price item or price item bundle to Inactive. 	Yes
Bundle	Used to indicate whether you want to define a price item bundle. The valid values are: <ul style="list-style-type: none"> • Y • N 	Yes
Bundle Type	Used to indicate the type of the price item bundle. If the price item bundle is available for pricing and billing, the valid values are: <ul style="list-style-type: none"> • PHAN - Enables you to create a phantom price item bundle. • REGU - Enables you to create a regular price item bundle. 	Yes (Conditional) <div style="border: 1px solid black; padding: 5px; margin-top: 10px;"> Note: This data is required when you are creating a price item bundle. </div>

Data	Description	Mandatory (Yes or No)
	<ul style="list-style-type: none"> • RTIO - Enables you to create a ratio price item bundle. <p>However, if the price item bundle is available for only pricing and the price item type is set to FEES, the valid value is:</p> <ul style="list-style-type: none"> • REGU - Enables you to create a regular price item bundle. <div data-bbox="483 485 1049 600" style="border: 1px solid black; padding: 5px;"> <p>Note: You cannot define a price item bundle when it is available for only pricing and when the price item type is set to RATE.</p> </div>	
Global Price List	<p>Used to indicate whether the price item or price item bundle can be assigned to a global price list. The valid values are:</p> <ul style="list-style-type: none"> • Y • N 	Yes
Contract Type	<p>Used to indicate the contract type that you want to associate with the price item or price item bundle.</p>	<p>Yes (Conditional)</p> <div data-bbox="1092 898 1438 1045" style="border: 1px solid black; padding: 5px;"> <p>Note: This data is required when the price item or price item bundle is used for pricing and billing.</p> </div>
Price Item Parameter Information		
Effective Start Date	<p>Used to specify the date from when the parameter is effective for the price item or price item bundle.</p>	<p>Yes (Conditional)</p> <div data-bbox="1092 1182 1438 1329" style="border: 1px solid black; padding: 5px;"> <p>Note: This data is required when you want to associate a parameter with the price item or price item bundle.</p> </div>
Effective End Date	<p>Used to specify the date till when the parameter is effective for the price item or price item bundle.</p>	No
Parameter	<p>Used to indicate the parameter that you want to associate with the price item or price item bundle.</p> <div data-bbox="483 1535 1049 1797" style="border: 1px solid black; padding: 5px;"> <p>Note:</p> <p>You must specify a parameter which is already defined in the system.</p> <p>The system allows you to specify only those parameters where the parameter usage is set to Price Item.</p> </div>	<p>Yes (Conditional)</p> <div data-bbox="1092 1503 1438 1650" style="border: 1px solid black; padding: 5px;"> <p>Note: This data is required when you want to associate a parameter with the price item or price item bundle.</p> </div>
Business Label	<p>Used to specify a business label for the parameter. If the business label is defined for a parameter,</p>	No

Data	Description	Mandatory (Yes or No)
	the business label appears instead of the parameter name.	
Display Order	Used to indicate the order in which the parameter and its value should be displayed in the price item parameter information string across the application.	Yes (Conditional) Note: This data is required when you want to associate a parameter with the price item or price item bundle.
Parameter Usage	Used to indicate whether you want to use the parameter for aggregation and/or for defining the price item pricing. The valid values are: <ul style="list-style-type: none"> • AGG - Indicates that you want to use the parameter for aggregating transactions. • PRI - Indicates that you want to use the parameter for aggregating transactions and defining the price item pricing. 	Yes (Conditional) Note: This data is required when you want to associate a parameter with the price item or price item bundle.
Mandatory	Used to indicate whether the parameter is mandatory while defining the price item pricing. The valid values are: <ul style="list-style-type: none"> • Y • N 	No
Priority	Used to indicate the priority in which optional parameters should be considered while determining best fit price for the price item or price item bundle.	Yes (Conditional) Note: This data is required when you want to associate an optional parameter with the price item or price item bundle.
Predefined Parameter Values for Price Item		
Predefined Parameter Value for Price Item	Used to indicate the predefined parameter value which you can use for the price item or price item bundle while defining the pricing.	Yes (Conditional) Note: This data is required when you want to define valid predefined parameter values for the price item or price item bundle.
Division Information		
Division	Used to indicate the division to which you want to associate the price item or price item bundle.	Yes
Division-Specific SQIs for Price Item		

Data	Description	Mandatory (Yes or No)
SQI	Used to indicate the SQI to which you want to associate the price item or price item bundle in the division.	Yes (Conditional) Note: This data is required when you want to define a division-specific SQI for the price item or price item bundle.
Division-Specific Characteristics for Price Item		
Characteristic Type	Used to specify the characteristic type. Note: You must specify a characteristic type which is already defined in the system. You must specify a characteristic type where the characteristic entity is set to Division/Price Item Combination .	Yes (Conditional) Note: This data is required when you are defining a division-specific characteristic for the price item or price item bundle.
Effective Date	Used to specify the date from when the price item or price item bundle characteristic is effective for the division.	Yes (Conditional) Note: This data is required when you are defining a division-specific characteristic for the price item or price item bundle.
Characteristic Value	Used to specify the value for the characteristic type.	Yes (Conditional) Note: This data is required when you are defining a division-specific characteristic for the price item or price item bundle.
Price Item Characteristics		
Characteristic Type	Used to specify the characteristic type. Note: You must specify a characteristic type which is already defined in the system. You must specify a characteristic type where the characteristic entity is set to Price Item .	Yes (Conditional) Note: This data is required when you are defining a characteristic for the price item or price item bundle.
Effective Date	Used to specify the date from when the characteristic is effective for the price item or price item bundle.	Yes (Conditional) Note: This data is required when you are defining a characteristic for the price item or price item bundle.

Data	Description	Mandatory (Yes or No)
Characteristic Value	Used to specify the value for the characteristic type.	Yes (Conditional) <div style="border: 1px solid black; padding: 5px; margin-top: 5px;"> <p>Note: This data is required when you are defining a characteristic for the price item or price item bundle.</p> </div>
Price Item Relationship		
Price Item	Used to indicate the price item or price item bundle that you want to associate with the parent price item or add to the price item bundle.	Yes (Conditional) <div style="border: 1px solid black; padding: 5px; margin-top: 5px;"> <p>Note: This data is required when you want to do either of the following:</p> <ul style="list-style-type: none"> Associate a price item or price item bundle with the parent price item Add a price item or price item bundle to the price item bundle </div>
Effective Start Date	Used to specify the date from when you want to associate the price item or price item bundle with the parent price item or add the price item or price item bundle to the price item bundle.	Yes (Conditional) <div style="border: 1px solid black; padding: 5px; margin-top: 5px;"> <p>Note: This data is required when you want to do either of the following:</p> <ul style="list-style-type: none"> Associate a price item or price item bundle with the parent price item Add a price item or price item bundle to the price item bundle </div>
Effective End Date	Used to specify the date till when you want to associate the price item or price item bundle with the parent price item or add the price item or price item bundle to the price item bundle.	No
Relationship Type	Used to indicate how the price item or price item bundle is related to the parent price item or price item bundle. The valid values are: <ul style="list-style-type: none"> BNDL - Enables you to set the relationship type to Bundle. CG - Enables you to set the relationship type to Custom. DENB - Enables you to set the relationship type to Denominator. NUMB - Enables you to set the relationship type to Numerator. 	Yes (Conditional) <div style="border: 1px solid black; padding: 5px; margin-top: 5px;"> <p>Note: This data is required when you want to do either of the following:</p> <ul style="list-style-type: none"> Associate a price item or price item bundle with the parent price item Add a price item or price item bundle to the price item bundle </div>

Data	Description	Mandatory (Yes or No)
	<ul style="list-style-type: none"> • OTHR - Enables you to set the relationship type to Other. • PROD - Enables you to set the relationship type to Price Item. • SVC - Enables you to set the relationship type to Service. • SVCG - Enables you to set the relationship type to Service Group. <div style="border: 1px solid black; padding: 5px; margin-top: 10px;"> <p>Note: You must use the OTHR, CG, PROD, SVC, or SVCG relationship type while associating a price item or price item bundle to the parent price item. However, you must use the BNDL relationship type while adding a price item or price item bundle in the regular and phantom price item bundles. However, you can use the DENB and NUMB relationship type while adding a price item or price item bundle in the ratio price item bundles.</p> </div>	
Price Item Parameter=Parameter Value	<p>Used to specify the parameter and its value using which you want to determine the pricing for the child price item or price item bundle.</p> <div style="border: 1px solid black; padding: 5px; margin-top: 10px;"> <p>Note: You must specify a parameter which is associated with the price item or price item bundle and whose parameter usage is set to Pricing. You cannot specify any special character except underscore (_) in the parameter name. You can specify any special characters except ampersand (&), comma (,), underscore (_), equal to (=), tilde (~), and semi-colon (;) in the parameter value. You cannot specify more than 50 parameter and parameter value combinations while uploading the price item file in the CSV format.</p> </div>	<p>Yes (Conditional)</p> <div style="border: 1px solid black; padding: 5px; margin-top: 10px;"> <p>Note: This data is required when you want to determine the pricing for the child price item or price item bundle using a parameter.</p> </div>
Relationship-Specific Characteristics for Price Item		
Characteristic Type	<p>Used to specify the characteristic type.</p> <div style="border: 1px solid black; padding: 5px; margin-top: 10px;"> <p>Note: You must specify a characteristic type which is already defined in the system. You must specify a characteristic type where the characteristic entity is set to Price Item Relationship.</p> </div>	<p>Yes (Conditional)</p> <div style="border: 1px solid black; padding: 5px; margin-top: 10px;"> <p>Note: This data is required when you are defining a relationship-specific characteristic for the price item or price item bundle.</p> </div>

Data	Description	Mandatory (Yes or No)
Effective Date	Used to specify the date from when the relationship-specific characteristic is effective for the price item or price item bundle.	Yes (Conditional) Note: This data is required when you are defining a relationship-specific characteristic for the price item or price item bundle.
Characteristic Value	Used to specify the value for the characteristic type.	Yes (Conditional) Note: This data is required when you are defining a relationship-specific characteristic for the price item or price item bundle.

Related Topics

For more information on...	See...
How to define a price item or price item bundle	Defining a Price Item or Price Item Bundle on page 361
How to associate a price item or price item bundle with a parameter	Associating a Parameter with a Price Item or Price Item Bundle on page 369
How to associate a price item or price item bundle with a division	Associating a Price Item or Price Item Bundle with a Division on page 374
How to associate a price item or price item bundle with an SQI in a particular division	Associating an SQI with a Price Item or Price Item Bundle for a Division on page 377
How to define a characteristic for a price item or price item bundle in a particular division	Defining a Division-Specific Characteristic for a Price Item or Price Item Bundle on page 379
How to define a characteristic for a price item or price item bundle	Defining a Characteristic for a Price Item or Price Item Bundle on page 392
How to define valid predefined parameter values for a price item or price item bundle	Defining the Valid Predefined Parameter Values for a Price Item or Price Item Bundle on page 372
How to associate a price item or price item bundle with a parent price item	Associating a Price Item or Price Item Bundle with a Parent Price Item on page 424
How to add a price item or price item bundle to a price item bundle	Adding a Price Item or Price Item Bundle to a Price Item Bundle on page 426
Sample CSV Format for Uploading Price Items	Sample CSV Format for Uploading Price Items on page 2385

Sample CSV Format for Uploading Price Items

Using the below example, you can create the following price items:

Price Item	Related Price Item	Relationship Type
Overdraft Returned	-	-

Price Item	Related Price Item	Relationship Type
Additional Negative Balance Fees	-	-
Overdraft Assistance	Overdraft Returned	Service
	Additional Negative Balance Fees	Service Group

Note: The system will create the above price items when the required contract types, parameters, predefined parameter values, divisions, SQIs, characteristic types, predefined characteristic values are defined in the application.

In addition, the file request type which is used for uploading the price item file in the CSV format must contain the following field transformation details:

Sequence	Field Name	Map Field XPath
1	Price Item	C1_PRICEITEM_BO/priceItemCode
2	Description	C1_PRICEITEM_BO/description
3	Price Item Usage	C1_PRICEITEM_BO/priceItemAvailFor
4	Price Item Type	C1_PRICEITEM_BO/priceItemType
5	Status	C1_PRICEITEM_BO/piStatusFlag
6	Bundle	C1_PRICEITEM_BO/bundleSw
7	Bundle Type	C1_PRICEITEM_BO/bundleTypeFlg
8	Global Price List	C1_PRICEITEM_BO/asgnGlobalPISw
9	Contract type	C1_PRICEITEM_BO/saType
10	Effective Start Date	C1_PRICEITEM_BO/0/priceItemParm/startDate
11	Effective End Date	C1_PRICEITEM_BO/0/priceItemParm/endDate
12	Parameter	C1_PRICEITEM_BO/0/priceItemParm/ priceParmCode
13	Business Label	C1_PRICEITEM_BO/0/priceItemParm/ overridePriceParmLabel
14	Display Order	C1_PRICEITEM_BO/0/priceItemParm/displayOrder
15	Parameter Usage	C1_PRICEITEM_BO/0/priceItemParm/parmUsageFlg
16	Mandatory	C1_PRICEITEM_BO/0/priceItemParm/isRequired
17	Priority	C1_PRICEITEM_BO/0/priceItemParm/priorityNum
18	Parameter Value	C1_PRICEITEM_BO/0/priceItemParm/0/ priceItemParmVal/priceParmVal

Sequence	Field Name	Map Field XPath
19	Parameter Value	C1_PRICEITEM_BO/0/priceItemParm/1/ priceItemParmVal/priceParmVal
20	Parameter Value	C1_PRICEITEM_BO/0/priceItemParm/2/ priceItemParmVal/priceParmVal
21	Parameter Value	C1_PRICEITEM_BO/0/priceItemParm/3/ priceItemParmVal/priceParmVal
22	Parameter Value	C1_PRICEITEM_BO/0/priceItemParm/4/ priceItemParmVal/priceParmVal
23	Parameter Value	C1_PRICEITEM_BO/0/priceItemParm/5/ priceItemParmVal/priceParmVal
24	Parameter Value	C1_PRICEITEM_BO/0/priceItemParm/6/ priceItemParmVal/priceParmVal
25	Parameter Value	C1_PRICEITEM_BO/0/priceItemParm/7/ priceItemParmVal/priceParmVal
26	Effective Start Date	C1_PRICEITEM_BO/1/priceItemParm/startDate
27	Effective End Date	C1_PRICEITEM_BO/1/priceItemParm/endDate
28	Parameter	C1_PRICEITEM_BO/1/priceItemParm/ priceParmCode
29	Business Label	C1_PRICEITEM_BO/1/priceItemParm/ overridePriceParmLabel
30	Display Order	C1_PRICEITEM_BO/1/priceItemParm/displayOrder
31	Parameter Usage	C1_PRICEITEM_BO/1/priceItemParm/parmUsageFlg
32	Mandatory	C1_PRICEITEM_BO/1/priceItemParm/isRequired
33	Priority	C1_PRICEITEM_BO/1/priceItemParm/priorityNum
34	Parameter Value	C1_PRICEITEM_BO/1/priceItemParm/0/ priceItemParmVal/priceParmVal
35	Parameter Value	C1_PRICEITEM_BO/1/priceItemParm/1/ priceItemParmVal/priceParmVal
36	Parameter Value	C1_PRICEITEM_BO/1/priceItemParm/2/ priceItemParmVal/priceParmVal
37	Parameter Value	C1_PRICEITEM_BO/1/priceItemParm/3/ priceItemParmVal/priceParmVal
38	Parameter Value	C1_PRICEITEM_BO/1/priceItemParm/4/ priceItemParmVal/priceParmVal

Sequence	Field Name	Map Field XPath
39	Parameter Value	C1_PRICEITEM_BO/1/priceItemParm/5/ priceItemParmVal/priceParmVal
40	Parameter Value	C1_PRICEITEM_BO/1/priceItemParm/6/ priceItemParmVal/priceParmVal
41	Parameter Value	C1_PRICEITEM_BO/1/priceItemParm/7/ priceItemParmVal/priceParmVal
42	Division	C1_PRICEITEM_BO/0/divPriceitem/division
43	SQI	C1_PRICEITEM_BO/0/divPriceitem/0/priceItemSqi/ serviceQuantityIdentifier
44	SQI	C1_PRICEITEM_BO/0/divPriceitem/1/priceItemSqi/ serviceQuantityIdentifier
45	Characteristic Type	C1_PRICEITEM_BO/0/divPriceitem/0/ divPriceItemChar/characteristicType
46	Effective Date	C1_PRICEITEM_BO/0/divPriceitem/0/ divPriceItemChar/effectiveDate
47	Characteristic Value	C1_PRICEITEM_BO/0/divPriceitem/0/ divPriceItemChar/characteristicValue
48	Characteristic Type	C1_PRICEITEM_BO/0/divPriceitem/1/ divPriceItemChar/characteristicType
49	Effective Date	C1_PRICEITEM_BO/0/divPriceitem/1/ divPriceItemChar/effectiveDate
50	Characteristic Value	C1_PRICEITEM_BO/0/divPriceitem/1/ divPriceItemChar/characteristicValue
51	Division	C1_PRICEITEM_BO/1/divPriceitem/division
52	SQI	C1_PRICEITEM_BO/1/divPriceitem/0/priceItemSqi/ serviceQuantityIdentifier
53	Characteristic Type	C1_PRICEITEM_BO/1/divPriceitem/0/ divPriceItemChar/characteristicType
54	Effective Date	C1_PRICEITEM_BO/1/divPriceitem/0/ divPriceItemChar/effectiveDate
55	Characteristic Value	C1_PRICEITEM_BO/1/divPriceitem/0/ divPriceItemChar/characteristicValue
56	Characteristic Type	C1_PRICEITEM_BO/0/priceItemChar/ characteristicType
57	Effective Date	C1_PRICEITEM_BO/0/priceItemChar/effectiveDate

Sequence	Field Name	Map Field XPath
58	Characteristic Value	C1_PRICEITEM_BO/0/priceItemChar/ characteristicValue
59	Price Item	C1_PRICEITEM_BO/0/priceItemRel/ priceItemChildCd
60	Effective Start Date	C1_PRICEITEM_BO/0/priceItemRel/startDate
61	Effective End Date	C1_PRICEITEM_BO/0/priceItemRel/endDate
62	Relationship Type	C1_PRICEITEM_BO/0/priceItemRel/ priceItemReTypeFlg
63	REL0PARMCD0PARMVAL0	-
64	REL0PARMCD1PARMVAL1	-
65	Effective Date	C1_PRICEITEM_BO/0/priceItemRel/0/ priceItemRelCharacteristic/effectiveDate
66	Characteristic Type	C1_PRICEITEM_BO/0/priceItemRel/0/ priceItemRelCharacteristic/characteristicType
67	Characteristic Value	C1_PRICEITEM_BO/0/priceItemRel/0/ priceItemRelCharacteristic/characteristicValue
68	Price Item	C1_PRICEITEM_BO/1/priceItemRel/ priceItemChildCd
69	Effective Start Date	C1_PRICEITEM_BO/1/priceItemRel/startDate
70	Effective End Date	C1_PRICEITEM_BO/1/priceItemRel/endDate
71	Relationship Type	C1_PRICEITEM_BO/1/priceItemRel/ priceItemReTypeFlg
72	REL1PARMCD0PARMVAL0	-
73	REL1PARMCD1PARMVAL1	-
74	Effective Date	C1_PRICEITEM_BO/1/priceItemRel/0/ priceItemRelCharacteristic/effectiveDate
75	Characteristic Type	C1_PRICEITEM_BO/1/priceItemRel/0/ priceItemRelCharacteristic/characteristicType
76	Characteristic Value	C1_PRICEITEM_BO/1/priceItemRel/0/ priceItemRelCharacteristic/characteristicValue
77	Price Item	C1_PRICEITEM_BO/priceItemCode
78	Description	C1_PRICEITEM_BO/description
79	Price Item Usage	C1_PRICEITEM_BO/priceItemAvailFor

Sequence	Field Name	Map Field XPath
80	Price Item Type	C1_PRICEITEM_BO/priceItemType
81	Status	C1_PRICEITEM_BO/piStatusFlag
82	Bundle	C1_PRICEITEM_BO/bundleSw
83	Bundle Type	C1_PRICEITEM_BO/bundleTypeFlg
84	Global Price List	C1_PRICEITEM_BO/asgnGlobalPISw
85	Contract type	C1_PRICEITEM_BO/saType
86	Effective Start Date	C1_PRICEITEM_BO/0/priceItemParm/startDate
87	Effective End Date	C1_PRICEITEM_BO/0/priceItemParm/endDate
88	Parameter	C1_PRICEITEM_BO/0/priceItemParm/ priceParamCode
89	Business Label	C1_PRICEITEM_BO/0/priceItemParm/ overridePriceParamLabel
90	Display Order	C1_PRICEITEM_BO/0/priceItemParm/displayOrder
91	Parameter Usage	C1_PRICEITEM_BO/0/priceItemParm/paramUsageFlg
92	Mandatory	C1_PRICEITEM_BO/0/priceItemParm/isRequired
93	Priority	C1_PRICEITEM_BO/0/priceItemParm/priorityNum
94	Parameter Value	C1_PRICEITEM_BO/0/priceItemParm/0/ priceItemParmVal/priceParamVal
95	Parameter Value	C1_PRICEITEM_BO/0/priceItemParm/1/ priceItemParmVal/priceParamVal
96	Parameter Value	C1_PRICEITEM_BO/0/priceItemParm/2/ priceItemParmVal/priceParamVal
97	Parameter Value	C1_PRICEITEM_BO/0/priceItemParm/3/ priceItemParmVal/priceParamVal
98	Parameter Value	C1_PRICEITEM_BO/0/priceItemParm/4/ priceItemParmVal/priceParamVal
99	Parameter Value	C1_PRICEITEM_BO/0/priceItemParm/5/ priceItemParmVal/priceParamVal
100	Parameter Value	C1_PRICEITEM_BO/0/priceItemParm/6/ priceItemParmVal/priceParamVal
101	Parameter Value	C1_PRICEITEM_BO/0/priceItemParm/7/ priceItemParmVal/priceParamVal
102	Effective Start Date	C1_PRICEITEM_BO/1/priceItemParm/startDate

Sequence	Field Name	Map Field XPath
103	Effective End Date	C1_PRICEITEM_BO/1/priceItemParm/endDate
104	Parameter	C1_PRICEITEM_BO/1/priceItemParm/ priceParmCode
105	Business Label	C1_PRICEITEM_BO/1/priceItemParm/ overridePriceParmLabel
106	Display Order	C1_PRICEITEM_BO/1/priceItemParm/displayOrder
107	Parameter Usage	C1_PRICEITEM_BO/1/priceItemParm/parmUsageFlg
108	Mandatory	C1_PRICEITEM_BO/1/priceItemParm/isRequired
109	Priority	C1_PRICEITEM_BO/1/priceItemParm/priorityNum
110	Parameter Value	C1_PRICEITEM_BO/1/priceItemParm/0/ priceItemParmVal/priceParmVal
111	Parameter Value	C1_PRICEITEM_BO/1/priceItemParm/1/ priceItemParmVal/priceParmVal
112	Parameter Value	C1_PRICEITEM_BO/1/priceItemParm/2/ priceItemParmVal/priceParmVal
113	Parameter Value	C1_PRICEITEM_BO/1/priceItemParm/3/ priceItemParmVal/priceParmVal
114	Parameter Value	C1_PRICEITEM_BO/1/priceItemParm/4/ priceItemParmVal/priceParmVal
115	Parameter Value	C1_PRICEITEM_BO/1/priceItemParm/5/ priceItemParmVal/priceParmVal
116	Parameter Value	C1_PRICEITEM_BO/1/priceItemParm/6/ priceItemParmVal/priceParmVal
117	Parameter Value	C1_PRICEITEM_BO/1/priceItemParm/7/ priceItemParmVal/priceParmVal
118	Division	C1_PRICEITEM_BO/0/divPriceitem/division
119	SQI	C1_PRICEITEM_BO/0/divPriceitem/0/priceItemSqi/ serviceQuantityIdentifier
120	SQI	C1_PRICEITEM_BO/0/divPriceitem/1/priceItemSqi/ serviceQuantityIdentifier
121	Characteristic Type	C1_PRICEITEM_BO/0/divPriceitem/0/ divPriceItemChar/characteristicType
122	Effective Date	C1_PRICEITEM_BO/0/divPriceitem/0/ divPriceItemChar/effectiveDate

Sequence	Field Name	Map Field XPath
123	Characteristic Value	C1_PRICEITEM_BO/0/divPriceitem/0/divPriceItemChar/characteristicValue
124	Characteristic Type	C1_PRICEITEM_BO/0/divPriceitem/1/divPriceItemChar/characteristicType
125	Effective Date	C1_PRICEITEM_BO/0/divPriceitem/1/divPriceItemChar/effectiveDate
126	Characteristic Value	C1_PRICEITEM_BO/0/divPriceitem/1/divPriceItemChar/characteristicValue
127	Division	C1_PRICEITEM_BO/1/divPriceitem/division
128	SQI	C1_PRICEITEM_BO/1/divPriceitem/0/priceItemSqi/serviceQuantityIdentifier
129	Characteristic Type	C1_PRICEITEM_BO/1/divPriceitem/0/divPriceItemChar/characteristicType
130	Effective Date	C1_PRICEITEM_BO/1/divPriceitem/0/divPriceItemChar/effectiveDate
131	Characteristic Value	C1_PRICEITEM_BO/1/divPriceitem/0/divPriceItemChar/characteristicValue
132	Characteristic Type	C1_PRICEITEM_BO/0/priceItemChar/characteristicType
133	Effective Date	C1_PRICEITEM_BO/0/priceItemChar/effectiveDate
134	Characteristic Value	C1_PRICEITEM_BO/0/priceItemChar/characteristicValue
135	Price Item	C1_PRICEITEM_BO/0/priceItemRel/priceItemChildCd
136	Effective Start Date	C1_PRICEITEM_BO/0/priceItemRel/startDate
137	Effective End Date	C1_PRICEITEM_BO/0/priceItemRel/endDate
138	Relationship Type	C1_PRICEITEM_BO/0/priceItemRel/priceItemReTypeFlg
139	REL0PARMCD0PARMVAL0	-
140	REL0PARMCD1PARMVAL1	-
141	Effective Date	C1_PRICEITEM_BO/0/priceItemRel/0/priceItemRelCharacteristic/effectiveDate
142	Characteristic Type	C1_PRICEITEM_BO/0/priceItemRel/0/priceItemRelCharacteristic/characteristicType

Sequence	Field Name	Map Field XPath
143	Characteristic Value	C1_PRICEITEM_BO/0/priceItemRel/0/ priceItemRelCharacteristic/characteristicValue
144	Price Item	C1_PRICEITEM_BO/1/priceItemRel/ priceItemChildCd
145	Effective Start Date	C1_PRICEITEM_BO/1/priceItemRel/startDate
146	Effective End Date	C1_PRICEITEM_BO/1/priceItemRel/endDate
147	Relationship Type	C1_PRICEITEM_BO/1/priceItemRel/ priceItemReTypeFlg
148	REL1PARMCD0PARMVAL0	-
149	REL1PARMCD1PARMVAL1	-
150	Effective Date	C1_PRICEITEM_BO/1/priceItemRel/0/ priceItemRelCharacteristic/effectiveDate
151	Characteristic Type	C1_PRICEITEM_BO/1/priceItemRel/0/ priceItemRelCharacteristic/characteristicType
152	Characteristic Value	C1_PRICEITEM_BO/1/priceItemRel/0/ priceItemRelCharacteristic/characteristicValue
153	Price Item	C1_PRICEITEM_BO/priceItemCode
154	Description	C1_PRICEITEM_BO/description
155	Price Item Usage	C1_PRICEITEM_BO/priceItemAvailFor
156	Price Item Type	C1_PRICEITEM_BO/priceItemType
157	Status	C1_PRICEITEM_BO/piStatusFlag
158	Bundle	C1_PRICEITEM_BO/bundleSw
159	Bundle Type	C1_PRICEITEM_BO/bundleTypeFlg
160	Global Price List	C1_PRICEITEM_BO/asgnGlobalPISw
161	Contract type	C1_PRICEITEM_BO/saType
162	Effective Start Date	C1_PRICEITEM_BO/0/priceItemParm/startDate
163	Effective End Date	C1_PRICEITEM_BO/0/priceItemParm/endDate
164	Parameter	C1_PRICEITEM_BO/0/priceItemParm/ priceParmCode
165	Business Label	C1_PRICEITEM_BO/0/priceItemParm/ overridePriceParmLabel
166	Display Order	C1_PRICEITEM_BO/0/priceItemParm/displayOrder

Sequence	Field Name	Map Field XPath
167	Parameter Usage	C1_PRICEITEM_BO/0/priceItemParm/parmUsageFlg
168	Mandatory	C1_PRICEITEM_BO/0/priceItemParm/isRequired
169	Priority	C1_PRICEITEM_BO/0/priceItemParm/priorityNum
170	Parameter Value	C1_PRICEITEM_BO/0/priceItemParm/0/ priceItemParmVal/priceParmVal
171	Parameter Value	C1_PRICEITEM_BO/0/priceItemParm/1/ priceItemParmVal/priceParmVal
172	Parameter Value	C1_PRICEITEM_BO/0/priceItemParm/2/ priceItemParmVal/priceParmVal
173	Parameter Value	C1_PRICEITEM_BO/0/priceItemParm/3/ priceItemParmVal/priceParmVal
174	Parameter Value	C1_PRICEITEM_BO/0/priceItemParm/4/ priceItemParmVal/priceParmVal
175	Parameter Value	C1_PRICEITEM_BO/0/priceItemParm/5/ priceItemParmVal/priceParmVal
176	Parameter Value	C1_PRICEITEM_BO/0/priceItemParm/6/ priceItemParmVal/priceParmVal
177	Parameter Value	C1_PRICEITEM_BO/0/priceItemParm/7/ priceItemParmVal/priceParmVal
178	Effective Start Date	C1_PRICEITEM_BO/1/priceItemParm/startDate
179	Effective End Date	C1_PRICEITEM_BO/1/priceItemParm/endDate
180	Parameter	C1_PRICEITEM_BO/1/priceItemParm/ priceParmCode
181	Business Label	C1_PRICEITEM_BO/1/priceItemParm/ overridePriceParmLabel
182	Display Order	C1_PRICEITEM_BO/1/priceItemParm/displayOrder
183	Parameter Usage	C1_PRICEITEM_BO/1/priceItemParm/parmUsageFlg
184	Mandatory	C1_PRICEITEM_BO/1/priceItemParm/isRequired
185	Priority	C1_PRICEITEM_BO/1/priceItemParm/priorityNum
186	Parameter Value	C1_PRICEITEM_BO/1/priceItemParm/0/ priceItemParmVal/priceParmVal
187	Parameter Value	C1_PRICEITEM_BO/1/priceItemParm/1/ priceItemParmVal/priceParmVal

Sequence	Field Name	Map Field XPath
188	Parameter Value	C1_PRICEITEM_BO/1/priceItemParm/2/ priceItemParmVal/priceParmVal
189	Parameter Value	C1_PRICEITEM_BO/1/priceItemParm/3/ priceItemParmVal/priceParmVal
190	Parameter Value	C1_PRICEITEM_BO/1/priceItemParm/4/ priceItemParmVal/priceParmVal
191	Parameter Value	C1_PRICEITEM_BO/1/priceItemParm/5/ priceItemParmVal/priceParmVal
192	Parameter Value	C1_PRICEITEM_BO/1/priceItemParm/6/ priceItemParmVal/priceParmVal
193	Parameter Value	C1_PRICEITEM_BO/1/priceItemParm/7/ priceItemParmVal/priceParmVal
194	Division	C1_PRICEITEM_BO/0/divPriceitem/division
195	SQI	C1_PRICEITEM_BO/0/divPriceitem/0/priceItemSqi/ serviceQuantityIdentifier
196	SQI	C1_PRICEITEM_BO/0/divPriceitem/1/priceItemSqi/ serviceQuantityIdentifier
197	Characteristic Type	C1_PRICEITEM_BO/0/divPriceitem/0/ divPriceItemChar/characteristicType
198	Effective Date	C1_PRICEITEM_BO/0/divPriceitem/0/ divPriceItemChar/effectiveDate
199	Characteristic Value	C1_PRICEITEM_BO/0/divPriceitem/0/ divPriceItemChar/characteristicValue
200	Characteristic Type	C1_PRICEITEM_BO/0/divPriceitem/1/ divPriceItemChar/characteristicType
201	Effective Date	C1_PRICEITEM_BO/0/divPriceitem/1/ divPriceItemChar/effectiveDate
202	Characteristic Value	C1_PRICEITEM_BO/0/divPriceitem/1/ divPriceItemChar/characteristicValue
203	Division	C1_PRICEITEM_BO/1/divPriceitem/division
204	SQI	C1_PRICEITEM_BO/1/divPriceitem/0/priceItemSqi/ serviceQuantityIdentifier
205	Characteristic Type	C1_PRICEITEM_BO/1/divPriceitem/0/ divPriceItemChar/characteristicType
206	Effective Date	C1_PRICEITEM_BO/1/divPriceitem/0/ divPriceItemChar/effectiveDate

Sequence	Field Name	Map Field XPath
207	Characteristic Value	C1_PRICEITEM_BO/1/divPriceitem/0/divPriceItemChar/characteristicValue
208	Characteristic Type	C1_PRICEITEM_BO/0/priceItemChar/characteristicType
209	Effective Date	C1_PRICEITEM_BO/0/priceItemChar/effectiveDate
210	Characteristic Value	C1_PRICEITEM_BO/0/priceItemChar/characteristicValue
211	Price Item	C1_PRICEITEM_BO/0/priceItemRel/priceItemChildCd
212	Effective Start Date	C1_PRICEITEM_BO/0/priceItemRel/startDate
213	Effective End Date	C1_PRICEITEM_BO/0/priceItemRel/endDate
214	Relationship Type	C1_PRICEITEM_BO/0/priceItemRel/priceItemReTypeFlg
215	REL0PARAMCD0PARAMVAL0	-
216	REL0PARAMCD1PARAMVAL1	-
217	Effective Date	C1_PRICEITEM_BO/0/priceItemRel/0/priceItemRelCharacteristic/effectiveDate
218	Characteristic Type	C1_PRICEITEM_BO/0/priceItemRel/0/priceItemRelCharacteristic/characteristicType
219	Characteristic Value	C1_PRICEITEM_BO/0/priceItemRel/0/priceItemRelCharacteristic/characteristicValue
220	Price Item	C1_PRICEITEM_BO/1/priceItemRel/priceItemChildCd
221	Effective Start Date	C1_PRICEITEM_BO/1/priceItemRel/startDate
222	Effective End Date	C1_PRICEITEM_BO/1/priceItemRel/endDate
223	Relationship Type	C1_PRICEITEM_BO/1/priceItemRel/priceItemReTypeFlg
224	REL1PARAMCD0PARAMVAL0	-
225	REL1PARAMCD1PARAMVAL1	-
226	Effective Date	C1_PRICEITEM_BO/1/priceItemRel/0/priceItemRelCharacteristic/effectiveDate
227	Characteristic Type	C1_PRICEITEM_BO/1/priceItemRel/0/priceItemRelCharacteristic/characteristicType

Sequence	Field Name	Map Field XPath
228	Characteristic Value	C1_PRICEITEM_BO/1/priceItemRel/0/priceItemRelCharacteristic/characteristicValue

Sample CSV

```
OVRDTRD,Overdraft Returned,PRBL,,ACTV,N,,N,SAVINGS,2019-01-01,,COUNTRY,,1,PRI,Y,,
USA,SWE,CHE,IND,LKA,MEX,CHN,JPN,2019-01-01,,CURRENCY,,2,AGG,N,1,USD,GBP,EUR,INR,
LKR,PESO,YUAN,YEN,DIV001,ACCTBAL,AVGDBAL,OVERDRTPLAN,2019-01-01,LINECRD,,,,,DIV002,
ACCTBAL,OVERDRTPLAN,2019-01-01,LKDPTACT,ACCTTYPE,2019-01-01,SAVINGS,,,,,,,,,
,,,,,,,,,ADDNGFEE,Additional Negative Balance Fees,PRBL,,ACTV,N,,N,SAVINGS,2019-01-01,,
COUNTRY,,1,PRI,Y,,USA,SWE,CHE,IND,LKA,MEX,CHN,JPN,2019-01-01,,CURRENCY,,2,AGG,N,1,USD,
GBP,EUR,INR,LKR,PESO,YUAN,YEN,DIV001,OVDLMT,,OVERDRTPLAN,2019-01-01,LINECRD,ACCTTYPE,
2019-01-01,SAVINGS,,,,,,,,,OVRDFT,Overdraft,PRBL,,ACTV,N,,N,SAVINGS,2019-01-01,,
COUNTRY,,1,PRI,Y,,USA,SWE,CHE,IND,LKA,MEX,CHN,JPN,2019-01-01,,CURRENCY,,2,AGG,N,1,USD,
GBP,EUR,INR,LKR,PESO,YUAN,YEN,DIV001,ACCTBAL,AVGDBAL,OVERDRTPLAN,2019-01-01,LINECRD,,,,,
DIV002,ACCTBAL,OVERDRTPLAN,2019-01-01,LKDPTACT,ACCTTYPE,2019-01-01,SAVINGS,OVRDTRD,
2019-01-01,,Service,COUNTRY,INDIA,CURRENCY,INR,2019-01-01,APPRD,Y,ADDNGFEE,2019-01-01,,
Service,COUNTRY,INDIA,CURRENCY,INR,2019-01-01,APPRD,Y
```

Related Topics

For more information on...	See...
CSV File Format for Uploading Price Items	CSV File Format for Uploading Price Items on page 2379

Uploading a Parameter File in the XML Format

To upload a parameter file in the XML format using the **File Upload Interface** utility, you need to do the following:

1. Define a file request type for uploading parameters in the XML format
2. Upload the parameter file
3. Create the parameters in the system

Related Topics

For more information on...	See...
How to define a file request type for uploading parameters in the XML format	Defining a File Request Type for Uploading Parameters in the XML Format on page 2397
How to upload a parameter file	Uploading a Parameter File on page 2398
How to create the parameters in the system	Creating Parameters on page 2398

Defining a File Request Type for Uploading Parameters in the XML Format

Procedure

To define a file request type for uploading parameters in the XML format:

1. Click the **Admin** link in the **Application** toolbar.
A list appears.
2. From the **Admin** menu, select **F** and then click **File Request Type**.
A sub-menu appears.
3. Click the **Add** option from the **File Request Type** sub-menu.
The **File Request Type** screen appears.

4. Enter the file request type and description in the respective fields.
5. Ensure that the **Extensible Markup Language** option is selected from the **File Format** list.
6. Attach an algorithm created using the **C1-FRHVA** algorithm type to the **File Validation Algorithm** field.
7. In the **Services** section, enter the required sequence number.
8. Select the **Business Object** option from the **Service Type** list.
9. Enter the **C1_PRICE_PARM** business object or custom parameter business object in the **Service Name** field.
10. Attach an algorithm created using the **C1-PRICEUPL** algorithm type to the **Pre-Processing Algorithm** field corresponding to the parameter business object.

Note: For more information about the **C1-PRICEUPL** algorithm, refer to [C1-PRICEUPL](#) on page 2364.

11. Select the **Add** option from the **Operation** list.

Note: At present, you cannot edit the existing parameters using the **Price Item, Parameter, and SQI Upload** feature. You can only edit the existing parameters from the user interface.

12. Click **Save**.

The file request type is defined for uploading parameters in the XML format.

Uploading a Parameter File

You can upload a parameter file using the **File Transformation and Upload (C1-FTRAN)** batch. While executing this batch, you must specify a file request type which is defined for uploading the parameter files in the XML format. For more information about the batch, refer to *Oracle Revenue Management and Billing Batch Guide*.

Creating Parameters

You can create the parameters in the system using the **File Request Processing (C1-FREQP)** batch. While executing this batch, you must specify a file request type which is defined for uploading the parameter files in the XML format. For more information about the batch, refer to *Oracle Revenue Management and Billing Batch Guide*.

Uploading a Parameter File in the CSV Format

To upload a parameter file in the CSV format using the **File Upload Interface** utility, you need to do the following:

1. Define a file request type for uploading parameters in the CSV format
2. Upload the parameter file
3. Create the parameters in the system

Related Topics

For more information on...	See...
How to define a file request type for uploading parameters in the CSV format	Defining a File Request Type for Uploading Parameters in the CSV Format on page 2398
How to upload a parameter file	Uploading a Parameter File on page 2400
How to create the parameters in the system	Creating Parameters on page 2400

Defining a File Request Type for Uploading Parameters in the CSV Format

Procedure

To define a file request type for uploading parameters in the CSV format:

1. Click the **Admin** link in the **Application** toolbar.
A list appears.
2. From the **Admin** menu, select **F** and then click **File Request Type**.
A sub-menu appears.
3. Click the **Add** option from the **File Request Type** sub-menu.
The **File Request Type** screen appears.
4. Enter the file request type and description in the respective fields.
5. Select the **Data Transformation Required** option.
The **File Format** field is enabled.
6. Select the **Comma Separated Values** option from the **File Format** list.
7. Enter `csv` in the **File Extension** field.
8. Attach an algorithm created using the **C1-FRHVA** algorithm type to the **File Validation Algorithm** field.
9. Attach an algorithm created using the **C1-FRTA** algorithm type to the **Data Transformation Algorithm** field.
10. In the **Services** section, enter the required sequence number.
11. Select the **Business Object** option from the **Service Type** list.
12. Enter the **C1_PRICE_PARM** business object or custom parameter business object in the **Service Name** field.
13. Attach an algorithm created using the **C1-PRICEUPL** algorithm type to the **Pre-Processing Algorithm** field corresponding to the parameter business object.

Note: For more information about the **C1-PRICEUPL** algorithm, refer to [C1-PRICEUPL](#) on page 2364.

14. Select the **Add** option from the **Operation** list.

Note: At present, you cannot edit the existing parameters using the **Price Item, Parameter, and SQI Upload** feature. You can only edit the existing parameters from the user interface.

15. If you have included a header in the CSV file, add the appropriate details in the **Header Transformation** section.
16. Similarly, if you have included a footer in the CSV file, add the appropriate details in the **Footer Transformation** section.
17. In the **Field Transformation** section, specify the following details:

Field Name	Field Description	Mandatory (Yes or No)
Sequence	Used to indicate the data field in the CSV record which you want to upload in the system.	Yes
Field Name	Used to indicate the field for which the data is uploaded in the system.	Yes
Map Field XPath	Used to specify the XPath of the field where you want to store the data field from the CSV record.	Yes

For example,

Sequence	Field Name	Map Field XPath
1	PRICEPARMCODE	C1_PRICE_PARM/priceParmCode
2	DESCRIPTION	C1_PRICE_PARM/description

18. Click **Save**.

The file request type is defined for uploading parameters in the CSV format.

Uploading a Parameter File

You can upload a parameter file using the **File Transformation and Upload (C1-FTRAN)** batch. While executing this batch, you must specify a file request type which is defined for uploading the parameter files in the CSV format. For more information about the batch, refer to *Oracle Revenue Management and Billing Batch Guide*.

Creating Parameters

You can create the parameters in the system using the **File Request Processing (C1-FREQP)** batch. While executing this batch, you must specify a file request type which is defined for uploading the parameter files in the CSV format. For more information about the batch, refer to *Oracle Revenue Management and Billing Batch Guide*.

XML File Format for Uploading Parameters

Before uploading a parameter file through the **File Upload Interface** utility, you need to ensure that the XML file contains the following tags:

Tag Name	Tag Description	Mandatory (Yes or No)
C1_PRICE_PARM	Used to specify the details of the parameter whose record you want to create or update in the system.	Yes
pricingEligibilitySw	Used to indicate whether the parameter can be used while defining the pricing eligibility criteria. The valid values are: <ul style="list-style-type: none"> • Y • N <p>Note: You must ensure that this tag contains N when the sourceEntityFlg tag contains TRN.</p>	No
priceItemSw	Used to indicate whether the parameter can be associated with a price item or price item bundle. The valid values are: <ul style="list-style-type: none"> • Y • N 	No

Tag Name	Tag Description	Mandatory (Yes or No)														
	<p>Note: You must ensure that this tag contains N when a parameter is defined using the following source entity and source type combinations:</p> <table border="1" data-bbox="570 380 1154 730"> <thead> <tr> <th data-bbox="570 380 862 428">Source Entity</th> <th data-bbox="862 380 1154 428">Source Type</th> </tr> </thead> <tbody> <tr> <td data-bbox="570 428 862 476">ACCT</td> <td data-bbox="862 428 1154 476">BAL</td> </tr> <tr> <td data-bbox="570 476 862 525">ACCT</td> <td data-bbox="862 476 1154 525">CNT</td> </tr> <tr> <td data-bbox="570 525 862 573">PERS</td> <td data-bbox="862 525 1154 573">BAL</td> </tr> <tr> <td data-bbox="570 573 862 621">PERS</td> <td data-bbox="862 573 1154 621">CNT</td> </tr> <tr> <td data-bbox="570 621 862 669">ALGO</td> <td data-bbox="862 621 1154 669">—</td> </tr> <tr> <td data-bbox="570 669 862 718">SQI</td> <td data-bbox="862 669 1154 718">—</td> </tr> </tbody> </table>	Source Entity	Source Type	ACCT	BAL	ACCT	CNT	PERS	BAL	PERS	CNT	ALGO	—	SQI	—	
Source Entity	Source Type															
ACCT	BAL															
ACCT	CNT															
PERS	BAL															
PERS	CNT															
ALGO	—															
SQI	—															
priceListEligibilitySw	<p>Used to indicate whether the parameter can be used while defining the price list eligibility criteria. The valid values are:</p> <ul style="list-style-type: none"> • Y • N <p>Note: You must ensure that this tag contains N when the sourceEntityFlg tag contains TRN.</p>	No														
productEligibilitySw	<p>Used to indicate whether the parameter can be used while defining the product eligibility criteria. The valid values are:</p> <ul style="list-style-type: none"> • Y • N <p>Note: You must ensure that this tag contains N when the sourceEntityFlg tag contains ALGO, SQI, or TRN.</p>	No														
priceParmCode	<p>Used to specify the parameter name.</p> <p>Note: You cannot specify any special character except underscore (_) in the parameter name.</p>	Yes														
description	Used to specify the description for the parameter.	Yes														
priceParmTypeFlag	<p>Used to indicate the type of value that you want to store in the parameter. The valid values are:</p> <ul style="list-style-type: none"> • ADV - Enables you to store an adhoc value in the parameter. • DFV - Enables you to store a predefined value in the parameter. 	Yes														

Tag Name	Tag Description	Mandatory (Yes or No)
	<ul style="list-style-type: none"> • FKV - Enables you to store a reference value in the parameter. 	
sourceEntityFlg	<p>Used to indicate the entity from where the parameter value should be derived. The valid values are:</p> <ul style="list-style-type: none"> • ACCT - Enables you to derive the parameter value from the account. • ALGO - Enables you to derive the parameter value from an algorithm. • PERS - Enables you to derive the parameter value from the person. • PRD - Enables you to derive the parameter value from the product. • SQI - Enables you to derive the parameter value from a service quantity identifier. • TRN - Enables you to derive the parameter value from a transaction. 	Yes
sourceTypeCode	Used to indicate the source, such as field, characteristic, usage amount, usage counter, SQI, or algorithm, from where the parameter value should be derived.	Yes

Tag Name	Tag Description	Mandatory (Yes or No)																																				
	<p>Note:</p> <p>You must ensure that this tag contains no value when the sourceEntityFlg tag contains TRN.</p> <p>You must ensure that this tag contains the following information depending on the source entity and source type combination:</p> <table border="1" data-bbox="570 457 1154 1856"> <thead> <tr> <th data-bbox="570 457 719 537">Source Entity</th> <th data-bbox="719 457 885 537">Source Type</th> <th data-bbox="885 457 1154 537">Source Type Code</th> </tr> </thead> <tbody> <tr> <td data-bbox="570 537 719 684">ACCT</td> <td data-bbox="719 537 885 684">CHAR</td> <td data-bbox="885 537 1154 684">A characteristic type where the characteristic entity is set to Account.</td> </tr> <tr> <td data-bbox="570 684 719 764">ACCT</td> <td data-bbox="719 684 885 764">FLD</td> <td data-bbox="885 684 1154 764">A field from the CI_ACCT table.</td> </tr> <tr> <td data-bbox="570 764 719 884">ACCT</td> <td data-bbox="719 764 885 884">BAL</td> <td data-bbox="885 764 1154 884">A value from the BAL_FLG lookup field.</td> </tr> <tr> <td data-bbox="570 884 719 1003">ACCT</td> <td data-bbox="719 884 885 1003">CNT</td> <td data-bbox="885 884 1154 1003">A value from the CNT_FLG lookup field.</td> </tr> <tr> <td data-bbox="570 1003 719 1150">PERS</td> <td data-bbox="719 1003 885 1150">CHAR</td> <td data-bbox="885 1003 1154 1150">A characteristic type where the characteristic entity is set to Person.</td> </tr> <tr> <td data-bbox="570 1150 719 1230">PERS</td> <td data-bbox="719 1150 885 1230">FLD</td> <td data-bbox="885 1150 1154 1230">A field from the CI_PER table.</td> </tr> <tr> <td data-bbox="570 1230 719 1350">PERS</td> <td data-bbox="719 1230 885 1350">BAL</td> <td data-bbox="885 1230 1154 1350">A value from the BAL_FLG lookup field.</td> </tr> <tr> <td data-bbox="570 1350 719 1449">PERS</td> <td data-bbox="719 1350 885 1449">CNT</td> <td data-bbox="885 1350 1154 1449">A value from the CNT_FLG lookup field.</td> </tr> <tr> <td data-bbox="570 1449 719 1596">PRD</td> <td data-bbox="719 1449 885 1596">CHAR</td> <td data-bbox="885 1449 1154 1596">A characteristic type where the characteristic entity is set to Product.</td> </tr> <tr> <td data-bbox="570 1596 719 1715">PRD</td> <td data-bbox="719 1596 885 1715">FLD</td> <td data-bbox="885 1596 1154 1715">A field from the CI_PRODUCT table.</td> </tr> <tr> <td data-bbox="570 1715 719 1856">SQI</td> <td data-bbox="719 1715 885 1856">—</td> <td data-bbox="885 1715 1154 1856">A service quantity identifier which is already defined in the system.</td> </tr> </tbody> </table>	Source Entity	Source Type	Source Type Code	ACCT	CHAR	A characteristic type where the characteristic entity is set to Account .	ACCT	FLD	A field from the CI_ACCT table.	ACCT	BAL	A value from the BAL_FLG lookup field.	ACCT	CNT	A value from the CNT_FLG lookup field.	PERS	CHAR	A characteristic type where the characteristic entity is set to Person .	PERS	FLD	A field from the CI_PER table.	PERS	BAL	A value from the BAL_FLG lookup field.	PERS	CNT	A value from the CNT_FLG lookup field.	PRD	CHAR	A characteristic type where the characteristic entity is set to Product .	PRD	FLD	A field from the CI_PRODUCT table.	SQI	—	A service quantity identifier which is already defined in the system.	
Source Entity	Source Type	Source Type Code																																				
ACCT	CHAR	A characteristic type where the characteristic entity is set to Account .																																				
ACCT	FLD	A field from the CI_ACCT table.																																				
ACCT	BAL	A value from the BAL_FLG lookup field.																																				
ACCT	CNT	A value from the CNT_FLG lookup field.																																				
PERS	CHAR	A characteristic type where the characteristic entity is set to Person .																																				
PERS	FLD	A field from the CI_PER table.																																				
PERS	BAL	A value from the BAL_FLG lookup field.																																				
PERS	CNT	A value from the CNT_FLG lookup field.																																				
PRD	CHAR	A characteristic type where the characteristic entity is set to Product .																																				
PRD	FLD	A field from the CI_PRODUCT table.																																				
SQI	—	A service quantity identifier which is already defined in the system.																																				

Tag Name	Tag Description	Mandatory (Yes or No)
sourceTypeFlg	<p>Used to indicate the type of source from where the parameter value should be derived. The valid values are:</p> <ul style="list-style-type: none"> • CHAR - Enables you to derive the parameter value from a characteristic. • FLD - Enables you to derive the parameter value from a field. • BAL - Enables you to derive the parameter value from a usage amount. • CNT - Enables you to derive the parameter value from a usage counter. 	Yes
	<p>Note:</p> <p>You must ensure that this tag contains no value when the sourceEntityFlg tag contains ALGO, SQI, or TRN.</p> <p>You must ensure that this tag does not contain BAL or CNT when the sourceEntityFlg tag contains PRD.</p>	
validationAlgoCd	<p>Used to indicate the algorithm using which you want to validate the adhoc parameter value.</p>	No
	<p>Note: You must ensure that this tag contains value when the priceParmTypeFlag tag contains ADV.</p>	
referredTable	Used to indicate the table whose primary key (column) you want to set as the reference entity.	Yes (Conditional)
		<p>Note: This data is required when the priceParmTypeFlag tag contains FKV.</p>
referredField	Used to indicate the column which is the primary key of the table. The parameter value is then validated against the primary column of the table.	Yes (Conditional)
		<p>Note: This data is required when the priceParmTypeFlag tag contains FKV.</p>
priceParmValue	Used to specify a list of predefined values for the parameter.	Yes (Conditional)
		<p>Note: This data is required when the priceParmTypeFlag tag contains DFV.</p>
priceParmVal	Used to specify the parameter value.	Yes (Conditional)

Tag Name	Tag Description	Mandatory (Yes or No)
	Note: You can specify any special characters except ampersand (&), comma (,), underscore (_), equal to (=), tilde (~), and semi-colon(:) in the predefined parameter value.	Note: This data is required when the priceParmTypeFlag tag contains DFV .
descr	Used to specify the description for the parameter value.	Yes (Conditional) Note: This data is required when the priceParmTypeFlag tag contains DFV .

Related Topics

For more information on...	See...
How to define a parameter	Defining a Parameter on page 296
Sample XML Format for Uploading Parameters	Sample XML Format for Uploading Parameters on page 2405

Sample XML Format for Uploading Parameters

Using the below example, you can create the following parameters:

- Country
- Currency

Note: The system will create the above parameters when the required fields, characteristic types, usage amount, usage counter, validation algorithm, referenced tables, and referenced fields are defined in the application.

```
<root>
<request>
<payload>
<C1_PRICE_PARM>
  <priceParmCode>COUNTRY</priceParmCode>
  <description>COUNTRY</description>
  <priceParmTypeFlag>DFV</priceParmTypeFlag>
  <sourceEntityFlg>PERS</sourceEntityFlg>
  <sourceTypeFlg>FLD</sourceTypeFlg>
  <sourceTypeCode>COUNTRY</sourceTypeCode>
  <validationAlgoCd></validationAlgoCd>
  <referredTable></referredTable>
  <referredField></referredField>
  <priceParmValue>
    <priceParmVal>AUT</priceParmVal>
    <descr>Austria</descr>
  </priceParmValue>
  <priceParmValue>
    <priceParmVal>AUS</priceParmVal>
    <descr>Australia</descr>
  </priceParmValue>
  <priceParmValue>
    <priceParmVal>CAN</priceParmVal>
    <descr>Canada</descr>
  </priceParmValue>
  <priceParmValue>
    <priceParmVal></priceParmVal>
    <descr></descr>
  </priceParmValue>
</C1_PRICE_PARM>
</payload>
</request>
</root>
```

```

    <priceParmVal>CHN</priceParmVal>
    <descr>China</descr>
  </priceParmValue>
  <priceParmValue>
    <priceParmVal>DNK</priceParmVal>
    <descr>Denmark</descr>
  </priceParmValue>
  <priceParmValue>
    <priceParmVal>EGY</priceParmVal>
    <descr>Egypt</descr>
  </priceParmValue>
  <priceParmValue>
    <priceParmVal>FRA</priceParmVal>
    <descr>France</descr>
  </priceParmValue>
  <priceParmValue>
    <priceParmVal>DEU</priceParmVal>
    <descr>Germany</descr>
  </priceParmValue>
  <priceParmValue>
    <priceParmVal>IND</priceParmVal>
    <descr>India</descr>
  </priceParmValue>
  <priceParmValue>
    <priceParmVal>ITA</priceParmVal>
    <descr>Italy</descr>
  </priceParmValue>
  <priceParmValue>
    <priceParmVal>JPN</priceParmVal>
    <descr>Japan</descr>
  </priceParmValue>
  <priceParmValue>
    <priceParmVal>MYS</priceParmVal>
    <descr>Malaysia</descr>
  </priceParmValue>
  <priceParmValue>
    <priceParmVal>MEX</priceParmVal>
    <descr>Mexico</descr>
  </priceParmValue>
  <priceParmValue>
    <priceParmVal>NOR</priceParmVal>
    <descr>Norway</descr>
  </priceParmValue>
  <priceParmValue>
    <priceParmVal>PHL</priceParmVal>
    <descr>Philippines</descr>
  </priceParmValue>
  <priceParmValue>
    <priceParmVal>RUS</priceParmVal>
    <descr>Russia</descr>
  </priceParmValue>
  <priceParmValue>
    <priceParmVal>ESP</priceParmVal>
    <descr>Spain</descr>
  </priceParmValue>
  <priceParmValue>
    <priceParmVal>LKA</priceParmVal>
    <descr>Sri Lanka</descr>
  </priceParmValue>
  <priceParmValue>
    <priceParmVal>SWE</priceParmVal>
    <descr>Sweden</descr>
  </priceParmValue>
  <priceParmValue>

```

```

    <priceParmVal>CHE</priceParmVal>
    <descr>Switzerland</descr>
  </priceParmValue>
  <priceParmValue>
    <priceParmVal>THA</priceParmVal>
    <descr>Thailand</descr>
  </priceParmValue>
  <priceParmValue>
    <priceParmVal>USA</priceParmVal>
    <descr>United States of America</descr>
  </priceParmValue>
  <pricingEligibilitySw>Y</pricingEligibilitySw>
  <priceItemSw>Y</priceItemSw>
  <priceListEligibilitySw>N</priceListEligibilitySw>
  <productEligibilitySw>N</productEligibilitySw>
</C1_PRICE_PARM>
<C1_PRICE_PARM>
  <priceParmCode>CURRENCY</priceParmCode>
  <description>CURRENCY</description>
  <priceParmTypeFlag>DFV</priceParmTypeFlag>
  <sourceEntityFlg>ACCT</sourceEntityFlg>
  <sourceTypeFlg>FLD</sourceTypeFlg>
  <sourceTypeCode>CURRENCY_CD</sourceTypeCode>
  <validationAlgoCd></validationAlgoCd>
  <referredTable></referredTable>
  <referredField></referredField>
  <priceParmValue>
    <priceParmVal>EUR</priceParmVal>
    <descr>Euro</descr>
  </priceParmValue>
  <priceParmValue>
    <priceParmVal>AUD</priceParmVal>
    <descr>Australian Dollar</descr>
  </priceParmValue>
  <priceParmValue>
    <priceParmVal>CAD</priceParmVal>
    <descr>Canadian Dollar</descr>
  </priceParmValue>
  <priceParmValue>
    <priceParmVal>CNY</priceParmVal>
    <descr>Chinese Yuan</descr>
  </priceParmValue>
  <priceParmValue>
    <priceParmVal>DKK</priceParmVal>
    <descr>Danish Krone</descr>
  </priceParmValue>
  <priceParmValue>
    <priceParmVal>EGP</priceParmVal>
    <descr>Egyptian Pound</descr>
  </priceParmValue>
  <priceParmValue>
    <priceParmVal>INR</priceParmVal>
    <descr>Indian Rupee</descr>
  </priceParmValue>
  <priceParmValue>
    <priceParmVal>JPY</priceParmVal>
    <descr>Japanese Yen</descr>
  </priceParmValue>
  <priceParmValue>
    <priceParmVal>MYR</priceParmVal>
    <descr>Malaysian Ringgit</descr>
  </priceParmValue>
  <priceParmValue>
    <priceParmVal>MXN</priceParmVal>

```

```

    <descr>Mexican Peso</descr>
  </priceParmValue>
  <priceParmValue>
    <priceParmVal>NOK</priceParmVal>
    <descr>Norwegian Krone</descr>
  </priceParmValue>
  <priceParmValue>
    <priceParmVal>PHP</priceParmVal>
    <descr>Philippine Peso</descr>
  </priceParmValue>
  <priceParmValue>
    <priceParmVal>RUB</priceParmVal>
    <descr>Russian Ruble</descr>
  </priceParmValue>
  <priceParmValue>
    <priceParmVal>LKR</priceParmVal>
    <descr>Sri Lankan Rupee</descr>
  </priceParmValue>
  <priceParmValue>
    <priceParmVal>SEK</priceParmVal>
    <descr>Swedish Krona</descr>
  </priceParmValue>
  <priceParmValue>
    <priceParmVal>CHF</priceParmVal>
    <descr>Swiss Franc</descr>
  </priceParmValue>
  <priceParmValue>
    <priceParmVal>THB</priceParmVal>
    <descr>Thai Baht</descr>
  </priceParmValue>
  <priceParmValue>
    <priceParmVal>USD</priceParmVal>
    <descr>United States Dollar</descr>
  </priceParmValue>
  <pricingEligibilitySw>Y</pricingEligibilitySw>
  <priceItemSw>Y</priceItemSw>
  <priceListEligibilitySw>N</priceListEligibilitySw>
  <productEligibilitySw>N</productEligibilitySw>
</C1_PRICE_PARM>
</payload>
</request>
</root>

```

Related Topics

For more information on...	See...
XML File Format for Uploading Parameters	XML File Format for Uploading Parameters on page 2400

CSV File Format for Uploading Parameters

Before uploading a parameter file through the **File Upload Interface** utility, you need to ensure that the CSV file contains the following data:

Data	Description	Mandatory (Yes or No)
Parameter	Used to specify the parameter name.	Yes

Data	Description	Mandatory (Yes or No)
	<p>Note: You cannot specify any special character except underscore (_) in the parameter name.</p>	
Description	Used to specify the description for the parameter.	Yes
Value Type	<p>Used to indicate the type of value that you want to store in the parameter. The valid values are:</p> <ul style="list-style-type: none"> • ADV - Enables you to store an adhoc value in the parameter. • DFV - Enables you to store a predefined value in the parameter. • FKV - Enables you to store a reference value in the parameter. 	Yes
Source Entity	<p>Used to indicate the entity from where the parameter value should be derived. The valid values are:</p> <ul style="list-style-type: none"> • ACCT - Enables you to derive the parameter value from the account. • ALGO - Enables you to derive the parameter value from an algorithm. • PERS - Enables you to derive the parameter value from the person. • PRD - Enables you to derive the parameter value from the product. • SQI - Enables you to derive the parameter value from a service quantity identifier. • TRN - Enables you to derive the parameter value from a transaction. 	Yes
Source Type	<p>Used to indicate the type of source from where the parameter value should be derived. The valid values are:</p> <ul style="list-style-type: none"> • CHAR - Enables you to derive the parameter value from a characteristic. • FLD - Enables you to derive the parameter value from a field. • BAL - Enables you to derive the parameter value from a usage amount. • CNT - Enables you to derive the parameter value from a usage counter. <p>Note: You must not specify the source type when the source entity is set to ALGO, SQI, or TRN. You must not specify the source type as BAL or CNT when the source entity is set to PRD.</p>	Yes

Data	Description	Mandatory (Yes or No)																																				
Source Type Code	<p>Used to indicate the source, such as field, characteristic, usage amount, usage counter, SQI, or algorithm, from where the parameter value should be derived.</p> <p>Note:</p> <p>You must not specify the source type code when the source entity is set to TRN.</p> <p>You must specify the source type code depending on the following source entity and source type combination:</p> <table border="1" data-bbox="440 590 1149 1734"> <thead> <tr> <th data-bbox="440 590 618 674">Source Entity</th> <th data-bbox="618 590 821 674">Source Type</th> <th data-bbox="821 590 1149 674">Source Type Code</th> </tr> </thead> <tbody> <tr> <td data-bbox="440 674 618 789">ACCT</td> <td data-bbox="618 674 821 789">CHAR</td> <td data-bbox="821 674 1149 789">A characteristic type where the characteristic entity is set to Account.</td> </tr> <tr> <td data-bbox="440 789 618 873">ACCT</td> <td data-bbox="618 789 821 873">FLD</td> <td data-bbox="821 789 1149 873">A field from the CI_ACCT table.</td> </tr> <tr> <td data-bbox="440 873 618 957">ACCT</td> <td data-bbox="618 873 821 957">BAL</td> <td data-bbox="821 873 1149 957">A value from the BAL_FLG lookup field.</td> </tr> <tr> <td data-bbox="440 957 618 1041">ACCT</td> <td data-bbox="618 957 821 1041">CNT</td> <td data-bbox="821 957 1149 1041">A value from the CNT_FLG lookup field.</td> </tr> <tr> <td data-bbox="440 1041 618 1146">PERS</td> <td data-bbox="618 1041 821 1146">CHAR</td> <td data-bbox="821 1041 1149 1146">A characteristic type where the characteristic entity is set to Person.</td> </tr> <tr> <td data-bbox="440 1146 618 1230">PERS</td> <td data-bbox="618 1146 821 1230">FLD</td> <td data-bbox="821 1146 1149 1230">A field from the CI_PER table.</td> </tr> <tr> <td data-bbox="440 1230 618 1314">PERS</td> <td data-bbox="618 1230 821 1314">BAL</td> <td data-bbox="821 1230 1149 1314">A value from the BAL_FLG lookup field.</td> </tr> <tr> <td data-bbox="440 1314 618 1398">PERS</td> <td data-bbox="618 1314 821 1398">CNT</td> <td data-bbox="821 1314 1149 1398">A value from the CNT_FLG lookup field.</td> </tr> <tr> <td data-bbox="440 1398 618 1503">PRD</td> <td data-bbox="618 1398 821 1503">CHAR</td> <td data-bbox="821 1398 1149 1503">A characteristic type where the characteristic entity is set to Product.</td> </tr> <tr> <td data-bbox="440 1503 618 1587">PRD</td> <td data-bbox="618 1503 821 1587">FLD</td> <td data-bbox="821 1503 1149 1587">A field from the CI_PRODUCT table.</td> </tr> <tr> <td data-bbox="440 1587 618 1734">SQI</td> <td data-bbox="618 1587 821 1734">—</td> <td data-bbox="821 1587 1149 1734">A service quantity identifier which is already defined in the system.</td> </tr> </tbody> </table>	Source Entity	Source Type	Source Type Code	ACCT	CHAR	A characteristic type where the characteristic entity is set to Account .	ACCT	FLD	A field from the CI_ACCT table.	ACCT	BAL	A value from the BAL_FLG lookup field.	ACCT	CNT	A value from the CNT_FLG lookup field.	PERS	CHAR	A characteristic type where the characteristic entity is set to Person .	PERS	FLD	A field from the CI_PER table.	PERS	BAL	A value from the BAL_FLG lookup field.	PERS	CNT	A value from the CNT_FLG lookup field.	PRD	CHAR	A characteristic type where the characteristic entity is set to Product .	PRD	FLD	A field from the CI_PRODUCT table.	SQI	—	A service quantity identifier which is already defined in the system.	Yes
Source Entity	Source Type	Source Type Code																																				
ACCT	CHAR	A characteristic type where the characteristic entity is set to Account .																																				
ACCT	FLD	A field from the CI_ACCT table.																																				
ACCT	BAL	A value from the BAL_FLG lookup field.																																				
ACCT	CNT	A value from the CNT_FLG lookup field.																																				
PERS	CHAR	A characteristic type where the characteristic entity is set to Person .																																				
PERS	FLD	A field from the CI_PER table.																																				
PERS	BAL	A value from the BAL_FLG lookup field.																																				
PERS	CNT	A value from the CNT_FLG lookup field.																																				
PRD	CHAR	A characteristic type where the characteristic entity is set to Product .																																				
PRD	FLD	A field from the CI_PRODUCT table.																																				
SQI	—	A service quantity identifier which is already defined in the system.																																				
Validation Algorithm	Used to indicate the algorithm using which you want to validate the adhoc parameter value.	No																																				

Data	Description	Mandatory (Yes or No)
	<p>Note: You must specify a validation algorithm when the value type is set to Adhoc.</p>	
Reference Entity	Used to indicate the table whose primary key (column) you want to set as the reference entity.	Yes (Conditional) <p>Note: This data is required when the value type is set to Reference.</p>
Field Name	Used to indicate the column which is the primary key of the table. The parameter value is then validated against the primary column of the table.	Yes (Conditional) <p>Note: This data is required when the value type is set to Reference.</p>
Predefined Parameter Values		
Parameter Value	Used to specify the parameter value. <p>Note: You can specify any special characters except ampersand (&), comma (,), underscore (_), equal to (=), tilde (~), and semi-colon(;) in the predefined parameter value.</p>	Yes (Conditional) <p>Note: This data is required when the value type is set to Predefined.</p>
Description	Used to specify the description for the parameter value.	Yes (Conditional) <p>Note: This data is required when the value type is set to Predefined.</p>
Parameter Usage Information		
Price Item	Used to indicate whether the parameter can be associated with a price item or price item bundle. The valid values are: <ul style="list-style-type: none"> • Y • N 	No

Data	Description	Mandatory (Yes or No)														
	<p>Note: You must specify the value as N when a parameter is defined using the following source entity and source type combinations:</p> <table border="1" data-bbox="435 388 1154 768"> <thead> <tr> <th>Source Entity</th> <th>Source Type</th> </tr> </thead> <tbody> <tr> <td>ACCT</td> <td>BAL</td> </tr> <tr> <td>ACCT</td> <td>CNT</td> </tr> <tr> <td>PERS</td> <td>BAL</td> </tr> <tr> <td>PERS</td> <td>CNT</td> </tr> <tr> <td>ALGO</td> <td>—</td> </tr> <tr> <td>SQI</td> <td>—</td> </tr> </tbody> </table>	Source Entity	Source Type	ACCT	BAL	ACCT	CNT	PERS	BAL	PERS	CNT	ALGO	—	SQI	—	
Source Entity	Source Type															
ACCT	BAL															
ACCT	CNT															
PERS	BAL															
PERS	CNT															
ALGO	—															
SQI	—															
Pricing Eligibility Criteria	<p>Used to indicate whether the parameter can be used while defining the pricing eligibility criteria. The valid values are:</p> <ul style="list-style-type: none"> • Y • N 	No														
Price List Eligibility Criteria	<p>Used to indicate whether the parameter can be used while defining the price list eligibility criteria. The valid values are:</p> <ul style="list-style-type: none"> • Y • N <p>Note: You must specify the value as N when the source entity is set to TRN.</p>	No														
Product Eligibility Criteria	<p>Used to indicate whether the parameter can be used while defining the product eligibility criteria. The valid values are:</p> <ul style="list-style-type: none"> • Y • N <p>Note: You must specify the value as N when the source entity is set to ALGO, SQI, or TRN.</p>	No														

Related Topics

For more information on...	See...
How to define a parameter	Defining a Parameter on page 296
Sample CSV Format for Uploading Parameters	Sample CSV Format for Uploading Parameters on page 2412

Sample CSV Format for Uploading Parameters

Using the below example, you can create the following parameters:

- Country
- Currency

Note: The system will create the above parameters when the required fields, characteristic types, usage amount, usage counter, validation algorithm, referenced tables, and referenced fields are defined in the application.

Sequence	Field Name	Map Field XPath
1	Parameter	C1_PRICE_PARM_BO/priceParmCode
2	Description	C1_PRICE_PARM_BO/description
3	Value Type	C1_PRICE_PARM_BO/priceParmTypeFlag
4	Source Entity	C1_PRICE_PARM_BO/sourceEntityFlg
5	Source Type	C1_PRICE_PARM_BO/sourceTypeFlg
6	Source Type Code	C1_PRICE_PARM_BO/sourceTypeCode
7	Validation Algorithm	C1_PRICE_PARM_BO/validationAlgoCd
8	Reference Entity	C1_PRICE_PARM_BO/referredTable
9	Field Name	C1_PRICE_PARM_BO/referredField
10	Parameter Values	C1_PRICE_PARM_BO/0/priceParmValue/ priceParmVal
11	Description	C1_PRICE_PARM_BO/0/priceParmValue/descr
12	Parameter Values	C1_PRICE_PARM_BO/1/priceParmValue/ priceParmVal
13	Description	C1_PRICE_PARM_BO/1/priceParmValue/descr
14	Parameter Values	C1_PRICE_PARM_BO/2/priceParmValue/ priceParmVal
15	Description	C1_PRICE_PARM_BO/2/priceParmValue/descr
16	Parameter Values	C1_PRICE_PARM_BO/3/priceParmValue/ priceParmVal
17	Description	C1_PRICE_PARM_BO/3/priceParmValue/descr
18	Parameter Values	C1_PRICE_PARM_BO/4/priceParmValue/ priceParmVal
19	Description	C1_PRICE_PARM_BO/4/priceParmValue/descr
20	Parameter Values	C1_PRICE_PARM_BO/5/priceParmValue/ priceParmVal
21	Description	C1_PRICE_PARM_BO/5/priceParmValue/descr

Sequence	Field Name	Map Field XPath
22	Parameter Values	C1_PRICE_PARM_BO/6/priceParmValue/ priceParmVal
23	Description	C1_PRICE_PARM_BO/6/priceParmValue/descr
24	Parameter Values	C1_PRICE_PARM_BO/7/priceParmValue/ priceParmVal
25	Description	C1_PRICE_PARM_BO/7/priceParmValue/descr
26	Parameter Values	C1_PRICE_PARM_BO/8/priceParmValue/ priceParmVal
27	Description	C1_PRICE_PARM_BO/8/priceParmValue/descr
28	Parameter Values	C1_PRICE_PARM_BO/9/priceParmValue/ priceParmVal
29	Description	C1_PRICE_PARM_BO/9/priceParmValue/descr
30	Parameter Values	C1_PRICE_PARM_BO/10/priceParmValue/ priceParmVal
31	Description	C1_PRICE_PARM_BO/10/priceParmValue/descr
32	Parameter Values	C1_PRICE_PARM_BO/11/priceParmValue/ priceParmVal
33	Description	C1_PRICE_PARM_BO/11/priceParmValue/descr
34	Parameter Values	C1_PRICE_PARM_BO/12/priceParmValue/ priceParmVal
35	Description	C1_PRICE_PARM_BO/12/priceParmValue/descr
36	Parameter Values	C1_PRICE_PARM_BO/13/priceParmValue/ priceParmVal
37	Description	C1_PRICE_PARM_BO/13/priceParmValue/descr
38	Parameter Values	C1_PRICE_PARM_BO/14/priceParmValue/ priceParmVal
39	Description	C1_PRICE_PARM_BO/14/priceParmValue/descr
40	Parameter Values	C1_PRICE_PARM_BO/15/priceParmValue/ priceParmVal
41	Description	C1_PRICE_PARM_BO/15/priceParmValue/descr
42	Parameter Values	C1_PRICE_PARM_BO/16/priceParmValue/ priceParmVal
43	Description	C1_PRICE_PARM_BO/16/priceParmValue/descr

Sequence	Field Name	Map Field XPath
44	Parameter Values	C1_PRICE_PARM_BO/17/priceParmValue/ priceParmVal
45	Description	C1_PRICE_PARM_BO/17/priceParmValue/descr
46	Parameter Values	C1_PRICE_PARM_BO/18/priceParmValue/ priceParmVal
47	Description	C1_PRICE_PARM_BO/18/priceParmValue/descr
48	Parameter Values	C1_PRICE_PARM_BO/19/priceParmValue/ priceParmVal
49	Description	C1_PRICE_PARM_BO/19/priceParmValue/descr
50	Parameter Values	C1_PRICE_PARM_BO/20/priceParmValue/ priceParmVal
51	Description	C1_PRICE_PARM_BO/20/priceParmValue/descr
52	Parameter Values	C1_PRICE_PARM_BO/21/priceParmValue/ priceParmVal
53	Description	C1_PRICE_PARM_BO/21/priceParmValue/descr
54	Pricing Eligibility Criteria	C1_PRICE_PARM_BO/pricingEligibilitySw
55	Price Item	C1_PRICE_PARM_BO/priceItemSw
56	Price List Eligibility Criteria	C1_PRICE_PARM_BO/priceListEligibilitySw
57	Product Eligibility Criteria	C1_PRICE_PARM_BO/productEligibilitySw
58	Parameter	C1_PRICE_PARM_BO/priceParmCode
59	Description	C1_PRICE_PARM_BO/description
60	Value Type	C1_PRICE_PARM_BO/priceParmTypeFlag
61	Source Entity	C1_PRICE_PARM_BO/sourceEntityFlg
62	Source Type	C1_PRICE_PARM_BO/sourceTypeFlg
63	Source Type Code	C1_PRICE_PARM_BO/sourceTypeCode
64	Validation Algorithm	C1_PRICE_PARM_BO/validationAlgoCd
65	Reference Entity	C1_PRICE_PARM_BO/referredTable
66	Field Name	C1_PRICE_PARM_BO/referredField
67	Parameter Values	C1_PRICE_PARM_BO/0/priceParmValue/ priceParmVal
68	Description	C1_PRICE_PARM_BO/0/priceParmValue/descr

Sequence	Field Name	Map Field XPath
69	Parameter Values	C1_PRICE_PARM_BO/1/priceParmValue/ priceParmVal
70	Description	C1_PRICE_PARM_BO/1/priceParmValue/descr
71	Parameter Values	C1_PRICE_PARM_BO/2/priceParmValue/ priceParmVal
72	Description	C1_PRICE_PARM_BO/2/priceParmValue/descr
73	Parameter Values	C1_PRICE_PARM_BO/3/priceParmValue/ priceParmVal
74	Description	C1_PRICE_PARM_BO/3/priceParmValue/descr
75	Parameter Values	C1_PRICE_PARM_BO/4/priceParmValue/ priceParmVal
76	Description	C1_PRICE_PARM_BO/4/priceParmValue/descr
77	Parameter Values	C1_PRICE_PARM_BO/5/priceParmValue/ priceParmVal
78	Description	C1_PRICE_PARM_BO/5/priceParmValue/descr
79	Parameter Values	C1_PRICE_PARM_BO/6/priceParmValue/ priceParmVal
80	Description	C1_PRICE_PARM_BO/6/priceParmValue/descr
81	Parameter Values	C1_PRICE_PARM_BO/7/priceParmValue/ priceParmVal
82	Description	C1_PRICE_PARM_BO/7/priceParmValue/descr
83	Parameter Values	C1_PRICE_PARM_BO/8/priceParmValue/ priceParmVal
84	Description	C1_PRICE_PARM_BO/8/priceParmValue/descr
85	Parameter Values	C1_PRICE_PARM_BO/9/priceParmValue/ priceParmVal
86	Description	C1_PRICE_PARM_BO/9/priceParmValue/descr
87	Parameter Values	C1_PRICE_PARM_BO/10/priceParmValue/ priceParmVal
88	Description	C1_PRICE_PARM_BO/10/priceParmValue/descr
89	Parameter Values	C1_PRICE_PARM_BO/11/priceParmValue/ priceParmVal
90	Description	C1_PRICE_PARM_BO/11/priceParmValue/descr

Sequence	Field Name	Map Field XPath
91	Parameter Values	C1_PRICE_PARM_BO/12/priceParmValue/ priceParmVal
92	Description	C1_PRICE_PARM_BO/12/priceParmValue/descr
93	Parameter Values	C1_PRICE_PARM_BO/13/priceParmValue/ priceParmVal
94	Description	C1_PRICE_PARM_BO/13/priceParmValue/descr
95	Parameter Values	C1_PRICE_PARM_BO/14/priceParmValue/ priceParmVal
96	Description	C1_PRICE_PARM_BO/14/priceParmValue/descr
97	Parameter Values	C1_PRICE_PARM_BO/15/priceParmValue/ priceParmVal
98	Description	C1_PRICE_PARM_BO/15/priceParmValue/descr
99	Parameter Values	C1_PRICE_PARM_BO/16/priceParmValue/ priceParmVal
100	Description	C1_PRICE_PARM_BO/16/priceParmValue/descr
101	Parameter Values	C1_PRICE_PARM_BO/17/priceParmValue/ priceParmVal
102	Description	C1_PRICE_PARM_BO/17/priceParmValue/descr
103	Parameter Values	C1_PRICE_PARM_BO/18/priceParmValue/ priceParmVal
104	Description	C1_PRICE_PARM_BO/18/priceParmValue/descr
105	Parameter Values	C1_PRICE_PARM_BO/19/priceParmValue/ priceParmVal
106	Description	C1_PRICE_PARM_BO/19/priceParmValue/descr
107	Parameter Values	C1_PRICE_PARM_BO/20/priceParmValue/ priceParmVal
108	Description	C1_PRICE_PARM_BO/20/priceParmValue/descr
109	Parameter Values	C1_PRICE_PARM_BO/21/priceParmValue/ priceParmVal
110	Description	C1_PRICE_PARM_BO/21/priceParmValue/descr
111	Pricing Eligibility Criteria	C1_PRICE_PARM_BO/pricingEligibilitySw
112	Price Item	C1_PRICE_PARM_BO/priceItemSw
113	Price List Eligibility Criteria	C1_PRICE_PARM_BO/priceListEligibilitySw

Sequence	Field Name	Map Field XPath
114	Product Eligibility Criteria	C1_PRICE_PARM_BO/productEligibilitySw

Sample CSV

```
COUNTRY,COUNTRY,DFV,PERS,COUNTRY,FLD,,,,,AUT,Austria,AUS,Australia,CAN,Canada,
CHN,China,DNK,Denmark,EGY,Egypt,FRA,France,DEU,Germany,IND,India,ITA,Italy,
JPN,Japan,MYS,Malaysia,MEX,Mexico,NOR,Norway,PHL,Philippines,RUS,Russia,ESP,
Spain,LKA,Sri Lanka,SWE,Sweden,CHE,Switzerland,THA,Thailand,USA,
United States of America,Y,Y,N,N,CURRENCY,CURRENCY,DFV,ACCT,CURRENCY_CD,FLD,,,,,
EUR,Euro,AUD,Australian Dollar,CAD,Canadian Dollar,CNY,Chinese Yuan,DKK,Danish Krone,
EGP,Egyptian Pound,INR,Indian Rupee,JPY,Japanese Yen,MYR,Malaysian Ringgit,MXN,
Mexican Peso,NOK,Norwegian Krone,PHP,Philippine,RUB,Russian Ruble,LKR,
Sri Lankan Rupee,SEK,Swedish Krona,CHF,Swiss Franc,THB,Thai Baht,USD,
United States Dollar,,,,,,,,,Y,Y,N,N
```

Related Topics

For more information on...	See...
CSV File Format for Uploading Parameters	CSV File Format for Uploading Parameters on page 2408

Uploading an SQI File in the XML Format

To upload an SQI file in the XML format using the **File Upload Interface** utility, you need to do the following:

1. Define a file request type for uploading SQIs in the XML format
2. Upload the SQI file
3. Create the SQIs in the system

Related Topics

For more information on...	See...
How to define a file request type for uploading SQIs in the XML format	Defining a File Request Type for Uploading SQIs in the XML Format on page 2418
How to upload an SQI file	Uploading an SQI File on page 2419
How to create the SQIs in the system	Creating SQIs on page 2419

Defining a File Request Type for Uploading SQIs in the XML Format

Procedure

To define a file request type for uploading SQIs in the XML format:

1. Click the **Admin** link in the **Application** toolbar.
A list appears.
2. From the **Admin** menu, select **F** and then click **File Request Type**.
A sub-menu appears.
3. Click the **Add** option from the **File Request Type** sub-menu.
The **File Request Type** screen appears.
4. Enter the file request type and description in the respective fields.
5. Ensure that the **Extensible Markup Language** option is selected from the **File Format** list.

6. Attach an algorithm created using the **C1-FRHVA** algorithm type to the **File Validation Algorithm** field.
7. In the **Services** section, enter the required sequence number.
8. Select the **Business Service** option from the **Service Type** list.
9. Enter the **C1-SQIUPLOAD** business service or custom SQI business service in the **Service Name** field.
10. Select the **Add** option from the **Operation** list.

Note: At present, you cannot edit the existing SQIs using the **Price Item, Parameter, and SQI Upload** feature. You can only edit the existing SQIs from the user interface.

11. Click **Save**.

The file request type is defined for uploading SQIs in the XML format.

Uploading an SQI File

You can upload an SQI file using the **File Transformation and Upload (C1-FTRAN)** batch. While executing this batch, you must specify a file request type which is defined for uploading the SQI files in the XML format. For more information about the batch, refer to *Oracle Revenue Management and Billing Batch Guide*.

Creating SQIs

You can create the SQIs in the system using the **File Request Processing (C1-FREQP)** batch. While executing this batch, you must specify a file request type which is defined for uploading the SQI files in the XML format. For more information about the batch, refer to *Oracle Revenue Management and Billing Batch Guide*.

Uploading an SQI File in the CSV Format

To upload an SQI file in the CSV format using the **File Upload Interface** utility, you need to do the following:

1. Define a file request type for uploading SQIs in the CSV format
2. Upload the SQI file
3. Create the SQIs in the system

Related Topics

For more information on...	See...
How to define a file request type for uploading SQIs in the CSV format	Defining a File Request Type for Uploading SQIs in the CSV Format on page 2419
How to upload an SQI file	Uploading an SQI File on page 2420
How to create the SQIs in the system	Creating SQIs on page 2421

Defining a File Request Type for Uploading SQIs in the CSV Format

Procedure

To define a file request type for uploading SQIs in the CSV format:

1. Click the **Admin** link in the **Application** toolbar.
A list appears.
2. From the **Admin** menu, select **F** and then click **File Request Type**.
A sub-menu appears.
3. Click the **Add** option from the **File Request Type** sub-menu.

The **File Request Type** screen appears.

4. Enter the file request type and description in the respective fields.
5. Select the **Data Transformation Required** option.
The **File Format** field is enabled.
6. Select the **Comma Separated Values** option from the **File Format** list.
7. Enter `csv` in the **File Extension** field.
8. Attach an algorithm created using the **C1-FRHVA** algorithm type to the **File Validation Algorithm** field.
9. Attach an algorithm created using the **C1-FRTA** algorithm type to the **Data Transformation Algorithm** field.
10. In the **Services** section, enter the required sequence number.
11. Select the **Business Service** option from the **Service Type** list.
12. Enter the **C1-SQIUPLOAD** business service or custom SQI business service in the **Service Name** field.
13. Select the **Add** option from the **Operation** list.

Note: At present, you cannot edit the existing SQIs using the **Price Item, Parameter, and SQI Upload** feature. You can only edit the existing SQIs from the user interface.

14. If you have included a header in the CSV file, add the appropriate details in the **Header Transformation** section.
15. Similarly, if you have included a footer in the CSV file, add the appropriate details in the **Footer Transformation** section.
16. In the **Field Transformation** section, specify the following details:

Field Name	Field Description	Mandatory (Yes or No)
Sequence	Used to indicate the data field in the CSV record which you want to upload in the system.	Yes
Field Name	Used to indicate the field for which the data is uploaded in the system.	Yes
Map Field XPath	Used to specify the XPath of the field where you want to store the data field from the CSV record.	Yes

For example,

Sequence	Field Name	Map Field XPath
1	DECIMALPOSITIONS	C1-SQIUPLOAD/decimalPositions
2	DESCRIPTION	C1-SQIUPLOAD/description

17. Click **Save**.

The file request type is defined for uploading SQIs in the CSV format.

Uploading an SQI File

You can upload an SQI file using the **File Transformation and Upload (C1-FTRAN)** batch. While executing this batch, you must specify a file request type which is defined for uploading the SQI files in the CSV format. For more information about the batch, refer to *Oracle Revenue Management and Billing Batch Guide*.

Creating SQIs

You can create the SQIs in the system using the **File Request Processing (C1-FREQP)** batch. While executing this batch, you must specify a file request type which is defined for uploading the SQI files in the CSV format. For more information about the batch, refer to *Oracle Revenue Management and Billing Batch Guide*.

XML File Format for Uploading Service Quantity Identifiers (SQIs)

Before uploading an SQI file through the **File Upload Interface** utility, you need to ensure that the XML file contains the following tags:

Tag Name	Tag Description	Mandatory (Yes or No)
C1-SQIUPLOAD	Used to specify the details of the SQI whose record you want to create or update in the system.	Yes
serviceQuantityIdentifier	Used to specify the service quantity identifier (SQI).	Yes (Conditional) Note: This data is required when you want to define an SQI.
description	Used to specify the description for the SQI.	Yes (Conditional) Note: This data is required when you want to define an SQI.
decimalPositions	Used to specify the appropriate number of decimal positions for the SQI. Note: If you do not specify the value in this tag, by default, it is set to zero (0). You can specify maximum precision of 18 decimal positions for an SQI.	No

Related Topics

For more information on...	See...
Sample XML Format for Uploading Service Quantity Identifiers (SQIs)	Sample XML Format for Uploading Service Quantity Identifiers (SQIs) on page 2421

Sample XML Format for Uploading Service Quantity Identifiers (SQIs)

Using the below example, you can create the following SQIs:

- ACCTBAL
- AVGDBAL

- OVDLMT

```

<root>
<request>
<payload>
<C1-SQIUPLOAD>
  <serviceQuantityIdentifier>ACCTBAL</serviceQuantityIdentifier>
  <description>Account Balance</description>
  <decimalPositions>18</decimalPositions>
</C1-SQIUPLOAD>
<C1-SQIUPLOAD>
  <serviceQuantityIdentifier>AVGDBAL</serviceQuantityIdentifier>
  <description>Average Daily Balance</description>
  <decimalPositions>18</decimalPositions>
</C1-SQIUPLOAD>
<C1-SQIUPLOAD>
  <serviceQuantityIdentifier>OVDLMT</serviceQuantityIdentifier>
  <description>Overdraft Limit</description>
  <decimalPositions>18</decimalPositions>
</C1-SQIUPLOAD>
</payload>
</request>
</root>

```

Related Topics

For more information on...	See...
XML File Format for Uploading Service Quantity Identifiers (SQIs)	XML File Format for Uploading Service Quantity Identifiers (SQIs) on page 2421

CSV File Format for Uploading Service Quantity Identifiers (SQIs)

Before uploading an SQI file through the **File Upload Interface** utility, you need to ensure that the CSV file contains the following data:

Data	Description	Mandatory (Yes or No)
Service Identifier	Quantity Used to specify the service quantity identifier (SQI).	Yes (Conditional) Note: This data is required when you want to define an SQI.
Description	Used to specify the description for the SQI.	Yes (Conditional) Note: This data is required when you want to define an SQI.
Decimal Positions	Used to specify the appropriate number of decimal positions for the SQI. Note: If you do not specify the value in this tag, by default, it is set to zero (0). You can specify maximum precision of 18 decimal positions for an SQI.	No

Related Topics

For more information on...	See...
Sample CSV Format for Uploading Service Quantity Identifiers (SQIs)	Sample CSV Format for Uploading SQIs on page 2423

Sample CSV Format for Uploading SQIs

Using the below example, you can create the following SQIs:

- ACCTBAL
- AVGDBAL
- OVDLMT

Note: The system will create the above SQIs when the required value types, source entities, source types, source type codes, algorithms, and reference entity values are defined in the application.

Sequence	Field Name	Map Field XPath
1	SQI	C1-SQIUPLOAD/serviceQuantityIdentifier
2	Description	C1-SQIUPLOAD/description
3	Decimal Positions	C1-SQIUPLOAD/decimalPositions
4	SQI	C1-SQIUPLOAD/serviceQuantityIdentifier
5	Description	C1-SQIUPLOAD/description
6	Decimal Positions	C1-SQIUPLOAD/decimalPositions
7	SQI	C1-SQIUPLOAD/serviceQuantityIdentifier
8	Description	C1-SQIUPLOAD/description
9	Decimal Positions	C1-SQIUPLOAD/decimalPositions

Sample CSV

```
ACCTBAL,Account Balance,18,AVGDBAL,Average Daily Balance,18,OVDLMT,Overdraft Limit,18
```

Related Topics

For more information on...	See...
CSV File Format for Uploading SQIs	CSV File Format for Uploading Service Quantity Identifiers (SQIs) on page 2422

Uploading Price Items, Parameters, and SQIs from the Same File

If the price item, parameter, and SQI information is given in the same file, you need to use a file request type where the following business objects and business service are added in the **Services** section:

- C1_PRICE_PARM

- C1-SQIUPLOAD
- C1_PRICEITEM_BO

Note that the **C1_PRICE_PARM** business object and the **C1-SQIUPLOAD** business service should have higher sequence compared to the **C1_PRICEITEM_BO** business object in such file request type. Otherwise, erroneous results might occur.

Related Topics

For more information on...	See...
How to define a file request type for uploading price items in the XML format	Defining a File Request Type for Uploading Price Items in the XML Format on page 2361
How to define a file request type for uploading price items in the CSV format	Defining a File Request Type for Uploading Price Items in the CSV Format on page 2362
How to define a file request type for uploading parameters in the XML format	Defining a File Request Type for Uploading Parameters in the XML Format on page 2397
How to define a file request type for uploading parameters in the CSV format	Defining a File Request Type for Uploading Parameters in the CSV Format on page 2398
How to define a file request type for uploading SQIs in the XML format	Defining a File Request Type for Uploading SQIs in the XML Format on page 2418
How to define a file request type for uploading SQIs in the CSV format	Defining a File Request Type for Uploading SQIs in the CSV Format on page 2419

Chapter 38

Product and Product Version Upload

Oracle Revenue Management and Billing enables you to create new products and edit the existing products using the **File Upload Interface** utility. You can upload the product file in the XML or CSV format using the **File Upload Interface** utility. You can specify the following in the XML and CSV files along with the basic details of the product:

- Divisions which you want to associate with the product
- Characteristics for the product
- Details of the product to product relationship

The system also enables you to create new product versions and edit the existing product versions using the **File Upload Interface** utility. You can upload product versions along with the product or separately based on the requirements. You can specify the following in the XML and CSV files along with the basic details of the product version:

- Characteristics for the product version
- Eligibility criteria for the product version
- Services and price list which you want to add in the product version
- Standard products and their services which you want to add in the product version (in case of packaged product)

Chapter 39

Price List and Price Item Pricing Upload

Oracle Revenue Management and Billing enables you to create new price lists and edit the existing price lists using the **File Upload Interface** utility. You can upload the price list file in the XML or CSV format using the **File Upload Interface** utility.

You can specify the following in the XML and CSV files along with the basic details of the price list:

- Divisions which you want to associate with the price list
- Characteristics for the price list
- Eligibility criteria for the price list
- Hierarchy details for the price list

To upload the price list file in the XML format using the **File Upload Interface** utility, you need to do the following:

1. Define a file request type with the following specifications:
 - Set the **File Format** field to **Extensible Markup Language**.
 - Attach an algorithm created using the **C1-FRHVA** algorithm type to the **File Validation Algorithm** field.
 - Add the **C1_PRICEASSIGN_SERVICE** business service in the **Services** section.
 - Set the **Operation** field to **Add** or **Replace** depending on whether you want to create new price lists or edit the existing price lists using the file request type.
2. Execute the **File Transformation and Upload Batch (C1-FTRAN)** batch to upload the price list file.
3. Execute the **File Request Processing (C1-FREQP)** batch to create or edit the price lists in the system.

Note: For more information about the XML file format, refer to *Oracle Revenue Management and Billing Banking User Guide* or *Oracle Revenue Management and Billing Insurance User Guide*.

To upload the price list file in the CSV format using the **File Upload Interface** utility, you need to do the following:

1. Define a file request type with the following specifications:
 - Set the **File Format** field to **Comma Separated Values**.
 - Select the **Data Transformation Required** option.

- Attach an algorithm created using the **C1-FRHVA** algorithm type to the **File Validation Algorithm** field.
- Attach an algorithm created using the **C1-FRTA** algorithm type to the **Data Transformation Algorithm** field.
- Add the **C1_PRICEASSIGN_SERVICE** business service in the **Services** section.
- Set the **Operation** field to **Add** or **Replace** depending on whether you want to create new price lists or edit the existing price lists using the file request type.
- Specify the following details in the Field Transformation section:
 - **Sequence** – Used to specify the data field in the CSV record which should be uploaded in the system.
 - **Field Name** – Used to indicate the field for which the data is uploaded in the system.
 - **Map Field XPath** – Used to specify the XPath of the field where you want to store the data field from the CSV record.

For example,

Sequence	Field Name	Map Field XPath
1	PRICELISTID	C1_PRICEASSIGN_SERVICE/0/pricelist/priceListId
2	DESCRIPTION	C1_PRICEASSIGN_SERVICE/0/pricelist/description

This means that the system should upload the first value (i.e. price list ID) and second value (i.e. price list description) from the CSV record in the **priceListId** and **description** fields using the **C1_PRICEASSIGN_SERVICE** business service.

2. Execute the **File Transformation and Upload Batch (C1-FTRAN)** batch to upload the price list file.
3. Execute the **File Request Processing (C1-FREQP)** batch to create or edit the price lists in the system.

Note: For more information about the CSV file format, refer to *Oracle Revenue Management and Billing Banking User Guide* or *Oracle Revenue Management and Billing Insurance User Guide*.

The system also enables you to create new price item pricing for an account, customer, or price list and edit the existing price item pricing assigned to an account, customer, or price list using the **File Upload Interface** utility. You can upload price item pricing along with the price list or separately based on the requirements.

You can specify the following in the XML and CSV files along with the basic details of price item pricing:

- Person, account, or price list to which you want to assign the price item pricing
- Characteristics for the price item pricing

- Price item parameters based on which you want to define the price item pricing
- Basic details for the price components
- Tiering criteria for the price component (if the **Tiering Type** of the corresponding rate component is set to **STEP** or **Threshold**)
- Eligibility criteria for the price component (if the **Tiering Type** of the corresponding rate component is set to **STEP** or **Threshold**)

To upload the price assignments file in the XML format using the **File Upload Interface** utility, you need to do the following:

1. Define a file request type with the following specifications:
 - Set the **File Format** field to **Extensible Markup Language**.
 - Attach an algorithm created using the **C1-FRHVA** algorithm type to the **File Validation Algorithm** field.
 - Add the **C1_PRICEASSIGN_SERVICE** business service in the **Services** section.
 - Set the **Operation** field to **Add** or **Replace** depending on whether you want to create new price item pricing or edit the existing price item pricing using the file request type.
2. Execute the **File Transformation and Upload Batch (C1-FTRAN)** batch to upload the price assignments file.
3. Execute the **File Request Processing (C1-FREQP)** batch to create or edit the price item pricing in the system.

Note: For more information about the XML file format, refer to *Oracle Revenue Management and Billing Banking User Guide* or *Oracle Revenue Management and Billing Insurance User Guide*.

To upload the price assignments file in the CSV format using the **File Upload Interface** utility, you need to do the following:

1. Define a file request type with the following specifications:
 - Set the **File Format** field to **Comma Separated Values**.
 - Select the **Data Transformation Required** option.
 - Attach an algorithm created using the **C1-FRHVA** algorithm type to the **File Validation Algorithm** field.
 - Attach an algorithm created using the **C1-FRTA** algorithm type to the **Data Transformation Algorithm** field.
 - Add the **C1_PRICEASSIGN_SERVICE** business service in the **Services** section.
 - Set the **Operation** field to **Add** or **Replace** depending on whether you want to create new price item pricing or edit the existing price item pricing using the file request type.
 - Specify the following details in the Field Transformation section:
 - **Sequence** – Used to specify the data field in the CSV record which should be uploaded in the system.

- **Field Name** – Used to indicate the field for which the data is uploaded in the system.
 - **Map Field XPath** – Used to specify the XPath of the field where you want to store the data field from the CSV record.
2. Execute the **File Transformation and Upload Batch (C1-FTRAN)** batch to upload the price assignments file.
 3. Execute the **File Request Processing (C1-FREQP)** batch to create or edit the price item pricing in the system.

Note: For more information about the CSV file format, refer to *Oracle Revenue Management and Billing Banking User Guide* or *Oracle Revenue Management and Billing Insurance User Guide*.

Chapter 40

Invoice Request

Topics:

- [Prerequisites](#)
- [Types of Invoice Request](#)
- [Invoice Request Manual Trial Bill Generation \(Without Approval\) Status Transition](#)
- [Invoice Request Manual Regular Bill Generation \(Without Approval\) Status Transition](#)
- [Invoice Request Manual Regular Bill Generation \(With Approval\) Status Transition](#)
- [Invoice Request Automatic Regular Bill Generation \(Without Approval\) Status Transition](#)
- [Invoice Request Type](#)
- [Invoice Request \(Used for Searching\)](#)
- [Invoice Request \(Used for Viewing\)](#)

Oracle Revenue Management and Billing enables you to generate an adhoc regular or trial bill for an account through an invoice request. The system enables you to create an invoice request manually or automatically. It enables you to create an invoice request for a person or an account. You can create an invoice request for an account where the **Eligible For Invoice Request Creation (INVRACTE)** characteristic is set to **Y**.

If you create an invoice request for a person, the system will consider all those accounts of the person where the **Eligible For Invoice Request Creation (INVRACTE)** characteristic is set to **Y**. You can then exclude an account from the invoice request, if required. The system also enables you to consider all accounts of the person and its child persons where the **Eligible For Invoice Request Creation (INVRACTE)** characteristic is set to **Y**.

Note: The system searches for the characteristic type which is specified in the **Invoice Request Account Eligibility Char Type** option type of the **C1-INVREQ** feature configuration. By default, this option type is set to **INVRACTE**. You can change the characteristic type, if required.

In other words, the system enables you to create the following types of invoice request:

- **Manual Regular Bill Generation Invoice Request** - It is used to generate an adhoc regular bill for an account. You can create a manual regular bill generation invoice request for a person or an account from the user interface.
- **Manual Trial Bill Generation Invoice Request** - It is used to generate an adhoc trial bill for an account. You can create a manual trial bill generation invoice request for a person or an account from the user interface.
- **Automatic Regular Bill Generation Invoice Request** - It is used to generate an adhoc regular bill for an account. You can configure the system such that an automatic regular bill generation invoice request is created for an account automatically when a fully-insured group policy is activated, terminated, reinstated, or renewed from the user interface or through a health care inbound message.

Note:

The automatic invoice request creation feature is only designed to work for the fully-insured group health insurance business and not for the financial services or self-funded health insurance business.

You cannot create an automatic regular bill generation invoice request for a person.

At present, the system is not designed to create an automatic trial bill generation invoice request.

While creating an invoice request, you need to specify an invoice request type using which you want to create the invoice request. The system enables you to create the invoice request types with the following combinations:

Invoice Mode	Bill Generation Type	Approval Process
Manual	Regular	On
Manual	Regular	Off
Manual	Trial	Off
Automatic	Regular	Off

It is the invoice request type which helps the system to determine:

- The business object using which the invoice request should be created in the system

Note: Two invoice request business objects named **Invoice Request - Regular Bill Generation (C1-InvoiceRequest)** and **Invoice Request - Trial Bill Generation (C1-InvoiceRequestTrial)** are introduced in this release. If the **Bill Generation Type** field is set to **Regular**, you must select the **Invoice Request - Regular Bill Generation** business object from the **Invoice Request Business Object** list. However, if the **Bill Generation Type** field is set to **Trial**, you must select the **Invoice Request - Trial Bill Generation** business object from the **Invoice Request Business Object** list.

- Whether a manual or automatic invoice request should be created in the system
- Whether a regular or trial bill generation invoice request should be created in the system
- Whether a manual regular bill generation invoice request for an account should be processed in the online or deferred mode

Note:

The system will process a manual regular bill generation invoice request for an account in the deferred mode when the number of billable charges of the account exceeds the defer processing billable charge count.

The defer processing billable charge count is not considered when a manual regular bill generation invoice request is created for a person.

You can specify the defer processing billable charge count when the invoice mode is set to **Manual** and bill generation type is set to **Regular**.

- Whether the approval is required for the invoice request

Note: You can only set the **Approval Required** flag when the invoice mode is set to **Manual** and bill generation type is set to **Regular**.

- The wait days which is used to calculate the processing date for an invoice request

Note:

If the invoice request is processed in the online mode, the system will process the invoice request when the processing date is earlier than or equal to the system date. However, if the invoice request is processed in the deferred mode, the system will process the invoice request when the processing date is earlier than or equal to the batch business date.

If required, you can configure the system such that the processing date does not fall on a holiday. To implement this requirement you need to specify the work calendar which helps to determine the working day.

- The date calculation algorithm which is used to calculate the processing date for an automatic regular bill generation invoice request

Note: In addition, you can configure threshold days for automatic invoice request creation. It is used to determine whether the number of days between the bill cycle date and processing date is greater than the threshold days. This parameter is used in Invoice Request Date Calculation algorithm to check whether the processing date of the invoice request is within threshold period. If so, the automatic invoice request is not created for the account. This parameter is only applicable while activating or renewing a fully-insured group policy.

While creating a manual invoice request, you need to specify the following – invoice request type, entity (i.e. person or account for which the invoice request should be created), cutoff date, accounting date, and bill date.

Note: The cutoff date, accounting date, and bill date are derived while creating an automatic invoice request for an account.

For more information about the types of invoice request, see [Types of Invoice Request](#) on page 2434.

For more information on how to setup the invoice request feature, see [Prerequisites](#) on page 2434.

Prerequisites

To setup the invoice request process, you need to do the following:

- Define the required invoice request types in the system.
- Define the required characteristic types where the characteristic entity is set to **Invoice Request Type**
- Define the required characteristic types where the characteristic entity is set to **Invoice Request**
- Assign the **C1-INVRA** To Do type to a To Do role whose users must receive To Do generated while submitting an invoice request for approval
- Assign the **C1-INVRS** To Do type to a To Do role whose users must receive To Do generated while resubmitting an invoice request
- Set the batch control type of the **Invoice Request Periodic Monitor (C1-INVQR)** batch to **Timed** and define the following attributes:
 - Time Interval
 - Timer Active
 - User ID
 - Batch Language
 - Email Address

For more information about the **Invoice Request Periodic Monitor (C1-INVQR)** batch, see *Oracle Revenue Management and Billing Batch Guide*.

- Set the batch control type of the **Pending Bill Generation (BILLOPEN)**, **Bill Segment Generation (BSGENREG)**, and **Bill Completion (POSTPROC)** batches to **Timed** and define the following attributes:
 - Time Interval
 - Timer Active
 - User ID
 - Batch Language
 - Email Address

For more information about these batches, see *Oracle Revenue Management and Billing Batch Guide*.

Set the following feature configuration in the system:

- **Invoice Request Configuration (C1-INVREQ)**

Types of Invoice Request

The system allows you to create the following types of invoice requests:

- [Manual Regular Bill Generation Invoice Request](#) on page 2434
- [Manual Trial Bill Generation Invoice Request](#) on page 2436
- [Automatic Regular Bill Generation Invoice Request](#) on page 2436

Manual Regular Bill Generation Invoice Request

Once a manual regular bill generation invoice request is created in the **Draft** status, the system checks whether it is created for a person or an account. If a manual regular bill generation invoice request is created for an account,

you can submit the invoice request. On submitting the invoice request, the system checks whether the number of the billable charges of the account exceed the defer processing billable charge count. If the number of the billable charges of the account exceed the defer processing billable charge count, the status of the invoice request is changed to **Defer Processing Batch**. However, if the number of the billable charges of the account does not exceed the defer processing billable charge count, the system checks whether the processing date of the invoice request is earlier than or equal to the system date. If the processing date is later than the system date, the status of the invoice request is changed to **Defer Processing**. On the **C1-INVRQ** batch execution, the system checks whether there are any invoice requests in the **Defer Processing** status. If there is an invoice request in the **Defer Processing** status, the system checks whether the processing date of the invoice request is earlier than or equal to the system date. If the processing date is later than the system date, the status of the invoice request remains as **Defer Processing**.

Note: The system enables you to cancel an invoice request which is in the **Defer Processing Batch** or **Defer Processing** status.

However, if the processing date is earlier than or equal to the system date, the system checks whether the pending bill already exists for the account. If the pending bill does not exist for the account, the system checks whether the cutoff date is later than the bill after date. If cutoff date is later than the bill after date, the system checks whether the accounting calendar is open for the accounting date. If the accounting calendar is open for the accounting date, the system creates the adhoc regular bill for the account in the online mode. Finally, the status of the invoice request is changed to **Processed**.

However, if the pending bill exists for the account, or if the cutoff date is earlier than or equal to the bill after date, or if the accounting calendar is not open for the accounting date, or if an error occurs while creating adhoc regular bill or its bill segments, the status of the invoice request is changed to **Error**. The system enables you to move such erroneous invoice request back to the **Draft** status.

However, if a manual regular bill generation invoice request is created for a person, the system checks whether the number of accounts of the person (if the **Include Person Hierarchy** option is not selected) or the number of accounts of the person and its child persons (if the **Include Person Hierarchy** option is selected) exceeds the limit defined in the **Account Limit** option type of the **C1-INVREQ** feature configuration. If the number of accounts does not exceed the account limit, the system derives the account of the person or the person and its child persons. Once the accounts are successfully derived, the status of the invoice request is changed to **Defer Processing Batch**.

However, if the number of accounts exceeds the account limit, the status of the invoice request is changed to **Account Derivation Pending**. On the **C1-INVRQ** batch execution, the system checks whether there are any invoice requests in the **Account Derivation Pending** status. If there is an invoice request in the **Account Derivation Pending** status, the system derives the accounts of the person or the person and its child persons. Once the accounts are successfully derived, the status of the invoice request is changed to **Defer Processing Batch**.

When you execute the **BILLOPEN** batch with the **Off Cycle Switch** parameter set to **Y**, the system checks whether the account that meets the search criteria is included in any invoice request which is in the **Defer Processing Batch** status. If the account is included in the invoice request, the system checks whether the processing date of the invoice request is earlier than or equal to the batch business date. If processing date is earlier than or equal to the batch business date, the system checks whether there is any record in the **Processing** status for the account in the invoice request. If so, the system checks whether the pending bill already exists for the account. If the pending bill does not exist for the account, the system checks whether the cutoff date is later than the bill after date. If cutoff date is later than the bill after date, the system checks whether the accounting calendar is open for the accounting date. If the accounting calendar is open for the accounting date, the system creates the adhoc regular bill for the account in the **Pending** status. When you execute the **BSGENREQ** batch with the **Off Cycle Switch** parameter set to **Y**, the system creates the bill segments for the adhoc regular bill. When you execute the **POSTPROC** batch with the **Off Cycle Switch** parameter set to **Y**, the system creates the post-processing bill segments (if any) and completes the adhoc regular bill of the account. Finally, the status of the invoice request is changed to **Processed**.

However, if the pending bill exists for the account, or if the cutoff date is earlier than or equal to the bill after date, or if the accounting calendar is not open for the accounting date, or if an error occurs while creating adhoc regular bill or its bill segments, or if a To Do is generated for the bill review, the status of the record in the invoice request is changed to **Error**. If all records in the invoice request are in the **Error** status, the status of the invoice request is changed to **Error**. The system enables you to move such erroneous invoice request back to the **Draft** status.

You can optionally configure the approval process for the manual regular bill generation invoice request. If the **Approval Required** flag is set to **Yes** in the invoice request type, the status of the manual regular bill generation invoice request is changed to **Approval In Progress** when you submit the invoice request. The approver can then approve or reject the manual regular bill generation invoice request based on the observations.

Manual Trial Bill Generation Invoice Request

The manual regular bill generation invoice request and manual trial bill generation invoice request are created and processed identically with the following exceptions:

- On submitting the manual trial bill generation invoice request for an account, the system does not check whether the number of the billable charges of the account exceed the defer processing billable charge count. Therefore, the manual trial bill generation invoice request is always processed in the deferred mode.
- You need to specify the following parameters while executing the **BILLOPEN**, **BSGENREQ**, and **POSTPROC** batches:
 - Bill Generation Type (set to **Trial**)
 - Description for Trial Billing Batch Run
 - Off Cycle Switch (set to **Y**)
- The **BSGENREQ** batch will not freeze and complete a trail bill for the account.
- At present, a To Do is not generated for a trial bill review, and therefore the system does not check whether a To Do is generated for a trial bill review.

Automatic Regular Bill Generation Invoice Request

To enable the automatic invoice request creation feature for the fully-insured group health insurance business, you need to attach the following algorithms:

If you want to create an automatic invoice request for an account while...	Then attach the algorithm....			
	Business Object	Status	System Event	Algorithm
Activating a Fully-Insured Group Policy <div style="border: 1px solid black; padding: 5px;"> <p>Note: This happens only on the customer onboarding. If an invoice request is already processed for any account in the person's hierarchy, the system will not create an invoice request for the account.</p> </div>	C1-POLICY	In Force/ Active	Enter	C1- INVREQCRE
Terminating a Fully-Insured Group Policy		Terminated	Enter	C1- INVREQPT
Reinstating a Fully-Insured Group Policy		Reinstated	Enter	C1- INVREPRIN
Renewing a Fully-Insured Group Policy		-	Audit	C1- IRPOLREW
Creating an Account for a Parent Customer or Bill	C1- AccountBO	-	Post- Processing	C1- INVRACTPO

If you want to create an automatic invoice request for an account while...	Then attach the algorithm....			
	Business Object	Status	System Event	Algorithm
Group who is the Main Customer of the Fully-Insured Group Policy <div style="border: 1px solid black; padding: 5px;"> <p>Note: This happens only on the customer onboarding. If an invoice request is already processed for any account in the person's hierarchy, the system will not create an invoice request for the account.</p> </div>				

The above algorithms contain a parameter wherein you can specify the invoice request type using which the automatic invoice request should be created in the system.

If the automatic invoice request creation feature is configured for the fully-insured group health insurance business, the system creates an automatic regular bill generation invoice request in the **Defer Processing Batch** status for an account when:

- A fully-insured group policy is activated, terminated, reinstated, or renewed
- An account is created for a parent customer or bill group who is the main customer of the fully-insured group policy

The deferred mode processing for manual regular bill generation invoice request and automatic regular bill generation invoice request is identical.

Invoice Request Manual Trial Bill Generation (Without Approval) Status Transition

The following figure graphically indicates how an invoice request in the manual trial bill generation process moves from one status to another when the approval process is not configured in the invoice request type:

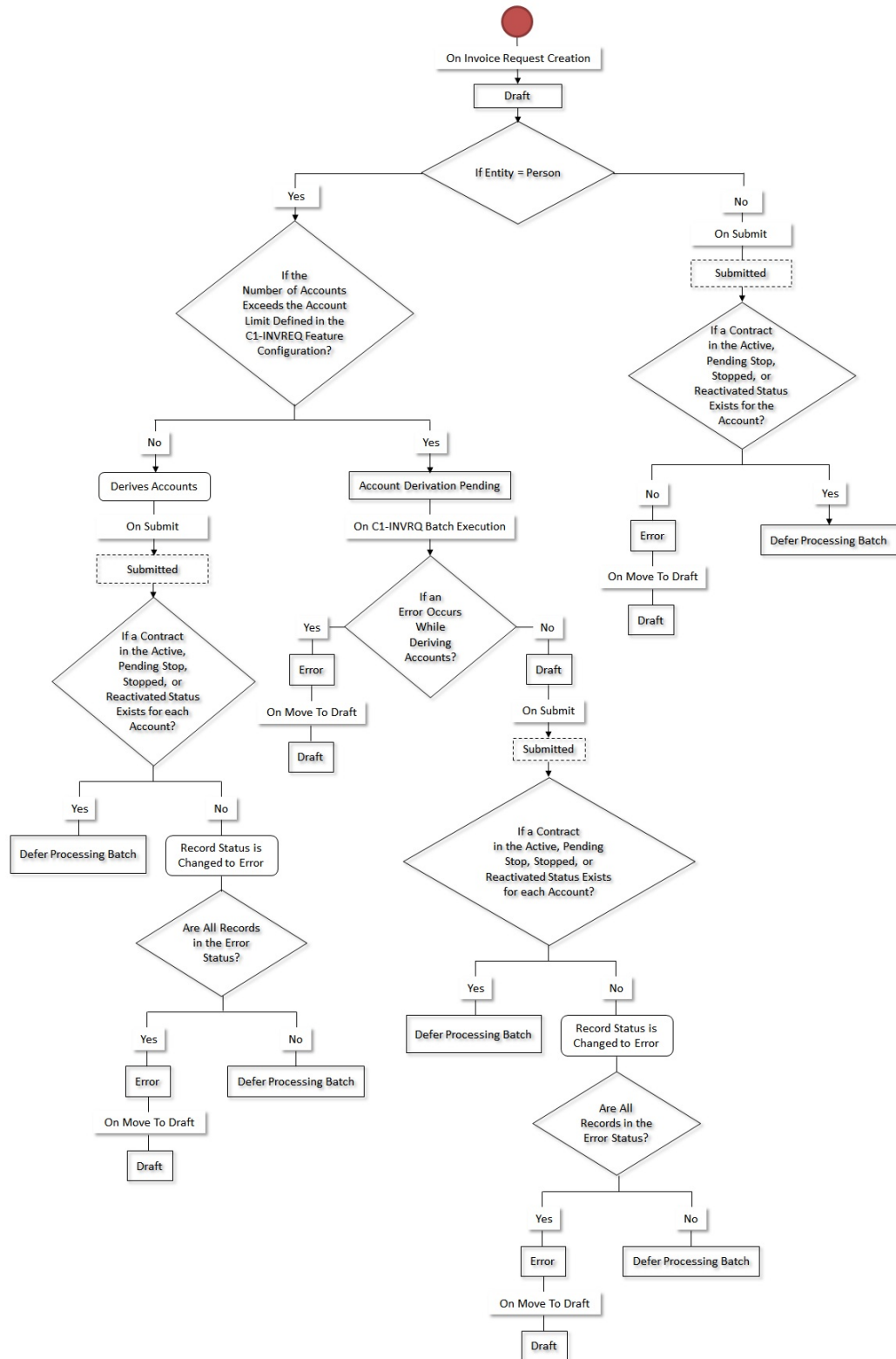

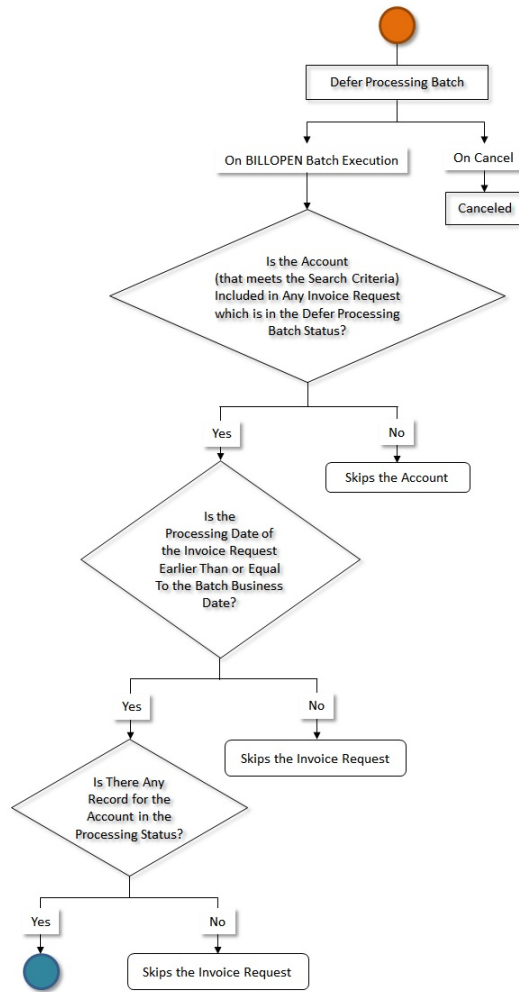

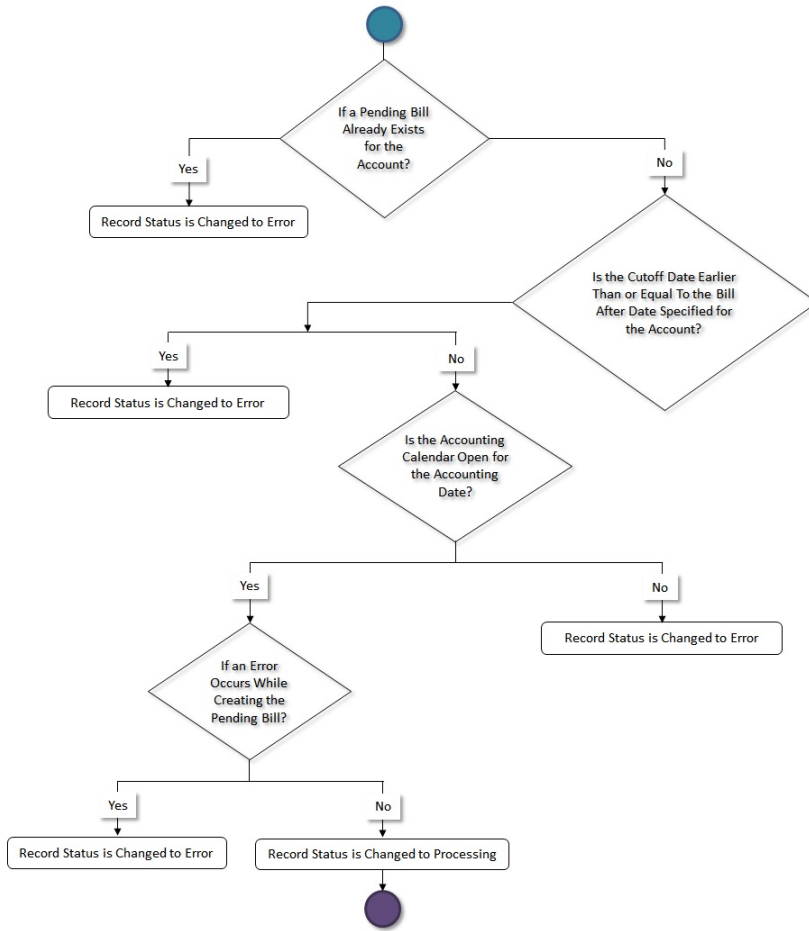

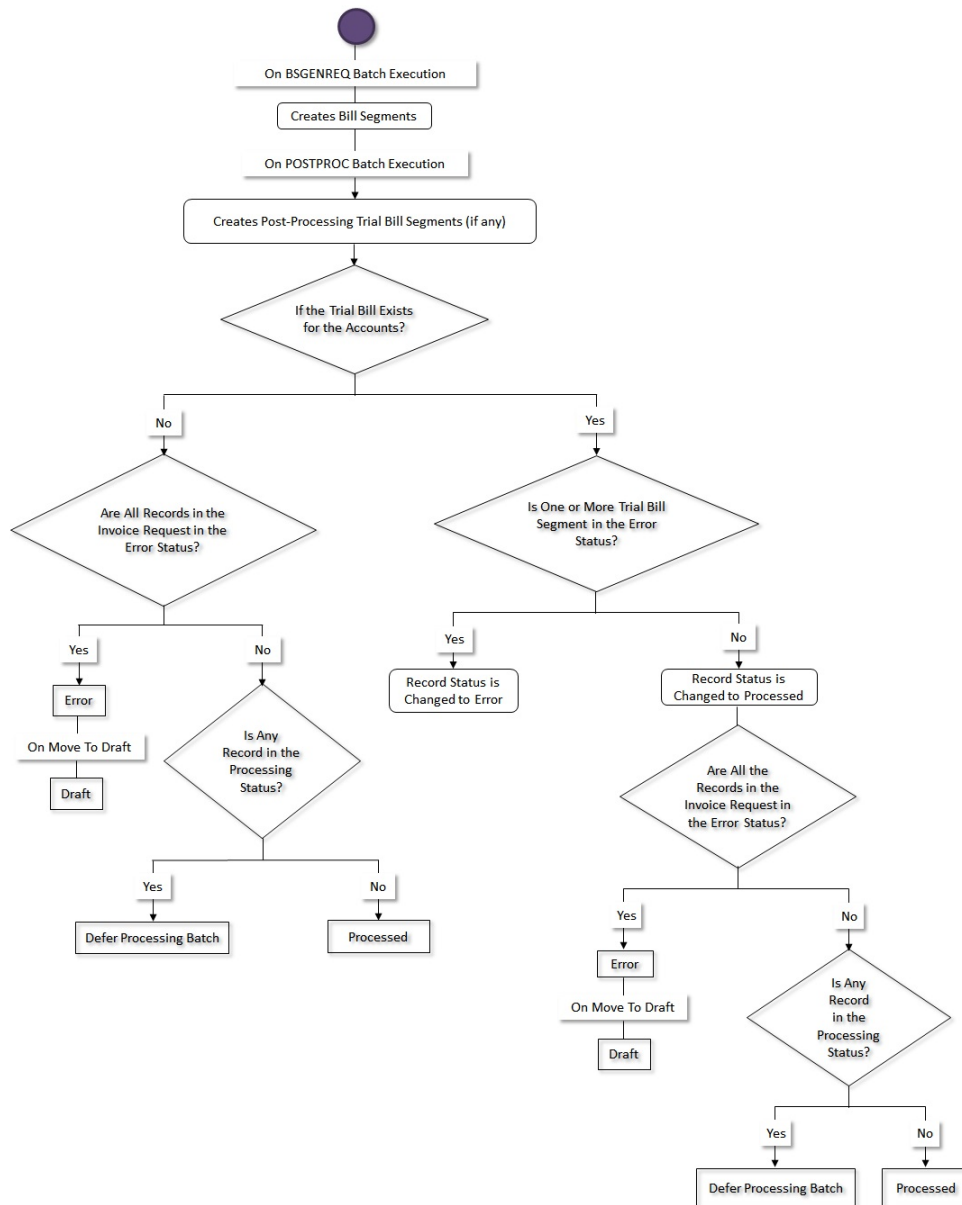

Invoice Request Manual Regular Bill Generation (Without Approval) Status Transition

The following figure graphically indicates how an invoice request in the manual regular bill generation process moves from one status to another when the approval process is not configured in the invoice request type:

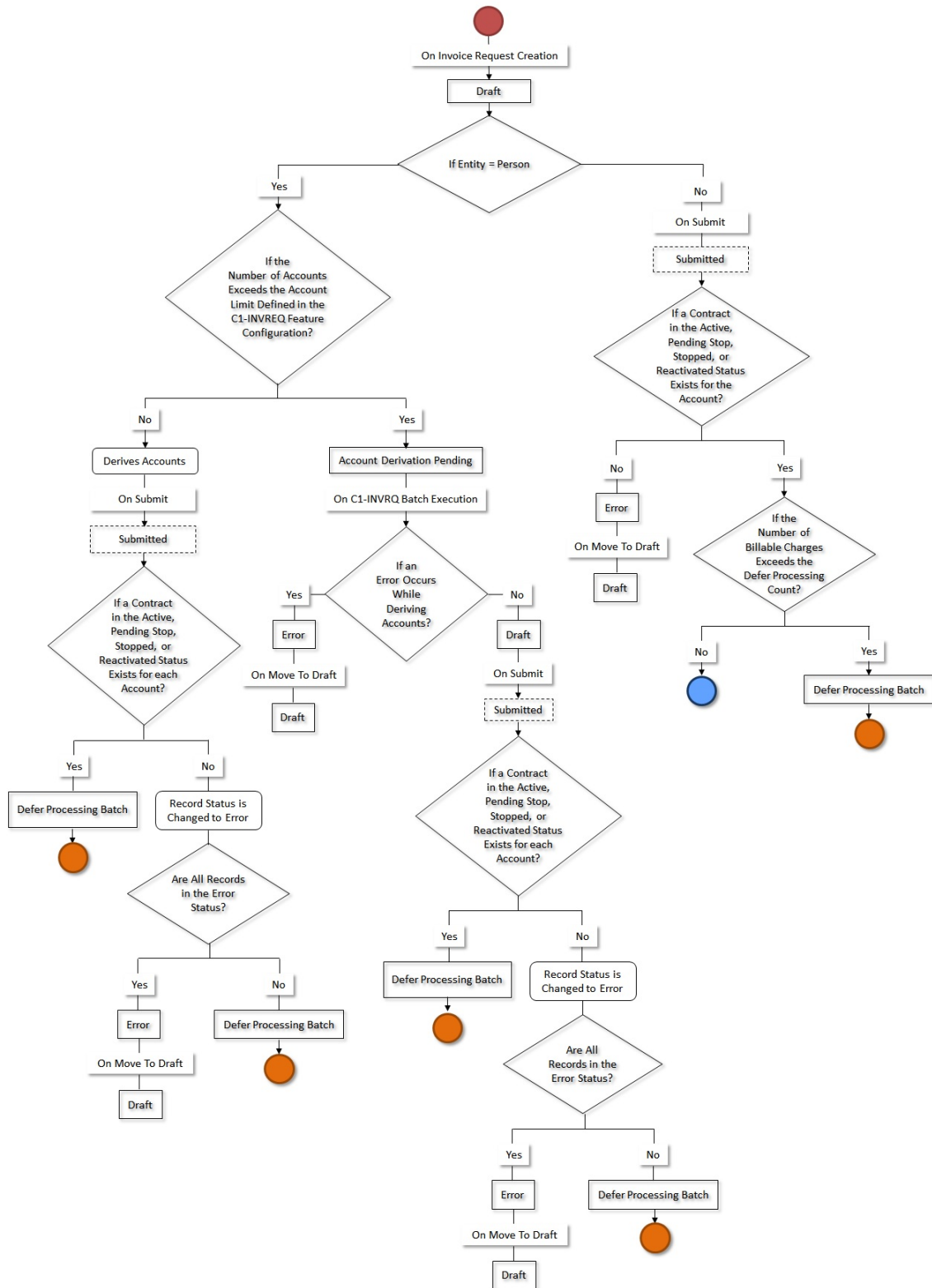

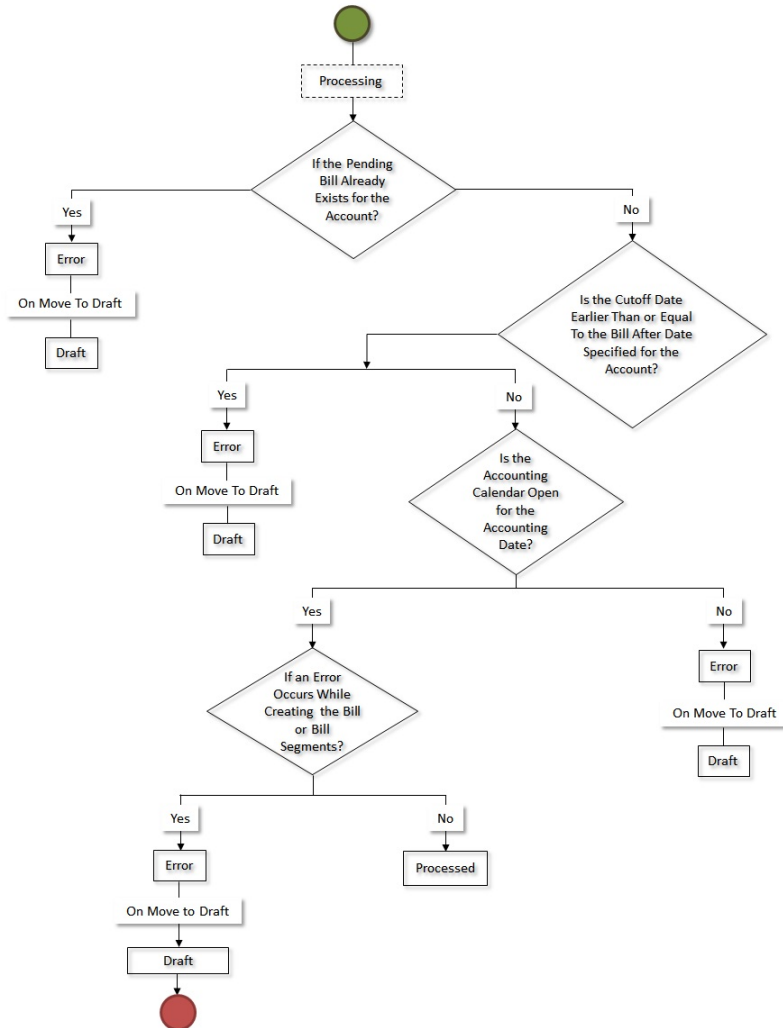
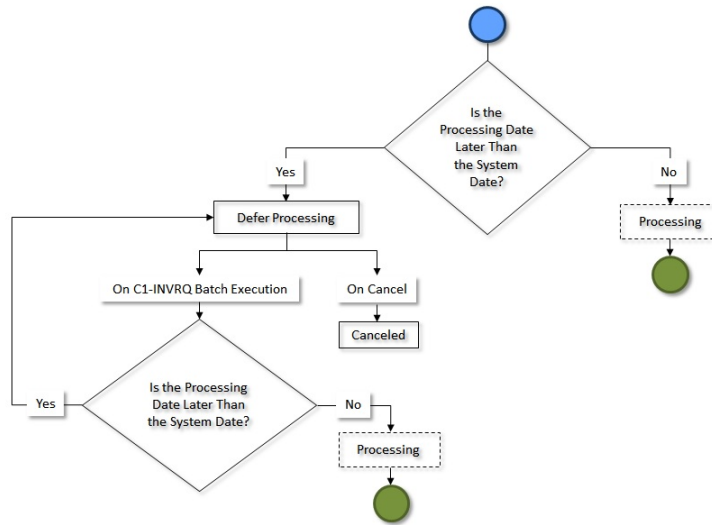

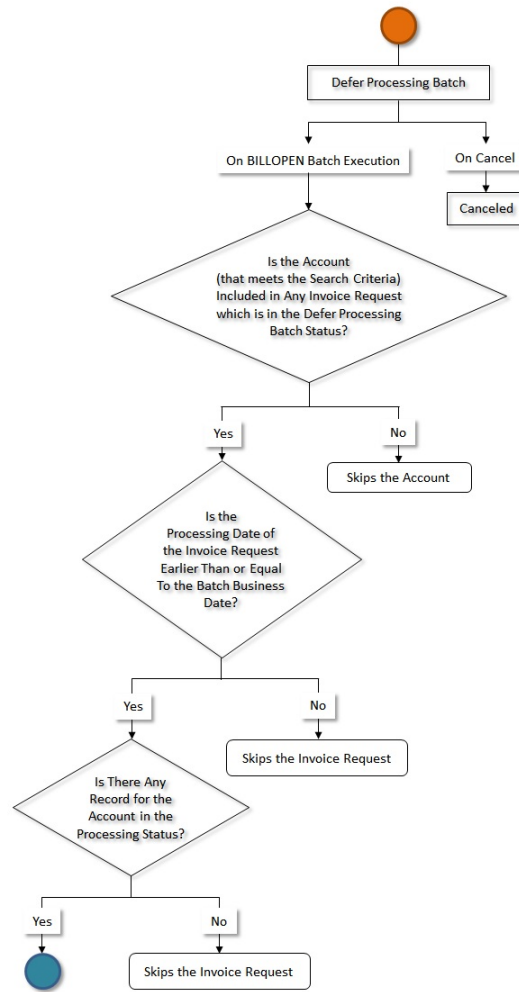

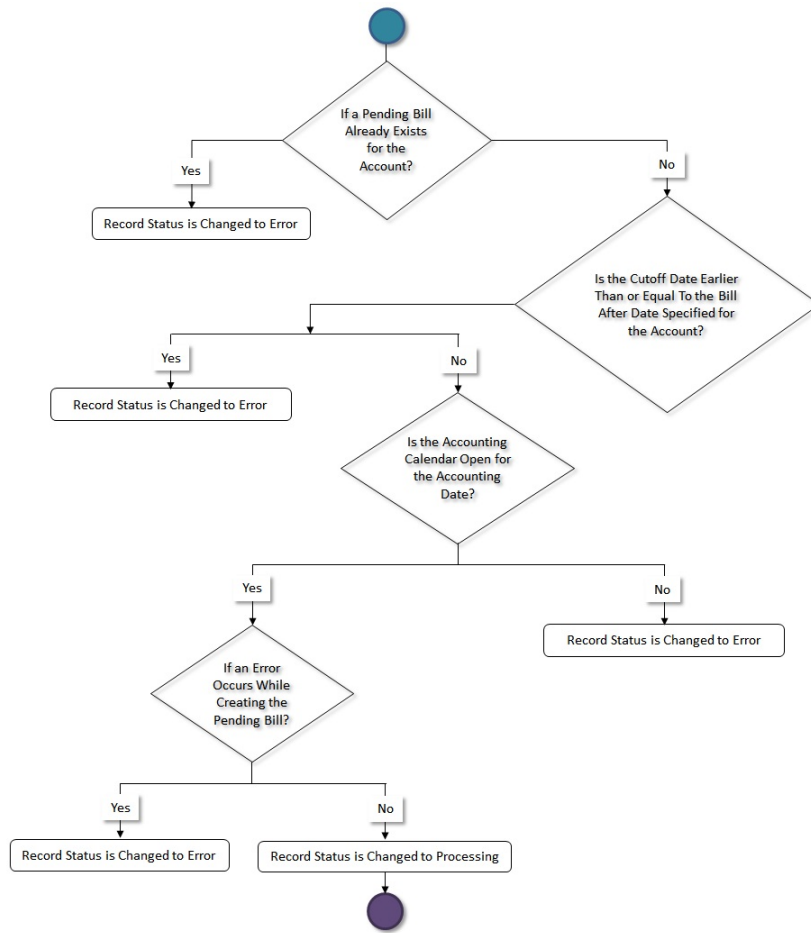

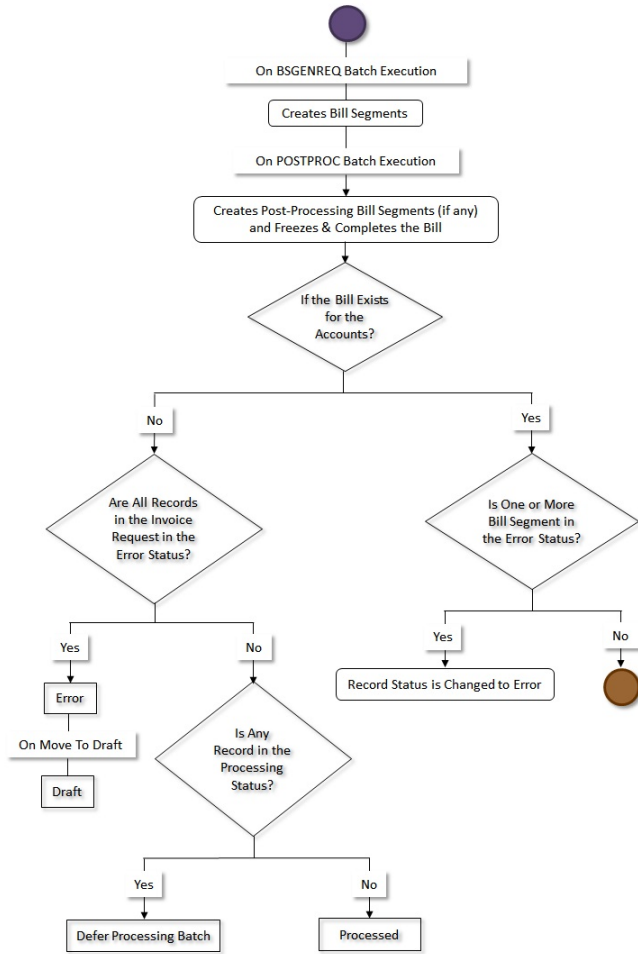

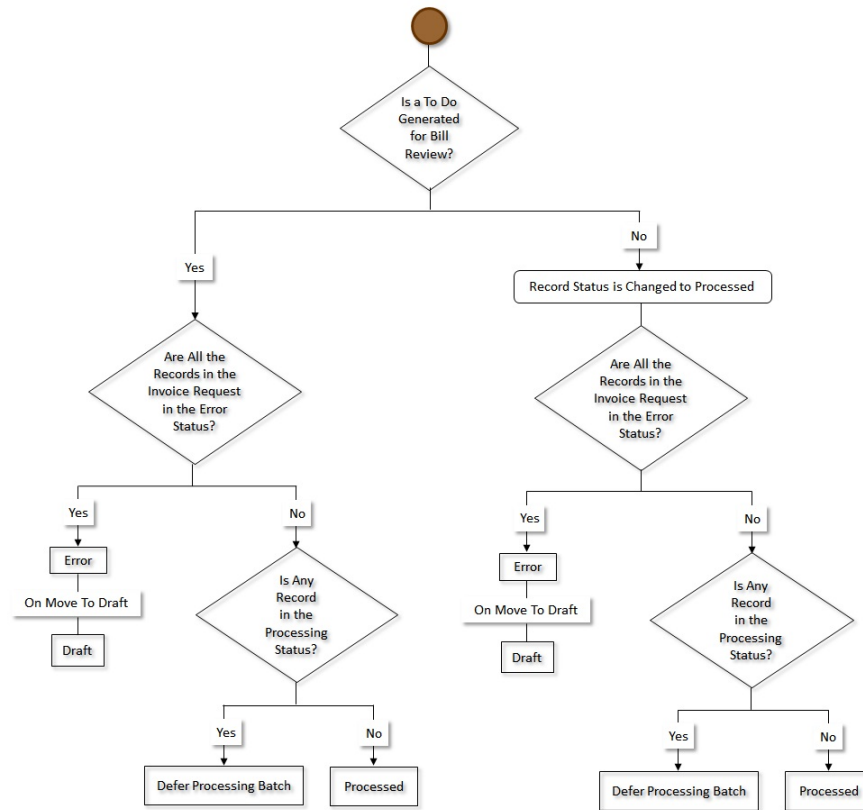

Invoice Request Manual Regular Bill Generation (With Approval) Status Transition

The following figure graphically indicates how an invoice request created through the manual regular bill generation process moves from one status to another when the approval process is configured in the invoice request type:

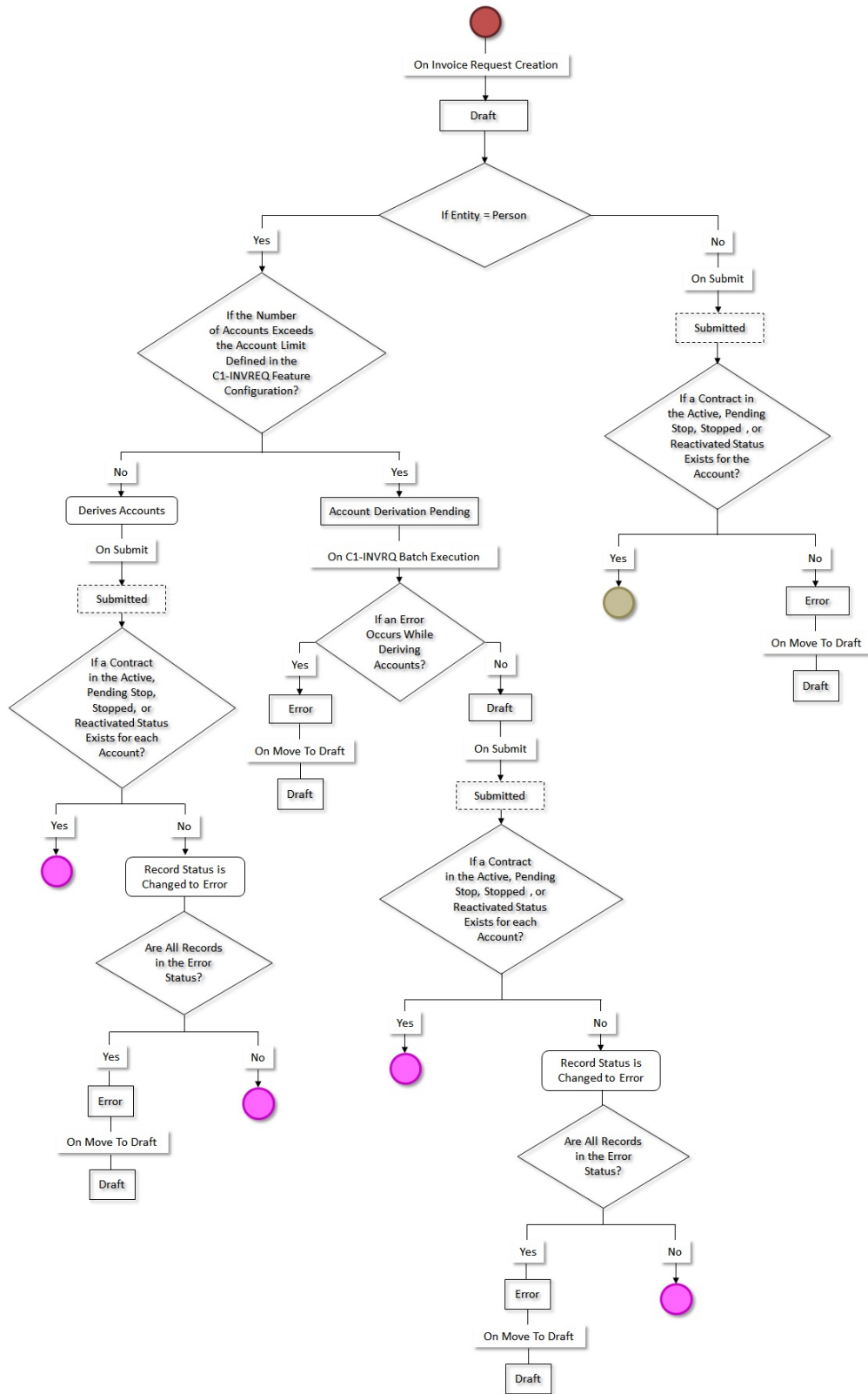

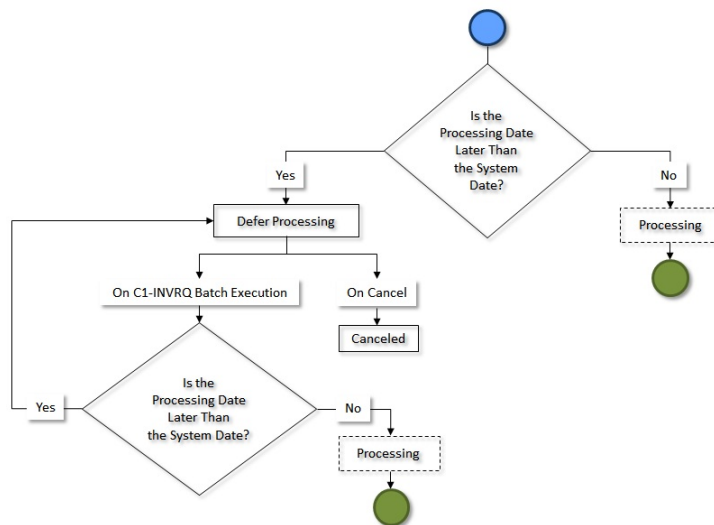
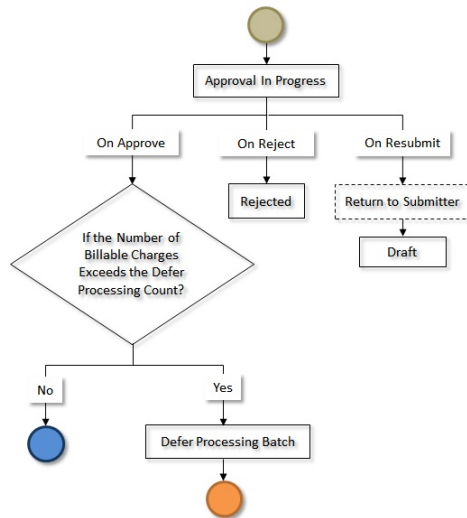
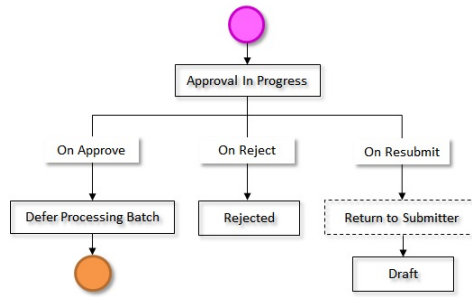

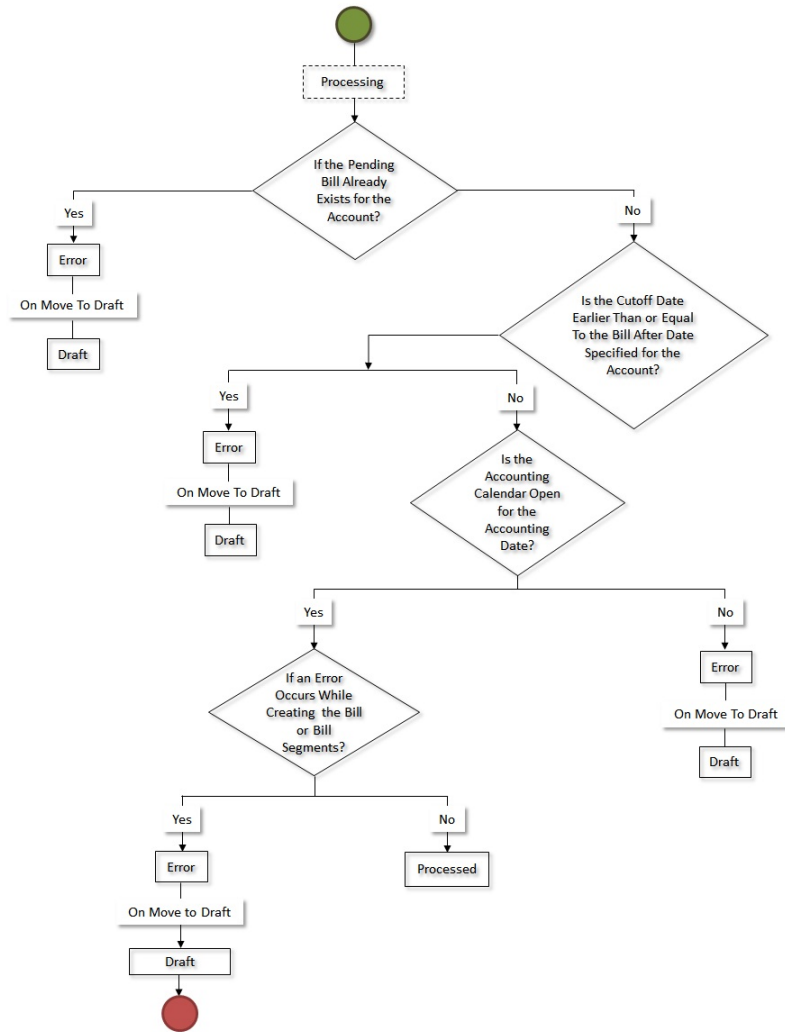

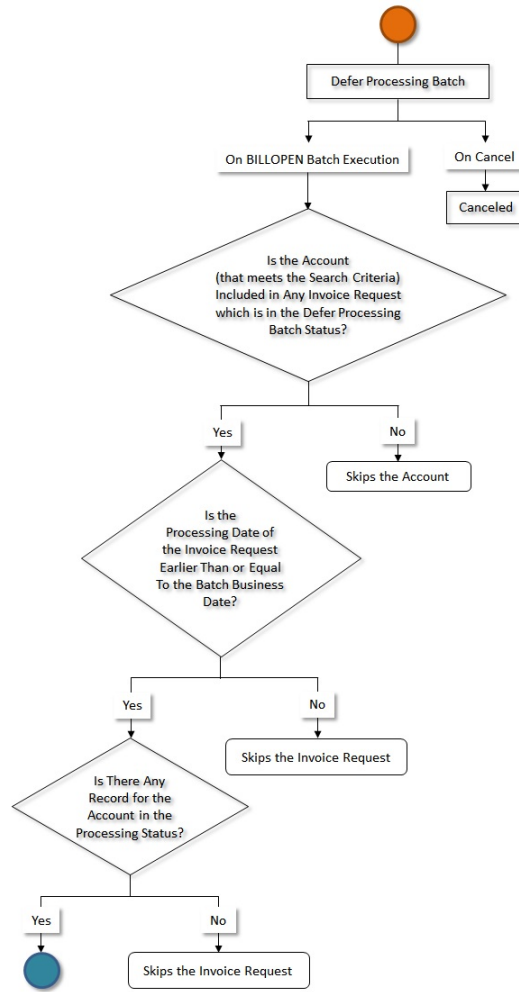

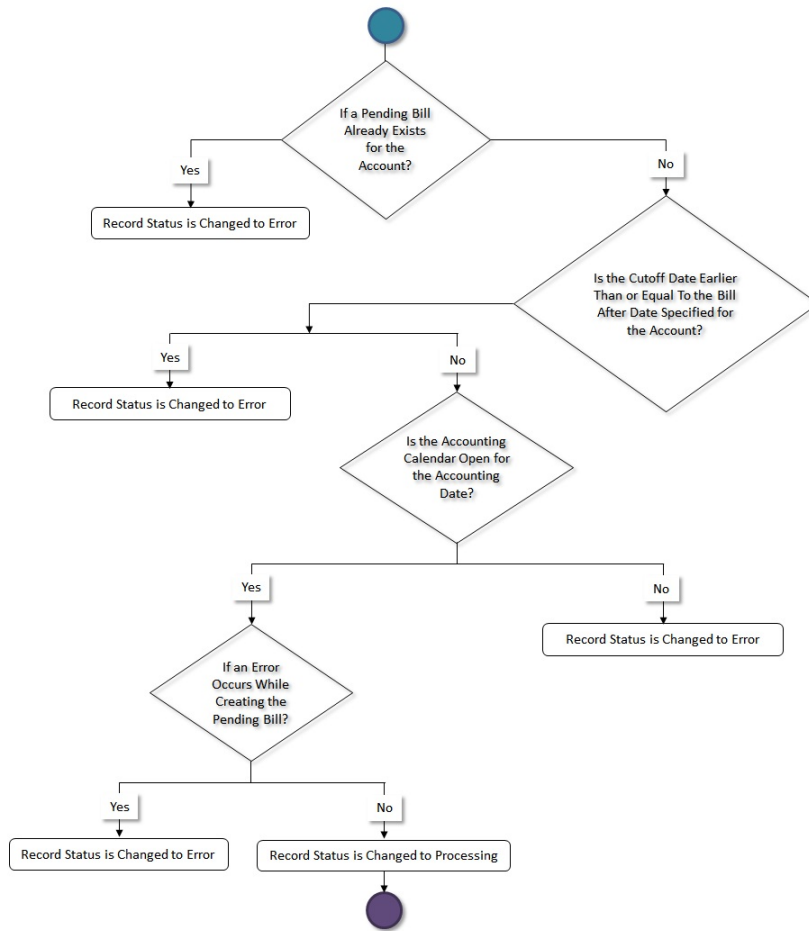

Invoice Request Automatic Regular Bill Generation (Without Approval) Status Transition

The following figure graphically indicates how an invoice request created through the automatic regular bill generation process moves from one status to another when the approval process is not configured in the invoice request type:

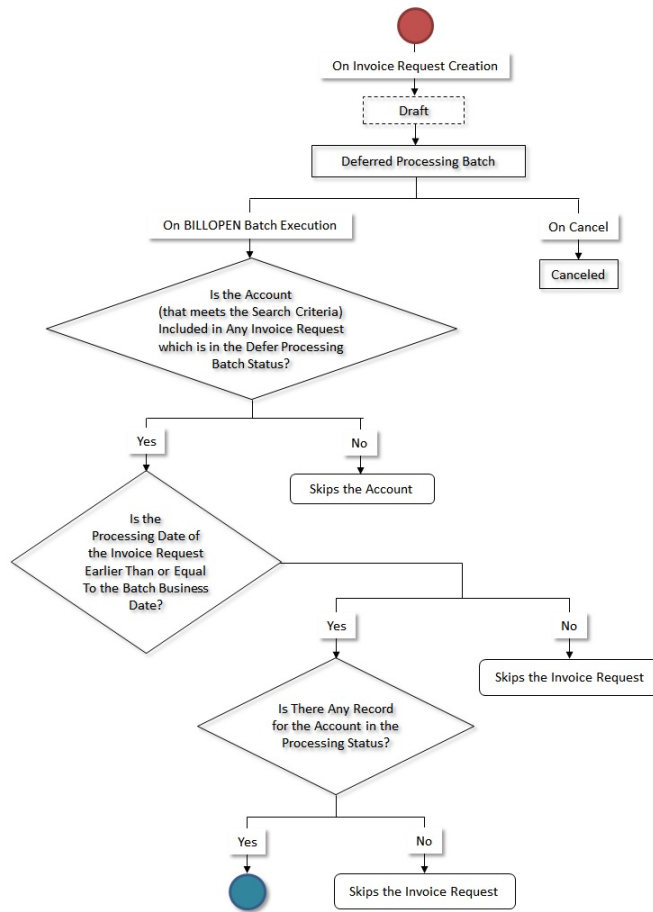

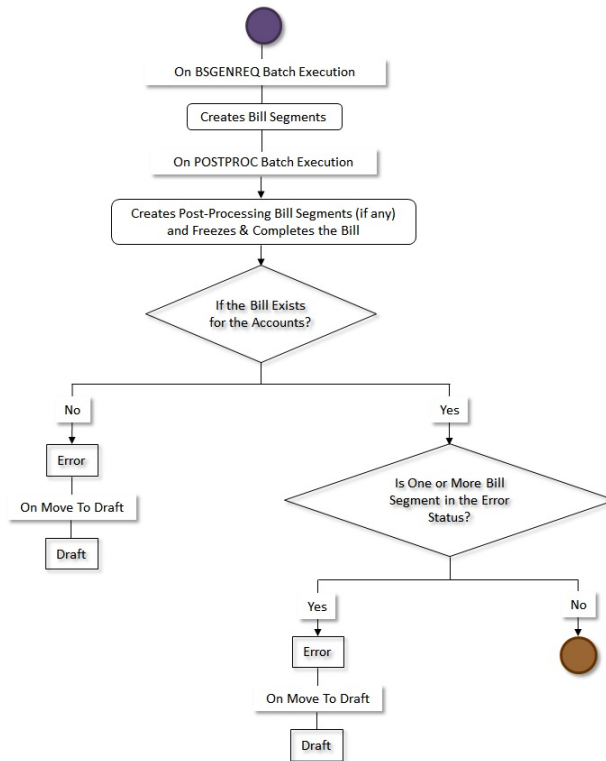
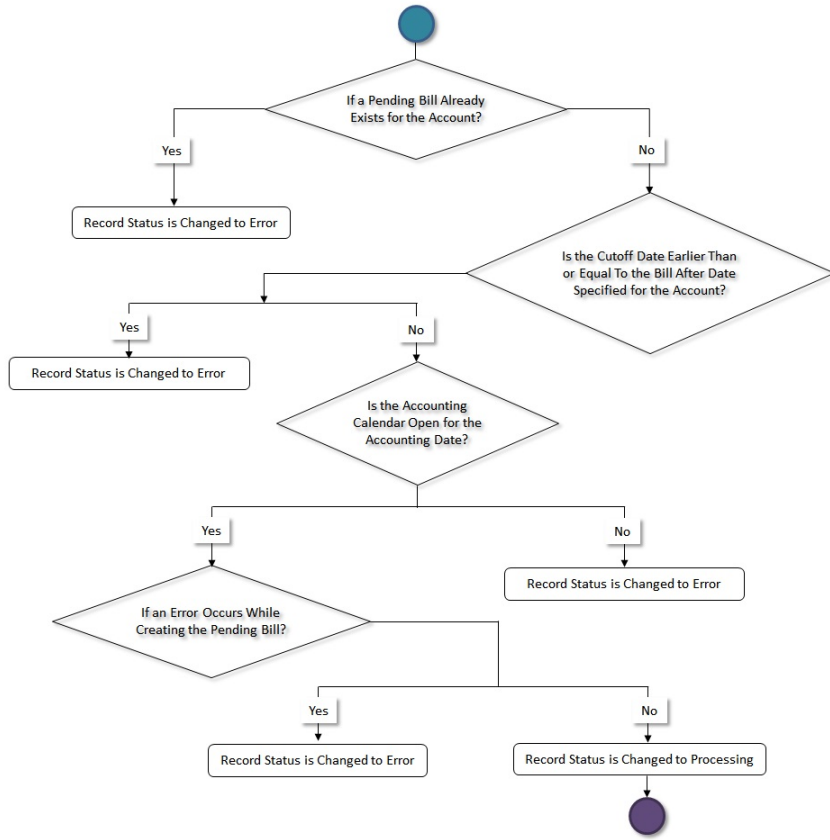

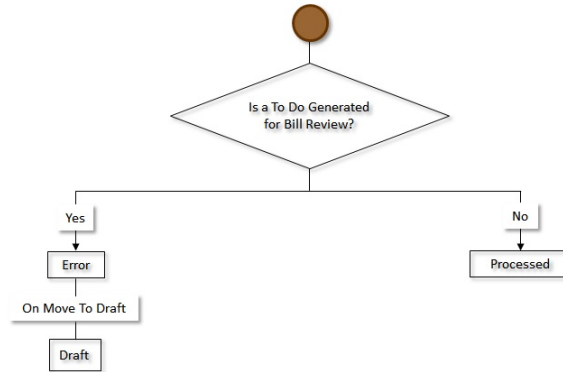

Invoice Request Type

Oracle Revenue Management and Billing enables you to define an invoice request type using which you can create an invoice request. The invoice request type helps the system to determine:

- The business object using which the invoice request should be created in the system
- Whether a manual or automatic invoice request should be created in the system
- Whether a regular or trial bill generation invoice request should be created in the system
- Whether a manual regular bill generation invoice request for an account should be processed in the online or deferred mode
- Whether the approval is required for the invoice request
- The wait days which is used to calculate the processing date for an invoice request
- The date calculation algorithm which is used to calculate the processing date for an automatic regular bill generation invoice request

The **Invoice Request Type** screen allows you to define, edit, copy, and delete an invoice request type. It contains the following zones:

- [Invoice Request Type List](#) on page 2455
- [Invoice Request Type](#) on page 2456

Invoice Request Type List

The **Invoice Request Type List** zone lists the invoice request types that are already defined in the system. It contains the following columns:

Column Name	Column Description
Invoice Request Type	Displays the invoice request type.
Description	Displays the description of the invoice request type.
Edit	On clicking the Edit (✎) icon, the Invoice Request Type screen appears where you can edit the details of the invoice request type.
Duplicate	On clicking the Duplicate (📄) icon, the Invoice Request Type screen appears where you can define a new invoice request type using an existing invoice request type.

Column Name	Column Description
Delete	On clicking the Delete (🗑️) icon, you can delete the invoice request type.
	Note: You can delete an invoice request type when an invoice request is not created using the invoice request type.

On clicking the **Broadcast** (📡) icon corresponding to an invoice request type, the **Invoice Request Type** zone appears with the details of the respective invoice request type.

Related Topics

For more information on...	See...
How to edit an invoice request type	Editing an Invoice Request Type on page 2464
How to copy an invoice request type	Copying an Invoice Request Type on page 2469
How to delete an invoice request type	Deleting an Invoice Request Type on page 2468
How to view the details of an invoice request type	Viewing the Invoice Request Type Details on page 2473

Invoice Request Type

The **Invoice Request Type** zone displays the details of the invoice request type. It contains the following sections:

- **Main** - Displays basic information about the invoice request type. It contains the following fields:

Field Name	Field Description
Invoice Request Type	Displays the invoice request type.
Description	Displays the description of the invoice request type.
Invoice Request Business Object	Indicates the business object using which an invoice request should be created. In addition, a context menu appears corresponding to this field which helps in navigating to other screens in the application. Note: It has a link. On clicking the link, the Business Object screen appears where you can view the details of the respective business object.
Detailed Description	Displays additional information about the invoice request type.
Status	Indicates the status of the invoice request type. The valid values are: <ul style="list-style-type: none"> • Active • Inactive
Invoice Mode	Indicates the mode of the invoice request type. The valid values are: <ul style="list-style-type: none"> • Automatic • Manual
Bill Generation Type	Indicates the bill generation type, using which an invoice request should be created. The valid values are:

Field Name	Field Description
	<ul style="list-style-type: none"> • Regular • Trial <p>Note: If Automatic option is selected from the Invoice Mode list, this field is disabled, and by default, is set to Regular.</p>
Defer Processing Billable Charge Count	<p>Displays the count which helps to determine whether an invoice request must be processed in the deferred mode (i.e. in the background) or in real time (i.e. immediately). If the number of billable charges created for the bills which are selected in the invoice request exceeds the defer processing billable charge count, the system processes the invoice request in the deferred mode. However, if the number of billable charges created for the bills which are selected in the invoice request does not exceed the defer processing billable charge count, the system processes the invoice request in real time (i.e. immediately).</p> <p>Note: You cannot specify a negative value in this field.</p> <p>Deferred mode means in the background when the Generic Request Periodic Monitor (C1-GENRQ) batch is invoked. You can configure the Generic Request Periodic Monitor (C1-GENRQ) batch such that it is executed at regular intervals. For more information about the Generic Request Periodic Monitor (C1-GENRQ) batch, refer to <i>Oracle Revenue Management and Billing Batch Guide</i>.</p> <p>This field appears when the Manual option is selected from the Invoice Mode list, and Regular option is selected from the Bill Generation Type list.</p> <p>If you set the defer processing billable charge count to zero (0), the system resets the default value to 500.</p>
Date Calculation Algorithm	<p>Indicates the algorithm using which the date should be calculated while adding a bill in an invoice request.</p> <p>Note: It has a link. On clicking the link, the Algorithm screen appears where you can view the details of the respective algorithm.</p> <p>This field appears when the Automatic option is selected from the Invoice Mode list.</p>
Invoice Request Approval Required	<p>Indicates whether approval is required while invoicing bills through an invoice request.</p> <p>Note: This field appears when the Automatic option is selected from the Invoice Mode list.</p>
Approval To Do Type	<p>Indicates that the To Do entry of the specified To Do type must be created when an invoice request is submitted for approval.</p>

Field Name	Field Description
	<p>Note:</p> <p>It has a link. On clicking the link, the To Do Type screen appears where you can view the details of the respective To Do Type.</p> <p>This field appears when the Approval Required option is selected.</p>
Approval To Do Role	<p>Indicates that users with the specified To Do role can only approve an invoice request which is submitted for approval.</p> <p>Note:</p> <p>It has a link. On clicking the link, the To Do Role screen appears where you can view the details of the respective To Do Role.</p> <p>This field appears when the Approval Required option is selected.</p>
Submitter To Do Type	<p>Indicates the submitter To Do type. At present, the submitter To Do type is not used to create To Do entry when the approver rejects an invoice request. It is only used to fetch the roles associated with the submitter To Do type while defining or editing the invoice request type.</p> <p>Note: It has a link. On clicking the link, the To Do Type screen appears where you can view the details of the respective To Do type.</p>
Submitter To Do Role	<p>Indicates that users with the specified To Do role cannot approve an invoice request which is submitted for approval.</p> <p>Note: It has a link. On clicking the link, the To Do Role screen appears where you can view the details of the respective To Do role.</p>
Freeze and Complete	<p>Indicates whether the invoice request raised through an automatic or manual invoice mode should be freeze and complete.</p> <p>Note:</p> <p>This field is not mandatory if the Invoice Mode - Manual option is selected.</p> <p>By default, this field is selected and disabled when the Invoice Mode - Automatic option is selected.</p> <p>The field should not be checked when the Bill Generation Type - Trial option is selected.</p> <p>Once it is defined and saved, it cannot be changed as it is linked to request(s) which are under processing.</p> <p>For the Batch mode, this field value will be passed to the batch parameter Freeze and Complete.</p>
Wait Days	<p>Displays the maximum wait period (in days) after which the bills in an invoice request are processed.</p> <p>Note: You cannot specify a negative value in the Wait Days field.</p>

- **Characteristics** - Lists the characteristics defined for the invoice request type. It contains the following columns:

Field Name	Field Description
Characteristic Type	Indicates the characteristic type.
Characteristic Value	Displays the value of the characteristic type.

- **Record Actions** - This section contains the following buttons:

Button Name	Button Description
Edit	Used to edit the details of the invoice request type.
Delete	Used to delete the invoice request type.
	Note: You can delete an invoice request type when an invoice request is not created using the invoice request type.
Duplicate	Used to create a new invoice request type using an existing invoice request type.

- **Record Information** - This section contains the following field:

Field Name	Field Description
Business Object	Indicates the business object using which the invoice request type is created. In addition, a context menu appears corresponding to this field which helps in navigating to other screens in the application.
	Note: It has a link. On clicking the link, the Business Object screen appears where you can view the details of the respective business object.

By default, the **Invoice Request Type** zone does not appear in the **Invoice Request Type** screen. It appears when you click the **Broadcast** () icon corresponding to an invoice request type in the **Invoice Request Type List** zone.

Related Topics

For more information on...	See...
How to edit an invoice request type	Editing an Invoice Request Type on page 2464
How to copy an invoice request type	Copying an Invoice Request Type on page 2469
How to delete an invoice request type	Deleting an Invoice Request Type on page 2468
How to view the details of an invoice request type	Viewing the Invoice Request Type Details on page 2473

Defining an Invoice Request Type

Prerequisites

To define an invoice request type, you should have:

- Invoice request type business objects defined in the application.
- Invoice request business objects defined in the application.
- Date calculation algorithm defined using the **C1-INVREDTCA** algorithm type.
- Required To Do role assigned to the **C1-INVRA** and **C1-INVRS** To Do types in the application

Procedure

To define an invoice request type:

1. Click the **Admin** link in the **Application** toolbar.
A list appears.
2. From the **Admin** menu, select **I** and then click **Invoice Request Type**.
A sub-menu appears.
3. Click the **Add** option from the **Invoice Request Type** sub-menu.

The **Invoice Request Type** screen appears. It contains the following sections:

- **Main** - Used to specify basic details about the invoice request type.
- **Characteristics** - Used to define the characteristics for the invoice request type.

The **Main** section contains the following fields:

Field Name	Field Description	Mandatory (Yes or No)
Invoice Request Type	Used to specify the invoice request type.	Yes
Business Object	Indicates the business object using which you are defining the invoice request type.	Not applicable
Description	Used to specify the description for the invoice request type.	Yes
Invoice Request Business Object	Used to indicate the business object using which you want to create an invoice request. The valid values are: <ul style="list-style-type: none"> • Invoice Request - Regular Bill Generation • Invoice Request - Trial Bill Generation 	Yes
Detailed Description	Used to specify additional information about the invoice request type.	No
Status	Used to indicate the status of the invoice request type. The valid values are: <ul style="list-style-type: none"> • Active • Inactive 	Yes
Invoice Mode	Used to indicate the mode of the invoice request type. The valid values are: <ul style="list-style-type: none"> • Manual • Automatic 	Yes
Bill Generation Type	Used to indicate the bill generation type, using which an invoice request should be created. The valid values are: <ul style="list-style-type: none"> • Regular • Trial <p>Note: If Automatic option is selected from the Invoice Mode list, this field is disabled, and by default, is set to Regular.</p>	Yes
Defer Processing Billable Charge Count	Used to specify the count which helps to determine whether an invoice request must be processed in the deferred mode (i.e. in the background) or in real time	No

Field Name	Field Description	Mandatory (Yes or No)
	<p>(i.e. immediately). If the number of billable charges created for the bills which are selected in the invoice request exceeds the defer processing billable charge count, the system processes the invoice request in the deferred mode. However, if the number of billable charges created for the bills which are selected in the invoice request does not exceed the defer processing billable charge count, the system processes the invoice request in real time (i.e. immediately).</p> <p>Note: You cannot specify a negative value in this field.</p> <p>Deferred mode means in the background when the Generic Request Periodic Monitor (C1-GENRQ) batch is invoked. You can configure the Generic Request Periodic Monitor (C1-GENRQ) batch such that it is executed at regular intervals. For more information about the Generic Request Periodic Monitor (C1-GENRQ) batch, refer to <i>Oracle Revenue Management and Billing Batch Guide</i>.</p> <p>This field appears when the Manual option is selected from the Invoice Mode list, and Regular option is selected from the Bill Generation Type list.</p> <p>If you set the defer processing billable charge count to zero (0), the system resets the default value to 500.</p>	
Date Calculation Algorithm	<p>Used to indicate the algorithm using which the date should be calculated while adding a bill in an invoice request.</p> <p>Note: The Search  icon appears corresponding to the Date Calculation Algorithm field. On clicking the Search icon, the Algorithm Search window appears.</p> <p>On specifying the date calculation algorithm, the description of the date calculation algorithm appears corresponding to the Date Calculation Algorithm field.</p> <p>You can specify the date calculation algorithm when the Invoice Mode is selected as Automatic.</p>	<p>Yes (Conditional)</p> <p>Note: This field is required when Invoice mode is Automatic.</p>
Invoice Request Approval Required	<p>Used to indicate whether approval is required while invoicing bills through an invoice request.</p> <p>Note: This field appears when the Automatic option is selected from the Invoice Mode list.</p>	No
Approval To Do Type	Used to indicate that the To Do entry of the specified To Do type must be created when an invoice request is submitted for approval.	Yes (Conditional)

Field Name	Field Description	Mandatory (Yes or No)
	<p>Note:</p> <p>The Search (🔍) icon appears corresponding to the Approval To Do Type field. On clicking the Search icon, the To Do Type Search window appears.</p> <p>On specifying the To Do type, the description of the To Do type appears corresponding to the Approval To Do Type field.</p> <p>This field appears when the Approval Required option is selected.</p> <p>The C1-INVRA To Do type is shipped with the product. You can use the C1-INVRA To Do type or a custom To Do type, if required.</p>	<p>Note: This field is required when the Approval Required option is selected.</p>
Approval To Do Role	<p>Used to indicate that users with the specified To Do role can only approve an invoice request which is submitted for approval.</p> <p>Note:</p> <p>The list includes only those To Do roles which are associated with the approval To Do type.</p> <p>This field appears when the Approval Required option is selected.</p>	<p>Yes (Conditional)</p> <p>Note: This field is required when the Approval Required option is selected.</p>
Submitter To Do Type	<p>Used to indicate the submitter To Do type. At present, the submitter To Do type is not used to create To Do entry when the approver rejects an offset request. It is only used to fetch the roles associated with the submitter To Do type.</p> <p>Note:</p> <p>The Search (🔍) icon appears corresponding to the Submitter To Do Type field. On clicking the Search icon, the To Do Type Search window appears.</p> <p>On specifying the To Do type, the description of the To Do type appears corresponding to the Submitter To Do Type field.</p> <p>The C1-INVRS To Do type is shipped with the product. You can use the C1-INVRS To Do type or a custom To Do type, if required.</p>	<p>Yes (Conditional)</p> <p>Note:</p> <p>This field is required when the Approval Required option is selected.</p>
Submitter To Do Role	<p>Used to indicate that users with the specified To Do role cannot approve an invoice request which is submitted for approval.</p>	<p>Yes (Conditional)</p>

Field Name	Field Description	Mandatory (Yes or No)
	<p>Note: The list includes only those To Do roles which are associated with the submitter To Do type.</p>	<p>Note: This field is required when the Approval Required option is selected.</p> <p>Once it is defined and saved, it cannot be changed as it is linked to request(s) which are under processing.</p>
Wait Days	<p>Used to indicate the threshold days before which no other invoice request for any bill generation process will be initiated.</p> <p>Note: By default, the value displayed for wait days is 0.</p>	No

4. Enter the required details in the **Main** section.
5. Define characteristics for the invoice request type, if required.
6. Click **Save**.

The invoice request type is defined.

Related Topics

For more information on...	See...
Invoice Request Type screen	Invoice Request Type on page 2455
How to define a characteristic for an invoice request type	Defining a Characteristic for an Invoice Request on page 2488

Defining a Characteristic for an Invoice Request Type

Prerequisites

To define a characteristic for an invoice request type, you should have:

- Characteristic types defined in the application (where the characteristic entity is set to **Invoice Request Type**)

Procedure

To define a characteristic for an invoice request type:

1. Ensure that the **Characteristics** section is expanded when you are defining, editing, or copying an invoice request type.

The **Characteristics** section contains the following fields in a grid:

Field Name	Field Description	Mandatory (Yes or No)
Characteristic Type	Used to indicate the characteristic type.	Yes (Conditional)

Field Name	Field Description	Mandatory (Yes or No)
	Note: The list includes only those characteristic types where the characteristic entity is set to Invoice Request Type .	Note: This field is required when you are defining a characteristic for the invoice request type.
Characteristic Value	Used to specify the value for the characteristic type. Note: If you select a predefined characteristic type, the Search (🔍) icon appears corresponding to the Characteristic Value field. On clicking the Search icon, the Predefined Characteristic Search window appears. On specifying the value for a predefined characteristic type, the description of the characteristic value appears corresponding to the Characteristic Value field.	Yes (Conditional) Note: This field is required when you are defining a characteristic for the invoice request type.

- Enter the required details in the **Characteristics** section.
- If you want to define more than one characteristic for the invoice request type, click the **Add (+)** icon and then repeat step 2.

Note: However, if you want to remove a characteristic from the invoice request type, click the **Delete** (🗑️) icon corresponding to the characteristic.

Related Topics

For more information on...	See...
How to define a invoice request type	Defining an Invoice Request Type on page 2459
How to edit a invoice request type	Editing an Invoice Request Type on page 2464
How to copy a invoice request type	Copying an Invoice Request Type on page 2469

Editing an Invoice Request Type

Prerequisites

To edit an invoice request type, you should have:

- Invoice request type business objects defined in the application.
- Invoice request business objects defined in the application.
- Date calculation algorithm defined using the **C1-INVREDTCA** algorithm type.
- Required To Do role assigned to the **C1-INVRA** and **C1-INVRS** To Do types in the application

Procedure

To edit an invoice request type:

- Click the **Admin** link in the **Application** toolbar.
A list appears.
- From the **Admin** menu, select **I** and then click **Invoice Request Type**.

A sub-menu appears.

- Click the **Search** option from the **Invoice Request Type** sub-menu.

The **Invoice Request Type** screen appears.

- In the **Invoice Request Type List** zone, click the **Edit**  icon in the **Edit** column corresponding to the invoice request type whose details you want to edit.

The **Invoice Request Type** screen appears. It contains the following section:

- Main** - Used to specify basic details about the invoice request type.
- Characteristics** - Used to define the characteristics for the offset request type.

The **Main** section contains the following fields:

Field Name	Field Description	Mandatory (Yes or No)
Invoice Request Type	Displays the invoice request type.	Not applicable
Business Object	Indicates the business object using which you are defining the invoice request type.	Not applicable
Description	Used to specify the description for the invoice request type.	Yes
Invoice Request Business Object	Used to indicate the business object using which you want to create an invoice request. The valid values are: <ul style="list-style-type: none"> Invoice Request - Regular Bill Generation Invoice Request - Trial Bill Generation 	Yes
Detailed Description	Used to specify additional information about the invoice request type.	No
Status	Used to indicate the status of the invoice request type. The valid values are: <ul style="list-style-type: none"> Active Inactive 	Yes
Invoice Mode	Used to indicate the mode of the invoice request type. The valid values are: <ul style="list-style-type: none"> Manual Automatic 	Yes
Bill Generation Type	Used to indicate the bill generation type, using which an invoice request should be created. The valid values are: <ul style="list-style-type: none"> Regular Trial <p>Note: If Automatic option is selected from the Invoice Mode list, this field is disabled, and by default, is set to Regular.</p>	Yes
Defer Processing Billable Charge Count	Used to specify the count which helps to determine whether an invoice request must be processed in the deferred mode (i.e. in the background) or in real time (i.e.	No

Field Name	Field Description	Mandatory (Yes or No)
	<p>immediately). If the number of billable charges created for the bills which are selected in the invoice request exceeds the defer processing billable charge count, the system processes the invoice request in the deferred mode. However, if the number of billable charges created for the bills which are selected in the invoice request does not exceed the defer processing billable charge count, the system processes the invoice request in real time (i.e. immediately).</p> <p>Note: You cannot specify a negative value in this field.</p> <p>Deferred mode means in the background when the Generic Request Periodic Monitor (C1-GENRQ) batch is invoked. You can configure the Generic Request Periodic Monitor (C1-GENRQ) batch such that it is executed at regular intervals. For more information about the Generic Request Periodic Monitor (C1-GENRQ) batch, refer to <i>Oracle Revenue Management and Billing Batch Guide</i>.</p> <p>This field appears when the Manual option is selected from the Invoice Mode list, and Regular option is selected from the Bill Generation Type list.</p> <p>If you set the defer processing billable charge count to zero (0), the system resets the default value to 500.</p>	
Date Calculation Algorithm	<p>Used to indicate the algorithm using which the date should be calculated while adding a bill in an invoice request.</p> <p>Note: The Search  icon appears corresponding to the Date Calculation Algorithm field. On clicking the Search icon, the Algorithm Search window appears.</p> <p>On specifying the date calculation algorithm, the description of the date calculation algorithm appears corresponding to the Date Calculation Algorithm field.</p> <p>You can specify the date calculation algorithm when the Invoice Mode is selected as Automatic.</p>	<p>Yes (Conditional)</p> <p>Note: This field is required when Invoice mode is Automatic.</p>
Invoice Request Approval Required	<p>Used to indicate whether approval is required while invoicing bills through an invoice request.</p> <p>Note: This field appears when the Automatic option is selected from the Invoice Mode list.</p>	No
Approval To Do Type	Used to indicate that the To Do entry of the specified To Do type must be created when an invoice request is submitted for approval.	Yes (Conditional)

Field Name	Field Description	Mandatory (Yes or No)
	<p>Note:</p> <p>The Search (🔍) icon appears corresponding to the Approval To Do Type field. On clicking the Search icon, the To Do Type Search window appears.</p> <p>On specifying the To Do type, the description of the To Do type appears corresponding to the Approval To Do Type field.</p> <p>This field appears when the Approval Required option is selected.</p> <p>The C1-INVRA To Do type is shipped with the product. You can use the C1-INVRA To Do type or a custom To Do type, if required.</p>	<p>Note: This field is required when the Approval Required option is selected.</p>
Approval To Do Role	<p>Used to indicate that users with the specified To Do role can only approve an invoice request which is submitted for approval.</p> <p>Note:</p> <p>The list includes only those To Do roles which are associated with the approval To Do type.</p> <p>This field appears when the Approval Required option is selected.</p>	<p>Yes (Conditional)</p> <p>Note: This field is required when the Approval Required option is selected.</p>
Submitter To Do Type	<p>At present, the submitter To Do type is not used to create To Do entry when the approver rejects an offset request. It is only used to fetch the roles associated with the submitter To Do type.</p> <p>Note:</p> <p>The Search (🔍) icon appears corresponding to the Submitter To Do Type field. On clicking the Search icon, the To Do Type Search window appears.</p> <p>On specifying the To Do type, the description of the To Do type appears corresponding to the Submitter To Do Type field.</p> <p>The C1-INVRS To Do type is shipped with the product. You can use the C1-INVRS To Do type or a custom To Do type, if required.</p>	<p>Yes (Conditional)</p> <p>Note:</p> <p>This field is required when the Approval Required option is selected.</p>
Submitter To Do Role	<p>Used to indicate that users with the specified To Do role cannot approve an invoice request which is submitted for approval.</p> <p>Note: The list includes only those To Do roles which are associated with the submitter To Do type.</p>	<p>Yes (Conditional)</p>

Field Name	Field Description	Mandatory (Yes or No)
		Note: This field is required when the Approval Required option is selected. Once it is defined and saved, it cannot be changed as it is linked to request(s) which are under processing.
Wait Days	Used to specify the maximum wait period (in days) after which the bills in an invoice request are processed.	No
	Note: You cannot specify a negative value in the Wait Days field.	

Tip: Alternatively, you can access this screen by clicking the **Edit** button in the **Invoice Request Type** zone.

5. Modify the required details in the **Main** section.
6. Define, edit, or remove characteristics of the invoice request type, if required.
7. Click **Save**.

The changes made to the invoice request type are saved.

Related Topics

For more information on...	See...
Invoice Request Type screen	Invoice Request Type on page 2455
Invoice Request Type List zone	Invoice Request Type List on page 2455
Invoice Request Type zone	Invoice Request Type on page 2456
How to define a characteristic for an invoice request type	Defining a Characteristic for an Invoice Request Type on page 2463

Deleting an Invoice Request Type

Procedure

To delete an invoice request type:

1. Click the **Admin** link in the **Application** toolbar.
A list appears.
2. From the **Admin** menu, select **I** and then click **Invoice Request Type**.
A sub-menu appears.
3. Click the **Search** option from the **Invoice Request Type** sub-menu.
The **Invoice Request Type** screen appears.

- In the **Invoice Request Type List** zone, click the **Delete** () icon in the **Delete** column corresponding to the invoice request type that you want to delete.

A message appears confirming whether you want to delete the invoice request type.

Note: You can delete an invoice request type when an invoice request is not created using the invoice request type.

Tip: Alternatively, you can delete an invoice request type by clicking the **Delete** button in the **Invoice Request Type** zone.

- Click **OK**.

The invoice request type is deleted.

Related Topics

For more information on...	See...
Invoice Request Type screen	Invoice Request Type on page 2455
Invoice Request Type List zone	Invoice Request Type List on page 2455
Invoice Request Type zone	Invoice Request Type on page 2456

Copying an Invoice Request Type

Instead of creating an invoice request type from scratch, you can create a new invoice request type using an existing invoice request type. This is possible through copying an invoice request type. On copying an invoice request type, the details including the characteristics are copied to the new invoice request type. You can then edit the details, if required.

Prerequisites

To copy an invoice request type, you should have:

- Invoice request type (whose copy you want to create) defined in the application.
- Invoice request business objects defined in the application.
- Date calculation algorithm defined using the **C1-INVREDTCA** algorithm type.
- Required To Do role assigned to the **C1-INVRA** and **C1-INVRS** To Do types in the application

Procedure

To copy an invoice request type:

- Click the **Admin** link in the **Application** toolbar.
A list appears.
- From the **Admin** menu, select **I** and then click **Invoice Request Type**.
A sub-menu appears.
- Click the **Search** option from the **Invoice Request Type** sub-menu.
The **Invoice Request Type** screen appears.
- In the **Request Type List** zone, click the **Duplicate** () icon in the **Duplicate** column corresponding to the invoice request type whose copy you want to create.

The **Invoice Request Type** screen appears. It contains the following sections:

- **Main** - Used to specify basic details about the invoice request type. It contains the following fields:
- **Characteristics** - Used to define the characteristics for the invoice request type.

Field Name	Field Description	Mandatory (Yes or No)
Invoice Request Type	Used to specify the invoice request type.	Yes
Business Object	Indicates the business object using which you are defining the invoice request type.	Not applicable
Description	Used to specify the description for the invoice request type.	Yes
Invoice Request Business Object	Used to indicate the business object using which you want to create an invoice request. The valid values are: <ul style="list-style-type: none"> • Invoice Request - Regular Bill Generation • Invoice Request - Trial Bill Generation 	Yes
Detailed Description	Used to specify additional information about the invoice request type.	No
Status	Used to indicate the status of the invoice request type. The valid values are: <ul style="list-style-type: none"> • Active • Inactive 	Yes
Invoice Mode	Used to indicate the mode of the invoice request type. The valid values are: <ul style="list-style-type: none"> • Manual • Automatic 	Yes
Bill Generation Type	Used to indicate the bill generation type, using which an invoice request should be created. The valid values are: <ul style="list-style-type: none"> • Regular • Trial <p>Note: If Automatic option is selected from the Invoice Mode list, this field is disabled, and by default, is set to Regular.</p>	Yes
Defer Processing Billable Charge Count	Used to specify the count which helps to determine whether an invoice request must be processed in the deferred mode (i.e. in the background) or in real time (i.e. immediately). If the number of billable charges created for the bills which are selected in the invoice request exceeds the defer processing billable charge count, the system processes the invoice request in the deferred mode. However, if the number of billable charges created for the bills which are selected in the invoice request does not exceed the defer processing billable charge count, the system processes the invoice request in real time (i.e. immediately).	No

Field Name	Field Description	Mandatory (Yes or No)
	<p>Note:</p> <p>You cannot specify a negative value in this field.</p> <p>Deferred mode means in the background when the Generic Request Periodic Monitor (C1-GENRQ) batch is invoked. You can configure the Generic Request Periodic Monitor (C1-GENRQ) batch such that it is executed at regular intervals. For more information about the Generic Request Periodic Monitor (C1-GENRQ) batch, refer to <i>Oracle Revenue Management and Billing Batch Guide</i>.</p> <p>This field appears when the Manual option is selected from the Invoice Mode list, and Regular option is selected from the Bill Generation Type list.</p> <p>If you set the defer processing billable charge count to zero (0), the system resets the default value to 500.</p>	
Date Calculation Algorithm	<p>Used to indicate the algorithm using which the date should be calculated while adding a bill in an invoice request.</p> <p>Note:</p> <p>The Search  icon appears corresponding to the Date Calculation Algorithm field. On clicking the Search icon, the Algorithm Search window appears.</p> <p>On specifying the date calculation algorithm, the description of the date calculation algorithm appears corresponding to the Date Calculation Algorithm field.</p> <p>You can specify the date calculation algorithm when the Invoice Mode is selected as Automatic.</p>	<p>Yes (Conditional)</p> <p>Note:</p> <p>This field is required when Invoice mode is Automatic.</p>
Invoice Request Approval Required	<p>Used to indicate whether approval is required while invoicing bills through an invoice request.</p> <p>Note: This field appears when the Automatic option is selected from the Invoice Mode list.</p>	No
Approval To Do Type	<p>Used to indicate that the To Do entry of the specified To Do type must be created when an invoice request is submitted for approval.</p>	<p>Yes (Conditional)</p> <p>Note: This field is required when the Approval Required option is selected.</p>

Field Name	Field Description	Mandatory (Yes or No)
	<p>Note:</p> <p>The Search (🔍) icon appears corresponding to the Approval To Do Type field. On clicking the Search icon, the To Do Type Search window appears.</p> <p>On specifying the To Do type, the description of the To Do type appears corresponding to the Approval To Do Type field.</p> <p>This field appears when the Approval Required option is selected.</p> <p>The C1-INVRA To Do type is shipped with the product. You can use the C1-INVRA To Do type or a custom To Do type, if required.</p>	
Approval To Do Role	<p>Used to indicate that users with the specified To Do role can only approve an invoice request which is submitted for approval.</p> <p>Note:</p> <p>The list includes only those To Do roles which are associated with the approval To Do type.</p> <p>This field appears when the Approval Required option is selected.</p>	<p>Yes (Conditional)</p> <p>Note: This field is required when the Approval Required option is selected.</p>
Submitter To Do Type	<p>Used to indicate the submitter To Do type. At present, the submitter To Do type is not used to create To Do entry when the approver rejects an offset request. It is only used to fetch the roles associated with the submitter To Do type.</p> <p>Note:</p> <p>The Search (🔍) icon appears corresponding to the Submitter To Do Type field. On clicking the Search icon, the To Do Type Search window appears.</p> <p>On specifying the To Do type, the description of the To Do type appears corresponding to the Submitter To Do Type field.</p> <p>The C1-INVRS To Do type is shipped with the product. You can use the C1-INVRS To Do type or a custom To Do type, if required.</p>	<p>Yes (Conditional)</p> <p>Note: This field is required when the Approval Required option is selected.</p>
Submitter To Do Role	<p>Used to indicate that users with the specified To Do role cannot approve an invoice request which is submitted for approval.</p> <p>Note: The list includes only those To Do roles which are associated with the submitter To Do type.</p>	<p>Yes (Conditional)</p>

Field Name	Field Description	Mandatory (Yes or No)
		<p>Note:</p> <p>This field is required when the Approval Required option is selected.</p> <p>Once it is defined and saved, it cannot be changed as it is linked to request(s) which are under processing.</p>
Wait Days	Used to indicate the threshold days before which no other invoice request for any bill generation process will be initiated.	No
	<p>Note: By default, the value displayed for wait days is 0.</p>	

Tip: Alternatively, you can copy an invoice request type by clicking the **Duplicate** button in the **Invoice Request Type** zone.

- Enter the required details in the **Main** section.
- Define, edit, or remove characteristics of the invoice request type, if required.
- Click **Save**.

The new invoice request type is defined.

Related Topics

For more information on...	See...
Invoice Request Type screen	Invoice Request Type on page 2455
Invoice Request Type List zone	Invoice Request Type List on page 2455
Invoice Request Type zone	Invoice Request Type on page 2456
How to define a characteristic for an invoice request type	Defining a Characteristic for an Invoice Request Type on page 2463

Viewing the Invoice Request Type Details

Procedure

To view the details of an invoice request type:

- Click the **Admin** link in the **Application** toolbar.
A list appears.
- From the **Admin** menu, select **I** and then click **Invoice Request Type**.
A sub-menu appears.
- Click the **Search** option from the **Invoice Request Type** sub-menu.
The **Invoice Request Type** screen appears.

4. In the **Invoice Request Type List** zone, click the **Broadcast** () icon corresponding to the invoice request type whose details you want to view. The **Invoice Request Type** zone appears.
5. View the details of the invoice request type in the **Invoice Request Type** zone.

Related Topics

For more information on...	See...
Invoice Request Type screen	Invoice Request Type on page 2455
Invoice Request Type List zone	Invoice Request Type List on page 2455
Invoice Request Type zone	Invoice Request Type on page 2456

Invoice Request (Used for Searching)

The **Invoice Request** screen allows you to search for an invoice request using various search criteria. It also allows you to define an invoice request. It contains the following zone:

- [Search Invoice Request](#) on page 2474

Through this screen, you can navigate to the following screen:



- [Invoice Request \(Used for Viewing\)](#) on page 2481

Search Invoice Request

The **Search Invoice Request** zone allows you to search for an invoice request using various search criteria. It contains the following two sections:

- **Search Criteria** - The **Search Criteria** section contains the following fields:

Field Name	Field Description	Mandatory (Yes or No)
Search By	Used to indicate whether you want to search for an invoice request using the invoice request or bill details. The valid values are: <ul style="list-style-type: none"> • Invoice Requests for Accounts • Invoice Requests for Persons 	Yes
	Note: By default, the Invoice Requests for Accounts option is selected.	
Invoice Request ID	Used to search a particular invoice request.	No
Created From	Used to search invoice requests which are created from a particular date onwards.	No
Created To	Used to search invoice requests which are created till a particular date.	No
Cutoff From	Used to indicate the date from when the billable charges are considered for processing the invoice request.	No
Cutoff To	Used to indicate the date till when the billable charges are considered for processing the invoice request.	No

Field Name	Field Description	Mandatory (Yes or No)
Invoice Request Type	Used to search invoice requests which are created using a particular invoice request type.	No
Status	Used to search invoice requests with a particular status. The valid values are: <ul style="list-style-type: none"> • Account Derivation Pending • Approved • Approval In Progress • Canceled • Deferred Processing • Deferred Processing Batch • Draft • Error • Processed • Rejected 	No
Person ID	Used to search invoice requests which include bills of a particular person. Note: The Search  icon appears corresponding to Person ID field. On clicking the Search icon, the Person Search window appears.	No
Account ID	Used to search invoice requests which include bills of a particular account. Note: The Search  icon appears corresponding to this field. On clicking the Search icon, the Account Search window appears.	No
Bill Generation Type	Used to indicate the bill generation type. The valid values are: <ul style="list-style-type: none"> • Regular • Trial Note: This field appears when the Invoice Requests for Accounts option is selected from the Search By list.	No
External Reference Type	Used to indicate the external reference type. The valid value is: <ul style="list-style-type: none"> • Policy 	No

Field Name	Field Description	Mandatory (Yes or No)
	<p>Note:</p> <p>This is a read-only field.</p> <p>This field is populated when the invoice request is created with the invoice mode option as Automatic.</p>	
External Reference ID	<p>Used to specify the external reference ID of the invoice request.</p> <p>Note:</p> <p>The Search  icon appears corresponding to the External Reference ID field. On clicking the Search icon, the Policy Search window appears.</p>	No

Note: You must specify at least one search criterion while searching for an invoice request.

- **Search Results** - On clicking the **Search** button, the search results appear based on the specified search criteria. The **Search Results** section contains the following columns:

Column Name	Column Description
Creation Date Time	Displays the date and time when the invoice request is created.
Invoice Request Information	<p>Displays information about the invoice request.</p> <p>Note: It has a link. On clicking the link, the Invoice Request screen appears where you can view the details of the respective invoice request.</p>
Created By	Indicates the user who has created the invoice request.
Cutoff Date	Displays the date till when all the billable charges are considered for processing the invoice request.
Account Information	<p>Displays information about the account. In addition, this column has a context menu which helps in navigating to other screens in the application.</p> <p>Note:</p> <p>It has a link. On clicking the link, the Account screen appears where you can view the details of the respective account.</p> <p>This column appears when the Invoice Requests for Accounts option is selected from the Search By list.</p>
Person Information	Displays additional information about the person. In addition, this column has a context menu which helps in navigating to other screens in the application.

Column Name	Column Description						
	<p>Note:</p> <p>It has a link. On clicking the link, the Person screen appears with the details of the respective person.</p> <p>This column appears when the Invoice Requests for Persons option is selected from the Search By list.</p>						
Status	<p>Indicates the status of the invoice request. The valid values are:</p> <ul style="list-style-type: none"> • Account Derivation Pending • Approved • Approval In Progress • Canceled • Deferred Processing • Deferred Processing - Batch • Draft • Error • Processed • Rejected 						
Bill Information	<p>Displays information about the bill.</p> <p>Note:</p> <table border="1" data-bbox="602 1104 1463 1507"> <thead> <tr> <th data-bbox="602 1104 1008 1155">If you select ...</th> <th data-bbox="1008 1104 1463 1155">Then...</th> </tr> </thead> <tbody> <tr> <td data-bbox="602 1155 1008 1365"> Invoice Requests for Account option from the Search By list and Regular option from the Bill Generation Type list. </td> <td data-bbox="1008 1155 1463 1365"> This column has a link. On clicking the link, the Bill screen appears where you can view the details of the respective bill. In addition this column has a context menu which helps in navigating to other screens in the application. </td> </tr> <tr> <td data-bbox="602 1365 1008 1507"> Invoice Requests for Account option from the Search By list and Trial option from the Bill Generation Type list. </td> <td data-bbox="1008 1365 1463 1507"> This column has a link. On clicking the link, the Trial Bill screen appears where you can view the details of the respective trial bill. </td> </tr> </tbody> </table> <p>By default, this column has a content menu which helps in navigating to other screens in the application.</p> <p>This column appears when the Invoice Requests for Accounts option is selected from the Search By list.</p>	If you select ...	Then...	Invoice Requests for Account option from the Search By list and Regular option from the Bill Generation Type list.	This column has a link. On clicking the link, the Bill screen appears where you can view the details of the respective bill. In addition this column has a context menu which helps in navigating to other screens in the application.	Invoice Requests for Account option from the Search By list and Trial option from the Bill Generation Type list.	This column has a link. On clicking the link, the Trial Bill screen appears where you can view the details of the respective trial bill.
If you select ...	Then...						
Invoice Requests for Account option from the Search By list and Regular option from the Bill Generation Type list.	This column has a link. On clicking the link, the Bill screen appears where you can view the details of the respective bill. In addition this column has a context menu which helps in navigating to other screens in the application.						
Invoice Requests for Account option from the Search By list and Trial option from the Bill Generation Type list.	This column has a link. On clicking the link, the Trial Bill screen appears where you can view the details of the respective trial bill.						
Error Message	<p>Displays the error message indicating the error that occurred while processing the bills in the invoice request.</p> <p>Note: This column appears when the Invoice Requests for Accounts option is selected from the Search By list.</p>						

Column Name	Column Description
Bill Generation Type	Indicates the bill generation type. The valid values are: <ul style="list-style-type: none"> Regular Trial
	Note: This column appears when the Invoice Requests for Accounts option is selected from the Search By list.

Note: Pagination is used to display limited number of records in the **Search Results** section. You can use the navigation links, such as **Previous** and **Next** to navigate between pages.

Related Topics

For more information on...	See...
How to search for an invoice request	Searching for an Invoice Request on page 2478

Searching for an Invoice Request

Prerequisites

To search for an invoice request, you should have:

- Invoice request types defined in the application

Procedure

To search for an invoice request:

1. Click the **Menu** link in the **Application** toolbar.
A list appears.
2. From the **Main** menu, select **Billing Management** and then click **Invoice Request**.
A sub-menu appears.
3. Click the **Search** option from the **Invoice Request** sub-menu.
The **Invoice Request** screen appears.
4. Enter the search criteria in the **Search Invoice Request** zone.

Note: ORMB search engine supports wildcard search, where you can substitute the percentage (%) symbol as a stand in for any word or letter in a search criteria. You can use the ‘%’ wildcard character in all input fields except the date and ID fields. The ‘%’ wildcard character is suffixed automatically at the end of the partial search criteria. Therefore, you may or may not specify the wildcard character at the end of the partial search criteria. However, you have to prefix the wildcard character manually wherever required.

5. Click **Search**.

A list of invoice requests that meet the search criteria appears in the **Search Results** section.

Related Topics

For more information on...	See...
Invoice Request screen	Invoice Request (Used for Searching) on page 2474
Search Invoice Request zone	Search Invoice Request on page 2474

Manually Creating an Invoice Request

Prerequisites

To create an invoice request, you should have:

- Invoice request types defined in the application
- Bills created in the application
- Account and Person entity defined in the application

Procedure

To create an invoice request:

1. Click the **Menu** link in the **Application** toolbar.
A list appears.
2. From the **Main** menu, select **Billing Management** and then click **Invoice Request**.
A sub-menu appears.
3. Click the **Add** option from the **Invoice Request** sub-menu.

The **Add Invoice Request** window appears. It contains the following field:

Field Name	Field Description	Mandatory (Yes or No)
Invoice Request Type	Used to indicate the invoice request type using which you want to create the invoice request.	Yes

Tip: Alternatively, you can access this window by clicking the **Add** button in the **Page Title** area of the **Invoice Request** screen.

4. Select the required invoice request type from the **Invoice Request Type** list.
5. Click **OK**.

The **Invoice Request** screen appears. It contains the following sections:

- **Main** - Used to specify basic details about the invoice request.
- **Characteristics** - Used to define the characteristics for the invoice request.

The **Main** section contains the following fields:

Field Name	Field Description	Mandatory (Yes or No)
Invoice Request Type	Indicates the invoice request type using which the invoice request is created.	Not applicable
Entity	Used to indicate the entity using which you want to create an invoice request. The valid values are: <ul style="list-style-type: none"> • Account • Person 	Not applicable
Note: By default, the Account option is selected.		
Account ID	Used to indicate the account for which you want to create an invoice request.	Yes

Field Name	Field Description	Mandatory (Yes or No)
	Note: The Search (🔍) icon appears corresponding to the Account ID field. On clicking the Search icon, the Account Search window appears.	
Person ID	Used to indicate the person for whom the invoice request is generated. Note: The Search (🔍) icon appears corresponding to Person ID field. On clicking the Search icon, the Person Search window appears.	Yes
Cutoff Date	Used to specify the date till when the billable charges are considered for processing the invoice request. Note: By default, the current date appears in this field.	No
Accounting Date	Used to specify the accounting date of the bill. Note: By default, the current date appears in this field.	No
Bill Date	Used to specify the processing date on which the bill is completed. Note: The bill date cannot be on or earlier than the last bill date of the account. By default, the current date appears in this field.	No
Comments	Used to specify additional information about the invoice request.	No

6. Enter the required details in the **Main** section.
7. Define characteristics for the invoice request, if required.
8. Click **Save**

The invoice request is created in the **Draft** status, and the status of all the records (in the invoice request) is set to **Pending**.

Related Topics

For more information on...	See...
Invoice Request screen	Invoice Request (Used for Searching) on page 2474
How to define a characteristic for an invoice request	Defining a Characteristic for an Invoice Request on page 2488

Viewing the Invoice Request Details

Procedure

To view the details of an invoice request:

1. Search for the invoice request in the **Invoice Request Search** screen.
2. In the **Search Results** section, click the link in the **Invoice Request Information** column corresponding to the invoice request whose details you want to view.

The **Invoice Request** screen appears.

3. Ensure that the **Main** tab is selected.
4. View the details of the invoice request in the **Invoice Request** zone.

Related Topics

For more information on...	See...
How to search for an invoice request	Invoice Request (Used for Searching) on page 2474
Invoice Request screen	Invoice Request (Used for Viewing) on page 2481
Invoice Request zone	Invoice Request on page 2481

Invoice Request (Used for Viewing)

The **Invoice Request** screen allows you to:

- View the details of the invoice request
- Edit the details of the invoice request
- Delete the invoice request
- Submit the invoice request for processing
- Approve or reject the invoice request
- Cancel the invoice request
- View the log of the invoice request
- Add a log entry for the invoice request

It consists of the following tabs:

- [Invoice Request - Main](#) on page 2481
- [Invoice Request - Log](#) on page 2486

Invoice Request - Main

The **Main** tab displays information about the invoice request. It contains the following zones:

- [Invoice Request](#) on page 2481
- [Invoice Request Details/Account List](#) on page 2484

Invoice Request

The **Invoice Request** zone displays the details of the invoice request. It contains the following sections:

- **Main** - Displays basic information about the invoice request. It contains the following fields:

Field Name	Field Description
Invoice Request Information	Displays information about the invoice request.
Invoice Request Type	Indicates the invoice request type using which the invoice request is created.

Field Name	Field Description
	<p>Note: It has a link. On clicking the link, the Invoice Request Type screen appears where you can view the details of the respective invoice request type.</p>
Entity	Indicates the entity using which an invoice request is created.
Account Information	<p>Indicates the account using which an invoice request is created.</p> <p>Note: It has a link. On clicking the link, the Account screen appears where you can view the details of the respective account.</p>
Cutoff Date	<p>Indicates the date till when the billable charges are considered for processing the invoice request.</p> <p>Note: This field is applicable only for Entity Type as Account.</p>
Accounting Date	Indicates the accounting date for which the financial transaction of the bill is created.
Bill Date	<p>Indicates the date when the bill is completed.</p> <p>Note: The bill date must not be equal to or earlier than the last bill date of the account for which the invoice request is generated.</p>
Processing Date	<p>Indicates the date when the invoice request is processed.</p> <p>Note: Processing Date = Invoice Request Creation Date + Wait Day + Work Days</p>
Status	<p>Indicates the status of the invoice request. The valid values are:</p> <ul style="list-style-type: none"> • Draft • Account Derivation Pending • Submitted • Approval In Progress • Approved • Deferred Processing • Deferred Processing - Batch • Rejected • Cancelled • Error • Processing • Processed • Return to Submitter
Status Reason	Indicates the reason why the status of the invoice request is changed.

Field Name	Field Description
	Note: It has a link. On clicking the link, the Status Reason screen appears where you can view the details of the respective status.

- **Characteristics** - Lists the characteristics defined for the invoice request. It contains the following columns:

Column Name	Column Description
Effective Date	Displays the date from when the characteristic is effective for the invoice request.
Characteristic Type	Indicates the characteristic type.
Characteristic Value	Displays the value of the characteristic type.

- **Record Actions** - This section contains the following buttons:

Button Name	Button Description
Edit	Used to edit the details of the invoice request.
	Note: The Edit button appears when the invoice request is in the Draft status.
Delete	Used to delete the invoice request.
	Note: The Delete button appears when the invoice request is in the Draft status.
Submit	Used to submit the invoice request.
	Note: The Submit button appears when the invoice request is in the Draft status.
Cancel	Used to cancel the invoice request.
	Note: The Cancel button appears when the invoice request is in the Deferred Processing Batch status.
Approve	Used to approve the invoice request.
	Note: The Approve button appears when: <ul style="list-style-type: none"> • The invoice request is in the Approval In Progress status. • A user with the approval To Do role is reviewing the invoice request.
Reject	Used to reject the invoice request.
	Note: The Reject button appears when: <ul style="list-style-type: none"> • The invoice request is in the Approval In Progress status. • A user with the approval To Do role is reviewing the invoice request.
Re Submit	Used to request for resubmitting the invoice request.

Button Name	Button Description
	<p>Note: The Re Submit button appears when:</p> <ul style="list-style-type: none"> The invoice request is in the Approval In Progress status. A user with the approval To Do role is reviewing the invoice request.

- **Record Information** - This section contains the following fields:

Field Name	Field Description
Business Object	<p>Indicates the business object using which the invoice request is created. In addition, a context menu appears corresponding to this field which helps in navigating to other screens in the application.</p> <p>Note: It has a link. On clicking the link, the Business Object screen appears where you can view the details of the respective business object.</p>
Status Date/Time	Displays the date and time when the invoice request status is updated.
Create Date/Time	Displays the date and time when the invoice request is created.

- **External Reference** - Lists the external references defined for the invoice request. This section contains the following columns:

Note: This section appears when the invoice request is in the **Deferred Processing Batch** or **Canceled** status.

Column Name	Column Description
External Reference Type	Indicates the external reference type of the invoice request.
External Reference Information	<p>Displays additional information about the external reference type.</p> <p>Note: It has a link. On clicking the link, the Policy screen appears with the details of the respective policy.</p>

Related Topics

For more information on...	See...
How to edit an invoice request	Editing an Invoice Request on page 2487
How to delete an invoice request	Deleting an Invoice Request on page 2490
How to submit an invoice request	Submitting an Invoice Request on page 2491
How to cancel an invoice request	Canceling an Invoice Request on page 2490
How to approve an invoice request	Approving an Invoice Request on page 2492
How to reject an invoice request	Rejecting an Invoice Request on page 2493
How to request for resubmitting an invoice request	Requesting to Resubmit an Invoice Request on page 2495

Invoice Request Details/Account List

The **Invoice Request Details/Account List** zone lists the bills or the accounts which are added to the invoice request. It contains the following columns:

Column Name	Column Description
Account Information	Indicates the account for which the invoice request is created. In addition, this column has a context menu which helps in navigating to other screens in the application.
	Note: It has a link. On clicking the link, the Account screen appears where you can view the details of the respective account.
Person Information	Indicates the person for which the invoice request is created. In addition, this column has a context menu which helps in navigating to other screens in the application.
	Note: It has a link. On clicking the link, the Person screen appears where you can view the details of the respective person.
Record Status	Indicates the status of the bills in the invoice request. The valid values are: <ul style="list-style-type: none"> • Pending • Error • Processing
Bill Information	Indicates the bill which is added to the invoice request. In addition, this column has a context menu which helps in navigating to other screens in the application.
	Note: It has a link. On clicking the link, the Bill screen appears where you can view the details of the respective bill.
Error Message	Displays the error message indicating the error that occurred while processing the bills in the invoice request.
Recent Billed Date	Displays the date of the bill that has been recently processed from the invoice request.

A check box appears corresponding to each account. On selecting the check box, and clicking the **Exclude** button, you can exclude the account from the invoice request. You can also select multiple accounts at the same time. In addition, you can select the check box corresponding to the column header. This allows you to exclude all accounts listed in the respective page from the invoice request.

<p>Note:</p> <p>Pagination is used to display limited number of records in this zone. You can use the navigation links, such as Previous and Next to navigate between pages.</p> <p>The Filter icon appears when the zone is Account List.</p> <p>You can filter the list using various search criteria (such as, Record Status, Account ID, and Person ID) available in the Filter area. By default, the Filter area is hidden. You can view the Filter area by clicking the Filters () icon in the upper right corner of this zone.</p>
--

Excluded Accounts

The **Excluded Accounts** zone lists the accounts which are excluded from the invoice request. It appears when **Invoice Requests for Persons** option is selected from the **Search By list** in the **Search Invoice Request** zone. It contains the following columns:

Column Name	Column Description
Account Information	Indicates the account for which the invoice request is created. In addition, this column has a context menu which helps in navigating to other screens in the application.

Column Name	Column Description
	Note: It has a link. On clicking the link, the Account screen appears where you can view the details of the respective account.
Person Information	Indicates the person for which the invoice request is created. In addition, this column has a context menu which helps in navigating to other screens in the application.
	Note: It has a link. On clicking the link, the Person screen appears where you can view the details of the respective person.

A check box appears corresponding to each account. On selecting the check box, and clicking the **Include** button, you can include the account to the invoice request. You can also select multiple accounts at the same time. In addition, you can select the check box corresponding to the column header. This allows you to add all accounts listed in the respective page to the invoice request.

Note:

Pagination is used to display limited number of records in this zone. You can use the navigation links, such as **Previous** and **Next** to navigate between pages.

The **Filter** icon appears when the zone is **Account List**.

You can filter the list using various search criteria (such as, **Record Status**, **Account ID**, and **Person ID**) available in the **Filter** area. By default, the **Filter** area is hidden. You can view the **Filter** area by clicking the **Filters** (🔍) icon in the upper right corner of this zone.

Invoice Request - Log

The **Log** tab contains the following zone:

- [Invoice Request Log](#) on page 2486

Invoice Request Log

The **Invoice Request Log** zone lists the complete trail of actions performed on the invoice request. It contains the following columns:

Column Name	Column Description
Creation Date/Time	Displays the date and time when the action was performed on the invoice request.
Details	Displays the details of the action performed on the invoice request.
User	Indicates the user who has performed the action on the invoice request.
Log Type	Indicates the type of log.
Related Object	Indicates the object or entity which is created when the action is performed on the invoice request.
	Note: At present, no data appears in this column. The implementation team can build the custom logic to meet the business requirements.
Status Reason	Indicates the reason why the invoice request was rejected by the approver.
	Note: The data appears in this column when the invoice request is in the Rejected status.

Note: You can manually add a log entry for the invoice request by clicking the **Add Log Entry** link in the upper right corner of the **Invoice Request Log** zone.

Related Topics

For more information on...	See...
How to view the log of a invoice request	Viewing the Log of an Invoice Request on page 2496
How to add a log entry for an invoice request	Adding a Log Entry for an Invoice Request on page 2497

Editing an Invoice Request

Prerequisites

To edit an invoice request, you should have:

- Invoice request types defined in the application
- Bills created in the application
- Account and Person entity defined in the application

Procedure

To edit an invoice request:

1. Search for the invoice request in the **Invoice Request** screen.
2. In the **Search Results** section, click the link in the **Invoice Request Information** column corresponding to the invoice request whose details you want to edit.

The **Invoice Request** screen appears.

3. Click the **Edit** button in the **Invoice Request** zone.

The **Edit Invoice Request** screen appears. It contains the following sections:

- **Main** - Used to specify basic details about the invoice request.
- **Characteristics** - Used to define the characteristics for the invoice request.

The **Main** section contains the following fields:

Field Name	Field Description	Mandatory (Yes or No)
Invoice Request Information	Displays information about the invoice request.	Not applicable
Invoice Request Type	Indicates the invoice request type using which the invoice request is created.	Not applicable
Entity	Used to indicate the entity using which you want to edit an invoice request. The valid values are: <ul style="list-style-type: none"> • Account • Person 	Not applicable
	Note: This field is in the read-only mode.	
Account ID	Used to indicate the account using which you want to edit an invoice request.	Yes

Field Name	Field Description	Mandatory (Yes or No)
	<p>Note:</p> <p>The Search (🔍) icon appears corresponding to the Account ID field. On clicking the Search icon, the Account Search window appears.</p>	
Cutoff Date	<p>Used to specify the date till when the billable charges are considered for processing the invoice request.</p> <p>Note: If the cutoff date is not mentioned, the system considers current date as the cutoff date.</p>	No
Accounting Date	<p>Used to specify the accounting date of the bill.</p> <p>Note: If the accounting date is not mentioned, the system considers current date as the accounting date.</p>	No
Bill Date	<p>Used to specify the processing date on which the bill is completed.</p> <p>Note:</p> <p>The bill date cannot be on or earlier than the last bill date of the account.</p> <p>If the bill date is not mentioned, the system considers current date as the bill date.</p>	No
Comments	Used to specify additional information about the invoice request.	No

Note: The **Edit** button appears when the invoice request is in the **Draft** status.

4. Modify the details of the invoice request, if required.
5. Define, edit, or remove characteristics of the invoice request, if required.
6. Click **Save**.

The changes made to the invoice request are saved.

Related Topics

For more information on...	See...
How to search for an invoice request	Searching for an Invoice Request on page 2478
Invoice Request screen	Invoice Request (Used for Viewing) on page 2481
Invoice Request zone	Invoice Request on page 2481
How to define a characteristic for an invoice request	Defining a Characteristic for an Invoice Request on page 2488

Defining a Characteristic for an Invoice Request

Prerequisites

To define a characteristic for an invoice request, you should have:

- Characteristic types defined in the application (where the characteristic entity is set to **Invoice Request**)

Procedure

To define a characteristic for an invoice request:

1. Ensure that the **Characteristics** section is expanded when you are defining, editing, or copying an invoice request type.

The **Characteristics** section contains the following fields in a grid:

Field Name	Field Description	Mandatory (Yes or No)
Effective Date	Used to specify the date from when the characteristic is effective for the invoice request.	Yes (Conditional)
		Note: This field is required when you are defining a characteristic for the invoice request.
Characteristic Type	Used to indicate the characteristic type. Note: The list includes only those characteristic types where the characteristic entity is set to Invoice Request .	Yes (Conditional)
		Note: This field is required when you are defining a characteristic for the invoice request.
Characteristic Value	Used to specify the value for the characteristic type. Note: If you select a predefined characteristic type, the Search (🔍) icon appears corresponding to the Characteristic Value field. On clicking the Search icon, you can search for a predefined characteristic value. On specifying the value for a predefined characteristic type, the description of the characteristic value appears corresponding to the Characteristic Value field.	Yes (Conditional)
		Note: This field is required when you are defining a characteristic for the invoice request.

2. Enter the required details in the **Characteristics** section.
3. If you want to define more than one characteristic for the invoice request, click the **Add** (+) icon and then repeat step 2.

Note: However, if you want to remove a characteristic from the invoice request, click the **Delete** (🗑️) icon corresponding to the characteristic.

4. Click **Save**.

The characteristics are defined for the invoice request.

Related Topics

For more information on...	See...
How to edit an invoice request	Editing an Invoice Request on page 2487

Deleting an Invoice Request

Procedure

To delete an invoice request:

1. Search for the invoice request in the **Search Invoice Request** screen.
2. In the **Search Results** section, click the link in the **Invoice Request Information** column corresponding to the invoice request that you want to delete.

The **Invoice Request** screen appears.

3. Click the **Delete** button in the **Invoice Request** zone.

A message appears confirming whether you want to delete the invoice request.

Note: The **Delete** button appears when the invoice request is in the **Draft** status.

4. Click **OK**.

The invoice request is deleted.

Related Topics

For more information on...	See...
How to search for an invoice request	Searching for an Invoice Request on page 2478
Invoice Request screen	Invoice Request (Used for Viewing) on page 2481
Invoice Request zone	Invoice Request on page 2481

Canceling an Invoice Request

Prerequisites

To cancel an invoice request, you should have:

- Reasons defined for the **Canceled** status of the **C1-InvoiceRequest** business object in the **Status Reason** screen

Procedure

To cancel an invoice request:

1. Search for the invoice request in the **Search Invoice Request** screen.
2. In the **Search Results** section, click the link in the **Invoice Request Information** column corresponding to the invoice request that you want to cancel.

The **Invoice Request** screen appears.

3. Click the **Cancel** button in the **Invoice Request** zone.

The **Invoice Request** window appears. It contains the following field:

Field Name	Field Description	Mandatory (Yes or No)
Status Reason	Used to indicate the reason why you want to cancel the invoice request.	Yes

Field Name	Field Description	Mandatory (Yes or No)
	Note: The list includes only those reasons which are defined for the Canceled status of the C1-InvoiceRequest business object in the Status Reason screen.	

Note: The **Cancel** button appears when the invoice request is in the **Deferred Processing** or **Deferred Processing - Batch** status.

4. Select the reason for canceling the invoice request from the **Status Reason** list.
5. Click **Save**.

The status of the invoice request (along with the bills within the invoice request) is changed to **Canceled**.

Related Topics

For more information on...	See...
How to search for an invoice request	Searching for an Invoice Request on page 2478
Invoice Request screen	Invoice Request (Used for Viewing) on page 2481
Invoice Request zone	Invoice Request on page 2481

Submitting an Invoice Request

Prerequisites

To submit an invoice request, you should have:

- The status of the invoice request in the **Draft** status.
- The invoice request type as **Manual**.

Procedure

To submit an invoice request:

1. Search for the invoice request in the **Search Invoice Request** screen.
2. In the **Search Results** section, click the link in the **Invoice Request Information** column corresponding to the invoice request that you want to submit.

The **Invoice Request** screen appears.

3. Click the **Submit** button in the **Invoice Request** zone.

The system behaves in the following manner:

If...	Then...
The Approval Required option is selected in the respective invoice request type	The status of the invoice request is changed to Approval In Progress . In this status, you can perform various actions on the invoice request, such as, Approve or Reject or Return To Submitter . If the approver clicks the Approve button, the status of the invoice request is changed to Approval In Progress . If the approver clicks the Reject button, the status of the invoice request is changed to Rejected . If the approver clicks the Return To Submitter button, a To Do is generated and the

If...	Then...
	invoice request is changed to Draft . The submitter updates the invoice request and redirects it back to the approver for approval purposes.
The Approval Required option is not selected in the respective invoice request type and the entity type is Person	The status of the invoice request is changed to Processed , or Deferred Processing or Deferred Processing - Batch .
The Approval Required option is not selected in the respective invoice request type, and the entity type is Account , and the billable charge count exceeds the defer processing billable charge count	The status of the invoice request is changed to Deferred Processing - Batch .
The Approval Required option is not selected in the respective invoice request type, and the entity type is Account , and the billable charge count does not exceed the defer processing billable charge count, and the invoice processing date does not exceed the system date	The status of the invoice request is changed to Processed else it is changed to Defer Processing .

Note:

The **Submit** button appears when the invoice request is in the **Draft** status and invoice request type is **Manual**.

Related Topics

For more information on...	See...
How to search for an invoice request	Searching for an Invoice Request on page 2478
Invoice Request screen	Invoice Request (Used for Viewing) on page 2481
Invoice Request zone	Invoice Request on page 2481

Approving an Invoice Request

You can view the number of invoice requests which are pending for approval in the **Invoice Request** screen. The approver can review, and accordingly approve, reject, or ask the submitter to resubmit the invoice request based on the observations.

Note: The system will not allow you to approve, reject, or resubmit an invoice request submitted by you.

Prerequisites

To approve an invoice request, you should have:

- Approval To Do role assigned in the system

Procedure

To approve an invoice request:

1. Do either of the following:

If you want to...	Then...
Approve an invoice request through the Invoice Request screen	<ol style="list-style-type: none"> 1. Search for the invoice request in the Invoice Request screen.

If you want to...	Then...
	<ol style="list-style-type: none"> In the Search Results section, click the link in the Invoice Request Information column corresponding to the invoice request which you want to review.
Approve an Invoice request from the To Do List screen	<ol style="list-style-type: none"> Click the Menu link in the Application toolbar. A list appears. From the Main menu, select To Do and then click To Do List. The To Do Type for User Search window appears. Enter C1-INVRATODO in the To Do Type field. Click the Search button corresponding to the To Do Type field. The To Do List screen appears. Select the Open option from the Filter by list to view all unassigned To Dos. Click the link in the Message column corresponding to the To Do of the invoice request that you want to review.

The **Invoice Request** screen appears.

- Review the details in the **Invoice Request** screen.
- If the information in the invoice request is accurate, then click the **Approve** button in the **Invoice Request** zone.

The system behaves in the following manner:

If...	Then...
The status of the invoice request is changed to Approved	A To Do entry is created using the To Do type F1-TODOCOMPL specified in the approval profile and is assigned back to the submitter to complete the invoice request.

Note: The **Approve** button appears when:

- The invoice request is in the **Approval In Progress** status.
- A user with the approval To Do role is reviewing the invoice request.

Related Topics

For more information on...	See...
How to search for an invoice request	Searching for an Invoice Request on page 2478
Invoice Request screen	Invoice Request (Used for Viewing) on page 2481
Invoice Request zone	Invoice Request on page 2481

Rejecting an Invoice Request

Prerequisites

To reject an invoice request, you should have:

- Reasons defined for the **Rejected** status of the **C1-InvoiceRequest** business object in the **Status Reason** screen.

Note: The system will not allow you to approve, reject, or resubmit an invoice request submitted by you.

Procedure

To reject an invoice request:

- Do either of the following:

If you want to...	Then...
Reject an invoice request through the Invoice Request screen	<ol style="list-style-type: none"> Search for the invoice request in the Invoice Request screen. In the Search Results section, click the link in the Invoice Request Information column corresponding to the invoice request which you want to review.
Reject an invoice request from the To Do List screen	<ol style="list-style-type: none"> Click the Menu link in the Application toolbar. A list appears. From the Main menu, select To Do and then click To Do List. The To Do Type for User Search window appears. Enter C1-INVRATODO in the To Do Type field. Click the Search button corresponding to the To Do Type field. The To Do List screen appears. Select the Open option from the Filter by list to view all unassigned To Dos. Click the link in the Message column corresponding to the To Do of the invoice request that you want to review.

The **Invoice Request** screen appears.

- Review the details in the **Invoice Request** screen.
- If the information in the invoice request is incorrect, then click the **Reject** button in the **Invoice Request** zone.

The **Reject Invoice Request** window appears. It contains following fields:

Field Name	Field Description	Mandatory (Yes or No)
Status Reason	Used to indicate the reason why you want to reject the invoice request.	Yes
	Note: The list includes only those reasons which are defined for the Rejected status of the C1-InvoiceRequest business object in the Status Reason screen.	
Comments	Used to specify additional information while rejecting the invoice request.	No

Note: The **Reject** button appears when:

- The invoice request is in the **Approval In Progress** status.
- A user with the approval To Do role is reviewing the invoice request.

4. Select the reason for rejecting the invoice request from the **Status Reason** list.
5. Click **Save**.

The status of the invoice request is changed to **Rejected**.

Related Topics

For more information on...	See...
How to search for an invoice request	Searching for an Invoice Request on page 2478
Invoice Request screen	Invoice Request (Used for Viewing) on page 2481
Invoice Request zone	Invoice Request on page 2481

Requesting to Resubmit an Invoice Request

Procedure

To request to resubmit an invoice request:

1. Do either of the following:

If you want to...	Then...
Request for resubmitting an invoice request through the Invoice Request screen	<ol style="list-style-type: none"> 1. Search for the invoice request in the Invoice Request screen. 2. In the Search Results section, click the link in the Invoice Request Information column corresponding to the invoice request which you want to review.
Request for resubmitting an invoice request from the To Do List screen	<ol style="list-style-type: none"> 1. Click the Menu link in the Application toolbar. A list appears. 2. From the Main menu, select To Do and then click To Do List. The To Do Type for User Search window appears. 3. Enter C1-INVRATODO in the To Do Type field. 4. Click the Search button corresponding to the To Do Type field. The To Do List screen appears. 5. Select the Open option from the Filter by list to view all unassigned To Dos. 6. Click the link in the Message column corresponding to the To Do of the invoice request that you want to review.

The **Invoice Request** screen appears.

- Review the details in the **Invoice Request** screen.
- If the information in the invoice request is incomplete and you want the submitter to make the required changes and resubmit the invoice request for approval, then click the **ReSubmit** button in the **Invoice Request** zone.

The **Resubmit Invoice Request** window appears. It contains the following field:

Field Name	Field Description	Mandatory (Yes or No)
Comments	Used to specify the changes which the submitter should make in the invoice request before resubmitting it for approval.	Yes

Note: The **Re Submit** button appears when:

- The invoice request is in the **Approval In Progress** status.
- A user with the approval To Do role is reviewing the invoice request.

- Enter the comments in the respective field and then click **Save**.

A To Do is created using the submitter To Do type and assigned to all users with a submitter To Do role specified in the invoice request type. In addition, the status of the invoice request is changed to **Draft**.

Related Topics

For more information on...	See...
How to search for an invoice request	Searching for an Invoice Request on page 2478
Invoice Request screen	Invoice Request (Used for Viewing) on page 2481
Invoice Request zone	Invoice Request on page 2481

Viewing the Log of an Invoice Request

Procedure

To view the log of an invoice request:

- Search for the invoice request in the **Invoice Request** screen.
- In the **Search Results** section, click the link in the **Invoice Request Information** column corresponding to the invoice request whose log you want to view.

The **Invoice Request** screen appears.

- Click the **Log** tab.

The **Log** tab appears.

- View the complete trail of actions performed on the invoice request in the **Invoice Request Log** zone.

Related Topics

For more information on...	See...
How to search for an invoice request	Searching for an Invoice Request on page 2478
Invoice Request screen	Invoice Request (Used for Viewing) on page 2481
Invoice Request Log zone	Invoice Request on page 2481

For more information on...	See...
How to add a log entry for an invoice request	Adding a Log Entry for an Invoice Request on page 2497

Adding a Log Entry for an Invoice Request

Procedure

To add a log entry for an invoice request:

1. Search for the invoice request in the **Invoice Request** screen.
2. In the **Search Results** section, click the link in the **Invoice Request Information** column corresponding to the invoice request whose log you want to edit.

The **Invoice Request** screen appears.

3. Click the **Log** tab.

The **Log** tab appears.

4. Click the **Add Log Entry** link in the upper right corner of the **Invoice Request Log** zone.

The **Add Request Log** window appears. It contains the following fields:

Field Name	Field Description	Mandatory (Yes or No)
Request Information	Displays information about the invoice request.	Not applicable
Log Details	Used to specify additional comments for the invoice request.	Yes

5. Enter the comments in the **Log Details** field.
6. Click **Save**.

The log entry is added in the **Invoice Request Log** zone.

Related Topics

For more information on...	See...
How to search for an invoice request	Searching for an Invoice Request on page 2478
Invoice Request screen	Invoice Request (Used for Viewing) on page 2481
Invoice Request Log zone	Invoice Request on page 2481

Chapter 41

Refund/Write Off Request

Topics:

- [Prerequisites](#)
- [Refund Request \(Without Approval\) Status Transition](#)
- [Refund Request \(With Approval\) Status Transition](#)
- [Write Off Request \(Without Approval\) Status Transition](#)
- [Write Off Request \(With Approval\) Status Transition](#)
- [Account Level Refund/Write Off](#)
- [Refund/Write Off Adjustment at Bill Level](#)
- [Algorithms Used in C1-RefundReq](#)
- [Algorithms Used in C1-WORequest](#)
- [Refund/Write Off Request Type](#)
- [Refund/Write Off Request](#)
- [Refund Request](#)
- [Write Off Request](#)

Oracle Revenue Management and Billing allows you to refund and write off amount to the account. If the amount received from the payor account is matched against the suspense or excess credit contract, the system facilitates you to refund the amount to the payor. In addition, you can refund the amount of a credit bill line item, such as credit bill segment or adjustment, if required. To refund the amount to the account holder, you need to create refund adjustments through a refund request. While creating a refund request, you need to specify the refund request type using which you want to create the refund request. It is the refund request type which helps the system to determine:

- Whether the refund request must be approved before creating refund adjustments in the system
- Approval profile using which the refund request must be approved
- Whether multi-level or single-level approval is required while creating refund adjustments in the system
- Tolerance limit for refund (i.e. minimum refund amount)
- Adjustment type using which the write up adjustment must be created when the total refund amount is less than the minimum refund amount
- Default adjustment type using which refund adjustments must be created

The system allows you to create refund adjustments only using those adjustment types where A/P request type is defined. Once the refund adjustments are created, the A/P Extract process will extract the information and accordingly refund the amount to the payor. During the refund request process, a refund request goes through various statuses in its lifecycle. For more information about the refund request statuses, see [Refund Request \(Without Approval\) Status Transition](#) on page 2501 and [Refund Request \(With Approval\) Status Transition](#) on page 2502.

Note that the lifecycle of a refund request is driven by the business object using which the refund request is created. A refund request business object named **C1-RefundReq** is shipped with the product. The refund request feature explained in this document is articulated based on the lifecycle and logic defined in the **C1-RefundReq** business object.

Similarly, the system facilitates you to write off the amount to the account through a write off request. While creating a write off request, you need to specify the write off request type using which you want to create the write off request. It is the write off request type which helps the system to determine:

- Whether the write off request must be approved before creating write off adjustments in the system
- Approval profile using which the write off request must be approved

- Whether multi-level or single-level approval is required while creating write off adjustments in the system
- Default adjustment type using which write off adjustments must be created

The system allows you to create write off adjustments only using those adjustment types where A/P request type is not defined. During the write off request process, a write off request goes through various statuses in its lifecycle. For more information about the write off request statuses, see [Write Off Request \(Without Approval\) Status Transition](#) on page 2503 and [Write Off Request \(With Approval\) Status Transition](#) on page 2504.

Note that the lifecycle of a write off request is driven by the business object using which the write off request is created. A write off request business object named **C1-WORequest** is shipped with the product. The write off request feature explained in this document is articulated based on the lifecycle and logic defined in the **C1-WORequest** business object.

For more information on how to setup the refund and write off request processes, see [Prerequisites](#) on page 2501.

Prerequisites

To setup the refund request process, you need to do the following:

- Define the required adjustment types (for creating refund adjustments) where A/P request type is defined
- Define the required adjustment types (for creating write up adjustments) where A/P request type is not defined
- Define the required characteristic types where the characteristic entity is set to **Refund Write Off Request Type**
- Define the required characteristic types where the characteristic entity is set to **Refund Write Off Request**
- Define voided and rejected status reasons for the **C1-RefundReq** business object
- Assign the **C1-REFRQ** To Do type to a To Do role whose users must receive To Do generated while submitting a refund request for approval
- Define the required approval profiles with the credit hierarchy and **C1-REFRQ** To Do type
- Define an algorithm of the **C1-ADI-INFO** algorithm type and attach to the **Adjustment Information** system event in the **Algorithms** tab of the **Installation Options — Framework** screen
- Define the required refund request types in the system

To setup the write off request process, you need to do the following:

- Define the required adjustment types (for creating write off adjustments) where A/P request type is not defined
- Define the required characteristic types where the characteristic entity is set to **Refund Write Off Request Type**
- Define the required characteristic types where the characteristic entity is set to **Refund Write Off Request**
- Define cancelled and rejected status reasons for the **C1-WOREquest** business object
- Assign the **C1-WOREQ** To Do type to a To Do role whose users must receive To Do generated while submitting a write off request for approval
- Define the required approval profiles with the debit hierarchy and **C1-WOREQ** To Do type
- Define an algorithm of the **C1-ADI-INFO** algorithm type and attach to the **Adjustment Information** system event in the **Algorithms** tab of the **Installation Options — Framework** screen
- Define the required write off request types in the system

Refund Request (Without Approval) Status Transition

The following figure graphically indicates how a refund request moves from one status to another when approval workflow is off:

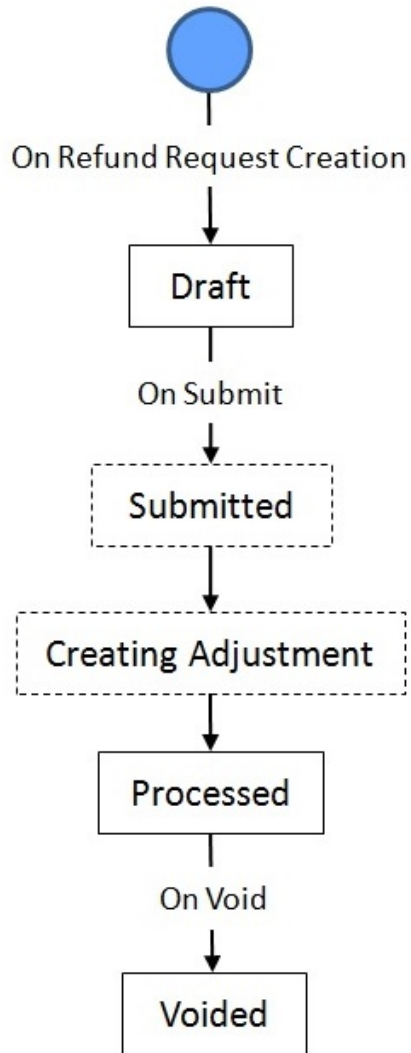

Refund Request (With Approval) Status Transition

The following figure graphically indicates how a refund request moves from one status to another when approval workflow is on:

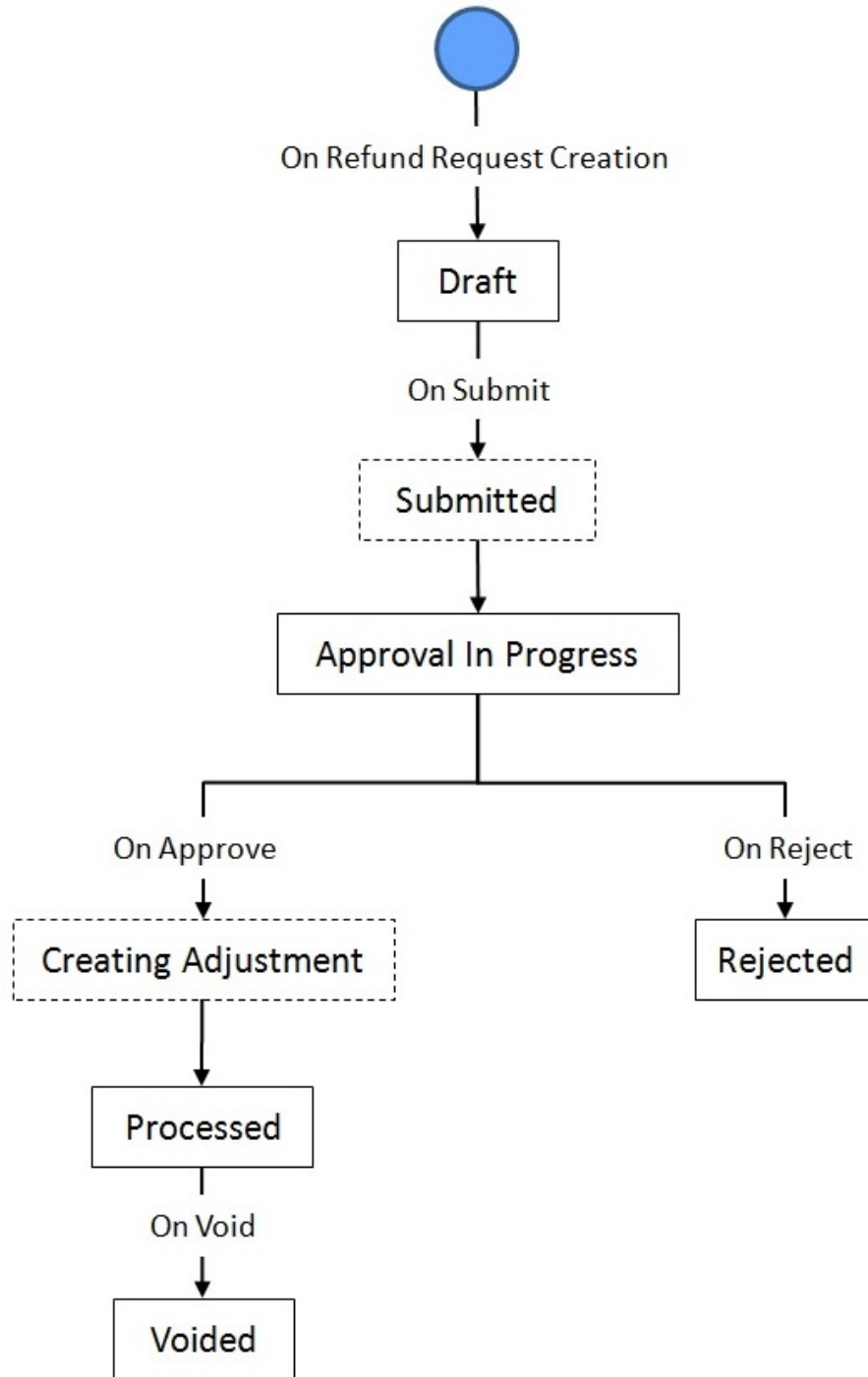

Write Off Request (Without Approval) Status Transition

The following figure graphically indicates how a write off request moves from one status to another when approval workflow is off:

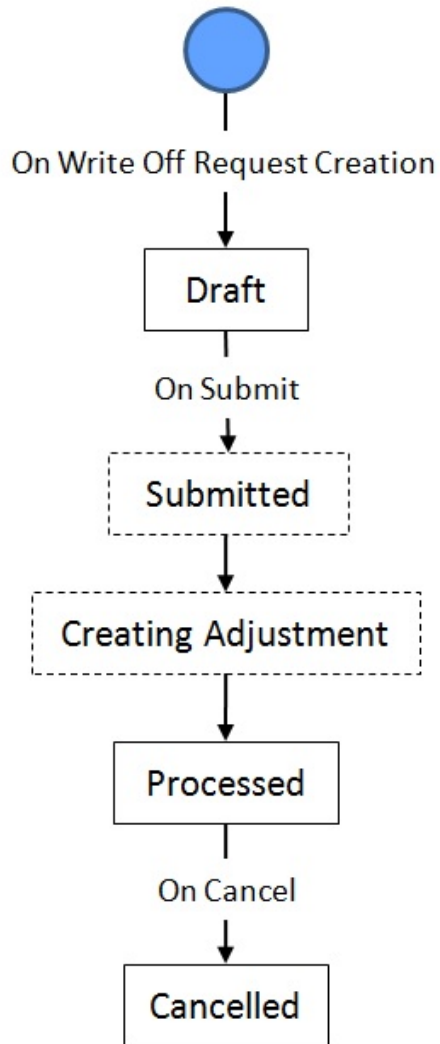

Write Off Request (With Approval) Status Transition

The following figure graphically indicates how a write off request moves from one status to another when approval workflow is on:

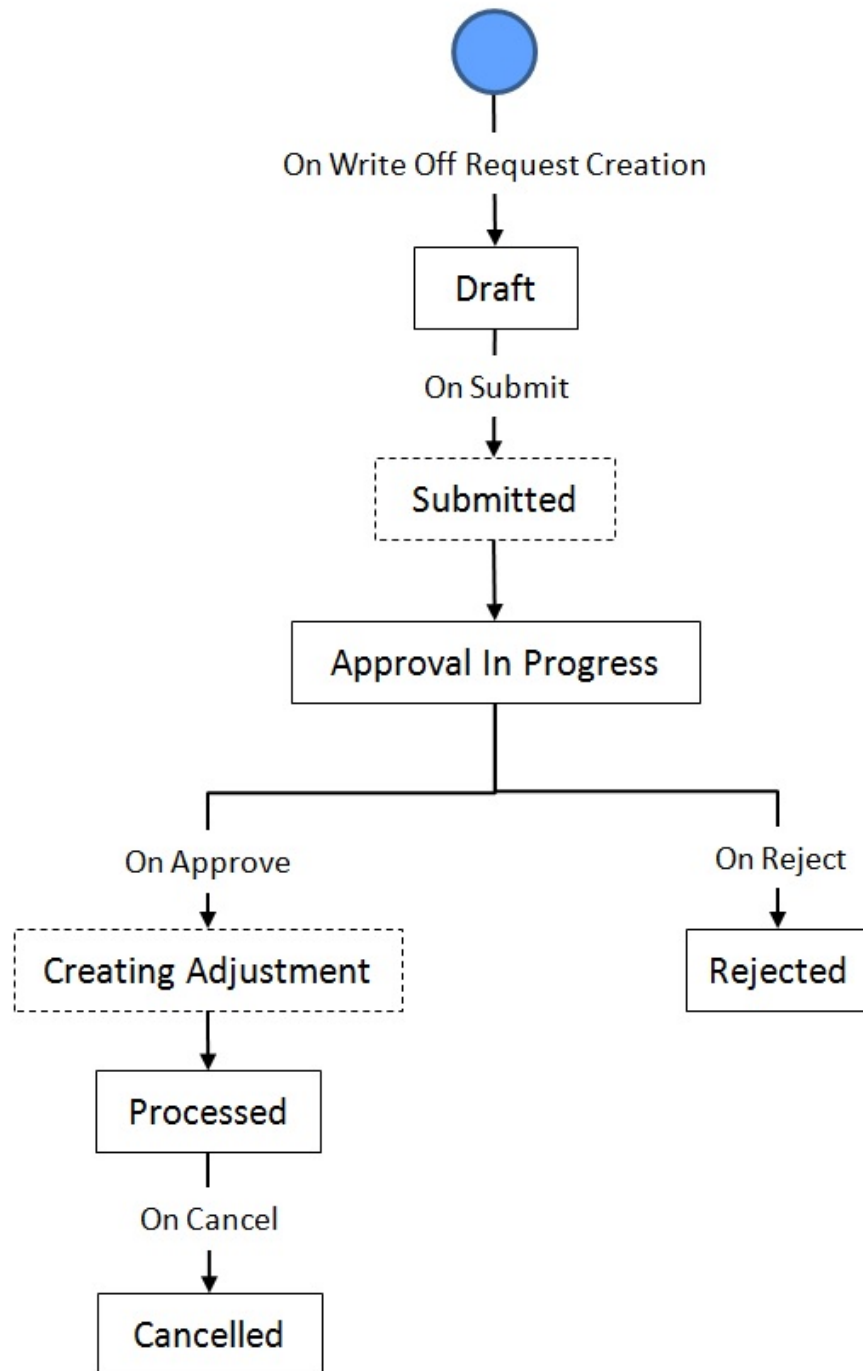

Account Level Refund/Write Off

Oracle Revenue Management and Billing enables you to create a refund/write off request at the account level. A new field named **Adjustment Level** is available while defining a refund/write off request. It allows you to control how the refund/write off adjustment should be created for the refund/write off request. It supports the following values:

- **Account** – Used when you want to create the refund/write off request at the account level. Here, the refund/write off adjustment is created against the netting contract of the account. This option is only applicable for the health insurance domain.
- **Bill** – Used when you want to create the refund/write off request for a bill. Here, the refund/write off adjustment is created against the netting contract of the account. This option is only applicable for the financial services domain.
- **Segment** – Used when you want to create the refund/write off request for a bill, bill segment, adjustment, or payment of an account. Here, the refund/write off adjustment is created against the bill segment, adjustment, or payment segment, respectively. If you select this option, the system behaves in the traditional manner.

If you do not specify the value for the **Adjustment Level** field, the system considers the value defined in the **Default Adjustment Level** option type of the **C1_REFWO** feature configuration. If you select the **Account** option from the **Adjustment Level** list, the system checks the account balance while creating the refund/write off request. If the account balance is zero, the system throws an appropriate error message and does not allow you to create the refund/write off request at the account level. However, if the account balance is in credit, the system allows you to create a refund request for the account. Similarly, if the account balance is in debit, the system allows you to create a write off request for the account.

While creating a refund/write off request at the account level, the system, by default, sets the total refund/write off amount to the account balance. You cannot edit the refund/write off amount. Even, the post processing algorithms cannot update the refund/write off amount in the refund/write off request.

Note: The **Bills** and **Payments and Adjustments** tabs do not appear in the **Refund Request** and **Write Off Request** screens when the refund/write off request is created at the account level.

Before creating the refund/write off request at the account level, you need to do the following:

- Attach the **C1-NTACBAL** algorithm to the **Netting Account Balance** system event in the **Algorithms** tab of the **Installation Options – Framework** screen
- Set the netting contract type on the respective refund/write off request type

The system invokes the **C1-NTACBAL** algorithm while processing the refund/write off request where the adjustment level is set to **Account**. The **C1-NTACBAL** algorithm creates transfer adjustments on the netting contract of the account. The transfer adjustment creation process slightly varies depending on the adjustment level that is selected while defining a refund/write off request.

If the adjustment level is set to **Account**, the system checks whether a netting contract created using the netting contract type (specified in the refund/write off request type) exists for the account. If so, the system considers the unmatched financial transactions of the account and then creates a transfer adjustment against each of them on the netting contract. However, if the netting contract does not exist for the account, then the system does the following:

1. Creates a netting contract using the netting contract type specified in the refund/write off request type
2. Considers the unmatched financial transactions of the account and then creates a transfer adjustment against each of them on the netting contract

You can opt to exclude unmatched financial transactions of contracts created using a particular contract type by setting the **Excluded Contract types for netting** option type of the **C1_CMO** feature configuration. You can exclude multiple contract types by defining the **Excluded Contract types for netting** option type multiple times (with unique sequence number) in the feature configuration. This option type is considered only when the adjustment level is set to **Account**.

On submitting or approving a refund/write off request at the account level, the system validates whether the refund/write off amount matches the current account balance. If the refund/write off amount does not match the current account balance, the system does not allow you to process the refund/write off request. However, if the refund/write off amount matches the current account balance, the system creates the transfer adjustments and refund/write off adjustment on the netting contract of the account.

On voiding a refund request where the adjustment level is set to **Account**, the system cancels the transfer adjustments and refund adjustment on the netting contract of the account. And, on canceling a write off request where the adjustment level is set to **Account**, the system cancels the transfer adjustments and write off adjustment on the netting contract of the account.

Refund/Write Off Adjustment at Bill Level

Until now, you were able to create the refund/write off request for a bill or bill line item (i.e. bill segment or adjustment) of an account. On processing the refund/write off request, the system used to create refund/write off adjustment against the bill line item irrespective of whether the refund/write off is done at the bill or bill line item level. There was a requirement wherein the system should allow to create the refund/write off adjustment against the bill and not against the bill line items when the refund/write off is done at the bill level.

Now, Oracle Revenue Management and Billing enables you to create a refund/write off adjustment at the bill level. A new field named **Adjustment Level** is available while defining a refund/write off request. It allows you to control how the refund/write off adjustment should be created for the refund/write off request. It supports the following values:

- **Account** – Used when you want to create the refund/write off request at the account level. Here, the refund/write off adjustment is created against the netting contract of the account. This option is only applicable for the health insurance domain.
- **Bill** - Used when you want to create the refund/write off request for a bill. Here, the refund/write off adjustment is created against the netting contract of the account. This option is only applicable for the financial services domain.
- **Segment** - Used when you want to create the refund/write off request for a bill, bill segment, adjustment, or payment of an account. Here, the refund/write off adjustment is created against the bill segment, adjustment, or payment segment, respectively. If you select this option, the system behaves in the traditional manner.

By default, the adjustment level is set to **Segment**. If you select the **Bill** option from the **Adjustment Level** list, the system checks the account balance while creating the refund/write off request. If the account balance is zero, the system throws an appropriate error message and does not allow you to create the refund/write off request for the account. However, if the account balance is in credit, the system allows you to create a refund request for the account. Similarly, if the account balance is in debit, the system allows you to create a write off request for the account.

Note: The **Payments and Adjustments** tab does not appear in the **Refund Request** screen when the adjustment level is set to **Bill** in the refund request.

Before creating the refund/write off request where the adjustment level is set to **Bill**, you need to do the following:

- Attach the **C1-NTACBAL** algorithm to the **Netting Account Balance** system event in the **Algorithms** tab of the **Installation Options – Framework** screen
- Set the netting contract type on the respective refund/write off request type

The system invokes the **C1-NTACBAL** algorithm while processing the refund/write off request where the adjustment level is set to **Bill**. The **C1-NTACBAL** algorithm creates transfer adjustments on the netting contract of the account. The transfer adjustment creation process slightly varies depending on the adjustment level that is selected while defining a refund/write off request.

If the adjustment level is set to **Bill**, then the system checks whether a netting contract created using the netting contract type (specified in the refund/write off request type) exists for the account and its contract balance is equal to zero. If both the conditions are met, the system considers the unpaid bill segments and adjustments of the bill and then creates a transfer adjustment against each of them on the netting contract. However, if the netting contract does not exist for the account, then the system does the following:

1. Creates a netting contract using the netting contract type specified in the refund/write off request type
2. Considers the unpaid bill segments and adjustments of the bill and then creates a transfer adjustment against each of them on the netting contract

And, if the netting contract exists for the account, but its contract balance is not equal to zero, the system throws an appropriate error message on the user interface.

On voiding a refund request where the adjustment level is set to **Bill**, the system cancels the transfer adjustments and refund adjustment on the netting contract of the account. And, on canceling a write off request where the adjustment level is set to **Bill**, the system cancels the transfer adjustments and write off adjustment on the netting contract of the account.

Algorithms Used in C1-RefundReq

The following table lists the algorithms which are attached to the **C1-RefundReq** business object:

System Event	Algorithm	Algorithm Type	Description
Information	C1-REFREQINF	C1-REFREQINF	This algorithm generates the refund and write off request information string which appears throughout the application. It concatenates the following fields: <ul style="list-style-type: none"> Refund or Write Off Request Type Description Refund or Write Off Request Status Description Refund or Write Off Request ID
Post-Processing	C1-REFWOPOSP	C1-REFWOPOSP	This algorithm recalculates and updates the total refund amount in the Refund Request zone when you change the refund amount against an entity while editing a refund request.
Validation	C1-REFUNDVAL	C1-REFUNDVAL	This algorithm validates the following for each entity that you have selected in the refund request: <ul style="list-style-type: none"> The mandatory data, such as refund amount and adjustment type, is specified. The refund amount is not less than zero. The refund amount is not greater than the entity amount. The refund amount is not greater than the eligible refund amount. The partial refund is not done at the payment event or bill level.

The following table lists the algorithms which are used in the lifecycle of the **C1-RefundReq** business object:

Status	System Event	Algorithm	Algorithm Type	Description
Draft	Enter	C1-REF-DFT	C1-REF-DFT	This algorithm fetches the account's main customer's name and address and displays in the Refund Request zone. In addition, when you refund the payments from the Payment Event Summary screen, this algorithm does the following: <ul style="list-style-type: none"> The total eligible refund amount is calculated and accordingly displayed in the Refund Request screen. The default refund adjustment type specified in the refund

Status	System Event	Algorithm	Algorithm Type	Description
				<p>request type is fetched and displayed against the selected payment event or payments.</p> <ul style="list-style-type: none"> On selecting a payment event for refund, if all payments in the payment event are matched against the same suspense or excess credit contract, the payment event is added in the Refund Details zone. However, if the payments in the payment event are matched against different suspense or excess credit contracts, the payments of the payment event are added in the Refund Details zone.
Submitted	Enter	C1-REFUNDSUB	C1-REFUNDSUB	<p>This algorithm checks the following:</p> <ul style="list-style-type: none"> Whether the approval is required for the refund request. If the approval is required for a refund request, the status of the refund request is changed to Approval In Progress. However, if the approval is not required for a refund request, the status of the refund request is changed to Creating Adjustment. At least one entity, such as payment event, payment, or credit bill line item (such as credit bill segment or adjustment) is selected in the refund request. Whether the approval profile attached to the refund request type has the credit hierarchy and C1-REFRQ To Do type defined.
Approval In Progress	Enter	C1-REFUNDAPP	C1-REFUNDAPP	<p>This algorithm creates the following:</p> <ul style="list-style-type: none"> A To Do using the To Do type specified in the approval profile which is attached to the refund request type. The To Do is sent to the appropriate users in the approval hierarchy depending on whether hierarchical approval is required or not.

Status	System Event	Algorithm	Algorithm Type	Description
				<ul style="list-style-type: none"> A log entry is added when a To Do is created using the To Do type.
Approved	Enter	C1-REFAPPRVD	C1-REFAPPRVD	<p>This algorithm is triggered when the approver clicks the Approve button. It checks whether the approval is required from users at the next level in the approval hierarchy. If the approval is required from the next level in the approval hierarchy, the status of the refund request is changed to Approval In Progress and the algorithm attached to the Approval In Progress status is invoked. If further approval is not required, the status of the refund request is changed to Creating Adjustment.</p>
Rejected	-	-	-	-
Creating Adjustment	Enter	C1-REFADJCRI	C1-REFADJCRI	<p>This algorithm does the following:</p> <ul style="list-style-type: none"> Creates the refund adjustments for the refund request. These refund adjustments are created in the Frozen status. The adjustment ID is displayed corresponding to the entity in the Refund Details zone. Stamps the bill ID of credit line item on the adjustment and the corresponding financial transaction. If a match event is present for the credit bill line item and for payments which are matched against the excess credit contract, the existing match event is stamped on the refund or write up adjustment and the corresponding financial transaction. However, when a match event is not present for payments which are matched against the suspense contract or if the match event does not exist, a new match event is created and stamped on the refund or write up adjustment and the corresponding financial transaction. If you are doing a partial refund for any entity, the corresponding

Status	System Event	Algorithm	Algorithm Type	Description
				<p>match event status is set to Open. However, if you are refunding the entire eligible amount, the corresponding match event status is set to Balanced.</p> <ul style="list-style-type: none"> The details of the refund adjustments are added in the A/P Check Request (CI_ADJ_APREQ) table. If a write up adjustment is created, the write up adjustment type specified in the refund request type is displayed corresponding to the entry in the Refund Details zone.
Processed	-	-	-	-
Voided	Enter	C1-REFVOID	C1-REFVOID	<p>This algorithm is invoked on click of the Void button for a refund request which is in processed state.</p> <p>The algorithm cancels all the frozen adjustments created for the refund request.</p> <p>The algorithm fetches the adjustment cancel reason required for cancelling the adjustments in the status reason characteristics (F1_BUS_OBJ_STATUS_RSN_CHAR table). If the reason is not found, it will use the status reason selected by the user</p>

Algorithms Used in C1-WORequest

The following table lists the algorithms which are attached to the **C1-WORequest** business object:

System Event	Algorithm	Algorithm Type	Description
Information	C1-REFREQINF	C1-REFREQINF	<p>This algorithm generates the refund and write off request information string which appears throughout the application. It concatenates the following fields:</p> <ul style="list-style-type: none"> Refund or Write Off Request Type Description Refund or Write Off Request Status Description Refund or Write Off Request ID

System Event	Algorithm	Algorithm Type	Description
Post-Processing	C1-WOPOSP	C1-WOPOSP	This algorithm recalculates and updates the total write off amount in the Write Off Request zone when you change the write off amount against an entity while editing a write off request.
Validation	C1-WOBOVAL	C1-WOBOVAL	This algorithm validates the following for each entity that you have selected in the write off request: <ul style="list-style-type: none"> The mandatory data, such as write off amount and adjustment type, is specified. The write off amount is not less than zero. The write off amount is not greater than the entity amount. The write off amount is not greater than the eligible write off amount. The partial write off is not done at the bill level. The A/P Request Type is not defined in the selected adjustment type.

The following table lists the algorithms which are used in the lifecycle of the **C1-WORequest** business object:

Status	System Event	Algorithm	Algorithm Type	Description
Draft	-	-	-	-
Submitted	Enter	C1-WOSUBMIT	C1-WOSUBMIT	This algorithm checks the following: <ul style="list-style-type: none"> Whether the approval is required for the write off request. If the approval is required for a write off request, the status of the write off request is changed to Approval In Progress. However, if the approval is not required for a write off request, the status of the write off request is changed to Creating Adjustment. At least one debit bill line item (such as debit bill segment or adjustment) is selected in the write off request. Whether the approval profile attached to the write off request type has the debit hierarchy and C1-WOREQ To Do type defined.
Approval In Progress	Enter	C1-WOAPPROVL	C1-WOAPPROVL	This algorithm creates the following: <ul style="list-style-type: none"> A To Do using the To Do type specified in the approval profile

Status	System Event	Algorithm	Algorithm Type	Description
				<p>which is attached to the write off request type. The To Do is sent to the appropriate users in the approval hierarchy depending on whether hierarchical approval is required or not.</p> <ul style="list-style-type: none"> A log entry is added when a To Do is created using the To Do type.
Approved	Enter	C1-WOAPPROVD	C1-WOAPPROVD	<p>This algorithm is triggered when the approver clicks the Approve button. It checks whether the approval is required from users at the next level in the approval hierarchy. If the approval is required from the next level in the approval hierarchy, the status of the write off request is changed to Approval In Progress and the algorithm attached to the Approval In Progress status is invoked. If further approval is not required, the status of the write off request is changed to Creating Adjustment.</p>
Rejected	-	-	-	-
Creating Adjustment	Enter	C1-WOAJCRT	C1-WOAJCRT	<p>This algorithm does the following:</p> <ul style="list-style-type: none"> Creates the write off adjustments for the write off request. These write off adjustments are created in the Frozen status. The adjustment ID is displayed corresponding to the entity in the Write Off Details zone. Stamps the bill ID of debit line item on the adjustment and the corresponding financial transaction. If a match event is present for the debit bill line item, the existing match event is stamped on the write off adjustment and the corresponding financial transaction. However, if the match event does not exist, a new match event is created and stamped on the write off adjustment and the corresponding financial transaction. If you are doing a partial write off for any entity,

Status	System Event	Algorithm	Algorithm Type	Description
				the corresponding match event status is set to Open . However, if the entire eligible amount is written off, the corresponding match event status is set to Balanced .
Processed	-	-	-	-
Cancelled	Enter	C1-WOCANCEL	C1-WOCANCEL	<p>This algorithm is invoked on click of the Cancel button for a write off request which is in the Processed state.</p> <p>This algorithm cancels all the frozen adjustments created for the write off request.</p> <p>The algorithm fetches the adjustment cancel reason required for cancelling the adjustments in the status reason characteristics (F1_BUS_OBJ_STATUS_RSN_CHAR table). If the reason is not found, it will use the status reason selected by the user.</p>

Refund/Write Off Request Type

Oracle Revenue Management and Billing allows you to define:

- **Refund Request Type** — It is used to create a refund request. You can define multiple refund request types in the system. A refund request type helps the system to determine:
 - Whether the refund request must be approved before creating refund adjustments in the system
 - Approval profile using which the refund request must be approved
 - Whether multi-level or single-level approval is required while creating refund adjustments in the system
 - Tolerance limit for refund (i.e. minimum refund amount)
 - Adjustment type using which the write up adjustment must be created when the total refund amount is less than the minimum refund amount
 - Default adjustment type using which refund adjustments must be created
- **Write Off Request Type** — It is used to create a write off request. You can define multiple write off request types in the system. A write off request type helps the system to determine:
 - Whether the write off request must be approved before creating write off adjustments in the system
 - Approval profile using which the write off request must be approved
 - Whether multi-level or single-level approval is required while creating write off adjustments in the system
 - Default adjustment type using which write off adjustments must be created

While defining a refund or write off request type where approval workflow is required, you need to select the **Approval Required** check box. If the **Approval Required** check box is selected, the refund or write off request (which is created using the refund or write off request type) is sent for approval before creating the refund or write off adjustments.

However, if the **Approval Required** check box is not selected, the refund or write off adjustments are created immediately on submitting a refund or write off request. The approval process is configured through the approval profile. The approval profile allows you to define the approval hierarchy. You can define a debit and credit hierarchy in the approval profile using the threshold amount. The debit approval hierarchy is used for approving write off request and credit approval hierarchy is used for approving refund request. Therefore, while defining an approval profile for refund, you need to define credit hierarchy and set the To Do Type to **C1-REFRQ**. However, while defining an approval profile for write off, you need to define debit hierarchy and set the To Do Type to **C1-WOREQ**.

You can define an approval hierarchy where users with different To Do role at each level can approve or reject the refund or write off request. For example, you can define an approval profile called A1 with two levels of approval. At the first level, a user with the *Manager* To Do role will approve or reject the refund or write off request, and at the second level, a user with the *Senior Manager* To Do role will approve or reject the refund or write off request. On submitting a refund or write off request where approval is required, a notification in the form of To Do is sent to all users with the To Do role defined at the first level in the hierarchy. Once the request is approved at the first level, a notification is sent to all users with the To Do role defined at the next level in the hierarchy. This process continues till the approval is received from all levels in the hierarchy. Once users at all levels approve the refund or write off request, the refund or write off adjustments are created. However, if an approver at any level in the hierarchy rejects the request, the refund or write off adjustments are not created.

The approval hierarchy is controlled by the threshold amount. For example, you define an approval profile called A1 with two levels of approval — *First Level* (Threshold Amount: 300, To Do Role: *Manager*) and *Second Level* (Threshold Amount: 500, To Do Role: *Senior Manager*). Now, if the total refund or write off amount is equal to 300 or less than 500, then the approval is required only from the first level in the hierarchy and not from the second level in the hierarchy. However, if the total refund or write off amount is equal to or greater than 500, then the approval is required from the first level and then from the second level in the hierarchy. But, if the total refund or write off amount is less than 300, then the approval is not required from any levels in the hierarchy. The system will automatically approve the refund or write off request and create the refund or write off adjustments.

The system supports both single-level and multi-level approval process while approving refund or write off request. If the **Hierarchical Approval** check box is selected while defining a refund or write off request type, the approval hierarchy defined in the approval profile is followed based on the threshold limit. However, if the **Hierarchical Approval** check box is not selected while defining a refund or write off request type, the approval is required only from the approval level where the total refund or write off amount falls within the threshold limit. Let us understand this with the help of some examples.

Example 1

Refund Request Type	Approval Profile	Approval Hierarchy	Hierarchical Approval								
R1	Refund Analyst	<p>Credit Hierarchy</p> <table border="1"> <thead> <tr> <th>Threshold Amount</th> <th>To Do Role</th> </tr> </thead> <tbody> <tr> <td>\$500</td> <td>Senior Analyst</td> </tr> <tr> <td>\$750</td> <td>Manager</td> </tr> <tr> <td>\$1500</td> <td>Senior Manager</td> </tr> </tbody> </table>	Threshold Amount	To Do Role	\$500	Senior Analyst	\$750	Manager	\$1500	Senior Manager	Yes
Threshold Amount	To Do Role										
\$500	Senior Analyst										
\$750	Manager										
\$1500	Senior Manager										
R2	Refund Analyst	<p>Credit Hierarchy</p> <table border="1"> <thead> <tr> <th>Threshold Amount</th> <th>To Do Role</th> </tr> </thead> <tbody> <tr> <td>\$500</td> <td>Senior Analyst</td> </tr> <tr> <td>\$750</td> <td>Manager</td> </tr> <tr> <td>\$1500</td> <td>Senior Manager</td> </tr> </tbody> </table>	Threshold Amount	To Do Role	\$500	Senior Analyst	\$750	Manager	\$1500	Senior Manager	No
Threshold Amount	To Do Role										
\$500	Senior Analyst										
\$750	Manager										
\$1500	Senior Manager										

The following table indicates how the system will behave in different refund scenarios:

Refund Request	Refund Request Type	Total Refund Amount (\$)	Comments
RR1	R1	200	This refund request is automatically approved by the system because the total refund amount is less than \$500.
RR2	R1	750	The To Do is sent for approval to the following users in the specified order: <ol style="list-style-type: none"> 1. Users with the Senior Analyst To Do role 2. Users with the Manager To Do role This is because the total refund amount is either equal to \$750 or less than \$1500 and hierarchical approval is required.
RR3	R1	2000	The To Do is sent for approval to the following users in the specified order: <ol style="list-style-type: none"> 1. Users with the Senior Analyst To Do role 2. Users with the Manager To Do role 3. Users with the Senior Manager To Do role This is because the total refund amount is greater than \$1500 and hierarchical approval is required.
RR4	R2	200	This refund request is automatically approved by the system because the total refund amount is less than \$500.
RR5	R2	750	The To Do is sent for approval to users with the Manager To Do role. This is because the total refund amount is either equal to \$750 or less than \$1500 and hierarchical approval is not required.
RR6	R2	2000	The To Do is sent for approval to users with the Senior Manager To Do role. This is because the total refund amount is greater than \$1500 and hierarchical approval is not required.

Example 2

Write Off Request Type	Approval Profile	Approval Hierarchy	Hierarchical Approval								
W1	Write Off Analyst	Debit Hierarchy <table border="1" style="width: 100%; border-collapse: collapse;"> <thead> <tr> <th>Threshold Amount</th> <th>To Do Role</th> </tr> </thead> <tbody> <tr> <td>\$100</td> <td>Senior Analyst</td> </tr> <tr> <td>\$200</td> <td>Manager</td> </tr> <tr> <td>\$300</td> <td>Senior Manager</td> </tr> </tbody> </table>	Threshold Amount	To Do Role	\$100	Senior Analyst	\$200	Manager	\$300	Senior Manager	Yes
Threshold Amount	To Do Role										
\$100	Senior Analyst										
\$200	Manager										
\$300	Senior Manager										

Write Off Request Type	Approval Profile	Approval Hierarchy	Hierarchical Approval								
W2	Write Off Analyst	<u>Debit Hierarchy</u> <table border="1"> <thead> <tr> <th>Threshold Amount</th> <th>To Do Role</th> </tr> </thead> <tbody> <tr> <td>\$100</td> <td>Senior Analyst</td> </tr> <tr> <td>\$200</td> <td>Manager</td> </tr> <tr> <td>\$300</td> <td>Senior Manager</td> </tr> </tbody> </table>	Threshold Amount	To Do Role	\$100	Senior Analyst	\$200	Manager	\$300	Senior Manager	No
Threshold Amount	To Do Role										
\$100	Senior Analyst										
\$200	Manager										
\$300	Senior Manager										

The following table indicates how the system will behave in different write off scenarios:

Write Off Request	Write Off Request Type	Total Write Off Amount (\$)	Comments
WO1	W1	90	This write off request is automatically approved by the system because the total write off amount is less than \$100.
WO2	W1	250	<p>The To Do is sent for approval to the following users in the specified order:</p> <ol style="list-style-type: none"> 1. Users with the Senior Analyst To Do role 2. Users with the Manager To Do role <p>This is because the total write off amount is either equal to \$200 or less than \$300 and hierarchical approval is required.</p>
WO3	W1	500	<p>The To Do is sent for approval to the following users in the specified order:</p> <ol style="list-style-type: none"> 1. Users with the Senior Analyst To Do role 2. Users with the Manager To Do role 3. Users with the Senior Manager To Do role <p>This is because the total write off amount is greater than \$300 and hierarchical approval is required.</p>
WO4	W2	90	This write off request is automatically approved by the system because the total write off amount is less than \$100.
WO5	W2	250	The To Do is sent for approval to users with the Manager To Do role. This is because the total write off amount is either equal to \$200 or less than \$300 and hierarchical approval is not required.
WO6	W2	500	The To Do is sent for approval to users with the Senior Manager To Do role. This is because the total write off amount is greater than \$300 and hierarchical approval is not required.

The **Refund/Write Off Request Type** screen allows you to define, edit, delete, and copy a refund and write off request type. This screen consists of the following zones:

- [Refund/Write Off Request Type List](#) on page 2518

- [Refund/Write Off Request Type](#) on page 2518

Refund/Write Off Request Type List

The **Refund/Write Off Request Type List** zone lists refund and write off request types that are already defined in the system. It contains the following columns:

Column Name	Column Description
Refund/Write Off Request Type	Displays the refund or write off request type.
Description	Displays the description of the refund or write off request type.
Edit	On clicking the Edit (✎) icon, the Refund/Write Off Request Type screen appears where you can edit the details of the refund and write off request type.
Duplicate	On clicking the Duplicate (📄) icon, the Refund/Write Off Request Type screen appears where you can define a refund and write off request type using an existing refund and write off request type.
Delete	On clicking the Delete (🗑) icon, you can delete the refund or write off request type. Note: You can delete a refund or write off request type when you have not created a refund or write off request using the refund or write off request type.

On clicking the **Broadcast** (📡) icon corresponding to refund or write off request type, the **Refund/Write Off Request Type** zone appears with the details of the respective refund or write off request type.

Related Topics

For more information on...	See...
How to define a refund or write off request type	Defining a Refund or Write Off Request Type on page 2521
How to edit a refund or write off request type	Editing a Refund or Write Off Request Type on page 2525
How to copy a refund or write off request type	Copying a Refund or Write Off Request Type on page 2528
How to delete a refund or write off request type	Deleting a Refund or Write Off Request Type on page 2532
How to view the details of a refund or write off request type	Viewing the Refund or Write Off Request Type Details on page 2533

Refund/Write Off Request Type

The **Refund/Write Off Request Type** zone displays the details of the refund or write off request type. This zone consists of the following sections:

- **Main** — This section provides basic information about the refund or write off request type. It contains the following fields:

Field Name	Field Description
Refund/Write Off Request Type	Displays the refund or write off request type.
Refund/Write Off Request Business Object	Indicates the business object that will be used to create the refund or write off request.

Field Name	Field Description
	Note: It has a link. On clicking the link, the Business Object screen appears with the details of the respective business object.
Description	Displays the description of the refund or write off request type.
Detailed Description	Displays additional information about the refund or write off request type.
Status	Indicates the status of the refund or write off request type. The valid values are: <ul style="list-style-type: none"> • Active • Inactive
Action	Indicates whether the request type is created for refund or write off. The valid values are: <ul style="list-style-type: none"> • Refund • Write Off
Minimum Refund Amount	Displays the minimum refund amount. Note: This field appears when the Action field is set to Refund .
Write Up Adjustment Type	Indicates the adjustment type using which the write up adjustment must be created when the total refund amount is less than the minimum refund amount. Note: This field appears when the Action field is set to Refund .
Approval Required	Indicates whether approval is required while creating the refund or write off adjustments using the refund or write off request type.
Approval Profile	Indicates the approval profile which must be used to define approval hierarchy for the refund or write off request type. Note: This field appears when the Approval Required check box is selected. It has a link. On clicking the link, the Approval Profile screen appears with the details of the respective approval profile.
Hierarchical Approval	Indicates whether multi-level or single approval is required while creating the refund or write off adjustments using the refund or write off request type. Note: This field appears when the Approval Required check box is selected.
Adjustment Type	Indicates the adjustment type using which the refund or write off adjustments must be created.

Field Name	Field Description
	Note: It has a link. On clicking the link, the Adjustment Type screen appears with the details of the respective adjustment type.

- **Characteristics** — This section lists the characteristics of the refund or write off request type. It contains the following columns:

Column Name	Column Description
Characteristic Type	Indicates the characteristic type.
Characteristic Value	Displays the value of the characteristic type.

- **Record Actions** — This section contains the following buttons:

Button Name	Button Description
Edit	Used to edit the details of the refund or write off request type.
Delete	Used to delete the refund or write off request type. Note: You can delete a refund or write off request type when you have not created a refund or write off request using the refund or write off request type.
Duplicate	Used to create a new refund or write off request type using an existing refund or write off request type.

- **Record Information** — This section contains the following fields:

Field Name	Field Description
Business Object	Indicates the business object using which the refund or write off request type is created. In addition, a context menu appears corresponding to this field which helps in navigating to other screens in the application. Note: It has a link. On clicking the link, the Business Object screen appears where you can view the details of the respective business object.

By default, the **Refund/Write Off Request Type** zone does not appear in the **Refund/Write Off Request Type** screen. It appears when you click the **Broadcast** (📡) icon corresponding to the refund or write off request type in the **Refund/Write Off Request Type List** zone.

Related Topics

For more information on...	See...
How to define a refund or write off request type	Defining a Refund or Write Off Request Type on page 2521
How to edit a refund or write off request type	Editing a Refund or Write Off Request Type on page 2525
How to copy a refund or write off request type	Copying a Refund or Write Off Request Type on page 2528
How to delete a refund or write off request type	Deleting a Refund or Write Off Request Type on page 2532
How to view the details of a refund or write off request type	Viewing the Refund or Write Off Request Type Details on page 2533

Defining a Refund or Write Off Request Type

Prerequisites

To define a refund or write off request type, you should have:

- Refund or Write Off request business objects defined in the application
- Approval profiles defined in the application
- Adjustment types with and without A/P request type defined in the application

Procedure

To define a refund or write off request type:

1. Click the **Admin** link in the **Application** toolbar.
A list appears.
2. From the **Admin** menu, select **R** and then click **Refund/Write Off Request Type**.
A sub-menu appears.
3. Click the **Add** option from the **Refund/Write Off Request Type** sub-menu.

The **Select Business Object** screen appears. It contains the following fields:

Field Name	Field Description	Mandatory (Yes or No)
Refund/Write Off Request Type Business Object	Used to indicate the business object that you want to use to create the refund or write off request type.	Yes

Tip: Alternatively, you can access the **Select Business Object** screen by clicking the **Add** button in the **Page Title** area of the **Refund/Write Off Request Type** screen.

Note: The **Select Business Object** screen appears when there are multiple refund and write off request type business objects defined in the application. If there is only one refund and write off request type business object defined in the application, the **Refund/Write Off Request Type** screen appears.

4. Select the required refund and write off request type business object from the respective field.
5. Click **OK**.

The **Refund/Write Off Request Type** screen appears. It contains the following sections:

- **Main** - Used to specify basic details about the refund or write off request type.
- **Characteristics** - Used to define the characteristics for the refund or write off request type.

The **Main** section contains the following fields:

Field Name	Field Description	Mandatory (Yes or No)
Refund/Write Off Request Type	Used to specify the refund or write off request type.	Yes
Business Object	Indicates the refund and write off request type business object used while defining the refund or write off request type.	Not applicable
Refund/Write Off Request Business Object	Used to indicate the business object that you want to use while creating the refund or write off request.	Yes

Field Name	Field Description	Mandatory (Yes or No)
Description	Used to specify the description for the refund or write off request type.	Yes
Detailed Description	Used to specify additional information about the refund or write off request type.	No
Status	<p>Used to indicate the status of the refund or write off request type. The valid values are:</p> <ul style="list-style-type: none"> • Active • Inactive <p>Note: You cannot change the status of a refund or write off request type to Inactive if there are refund or write off requests which are created using the refund or write off request type and are currently in the Draft or Approval In Progress status.</p>	Yes
Action	<p>Used to indicate whether the request type is created for refund or write off. The valid values are:</p> <ul style="list-style-type: none"> • Refund • Write Off 	Yes
Minimum Refund Amount	<p>Used to specify the minimum refund amount. This field is used to define tolerance limit for refund. If the total refund amount in a refund request is less than the minimum refund amount, the system creates a write up adjustment. However, if the total refund amount in a refund request is equal to or greater than the minimum refund amount, the system creates a refund adjustment.</p> <p>Note: This field appears when the Action field is set to Refund.</p>	Yes
Write Up Adjustment Type	Used to indicate the adjustment type using which the write up adjustment must be created when the total refund amount is less than the minimum refund amount.	Yes

Field Name	Field Description	Mandatory (Yes or No)
	<p>Note:</p> <p>This field appears when the Action field is set to Refund.</p> <p>You can create write up adjustments only using those adjustment types where A/P request type is not defined.</p>	
Approval Required	Used to indicate whether approval is required while creating the refund or write off adjustments using the refund or write off request type.	No
Approval Profile	Used to indicate the approval profile which must be used to define approval hierarchy for the refund or write off request type.	Yes (Conditional)
	<p>Note: This field appears when the Approval Required check box is selected.</p>	<p>Note: This field is required when the Approval Required check box is selected.</p>
Hierarchical Approval	Used to indicate whether multi-level or single-level approval is required while creating the refund or write off adjustments using the refund or write off request type.	No
	<p>Note: This field appears only when the Approval Required check box is selected.</p>	
Refund Adjustment Type	<p>Used to indicate the adjustment type using which the refund adjustments must be created. This default adjustment type appears when you select the payments or credit bill line items for refund. You can then change the adjustment type, if required, while editing a refund request.</p> <p>Note:</p> <p>This field appears when the Action field is set to Refund.</p> <p>The list includes only those adjustment types where A/P request type is defined.</p>	Yes
Write Off Adjustment Type	Used to indicate the adjustment type using which the write off adjustments must be created. This default adjustment type appears when you select the debit bill line items for write off. You can then	Yes

Field Name	Field Description	Mandatory (Yes or No)
	change the adjustment type, if required, while editing a write off request.	
	<p>Note:</p> <p>This field appears when the Action field is set to Write Off.</p> <p>You can create write off adjustments only using those adjustment types where A/P request type is not defined.</p>	

- Enter the required details depending on whether you want to define refund or write off request type.

Note: You can search for an adjustment type by clicking the **Search** (🔍) icon corresponding to the respective field.

- Define characteristics for the refund or write off request type, if required.
- Click **Save**.

The refund or write off request type is defined.

Related Topics

For more information on...	See...
Refund/Write Off Request Type screen	Refund/Write Off Request Type on page 2514
How to define a characteristic for a refund or write off request type	Defining a Characteristic for a Refund or Write Off Request Type on page 2524

Defining a Characteristic for a Refund or Write Off Request Type

Prerequisites

To define a characteristic for a refund or write off request type, you should have:

- Characteristic types defined in the application (where the characteristic entity is set to **Refund Write Off Request Type**)

Procedure

To define a characteristic for a refund or write off request type:

- Ensure that the **Characteristics** section is expanded when you are defining, editing, or copying a refund or write off request type.

The **Characteristics** section contains the following fields:

Field Name	Field Description	Mandatory (Yes or No)
Characteristic Type	Used to indicate the characteristic type.	Yes (Conditional)
	<p>Note: The list includes only those characteristic types where the characteristic entity is set to Refund Write Off Request Type.</p>	<p>Note: This field is required when you are defining a characteristic for the refund or write off request type.</p>

Field Name	Field Description	Mandatory (Yes or No)
Characteristic Value	Used to specify the value for the characteristic type.	Yes (Conditional)
	Note: On specifying the value for a predefined characteristic type, the description of the characteristic value appears corresponding to the Characteristic Value field.	Note: This field is required when you are defining a characteristic for the refund or write off request type.

- Enter the required details in the **Characteristics** section.

Note: If you select a predefined characteristic type, the **Search** (🔍) icon appears corresponding to the **Characteristic Value** field. On clicking the **Search** icon, you can search for a predefined characteristic value.

- If you want to define more than one characteristic for the refund or write off request type, click the **Add** (+) icon and then repeat step 2.

Note: However, if you want to remove a characteristic from the refund or write off request type, click the **Delete** (🗑️) icon corresponding to the characteristic.

Related Topics

For more information on...	See...
How to define a refund or write off request type	Defining a Refund or Write Off Request Type on page 2521
How to edit a refund or write off request type	Editing a Refund or Write Off Request Type on page 2525
How to copy a refund or write off request type	Copying a Refund or Write Off Request Type on page 2528

Editing a Refund or Write Off Request Type

Prerequisites

To edit a refund or write off request type, you should have:

- Refund or Write Off request business objects defined in the application
- Approval profiles defined in the application
- Adjustment types with and without A/P request type defined in the application

Procedure

To edit a refund or write off request type:

- Click the **Admin** link in the **Application** toolbar.
A list appears.
- From the **Admin** menu, select **R** and then click **Refund/Write Off Request Type**.
A sub-menu appears.
- Click the **Search** option from the **Refund/Write Off Request Type** sub-menu.
The **Refund/Write Off Request Type** screen appears.
- In the **Refund/Write Off Request Type List** zone, click the **Edit** (✎) icon in the **Edit** column corresponding to the refund or write off request type whose details you want to edit.

The **Refund/Write Off Request Type** screen appears. It contains the following sections:

- **Main** - Used to specify basic details about the refund or write off request type.
- **Characteristics** - Used to define the characteristics for the refund or write off request type.

The **Main** section contains the following fields:

Field Name	Field Description	Mandatory (Yes or No)
Refund/Write Off Request Type	Displays the refund or write off request type.	Not applicable
Business Object	Indicates the refund and write off request type business object used while defining the refund or write off request type.	Not applicable
Refund/Write Off Request Business Object	Used to indicate the business object that you want to use while creating the refund or write off request.	Yes
Description	Used to specify the description for the refund or write off request type.	Yes
Detailed Description	Used to specify additional information about the refund or write off request type.	No
Status	<p>Used to indicate the status of the refund or write off request type. The valid values are:</p> <ul style="list-style-type: none"> • Active • Inactive <p>Note: You cannot change the status of a refund or write off request type to Inactive if there are refund or write off requests which are created using the refund or write off request type and are currently in the Draft or Approval In Progress status.</p>	Yes
Action	<p>Indicates whether the request type is created for refund or write off. The valid values are:</p> <ul style="list-style-type: none"> • Refund • Write Off 	Not applicable
Minimum Refund Amount	Used to specify the minimum refund amount. This field is used to define tolerance limit for refund. If the total refund amount in a refund request is less than the minimum refund amount, the system creates a write up adjustment. However, if the total refund amount in a refund request is equal to or greater than the minimum refund amount, the system creates a refund adjustment.	Yes

Field Name	Field Description	Mandatory (Yes or No)
	Note: This field appears when the Action field is set to Refund .	
Write Up Adjustment Type	Used to indicate the adjustment type using which the write up adjustment must be created when the total refund amount is less than the minimum refund amount. Note: This field appears when the Action field is set to Refund . You can create write up adjustments only using those adjustment types where A/P request type is not defined.	Yes
Approval Required	Used to indicate whether approval is required while creating the refund or write off adjustments using the refund or write off request type.	No
Approval Profile	Used to indicate the approval profile which must be used to define approval hierarchy for the refund or write off request type. Note: This field appears when the Approval Required check box is selected.	Yes (Conditional) Note: This field is required when the Approval Required check box is selected.
Hierarchical Approval	Used to indicate whether multi-level or single-level approval is required while creating the refund or write off adjustments using the refund or write off request type. Note: This field appears only when the Approval Required check box is selected.	No
Refund Adjustment Type	Used to indicate the adjustment type using which the refund adjustments must be created. This default adjustment type appears when you select the payments or credit bill line items for refund. You can then change the adjustment type, if required, while editing a refund request.	Yes

Field Name	Field Description	Mandatory (Yes or No)
	<p>Note:</p> <p>This field appears when the Action field is set to Refund.</p> <p>The list includes only those adjustment types where A/P request type is defined.</p>	
Write Off Adjustment Type	<p>Used to indicate the adjustment type using which the write off adjustments must be created. This default adjustment type appears when you select the debit bill line items for write off. You can then change the adjustment type, if required, while editing a write off request.</p> <p>Note:</p> <p>This field appears when the Action field is set to Write Off.</p> <p>You can create write off adjustments only using those adjustment types where A/P request type is not defined.</p>	Yes

Tip: Alternatively, you can click the **Edit** button in the **Refund/Write Off Request Type** zone to edit the details of the refund or write off request type.

- Modify the required details in the **Main** section.

Note: You can search for an adjustment type by clicking the **Search** (🔍) icon corresponding to the respective field.

- Define, edit, or remove characteristics of the refund or write off request type, if required.
- Click **Save**.

The changes made to the refund or write off request type are saved.

Related Topics

For more information on...	See...
Refund/Write Off Request Type screen	Refund/Write Off Request Type on page 2514
Refund/Write Off Request Type List zone	Refund/Write Off Request Type List on page 2518
Refund/Write Off Request Type zone	Refund/Write Off Request Type on page 2518
How to define a characteristic for a refund or write off request type	Defining a Characteristic for a Refund or Write Off Request Type on page 2524

Copying a Refund or Write Off Request Type

Instead of creating a refund or write off request type from scratch, you can create a new refund or write off request type using an existing refund or write off request type. This is possible through copying a refund or write off request type.

On copying a refund or write off request type, the details including the characteristics are copied to the new refund or write off request type. You can then edit the details, if required.

Prerequisites

To copy a refund or write off request type, you should have:

- Refund or Write Off request type (whose copy you want to create) defined in the application
- Refund or Write Off request business objects defined in the application
- Approval profiles defined in the application
- Adjustment types with and without A/P request type defined in the application

Procedure

To copy a refund or write off request type:

1. Click the **Admin** link in the **Application** toolbar.

A list appears.

2. From the **Admin** menu, select **R** and then click **Refund/Write Off Request Type**.

A sub-menu appears.

3. Click the **Search** option from the **Refund/Write Off Request Type** sub-menu.

The **Refund/Write Off Request Type** screen appears.

4. In the **Refund/Write Off Request Type List** zone, click the **Duplicate**  icon in the **Duplicate** column corresponding to the refund or write off request type whose copy you want to create.

The **Refund/Write Off Request Type** screen appears. It contains the following sections:

- **Main** - Used to specify basic details about the refund or write off request type.
- **Characteristics** - Used to define the characteristics for the refund or write off request type.

The **Main** section contains the following fields:

Field Name	Field Description	Mandatory (Yes or No)
Refund/Write Off Request Type	Used to specify the refund or write off request type.	Yes
Business Object	Indicates the refund and write off request type business object used while defining the refund or write off request type.	Not applicable
Refund/Write Off Request Business Object	Used to indicate the business object that you want to use while creating the refund or write off request.	Yes
Description	Used to specify the description for the refund or write off request type.	Yes
Detailed Description	Used to specify additional information about the refund or write off request type.	No
Status	Used to indicate the status of the refund or write off request type. The valid values are: <ul style="list-style-type: none"> • Active 	Yes

Field Name	Field Description	Mandatory (Yes or No)
	<ul style="list-style-type: none"> Inactive <p>Note: You cannot change the status of a refund or write off request type to Inactive if there are refund or write off requests which are created using the refund or write off request type and are currently in the Draft or Approval In Progress status.</p>	
Action	<p>Used to indicate whether the request type is created for refund or write off. The valid values are:</p> <ul style="list-style-type: none"> Refund Write Off 	Yes
Minimum Refund Amount	<p>Used to specify the minimum refund amount. This field is used to define tolerance limit for refund. If the total refund amount in a refund request is less than the minimum refund amount, the system creates a write up adjustment. However, if the total refund amount in a refund request is equal to or greater than the minimum refund amount, the system creates a refund adjustment.</p> <p>Note: This field appears when the Action field is set to Refund.</p>	Yes
Write Up Adjustment Type	<p>Used to indicate the adjustment type using which the write up adjustment must be created when the total refund amount is less than the minimum refund amount.</p> <p>Note: This field appears when the Action field is set to Refund. You can create write up adjustments only using those adjustment types where A/P request type is not defined.</p>	Yes
Approval Required	Used to indicate whether approval is required while creating the refund or write off adjustments using the refund or write off request type.	No
Approval Profile	Used to indicate the approval profile which must be used to define approval hierarchy for the refund or write off request type.	Yes (Conditional)

Field Name	Field Description	Mandatory (Yes or No)
	Note: This field appears when the Approval Required check box is selected.	Note: This field is required when the Approval Required check box is selected.
Hierarchical Approval	Used to indicate whether multi-level or single-level approval is required while creating the refund or write off adjustments using the refund or write off request type. Note: This field appears only when the Approval Required check box is selected.	No
Refund Adjustment Type	Used to indicate the adjustment type using which the refund adjustments must be created. This default adjustment type appears when you select the payments or credit bill line items for refund. You can then change the adjustment type, if required, while editing a refund request. Note: This field appears when the Action field is set to Refund . The list includes only those adjustment types where A/P request type is defined.	Yes
Write Off Adjustment Type	Used to indicate the adjustment type using which the write off adjustments must be created. This default adjustment type appears when you select the debit bill line items for write off. You can then change the adjustment type, if required, while editing a write off request. Note: This field appears when the Action field is set to Write Off . You can create write off adjustments only using those adjustment types where A/P request type is not defined.	Yes

Tip: Alternatively, you can click the **Duplicate** button in the **Refund/Write Off Request Type** zone to create a copy of the refund or write off request type.

5. Enter the required details in the **Main** section.

Note: You can search for an adjustment type by clicking the **Search** (🔍) icon corresponding to the respective field.

6. Define, edit, or remove characteristics of the refund or write off request type, if required.
7. Click **Save**.

The new refund or write off request type is defined.

Related Topics

For more information on...	See...
Refund/Write Off Request Type screen	Refund/Write Off Request Type on page 2514
Refund/Write Off Request Type List zone	Refund/Write Off Request Type List on page 2518
Refund/Write Off Request Type zone	Refund/Write Off Request Type on page 2518
How to define a characteristic for a refund or write off request type	Defining a Characteristic for a Refund or Write Off Request Type on page 2524

Deleting a Refund or Write Off Request Type

Procedure

To delete a refund or write off request type:

1. Click the **Admin** link in the **Application** toolbar.
A list appears.
2. From the **Admin** menu, select **R** and then click **Refund/Write Off Request Type**.
A sub-menu appears.
3. Click the **Search** option from the **Refund/Write Off Request Type** sub-menu.
The **Refund/Write Off Request Type** screen appears.
4. In the **Refund/Write Off Request Type List** zone, click the **Delete** (🗑️) icon in the **Delete** column corresponding to the refund or write off request type that you want to delete.
A message appears confirming whether you want to delete the refund or write off request type.

Note: You can delete a refund or write off request type when you have not defined a refund or write off request using the refund or write off request type.

Tip: Alternatively, you can click the **Delete** button in the **Refund/Write Off Request Type** zone to delete the refund or write off request type.

5. Click **OK**.

The refund or write off request type is deleted.

Related Topics

For more information on...	See...
Refund/Write Off Request Type screen	Refund/Write Off Request Type on page 2514
Refund/Write Off Request Type List zone	Refund/Write Off Request Type List on page 2518
Refund/Write Off Request Type zone	Refund/Write Off Request Type on page 2518

Viewing the Refund or Write Off Request Type Details

Procedure

To view the details of a refund or write off request type:

1. Click the **Admin** link in the **Application** toolbar.
A list appears.
2. From the **Admin** menu, select **R** and then click **Refund/Write Off Request Type**.
A sub-menu appears.
3. Click the **Search** option from the **Refund/Write Off Request Type** sub-menu.
The **Refund/Write Off Request Type** screen appears.
4. In the **Refund/Write Off Request Type List** zone, click the **Broadcast** () icon corresponding to the refund or write off request type whose details you want to view.
The **Refund/Write Off Request Type** zone appears.
5. View the details of the refund or write off request type in the **Refund/Write Off Request Type** zone.

Related Topics

For more information on...	See...
Refund/Write Off Request Type screen	Refund/Write Off Request Type on page 2514
Refund/Write Off Request Type List zone	Refund/Write Off Request Type List on page 2518
Refund/Write Off Request Type zone	Refund/Write Off Request Type on page 2518

Refund/Write Off Request

The **Refund/Write Off Request** screen allows you to search for a refund and write off request using various search criteria. It also allows you to create a refund and write off requests. Through this screen, you can navigate to the following screens:

- [Refund Request](#) on page 2545
- [Write Off Request](#) on page 2578

This screen consists of the following zones:

- [Search Refund/Write Off Request](#) on page 2533

Search Refund/Write Off Request

The **Search Refund/Write Off Request** zone allows you to search for refund and write off requests using various search criteria. This zone contains the following two sections:

- **Search Criteria** — The **Search Criteria** section contains the following fields:

Field Name	Field Description	Mandatory (Yes or No)
Search By	<p>Used to indicate whether you want to search for a refund or write off request using request, payment, or bill details. The valid values are:</p> <ul style="list-style-type: none"> • Request Details — Used when you want to search for refund and/or write off requests. • Payment Details — Used when you want to search for refund requests. • Bill Details — Used when you want to search for refund and/or write off requests. <p>Note: By default, the Request Details option is selected.</p>	Yes
Action	<p>Used to indicate whether you want to search for refund or write off requests. The valid values are:</p> <ul style="list-style-type: none"> • Refund • Write Off <p>Note: This field appears when you select the Request Details or Bill Details option from the Search By list.</p>	No
Refund/Write Off Request Type	<p>Used to search refund or write off requests which are created using a particular refund or write off request type.</p> <p>Note: This field appears when you select the Request Details option from the Search By list. The refund or write off request types are listed when you set the Action field to either Refund or Write Off.</p>	No
Status	<p>Used to search refund or write off requests with a particular status. The valid values are:</p> <ul style="list-style-type: none"> • Approval In Progress • Cancelled • Draft • Processed • Rejected • Voided 	No

Field Name	Field Description	Mandatory (Yes or No)
	<p>Note:</p> <p>This field appears when you select the Request Details option from the Search By list.</p> <p>The Voided status is applicable while searching for refund requests and the Cancelled status is applicable while searching for write off requests.</p>	
User ID	<p>Used to search refund or write off requests which are created by a particular user.</p> <p>Note: This field appears when you select the Request Details option from the Search By list.</p>	No
Created From	<p>Used to search refund or write off requests which are created from a particular date onwards.</p> <p>Note: This field appears when you select the Request Details option from the Search By list.</p>	No
To	<p>Used to search refund or write off requests which are created till a particular date.</p> <p>Note:</p> <p>By default, the current date appears in this field.</p> <p>This field appears when you select the Request Details option from the Search By list.</p>	No
Refund/Write Off Request ID	<p>Used to search a particular refund or write off request.</p> <p>Note: This field appears when you select the Request Details option from the Search By list.</p>	No
Payment Event ID	<p>Used to search refund requests which includes a particular payment event for refund.</p> <p>Note: This field appears when you select the Payment Details option from the Search By list.</p>	No
Payor Account ID	<p>Used to search refund requests which are created for a particular payor account.</p> <p>Note: This field appears when you select the Payment Details option from the Search By list.</p>	No
Payor Name	<p>Used to search refund requests which are created for a particular payor.</p> <p>Note: This field appears when you select the Payment Details option from the Search By list.</p>	No

Field Name	Field Description	Mandatory (Yes or No)
Payment Date	Used to search refund requests which includes payments made on a particular date.	No
	Note: This field appears when you select the Payment Details option from the Search By list.	
MICR ID	Used to search refund requests which includes payments made with a particular MICR code.	No
	Note: This field appears when you select the Payment Details option from the Search By list.	
Check Number	Used to search refund request which includes payment made through a particular check.	No
	Note: This field appears when you select the Payment Details option from the Search By list.	
Bill ID	Used to search refund or write off requests which includes bill segments or adjustments of a particular bill.	No
	Note: This field appears when you select the Bill Details option from the Search By list.	
Bill Date From	Used to search refund or write off requests which includes bill segments or adjustments of bills which are created from a particular date onwards.	No
	Note: This field appears when you select the Bill Details option from the Search By list.	
To	Used to search refund or write off requests which includes bill segments or adjustments of bills which are created till a particular date.	No
	Note: By default, the current date appears in this field. This field appears when you select the Bill Details option from the Search By list.	

Note: You must specify at least one search criterion while searching for a refund or write off request.

- **Search Results** — On clicking the **Search** button, the search results appear based on the specified search criteria. The **Search Results** section contains the following columns:

Column Name	Column Description
Create Date/Time	Displays the date and time when the refund or write off request is created.
Refund/Write Off Request Information	Displays information about the refund or write off request.

Column Name	Column Description
	Note: It has a link. On clicking the link, the Refund Request or Write Off Request screen appears depending on whether the request is for refund or write off.
Status	Indicates the status of the refund or write off request.
Action	Indicates whether the request is created for refund or write off. The valid values are: <ul style="list-style-type: none"> • Refund • Write Off Note: This column appears when you select the Request Details or Bill Details option from the Search By list.
Refund/Write Off Amount	Displays the total refund or write off amount. Note: This column appears when you select the Request Details or Bill Details option from the Search By list.
Refund Amount	Displays the total refund amount. Note: This column appears when you select the Payment Details option from the Search By list.
Account Information	Displays additional information about the account for which the refund or write off request is created. Note: It has a link. On clicking the link, the Account screen appears with the details of the respective account.
Created By	Indicates the user who has created the refund or write off request.

Related Topics

For more information on...	See...
How to search for a refund or write off request	Searching for a Refund or Write Off Request on page 2537
How to view the details of a refund request	Viewing the Refund Request Details on page 2543
How to view the details of a write off request	Viewing the Write Off Request Details on page 2544
How to create a refund request	Creating a Refund Request on page 2538
How to create a write off request	Creating a Write Off Request on page 2541

Searching for a Refund or Write Off Request

Prerequisites

To search for a refund or write off request, you should have:

- Refund or Write Off request types defined in the application

Procedure

To search for a refund or write off request:

1. Click the **Menu** link in the **Application** toolbar.

A list appears.

- From the **Main** menu, select **Accounting and Receivable** and then click **Refund/Write Off Request**.

A sub-menu appears.

- Click the **Search** option from the **Refund/Write Off Request** sub-menu.

The **Refund/Write Off Request** screen appears.

- Enter the search criteria in the **Search Refund/Write Off Request** zone depending on whether you want to search for a refund or write off request.

Note: ORMB search engine supports wildcard search, where you can substitute the percentage (%) symbol as a stand in for any word or letter in a search criteria. You can use the ‘%’ wildcard character in all input fields except the date and ID fields. The ‘%’ wildcard character is suffixed automatically at the end of the partial search criteria. Therefore, you may or may not specify the wildcard character at the end of the partial search criteria. However, you have to prefix the wildcard character manually wherever required.

- Click **Search**.

A list of refund or write off requests that meet the search criteria appears in the **Search Results** section.

Related Topics

For more information on...	See...
Refund/Write Off Request screen	Refund/Write Off Request on page 2533
Search Refund/Write Off Request zone	Search Refund/Write Off Request on page 2533

Creating a Refund Request

Prerequisites

To create a refund request, you should have:

- Refund request types defined in the application

Procedure

To create a refund request:

- Do either of the following:

If you want to...	Then...
Define a refund request from the Account Receivable Central screen	<ol style="list-style-type: none"> Click the Main link in the Application toolbar. A list appears. From the Main menu, select Accounting and Receivable and then click Account Receivable Central. Search for the bill in the Account Receivable Central screen. In the Search Results section, select the required bill and then click Refund.
	Note: Only one bill at a time is allowed to select for Refund Request from the Account Receivable Central screen.

If you want to...	Then...
Define a refund request from the Refund Request screen	<ol style="list-style-type: none"> 1. Click the Main link in the Application toolbar. A list appears. 2. From the Main menu, select Accounting and Receivable and then click Refund/Write Off Request. A sub-menu appears. 3. Click the Add option from the Refund/Write Off Request sub-menu.
Define a refund request from the Payment Event Summary screen	<ol style="list-style-type: none"> 1. Click the Main link in the Application toolbar. A list appears. 2. From the Main menu, select Payments and then click Payment Event Summary. 3. Search for the payment event (whose payments you want to refund) in the Payment Event Summary screen. 4. In the Search Results section, click the Broadcast (📡) icon corresponding to the payment event whose payments you want to view. The Payments zone appears. 5. Select the check box corresponding to the payments that you want to refund. 6. Click the Refund button in the Payments zone.

The **Select Request Type** screen appears. It contains the following fields:

Field Name	Field Description	Mandatory (Yes or No)
Action	<p>Displays the type of request (refund or write off) to be created.</p> <p>Note: This field is pre-populated if the refund request is created from the Account Receivable Central screen. This field is editable if the refund request is created from the Refund/Write Off Request screen.</p>	Not applicable
Refund/Write Off Request Type	<p>Used to indicate the request type using which you want to create the refund or write off request.</p> <p>Note: The refund request types are listed when you set the Action field to Refund and the write off request types are listed when you set the Action field to Write Off.</p>	Yes

Field Name	Field Description	Mandatory (Yes or No)
Account	Used to indicate the account for which you want to create the refund or write off request. Note: This field is pre-populated if the refund request is created from the Account Receivable Central screen. This field is editable if the refund request is created from the Refund/Write Off Request screen. You can search for an account by clicking the Search (🔍) icon corresponding to the respective field.	Yes

Tip:

Alternatively, you can access the **Select Request Type** screen:

- By clicking the **Add** button in the **Page Title** area of **Refund/Write Off Request** screen.
- By selecting the payment which you want to refund in the **Payment Event Summary** screen and then clicking the **Refund** button. Note that the system will allow you to refund only those payments which are in the **Frozen** status and matched against the suspense or excess credit contract.

2. Select the required refund request type from the respective field.

3. Click **Save**.

The refund request is defined and the status of the refund request is set to **Draft**. The **Refund Request** screen appears where you can view the details of the refund request. It contains the following tabs:

Note: The refund request can be created only for bill with outstanding amount lesser than zero.

- **Main** – Displays information about the refund request. It contains the following zones:
 - **Refund Request** – Displays the details of the refund request.
 - **Refund Details** – Lists the entities, such as payment events, payments, and/or credit bill line items (such as credit bill segments and adjustments), of the account which must be refunded.
 - **Payments** – Used to search payment events or individual payments that you want to refund. This tab appears only when the refund request is in the **Draft** status.
 - **Bills** – Used to search bills with credit line items, such as credit bill segments and adjustments, that you want to refund. This tab appears when the refund request is in the **Draft** status.
 - **Log** – Lists the complete trail of actions performed on the refund request.
4. Add payment events, payments, or credit bill line items that you want to refund.
 5. Edit the refund amount of each entity, if required.
 6. Define characteristics for the refund request, if required.
 7. Override the address if you want to sent the refund to an address other than the account’s main customer address.

Related Topics

For more information on...	See...
Refund Request screen	Refund Request on page 2545
Account Receivable Central screen	Account Receivable Central on page 1538
How to add a payment event to the refund request	Adding a Payment Event to the Refund Request on page 2558
How to add a payment to the refund request	Adding a Payment to the Refund Request on page 2559
How to add a credit bill line item to the refund request	Adding a Credit Bill Line Item to the Refund Request on page 2561
How to edit a refund request	Editing a Refund Request on page 2563
How to define a characteristic for a refund request	Defining a Characteristic for a Refund Request on page 2557

Creating a Write Off Request

Prerequisites

To create a write off request, you should have:

- Write off request types defined in the application

Procedure

To create a write off request:

1. Do either of the following:

If you want to...	Then...
Define a write off request from the Account Receivable Central screen	<ol style="list-style-type: none"> 1. Click the Main link in the Application toolbar. A list appears. 2. From the Main menu, select Accounting and Receivable and then click Account Receivable Central. 3. Search for the bill in the Account Receivable Central screen. 4. In the Search Results section, select the required bill and then click Write Off. <p>Note: Only one bill at a time is allowed to select for Write Off Request from the Account Receivable Central screen.</p>
Define a write off request from the Write Off Request screen	<ol style="list-style-type: none"> 1. Click the Main link in the Application toolbar. A list appears. 2. From the Main menu, select Accounting and Receivable and then click Refund/Write Off Request.

If you want to...	Then...
	<p>A sub-menu appears.</p> <p>3. Click the Add option from the Refund/Write Off Request sub-menu.</p>

The **Select Request Type** screen appears. It contains the following fields:

Field Name	Field Description	Mandatory (Yes or No)
Action	<p>Displays the type of request (refund or write off) to be created.</p> <p>Note:</p> <p>This field is pre-populated if the write off request is created from the Account Receivable Central screen.</p> <p>This field is editable if the write off request is created from the Refund/Write Off Request screen.</p>	Yes
Refund/Write Off Request Type	<p>Used to indicate the request type using which you want to create the refund or write off request.</p> <p>Note: The refund request types are listed when you set the Action field to Refund and the write off request types are listed when you set the Action field to Write Off.</p>	Yes
Account	<p>Used to indicate the account for which you want to create the refund or write off request.</p> <p>Note:</p> <p>This field is pre-populated if the write off request is created from the Account Receivable Central screen.</p> <p>This field is editable if the write off request is created from the Refund/Write Off Request screen.</p> <p>You can search for an account by clicking the Search (🔍) icon corresponding to the respective field.</p>	Yes

Tip: Alternatively, you can access the **Select Request Type** screen by clicking the **Add** button in the **Page Title** area of the **Refund/Write Off Request** screen.

2. Select the required write off request type and account from the respective fields.
3. Click **Save**.

The write off request is defined and the status of the write off request is set to **Draft**. The **Write Off Request** screen appears with the details of the write off request. It contains the following tabs:

Note: The write off request can be created only for bill with outstanding amount greater than zero.

- **Main** – Displays information about the write off request. It contains the following zones:
 - **Write Off Request** – Displays the details of the write off request.
 - **Write Off Details** – Lists the debit bill line items (such as debit bill segments and adjustments) of the account which must be written off.
 - **Bills** — Used to search bills with debit line items, such as debit bill segments and adjustments, that you want to write off. This tab appears when the write off request is in the **Draft** status.
 - **Log** – Lists the complete trail of actions performed on the write off request.
4. Add debit bill line items that you want to write off.
 5. Edit the write off amount of each entity, if required.
 6. Define characteristics for the write off request, if required.

Related Topics

For more information on...	See...
Write Off Request screen	Write Off Request on page 2578
Account Receivable Central screen	Account Receivable Central on page 1538
How to add a debit bill line item to the write off request	Adding a Debit Bill Line Item to the Write Off Request on page 2590
How to edit a write off request	Editing a Write Off Request on page 2591
How to define a characteristic for a write off request	Defining a Characteristic for a Write Off Request on page 2588

Viewing the Refund Request Details

Procedure

To view the details of a refund request:

1. Search for the refund request in the **Refund/Write Off Request** screen.
2. In the **Search Results** section, click the link in the **Refund/Write Off Request Information** column corresponding to the refund request whose details you want to view.

The **Refund Request** screen appears. It consists of the following tabs:

- **Main** – Displays information about the refund request. It contains the following zones:
 - **Refund Request** – Displays the details of the refund request.
 - **Refund Details** – Lists the entities, such as payment events, payments, and/or credit bill line items (such as credit bill segments and adjustments), of the account which must be refunded.
- **Payments** — Used to search payment events or individual payments that you want to refund. This tab appears only when the refund request is in the **Draft** status.
- **Bills** — Used to search bills with credit line items, such as credit bill segments and adjustments, that you want to refund. This tab appears when the refund request is in the **Draft** status.

- **Log** – Lists the complete trail of actions performed on the refund request.
3. View the details of the refund request in the **Refund Request** zone.
 4. View the entities (such as payment events, payments, or credit bill line items) which must be refunded in the **Refund Details** zone.

Related Topics

For more information on...	See...
Refund Request screen	Refund Request on page 2545
Refund Request zone	Refund Request on page 2545
Refund Details zone	Refund Details on page 2548
How to search for a refund request	Searching for a Refund or Write Off Request on page 2537

Viewing the Write Off Request Details

Procedure

To view the details of a write off request:

1. Search for the write off request in the **Refund/Write Off Request** screen.
2. In the **Search Results** section, click the link in the **Refund/Write Off Request Information** column corresponding to the write off request whose details you want to view.

The **Write Off Request** screen appears. It consists of the following tabs:

- **Main** – Displays information about the write off request. It contains the following zones:
 - **Write Off Request** – Displays the details of the write off request.
 - **Write Off Details** – Lists the debit bill line items, such as debit bill segments and adjustments, of the account which must be written off.
 - **Bills** — Used to search bills with debit line items, such as debit bill segments and adjustments, that you want to write off. This tab appears when the write off request is in the **Draft** status.
 - **Log** – Lists the complete trail of actions performed on the write off request.
3. View the details of the write off request in the **Write Off Request** zone.
 4. View the entities (such as debit bill segments and adjustments) which must be written off in the **Write Off Details** zone.

Related Topics

For more information on...	See...
Write Off Request screen	Write Off Request on page 2578
Write Off Request zone	Write Off Request on page 2579
Write Off Details zone	Write Off Details on page 2581
How to search for a write off request	Searching for a Refund or Write Off Request on page 2537

Refund Request

Once you create a refund request, the **Refund Request** screen allows you to:

- Edit and delete a refund request
- View the details of a refund request
- Submit a refund request for approval
- Approve or reject a refund request
- View the log of a refund request
- Add a log entry for a refund request
- Void a refund request

This screen consists of the following tabs:

- **Main** – Displays information about the refund request. It contains the following zones:
 - **Refund Request** – Displays the details of the refund request.
 - **Refund Details** – Lists the entities, such as payment events, payments, and/or credit bill line items (such as credit bill segments and adjustments), of the account which must be refunded.
 - **Bill Line Items** — Displays the details of the bill which must be refunded.

Note: This zone appears when you click the Broadcast () icon corresponding to the entity type as **Bill** in the **Refund Details** zone.

- **Bills** — Used to search bills with credit line items, such as credit bill segments and adjustments, that you want to refund. It contains the following zones:
 - **Search Bills** — Lists completed bills of the account which are either with credit balance or have one or more credit line items, such as bill segments and adjustments. You can filter the bills using various search criteria.
 - **Bill Line Items** — Lists the debit and credit bill segments and adjustments of the bill.

This tab appears when the refund request is in the **Draft** status.

- **Payments** — Used to search payment events or individual payments that you want to refund. It contains the following zones:
 - **Search Payment Event** — Lists the payment events which are created for the account. You can filter the payment events using various search criteria.
 - **Payments** — Lists all payments created through the payment event.

This tab appears when the refund request is in the **Draft** status.

- **Log** – Lists the complete trail of actions performed on the refund request.

Refund Request - Main

The **Main** tab displays information about the refund request. It contains the following zones:

- [Refund Request](#) on page 2545
- [Refund Details](#) on page 2548
- [Bill Line Items](#) on page 2549

Refund Request

The **Refund Request** zone displays the details of the refund request. This zone contains the following sections:

- **Main** — This section provides basic information about the refund request. It contains the following fields:

Field Name	Field Description
Refund Request Information	Displays information about the refund request.
Refund Request Type	Indicates the refund request type using which the refund request is created. Note: It has a link. On clicking the link, the Refund/Write Off Request Type screen appears where you can view the details of the refund request type.
Status	Indicates the status of the refund request. The valid values are: <ul style="list-style-type: none"> • Draft • Approval In Progress • Rejected • Processed • Voided
Status Reason	Indicates the reason why the refund request is rejected or voided. Note: This field appears when the refund request is in the Rejected or Voided status. It has a link. On clicking the link, the Status Reason screen appears where you can view the details of the rejected or voided reason.
Account Information	Indicates the account for which the refund request is created. Note: It has a link. On clicking the link, the Account screen appears where you can view the details of the respective account.
Person Name	Indicates the person for whom the refund request is created.
Override Address	Indicates whether the account's mailing address is overridden.
Address 1	Displays the house number and apartment name.
Address 2	Displays the street name.
Address 3	Indicates the landmark, if available.
Address 4	Displays the village, town, or city name.
City	Displays the city name.
State	Displays the state name.
Country	Displays the country name.
Postal	Displays the postal or zip code.
Comments	Displays additional information about the refund request.
Total Refund Amount	Displays the total refund amount.

- **Characteristics** — Lists the characteristics defined for the refund request. It contains the following fields:

Field Name	Field Description
Effective Date	Indicates the date from when the characteristic is effective for the refund request.
Characteristic Type	Indicates the characteristic type.
Characteristic Value	Displays the value of the characteristic type.

- **Record Actions** — This section contains the following buttons:

Button Name	Button Description
Edit	Used to edit the details of the refund request.
	Note: The Edit button appears when the refund request is in the Draft status.
Delete	Used to delete the refund request.
	Note: The Delete button appears when the refund request is in the Draft status.
Submit	Used to submit the refund request for approval.
	Note: The Submit button appears when the refund request is in the Draft status.
Approve	Used to approve the refund request.
	Note: The Approve button appears when: <ul style="list-style-type: none"> • The refund request is in the Approval In Progress status. • A user with the approval To Do role is reviewing the refund request.
Reject	Used to reject the refund request.
	Note: The Reject button appears when: <ul style="list-style-type: none"> • The refund request is in the Approval In Progress status. • A user with the approval To Do role is reviewing the refund request.
Void	Used to void the refund request.
	Note: The Void button appears when the refund request is in the Processed status.

- **Record Information** — This section contains the following fields:

Field Name	Field Description
Business Object	Indicates the business object using which the refund request is created. In addition, a context menu appears corresponding to this field which helps in navigating to other screens in the application.
	Note: It has a link. On clicking the link, the Business Object screen appears where you can view the details of the respective business object.

Field Name	Field Description
Status Date/Time	Displays the date and time when the refund request status is updated
Create Date/Time	Displays the date and time when the refund request is created.

Refund Details

The **Refund Details** zone lists the payment events, payments, and credit bill line items (such as bill segments and adjustments) that you have added to the refund request. This zone contains the following columns:

Column Name	Column Description
Entity ID	Displays the entity ID.
Entity Type	Indicates whether the entity is a payment event, payment, bill, bill segment, or an adjustment.
Currency	Indicates the currency in which the entity was created.
Entity Amount	Displays the entity amount.
Refund Amount	Displays the amount that must be refunded. Note: By default, the amount which is eligible for refund appears in this column. You can edit the amount, if required. However, you cannot specify the amount greater than the eligible amount.
Contract Information	Displays additional information about the contract against which the bill segment or adjustment is created or against which the payment is matched. In addition, this column has a context menu which helps in navigating to other screens in the application. Note: It has a link. On clicking the link, the Contract screen appears where you can view the details of the respective contract.
Adjustment Type	Indicates the adjustment type using which the refund adjustment must be created. Note: By default, the adjustment type specified in the refund request type appears in this column. You can change the adjustment type, if required, by editing the refund request.
Adjustment Information	Displays information about the refund adjustment. Note: It has a link. On clicking the link, the Adjustment screen appears where you can view the details of the respective adjustment. The data appears in this column when the status of the refund request is Processed . The information string appears when an algorithm of the C1-ADI-INFO algorithm type is attached to the Adjustment Information system event in the Algorithms tab of the Installation Options — Framework screen.

Note: On clicking the Broadcast (📡) icon corresponding to the entity type as **Bill**, the **Bill Line Items** zone appears with the details of the respective bill.

In addition to above columns, this screen contains following buttons:

Button Name	Button Description
Edit	Used to edit the details of bill line items.
Delete	Used to delete the bill line items.

Bill Line Items

The **Bill Line Items** zone lists the debit and credit bill segments and adjustments of the bill. This zone contains the following columns:

Column Name	Column Description
Bill ID	Displays the bill ID.
Entity ID	Displays the bill segment or adjustment ID.
Entity Type	Indicates whether the entity is a bill, bill segment or an adjustment.
Currency	Displays the currency in which the entity was created.
Entity Amount	Displays the bill segment or adjustment amount.
Request Amount	Displays the bill segment or adjustment amount which is eligible for refund. In other words, it means entity amount minus amount refunded.
	Note: If the bill segment or adjustment has debit balance, the eligible amount for refund would be zero.
Contract Information	Displays additional information about the contract against which the bill segment or adjustment is created. In addition, this column has a context menu which helps in navigating to other screens in the application.
	Note: It has a link. On clicking the link, the Contract screen appears where you can view the details of the respective contract.
Adjustment Type	Indicates the adjustment type using which the refund adjustment must be created.
	Note: It has a link. On clicking the link, the Adjustment Type screen appears where you can view the details of the respective adjustment type.
Adjustment Information	Displays information about the refund adjustment.

By default, the **Bill Line Items** zone does not appear in the **Main** tab. It appears only when you click the **Broadcast** (📡) icon corresponding to the bill in the **Refund Details** zone.

Related Topics

For more information on...	See...
How to add a credit bill line item to the refund request	Adding a Credit Bill Line Item to the Refund Request on page 2561

Refund Request - Bills

The **Bills** tab allows you to search bills with credit line items, such as credit bill segments and adjustments, that you want to refund. It contains the following zones:

- [Search Bills](#) on page 2550

- [Bill Line Items](#) on page 2551

Search Bills

The **Search Bills** zone lists completed bills of the account which are either with credit balance or have one or more credit line items, such as bill segments and adjustments. You can filter the bills using various search criteria. This zone contains the following two sections:

- **Search Criteria** — The **Search Criteria** section contains the following fields:

Field Name	Field Description	Mandatory (Yes or No)
Search By	Used to indicate whether you want to search for a bill using bill or bill and price item details. The valid values are: <ul style="list-style-type: none"> • Bill Details • Bill and Price Item Details 	Yes
	Note: By default, the Bill Details option is selected.	
Bill ID	Used to search a particular bill.	No
Bill Date From	Used to search bills which are created from a particular date onwards.	No
To	Used to search bills which are created till a particular date.	No
Price Item	Used to search bills which are created for a particular price item.	No
	Note: This field appears when you select Bill and Price Item Details option from the Search By list. You can search for a price item by clicking the search (🔍) icon corresponding to the field.	

- **Search Results** — On clicking the **Search** button, the search results are filtered based on the specified search criteria. The **Search Results** section contains the following columns:

Column Name	Column Description
Bill ID	Displays the bill ID.
Bill Information	Displays additional information about the bill. In addition, this column has a context menu which helps in navigating to other screens in the application.
	Note: It has a link. On clicking the link, the Bill screen appears with the details of the respective bill.
Amount	Displays the total bill amount.

If you want to refund a bill with credit balance and all credit line items, you need to select the check box corresponding to the bill and then click the **Add** button in the **Search Results** section. All credit bill segments and adjustments of the bill are added in the **Refund Details** zone on the **Main** tab. However, if you select a bill (with credit balance) which contains one or more debit line items or if you select a bill (with debit balance) which contains one or more credit line items, the system will not allow you to add the credit line items by directly adding

the bill. In such case, you need to individually select the credit bill segments and adjustments of the bill and then add them to the refund request.

Note: If a refund request is currently in progress for a credit bill segment or adjustment of a bill, those bills of the account are not listed in the **Search Bills** zone. In addition, a bill with all debit line items are not listed in the **Search Bills** zone.

Related Topics

For more information on...	See...
How to add a credit bill line item to the refund request	Adding a Credit Bill Line Item to the Refund Request on page 2561

Bill Line Items

The **Bill Line Items** zone lists the debit and credit bill segments and adjustments of the bill. This zone contains the following columns:

Column Name	Column Description
Entity ID	Displays the bill segment or adjustment ID.
Entity Type	Indicates whether the entity is a bill segment or an adjustment.
Entity Information	Displays additional information about the bill segment or adjustment. If the entity is a bill segment, the context menu appears in the column which helps in navigating to other screens in the application. Note: It has a link. If the entity is a bill segment, the Bill Segment screen appears where you can view the details of the respective bill segment on clicking the link. However, if the entity is an adjustment, the Adjustment screen appears with the details of the respective adjustment on clicking the link.
Entity Amount	Displays the bill segment or adjustment amount.
Eligible Amount	Displays the bill segment or adjustment amount which is eligible for refund. In other words, it means entity amount minus amount refunded. Note: If the bill segment or adjustment has debit balance, the eligible amount for refund would be zero.
Amount Refunded	Displays the amount which is already refunded to the account.
Contract Information	Displays additional information about the contract against which the bill segment or adjustment is created. In addition, this column has a context menu which helps in navigating to other screens in the application. Note: It has a link. On clicking the link, the Contract screen appears where you can view the details of the respective contract.

You can select one or more credit bill segments or adjustments and click the **Add** button in this zone to add selected credit bill segments or adjustments to the refund request.

By default, the **Bill Line Items** zone does not appear in the **Bills** tab. It appears only when you click the **Broadcast** (📡) icon corresponding to the bill in the **Search Bills** zone.

Related Topics

For more information on...	See...
How to add a credit bill line item to the refund request	Adding a Credit Bill Line Item to the Refund Request on page 2561

Refund Request - Payments

The **Payments** tab allows you to search payment events or individual payments that you want to refund. It contains the following zones:

- [Search Payment Event](#) on page 2552
- [Payments](#) on page 2553

Search Payment Event

The **Search Payment Event** zone lists the payment events which are created for the account. You can filter the payment events using various search criteria. This zone contains the following two sections:

- **Search Criteria** — The **Search Criteria** section contains the following fields:

Field Name	Field Description	Mandatory (Yes or No)
Search By	Used to indicate that you want to search for a payment event using the payment details. The valid values are: <ul style="list-style-type: none"> • Payment Details 	Yes
	Note: By default, the Payment Details option is selected.	
Payment Event ID	Used to search a particular payment event.	No
Suspense/Excess Credit Contract	Used to search payment events which include payments made against a particular suspense or excess credit contract.	No
	Note: The suspense and excess credit contracts are listed when these contracts are associated with the account	
Check Number	Used to search a payment event which includes payment made through a particular check.	No
Payment Date	Used to search payment events which include payments created from a particular date onwards.	No
To	Used to search payment events which include payments created till a particular date.	No
MICR ID	Used to search payment events which include payments made with a particular MICR code.	No

- **Search Results** — On clicking the **Search** button, the search results are filtered based on the specified search criteria. The **Search Results** section contains the following columns:

Column Name	Column Description
Payment Event Information	Displays additional information about the payment event.

Column Name	Column Description
	Note: It has a link. On clicking the link, the Payment Event screen appears where you can view the details of the respective payment event.
Payment Date	Displays the date when the payments were created.
Tender Amount	Displays the tender amount.
Payment Event ID	Displays the payment event ID.

If you want to refund all payments of a payment event, you need to select the check box corresponding to the payment event and then click the **Add** button in the **Search Results** section. If all payments in the payment event are matched against the same suspense or excess credit contract, the payment event is added in the **Refund Details** zone on the **Main** tab. However, if the payments in the payment event are matched against different suspense or excess credit contracts, the payments of the payment event are added in the **Refund Details** zone.

Note: If a refund request is currently in progress for a payment event or for any payment of a payment event, those payments events of the account are not listed in the **Search Payment Event** zone.

Related Topics

For more information on...	See...
How to add a payment event to the refund request	Adding a Payment Event to the Refund Request on page 2558

Payments

The **Payments** zone lists only those payments which are created through the payment event and are currently in the **Frozen** status. This zone contains the following columns:

Column Name	Column Description
Payment ID	Displays the payment ID. Note: It has a link. On clicking the link, the Payment screen appears where you can view the details of the respective payment.
Payee Account Information	Displays additional information about the account for which the payment was made. Note: It has a link. On clicking the link, the Account screen appears where you can view the details of the respective account.
Payment Amount	Displays the payment amount.
Payment Currency	Indicates the currency in which the payment was made.
Payment Status	Indicates the status of the payment.
Match Type	Indicates the match type using which the payment was matched.
Match Value	Indicates the entity (such as bill, contract, and so on) against which the payment was matched.
Amount Refunded	Displays the amount which is already refunded to the payor account.

You can select one or more payments and click the **Add** button in this zone to add selected payments to the refund request.

By default, the **Payments** zone does not appear in the **Payments** tab. It appears when you click the **Broadcast** (📡) icon corresponding to the payment event in the **Search Payment Event** zone.

Related Topics

For more information on...	See...
How to add a payment to the refund request	Adding a Payment to the Refund Request on page 2559

Refund Request - Log

The **Log** tab contains the following zone:

- [Refund Request Log](#) on page 2554

Refund Request Log

The **Refund Request Log** zone lists the complete trail of actions performed on the refund request. This zone contains the following columns:

Column Name	Column Description
Date/Time	Displays the date and time when the action was performed on the refund request.
Details	Displays the details about the action performed on the refund request.
User	Indicates the user who has performed the action on the refund request.
Log Type	Indicates the type of log.
Related Object	Indicates the object or entity which is generated when the action is performed on the refund request.
Status Reason	Displays the status reason of action performed on the refund request.

Note: You can manually add a log entry for the refund request by clicking the **Add Log Entry** link in the upper right corner of the **Refund Request Log** zone.

The **Add Request Log** window appears. Enter **Log Details** and click **Save**. The refund request log is added.

Related Topics

For more information on...	See...
How to view the log of a refund request	Viewing the Log of a Refund Request on page 2575

Creating a Refund Request

Prerequisites

To create a refund request, you should have:

- Refund request types defined in the application

Procedure

To create a refund request:

1. Do either of the following:

If you want to...	Then...
Define a refund request from the Account Receivable Central screen	<ol style="list-style-type: none"> 1. Click the Main link in the Application toolbar. A list appears. 2. From the Main menu, select Accounting and Receivable and then click Account Receivable Central. 3. Search for the bill in the Account Receivable Central screen. 4. In the Search Results section, select the required bill and then click Refund. <p>Note: Only one bill at a time is allowed to select for Refund Request from the Account Receivable Central screen.</p>
Define a refund request from the Refund Request screen	<ol style="list-style-type: none"> 1. Click the Main link in the Application toolbar. A list appears. 2. From the Main menu, select Accounting and Receivable and then click Refund/Write Off Request. A sub-menu appears. 3. Click the Add option from the Refund/Write Off Request sub-menu.
Define a refund request from the Payment Event Summary screen	<ol style="list-style-type: none"> 1. Click the Main link in the Application toolbar. A list appears. 2. From the Main menu, select Payments and then click Payment Event Summary. 3. Search for the payment event (whose payments you want to refund) in the Payment Event Summary screen. 4. In the Search Results section, click the Broadcast (📡) icon corresponding to the payment event whose payments you want to view. The Payments zone appears. 5. Select the check box corresponding to the payments that you want to refund. 6. Click the Refund button in the Payments zone.

The **Select Request Type** screen appears. It contains the following fields:

Field Name	Field Description	Mandatory (Yes or No)
Action	Displays the type of request (refund or write off) to be created.	Not applicable

Field Name	Field Description	Mandatory (Yes or No)
	<p>Note:</p> <p>This field is pre-populated if the refund request is created from the Account Receivable Central screen.</p> <p>This field is editable if the refund request is created from the Refund/Write Off Request screen.</p>	
Refund/Write Off Request Type	<p>Used to indicate the request type using which you want to create the refund or write off request.</p> <p>Note: The refund request types are listed when you set the Action field to Refund and the write off request types are listed when you set the Action field to Write Off.</p>	Yes
Account	<p>Used to indicate the account for which you want to create the refund or write off request.</p> <p>Note:</p> <p>This field is pre-populated if the refund request is created from the Account Receivable Central screen.</p> <p>This field is editable if the refund request is created from the Refund/Write Off Request screen.</p> <p>You can search for an account by clicking the Search (🔍) icon corresponding to the respective field.</p>	Yes

Tip:

Alternatively, you can access the **Select Request Type** screen:

- By clicking the **Add** button in the **Page Title** area of **Refund/Write Off Request** screen.
- By selecting the payment which you want to refund in the **Payment Event Summary** screen and then clicking the **Refund** button. Note that the system will allow you to refund only those payments which are in the **Frozen** status and matched against the suspense or excess credit contract.

2. Select the required refund request type from the respective field.
3. Click **Save**.

The refund request is defined and the status of the refund request is set to **Draft**. The **Refund Request** screen appears where you can view the details of the refund request. It contains the following tabs:

Note: The refund request can be created only for bill with outstanding amount lesser than zero.

- **Main** – Displays information about the refund request. It contains the following zones:
 - **Refund Request** – Displays the details of the refund request.
 - **Refund Details** – Lists the entities, such as payment events, payments, and/or credit bill line items (such as credit bill segments and adjustments), of the account which must be refunded.

- **Payments** – Used to search payment events or individual payments that you want to refund. This tab appears only when the refund request is in the **Draft** status.
 - **Bills** – Used to search bills with credit line items, such as credit bill segments and adjustments, that you want to refund. This tab appears when the refund request is in the **Draft** status.
 - **Log** – Lists the complete trail of actions performed on the refund request.
4. Add payment events, payments, or credit bill line items that you want to refund.
 5. Edit the refund amount of each entity, if required.
 6. Define characteristics for the refund request, if required.
 7. Override the address if you want to sent the refund to an address other than the account’s main customer address.

Related Topics

For more information on...	See...
Refund Request screen	Refund Request on page 2545
Account Receivable Central screen	Account Receivable Central on page 1538
How to add a payment event to the refund request	Adding a Payment Event to the Refund Request on page 2558
How to add a payment to the refund request	Adding a Payment to the Refund Request on page 2559
How to add a credit bill line item to the refund request	Adding a Credit Bill Line Item to the Refund Request on page 2561
How to edit a refund request	Editing a Refund Request on page 2563
How to define a characteristic for a refund request	Defining a Characteristic for a Refund Request on page 2557

Defining a Characteristic for a Refund Request

Prerequisites

To define a characteristic for a refund request, you should have:

- Characteristic types defined in the application (where the characteristic entity is set to **Refund Write Off Request**)

Procedure

To define a characteristic for a refund request:

1. Search for the refund request in the **Refund/Write Off Request** screen.
2. In the **Search Results** section, click the link in the **Refund/Write Off Request Information** column corresponding to the refund request whose details you want to edit.

The **Refund Request** screen appears.

3. Click the **Edit** button in the **Refund Request** zone.

The **Edit Refund Request** screen appears.

Note: The Edit button appears only when the refund request is in the Draft status.

4. Ensure that the **Characteristics** section is expanded when you are editing the refund request.

The **Characteristics** section contains the following fields:

Field Name	Field Description	Mandatory (Yes or No)
Effective Date	Used to specify the date from when the characteristic is effective for the refund request.	Yes (Conditional)
		Note: This field is required when you are defining a characteristic for the refund request.
Characteristic Type	Used to indicate the characteristic type. Note: The list includes only those characteristic types where the characteristic entity is set to Refund Write Off Request .	Yes (Conditional)
		Note: This field is required when you are defining a characteristic for the refund request.
Characteristic Value	Used to specify the value for the characteristic type. Note: On specifying the value for a predefined characteristic type, the description of the characteristic value appears corresponding to the Characteristic Value field.	Yes (Conditional)
		Note: This field is required when you are defining a characteristic for the refund request.

5. Enter the required details in the **Characteristics** section.

Note: If you select a predefined characteristic type, the **Search** (🔍) icon appears corresponding to the **Characteristic Value** field. On clicking the **Search** icon, you can search for a predefined characteristic value.

6. If you want to define more than one characteristic for the refund request, click the **Add** (+) icon and then repeat step 5.

Note: However, if you want to remove a characteristic from the refund request, click the **Delete** (🗑️) icon corresponding to the characteristic.

Related Topics

For more information on...	See...
How to search for a refund request	Searching for a Refund or Write Off Request on page 2537
How to create a refund request	Creating a Refund Request on page 2538

Adding a Payment Event to the Refund Request

Prerequisites

To add a payment event to the refund request, you should have:

- Payments made by the account for which you need to create the refund request

Procedure

To add a payment event to the refund request:

1. Click the **Payments** tab in the **Refund Request** screen.

The **Payments** tab appears.

- Filter the payment events, if required, in the **Search Payment Event** zone.

Note: You can only refund payments, which are matched against suspense or excess credit contracts, to the payor account. Therefore, you can only view payment events which includes payments matched against suspense or excess credit contracts. If a refund request is currently in progress for a payment event or for any payment of a payment event, those payments events of the account are not listed in the **Search Payment Event** zone.

- Select the check box corresponding to the payment event, whose payments you want to refund, in the **Search Results** section.

Note: You can add more than one payment event to the refund request at the same time.

- Click **Add**.

A message appears indicating that the selected payment events are added to the refund request.

- Click **OK**.

Note that the entity is added in the **Refund Details** zone on the **Main** tab.

Note:

You can only refund payments which are in the **Frozen** status.

If all payments in the payment event are matched against the same suspense or excess credit contract, the payment event is added in the **Refund Details** zone. However, if the payments in the payment event are matched against different suspense or excess credit contracts, the payments of the payment event are added in the **Refund Details** zone.

Related Topics

For more information on...	See...
How to create a refund request	Creating a Refund Request on page 2538

Adding a Payment to the Refund Request

Prerequisites

To add a payment to the refund request, you should have:

- Payments made by the account for which you need to create the refund request

Procedure

To add a payment to the refund request:

- Click the **Payments** tab in the **Refund Request** screen.

The **Payments** tab appears.

- Filter the payment events, if required, in the **Search Payment Event** zone.

Note: You can only refund payments, which are matched against suspense or excess credit contracts, to the payor account. Therefore, you can only view payment events which includes payments matched against suspense or excess credit contracts. If a refund request is currently in progress for a payment event or for any payment of a payment event, those payments events of the account are not listed in the **Search Payment Event** zone.

- In the **Search Results** section, click the **Broadcast** () icon corresponding to the payment event whose payments you want to view.

The **Payments** zone appears.

4. Select the check box corresponding to the payment that you want to refund.

Note: You can add more than one payment to the refund request at the same time.

5. Click **Add**.

A message appears indicating that the selected payments are added to the refund request.

6. Click **OK**.

Note that the payments are added in the **Refund Details** zone on the **Main** tab.

Note: You can only refund payments which are in the **Frozen** status.

Related Topics

For more information on...	See...
How to create a refund request	Creating a Refund Request on page 2538

Adding a Credit Bill to the Refund Request

You can refund the credit bills to the account.

Prerequisites

To add a credit bill to the refund request, you should have:

- Completed bills for the account with one or more credit line items

Procedure

To add a credit bill to the refund request:

1. Click the **Bills** tab in the **Refund Request** screen.

The **Bills** tab appears.

2. Filter the bills, if required, in the **Search Bills** zone.

Note: If a refund request is currently in progress for a credit bill segment or adjustment of a bill, those bills of the account are not listed in the **Search Bills** zone. In addition, a bill with all debit line items are not listed in the **Search Bills** zone.

3. Do either of the following:

If...	Then...
A bill has all credit line items and you want to add the credit bill to the refund request	<ol style="list-style-type: none"> 1. In the Search Bills zone, select the bills that you want to refund. 2. Click the Add button available at the upper left corner of the Search Bills zone.
	Note: Default adjustment type selected in the write off request type should be non A/P.

If...	Then...
A bill has credit balance and one or more debit line items and you want to add the credit bill to the refund request	<ol style="list-style-type: none"> 1. In the Search Bills zone, select the bills that you want to refund. 2. Click the Add button available at the upper left corner of the Search Bills zone. <p>Note: Default adjustment type selected in the write off request type should be non A/P.</p>

4. Click **Add**.

A message appears indicating that the selected bills are added to the refund request.

Note: If you select a bill (with credit balance) which contains one or more debit line items or if you select a bill (with debit balance) which contains one or more credit line items, the system will not allow you to add the credit line items by directly adding the bill. In such case, you need to individually select the credit bill segments and adjustments of the bill and then add them to the refund request.

5. Click **OK**.

Note that all the credit bill segments or adjustments of the bills are added in the **Refund Details** zone on the **Main** tab.

Note:

Irrespective of whether you select a credit bill, or credit bill segments or adjustments, the credit bill segments or adjustments are added in the **Refund Details** zone. The credit bill is not added to the **Refund Details** zone.

The system will not allow you to add a debit line item to the **Refund Details** zone.

Related Topics

For more information on...	See...
How to create a refund request	Creating a Refund Request on page 2538

Adding a Credit Bill Line Item to the Refund Request

You can refund the credit bill line items, such as bill segments and adjustments, to the account. While adding a credit bill line item to the refund request, you can either:

- Directly add all credit line items of a bill to the refund request by adding the bill which has all bill segments and adjustments in credit
- Individually add a credit bill segment or adjustment of a bill (with one or more credit line items) to the refund request

Prerequisites

To add a credit bill line item to the refund request, you should have:

- Completed bills for the account with one or more credit line items

Procedure

To add a credit bill line item to the refund request:

1. Click the **Bills** tab in the **Refund Request** screen.

The **Bills** tab appears.

- Filter the bills, if required, in the **Search Bills** zone.

Note: If a refund request is currently in progress for a credit bill segment or adjustment of a bill, those bills of the account are not listed in the **Search Bills** zone. In addition, a bill with all debit line items are not listed in the **Search Bills** zone.

- Do either of the following:

If...	Then...
A bill has all credit line items and you want to add a particular credit bill line item to the refund request	<ol style="list-style-type: none"> In the Search Bills zone, click the Broadcast (📡) icon corresponding to the bill whose line items you want to view. The Bill Line Items zone appears. Select the check box corresponding to the credit bill segment or adjustment that you want to refund.
A bill has credit balance and one or more debit line items	<ol style="list-style-type: none"> In the Search Bills zone, click the Broadcast (📡) icon corresponding to the bill whose line items you want to view. The Bill Line Items zone appears. Select the check box corresponding to the credit bill segment or adjustment that you want to refund.
A bill has debit balance and one or more credit line items	<ol style="list-style-type: none"> In the Search Bills zone, click the Broadcast (📡) icon corresponding to the bill whose line items you want to view. The Bill Line Items zone appears. Select the check box corresponding to the credit bill segment or adjustment that you want to refund.

- Click **Add**.

A message appears indicating that the selected bill segments or adjustments are added to the refund request.

Note: If you select a bill (with credit balance) which contains one or more debit line items or if you select a bill (with debit balance) which contains one or more credit line items, the system will not allow you to add the credit line items by directly adding the bill. In such case, you need to individually select the credit bill segments and adjustments of the bill and then add them to the refund request.

- Click **OK**.

Note that the credit bill segments or adjustments are added in the **Refund Details** zone on the **Main** tab.

Note:

Irrespective of whether you select a credit bill, or credit bill segments or adjustments, the credit bill segments or adjustments are added in the **Refund Details** zone. The credit bill is not added to the **Refund Details** zone.

The system will not allow you to add a debit line item to the **Refund Details** zone.

Related Topics

For more information on...	See...
How to create a refund request	Creating a Refund Request on page 2538

Editing a Refund Request**Prerequisites**

To edit a refund request, you should have:

- Adjustment types with A/P request type defined in the application

Procedure

To edit a refund request:

1. Search for the refund request in the **Refund/Write Off Request** screen.
2. In the **Search Results** section, click the link in the **Refund/Write Off Request Information** column corresponding to the refund request whose details you want to edit.

The **Refund Request** screen appears.

3. Click the **Edit** button in the **Refund Request** zone.

The **Edit Refund Request** screen appears. It contains the following section:

Field Name	Field Description	Mandatory (Yes or No)
Refund Request Information	Displays information about the refund request.	Not applicable
Account Information	Indicates the account for which the refund request is created.	Not applicable
Person Name	Used to indicate the person for whom the refund request is created. Note: The system maintains a log when you edit the person name in a refund request. A log is created in the following format: Person Name is changed; Old Value: <OLD NAME>; New Value: <NEW NAME>	No
Override Address	Used to indicate whether the account's mailing address must be overridden.	No

Field Name	Field Description	Mandatory (Yes or No)
	<p>Note:</p> <p>By default, the account's main customer's address appears in the following fields — Address 1, Address 2, Address 3, Address 4, City, Country, State, and Postal. You can override the address in these fields, if required.</p> <p>The system maintains a log when you edit the address in a refund request. A log is created in the following format:</p> <p>Address is changed; Old Value: <OLD ADDRESS>; New Value: <NEW ADDRESS></p>	
Address 1	Used to specify the house number and apartment name.	No
Address 2	Used to specify the street name.	No
Address 3	Used to specify any landmark, if available.	No
Address 4	Used to specify the village, town, or city name.	No
City	Used to specify the city name.	No
Country	Used to specify the country name.	No
State	Used to specify the state name.	No
Postal	Used to specify the postal or zip code.	No
Comments	Used to specify additional information about the refund request.	No

In addition, this screen contains the following two sections:

- **Characteristics** — Used to define the characteristics for the refund request. It contains the following fields:

Field Name	Field Description	Mandatory (Yes or No)
Effective Date	Used to specify the date from when the characteristic is effective for the refund request.	Yes (Conditional)
		Note: This field is required when you are defining a characteristic for the refund request.
Characteristic Type	Used to indicate the characteristic type.	Yes (Conditional)
		Note: This field is required when you are defining a characteristic for the refund request.
	Note: The list includes only those characteristic types where the characteristic entity is set to Refund Write Off Request .	

Field Name	Field Description	Mandatory (Yes or No)
Characteristic Value	Used to specify the value for the characteristic type.	Yes (Conditional)
	Note: On specifying the value for a predefined characteristic type, the description of the characteristic value appears corresponding to the Characteristic Value field.	Note: This field is required when you are defining a characteristic for the refund request.

4. Modify the details of the refund request, if required.
5. Define, edit, or remove characteristics of the refund request, if required.
6. Click **Save**.

The changes made to the refund request are saved.

Related Topics

For more information on...	See...
How to search for a refund request	Searching for a Refund or Write Off Request on page 2537
Refund Request screen	Refund Request on page 2545
Refund Request zone	Refund Request on page 2545
How to define a characteristic for a refund request	Defining a Characteristic for a Refund Request on page 2557

Editing the Refund Details

Prerequisites

To edit the refund details, you should have:

- Adjustment types with A/P request type defined in the application

Procedure

To edit the refund details:

1. Search for the refund request in the **Refund/Write Off Request** screen.
2. In the **Search Results** section, click the link in the **Refund/Write Off Request Information** column corresponding to the refund request whose bill line item details you want to edit.

The **Refund Request** screen appears. You can edit the bill line items by either of the following ways:

If...	Then
Select the bill whose details you want to edit in the Refund Details zone and click the Edit button available in the upper left corner of this zone.	The Edit Request Details screen appears.
In the Refund Details zone, click the Broadcast (📡) icon corresponding to the bill whose line items details you want to edit.	The Bill Line Items zone appears. Note: This zone appears when the Entity Type is Bill .

If...	Then
	<p>1. Select the bill line item whose details you want to edit in the Bill Line Items zone and click the Edit button available in the upper left corner of this zone.</p> <p>The Edit Request Details screen appears.</p>

Note: A bill line item from the refund request can be edited when the refund request is in the **Draft** status.

The **Edit Request Details** screen contains the following fields:

Field Name	Field Description	Mandatory (Yes or No)
Request ID	Displays the refund request ID.	Not applicable
Account Information	Displays additional information about the account.	Not applicable
Adjustment Type	<p>Indicates the adjustment type of the refund request type.</p> <p>You can search for an adjustment type by clicking the Search(🔍) icon corresponding to the field.</p>	No

In addition to these fields, this screen contains following columns:

Column Name	Column Description
Entity Type	<p>Indicates the entity type. The valid values are</p> <ul style="list-style-type: none"> • Adjustments • Bill • Bill Segment • Payment Event • Payment
Entity ID	Displays the entity ID.
Entity Amount	Displays the entity amount.
Currency	Displays the currency in which the entity was created.
Request Amount	Displays the amount that must be refunded.
Adjustment Type	<p>Indicates the adjustment type using which the refund adjustment must be created.</p> <p>Note:</p> <p>You can search for an account by clicking the Search(🔍) icon corresponding to the field.</p>
Bill ID	Displays the bill ID.





In addition to the above columns, the screen has following button:

Button Name	Button Description
Override	Used to override an adjustment type of the refund request.

Note:

In the **Bill Line Items** zone, click the **Broadcast** () icon corresponding to the bill line item which you want to delete

Pagination is used to display limited number of records in the **Search Results** section. By default, 10 records are displayed in the **Search Results** section. You can change the number of records displayed per page, if required.

You can use the navigation buttons, such as **First** () , **Previous** () , **Next** () , and **Last** () to navigate between pages. You can also select the page to which you want to navigate from the **Go To** list.

The values appear in the **Page Limit** list when you define values for the **PAGE_NUMBER** lookup field.

3. Modify the details of the bill line items.
4. Click **Save**.

The changes made to the refund bill line items are saved.

Related Topics

For more information on...	See...
Refund Request screen	Refund Request on page 2545
Refund Request zone	Refund Request on page 2545
How to search for a refund request	Searching for a Refund or Write Off Request on page 2537

Deleting a Refund Request**Procedure**

To delete a refund request:

1. Search for the refund request in the **Refund/Write Off Request** screen.
2. In the **Search Results** section, click the link in the **Refund/Write Off Request Information** column corresponding to the refund request that you want to delete.

The **Refund Request** screen appears.

3. Click the **Delete** button in the **Refund Request** zone.

A message appears confirming whether you want to delete the refund request.

Note: The **Delete** button appears when the refund request is in the **Draft** status.

4. Click **OK**.

The refund request is deleted.

Related Topics

For more information on...	See...
How to search for a refund request	Searching for a Refund or Write Off Request on page 2537

For more information on...	See...
Refund Request screen	Refund Request on page 2545
Refund Request zone	Refund Request on page 2545

Deleting a Bill from the Refund Request

Procedure

To delete a bill from the refund request:

1. Search for the refund request in the **Refund/Write Off Request** screen.
2. In the **Search Results** section, click the link in the **Refund/Write Off Request Information** column corresponding to the refund request whose bill you want to delete.

The **Refund Request** screen appears.

3. In the **Refund Details** zone, select the bills and click the **Delete** button available in the upper left corner of this zone.

A message appears confirming whether you want to delete the bill from the refund request.

Note: You can delete bill from the refund request when the request is in the **Draft** status.

4. Click **OK**.

The selected bill gets deleted from the refund request.

Related Topics

For more information on...	See...
Refund Request screen	Refund Request on page 2545
Refund Request zone	Refund Request on page 2545
How to search for a refund request	Searching for a Refund or Write Off Request on page 2537

Deleting a Bill Line Item from the Refund Request

Procedure

To delete a bill line item from the refund request:

1. Search for the refund request in the **Refund/Write Off Request** screen.
2. In the **Search Results** section, click the link in the **Refund/Write Off Request Information** column corresponding to the refund request whose bill line items you want to delete.

The **Refund Request** screen appears.

3. In the **Refund Details** zone, click the **Broadcast** () icon corresponding to the bill whose line items details you want to delete.

The **Bill Line Items** zone appears.

4. In the **Bill Line Items** zone, select the bill line items which you want to delete and click the **Delete** button available in the upper left corner of this zone.

A message appears confirming whether you want to delete the bill line items from the refund request.

Note:

You can delete a bill line item from the refund request when the request is in the **Draft** status.

5. Click **OK**.

The selected bill line items gets deleted from the refund request.

Related Topics

For more information on...	See...
Refund Request screen	Refund Request on page 2545
Refund Request zone	Refund Request on page 2545
How to search for a refund request	Searching for a Refund or Write Off Request on page 2537

Submitting a Refund Request

Prerequisites

To submit a refund request, you should have:

- Payment events, payments, or credit bill line items added in the refund request

Procedure

To submit a refund request:

1. Search for the refund request in the **Refund/Write Off Request** screen.
2. In the **Search Results** section, click the link in the **Refund/Write Off Request Information** column corresponding to the refund request that you want to submit.

The **Refund Request** screen appears.

3. Click the **Submit** button in the **Refund Request** zone.

The system behaves in the following manner:

If...	Then...
The Approval Required and Hierarchical Approval check boxes are selected in the refund request type using which the refund request is created	A To Do of the C1-REFRQ To Do type is created and sent to the approver at the first level in the approval hierarchy, and the status of the refund request is changed to Approval In Progress .
The Approval Required check box is selected, but the Hierarchical Approval check box is not selected in the refund request type using which the refund request is created	A To Do of the C1-REFRQ To Do type is created and sent to the approver at the hierarchy level where the total refund amount falls within the threshold limit. In addition, the status of the refund request is changed to Approval In Progress .
The Approval Required check box is not selected in the refund request type using which the refund request is created	The refund adjustments are created using the specified adjustment types and the status of the refund request is changed to Processed .

If...	Then...
	<p>Note: The refund adjustments are created in the Frozen status. If a match event is present for the credit bill line items (such as bill segments and adjustments) and for the payments which are matched against the excess credit contract, the existing match event is stamped on the refund adjustments and on the corresponding financial transactions. However, when a match event is not present for the payments which are matched against the suspense contract or if the match events does not exist, a new match event is created and stamped on the refund adjustments and on the corresponding financial transactions. If you are doing a partial refund for any entity, the corresponding match event status is set to Open. However, if you are refunding the entire eligible amount, the corresponding match event status is set to Balanced.</p>
<p>The total refund amount is less than minimum refund amount</p>	<p>The write up adjustment is created using the write up adjustment type specified in the refund request type. In addition, the status of the refund request is changed to Processed.</p> <p>Note: The write up adjustment is created in the Frozen status. If a match event is present for the credit bill line items (such as bill segments and adjustments) and for the payments which are matched against the excess credit contract, the existing match event is stamped on the write up adjustment and on the corresponding financial transaction. However, when a match event is not present for the payments which are matched against the suspense contract or if the match events does not exist, a new match event is created and stamped on the write up adjustment and on the corresponding financial transaction. If you are doing a partial refund for any entity, the corresponding match event status is set to Open. However, if you are refunding the entire eligible amount, the corresponding match event status is set to Balanced.</p>
<p>The total refund amount is less than the minimum threshold amount</p>	<p>The refund request is automatically approved by the system and refund adjustments are created using the specified adjustment types. In addition, the status of the refund request is changed to Processed.</p>

If...	Then...
	<p>Note: The refund adjustments are created in the Frozen status. If a match event is present for the credit bill line items (such as bill segments and adjustments) and for the payments which are matched against the excess credit contract, the existing match event is stamped on the refund adjustments and on the corresponding financial transactions. However, when a match event is not present for the payments which are matched against the suspense contract or if the match events does not exist, a new match event is created and stamped on the refund adjustments and on the corresponding financial transactions. If you are doing a partial refund for any entity, the corresponding match event status is set to Open. However, if you are refunding the entire eligible amount, the corresponding match event status is set to Balanced.</p>

Note: The **Submit** button appears when the refund request is in the **Draft** status.

Related Topics

For more information on...	See...
How to search for a refund request	Searching for a Refund or Write Off Request on page 2537
Refund Request screen	Refund Request on page 2545
Refund Request zone	Refund Request on page 2545

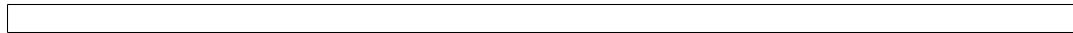

Approving a Refund Request

You can view the number of refund requests which are pending for approval in the **Refund/Write Off Request** screen. The approver can review, and accordingly approve or reject the refund request based on the observations.

Note: The system will not allow you to approve or reject a refund request submitted by you.

Procedure

To approve a refund request:

1. Do either of the following:

If you want to...	Then...
Approve a refund request through the Refund/Write Off Request screen	<ol style="list-style-type: none"> 1. Search for the refund request in the Refund/Write Off Request screen. 2. In the Search Results section, click the link in the Refund/Write Off Request Information column corresponding to the refund request which you want to review.

If you want to...	Then...
Approve a refund request from the To Do List screen	<ol style="list-style-type: none"> 1. Click the Menu link in the Application toolbar. A list appears. 2. From the Main menu, select To Do and then click To Do List. The To Do Type for User Search window appears. 3. Enter C1-REFRQ in the To Do Type field. 4. Click the Search button corresponding to the To Do Type field. The To Do List screen appears. 5. Select the Open option from the Filter by list to view all unassigned To Dos. 6. Click the link in the Message column corresponding to the To Do of the refund request that you want to review.

The **Refund Request** screen appears.

2. Review the refund request details.
3. Click the **Approve** button in the **Refund Request** zone.

The system behaves in the following manner:

If...	Then
The Hierarchical Approval check box is selected in the refund request type using which the refund request is created and the total refund amount is greater than the threshold amount specified at the next level in the approval hierarchy	A To Do of the C1-REFRQ To Do type is created and sent to the approver at the next level in the approval hierarchy, and the status of the refund request remains as Approval In Progress .
The Hierarchical Approval check box is selected in the refund request type using which the refund request is created and the total refund amount is less than the threshold amount specified at the next level in the approval hierarchy	The refund adjustments are created using the specified adjustment types and the status of the refund request is changed to Processed .

If...	Then
	<p>Note: The refund adjustments are created in the Frozen status. If a match event is present for the credit bill line items (such as bill segments and adjustments) and for the payments which are matched against the excess credit contract, the existing match event is stamped on the refund adjustments and on the corresponding financial transactions. However, when a match event is not present for the payments which are matched against the suspense contract or if the match events does not exist, a new match event is created and stamped on the refund adjustments and on the corresponding financial transactions. If you are doing a partial refund for any entity, the corresponding match event status is set to Open. However, if you are refunding the entire eligible amount, the corresponding match event status is set to Balanced.</p>
<p>The Hierarchical Approval check box is not selected in the refund request type using which the refund request is created</p>	<p>The refund adjustments are created using the specified adjustment types and the status of the refund request is changed to Processed.</p> <p>Note: The refund adjustments are created in the Frozen status. If a match event is present for the credit bill line items (such as bill segments and adjustments) and for the payments which are matched against the excess credit contract, the existing match event is stamped on the refund adjustments and on the corresponding financial transactions. However, when a match event is not present for the payments which are matched against the suspense contract or if the match events does not exist, a new match event is created and stamped on the refund adjustments and on the corresponding financial transactions. If you are doing a partial refund for any entity, the corresponding match event status is set to Open. However, if you are refunding the entire eligible amount, the corresponding match event status is set to Balanced.</p>

Note: The **Approve** button appears when:

- The refund request is in the **Approval In Progress** status.
- A user with the approval To Do role is reviewing the refund request.

Related Topics

For more information on...	See...
How to search for a refund request	Searching for a Refund or Write Off Request on page 2537
Refund Request screen	Refund Request on page 2545
Refund Request zone	Refund Request on page 2545

--

Rejecting a Refund Request

Prerequisites

To reject a refund request, you should have:

- Rejection reasons defined in the application

Note:

While rejecting a refund request, you need to specify the reason why you want to reject the refund request. You can select the appropriate rejection reason when you have defined the reasons for the **Rejected** status of the **C1-RefundReq** business object in the **Status Reason** screen.

The system will not allow you to approve or reject a refund request submitted by you.

Procedure

To reject a refund request:

1. Do either of the following:

If you want to...	Then...
Reject a refund request through the Refund/Write Off Request screen	<ol style="list-style-type: none"> 1. Search for the refund request in the Refund/Write Off Request screen. 2. In the Search Results section, click the link in the Refund/Write Off Request Information column corresponding to the refund request which you want to review.
Reject a refund request from the To Do List screen	<ol style="list-style-type: none"> 1. Click the Menu link in the Application toolbar. A list appears. 2. From the Main menu, select To Do and then click To Do List. The To Do Type for User Search window appears. 3. Enter C1-REFRQ in the To Do Type field. 4. Click the Search button corresponding to the To Do Type field. The To Do List screen appears. 5. Select the Open option from the Filter by list to view all unassigned To Dos. 6. Click the link in the Message column corresponding to the To Do of the refund request that you want to review.

The **Refund Request** screen appears.

- Review the refund request details.
- Click the **Reject** button in the **Refund Request** zone.

The **Reject Refund Request** window appears. It contains following fields:

Field Name	Field Description	Mandatory (Yes or No)
Status Reason	Used to indicate the reason why you want to reject the refund request.	Yes
Comments	Used to specify additional information while rejecting the refund request.	No

Note: The **Reject** button appears when:

- The refund request is in the **Approval In Progress** status.
- A user with the approval To Do role is reviewing the refund request.

- Select the rejection reason from the **Status Reason** list.
- Click **Save**.

The status of the refund request is changed to **Rejected**.

Related Topics

For more information on...	See...
How to search for a refund request	Searching for a Refund or Write Off Request on page 2537
Refund Request screen	Refund Request on page 2545
Refund Request zone	Refund Request on page 2545

Viewing the Log of a Refund Request

Procedure

To view the log of a refund request:

- Search for the refund request in the **Refund/Write Off Request** screen.
- In the **Search Results** section, click the link in the **Refund/Write Off Request Information** column corresponding to the refund request whose log you want to view.

The **Refund Request** screen appears. It consists of the following tabs:

- Main** – Displays information about the refund request. It contains the following zones:
 - Refund Request** – Displays the details of the refund request.
 - Refund Details** – Lists the entities, such as payment events, payments, and/or credit bill line items (such as credit bill segments and adjustments), of the account which must be refunded.
 - Bill Line Items** — Displays the details of the bill which must be refunded.

Note:

This zone appears when you click the Broadcast () icon corresponding to the entity type as **Bill** in the **Refund Details** zone.

- **Payments** — Used to search payment events or individual payments that you want to refund. This tab appears only when the refund request is in the **Draft** status.
 - **Bills** — Used to search bills with credit line items, such as credit bill segments and adjustments, that you want to refund. This tab appears when the refund request is in the **Draft** status.
 - **Log** – Lists the complete trail of actions performed on the refund request.
3. Click the **Log** tab.
 4. View the log of the refund request in the **Refund Request Log** zone.

Note: You can manually add a log entry for the refund request by clicking the **Add Log Entry** link in the upper right corner of the **Refund Request Log** zone.

Related Topics

For more information on...	See...
How to search for a refund request	Searching for a Refund or Write Off Request on page 2537
How to add a log entry for a refund request	Adding a Log Entry for a Refund Request on page 2576
Refund Request Log zone	Refund Request Log on page 2554

Adding a Log Entry for a Refund Request

Procedure

To add a log entry for a refund request:

1. Search for the refund request in the **Refund/Write Off Request** screen.
2. In the **Search Results** section, click the link in the **Refund/Write Off Request Information** column corresponding to the refund request whose log you want to edit.

The **Refund Request** screen appears. It consists of the following tabs:

- **Main** – Displays information about the refund request. It contains the following zones:
 - **Refund Request** – Displays the details of the refund request.
 - **Refund Details** – Lists the entities, such as payment events, payments, and/or credit bill line items (such as credit bill segments and adjustments), of the account which must be refunded.
 - **Payments** — Used to search payment events or individual payments that you want to refund. This tab appears only when the refund request is in the **Draft** status.
 - **Bills** — Used to search bills with credit line items, such as credit bill segments and adjustments, that you want to refund. This tab appears when the refund request is in the **Draft** status.
 - **Log** – Lists the complete trail of actions performed on the refund request.
3. Click the **Log** tab.
The **Log** tab appears.
 4. Click the **Add Log Entry** link in the upper right corner of the **Refund Request Log** zone.

The **Add Request Log** window appears. It contains the following fields:

Field Name	Field Description	Mandatory (Yes or No)
Request Information	Displays information about the refund request.	Not applicable

Field Name	Field Description	Mandatory (Yes or No)
Log Details	Used to specify additional comments for the refund request.	Yes

- Enter the comments in the **Log Details** field.
- Click **Save**.

The log entry is added in the **Refund Request Log** zone.

Related Topics

For more information on...	See...
How to search for a refund request	Searching for a Refund or Write Off Request on page 2537

Voiding a Refund Request

There might be situations when incorrect refund request is processed in the system. In such case, the system provides you with an ability to void or cancel the refund request. However, note that you can void a refund request when the refund request is in the **Processed** status.

Prerequisites

To void a refund request, you should have:

- Void reasons defined in the application

Note: While voiding a refund request, you need to specify the reason why you want to void the refund request. You can select the appropriate void reason when you have defined the reasons for the **Voided** status of the **C1-RefundReq** business object in the **Status Reason** screen.

Procedure

To void a refund request:

- Search for the refund request in the **Refund/Write Off Request** screen.
- In the **Search Results** section, click the link in the **Refund/Write Off Request Information** column corresponding to the refund request that you want to void.

The **Refund Request** screen appears.

- Click the **Void** button in the **Refund Request** zone.

The **Void Reason** window appears. It contains the following fields:

Field Name	Field Description	Mandatory (Yes or No)
Status Reason	Used to indicate the reason why you want to void the refund request.	Yes
Comments	Used to specify additional information while voiding the refund request.	No

Note: The **Void** button appears when the refund request is in the **Processed** status.

- Select the void reason from the **Status Reason** list.
- Click **Save**.

The status of the refund request is changed to **Voided**.

Note: The **C1-REFVOID** algorithm cancels all the frozen adjustments created for the refund request which is in the **Processed** state.

Related Topics

For more information on...	See...
How to search for a refund request	Searching for a Refund or Write Off Request on page 2537
Refund Request screen	Refund Request on page 2545
Refund Request zone	Refund Request on page 2545

Write Off Request

Once you create a write off request, the **Write Off Request** screen allows you to:

- Edit and delete a write off request
- View the details of a write off request
- Submit a write off request for approval
- Approve or reject a write off request
- View the log of a write off request
- Add a log entry for a write off request
- Cancel a write off request

This screen consists of the following tabs:

- **Main** – Displays information about the write off request. It contains the following zones:
 - **Write Off Request** – Displays the details of the write off request.
 - **Write Off Details** – Lists the debit bill line items (such as debit bill segments and adjustments) of the account which must be written off.
 - **Bill Line Items** — Displays the details of the bill which must be written off.

Note:

This zone appears when you click the Broadcast () icon corresponding to the entity type as **Bill** in the **Write Off Details** zone.

- **Bills** — Used to search bills with debit line items, such as debit bill segments and adjustments, that you want to write off. It contains the following zones:
 - **Search Bills** — Lists completed bills of the account which are either with debit balance or have one or more debit line items, such as bill segments and adjustments. You can filter the bills using various search criteria.
 - **Bill Line Items** — Lists the debit and credit bill segments and adjustments of the bill.

This tab appears when the write off request is in the **Draft** status.

- **Log** – Lists the complete trail of actions performed on the write off request.

Write Off Request - Main

The **Main** tab displays information about the write off request. It contains the following zones:

- [Write Off Request](#) on page 2579
- [Write Off Details](#) on page 2581
- [Bill Line Items](#) on page 2582

Write Off Request

The **Write Off Request** zone displays the details of the write off request. This zone contains the following sections:

- **Main** — This section provides basic information about the write off request. It contains the following fields:

Field Name	Field Description
Write Off Request Information	Displays information about the write off request.
Write Off Request Type	Indicates the write off request type using which the write off request is created. Note: It has a link. On clicking the link, the Refund/Write Off Request Type screen appears where you can view the details of the write off request type.
Status	Indicates the status of the write off request. The valid values are: <ul style="list-style-type: none"> • Draft • Approval In Progress • Rejected • Processed • Cancelled
Status Reason	Indicates the reason why the write off request is rejected or cancelled. Note: This field appears when the write off request is in the Rejected or Cancelled status. It has a link. On clicking the link, the Status Reason screen appears where you can view the details of the rejected or cancelled reason.
Account Information	Indicates the account for which the write off request is created. Note: It has a link. On clicking the link, the Account screen appears where you can view the details of the respective account.
Comments	Displays additional information about the write off request.
Total Write Off Amount	Displays the total write off amount.

- **Characteristics** — Lists the characteristics defined for the write off request. It contains the following fields:

Field Name	Field Description
Effective Date	Indicates the date from when the characteristic is effective for the write off request.

Field Name	Field Description
Characteristic Type	Indicates the characteristic type.
Characteristic Value	Displays the value of the characteristic type.

- **Record Actions** — This section contains the following buttons:

Button Name	Button Description
Edit	Used to edit the details of the write off request.
	Note: The Edit button appears when the write off request is in the Draft status.
Delete	Used to delete the write off request.
	Note: The Delete button appears when the write off request is in the Draft status.
Submit	Used to submit the write off request for approval.
	Note: The Submit button appears when the write off request is in the Draft status.
Approve	Used to approve the write off request.
	Note: The Approve button appears when: <ul style="list-style-type: none"> • The write off request is in the Approval In Progress status. • A user with the approval To Do role is reviewing the write off request.
Reject	Used to reject the write off request.
	Note: The Reject button appears when: <ul style="list-style-type: none"> • The write off request is in the Approval In Progress status. • A user with the approval To Do role is reviewing the write off request.
Cancel	Used to cancel the write off request.
	Note: The Cancel button appears when the write off request is in the Processed status.

- **Record Information** — This section contains the following fields:

Field Name	Field Description
Business Object	Indicates the business object using which the write off request is created. In addition, a context menu appears corresponding to this field which helps in navigating to other screens in the application.
	Note: It has a link. On clicking the link, the Business Object screen appears where you can view the details of the respective business object.
Status Date/Time	Displays the date and time when the write off request status is updated

Field Name	Field Description
Create Date/Time	Displays the date and time when the write off request is created.

Write Off Details

The **Write Off Details** zone lists the debit bill line items (such as bill segments and adjustments) that you have added to the write off request. This zone contains the following columns:

Column Name	Column Description
Entity ID	Displays the entity ID.
Entity Type	Indicates whether the entity is a bill, bill segment or an adjustment.
Currency	Indicates the currency in which the entity was created.
Entity Amount	Displays the entity amount.
Write Off Amount	Displays the amount that must be written off.
	Note: By default, the amount which is eligible for write off appears in this column. You can edit the amount, if required. However, you cannot specify the amount greater than the eligible amount.
Contract Information	Displays additional information about the contract against which the bill segment or adjustment is created. In addition, this column has a context menu which helps in navigating to other screens in the application.
	Note: It has a link. On clicking the link, the Contract screen appears where you can view the details of the respective contract.
Adjustment Type	Indicates the adjustment type using which the write off adjustment must be created.
	Note: By default, the adjustment type specified in the write off request type appears in this column. You can change the adjustment type, if required, by editing the write off request.
Adjustment Information	Displays information about the write off adjustment.
	Note: It has a link. On clicking the link, the Adjustment screen appears where you can view the details of the respective adjustment.
	The data appears in this column when the status of the write off request is Processed . The information string appears when an algorithm of the C1-ADI-INFO algorithm type is attached to the Adjustment Information system event in the Algorithms tab of the Installation Options — Framework screen.

Note:

On clicking the **Broadcast** () icon corresponding to the entity type as **Bill**, the **Bill Line Items** zone appears with the details of the respective bill.

In addition to above columns, this screen contains following buttons:

Button Name	Button Description
Edit	Used to edit the details of bill line items.
Delete	Used to delete the bill line items.

Bill Line Items

The **Bill Line Items** zone lists the debit and credit bill segments and adjustments of the bill. This zone contains the following columns:

Column Name	Column Description
Bill ID	Displays the bill ID.
Entity ID	Displays the bill segment or adjustment ID.
Entity Type	Indicates whether the entity is a bill, bill segment or an adjustment.
Currency	Displays the currency in which the entity was created.
Entity Amount	Displays the bill segment or adjustment amount.
Request Amount	Displays the bill segment or adjustment amount which is eligible for refund. In other words, it means entity amount minus amount refunded.
	Note: If the bill segment or adjustment has debit balance, the eligible amount for refund would be zero.
Contract Information	Displays additional information about the contract against which the bill segment or adjustment is created. In addition, this column has a context menu which helps in navigating to other screens in the application.
	Note: It has a link. On clicking the link, the Contract screen appears where you can view the details of the respective contract.
Adjustment Type	Indicates the adjustment type using which the refund adjustment must be created.
	Note: It has a link. On clicking the link, the Adjustment Type screen appears where you can view the details of the respective adjustment type.
Adjustment Information	Displays information about the refund adjustment.

By default, the **Bill Line Items** zone does not appear in the **Main** tab. It appears only when you click the **Broadcast** (📡) icon corresponding to the bill in the **Write Off Details** zone.

Related Topics

For more information on...	See...
How to add a debit bill line item to the write off request	Adding a Debit Bill Line Item to the Write Off Request on page 2590

Write Off Request - Bills

The **Bills** tab allows you to search bills with debit line items, such as debit bill segments and adjustments, that you want to write off. It contains the following zones:

- [Search Bills](#) on page 2583

- [Bill Line Items](#) on page 2584

Search Bills

The **Search Bills** zone lists completed bills of the account which are either with debit balance or have one or more debit line items, such as bill segments and adjustments. You can filter the bills using various search criteria. This zone contains the following two sections:

- **Search Criteria** — The **Search Criteria** section contains the following fields:

Field Name	Field Description	Mandatory (Yes or No)
Search By	Used to indicate that you want to search for a bill using the bill details. The valid values are: <ul style="list-style-type: none"> • Bill Details • Bill and Price Item Details 	Yes
	Note: By default, the Bill Details option is selected.	
Bill ID	Used to search a particular bill.	No
Bill Date From	Used to search bills which are created from a particular date onwards.	No
To	Used to search bills which are created till a particular date.	No
Price Item	Used to search bills which are created for a particular price item.	No
	Note: This field appears when you select Bill and Price Item Details option from the Search By list. You can search for a price item by clicking the search (🔍) icon corresponding to the field.	

- **Search Results** — On clicking the **Search** button, the search results are filtered based on the specified search criteria. The **Search Results** section contains the following columns:

Column Name	Column Description
Bill ID	Displays the bill ID.
Bill Information	Displays additional information about the bill. In addition, this column has a context menu which helps in navigating to other screens in the application.
	Note: It has a link. On clicking the link, the Bill screen appears with the details of the respective bill.
Amount	Displays the total bill amount.

If you want to write off a bill with debit balance and all debit line items, you need to select the check box corresponding to the bill and then click the **Add** button in the **Search Results** section. All debit bill segments and adjustments of the bill are added in the **Write Off Details** zone on the **Main** tab. However, if you select a bill (with debit balance) which contains one or more credit line items or if you select a bill (with credit balance) which contains one or more debit line items, the system will not allow you to add the debit line items by directly

adding the bill. In such case, you need to individually select the debit bill segments and adjustments of the bill and then add them to the write off request.

Note: If a write off request is currently in progress for a debit bill segment or adjustment of a bill, those bills of the account are not listed in the **Search Bills** zone. In addition, a bill with all credit line items are not listed in the **Search Bills** zone.

Related Topics

For more information on...	See...
How to add a debit bill line item to the write off request	Adding a Debit Bill Line Item to the Write Off Request on page 2590

Bill Line Items

The **Bill Line Items** zone lists the debit and credit bill segments and adjustments of the bill. This zone contains the following columns:

Column Name	Column Description
Entity ID	Displays the bill segment or adjustment ID.
Entity Type	Indicates whether the entity is a bill segment or an adjustment.
Entity Information	<p>Displays additional information about the bill segment or adjustment. If the entity is a bill segment, the context menu appears in the column which helps in navigating to other screens in the application.</p> <p>Note: It has a link. If the entity is a bill segment, the Bill Segment screen appears where you can view the details of the respective bill segment on clicking the link. However, if the entity is an adjustment, the Adjustment screen appears with the details of the respective adjustment on clicking the link.</p>
Entity Amount	Displays the bill segment or adjustment amount.
Eligible Amount	<p>Displays the bill segment or adjustment amount which is eligible for write off. In other words, it means entity amount minus amount written off.</p> <p>Note: If the bill segment or adjustment has credit balance, the eligible amount for write off would be zero.</p>
Amount Written Off	Displays the amount which is already written off to the account.
Contract Information	<p>Displays additional information about the contract against which the bill segment or adjustment is created. In addition, this column has a context menu which helps in navigating to other screens in the application.</p> <p>Note: It has a link. On clicking the link, the Contract screen appears where you can view the details of the respective contract.</p>

You can select one or more debit bill segments or adjustments and click the **Add** button in this zone to add selected debit bill segments or adjustments to the write off request.

By default, the **Bill Line Items** zone does not appear in the **Bills** tab. It appears only when you click the **Broadcast** (📡) icon corresponding to the bill in the **Search Bills** zone.

Related Topics

For more information on...	See...
How to add a debit bill line item to the write off request	Adding a Debit Bill Line Item to the Write Off Request on page 2590

Write Off Request - Log

The **Log** tab contains the following zone:

- [Write Off Request Log](#) on page 2585

Write Off Request Log

The **Write Off Request Log** zone lists the complete trail of actions performed on the write off request. This zone contains the following columns:

Column Name	Column Description
Date/Time	Displays the date and time when the action was performed on the write off request.
Details	Displays the details about the action performed on the write off request.
User	Indicates the user who has performed the action on the write off request.
Log Type	Indicates the type of log.
Related Object	Indicates the object or entity which is generated when the action is performed on the write off request.
Status Reason	Displays the status reason of action performed on the write off request.

Note: You can manually add a log entry for the write off request by clicking the **Add Log Entry** link in the upper right corner of the **Write Off Request Log** zone.

The **Add Request Log** window appears. Enter **Log Details** and click **Save**. The write off request log is added.

Related Topics

For more information on...	See...
How to view the log of a write off request	Viewing the Log of a Write Off Request on page 2602

Creating a Write Off Request

Prerequisites

To create a write off request, you should have:

- Write off request types defined in the application

Procedure

To create a write off request:

1. Do either of the following:

If you want to...	Then...
Define a write off request from the Account Receivable Central screen	<ol style="list-style-type: none"> 1. Click the Main link in the Application toolbar. A list appears.

If you want to...	Then...
	<ol style="list-style-type: none"> 2. From the Main menu, select Accounting and Receivable and then click Account Receivable Central. 3. Search for the bill in the Account Receivable Central screen. 4. In the Search Results section, select the required bill and then click Write Off. <p>Note: Only one bill at a time is allowed to select for Write Off Request from the Account Receivable Central screen.</p>
Define a write off request from the Write Off Request screen	<ol style="list-style-type: none"> 1. Click the Main link in the Application toolbar. A list appears. 2. From the Main menu, select Accounting and Receivable and then click Refund/Write Off Request. A sub-menu appears. 3. Click the Add option from the Refund/Write Off Request sub-menu.

The **Select Request Type** screen appears. It contains the following fields:

Field Name	Field Description	Mandatory (Yes or No)
Action	<p>Displays the type of request (refund or write off) to be created.</p> <p>Note: This field is pre-populated if the write off request is created from the Account Receivable Central screen. This field is editable if the write off request is created from the Refund/Write Off Request screen.</p>	Yes
Refund/Write Off Request Type	<p>Used to indicate the request type using which you want to create the refund or write off request.</p> <p>Note: The refund request types are listed when you set the Action field to Refund and the write off request types are listed when you set the Action field to Write Off.</p>	Yes
Account	Used to indicate the account for which you want to create the refund or write off request.	Yes

Field Name	Field Description	Mandatory (Yes or No)
	<p>Note:</p> <p>This field is pre-populated if the write off request is created from the Account Receivable Central screen.</p> <p>This field is editable if the write off request is created from the Refund/Write Off Request screen.</p> <p>You can search for an account by clicking the Search (🔍) icon corresponding to the respective field.</p>	

Tip: Alternatively, you can access the **Select Request Type** screen by clicking the **Add** button in the **Page Title** area of the **Refund/Write Off Request** screen.

2. Select the required write off request type and account from the respective fields.
3. Click **Save**.

The write off request is defined and the status of the write off request is set to **Draft**. The **Write Off Request** screen appears with the details of the write off request. It contains the following tabs:

Note: The write off request can be created only for bill with outstanding amount greater than zero.

- **Main** – Displays information about the write off request. It contains the following zones:
 - **Write Off Request** – Displays the details of the write off request.
 - **Write Off Details** – Lists the debit bill line items (such as debit bill segments and adjustments) of the account which must be written off.
 - **Bills** — Used to search bills with debit line items, such as debit bill segments and adjustments, that you want to write off. This tab appears when the write off request is in the **Draft** status.
 - **Log** – Lists the complete trail of actions performed on the write off request.
- 4. Add debit bill line items that you want to write off.
- 5. Edit the write off amount of each entity, if required.
- 6. Define characteristics for the write off request, if required.

Related Topics

For more information on...	See...
Write Off Request screen	Write Off Request on page 2578
Account Receivable Central screen	Account Receivable Central on page 1538
How to add a debit bill line item to the write off request	Adding a Debit Bill Line Item to the Write Off Request on page 2590
How to edit a write off request	Editing a Write Off Request on page 2591
How to define a characteristic for a write off request	Defining a Characteristic for a Write Off Request on page 2588

Defining a Characteristic for a Write Off Request

Prerequisites

To define a characteristic for a write off request, you should have:

- Characteristic types defined in the application (where the characteristic entity is set to **Refund Write Off Request**)

Procedure

To define a characteristic for a write off request:

1. Search for the write off request in the **Refund/Write Off Request** screen.
2. In the **Search Results** section, click the link in the **Refund/Write Off Request Information** column corresponding to the write off request whose details you want to edit.

The **Write Off Request** screen appears.

3. Click the **Edit** button in the **Write Off Request** zone.

The **Edit Write Off Request** screen appears.

Note: The **Edit** button appears only when the write off request is in the **Draft** status.

4. Ensure that the **Characteristics** section is expanded when you are editing the write off request.

The **Characteristics** section contains the following fields:

Field Name	Field Description	Mandatory (Yes or No)
Effective Date	Used to specify the date from when the characteristic is effective for the write off request.	Yes (Conditional)
		Note: This field is required when you are defining a characteristic for the write off request.
Characteristic Type	Used to indicate the characteristic type. Note: The list includes only those characteristic types where the characteristic entity is set to Refund Write Off Request .	Yes (Conditional)
		Note: This field is required when you are defining a characteristic for the write off request.
Characteristic Value	Used to specify the value for the characteristic type. Note: On specifying the value for a predefined characteristic type, the description of the characteristic value appears corresponding to the Characteristic Value field.	Yes (Conditional)
		Note: This field is required when you are defining a characteristic for the write off request.

5. Enter the required details in the **Characteristics** section.

Note: If you select a predefined characteristic type, the **Search** (🔍) icon appears corresponding to the **Characteristic Value** field. On clicking the **Search** icon, you can search for a predefined characteristic value.

6. If you want to define more than one characteristic for the write off request, click the **Add** (+) icon and then repeat step 5.

Note: However, if you want to remove a characteristic from the write off request, click the **Delete** (🗑️) icon corresponding to the characteristic.

Related Topics

For more information on...	See...
How to search for a write off request	Searching for a Refund or Write Off Request on page 2537
How to create a write off request	Creating a Write Off Request on page 2541

Adding a Debit Bill to the Write Off Request

Prerequisites

To add a debit bill to the write off request, you should have:

- Completed bills for the account with one or more debit line items

Procedure

To add a debit bill to the write off request:

1. Click the **Bills** tab in the **Write Off Request** screen.
The **Bills** tab appears.
2. Filter the bills, if required, in the **Search Bills** zone.

Note: If a write off request is currently in progress for a debit bill segment or adjustment of a bill, those bills of the account are not listed in the **Search Bills** zone. In addition, a bill with all credit line items are not listed in the **Search Bills** zone.

3. Do either of the following:

If...	Then...
A bill has all debit line items and you want to add the debit bill to the write off request	<ol style="list-style-type: none"> 1. In the Search Bills zone, select the bills that you want to write off. 2. Click the Add button available at the upper left corner of the Search Bills zone. <p>Note: Default adjustment type selected in the write off request type should be non A/P.</p>
A bill has debit balance and one or more credit line items and you want to add the debit bill to the write off request	<ol style="list-style-type: none"> 1. In the Search Bills zone, select the bills that you want to write off. 2. Click the Add button available at the upper left corner of the Search Bills zone. <p>Note: Default adjustment type selected in the write off request type should be non A/P.</p>

4. Click **Add**.

A message appears indicating that the selected bills are added to the write off request.

Note: If you select a bill (with credit balance) which contains one or more debit line items or if you select a bill (with debit balance) which contains one or more credit line items, the system will not allow you to add the debit line items by directly adding the bill. In such case, you need to individually select the debit bill segments and adjustments of the bill and then add them to the write off request.

5. Click **OK**.

Note that the debit bill segments or adjustments are added in the **Write Off Details** zone on the **Main** tab.

Note:

Irrespective of whether you select a debit bill, or debit bill segments or adjustments, the debit bill segments or adjustments are added in the **Write Off Details** zone. The debit bill is not added to the **Write Off Details** zone.

The system will not allow you to add a credit line item to the **Write Off Details** zone.

Related Topics

For more information on...	See...
How to create a write off request	Creating a Write Off Request on page 2541

Adding a Debit Bill Line Item to the Write Off Request

You can write off the debit bill line items, such as bill segments and adjustments, of the account. While adding a debit bill line item to the write off request, you can either:

- Directly add all debit line items of a bill to the write off request by adding the bill which has all bill segments and adjustments in debit
- Individually add a debit bill segment or adjustment of a bill (with one or more debit line items) to the write off request

Prerequisites

To add a debit bill line item to the write off request, you should have:

- Completed bills for the account with one or more debit line items

Procedure

To add a debit bill line item to the write off request:

1. Click the **Bills** tab in the **Write Off Request** screen.



The **Bills** tab appears.

2. Filter the bills, if required, in the **Search Bills** zone.

Note: If a write off request is currently in progress for a debit bill segment or adjustment of a bill, those bills of the account are not listed in the **Search Bills** zone. In addition, a bill with all credit line items are not listed in the **Search Bills** zone.

3. Do any of the following:

If...	Then...
A bill has all debit line items and you want to add a particular debit bill line item to the write off request	<ol style="list-style-type: none"> 1. In the Search Bills zone, click the Broadcast  icon corresponding to the bill whose line items you want to view.

If...	Then...
	<p>The Bill Line Items zone appears.</p> <ol style="list-style-type: none"> <li data-bbox="846 260 1396 352">2. Select the check box corresponding to the debit bill segment or adjustment that you want to write off.
A bill has debit balance and one or more credit line items	<ol style="list-style-type: none"> <li data-bbox="846 428 1396 533">1. In the Search Bills zone, click the Broadcast () icon corresponding to the bill whose line items you want to view. The Bill Line Items zone appears. <li data-bbox="846 611 1396 703">2. Select the check box corresponding to the debit bill segment or adjustment that you want to write off.
A bill has credit balance and one or more debit line items	<ol style="list-style-type: none"> <li data-bbox="846 758 1396 863">1. In the Search Bills zone, click the Broadcast () icon corresponding to the bill whose line items you want to view. The Bill Line Items zone appears. <li data-bbox="846 940 1396 1033">2. Select the check box corresponding to the debit bill segment or adjustment that you want to write off.

4. Click **Add**.

A message appears indicating that the selected bill segments or adjustments are added to the write off request.

Note: If you select a bill (with credit balance) which contains one or more debit line items or if you select a bill (with debit balance) which contains one or more credit line items, the system will not allow you to add the debit line items by directly adding the bill. In such case, you need to individually select the debit bill segments and adjustments of the bill and then add them to the write off request.

5. Click **OK**.

Note that the debit bill segments or adjustments are added in the **Write Off Details** zone on the **Main** tab.

Note:
Irrespective of whether you select a debit bill, or debit bill segments or adjustments, the debit bill segments or adjustments are added in the **Write Off Details** zone. The debit bill is not added to the **Write Off Details** zone.
The system will not allow you to add a credit line item to the **Write Off Details** zone.

Related Topics

For more information on...	See...
How to create a write off request	Creating a Write Off Request on page 2541

Editing a Write Off Request

Prerequisites

To edit a write off request, you should have:

- Adjustment types without A/P request type defined in the application

Procedure

To edit a write off request:

1. Search for the write off request in the **Refund/Write Off Request** screen.
2. In the **Search Results** section, click the link in the **Refund/Write Off Request Information** column corresponding to the write off request whose details you want to edit.

The **Write Off Request** screen appears.

3. Click the **Edit** button in the **Write Off Request** zone.

The **Edit Write Off Request** screen appears. It contains the following fields:

Field Name	Field Description	Mandatory (Yes or No)
Write Off Request Information	Displays information about the write off request.	Not applicable
Account Information	Indicates the account for which the write off request is created.	Not applicable
Comments	Used to specify additional information about the write off request.	No

In addition, this screen contains the following two sections:

- **Characteristics** — Used to define the characteristics for the write off request. It contains the following fields:

Field Name	Field Description	Mandatory (Yes or No)
Effective Date	Used to specify the date from when the characteristic is effective for the write off request.	Yes (Conditional)
		Note: This field is required when you are defining a characteristic for the write off request.
Characteristic Type	Used to indicate the characteristic type.	Yes (Conditional)
	Note: The list includes only those characteristic types where the characteristic entity is set to Refund Write Off Request .	Note: This field is required when you are defining a characteristic for the write off request.
Characteristic Value	Used to specify the value for the characteristic type.	Yes (Conditional)
	Note: On specifying the value for a predefined characteristic type, the description of the characteristic value appears corresponding to the Characteristic Value field.	Note: This field is required when you are defining a characteristic for the write off request.

4. Modify the details of the write off request, if required.
5. Define, edit, or remove characteristics of the write off request, if required.
6. Click **Save**.

The changes made to the write off request are saved.

Related Topics

For more information on...	See...
How to search for a write off request	Searching for a Refund or Write Off Request on page 2537
Write Off Request screen	Write Off Request on page 2578
Write Off Request zone	Write Off Request on page 2579
How to define a characteristic for a write off request	Defining a Characteristic for a Write Off Request on page 2588

Editing the Write Off Details

Prerequisites

To edit the write off details, you should have:

- Adjustment types with A/P request type defined in the application

Procedure

To edit the write off details:

1. Search for the write off request in the **Refund/Write Off Request** screen.
2. In the **Search Results** section, click the link in the **Refund/Write Off Request Information** column corresponding to the write off request whose bill line item details you want to edit.

The **Write Off Request** screen appears. You can edit the bill line items of the write off request by using either of the following ways:

If...	Then...
Select the bill whose details you want to edit in the Write Off Details zone and click the Edit button available in the upper left corner of this zone.	The Edit Request Details screen appears.
In the Write Off Details zone, click the Broadcast (📡) icon corresponding to the bill whose line items details you want to edit.	The Bill Line Items zone appears.
	<p>Note: This zone appears when the Entity Type is Bill.</p> <ol style="list-style-type: none"> 1. Select the bill line item whose details you want to edit in the Bill Line Items zone and click the Edit button available in the upper left corner of this zone. <p>The Edit Request Details screen appears.</p>

Note: A bill line item from the write off request can be edited when the write off request is in the **Draft** status.

The **Edit Request Details** screen appears. It contains the following fields:

Field Name	Field Description	Mandatory (Yes or No)
Request ID	Displays the write off request ID.	Not applicable
Account Information	Displays additional information about the account.	Not applicable
Adjustment Type	Indicates the adjustment type of the write off request type. You can search for an adjustment type by clicking the Search (🔍) icon corresponding to the field.	No

In addition to these fields, this screen contains following columns:

Column Name	Column Description
Entity Type	Indicates the entity type. The valid values are <ul style="list-style-type: none"> • Adjustments • Bill • Bill Segment • Payment Event • Payment
Entity ID	Displays the entity ID.
Entity Amount	Displays the entity amount.
Currency	Displays the currency in which the entity was created.
Request Amount	Displays the amount that must be write off.
Adjustment Type	Indicates the adjustment type using which the write off adjustment must be created. Note: You can search for an account by clicking the Search (🔍) icon corresponding to the field.
Bill ID	Displays the bill ID.

In addition to the above columns, the screen has following button:

Button Name	Button Description
Override	Used to override an adjustment type of the write off request.

Note:

Pagination is used to display limited number of records in the **Search Results** section. By default, 10 records are displayed in the **Search Results** section. You can change the number of records displayed per page, if required.

You can use the navigation buttons, such as **First** (<<), **Previous** (<), **Next** (>), and **Last** (>>) to navigate between pages. You can also select the page to which you want to navigate from the **Go To** list.

The values appear in the **Page Limit** list when you define values for the **PAGE_NUMBER** lookup field.

3. Modify the details of the bill line items.
4. Click **Save**.

The changes made to the write off bill line items are saved.

Related Topics

For more information on...	See...
Write Off Request screen	Write Off Request on page 2578
Write Off Request zone	Write Off Request on page 2579
How to search for a write off request	Searching for a Refund or Write Off Request on page 2537

Deleting a Write Off Request**Procedure**

To delete a write off request:

1. Search for the write off request in the **Refund/Write Off Request** screen.
2. In the **Search Results** section, click the link in the **Refund/Write Off Request Information** column corresponding to the write off request that you want to delete.

The **Write Off Request** screen appears.

3. Click the **Delete** button in the **Write Off Request** zone.

A message appears confirming whether you want to delete the write off request.

Note: The **Delete** button appears when the write off request is in the **Draft** status.

4. Click **OK**.

The write off request is deleted.

Related Topics

For more information on...	See...
How to search for a write off request	Searching for a Refund or Write Off Request on page 2537
Write Off Request screen	Write Off Request on page 2578
Write Off Request zone	Write Off Request on page 2579

Deleting a Bill from the Write Off Request

Procedure

To delete a bill from the write off request:

1. Search for the write off request in the **Refund/Write Off Request** screen.
2. In the **Search Results** section, click the link in the **Refund/Write Off Request Information** column corresponding to the write off request whose bill you want to delete.

The **Write Off Request** screen appears.

3. In the **Write Off Details** zone, select the bills and click the **Delete** button available in the upper left corner of this zone.

A message appears confirming whether you want to delete the bill from the write off request.

Note: You can delete bill from the write off request when the request is in the **Draft** status.

4. Click **OK**.

The selected bill gets deleted from the write off request.

Related Topics

For more information on...	See...
Write Off Request screen	Write Off Request on page 2578
Write Off Request zone	Write Off Request on page 2579
How to search for a write off request	Searching for a Refund or Write Off Request on page 2537

Deleting a Bill Line Item from the Write Off Request

Procedure

To delete a bill line item from the write off request:

1. Search for the write off request in the **Refund/Write Off Request** screen.
2. In the **Search Results** section, click the link in the **Refund/Write Off Request Information** column corresponding to the write off request whose bill line items you want to delete.

The **Write Off Request** screen appears.

3. In the **Write Off Details** zone, click the **Broadcast** () icon corresponding to the bill whose line items details you want to delete.

The **Bill Line Items** zone appears.

4. In the **Bill Line Items** zone, select the bill line items which you want to delete and click the **Delete** button available in the upper left corner of this zone.

A message appears confirming whether you want to delete the bill line items from the write off request.

Note: You can delete a bill line items from the write off request when the request is in the **Draft** status.

5. Click **OK**.

The selected bill line items gets deleted from the write off request.

Related Topics

For more information on...	See...
Write Off Request screen	Write Off Request on page 2578
Write Off Request zone	Write Off Request on page 2579
How to search for a write off request	Searching for a Refund or Write Off Request on page 2537

Submitting a Write Off Request

Prerequisites

To submit a write off request, you should have:

- Debit bill line items added in the write off request

Procedure

To submit a write off request:

1. Search for the write off request in the **Refund/Write Off Request** screen.
2. In the **Search Results** section, click the link in the **Refund/Write Off Request Information** column corresponding to the write off request that you want to submit.

The **Write Off Request** screen appears.

3. Click the **Submit** button in the **Write Off Request** zone.

The system behaves in the following manner:

If...	Then
The Approval Required and Hierarchical Approval check boxes are selected in the write off request type using which the write off request is created	A To Do of the C1-WOREQ To Do type is created and sent to the approver at the first level in the approval hierarchy, and the status of the write off request is changed to Approval In Progress .
The Approval Required check box is selected, but the Hierarchical Approval check box is not selected in the write off request type using which the write off request is created	A To Do of the C1-WOREQ To Do type is created and sent to the approver at the hierarchy level where the total write off amount falls within the threshold limit. In addition, the status of the write off request is changed to Approval In Progress .
The Approval Required check box is not selected in the write off request type using which the write off request is created	The write off adjustments are created using the specified adjustment types and the status of the write off request is changed to Processed .

If...	Then
	<p>Note: The write off adjustments are created in the Frozen status. If a match event is present for the debit bill line items (such as bill segments and adjustments), the existing match event is stamped on the write off adjustments and on the corresponding financial transactions. However, if the match events does not exist, a new match event is created and stamped on the write off adjustments and on the corresponding financial transactions. If you are doing a partial write off for any entity, the corresponding match event status is set to Open. However, if the entire eligible amount is written off, the corresponding match event status is set to Balanced.</p>
<p>The total write off amount is less than the minimum threshold amount</p>	<p>The write off request is automatically approved by the system and write off adjustments are created using the specified adjustment types. In addition, the status of the write off request is changed to Processed.</p> <p>Note: The write off adjustments are created in the Frozen status. If a match event is present for the debit bill line items (such as bill segments and adjustments), the existing match event is stamped on the write off adjustments and on the corresponding financial transactions. However, if the match events does not exist, a new match event is created and stamped on the write off adjustments and on the corresponding financial transactions. If you are doing a partial write off for any entity, the corresponding match event status is set to Open. However, if the entire eligible amount is written off, the corresponding match event status is set to Balanced.</p>

Note: The **Submit** button appears when the write off request is in the **Draft** status.

Related Topics

For more information on...	See...
How to search for a write off request	Searching for a Refund or Write Off Request on page 2537
Write Off Request screen	Write Off Request on page 2578
Write Off Request zone	Write Off Request on page 2579

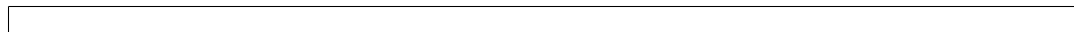

Approving a Write Off Request

You can view the number of write off requests which are pending for approval in the **Refund/Write Off Request** screen. The approver can review, and accordingly approve or reject the write off request based on the observations.

Note: The system will not allow you to approve or reject a write off request submitted by you.

Procedure

To approve a write off request:

1. Do either of the following:

If you want to...	Then...
Approve a write off request through the Refund/Write Off Request screen	<ol style="list-style-type: none"> 1. Search for the write off request in the Refund/Write Off Request screen. 2. In the Search Results section, click the link in the Refund/Write Off Request Information column corresponding to the write off request which you want to review.
Approve a write off request from the To Do List screen	<ol style="list-style-type: none"> 1. Click the Menu link in the Application toolbar. A list appears. 2. From the Main menu, select To Do and then click To Do List. The To Do Type for User Search window appears. 3. Enter C1-WOREQ in the To Do Type field. 4. Click the Search button corresponding to the To Do Type field. The To Do List screen appears. 5. Select the Open option from the Filter by list to view all unassigned To Dos. 6. Click the link in the Message column corresponding to the To Do of the write off request that you want to review.

The **Write Off Request** screen appears.

2. Review the write off request details.
3. Click the **Approve** button in the **Write Off Request** zone.

The system behaves in the following manner:

If...	Then...
The Hierarchical Approval check box is selected in the write off request type using which the write off request is created and the total write off amount is greater than the threshold amount specified at the next level in the approval hierarchy	A To Do of the C1-WOREQ To Do type is created and sent to the approver at the next level in the approval hierarchy, and the status of the write off request remains as Approval In Progress .
The Hierarchical Approval check box is selected in the write off request type using which the write off request is created and the total write off amount is less than the threshold amount specified at the next level in the approval hierarchy	The write off adjustments are created using the specified adjustment types and the status of the write off request is changed to Processed .

If...	Then...
	<p>Note: The write off adjustments are created in the Frozen status. If a match event is present for the debit bill line items (such as bill segments and adjustments), the existing match event is stamped on the write off adjustments and on the corresponding financial transactions. However, if the match events does not exist, a new match event is created and stamped on the write off adjustments and on the corresponding financial transactions. If you are doing a partial write off for any entity, the corresponding match event status is set to Open. However, if the entire eligible amount is written off, the corresponding match event status is set to Balanced.</p>
<p>The Hierarchical Approval check box is not selected in the write off request type using which the write off request is created</p>	<p>The write off adjustments are created using the specified adjustment types and the status of the write off request is changed to Processed.</p> <p>Note: The write off adjustments are created in the Frozen status. If a match event is present for the debit bill line items (such as bill segments and adjustments), the existing match event is stamped on the write off adjustments and on the corresponding financial transactions. However, if the match events does not exist, a new match event is created and stamped on the write off adjustments and on the corresponding financial transactions. If you are doing a partial write off for any entity, the corresponding match event status is set to Open. However, if the entire eligible amount is written off, the corresponding match event status is set to Balanced.</p>

Note: The **Approve** button appears when:

- The write off request is in the **Approval In Progress** status.
- A user with the approval To Do role is reviewing the write off request.

Related Topics

For more information on...	See...
How to search for a write off request	Searching for a Refund or Write Off Request on page 2537
Write Off Request screen	Write Off Request on page 2578
Write Off Request zone	Write Off Request on page 2579

Rejecting a Write Off Request

Prerequisites

To reject a write off request, you should have:

- Rejection reasons defined in the application

Note:

While rejecting a write off request, you need to specify the reason why you want to reject the write off request. You can select the appropriate rejection reason when you have defined the reasons for the **Rejected** status of the **C1-WORequest** business object in the **Status Reason** screen.

The system will not allow you to approve or reject a write off request submitted by you.

Procedure

To reject a write off request:

1. Do either of the following:

If you want to...	Then...
Reject a write off request through the Refund/Write Off Request screen	<ol style="list-style-type: none"> 1. Search for the write off request in the Refund/Write Off Request screen. 2. In the Search Results section, click the link in the Refund/Write Off Request Information column corresponding to the write off request which you want to review.
Reject a write off request from the To Do List screen	<ol style="list-style-type: none"> 1. Click the Menu link in the Application toolbar. A list appears. 2. From the Main menu, select To Do and then click To Do List. The To Do Type for User Search window appears. 3. Enter C1-WOREQ in the To Do Type field. 4. Click the Search button corresponding to the To Do Type field. The To Do List screen appears. 5. Select the Open option from the Filter by list to view all unassigned To Dos. 6. Click the link in the Message column corresponding to the To Do of the write off request that you want to review.

The **Write Off Request** screen appears.

2. Review the write off request details.
3. Click the **Reject** button in the **Write Off Request** zone.

The **Reject Write Off Request** window appears. It contains following fields:

Field Name	Field Description	Mandatory (Yes or No)
Status Reason	Used to indicate the reason why you want to reject the write off request.	Yes
Comments	Used to specify additional information while rejecting the write off request.	No

Note: The **Reject** button appears when:

- The write off request is in the **Approval In Progress** status.
- A user with the approval To Do role is reviewing the write off request.

4. Select the rejection reason from the **Status Reason** list.

5. Click **Save**.

The status of the write off request is changed to **Rejected**.

Related Topics

For more information on...	See...
How to search for a write off request	Searching for a Refund or Write Off Request on page 2537
Write Off Request screen	Write Off Request on page 2578
Write Off Request zone	Write Off Request on page 2579

Viewing the Log of a Write Off Request

Procedure

To view the log of a write off request:

1. Search for the write off request in the **Refund/Write Off Request** screen.
2. In the **Search Results** section, click the link in the **Refund/Write Off Request Information** column corresponding to the write off request whose log you want to view.

The **Write Off Request** screen appears. It consists of the following tabs:

- **Main** – Displays information about the write off request. It contains the following zones:
 - **Write Off Request** – Displays the details of the write off request.
 - **Write Off Details** – Lists the debit bill line items (such as debit bill segments and adjustments) of the account which must be written off.
 - **Bill Line Items** — Displays the details of the bill which must be written off.

Note:

This zone appears when you click the Broadcast () icon corresponding to the entity type as **Bill** in the **Write Off Details** zone.

- **Bills** — Used to search bills with debit line items, such as debit bill segments and adjustments, that you want to write off. This tab appears when the write off request is in the **Draft** status.
- **Log** – Lists the complete trail of actions performed on the write off request.

3. Click the **Log** tab
4. View the log of the write off request in the **Write Off Request Log** zone.

Note: You can manually add a log entry for the write off request by clicking the **Add Log Entry** link in the upper right corner of the **Write Off Request Log** zone.

Related Topics

For more information on...	See...
How to search for a write off request	Searching for a Refund or Write Off Request on page 2537
How to add a log entry for a write off request	Adding a Log Entry for a Write Off Request on page 2603
Write Off Request Log zone	Write Off Request Log on page 2585

Adding a Log Entry for a Write Off Request

Procedure

To add a log entry for a write off request:

1. Search for the write off request in the **Refund/Write Off Request** screen.
2. In the **Search Results** section, click the link in the **Refund/Write Off Request Information** column corresponding to the write off request whose log you want to edit.

The **Write Off Request** screen appears. It consists of the following tabs:

- **Main** – Displays information about the write off request. It contains the following zones:
 - **Write Off Request** – Displays the details of the write off request.
 - **Write Off Details** – Lists the debit bill line items (such as debit bill segments and adjustments) of the account which must be written off.
- **Bills** — Used to search bills with debit line items, such as debit bill segments and adjustments, that you want to write off. This tab appears when the write off request is in the **Draft** status.
- **Log** – Lists the complete trail of actions performed on the write off request.

3. Click the **Log** tab.

The **Log** tab appears.

4. Click the **Add Log Entry** link in the upper right corner of the **Write Off Request Log** zone.

The **Add Request Log** window appears. It contains the following fields:

Field Name	Field Description	Mandatory (Yes or No)
Request Information	Displays information about the write off request.	Not applicable
Log Details	Used to specify additional comments for the write off request.	Yes

5. Enter the comments in the **Log Details** field.
6. Click **Save**.

The log entry is added in the **Write Off Request Log** zone.

Related Topics

For more information on...	See...
How to search for a write off request	Searching for a Refund or Write Off Request on page 2537

Canceling a Write Off Request

There might be situations when incorrect write off request is processed in the system. In such case, the system provides you with an ability to cancel the write off request. However, note that you can cancel a write off request when the write off request is in the **Processed** status.

Prerequisites

To cancel a write off request, you should have:

- Cancel reasons defined in the application

Note: While cancelling a write off request, you need to specify the reason why you want to cancel the write off request. You can select the appropriate cancel reason when you have defined the reasons for the **Cancelled** status of the **C1-WORequest** business object in the **Status Reason** screen.

Procedure

To cancel a write off request:

1. Search for the write off request in the **Refund/Write Off Request** screen.
2. In the **Search Results** section, click the link in the **Refund/Write Off Request Information** column corresponding to the write off request that you want to cancel.

The **Write Off Request** screen appears.

3. Click the **Cancel** button in the **Write Off Request** zone.

The **Cancel Reason** window appears. It contains the following fields:

Field Name	Field Description	Mandatory (Yes or No)
Status Reason	Used to indicate the reason why you want to cancel the write off request.	Yes
Comments	Used to specify additional information while cancelling the write off request.	No

Note: The **Cancel** button appears when the write off request is in the **Processed** status.

4. Select the cancel reason from the **Status Reason** list.
5. Click **Save**.

The status of the write off request is changed to **Cancelled**.

Note: The **C1-WOCANCEL** algorithm cancels all the frozen adjustments created for the write off request which is in the **Processed** state.

Related Topics

For more information on...	See...
How to search for a write off request	Searching for a Refund or Write Off Request on page 2537
Write Off Request screen	Write Off Request on page 2578

For more information on...	See...
Write Off Request zone	Write Off Request on page 2579

Chapter 42

Deal Management

Topics:

- [Price Item Status Transition in a Deal](#)
- [Deal Status Transition](#)
- [Deal Approval Scenarios](#)
- [Different Stages in Deal Lifecycle](#)
- [Deal Monitoring](#)
- [Product Level Approval for Deals](#)
- [Recommended Pricing](#)
- [Deal Currency Conversion](#)
- [Reference Selection Based on Questionnaire](#)
- [Rate Negotiability for Price Item in Deal](#)
- [Price Item Selection during Deal Creation](#)
- [Price Item and Hierarchy Entity Selection in a Deal Based on Characteristic Value](#)
- [Seasonal Pricing for Price Items in a Deal](#)
- [Include Customer Hierarchy in a Deal](#)
- [Contracted Deal](#)
- [Deal Inactivation](#)
- [Average Price Validation Using Floor and Ceil Limits](#)
- [Considering Pass Through Charges While Calculating Original Revenue](#)

Oracle Revenue Management and Billing enables you to create a deal for an existing customer, account, or prospect person. A deal facilitates you to simulate the proposed pricing on the proposed commitments, and thereby analyze the cost, revenue, and profitability of the deal. The system provides different ways in which you can simulate the pricing for an existing customer, account, or prospect person. You can use the following simulation types while creating a deal:

- **Customer** - This simulation type can be used while creating a deal for an existing customer or a prospect person. If you use this simulation type for an existing customer, the system does the following:
 - Copies the customer, all its accounts, and the customer hierarchy (i.e. its child persons and child persons' accounts), and creates the corresponding prospect persons and accounts in the system
 - Copies the price list assignments and price assignments of the customer, accounts, child persons and child persons' accounts, and assigns the price lists and pricing to the respective prospect persons and accounts in the **Proposed** status
 - Copies the product enrollments of the customer's and child persons' accounts, and enrolls the respective prospect accounts for the products in the **Proposed** status
 - Copies the commitments from the SQI-based billable charges of the customer's and child persons' accounts (based on the deal frequency and usage period), and accordingly adds proposed commitments for the respective prospect accounts

However, if you use this simulation type for a prospect person, you need to manually:

- Assign a price list and pricing to the prospect person, its accounts, and to its hierarchy
 - Enroll the prospect account for a product
 - Add commitments for the prospect account
- **Account** - This simulation type can be used while creating a deal for an existing account. If you use this simulation type, the system does the following:
 - Copies the account and creates the corresponding prospect account in the system
 - Copies the price list assignments and price assignments of the account and assigns the price lists and pricing to the respective prospect account in the **Proposed** status

- [Considering SQI Based Billable Charges While Calculating Commitments](#)
- [Stacking Commitments in Deal](#)
- [Terms and Conditions Selection in a Deal Based on Characteristic Value](#)
- [Terms and Conditions Grouping in a Deal Based on Characteristic Value](#)
- [Overriding Terms and Conditions in a Deal](#)
- [Refreshing Terms and Conditions in a Deal](#)
- [Deal Approval Profile](#)
- [Deal Type](#)
- [Questionnaire Template \(Used for Searching\)](#)
- [Questionnaire Template \(Used for Viewing\)](#)
- [Prospect](#)
- [Deal Dashboard](#)
- [Deal Compare](#)
- [Deal Profitability Report](#)
- [Deal Approval Workflow](#)
- [Deal Information](#)
- [Pricing and Commitments](#)
- [Deal Pricing and Commitments](#)
- [Price List Assignment](#)
- [Product Enrollment](#)
- [Pricing and Commitments](#)
- [Mapping Terms and Conditions](#)
- [Terms and Conditions](#)
- [Deal Log and Comments](#)
- [Deal Version Log and Comments](#)
- [Adhoc Revenue and Cost](#)
- [Terms and Conditions Mapping](#)
- [Deal Approver Dashboard](#)

- Copies the product enrollments of the account, and enrolls the respective prospect account for the products in the **Proposed** status
- Copies the commitments from the SQI-based billable charges of the account (based on the deal frequency and usage period), and accordingly adds proposed commitments for the respective prospect account
- **Deal** - This simulation type can be used while creating a deal for an existing customer or a prospect person. If you use this simulation type for an existing customer, the system does the following:
 - Copies the customer and creates the corresponding prospect customer in the system
 - Copies the price list assignments and price assignments of the customer, and assigns the price lists and pricing to the respective prospect person in the **Proposed** status
 - Copies the commitments from the SQI-based billable charges of the customer's accounts (based on the deal frequency and usage period), and accordingly adds the rolled up proposed commitments for the respective prospect person

However, if you use this simulation type for a prospect person, you need to manually:

- Assign a price list and pricing to the prospect person
- Add commitments for the prospect person

For more information about different stages involved in the deal lifecycle, see [Different Stages in Deal Lifecycle](#) on page 2643.

Note: The **Deal Management** feature is tested and certified on Google Chrome and not on Internet Explorer.

Price Item Status Transition in a Deal

The following figure graphically indicates how a price item moves from one status to another in a deal lifecycle. Since the price item status transition flow spans across multiple pages, we have split the flow into four parts — Part 1a, Part 1b, Part 1c, and Part 1d.

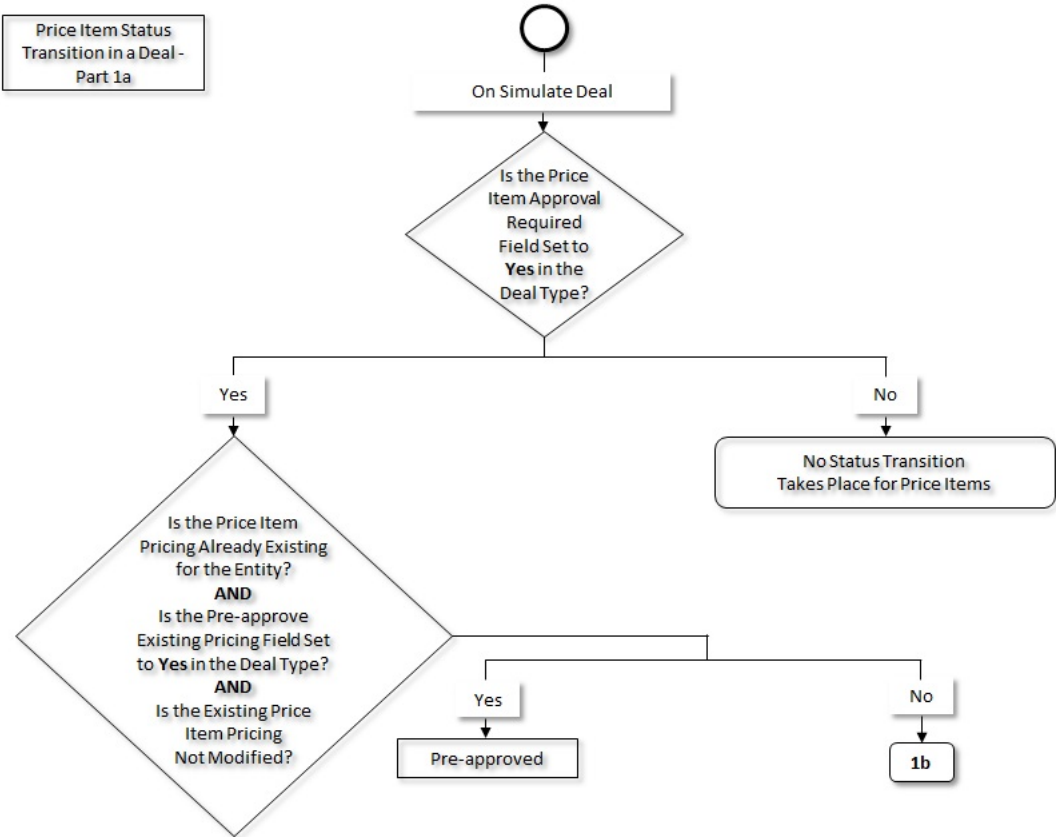

Price Item Status
Transition in a Deal -
Part 1b

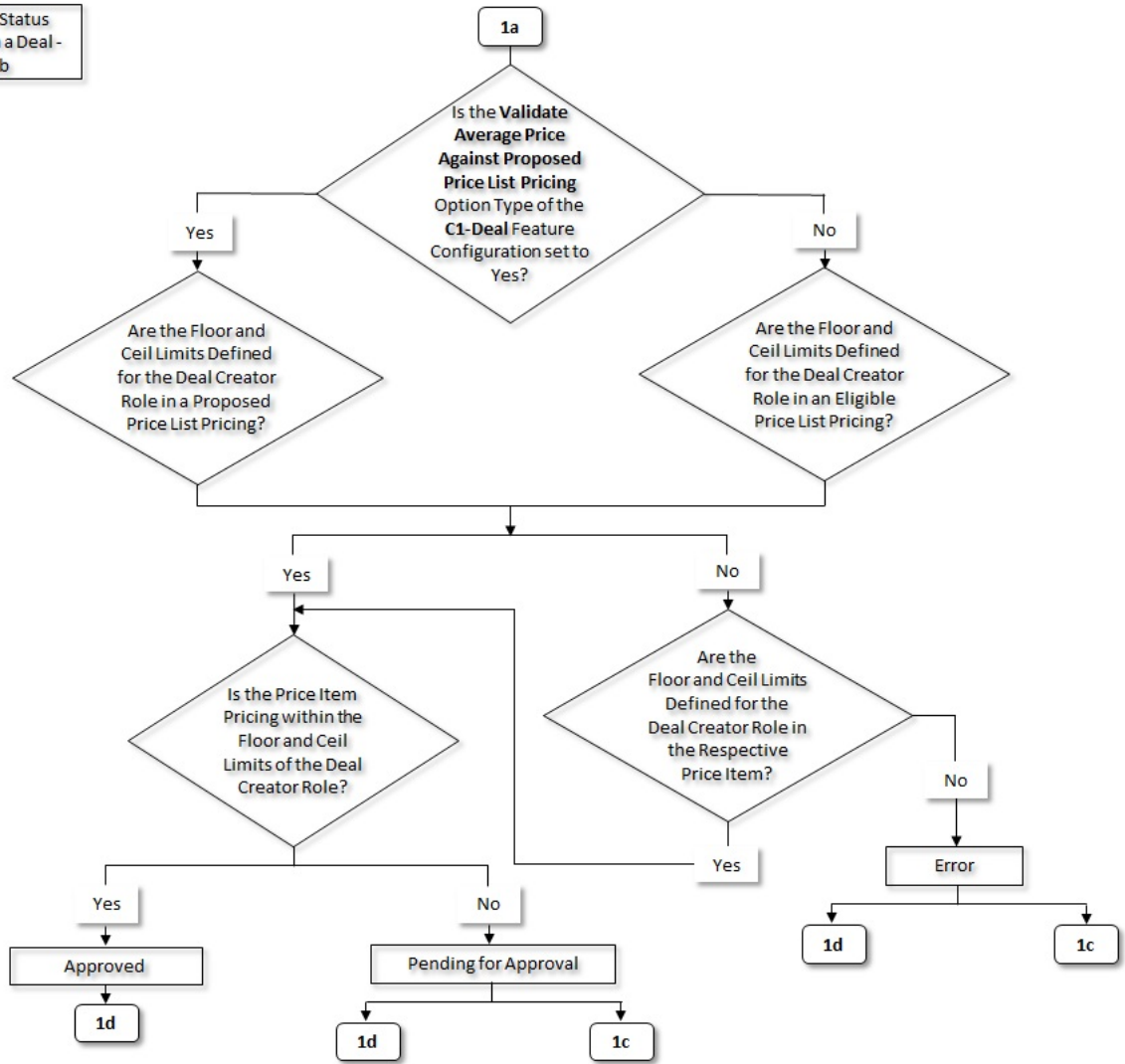

Price Item Status Transition in a Deal - Part 1c

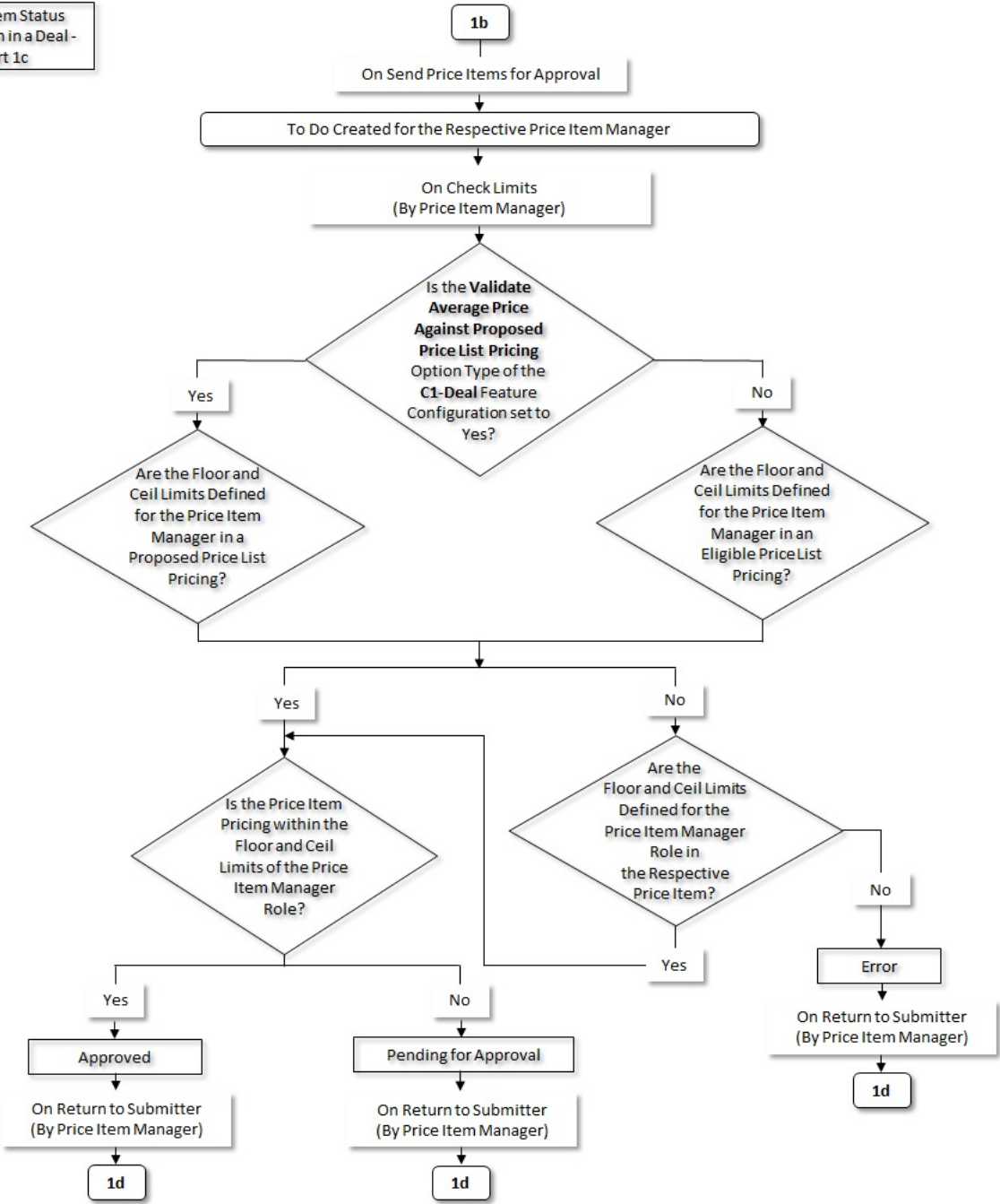

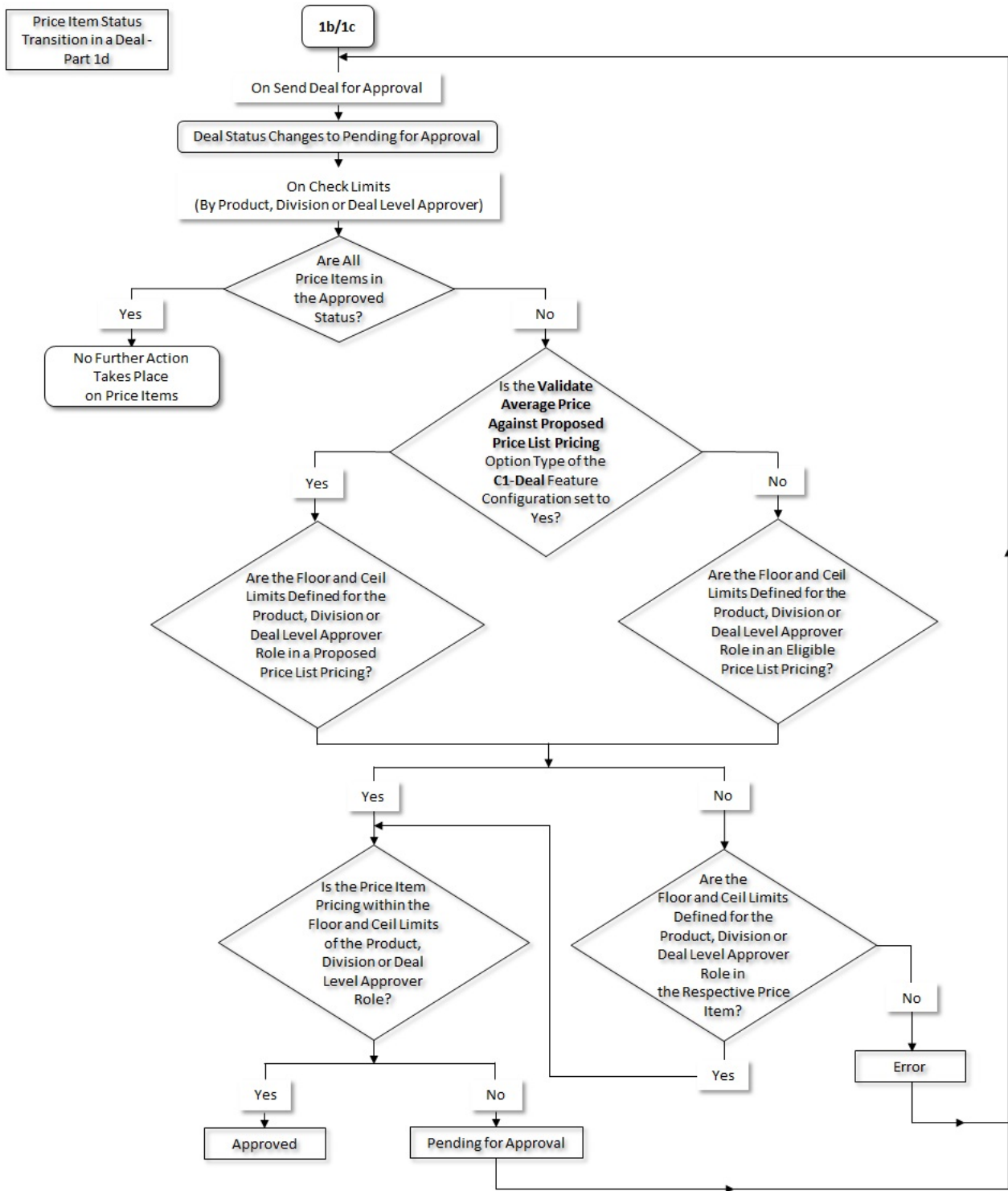

Deal Status Transition

The following figure graphically indicates how a deal moves from one status to another in its lifecycle. Since the deal status transition flow spans across multiple pages, we have split the flow into multiple parts — Part 2a, Part 2b, Part 2c, Part 2d, Part 2e, Part 2f, Part 2g, Part 2h, Part 2i, Part 2j, Part 2k, Part 2l, Part 2m, and Part 2n.

Deal Status Transition – Part 2a

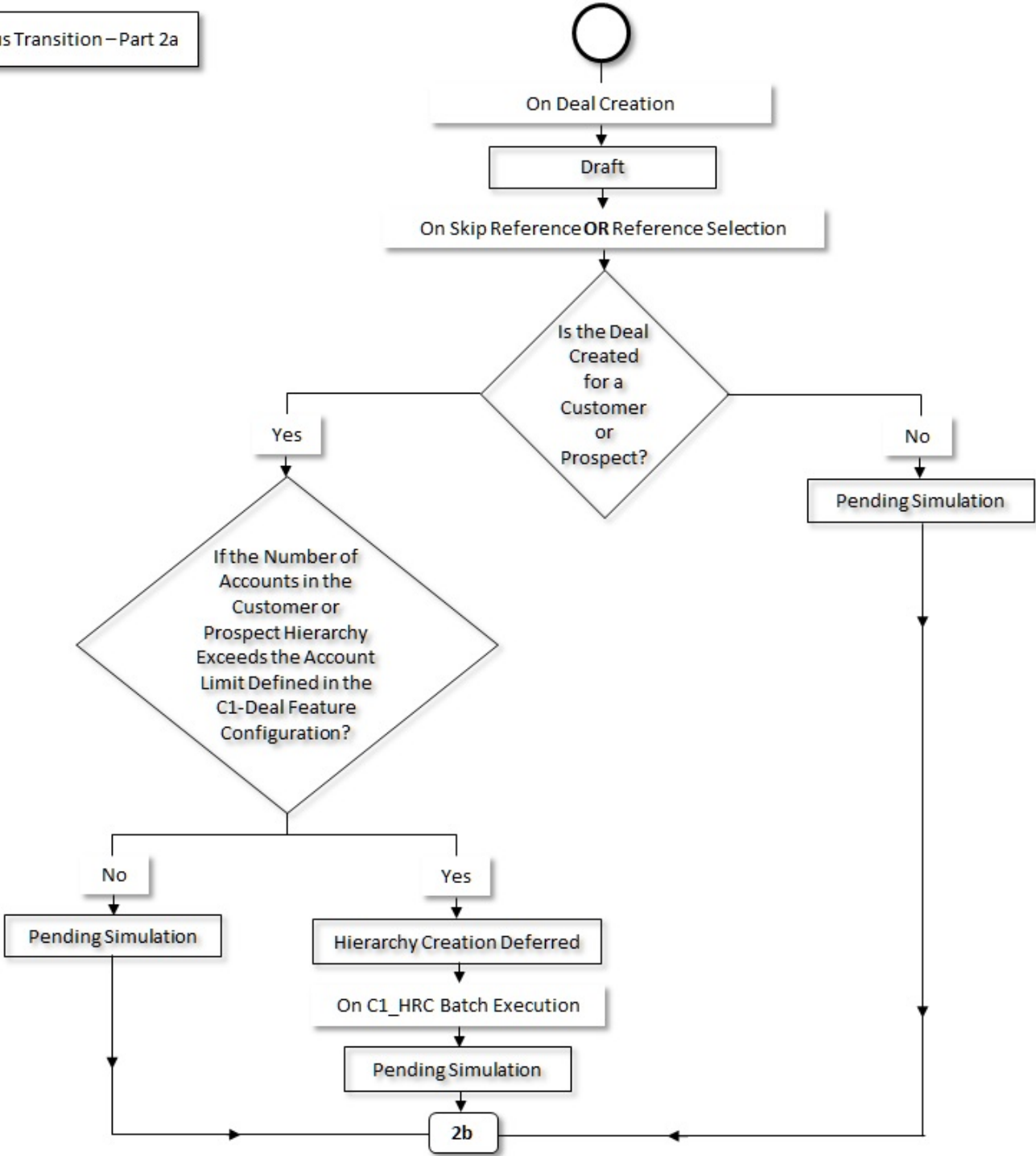

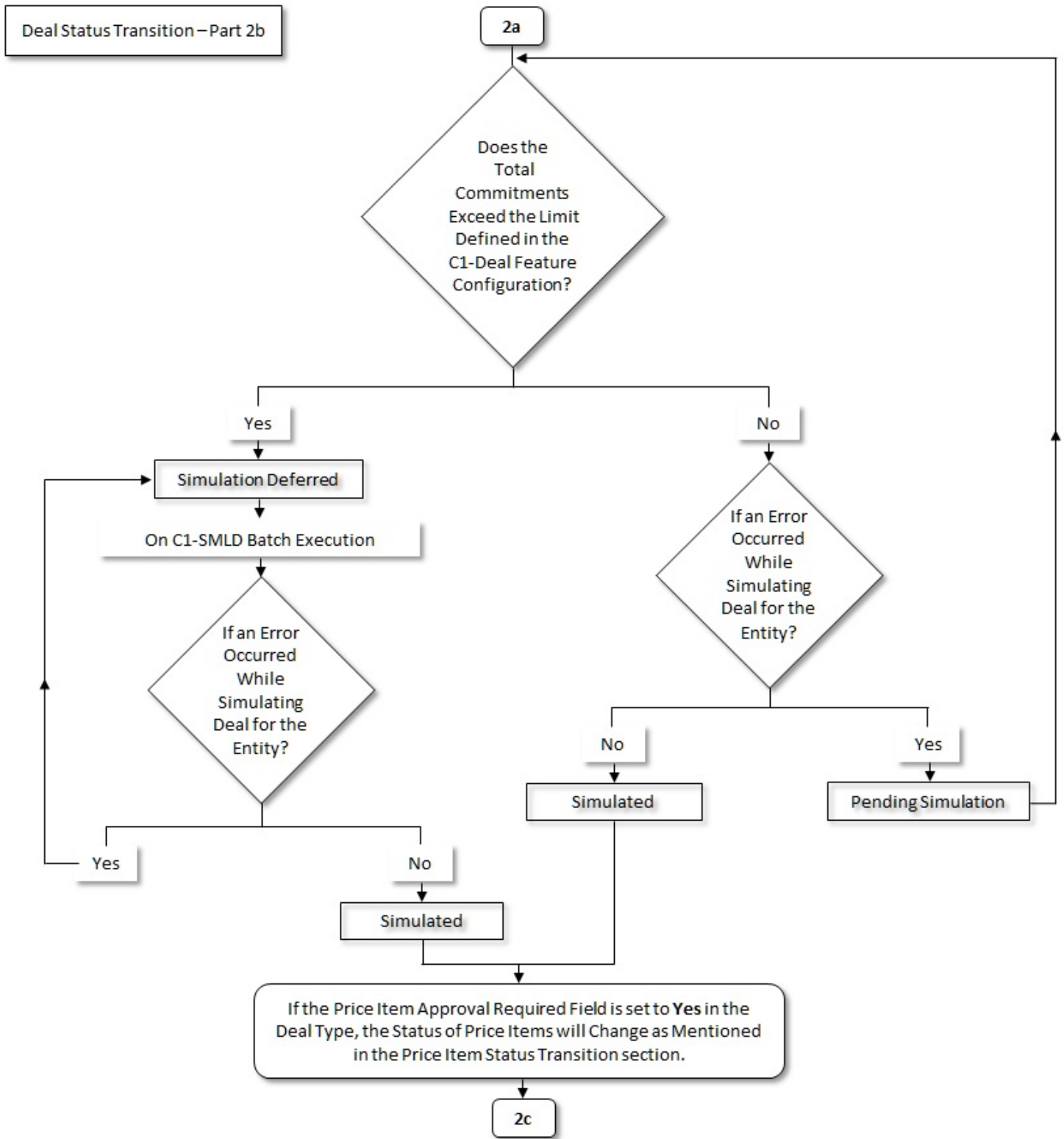

Deal Status Transition – Part 2c

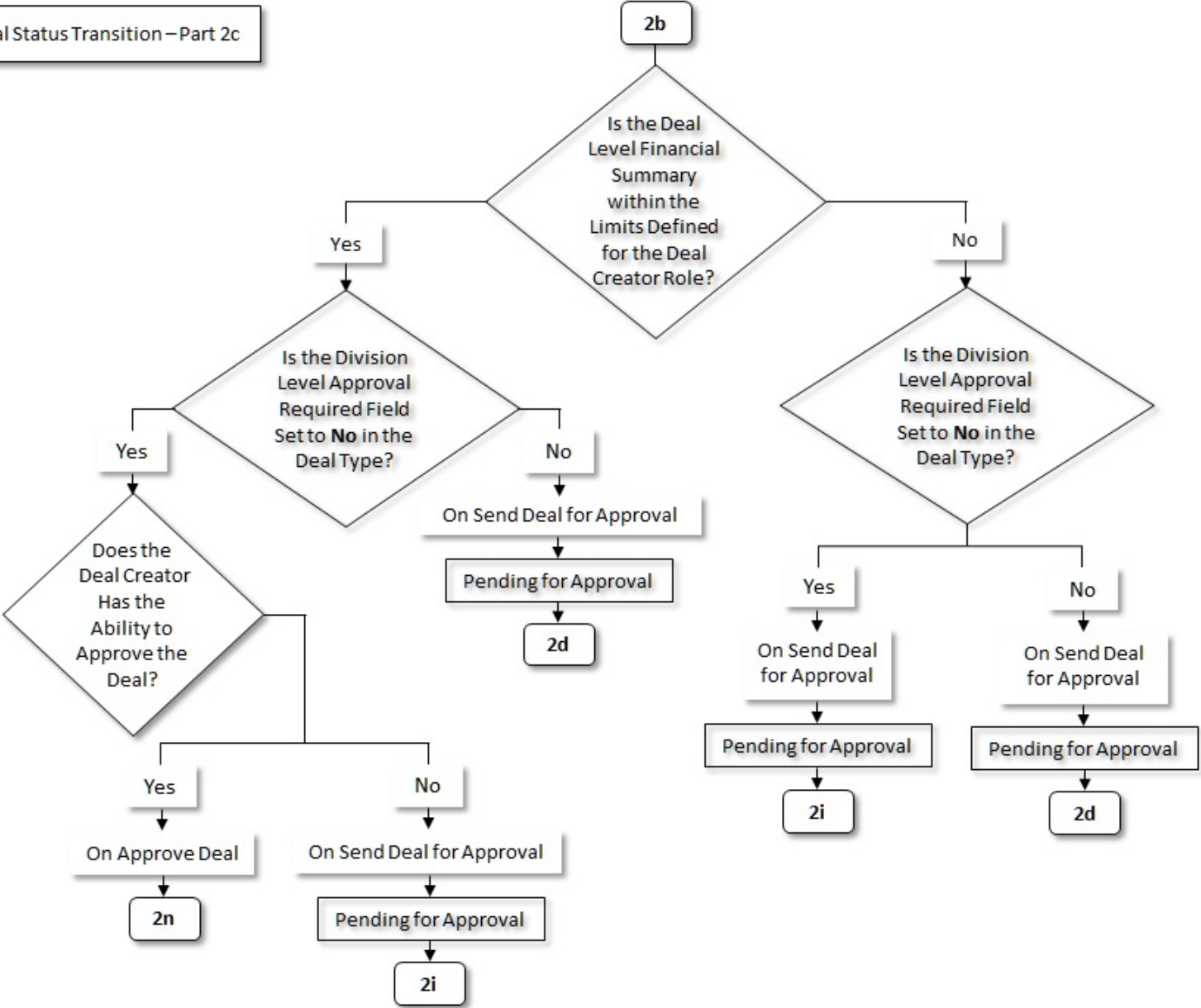

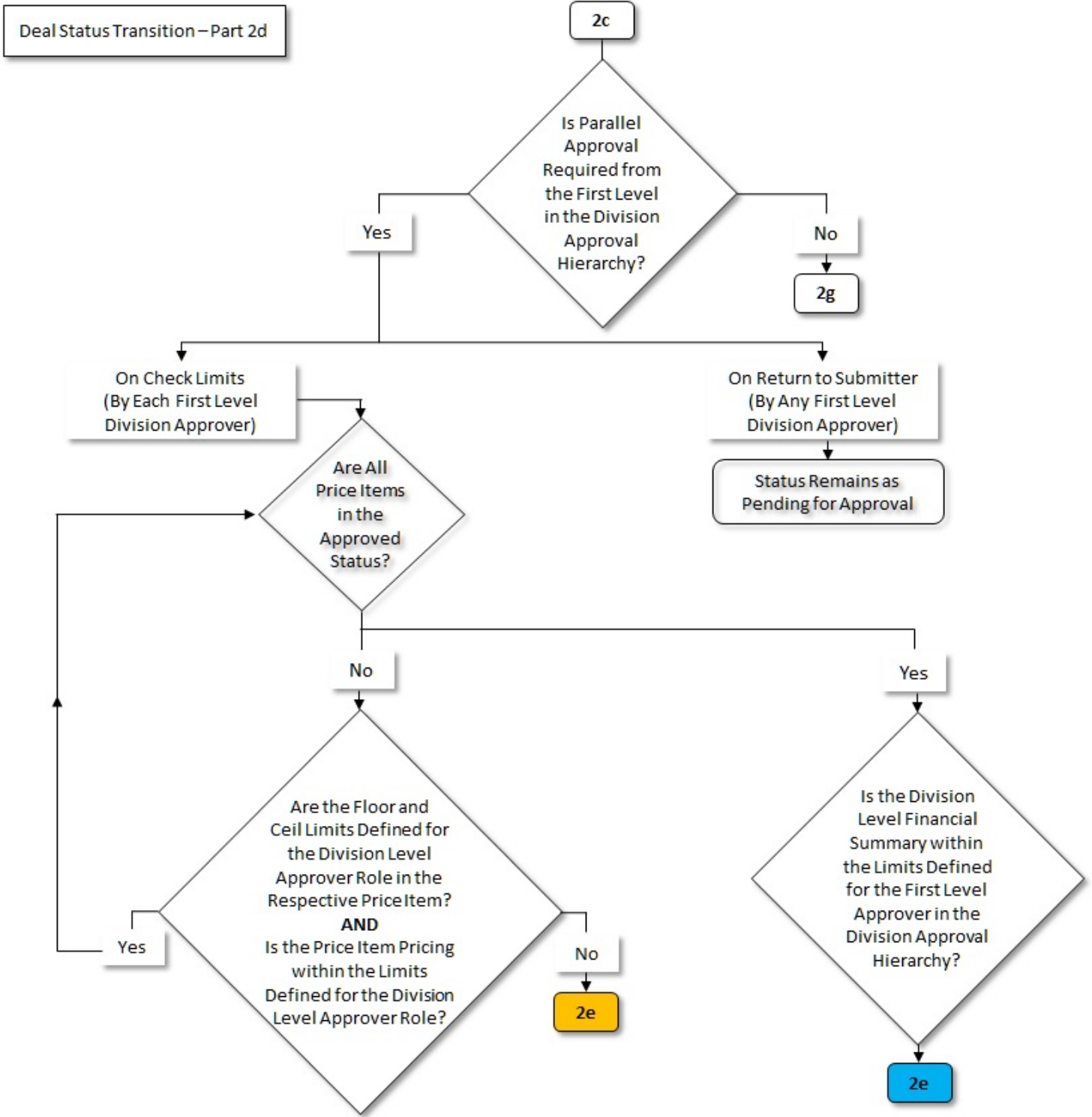

Deal Status Transition – Part 2e

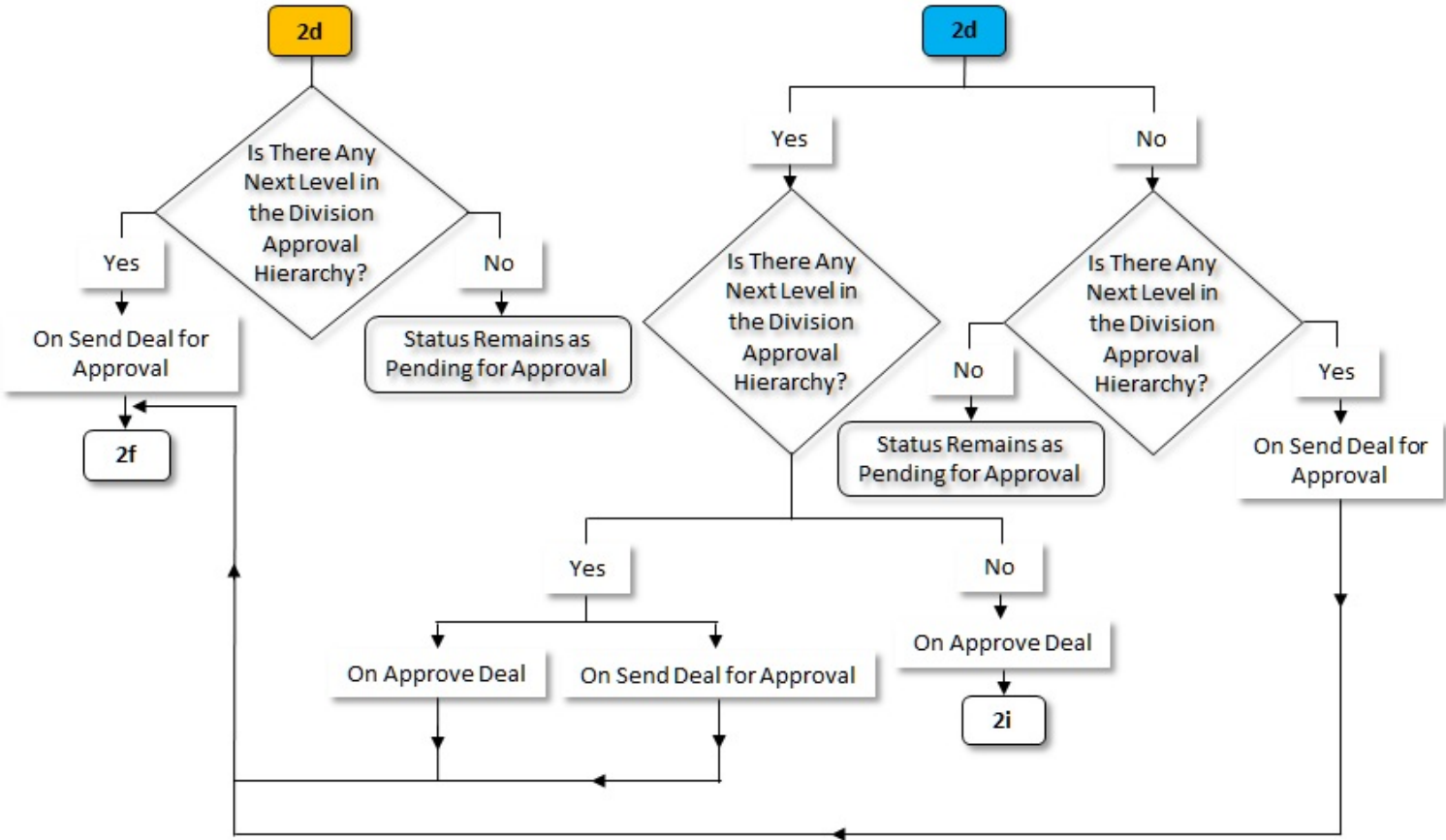

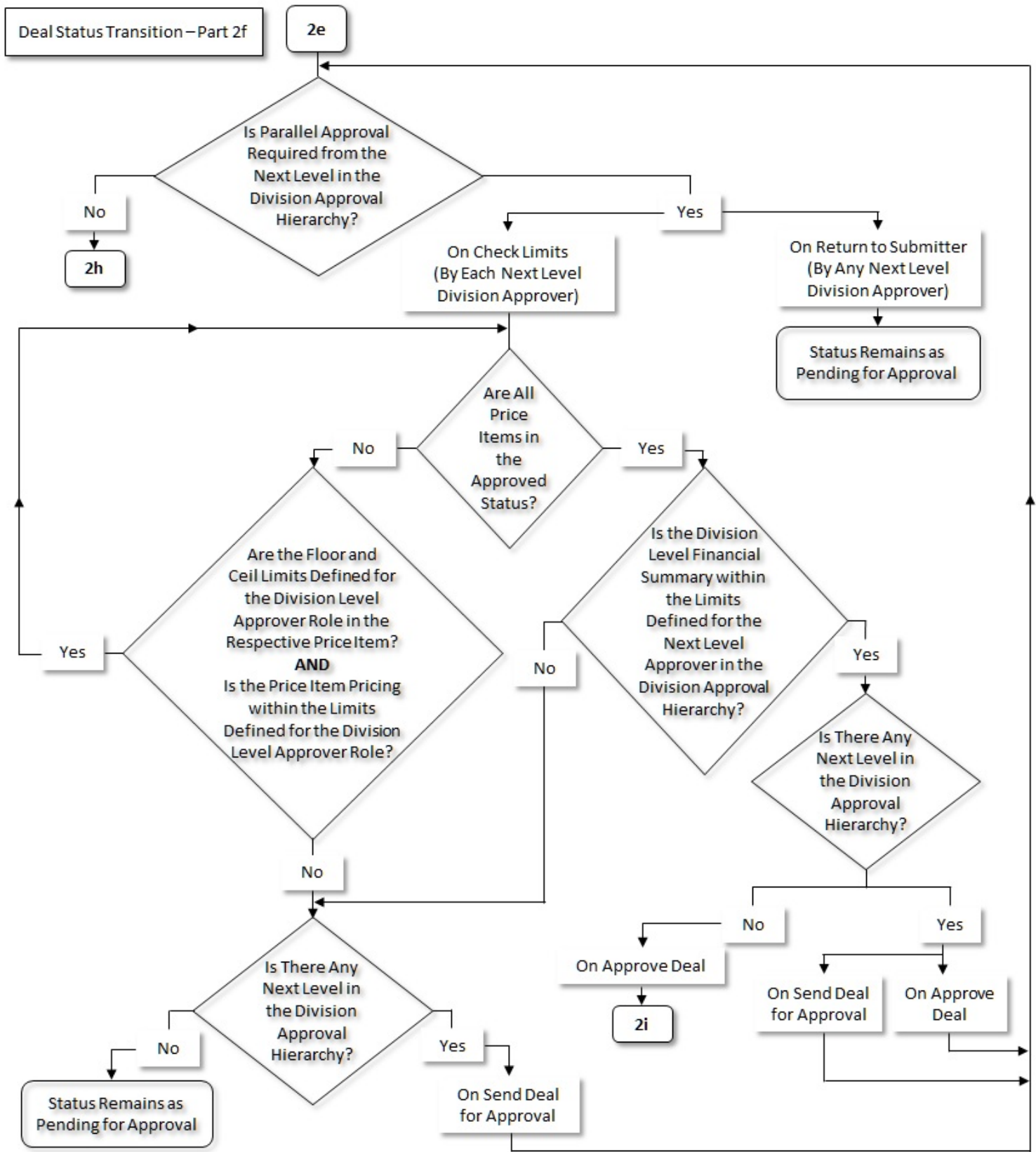

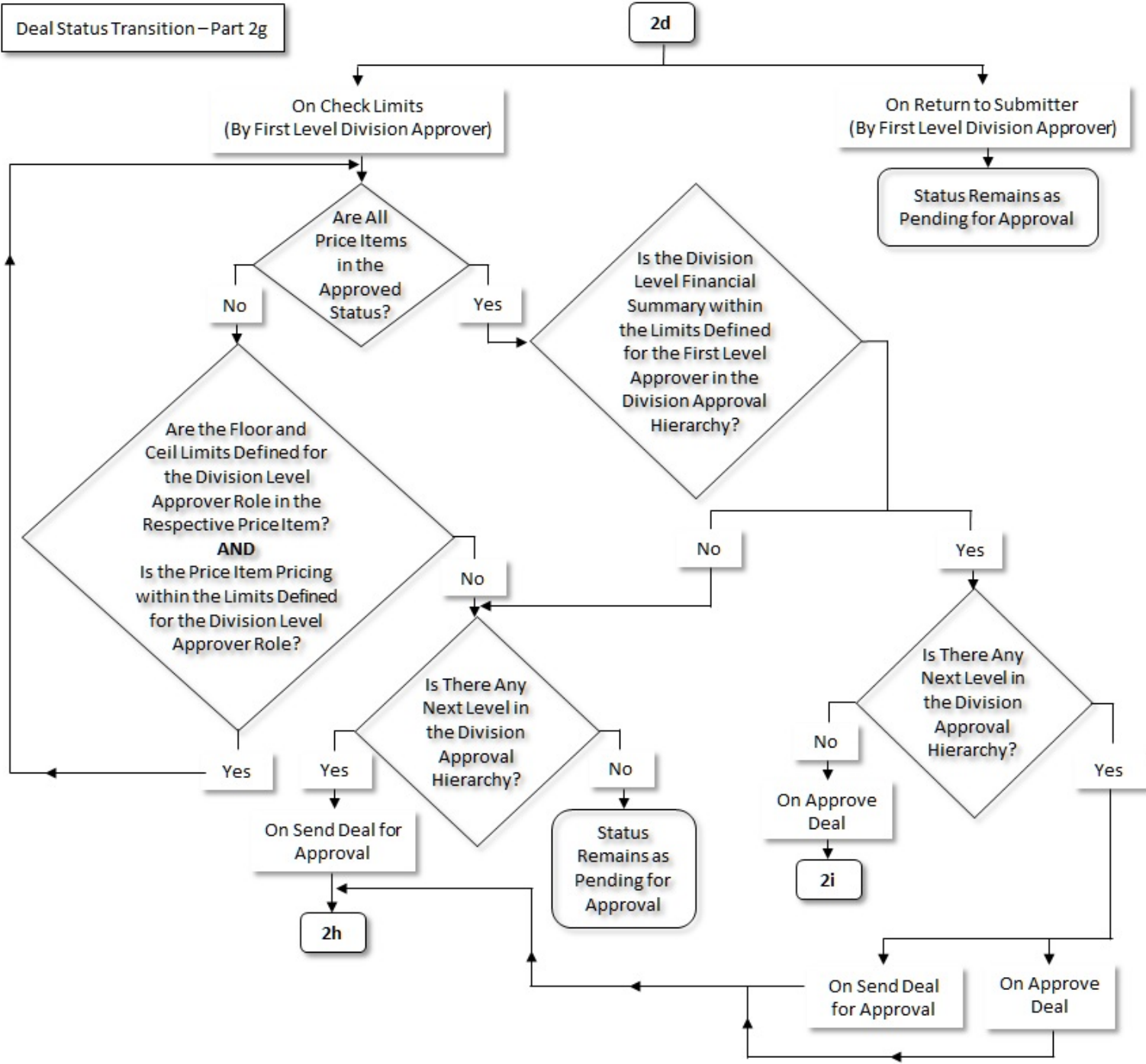

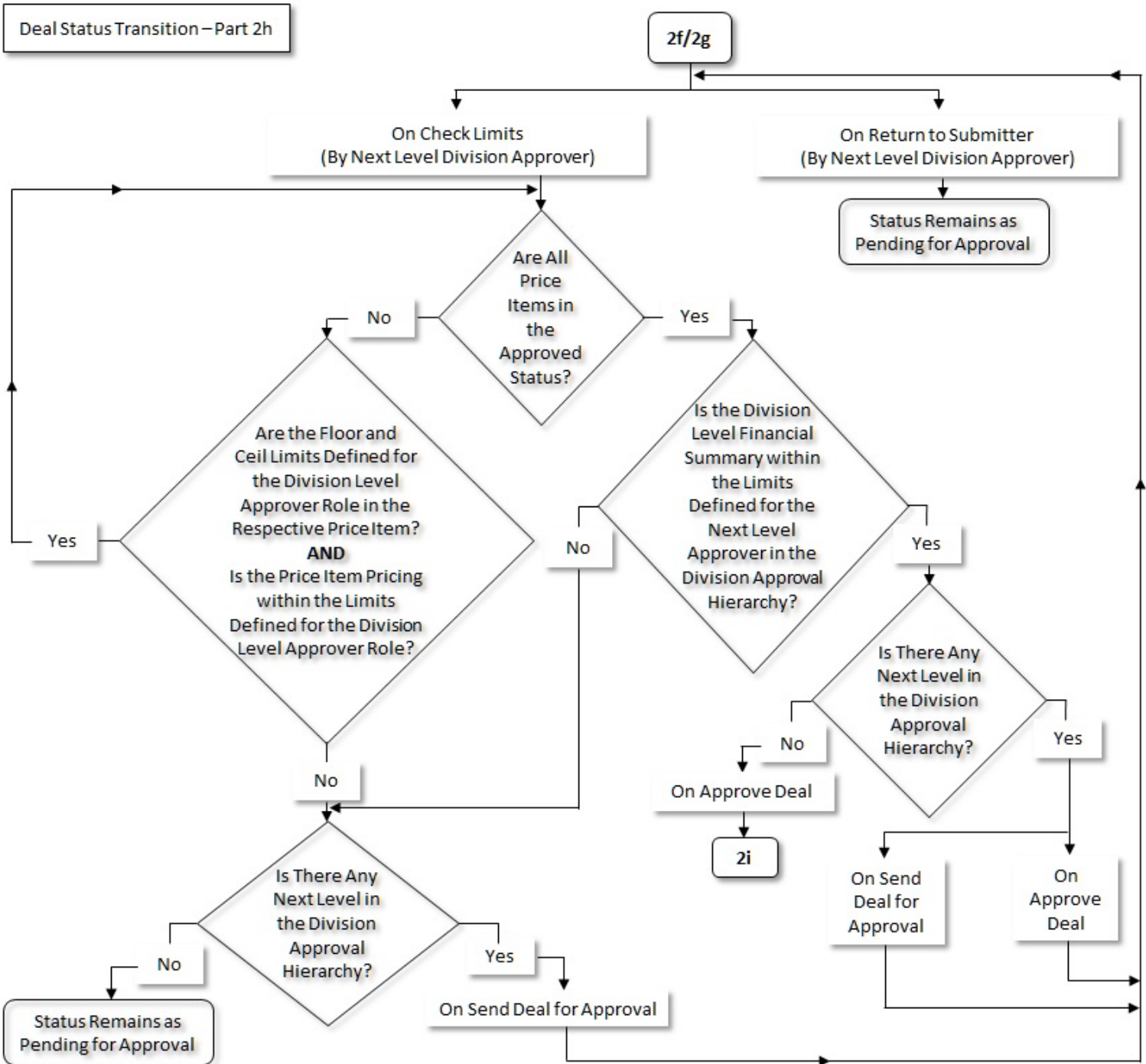

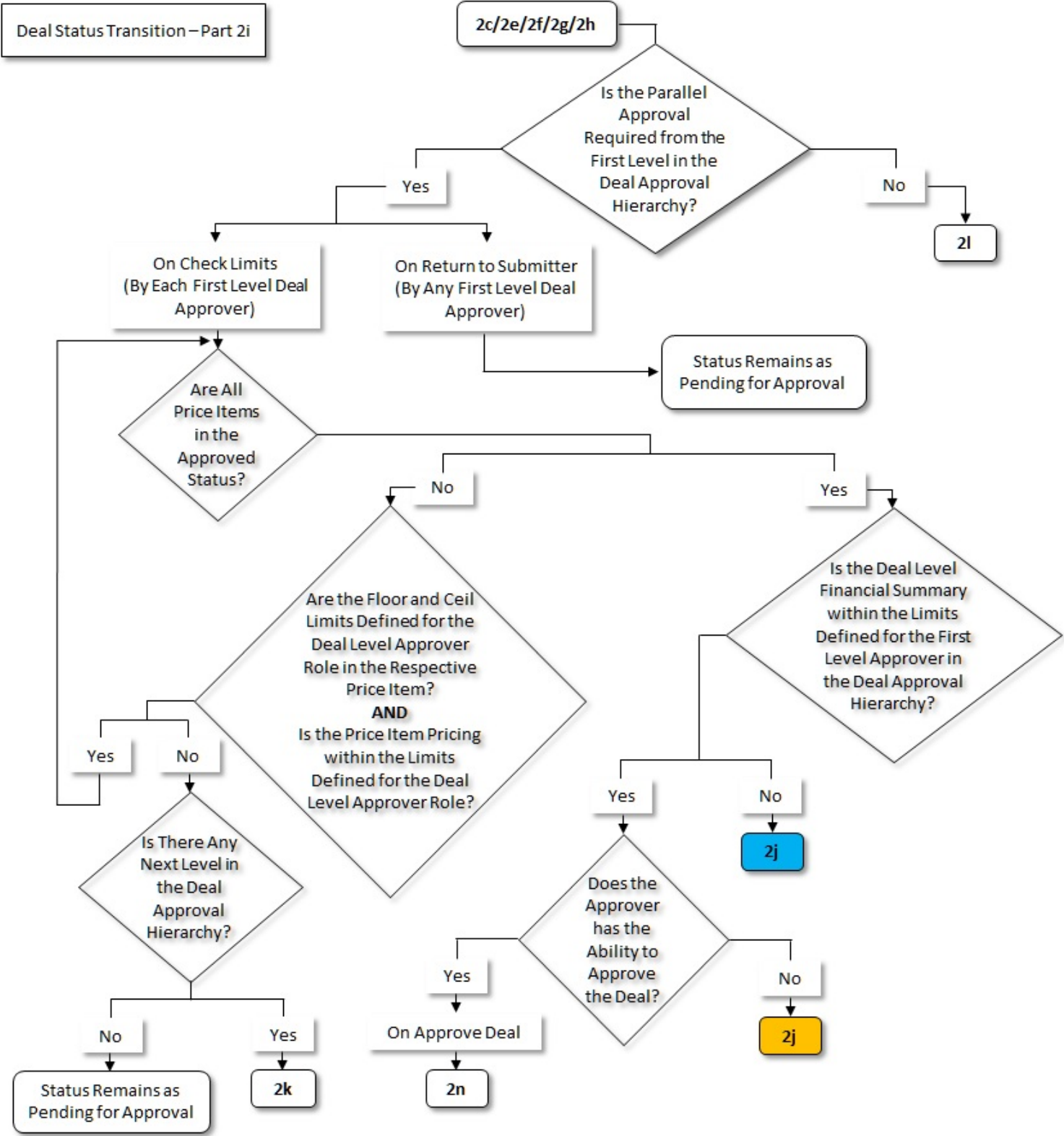

Deal Status Transition – Part 2j

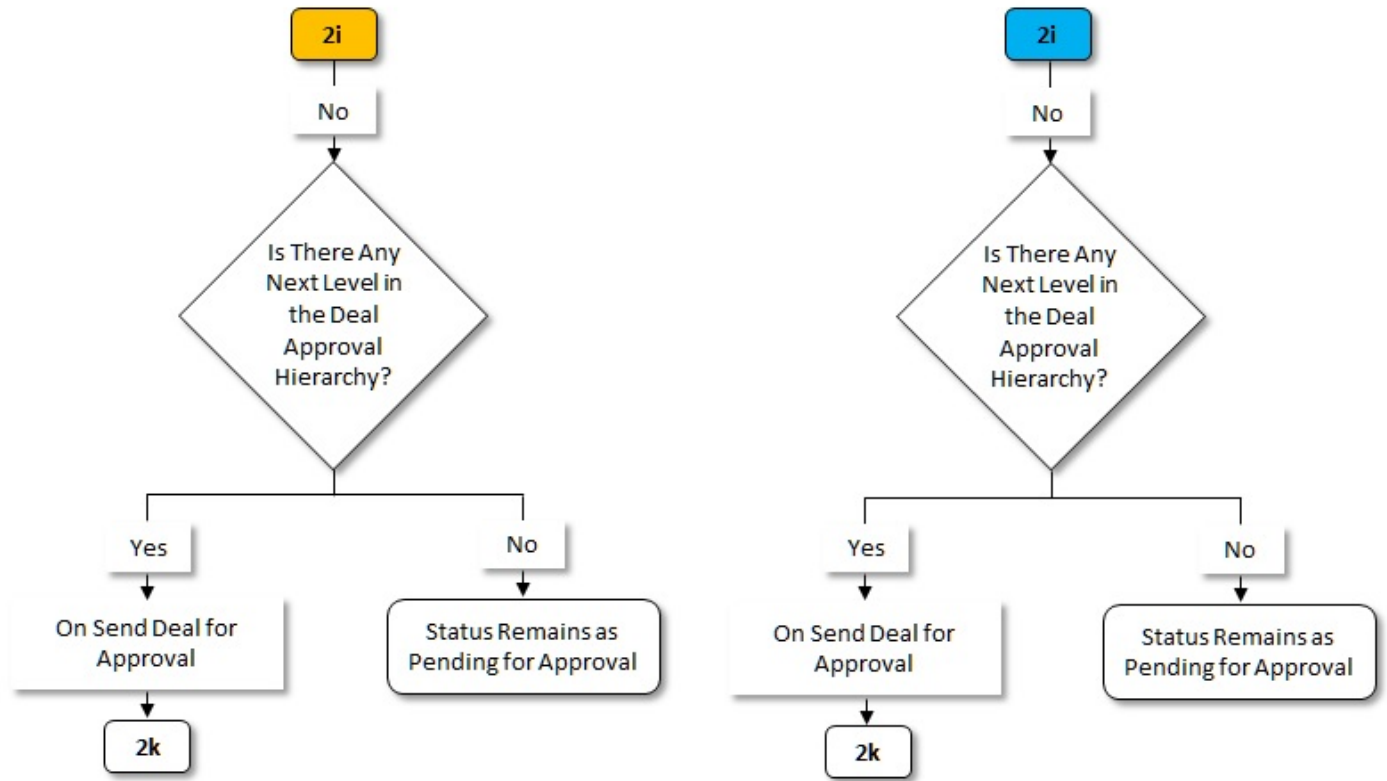

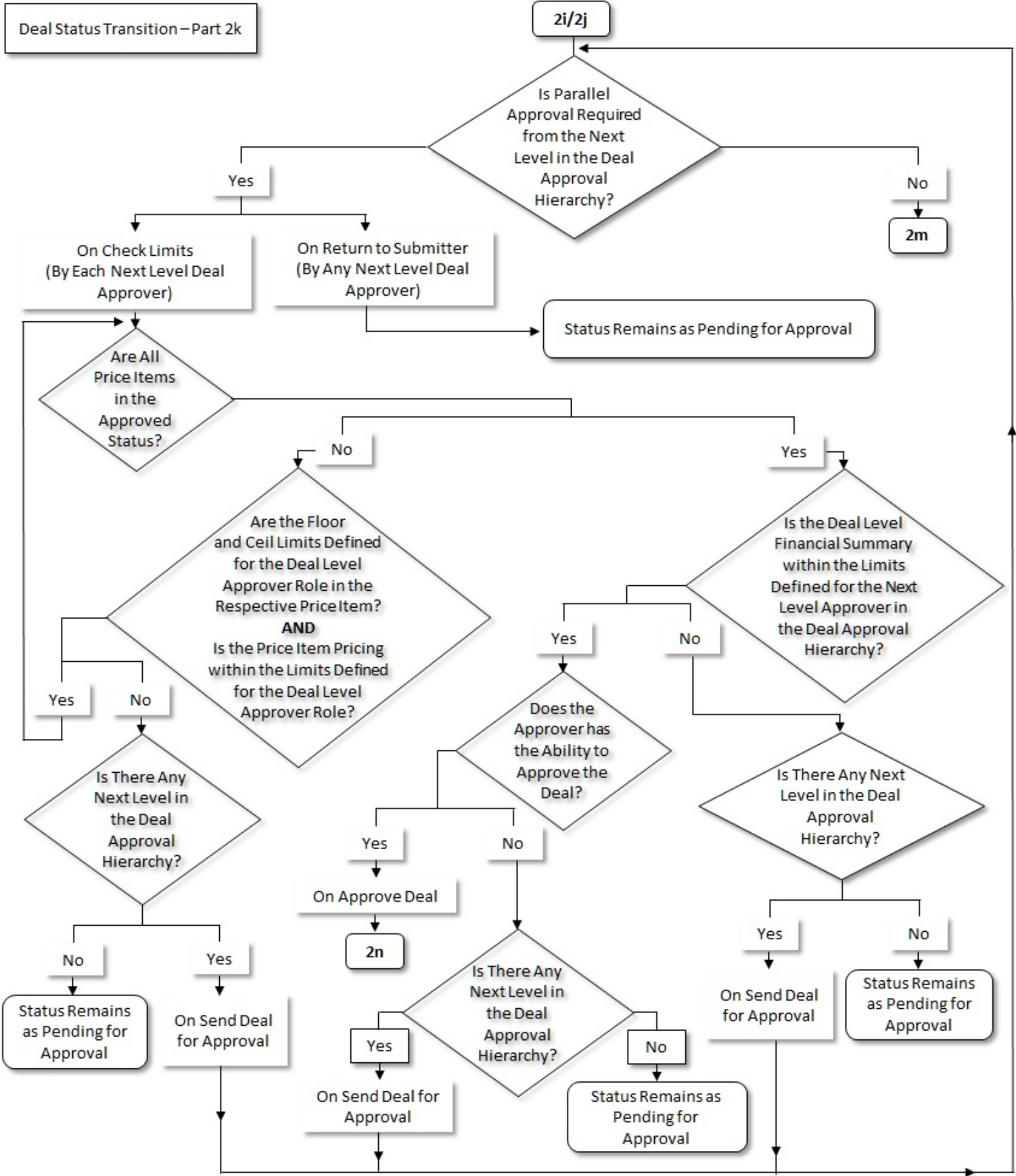

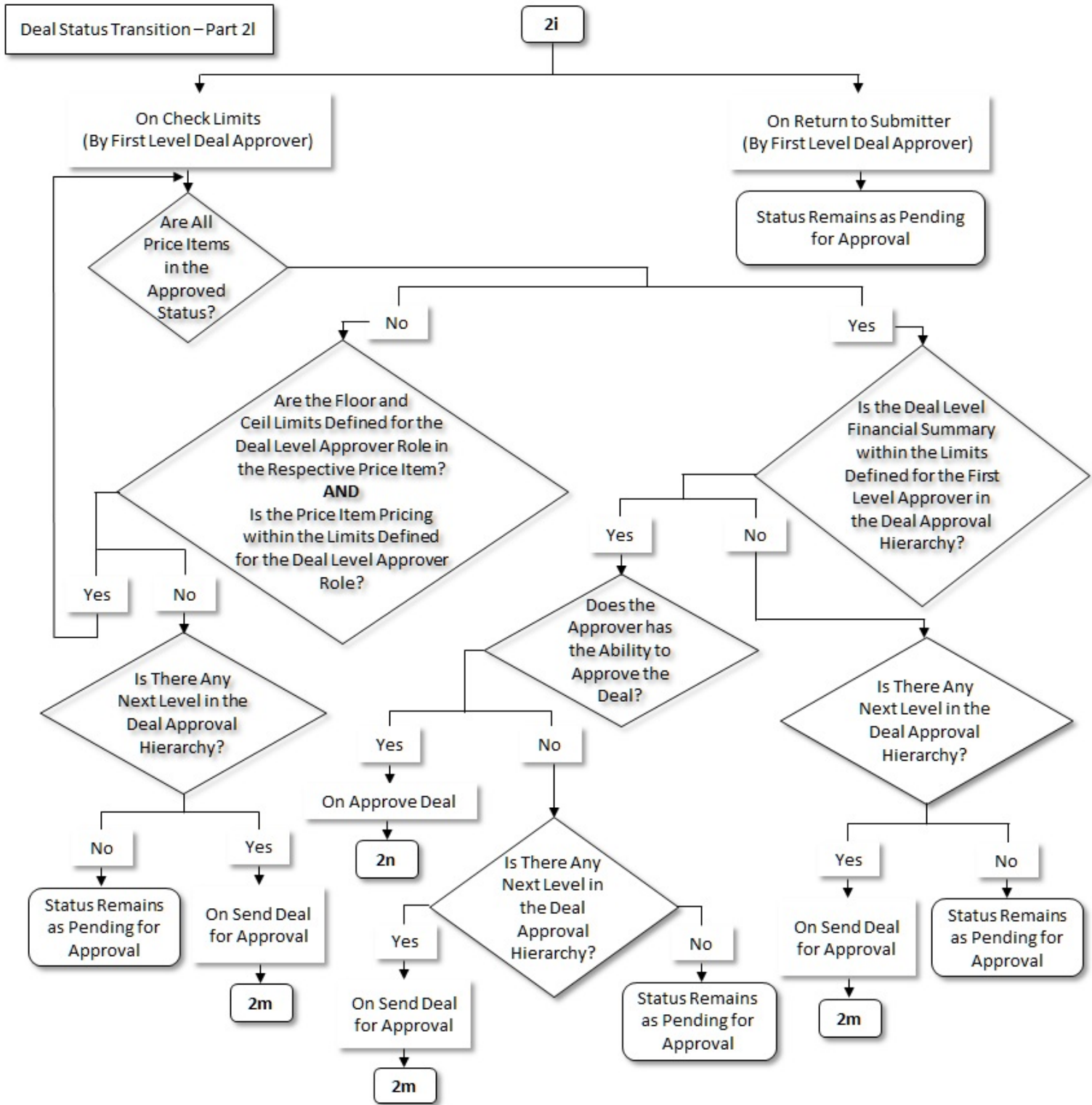

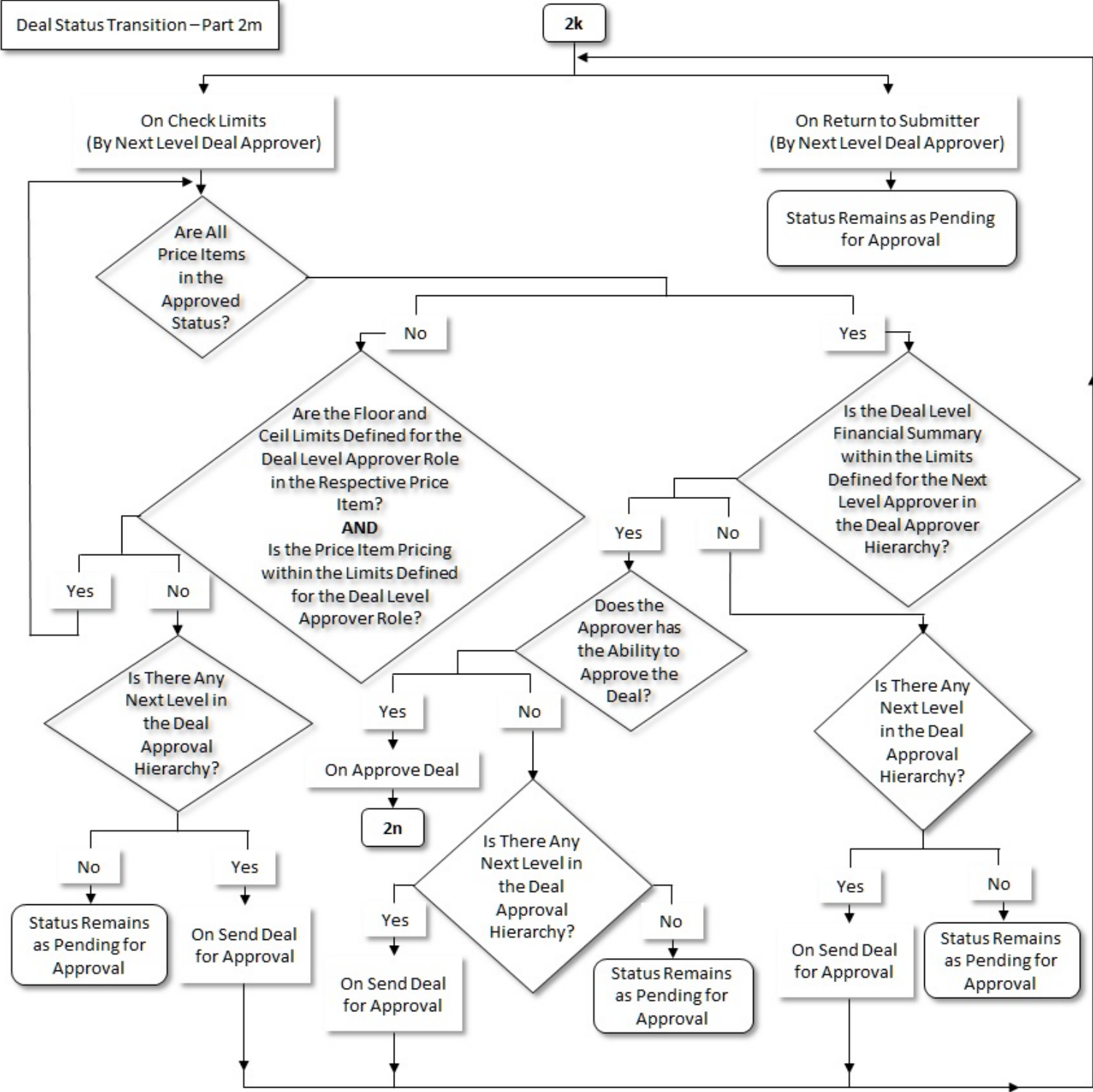

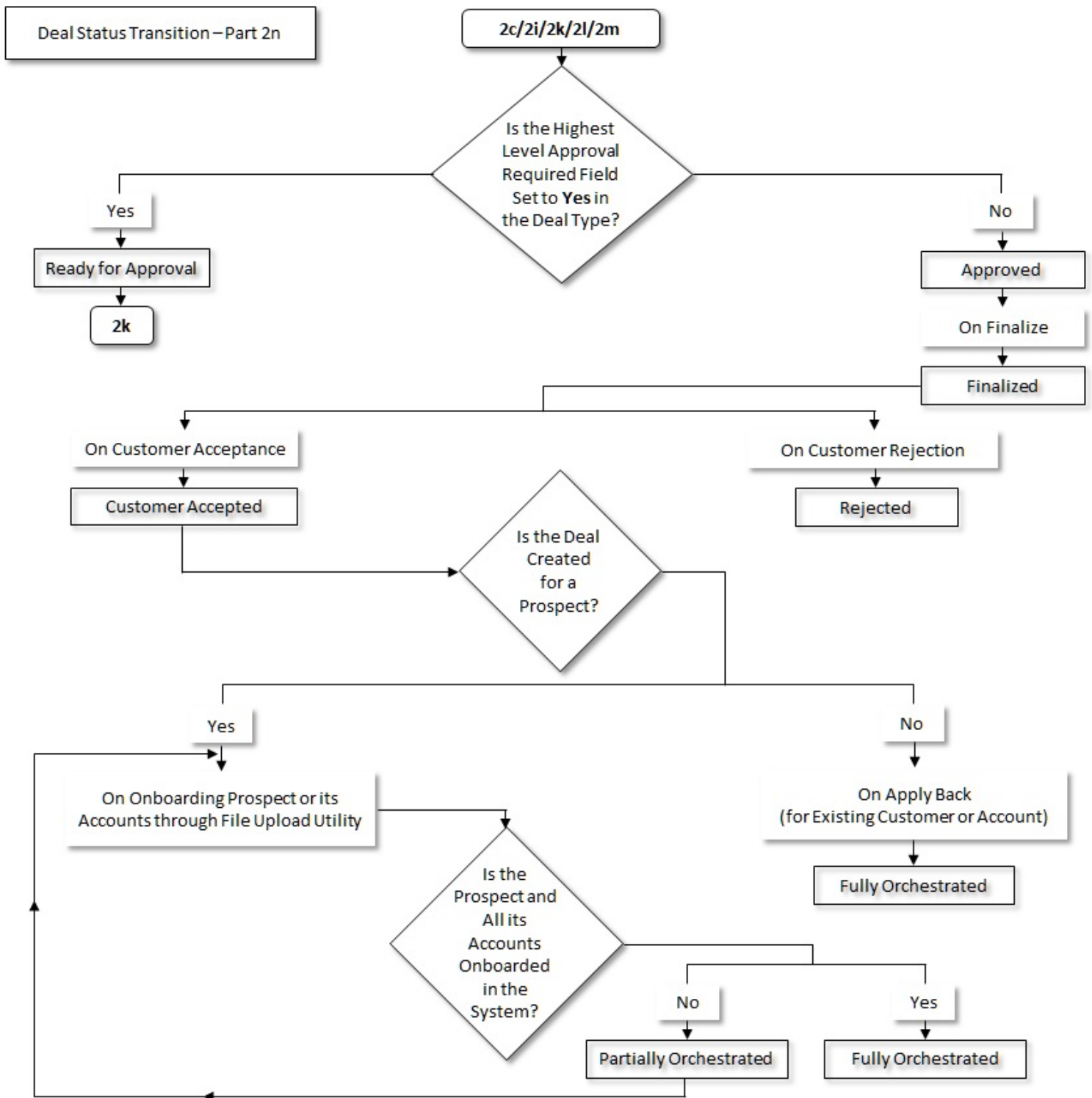

Deal Approval Scenarios

This section illustrates how a deal moves from one approver to another in the following scenarios:

- [Deal Approval Scenario 1](#) on page 2627

- [Deal Approval Scenario 2](#) on page 2627
- [Deal Approval Scenario 3](#) on page 2628
- [Deal Approval Scenario 4](#) on page 2629
- [Deal Approval Scenario 5](#) on page 2631
- [Deal Approval Scenario 6](#) on page 2632
- [Deal Approval Scenario 7](#) on page 2634
- [Deal Approval Scenario 8](#) on page 2636
- [Deal Approval Scenario 9](#) on page 2638
- [Deal Approval Scenario 10](#) on page 2640

Deal Approval Scenario 1

The following table illustrates the different levels of approval that are required for a deal in scenario 1:

Scenario 1	Price Item Approval Required	No
	Product Level Approval Required	No
	Division Level Approval Required	No
	Parallel Approval in the Deal Approval Hierarchy	No
	Highest Level Approval Required	Yes

The following table lists the approvers at different levels in the deal approval hierarchy:

Deal Approval Hierarchy		
Approval Level	To Do Role	Approve Deal
Level 0	Relationship Manager (RM)	No
Level 1	Pricing Manager (PM)	No
Level 2	Senior Pricing Manager (SPM)	No
Level 3	Executive Pricing Manager (EPM)	Yes

The following figure graphically indicates how a deal moves from one approver to another in the given deal approval scenario:



Deal Approval Scenario 2

The following table illustrates the different levels of approval that are required for a deal in scenario 2:

Scenario 2	Price Item Approval Required	No
-------------------	------------------------------	----

	Product Level Approval Required	No
	Division Level Approval Required	No
	Parallel Approval in the Deal Approval Hierarchy	Yes
	Highest Level Approval Required	Yes

The following table lists the approvers at different levels including the parallel levels in the deal approval hierarchy:

Deal Approval Hierarchy		
Approval Level	To Do Role	Approve Deal
Level 0	Relationship Manager (RM)	Yes
Level 1	Pricing Manager 1 (PM1)	No
Level 1	Pricing Manager 2 (PM2)	No
Level 2	Senior Pricing Manager 1 (SPM1)	No
Level 2	Senior Pricing Manager 2 (SPM2)	Yes
Level 3	Executive Pricing Manager (EPM)	Yes

The following figure graphically indicates how a deal moves from one approver to another in the given deal approval scenario:

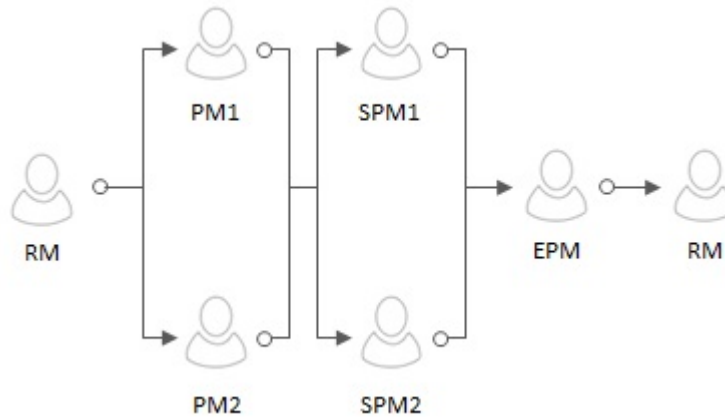

Deal Approval Scenario 3

The following table illustrates the different levels of approval that are required for a deal in scenario 3:

Scenario 3	Price Item Approval Required	Yes
	Product Level Approval Required	No
	Division Level Approval Required	No
	Parallel Approval in the Deal Approval Hierarchy	No

	Highest Level Approval Required	Yes
--	---------------------------------	-----

The following table lists the approvers at different levels in the deal approval hierarchy:

Deal Approval Hierarchy		
Approval Level	To Do Role	Approve Deal
Level 0	Relationship Manager (RM)	No
Level 1	Pricing Manager (PM)	Yes
Level 2	Senior Pricing Manager (SPM)	No
Level 3	Executive Pricing Manager (EPM)	Yes

The following table lists the price item managers who can approve the respective price item in the deal:

Price Item Managers	
PI1	PI1 Pricing Manager (PI1 PM)
PI2	PI2 Pricing Manager (PI2 PM)
PI3	PI3 Pricing Manager (PI3 PM)

The following figure graphically indicates how a deal moves from one approver to another in the given deal approval scenario:

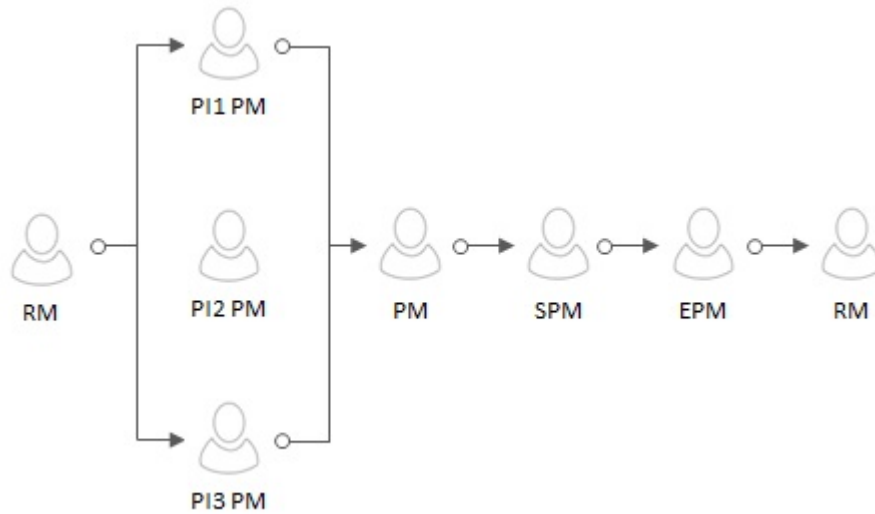

Deal Approval Scenario 4

The following table illustrates the different levels of approval that are required for a deal in scenario 4:

Scenario 4	Price Item Approval Required	Yes
	Product Level Approval Required	No
	Division Level Approval Required	No

	Parallel Approval in the Deal Approval Hierarchy	Yes
	Highest Level Approval Required	Yes

The following table lists the approvers at different levels including the parallel levels in the deal approval hierarchy:

Deal Approval Hierarchy		
Approval Level	To Do Role	Approve Deal
Level 0	Relationship Manager (RM)	Yes
Level 1	Pricing Manager 1 (PM1)	No
Level 1	Pricing Manager 2 (PM2)	No
Level 2	Senior Pricing Manager 1 (SPM1)	No
Level 2	Senior Pricing Manager 2 (SPM2)	Yes
Level 3	Executive Pricing Manager (EPM)	Yes

The following table lists the price item managers who can approve the respective price item in the deal:

Price Item Managers	
PI1	PI1 Pricing Manager (PI1 PM)
PI2	PI2 Pricing Manager (PI2 PM)
PI3	PI3 Pricing Manager (PI3 PM)
PI4	PI4 Pricing Manager (PI4 PM)

The following figure graphically indicates how a deal moves from one approver to another in the given deal approval scenario:

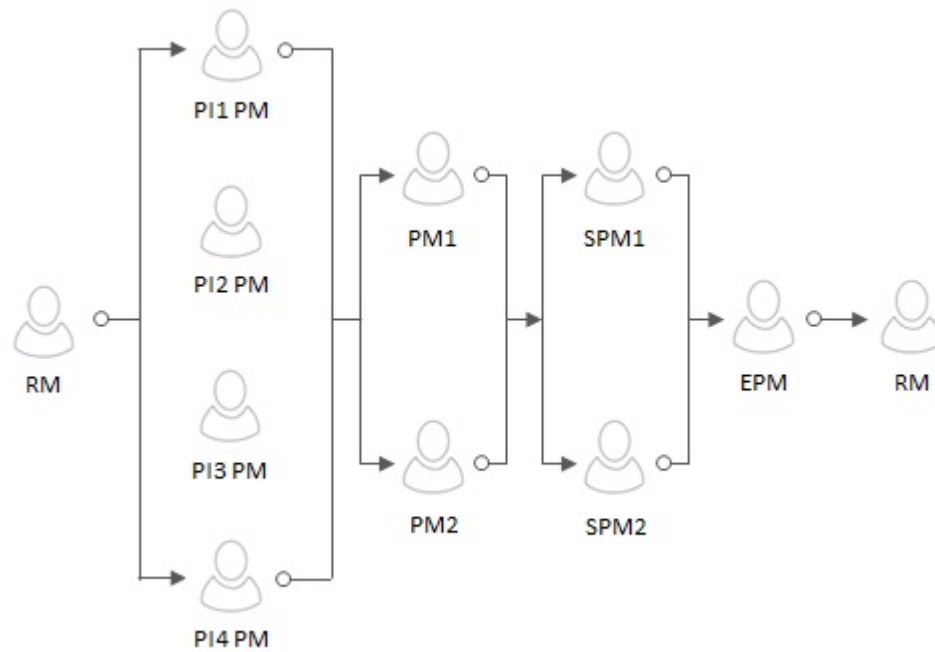

Deal Approval Scenario 5

The following table illustrates the different levels of approval that are required for a deal in scenario 5:

Scenario 5	Price Item Approval Required	No
	Product Level Approval Required	No
	Division Level Approval Required	Yes
	Parallel Approval in the Division or Deal Approval Hierarchy	No
	Highest Level Approval Required	Yes

The following table lists the approvers at different levels in the D1 division approval hierarchy:

D1 Division Approval Hierarchy		
Approval Level	To Do Role	Approve Deal
Level 1	D1 Pricing Manager (D1 PM)	Yes
Level 2	D1 Senior Pricing Manager (D1 SPM)	Yes
Level 3	D1 Executive Pricing Manager (D1 EPM)	Yes

The following table lists the approvers at different levels in the D2 division approval hierarchy:

D2 Division Approval Hierarchy		
Approval Level	To Do Role	Approve Deal
Level 1	D2 Pricing Manager (D2 PM)	Yes

D2 Division Approval Hierarchy		
Approval Level	To Do Role	Approve Deal
Level 2	D2 Senior Pricing Manager (D2 SPM)	Yes
Level 3	D2 Executive Pricing Manager (D2 EPM)	Yes

The following table lists the approvers at different levels in the deal approval hierarchy:

Deal Approval Hierarchy		
Approval Level	To Do Role	Approve Deal
Level 0	Relationship Manager (RM)	Yes
Level 1	Pricing Manager (PM)	Yes
Level 2	Senior Pricing Manager (SPM)	Yes
Level 3	Executive Pricing Manager (EPM)	Yes

The following figure graphically indicates how a deal moves from one approver to another in the given deal approval scenario:

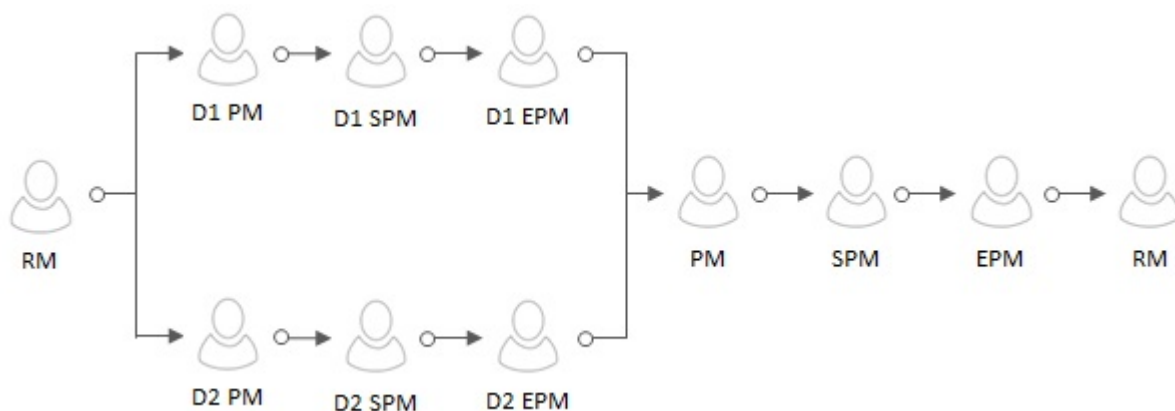

Deal Approval Scenario 6

The following table illustrates the different levels of approval that are required for a deal in scenario 6:

Scenario 6	Price Item Approval Required	Yes
	Product Level Approval Required	No
	Division Level Approval Required	Yes
	Parallel Approval in the Division or Deal Approval Hierarchy	No
	Highest Level Approval Required	Yes

The following table lists the approvers at different levels in the D1 division approval hierarchy:

D1 Division Approval Hierarchy		
Approval Level	To Do Role	Approve Deal
Level 1	D1 Pricing Manager (D1 PM)	Yes
Level 2	D1 Senior Pricing Manager (D1 SPM)	Yes
Level 3	D1 Executive Pricing Manager (D1 EPM)	Yes

The following table lists the approvers at different levels in the D2 division approval hierarchy:

D2 Division Approval Hierarchy		
Approval Level	To Do Role	Approve Deal
Level 1	D2 Pricing Manager (D2 PM)	Yes
Level 2	D2 Senior Pricing Manager (D2 SPM)	Yes
Level 3	D2 Executive Pricing Manager (D2 EPM)	Yes

The following table lists the approvers at different levels in the deal approval hierarchy:

Deal Approval Hierarchy		
Approval Level	To Do Role	Approve Deal
Level 0	Relationship Manager (RM)	Yes
Level 1	Pricing Manager (PM)	Yes
Level 2	Senior Pricing Manager (SPM)	Yes
Level 3	Executive Pricing Manager (EPM)	Yes

The following table lists the price item managers who can approve the respective price item in the deal:

Price Item Managers		
Price Item	Division	Price Item Manager
PI1	D1	PI1 Price Item Manager (PI1 PM)
PI2	D1	PI2 Price Item Manager (PI2 PM)
PI3	D2	PI3 Price Item Manager (PI3 PM)
PI4	D2	PI4 Price Item Manager (PI4 PM)

The following figure graphically indicates how a deal moves from one approver to another in the given deal approval scenario:

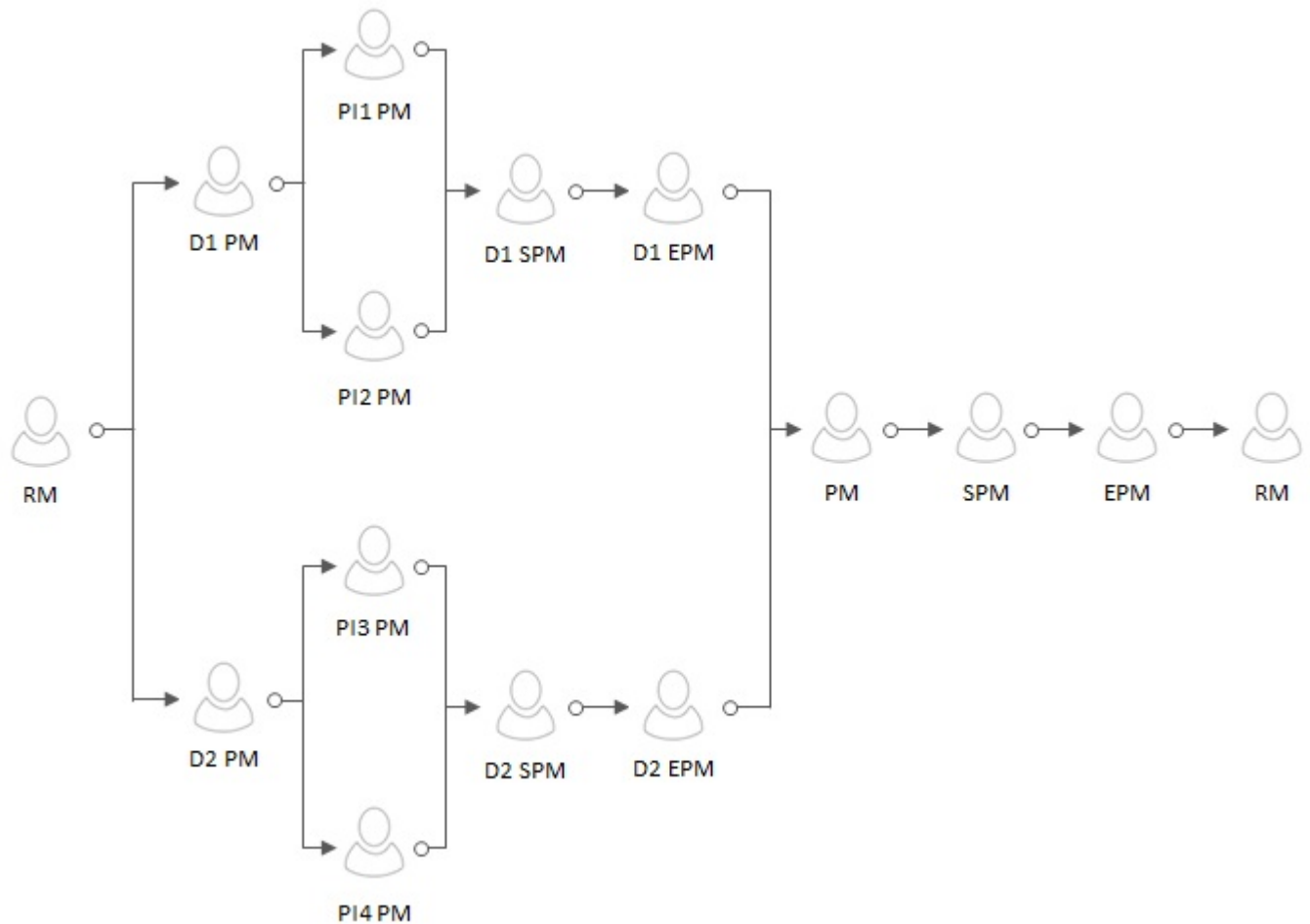

Deal Approval Scenario 7

The following table illustrates the different levels of approval that are required for a deal in scenario 7:

Scenario 7	Price Item Approval Required	No
	Product Level Approval Required	No
	Division Level Approval Required	Yes
	Parallel Approval in the Division or Deal Approval Hierarchy	Yes
	Highest Level Approval Required	Yes

The following table lists the approvers at different levels including the parallel levels in the D1 division approval hierarchy:

D1 Division Approval Hierarchy		
Approval Level	To Do Role	Approve Deal
Level 1	D1 Pricing Manager (D1 PM)	Yes
Level 2	D1 Senior Pricing Manager 1 (D1 SPM1)	Yes

D1 Division Approval Hierarchy		
Approval Level	To Do Role	Approve Deal
Level 2	D1 Senior Pricing Manager 2 (D1 SPM2)	Yes
Level 3	D1 Executive Pricing Manager (D1 EPM)	Yes

The following table lists the approvers at different levels including the parallel levels in the D2 division approval hierarchy:

D2 Division Approval Hierarchy		
Approval Level	To Do Role	Approve Deal
Level 1	D2 Pricing Manager 1 (D2 PM1)	Yes
Level 1	D2 Pricing Manager 2 (D2 PM2)	Yes
Level 2	D2 Senior Pricing Manager 1 (D2 SPM1)	Yes
Level 2	D2 Senior Pricing Manager 2 (D2 SPM2)	Yes
Level 3	D2 Executive Pricing Manager 1 (D2 EPM1)	Yes
Level 3	D2 Executive Pricing Manager 2 (D2 EPM2)	Yes

The following table lists the approvers at different levels including the parallel levels in the deal approval hierarchy:

Deal Approval Hierarchy		
Approval Level	To Do Role	Approve Deal
Level 0	Relationship Manager (RM)	Yes
Level 1	Pricing Manager 1 (PM1)	No
Level 1	Pricing Manager 2 (PM2)	No
Level 2	Senior Pricing Manager 1 (SPM1)	No
Level 2	Senior Pricing Manager 2 (SPM2)	Yes
Level 3	Executive Pricing Manager (EPM)	Yes

The following figure graphically indicates how a deal moves from one approver to another in the given deal approval scenario:

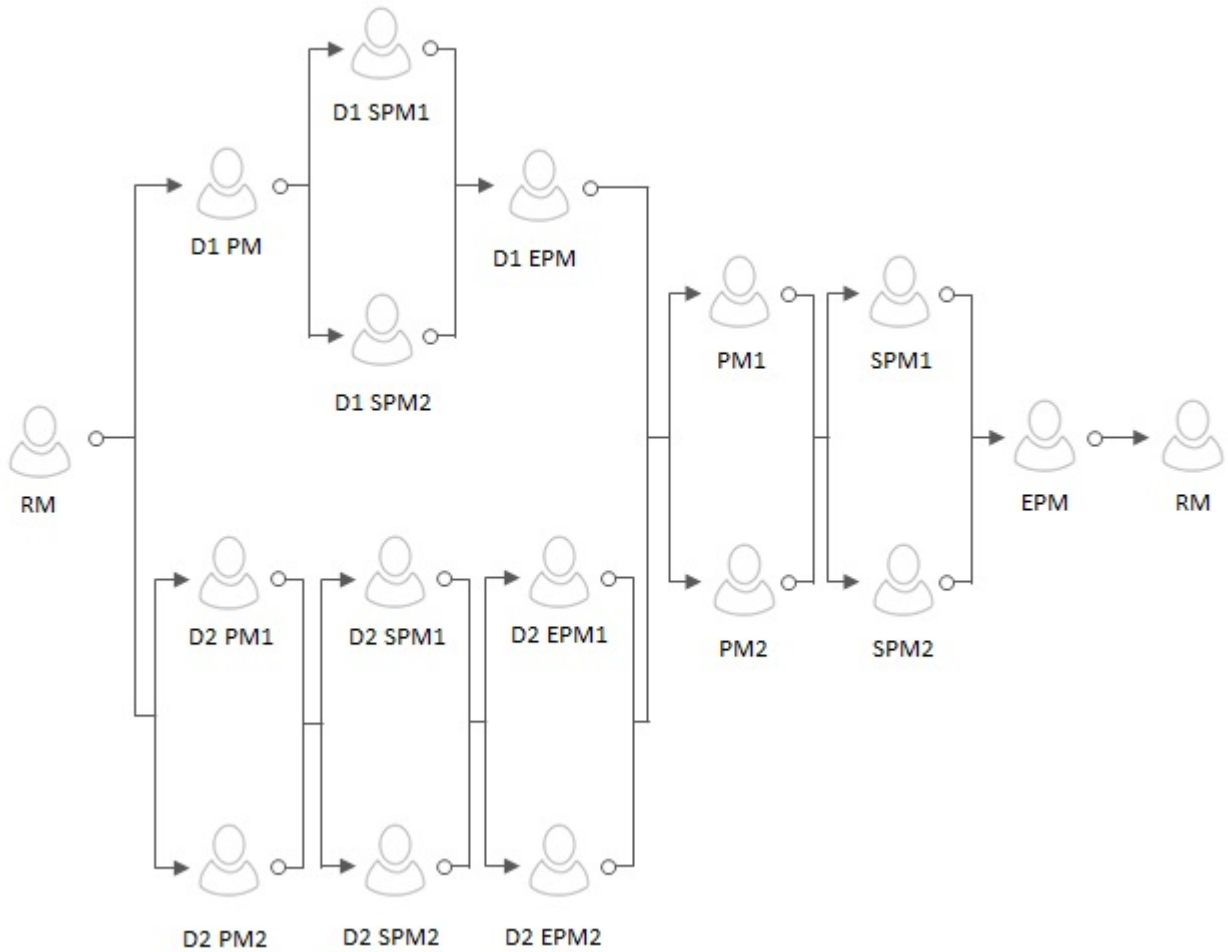

Deal Approval Scenario 8

The following table illustrates the different levels of approval that are required for a deal in scenario 8:

Scenario 8	Price Item Approval Required	Yes
	Product Level Approval Required	No
	Division Level Approval Required	Yes
	Parallel Approval in the Division or Deal Approval Hierarchy	Yes
	Highest Level Approval Required	Yes

The following table lists the approvers at different levels including the parallel levels in the D1 division approval hierarchy:

D1 Division Approval Hierarchy		
Approval Level	To Do Role	Approve Deal
Level 1	D1 Pricing Manager (D1 PM)	Yes
Level 2	D1 Senior Pricing Manager 1 (D1 SPM1)	Yes

D1 Division Approval Hierarchy		
Approval Level	To Do Role	Approve Deal
Level 2	D1 Senior Pricing Manager 2 (D1 SPM2)	Yes
Level 3	D1 Executive Pricing Manager (D1 EPM)	Yes

The following table lists the approvers at different levels including the parallel levels in the D2 division approval hierarchy:

D2 Division Approval Hierarchy		
Approval Level	To Do Role	Approve Deal
Level 1	D2 Pricing Manager 1 (D2 PM1)	Yes
Level 1	D2 Pricing Manager 2 (D2 PM2)	Yes
Level 2	D2 Senior Pricing Manager 1 (D2 SPM1)	Yes
Level 2	D2 Senior Pricing Manager 2 (D2 SPM2)	Yes
Level 3	D2 Executive Pricing Manager 1 (D2 EPM1)	Yes
Level 3	D2 Executive Pricing Manager 2 (D2 EPM2)	Yes

The following table lists the approvers at different levels including the parallel levels in the deal approval hierarchy:

Deal Approval Hierarchy		
Approval Level	To Do Role	Approve Deal
Level 0	Relationship Manager (RM)	Yes
Level 1	Pricing Manager 1 (PM1)	No
Level 1	Pricing Manager 2 (PM2)	No
Level 2	Senior Pricing Manager 1 (SPM1)	No
Level 2	Senior Pricing Manager 2 (SPM2)	Yes
Level 3	Executive Pricing Manager (EPM)	Yes

The following table lists the price item managers who can approve the respective price item in the deal:

Price Item Managers		
Price Item	Division	Price Item Manager
PI1	D1	PI1 Price Item Manager (PI1 PM)
PI2	D2	PI2 Price Item Manager (PI2 PM)
PI3	D1	PI3 Price Item Manager (PI3 PM)
PI4	D2	PI4 Price Item Manager (PI4 PM)

The following figure graphically indicates how a deal moves from one approver to another in the given deal approval scenario:

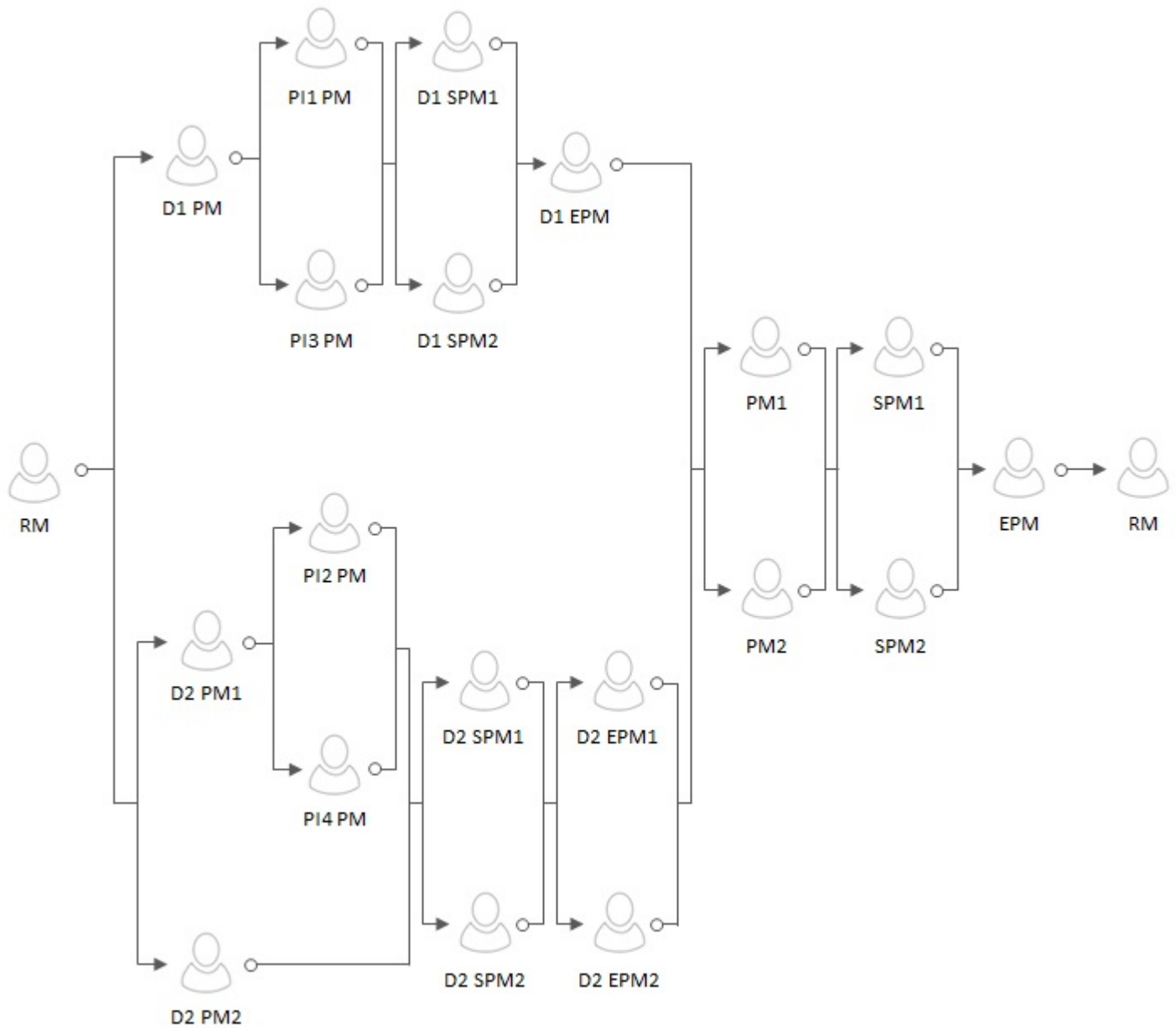

Deal Approval Scenario 9

The following table illustrates the different levels of approval that are required for a deal in scenario 9:

Scenario 9	Price Item Approval Required	No
	Product Level Approval Required	Yes
	Division Level Approval Required	Yes
	Parallel Approval in the Product, Division, or Deal Approval Hierarchy	Yes
	Highest Level Approval Required	Yes

The following table lists the approvers at different levels including the parallel levels in the P1 product approval hierarchy:

P1 Product Approval Hierarchy		
Approval Level	To Do Role	Approve Deal
Level 1	P1 Product Manager 1 (P1 PM1)	Yes
Level 1	P1 Product Manager 2 (P1 PM2)	Yes
Level 2	P1 Senior Product Manager 1 (P1 SPM1)	Yes
Level 2	P1 Senior Product Manager 2 (P1 SPM2)	Yes
Level 3	P1 Executive Product Manager (P1 EPM)	Yes

The following table lists the approvers at different levels including the parallel levels in the P2 product approval hierarchy:

P2 Product Approval Hierarchy		
Approval Level	To Do Role	Approve Deal
Level 1	P2 Product Manager (P2 PM1)	Yes
Level 2	P2 Senior Product Manager 1 (P2 SPM1)	Yes
Level 2	P2 Senior Product Manager 2 (P2 SPM2)	Yes
Level 3	P2 Executive Product Manager 1 (P2 EPM1)	Yes
Level 3	P2 Executive Product Manager 2 (P2 EPM2)	Yes

The following table lists the approvers at different levels including the parallel levels in the D1 division approval hierarchy:

D1 Division Approval Hierarchy		
Approval Level	To Do Role	Approve Deal
Level 1	D1 Pricing Manager (D1 PM)	Yes
Level 2	D1 Senior Pricing Manager 1 (D1 SPM1)	Yes
Level 2	D1 Senior Pricing Manager 2 (D1 SPM2)	Yes
Level 3	D1 Executive Pricing Manager (D1 EPM)	Yes

The following table lists the approvers at different levels including the parallel levels in the D2 division approval hierarchy:

D2 Division Approval Hierarchy		
Approval Level	To Do Role	Approve Deal
Level 1	D2 Pricing Manager 1 (D2 PM1)	Yes
Level 1	D2 Pricing Manager 2 (D2 PM2)	Yes

D2 Division Approval Hierarchy		
Approval Level	To Do Role	Approve Deal
Level 2	D2 Senior Pricing Manager (D2 SPM)	Yes
Level 3	D2 Executive Pricing Manager 1 (D2 EPM1)	Yes
Level 3	D2 Executive Pricing Manager 2 (D2 EPM2)	Yes

The following table lists the approvers at different levels including the parallel levels in the deal approval hierarchy:

Deal Approval Hierarchy		
Approval Level	To Do Role	Approve Deal
Level 0	Relationship Manager (RM)	Yes
Level 1	Pricing Manager (PM)	No
Level 2	Senior Pricing Manager 1 (SPM1)	No
Level 2	Senior Pricing Manager 2 (SPM2)	Yes
Level 3	Executive Pricing Manager (EPM)	Yes

The following figure graphically indicates how a deal moves from one approver to another in the given deal approval scenario:

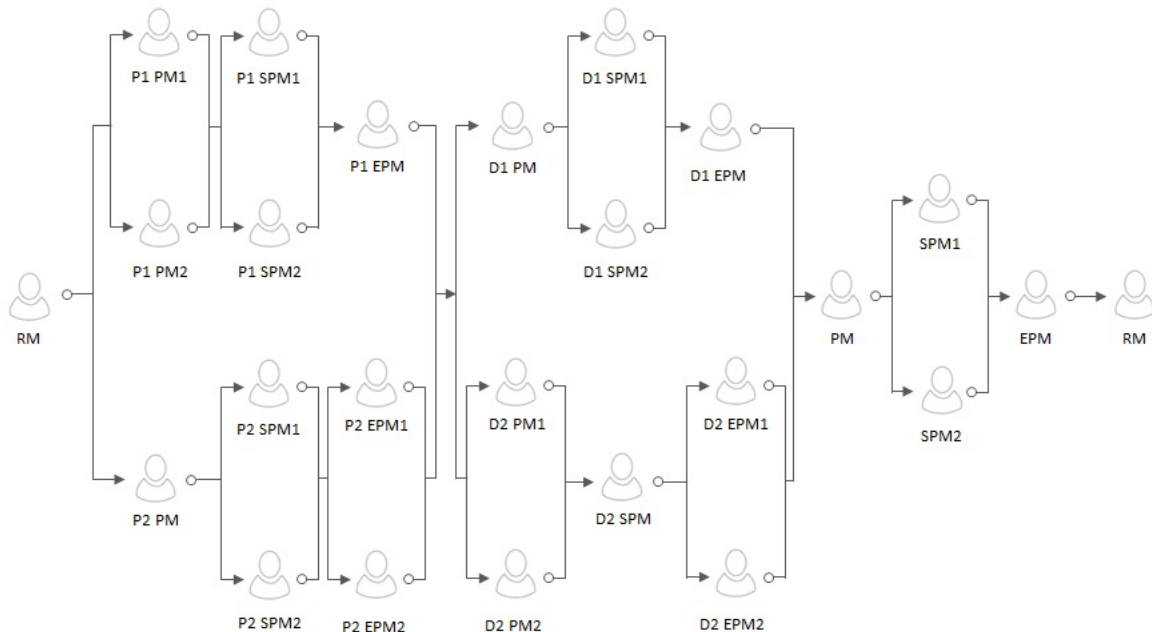

Deal Approval Scenario 10

The following table illustrates the different levels of approval that are required for a deal in scenario 10:

Scenario 10	Price Item Approval Required	Yes
-------------	------------------------------	-----

	Product Level Approval Required	Yes
	Division Level Approval Required	Yes
	Parallel Approval in the Product, Division, or Deal Approval Hierarchy	Yes
	Highest Level Approval Required	Yes

The following table lists the approvers at different levels including the parallel levels in the P1 product approval hierarchy:

P1 Product Approval Hierarchy		
Approval Level	To Do Role	Approve Deal
Level 1	P1 Product Manager 1 (P1 PM1)	Yes
Level 1	P1 Product Manager 2 (P1 PM2)	Yes
Level 2	P1 Senior Product Manager 1 (P1 SPM1)	Yes
Level 2	P1 Senior Product Manager 2 (P1 SPM2)	Yes
Level 3	P1 Executive Product Manager (P1 EPM)	Yes

The following table lists the approvers at different levels including the parallel levels in the P2 product approval hierarchy:

P2 Product Approval Hierarchy		
Approval Level	To Do Role	Approve Deal
Level 1	P2 Product Manager (P2 PM1)	Yes
Level 2	P2 Senior Product Manager 1 (P2 SPM1)	Yes
Level 2	P2 Senior Product Manager 2 (P2 SPM2)	Yes
Level 3	P2 Executive Product Manager 1 (P2 EPM1)	Yes
Level 3	P2 Executive Product Manager 2 (P2 EPM2)	Yes

The following table lists the approvers at different levels including the parallel levels in the D1 division approval hierarchy:

D1 Division Approval Hierarchy		
Approval Level	To Do Role	Approve Deal
Level 1	D1 Pricing Manager (D1 PM)	Yes
Level 2	D1 Senior Pricing Manager 1 (D1 SPM1)	Yes
Level 2	D1 Senior Pricing Manager 2 (D1 SPM2)	Yes
Level 3	D1 Executive Pricing Manager (D1 EPM)	Yes

The following table lists the approvers at different levels including the parallel levels in the D2 division approval hierarchy:

D2 Division Approval Hierarchy		
Approval Level	To Do Role	Approve Deal
Level 1	D2 Pricing Manager 1 (D2 PM1)	Yes
Level 1	D2 Pricing Manager 2 (D2 PM2)	Yes
Level 2	D2 Senior Pricing Manager 1 (D2 SPM1)	Yes
Level 2	D2 Senior Pricing Manager 2 (D2 SPM2)	Yes
Level 3	D2 Executive Pricing Manager 1 (D2 EPM1)	Yes
Level 3	D2 Executive Pricing Manager 2 (D2 EPM2)	Yes

The following table lists the approvers at different levels including the parallel levels in the deal approval hierarchy:

Deal Approval Hierarchy		
Approval Level	To Do Role	Approve Deal
Level 0	Relationship Manager (RM)	Yes
Level 1	Pricing Manager 1 (PM1)	No
Level 1	Pricing Manager 2 (PM2)	No
Level 2	Senior Pricing Manager 1 (SPM1)	No
Level 2	Senior Pricing Manager 2 (SPM2)	Yes
Level 3	Executive Pricing Manager (EPM)	Yes

The following table lists the price item managers who can approve the respective price item in the deal:

Price Item Managers			
Price Item	Product	Division	Price Item Manager
PI1	P1		PI1 Pricing Manager (PI1 PM)
PI2	P2		PI2 Pricing Manager (PI2 PM)
PI3	P1		PI3 Pricing Manager (PI3 PM)
PI4	P2		PI4 Pricing Manager (PI4 PM)
PI5		D1	PI5 Pricing Manager (PI5 PM)
PI6		D2	PI6 Pricing Manager (PI6 PM)
PI7		D1	PI7 Pricing Manager (PI7 PM)
PI8		D2	PI8 Pricing Manager (PI8 PM)

The following figure graphically indicates how a deal moves from one approver to another in the given deal approval scenario:

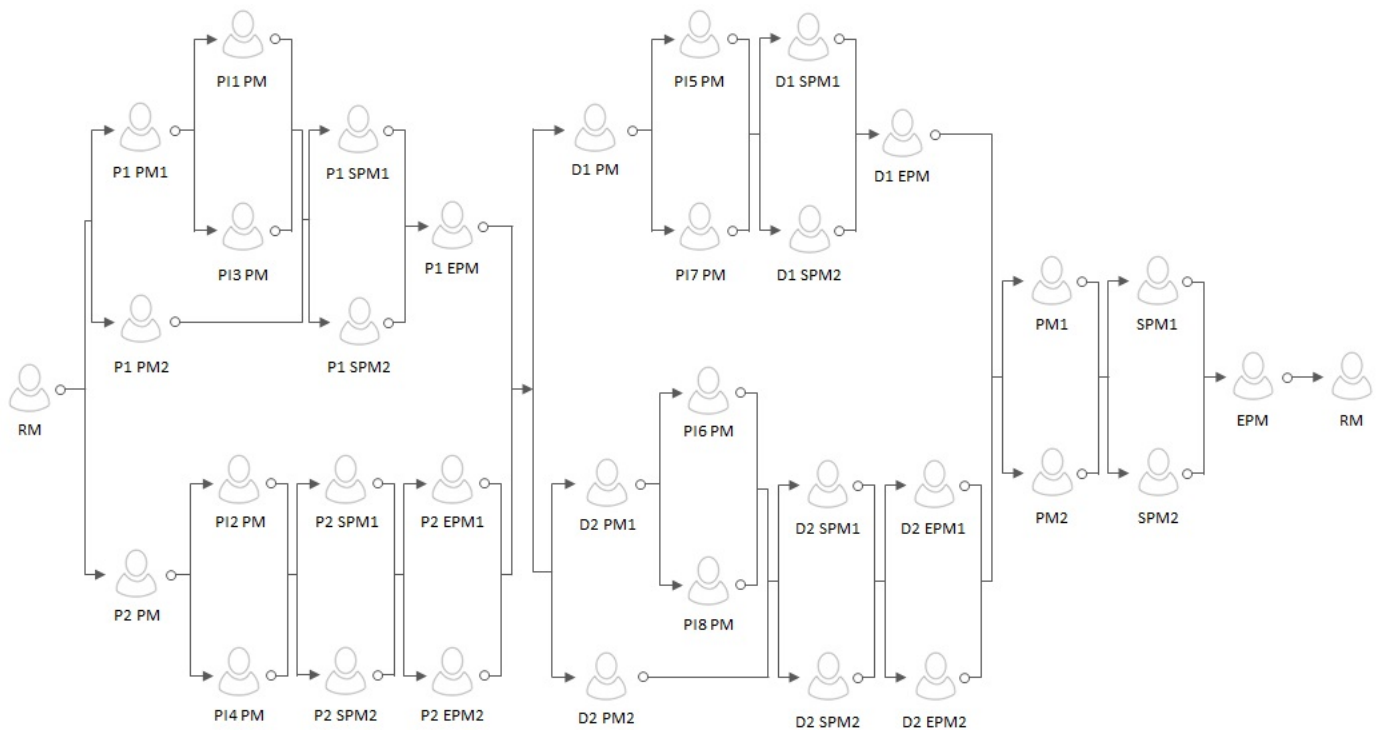

Different Stages in Deal Lifecycle

Following stages are involved in deal modelling:

- [Deal Creation](#) on page 2643
- [Reference Selection](#) on page 2644
- [Simulation](#) on page 2645
- [Price Item Approval](#) on page 2645
- [Division Level Approval](#) on page 2645
- [Deal Level Approval](#) on page 2646
- [Deal Finalization](#) on page 2646
- [Customer Acceptance or Rejection](#) on page 2646
- [Apply Back or Orchestration](#) on page 2646

Deal Creation

While creating a deal, you need to specify various details, such as entity for which you want to create the deal, simulation type, deal type, deal date range, price selection date, deal frequency, usage period, review frequency, deal version, etc. You can maintain different versions of a deal. A deal version feature facilitates you to perform what-if analysis. Through each deal version, you can analyze the cost, revenue, and profitability for a different set of proposed pricing and commitments. However, you can only send one best version of a deal for the approval. The system then automatically discards the other versions in a deal.

A deal type helps the system to determine:

- Whether the pricing for each price item should be approved in the deal.
- Whether the deal should be assigned to users for approval as per the limits defined in the deal approval profile.

- Whether the pricing and financial summary should be approved by the respective division.
- Whether the highest level approval is required for the deal.
- Whether the existing pricing should be pre-approved in the deal.
- The deal approval profile that should be used for a division level approval.
- The deal approval profile that should be used for the deal level approval based on the division, customer segment, and customer tier combination.

Whereas, the deal approval profile helps the system to determine:

- Different levels in the division or deal approval hierarchy which can approve the pricing and financial summary of the deal.

Note: At present, you can add an approval level from 0 to 10. If required, you can add more approval levels in the system through the **C1_DEALHIERARCHYLEVEL** lookup field.

- To Do type using which a To Do should be created for the approver at each level.
- To Do role whose users must receive the To Do for approval.
- Whether the users at the approval level can propose a new pricing for a price item while approving the deal.

Note: As per the business requirements, a deal level approver can only propose a new pricing for a price item while approving a deal. However, this feature is currently not implemented and would be available for use in the future release.

- Whether the users at the approval level can request the respective price item manager to approve the pricing for the price item.
- Whether the users at the approval level can approve the deal.
- Whether the users at the approval level should only view those price items for approval for whom floor and ceil limits are defined for the price item.
- The minimum and maximum profitability, deviation, and revenue which the users at the approval level can approve in the deal.

The system enables you to configure parallel approval at any level in the division or deal approval hierarchy. Once the deal is created in the **Draft** status, you can either skip the reference or provide the reference.

Reference Selection

The system enables you to refer another customer, account, or deal for pricing and commitments. The system does the following when you select the respective reference:

- **Customer** - You can refer another customer while creating a deal for an existing customer or a prospect person. If you use this reference, the system does the following:
 - Copies the price list assignments and price assignments of the referenced customer and assigns the price lists and pricing to the prospect person in the **Proposed** status.
 - Copies the commitments from the SQI-based billable charges of the referenced customer's accounts (based on the deal frequency and usage period), and accordingly adds rolled up proposed commitments for the prospect person.

In addition, if you use this reference for a prospect person, the system copies the hierarchy of the referenced customer when the **Refer Customer Hierarchy** option is selected.

- **Account** - You can refer another account while creating a deal for an existing account. If you use this reference, the system does the following:
 - Copies the price list assignments and price assignments of the referenced account and assigns the price lists and pricing to the prospect account in the **Proposed** status.

- Copies the commitments from the SQI-based billable charges of the referenced account (based on the deal frequency and usage period), and accordingly adds proposed commitments for the prospect account.
- **Deal** - You can refer another deal which is created for a customer while creating a deal for an existing customer or a prospect person. And, you can refer another deal which is created for an account while creating a deal for an existing account. If you use this reference for an existing customer or a prospect person, the system does the following:
 - Copies the price list assignments and price assignments of the referenced deal's customer and assigns the price lists and pricing to the prospect person in the **Proposed** status.
 - Copies the commitments from the SQI-based billable charges of the referenced deal's customer (based on the deal frequency and usage period), and accordingly adds proposed commitments for the prospect person.

However, if you use this reference for an existing account, the system does the following:

- Copies the price list assignments and price assignments of the referenced deal's account and assigns the price lists and pricing to the prospect account in the **Proposed** status.
- Copies the commitments from the SQI-based billable charges of the referenced deal's account (based on the deal frequency and usage period), and accordingly adds proposed commitments for the prospect account.

Once you select or skip the reference, the system checks whether the number of accounts in the customer hierarchy exceeds the account limit defined in the **C1-Deal** feature configuration. If the number of accounts in the customer hierarchy does not exceed the account limit, the system creates the corresponding prospect persons and accounts immediately and then changes the status of the deal to **Pending Simulation**. However, if the number of accounts in the customer hierarchy exceeds the account limit, the status of the deal is changed to **Hierarchy Creation Deferred**. On executing the **C1_HRC** batch, the system checks whether there are any deals in the **Hierarchy Creation Deferred** status. If so, the system creates the corresponding prospect persons and accounts for the deal and then changes the status of the deal to **Pending Simulation**.

Simulation

Once the deal is in the **Pending Simulation** status, you can do the following:

- Assign a new price list to the prospect person or account
- Edit/override the proposed price assignment of the prospect person or account
- Enroll the prospect account for a new product
- Edit the proposed commitments of the prospect account

Once the required changes are made to the deal, you can simulate the proposed pricing on the proposed commitments. In other words, you can simulate the deal version. On simulating a deal version, the system checks whether the proposed commitments exceed the limit defined in the **C1-Deal** feature configuration. If the proposed commitments do not exceed the limit, the system calculates the cost, revenue, and profitability for the deal version immediately and then changes the status of the deal to **Simulated**. However, if the proposed commitments exceed the limit, the status of the deal is changed to **Simulation Deferred**. On executing the **C1_SMLD** batch, the system checks whether there are any deals in the **Simulation Deferred** status. If so, the system calculates the cost, revenue, and profitability for the deal version and then changes the status of the deal and its version to **Simulated**.

Price Item Approval

If the **Price Item Approval Required** field is set to **Yes** in the deal type, the pricing of all the price items should be approved before the deal is approved. An approver at any level in the division or deal approval hierarchy can approve the pricing of a price item when the pricing falls within the floor and ceil limits of the approver. Additionally, if the **Submit Price Item for Approval** field is set to **Yes** for an approval level, the approver at the respective level can request the price item manager to approve the pricing for the price item. On clicking the **Submit Price Item for Approval** button, the status of the deal is changed to **Pending for Approval**.

Division Level Approval

If the **Division Level Approval Required** field is set to **Yes** in the deal type, the system creates a To Do for the approver at the first level in the division approval hierarchy. The approver can either approve the division-specific pricing and financial summary or request the submitter to resubmit the deal for approval after making the required changes. If the approver at the first level in the division approval hierarchy approves the division-specific pricing and financial summary, or if the approver at the first level in the division approval hierarchy cannot approve the division-specific pricing and financial summary, the system creates a To Do for the approver at the next level in the division approval hierarchy. This process continues until the approval is received from all the levels in the division approval hierarchy.

Deal Level Approval

Once the approval is received from all the levels in the division approval hierarchy, the system creates a To Do for the approver at the first level in the deal approval hierarchy. The approver can either approve the deal or request the submitter to resubmit the deal for approval after making the required changes. If the approver at the first level in the deal approval hierarchy approves the deal and if the highest level approval is not required, the system changes the status of the deal to **Approved**. However, if the approver at the first level in the deal approval hierarchy cannot approve the deal, the system creates a To Do for the approver at the next level in the deal approval hierarchy. This process continues until the deal is approved by any level in the deal approval hierarchy. However, if the highest level approval is required for the deal, this process continues until the deal is approved by the highest level in the deal approval hierarchy.

Deal Finalization

Once a deal is approved, you can finalize the deal. On clicking the **Finalize** button, the status of the deal is changed to **Finalized**.

Customer Acceptance or Rejection

The system enables you to either accept or reject the finalized deal based on the customer feedback. On clicking the **Accept** button, the status of the deal is changed to **Customer Accepted**. However, on clicking the **Reject** button, the status of the deal is changed to **Rejected**.

Apply Back or Orchestration

Once the deal is accepted for an existing customer or account, you can click the **Apply Back** button. On clicking the **Apply Back** button, the system does the following:

- Copies a new proposed price list assignment and assigns the price list to the respective customer or account in the **Active** status.
- Ends the price assignment of the respective customer or account when it is overridden or edited for the prospect customer or account.
- Creates a new price assignment for respective customer or account when it is overridden or edited for the prospect customer or account.
- Copies a new proposed product enrollment and enrolls the respective account for the product in the **Active** status.

The customer acceptance date is used as the start date while adding the new price list assignments, price assignments, and product enrollments.

Once the above changes are made, the system changes the status of the deal to **Fully Orchestrated**. The system enables you to onboard a prospect person or account through the **File Upload Request** utility. Once the person or account is created, the system checks whether there is any deal with the specified deal identifier in the **Customer Accepted** status. If so, the system checks whether the primary person or account identifier matches with the primary prospect person or account identifier, respectively. If so, the system adds the person or account ID corresponding to the prospect person or account. Then, the system changes the status of the deal to **Partially Orchestrated**. Once the system creates persons and accounts for the entire prospect hierarchy, the status of the deal is changed to **Fully Orchestrated**.

Deal Monitoring

Oracle Revenue Management and Billing enables the relationship manager to assess the deal at regular intervals using the **Deal Monitoring** feature. The system sends the To Do reminders to the relationship manager at predefined intervals to review the deal. On assessing a deal, the relationship manager can accordingly add the review comments for the deal.

To send the To Do reminders for deal review, you need to set the following fields in the required deal types:

- **To Do Reminder Days** – Used to indicate the number of days using which the system calculates the To Do reminder date.
- **To Do High Priority Days** – Used to indicate the number of days using which the system calculates the date when the To Do reminder of highest priority should be sent.
- **Deal Monitor To Do Type** – Used to indicate the To Do type using which the To Do should be created for the deal review.

The **Deal Monitoring (C1_DLMTR)** batch is used to monitor or check whether there is any deal in the **Fully Orchestrated** status. If there is a deal in the **Fully Orchestrated** status, the system considers its deal version which is in the **Fully Orchestrated** status. It then does the following:

- Calculates the review date and To Do reminder date for the deal
- Create a To Do for deal review and changes the status of the deal to **Pending For Review** when the To Do reminder date is equal to the system date

If the deal is not yet reviewed even once, the batch calculates the first review date using the deal effective start date and deal review frequency. For example, if there is a deal which is effective from 07-01-2020 to 12-31-2021 and where the deal review frequency is set to **Biannually**, the system sets the first review date to 01-01-2021 (i.e. 07-01-2020 + 6 months). However, if the deal is already reviewed in the past, the batch calculates the subsequent review date using the last review date and deal review frequency. For example, if there is a deal which is effective from 07-01-2020 to 12-31-2021 and where the last review date is set to 01-01-2021 and the deal review frequency is set to **Biannually**, the system sets the subsequent review date to 07-01-2021 (i.e. 01-01-2021 + 6 months). Note that if the calculated review date is later than the deal effective end date, then the batch sets the review date to the deal effective end date. For example, if there is a deal which is effective from 07-01-2020 to 12-31-2021 and where the last review date is set to 07-01-2021 and the deal review frequency is set to **Biannually**, the system sets the subsequent review date to 12-31-2021. This is because the calculated review date (i.e. 01-01-2022) is later than the deal effective end date (i.e. 12-31-2021).

In addition, the batch calculates the To Do reminder date which is review date minus the To Do reminder days. For example, if the review date is 12-31-2021 and To Do reminder days is 60, the system sets the To Do reminder date to 11-01-2021. For more information about the batch, refer to *Oracle Revenue Management and Billing Batch Guide*. After executing the **Deal Monitoring (C1_DLMTR)** batch, you need to execute the **Recalculate To Do Priority (F1-TDCLP)** batch. The **Recalculate To Do Priority (F1-TDCLP)** batch recalculates and changes the priority of the To Do reminder using the following formula:

$(\text{To Do Reminder Days} - \text{To Do High Priority Days}) / \text{Number of Priority}$

For example,

The following table lists the parameters and their values which are used for calculating the priority of the To Do reminders:

To Do Reminder Days	90
To Do High Priority Days	30
To Do Reminder Date	01-April-20
Deal Review Date	30-June-20
Number of Priority	8

In this case, the system changes the priority of the To Do reminder after every 8 days (i.e. $(90-30)/8=7.5$) as mentioned in the below table:

System Date	Priority
1-April-2020	Lowest - Priority 9
9-April-2020	Priority 8
17-April-2020	Priority 7
25-April-2020	Priority 6
02-May-2020	Priority 5
10-May-2020	Priority 4
18-May-2020	Priority 3
26-May-2020	Priority 2
01-June-2020	Highest Priority 1

The system changes the To Do priority from Priority 9 to Priority 1 where 9 is the lowest and 1 is the highest. The system always ensures that the priority of the To Do reminder to highest is set 10 days before the deal review date. However, if the output of the above formula is zero, the system changes the priority of the To Do reminder every day.

If a deal is in the **Pending For Review** status, the **Review Deal** icon appears corresponding to the deal in the **Search Deal** zone of the **Deal Dashboard** screen. On clicking the **Review Deal** icon, the **Deal Review** window appears. Here, the relationship manager can add the review comments for the deal after assessing its performance. On adding the review comments, the status of the deal is changed from **Pending For Review** to **Fully Orchestrated**.

Product Level Approval for Deals

Until now, the relationship manager could send one best version of the deal for the division and deal level approvals. Now, in addition, the relationship manager can send one best version of the deal for the product level approval when the following conditions are met:

- Customers or accounts in the deal have enrolled for the products
- **Product Level Approval Required** field is set to **Yes** in the respective deal type
- Deal approval profile is specified for the division and product combination in the respective deal type

The system enables you to design a deal approval profile for the product approval hierarchy. The deal approval profile of a product and division combination helps the system to determine:

- Different levels in the product approval hierarchy which can approve the price item pricing and financial summary of the product in the deal. Note that the product level approver can only approve the pricing of those price items which are included in the product.
- Whether the product level approver can recommend a new pricing for a price item while approving the deal.
- Whether the product level approver can request the respective price item manager to approve the pricing for the price item.
- Whether the product level approver can approve the deal.
- Whether the product level approver should only view those price items for approval for which floor and ceil limits are within his approval range.
- The minimum and maximum profitability, profit, profit variation, and revenue which the product level approver can approve in the deal.

In a deal type, you can now specify the approval profile for a division and product combination using the approval type as **Product**. If a product is associated to multiple divisions, you can specify the approval profile for each division and product combination. If a deal is created for a customer or prospect whose accounts belong to different divisions, but have enrolled for the same product, the system then creates a product approval hierarchy for each division and

product combination. For example, if the SAVINGS product is associated to two divisions named CA and US and an approval profile is specified for both the combinations (i.e. SAVINGS and CA; SAVINGS and US) in the deal type, the system will create two product approval hierarchies when two accounts belonging to different divisions (i.e. CA and US) have enrolled for the SAVINGS product in a deal. One product approval hierarchy would be for the SAVINGS and US combination and another product approval hierarchy would be for the SAVINGS and CA combination. However, if the SAVINGS product is associated to two divisions named CA and US and an approval profile is specified only for the SAVINGS and CA combination in the deal type, the system will create one product approval hierarchy for the SAVINGS and CA combination. The system will not create product approval hierarchy for the SAVINGS and US combination because there is no approval profile configured for this combination in the deal type.

Note: You cannot specify the same approval profile for the same or different product and different division combination. However, you can specify the same approval profile for the different product and same division combination.

The system enables you to configure parallel approval at any level in the product approval hierarchy. If the **Product Level Approval Required** field is set to **Yes** and the **Division Level Approval Required** field is set to **Yes**, the system first sends the deal to the product approval hierarchy, then to the division approval hierarchy and finally to the deal approval hierarchy for approval. However, if the **Product Level Approval Required** field is set to **Yes** and the **Division Level Approval Required** field is set to **No**, the system first sends the deal to the product approval hierarchy and then to the deal approval hierarchy for approval.

If the **Product Level Approval Required** field is set to **Yes** in the deal type, the system creates a To Do for the approver at the first level in the product approval hierarchy. The approver can either approve the product-specific price item pricing and product financial summary or request the submitter to resubmit the deal for approval after making the required changes. If the approver at the first level in the product approval hierarchy approves the product-specific price item pricing and product financial summary, or if the approver at the first level in the product approval hierarchy cannot approve the product-specific price item pricing and product financial summary, the system creates a To Do for the approver at the next level in the product approval hierarchy. This process continues until the approval is received from all the levels in the product approval hierarchy.

Note that a product level approver can recommend a price for a price item which is included in the product when the **Propose Pricing** field is set to **Yes** for the approval level in the deal type. After recommending a new price (i.e. rate), the product level approver needs to request the submitter to resubmit the deal for approval after considering the recommended price.

If the **Product Level Approval Required** field is set to **Yes** and if customers or accounts in the deal have enrolled for the products, the **Product Financial Summary** section appears in the **Simulation Details** zone when you simulate the deal. It indicates the revenue, cost, profit, and profitability for each product and division combination. In addition, the **Product Financial Summary** section appears in the **Pricing and Commitments** screen. It indicates the revenue and cost of each product to which existing customer's or prospect's account is enrolled. The system calculates the revenue and cost based on the original, proposed, and recommended prices, and accordingly shows the variation between original, proposed and recommended revenue.

Recommended Pricing

Oracle Revenue Management and Billing enables the approver at any level in the product approval hierarchy, division approval hierarchy, and deal approval hierarchy to recommend a price for a price item. An approver can recommend a price for a price item when the **Propose Pricing** field is set to **Yes** for the respective level in the approval hierarchy.

Note: The **Propose Pricing** field is non-editable for the Level 0 in the deal approval hierarchy. By default, it is set to **No**.

The recommended pricing related columns (such as **Pricing Information**, **Average Price**, and **Revenue**) are visible to the approver in the **Pricing and Commitments** section of the **Pricing and Commitments** screen. The **Recommend Price** link appears in the **Pricing Information** column corresponding to each price item. On clicking the **Recommend Price** link, the **Deal Pricing** screen appears. The **Rate** field corresponding to each price component is editable in the **Projected Pricing** section of the **Deal Pricing** screen. The approver can recommend a new price for the price item. However, note that the recommended price for the price item should be within the negotiability floor and ceil limits of the approver.

On simulating the deal, the system calculates the average price, revenue, cost, profit, and profitability based on the recommended price. It checks whether the average price of the price item is within the average price floor and ceil limits of the approver and accordingly changes the status of the price item to **Approved**, **Pending for Approval**, or **Error**. After analyzing the profitability of the deal, the approver can click the **Return to Submitter** button and thereby request the submitter to consider the recommended price for the price item. On clicking the **Return to Submitter** button, the status of the price item is changed to **Approver Recommended**. In addition, a To Do is generated for the relationship manager of the deal. If required, the approver who has recommended the price can edit or delete the recommended price before clicking on the **Return to Submitter** button.

If the approver has sent the price item to the price item manager for approval, the approver cannot recommend the price for the price item. And, if the approver has recommended the price for a price item, the approver cannot send the price item to the price item manager for approval. In such case, the approver can send the price item to the price item manager for approval only after deleting the recommended price for the price item.

In case of parallel approval, if one approver has recommended the price for a price item, the other approver can view the recommended price for the price item. But, the other approver cannot edit or delete the recommended price for the price item. Also, in case of parallel approval, if one approver has sent the price item to the price item manager for approval, then other approver cannot recommended price for the price item. And, vice-versa, if one approver has recommended price for the price item, then other approver cannot send the price item to the price item manager for approval.

On viewing the recommended price for the price item, the relationship manager may or may not edit the price of the price item based on the approver recommendation. If the relationship manager edits the price of the price item based on the approver recommendation, the system checks whether the proposed price is within the negotiability floor and ceil limits of the relationship manager. Then, on simulating the deal, the system calculates the average price, revenue, cost, profit, and profitability based on the new proposed price. It checks whether the average price of the price item is within the average price floor and ceil limits of the relationship manager. Here, the system derives a new floor and ceil range for the relationship manager dynamically using the approver recommended price and accordingly changes the status of the price item to **Approved**, **Pending for Approval**, or **Error**.

Deal Currency Conversion

Oracle Revenue Management and Billing enables you to view the division financial summary (i.e. revenue, cost, profit, and profitability of the division) in the deal currency or in the respective division currency. A toggle switch appears above the **Division Financial Summary** section. By default, the division financial summary is shown in the deal currency. On clicking the toggle switch, you can view the division financial summary in the division's base currency.

In addition, the system enables you to:

- View the original and proposed revenue and cost of a customer (in the customer hierarchy) in the deal currency or in the respective customer's division currency
- View the original and proposed revenue and cost of an account (in the customer hierarchy) in the deal currency or in the respective account's invoice currency
- View the original and proposed revenue and cost of a price item assigned to a customer in the deal currency or in the respective customer's division currency
- View the original and proposed revenue and cost of a price item assigned to an account in the deal currency or in the respective account's invoice currency
- View the average price of a price item assigned to a customer in the pricing currency or in the respective customer's division currency
- View the average price of a price item assigned to an account in the pricing currency or in the respective account's invoice currency

A toggle switch appears above the respective section. By default, the original and proposed revenue and cost are shown in the deal currency and the average price of the price item is shown in the pricing currency. On clicking the toggle switch, you can view the original and proposed revenue and cost and average price of the price item in the customer's division currency or account's invoice currency.

During currency conversion, the system uses the currency conversion algorithm attached to the **Currency Conversion For Bill Segments** system event of the division. Note that the currency conversion happens when the **Allow Multi-Currency Accounts** option type of the **C1_MLTCURACC** feature configuration is set to **Y**.

Reference Selection Based on Questionnaire

Oracle Revenue Management and Billing enables you to derive reference customers and deals during a deal creation using a questionnaire. Note that the reference deals are those deals which belong to the reference customers which are derived using the questionnaire. The system displays the questions from the questionnaire template which is specified in the respective deal type. Note that the system considers the questionnaire template specified in the deal type when it is effective on the deal start date. You can also skip the questionnaire using the **Skip Questionnaire** option. If a questionnaire template is not specified in the respective deal type or if the questionnaire template is not effective on the deal start date or if the **Skip Questionnaire** option is selected during the deal creation, the system derives the reference customers for the deal using the division, customer segment, and customer tier combination. Note that reference deals are not derived when the **Skip Questionnaire** option is selected during the deal creation.

While defining a questionnaire template, you can specify the following:

- The date range when the questionnaire template is effective
- Whether to display the questions from the questionnaire template in a particular sequence or when a rule of a particular rule type is satisfied
- A set of questions that you want the customer to answer
- Whether the answer for the question should be:
 - Date
 - Decimal Value
 - From Multi Selection Drop Down List
 - From Multi Selection Check Box List
 - Numeric Value
 - Percentage
 - From Radio Button List
 - From Single Selection Drop Down List
 - Text
- Whether the answer value set for the following answer types should be derived from the reference data or from a predefined list:
 - Multi Selection Drop Down List
 - Multi Selection Check Box List
 - Radio Button List
 - Single Selection Drop Down List
- The reference table, column, and criteria when the answer value set is set to **Reference Data**. Note that you can only use the Equal To and IN operators while defining the reference criteria.
- The default answer for the question
- Whether the question is mandatory or optional in the questionnaire
- The parameter which helps to derive the reference customers when the question is answered in the questionnaire. Note that you can only specify a parameter where the source entity is set to **Person** or **Account** and the source type is set to **Characteristic** or **Field**.

- The rule type which helps to determine the rules that should be executed to display the next question in the questionnaire
- Whether the response from the question should be used to derive the reference customer list
- The predefined values when the answer value set is set to **Predefined List**

A new screen named **Questionnaire Template** is introduced in this release. You can define, edit, delete, copy, and preview a questionnaire template through this screen. On previewing a sequence based or rule based questionnaire template, the questions appear in the specified sequence. When a rule based questionnaire template is used during a deal creation, the system displays the next question based on the output of the previous question.

A new page named **Questionnaire** is added to the **Deal Information** screen which helps to answer the questionnaire. The number of questions that appear in the **Questionnaire** page depends on the value specified in the **Questionnaire UI Pagination Limit** option type of the **C1-DEAL** feature configuration.

Rate Negotiability for Price Item in Deal

Oracle Revenue Management and Billing enables you to indicate whether the rate is negotiable for a price item in a deal. A new field named **Negotiability Switch** is introduced while defining or editing a price item. The system enables you to set the negotiability option for a price item at the division level. Therefore, you can set different the negotiability option for the divisions to which the price item is associated. By default, the **Negotiability Switch** field is set to **No**.

If you set the **Negotiability Switch** field to **No** for a division of a price item, you cannot edit or override the rate of the price item in a deal when the customer or account to which the price item is assigned belongs to the division. However, if you set the **Negotiability Switch** field to **Yes** for a division of a price item, you can edit or override the rate of the price item in a deal when the customer or account to which the price item is assigned belongs to the division. Along with the **Negotiability Switch** field, you can also set the **Only Within Range** field which indicates that the system should validate whether the negotiated rate is within the negotiability floor and ceil limits. The **Only Within Range** field is enabled only when the **Negotiability Switch** field is set to **Yes**. By default, the **Only Within Range** field is set to **No**.

If the **Only Within Range** field is set to **No**, the system does not validate whether the negotiated rate is within the negotiability floor and ceil limits. However, if the **Only Within Range** field is set to **Yes**, the system validates whether the negotiated rate is within the negotiability floor and ceil limits. You can define the negotiability floor and ceil limits for a division of a price item at the price item level or at the price assignment level.

On clicking the link in the **Pricing Information** column corresponding to a price item in the **Pricing and Commitments** screen, the system enables you to edit or override the original pricing when the **Negotiability Switch** field is set to **Yes** for the price item and thereby create a proposed pricing. If the **Only Within Range** field is set to **Yes**, the system first validates whether the negotiated rate is within the negotiability floor and ceil limits specified in the original pricing (in case of override) or proposed pricing (in case of edit). To validate the rate, the system considers the pricing where the price item, pricing currency, and division (for which pricing is defined on the customer or account) is same. If the negotiated rate is within the negotiability floor and ceil limits specified in the original or proposed pricing, the system enables you to edit or override the rate. However, if the negotiated rate is not within the negotiability floor and ceil limits specified in the original or proposed pricing, an error occurs indicating that the specified rate is not within the negotiability floor and ceil limits.

If the negotiability floor and ceil limits are not specified for the division in the original or proposed pricing, the system checks whether the negotiated rate is within the negotiability floor and ceil limits specified at the price item level. The system considers the negotiability range of the pricing currency. If the negotiated rate is within the negotiability floor and ceil limits specified at the price item level, the system enables you to edit or override the rate. However, if the negotiated rate is not within the negotiability floor and ceil limits specified at the price item level, an error occurs indicating that the specified rate is not within the negotiability floor and ceil limits. If the negotiability range is not defined for the pricing currency, the system does not validate whether the negotiated rate is within the negotiability floor and ceil limits of the price item.

If the rate negotiability feature is configured for a price item, the system enables:

- The relationship manager to propose a negotiated rate for the price item
- The product level approver, division level approver, and deal level approver to recommend a rate for the price item.

Price Item Selection during Deal Creation

Oracle Revenue Management and Billing enables you to select the price items which you want to offer in a deal. If you create a deal for an existing customer, the system, by default, selects the following price items:

- Whose pricing is directly assigned to the customer
- Whose pricing is inherited by the customer

Note that the system does not by default select the price items assigned to the customer's accounts and the price items assigned to the child customers and their accounts. And, if you create a deal for an existing account, the system, by default, selects the following price items:

- Whose pricing is directly assigned to the account
- Whose pricing is inherited by the account

The default price item selection is done when the following conditions are met:

- Deal is created for an existing customer or an account
- Default commitments are not defined in the respective deal type

However, if the deal is created for a proposed customer or if the default commitments are defined in the respective deal type, the system does not select the price items, by default, in the **Price Item Group Selection** screen. You have to manually select the required price items in the **Price Item Group Selection** screen. Only then, the system considers the pricing and commitments of the selected price items in the deal.

If required, you can deselect a price item the **Price Item Group Selection** screen. You can access the **Price Item Group Selection** screen in either of the following ways:

- By clicking the **Edit**  icon in the **Price Item Group Selection** column corresponding to the customer or account in the **Simulation Details** zone of the **Deal Information** screen
- By clicking the **Select Price Item Group** button in the **Pricing and Commitments** screen
- By clicking the **Save and Select Price Item Group** button in the **Price List Assignment** screen

Only the selected price items are then considered in the deal for simulation. On assigning a price list to an entity in the customer hierarchy, you need to select the price items whose pricing you want to inherit from the price list. Only the selected price items from the price list will be considered in the deal for simulation. If you remove a price list which is newly assigned to an entity in the deal, the price item pricing inherited from the price list is removed from the **Pricing and Commitments** screen.

However, if you override a price list pricing and create a customer or account agreed pricing for the entity, the system does not delete the customer or account agreed pricing when the assigned price list is removed from the deal.

The system enables you to select or deselect all price items within a root level or non-root level hierarchy entity by selecting the check box corresponding to the root level or non-root level hierarchy entity. On clicking the check box corresponding to the root level hierarchy entity, all the subsequent non-root level hierarchy entities and their price items are selected.

Price Item and Hierarchy Entity Selection in a Deal Based on Characteristic Value

The system provides an alternative solution wherein the price items and hierarchy entities are automatically selected based on their characteristic in the **Price Item Group Selection** screen. Two new algorithm spots named **Price Item Group List Filter** and **Price Item Selection Validation** are available while defining a deal type. A new algorithm type named **C1-DPIG-ELIG** is introduced in this release. This algorithm checks whether the characteristic type specified in the parameter is defined on each price item and hierarchy entity. A new characteristic type named **C1_SEL_T** is

shipped with the product. It has three predefined values – **Standard**, **Mandatory**, and **Optional**. On accessing the **Price Item Group Selection** screen of an entity for the first time in a deal, the system checks whether the **C1-DPIG-ELIG** algorithm is attached to the **Price Item Group List Filter** system event in the respective deal type.

If the **C1-DPIG-ELIG** algorithm is not attached to the **Price Item Group List Filter** system event in the respective deal type, the system behaves in the traditional manner. However, if the **C1-DPIG-ELIG** algorithm is attached to the **Price Item Group List Filter** system event in the respective deal type, the system checks whether the characteristic type specified in the **C1-DPIG-ELIG** algorithm is defined for each price item and hierarchy entity. If so, the system behavior for each price item and hierarchy entity varies depending on the value defined for the **C1_SEL_T** characteristic type on the respective price item and hierarchy entity. The following table explains the significance of each predefined characteristic value:

Characteristic Value	System Behavior
Standard	If the characteristic value is set to Standard , the system, by default, selects the check box corresponding to the price item or hierarchy entity in the Price Item Group Selection screen. The check box is editable. If the C1_SEL_T characteristic of a parent entity in the price item hierarchy is set to Standard , the system checks the C1_SEL_T characteristic of each child entity in the respective hierarchy and behaves based on the value defined for the C1_SEL_T characteristic type on the respective child entity.
Mandatory	If the characteristic value is set to Mandatory , the system, by default, selects the check box corresponding to the price item or hierarchy entity in the Price Item Group Selection screen. The check box is non-editable. If the C1_SEL_T characteristic of a parent entity in the price item hierarchy is set to Mandatory , the system checks the C1_SEL_T characteristic of each child entity in the respective hierarchy and behaves based on the value defined for the C1_SEL_T characteristic type on the respective child entity.
Optional	If the characteristic value is set to Optional , the system, by default, does not select the check box corresponding to the price item or hierarchy entity in the Price Item Group Selection screen. The check box is editable. If the C1_SEL_T characteristic of a parent entity in the price item hierarchy is set to Optional , the system does not check the C1_SEL_T characteristic of each child entity in the respective hierarchy and considers all the child and grandchild entities as optional.

The following table illustrates how the price items and hierarchy entities would be selected based on their characteristic value:

Level 1	Level 2	Level 3	Characteristic Value	Check Box Selected (Y or N)	Check Box Disabled (Y or N)
PG1	-	-	Standard	Y	N
	PG2	-	Mandatory	Y	Y
		PI1	Mandatory	Y	Y
		PI2	Optional	N	N
	PI3	-	Standard	Y	N
	PI4	-	Optional	N	N
	PG3	-	Optional	N	N

Level 1	Level 2	Level 3	Characteristic Value	Check Box Selected (Y or N)	Check Box Disabled (Y or N)
		PI5	Mandatory	Y	Y
		PI6	Standard	Y	N

If a user deselects a price item or hierarchy entity, the system deselects all the child entities including the mandatory entity (if any) in the respective hierarchy. However, if a user selects a price item (for example, PI1 in the above example which was deselected earlier), the system does the following:

- Checks the **C1_SEL_T** characteristic of other siblings (i.e. PI2) in the hierarchy and behaves based on the value defined for the **C1_SEL_T** characteristic type on the respective sibling entity.
- Selects the check box corresponding to the immediate parent and its grandparent hierarchy entities (i.e. PG2 and PG1) in the price item hierarchy.
- Checks the **C1_SEL_T** characteristic of the child entities in the parent and grandparent hierarchies (i.e. PI3, PI4, PG3) and behaves based on the value defined for the **C1_SEL_T** characteristic type on the respective child entity.

However, if a user selects a hierarchy entity (i.e. PG2), the system does the following:

- Checks the **C1_SEL_T** characteristic of the child entities (i.e. PI1 and PI2) in the respective hierarchy and behaves based on the value defined for the **C1_SEL_T** characteristic type on the respective child entity.
- Selects the check box corresponding to the immediate parent and its grandparent hierarchy entities (i.e. PG1) in the price item hierarchy.
- Checks the **C1_SEL_T** characteristic of the child entities in the parent and grandparent hierarchies (i.e. PI3, PI4, PG3) and behaves based on the value defined for the **C1_SEL_T** characteristic type on the respective child entity.

You can opt to validate the selection (if required) by designing a custom logic and then attaching the algorithm to the **Price Item Selection Validation** system event of the respective deal type. On clicking the **Save & View Pricing & Commitment** button, the system will invoke the algorithm attached to the **Price Item Selection Validation** system event and accordingly validate the price item and hierarchy entity selection of an entity in the deal.

Earlier, while using the search filter in the **Price Item Group Selection** screen, the system used to extract only those price items and hierarchy entities which met the search criteria. Now, the system highlights the price item hierarchies in the entire set with either the green or grey color. Two shades of grey are used – one highlights the entire price item hierarchy where none of price items or hierarchy entities meet the search criteria, and another highlights the price item hierarchy where one or more price items or hierarchy entities but not all meets the search criteria. The system highlights the price item hierarchy with the green color when all its price items or hierarchy entities meet the search criteria. Two new icons named **Up** and **Down** are available in the **Search Criteria** section which enable you to quickly jump from one search result to another (highlighted in the green color).

Now, on clicking the **Select All** button in the **Price Item Group Selection** screen, the system selects all the hierarchy entities and price items irrespective of the **C1_SEL_T** characteristic value. However, on clicking the **Deselect All** button in the **Price Item Group Selection** screen, the system deselects all the hierarchy entities and price items except the ones where the **C1_SEL_T** characteristic value is set to **Mandatory**.

Seasonal Pricing for Price Items in a Deal

Oracle Revenue Management and Billing enables the relationship manager to create a seasonal pricing for a price item. This feature enables the relationship manager to offer different rates for a price item for different periods. You can create a seasonal pricing for a price item by overriding the proposed pricing of the price item which is effective from the deal start date. While creating a seasonal pricing, you need to ensure the following:

- Start and end dates are specified in the seasonal pricing
- Start date is later than the deal start date

- End date is not later than the date which is calculated using the start date and number of months specified in the **Validity Period for Deal in Months** option type of the **C1-Deal** feature configuration
- Price assignment type of the seasonal pricing should be same as the proposed pricing which is overridden

If the proposed pricing which you are overriding to create the seasonal pricing is open-ended (i.e. the end date is not specified in the proposed pricing), the system automatically ends the proposed pricing of the price item. The end date of the proposed pricing is set to Seasonal Pricing Start Date - 1.

You can define more than one seasonal pricing for a price item which is effective during a different date range. However, note that you cannot define more than 10 seasonal pricing for a customer or an account. Along with the proposed pricing, the system sends the seasonal pricing of a price item for product, division, and deal level approval. An approver can only approve the seasonal pricing, but cannot recommend a change in the seasonal pricing. An approver can approve the seasonal pricing when the average price falls within the floor and ceil limits of the approver. The relationship manager or approver can send the seasonal pricing of a price item to the price item manager for approval. In such case, the price item manager can view both proposed and seasonal pricing for the price item. But, the price item manager can only approve the seasonal pricing of the price item.

You cannot specify the commitments for the seasonal pricing in the deal. By default, the system considers the commitments of the proposed pricing while calculating the revenue from the seasonal pricing. Also, the system does not consider the seasonal pricing of a price item while calculating the product, division, and deal level financial summary. The system only considers the proposed pricing of a price item while calculating the product, division, and deal level financial summary. You can view the revenue generated for a price item from the seasonal pricing in the **Pricing and Commitments** screen.

If the seasonal pricing is created for a price item with the assignment level other than **Customer Agreed** or **Account Agreed**, the system will automatically consider the proposed pricing of the price item after the seasonal pricing's effective end date. However, if the seasonal pricing is created for a price item with the assignment level as **Customer Agreed** or **Account Agreed**, the relationship manager will have to create a new seasonal pricing for the price item for the remaining deal period.

The following table illustrates different seasonal pricing scenarios at different assignment levels:

Scenario	Assignment Level	Proposed Pricing		Seasonal Pricing	
		Start Date	End Date	Start Date	End Date
Scenario 1	Customer Price List or Account Price List	01-01-2021	31-12-2021	01-03-2021	30-06-2021
Scenario 2	Customer Agreed or Account Agreed	01-01-2021	31-12-2021	01-02-2021	31-05-2021

In scenario 1, the system considers the proposed pricing of the price item after the seasonal pricing of the price item is expired. However, in scenario 2, the relationship manager will have to create a new seasonal pricing for the price item which is effective from 01-06-2021 to 31-12-2021.

Include Customer Hierarchy in a Deal

Earlier, while creating a deal for an existing customer, the system, by default, considered all child and grandchild persons and their accounts in the customer hierarchy. Now, the system facilitates you to indicate whether you want to consider all child and grandchild persons and their accounts in the customer hierarchy while creating a deal.

A new option named **Include Hierarchy** is introduced in this release. It appears when the entity type is set to **Customer** and simulation type is set to **Customer** while creating a deal. If you select the **Include Hierarchy** option while creating a deal, the system considers all child and grandchild persons and their accounts in the customer hierarchy. Note that if you

select a reference customer while creating a deal for an existing customer, the system considers all child and grandchild persons and their accounts in the referenced customer's hierarchy irrespective of whether the **Include Hierarchy** option is selected or not.

Contracted Deal

At present, the relationship manager of a deal can offer a customer or account agreed pricing for a price item or can inherit the pricing for a price item from a price list. If you inherit the pricing for a price item from a price list in a deal and if you change the price item pricing in the price list after orchestrating the deal, the price list is updated in the system. As a result, the pricing offered for a price item to an entity in the deal is overridden. Oracle Revenue Management and Billing enables you to handle this issue by creating a contracted deal.

A new option named **Contracted Deal** is introduced in this release. If you select the **Contracted Deal** option while creating a deal for an existing customer, account, or prospect, any change in the price item pricing of the price list (after orchestration) will not affect the price item pricing offered in the deal.

The **Contracted Deal** option works in conjunction with a new option named **Variable Price** which is available while defining a price item. If the **Variable Price** option is selected for a price item, the system will inherit the pricing for the price item from the price list. In such case, the pricing offered for a price item to an entity in the deal is overridden when the price list pricing is changed after orchestrating the deal in the system.

However, if the **Variable Price** option is not selected for a price item, the system will create a customer or account agreed pricing for the price item, whose pricing is inherited from the price list, whenever the relationship manager orchestrates the deal. In such case, the pricing offered for a price item to an entity in the deal is not overridden when the price list pricing is changed in the system. This enables the relationship manager to create deals for an existing customers, accounts, and prospects where the pricing of the price items are fixed for a particular timeframe. Note that the system creates a customer or account agreed pricing for the price item whose pricing is inherited from the price list only when the commitments are specified for the price item in the deal. If the commitments are not specified for the price item in the deal, the system does not create customer or account agreed pricing for the price item, whose pricing is inherited from the price list. In such case, the system ignores the price items without commitments. It neither creates an error message nor creates a To Do to indicate the error that occurred while creating the price assignments during orchestration.

While accepting a contracted deal, you need to specify the customer acceptance end date. The system then uses the customer acceptance end date as the effective end date while creating the customer or account agreed price assignments during orchestration.

Note: You cannot define seasonal pricing for a price item in a contracted deal.

Deal Inactivation

Oracle Revenue Management and Billing enables the relationship manager to create multiple deals and deal versions until he reaches the best-optimized deal for a customer. Most of the deals which are created to check multiple permutation combinations to reach the best deal are later not updated in the system. Oracle Revenue Management and Billing provides the ability to automatically inactivate such deals which are not active in the system for a long time. The system stamps the last updated date on a deal when an action is performed on the deal or when there is a change in the deal status.

To automatically inactivate the deals which are not updated in the system for a long time, you need to:

- Attach an algorithm which is created using the **C1-INACDEAL** algorithm type to the **Deal Inactivation** system event in the required deal types.
- Set the following fields in the required deal types:
 - **Days to Inactivate Deal** – Used to indicate the number of days after which the deal should be inactivated when it is not active in the system. Here, you must specify a numeric value greater than zero. The numeric value should be greater than the values specified in the **To Do Reminder Days** and **To Do High Priority Days** fields. This field is required when the deal inactivation algorithm is attached to the deal type.

- **To Do Reminder Days** - Used to indicate the number of days using which the system calculates the first To Do reminder date.
- **To Do High Priority Days** - Used to indicate the number of days using which the system calculates the date when the To Do reminder of highest priority should be sent.

The deal inactivation algorithm (i.e. **C1-INACDEAL**) does the following:

- Calculates the following dates for the deal:
 - **Deal Inactivation Date** = Last Updated Date + Days to Inactivate Deal
 - **First To Do Reminder Date** = Deal Inactivation Date – To Do Remainder Days
 - **Second To Do Remainder Date** = Deal Inactivation Date – To Do High Priority Days
- Creates two reminder notifications (i.e. To Dos) for the relationship manager which indicates that the system will inactivate the deal on a particular date if no actions are performed on it before the deal inactivation date. The reminder notifications are sent when the First To Do Reminder Date or Second To Do Remainder Date is equal to the system date.
- Changes the status of the deal to **Inactive** when the deal inactivation date is equal to the system date.

This algorithm is triggered when the **Deal Monitoring (C1_DLMTR)** batch is executed. The **Deal Monitoring (C1_DLMTR)** batch considers all deals which are in the following status:

- Draft
- Error
- Hierarchy Creation Deferred
- Pending For Approval
- Pending Simulation
- Ready For Approval
- Simulated
- Simulation Deferred

For more information about the batch, refer to *Oracle Revenue Management and Billing Batch Guide*. Once a deal is inactivated, you can only view the profitability details of its deal version and extract the deal version information in the PDF and Excel formats. If the inactivated deal has simulation date, then its deal version is available for deal comparison. All other functionalities, such as viewing approval workflow, finalizing deal, accepting deal, rejecting deal, deal orchestration, reviewing deal, etc. are not available for an inactivated deal. Also, you cannot refer an inactivated deal or use an inactivated deal as a template deal.

Average Price Validation Using Floor and Ceil Limits

Until now, the system ensured that the relationship manager, division level or deal level approver, and price item manager could approve the average price of a price item in a deal when it is within the absolute floor and ceil limits of the respective To Do role. Now, in addition, the system provides the following features:

- Validate Average Price Using Spread Amount or Spread Percentage
- Validate Average Price Against Eligible Price List Pricing

On simulating the deal, the system checks whether the **Price Item Approval Required** field is set to **Yes** in the respective deal type. If the **Price Item Approval Required** field is set to **Yes**, the system derives the eligible price lists for the customer using the division, customer segment, and customer tier attributes. If one or more eligible price lists exist for the customer, the system checks whether a price assignment for the price item exists in any of the eligible price list. If the price assignment exists for the price item in an eligible price list, the system checks whether the **Average Price Floor**

and **Ceil Limits** field in the price assignment is set to **Absolute Value Range**, **Spread Amount**, or **Spread Percentage**. The system does the following depending on the value specified in the **Average Price Floor and Ceil Limits** field:

- **Absolute Value Range** – If the **Average Price Floor and Ceil Limits** field in the price assignment is set to **Absolute Value Range**, the system checks whether the average price of the price item in the deal is within the floor and ceil limits of the relationship manager’s To Do role. If the pricing currency is different from the floor and ceil currency, the system does the currency conversion. If the average price of the price item in the deal is within the absolute floor and ceil limits, the system changes the status of the price item to **Approved**. However, if the average price of the price item in the deal is not within the absolute floor and ceil limits, the status of the price item remains as **Pending for Approval**.
- **Spread Amount** - If the **Average Price Floor and Ceil Limits** field in the price assignment is set to **Spread Amount**, the system calculates the average price of the price assignment. If a flat pricing is defined in the price assignment, the system sets the average price to the flat rate. However, if a tiered pricing is defined in the price assignment, the system calculates the average price using the following formula:

$$\text{Average Price} = \text{Price Item Revenue} / \text{Price Item Commitments}$$

The system then considers the spread amount specified for the relationship manager’s To Do role in the price assignment. Using the spread amount and average price, the system calculates the average price floor and ceil values. The system then checks whether the average price of the price item in the deal is within the derived average price floor and ceil limits. If so, the system changes the status of the price item to **Approved**. However, if the average price of the price item in the deal is not within the derived average price floor and ceil limits, the status of the price item remains as **Pending for Approval**.

- **Spread Percentage** - If the **Average Price Floor and Ceil Limits** field in the price assignment is set to **Spread Percentage**, the system calculates the average price of the price assignment. If a flat pricing is defined in the price assignment, the system sets the average price to the flat rate. However, if a tiered pricing is defined in the price assignment, the system calculates the average price using the following formula:

$$\text{Average Price} = \text{Price Item Revenue} / \text{Price Item Commitments}$$

The system then considers the spread parentage specified for the relationship manager’s To Do role in the price assignment. Using the spread percentage and average price, the system calculates the average price floor and ceil values. The system then checks whether the average price of the price item in the deal is within the derived average price floor and ceil limits. If so, the system changes the status of the price item to **Approved**. However, if the average price of the price item in the deal is not within the derived average price floor and ceil limits, the status of the price item remains as **Pending for Approval**.

If the absolute floor and ceil limits, spread amount, or spread percentage is not defined for the To Do role in the price assignment, the system checks whether the **Average Price Floor and Ceil Limits** field in the price item is set to **Absolute Value Range**, **Spread Amount**, or **Spread Percentage**. The system does the following depending on the value specified in the **Average Price Floor and Ceil Limits** field:

- **Absolute Value Range** - If the **Average Price Floor and Ceil Limits** field in the price item is set to **Absolute Value Range**, the system checks whether the average price of the price item in the deal is within the floor and ceil limits of the relationship manager’s To Do role. If the pricing currency is different from the floor and ceil currency, the system does the currency conversion. If the average price of the price item in the deal is within the absolute floor and ceil limits, the system changes the status of the price item to **Approved**. However, if the average price of the price item in the deal is not within the absolute floor and ceil limits, the status of the price item remains as **Pending for Approval**.
- **Spread Amount** - If the **Average Price Floor and Ceil Limits** field in the price item is set to **Spread Amount**, the system calculates the average price of the price assignment. If a flat pricing is defined in the price assignment, the system sets the average price to the flat rate. However, if a tiered pricing is defined in the price assignment, the system calculates the average price using the following formula:

$$\text{Average Price} = \text{Price Item Revenue} / \text{Price Item Commitments}$$

The system then considers the spread amount specified for the relationship manager’s To Do role in the price item. Using the spread amount and average price, the system calculates the average price floor and ceil values. The system then checks whether the average price of the price item in the deal is within the derived average price

floor and ceil limits. If so, the system changes the status of the price item to **Approved**. However, if the average price of the price item in the deal is not within the derived average price floor and ceil limits, the status of the price item remains as **Pending for Approval**.

- **Spread Percentage** - If the **Average Price Floor and Ceil Limits** field in the price item is set to **Spread Percentage**, the system calculates the average price of the price assignment. If a flat pricing is defined in the price assignment, the system sets the average price to the flat rate. However, if a tiered pricing is defined in the price assignment, the system calculates the average price using the following formula:

$$\text{Average Price} = \text{Price Item Revenue} / \text{Price Item Commitments}$$

The system then considers the spread parentage specified for the relationship manager's To Do role in the price item. Using the spread percentage and average price, the system calculates the average price floor and ceil values. The system then checks whether the average price of the price item in the deal is within the derived average price floor and ceil limits. If so, the system changes the status of the price item to **Approved**. However, if the average price of the price item in the deal is not within the derived average price floor and ceil limits, the status of the price item remains as **Pending for Approval**.

However, if the absolute floor and ceil limits, spread amount, or spread percentage is not defined for the To Do role in the price item, the system changes the status of the price item to **Error**. If the system could not derive a price assignment for the price item from any of the eligible price list, the system checks whether the **Average Price Floor and Ceil Limits** field in the price item is set to **Absolute Value Range**, **Spread Amount**, or **Spread Percentage**. If the **Average Price Floor and Ceil Limits** field in the price item is set to **Absolute Value Range**, the system validates the average price of the price item in the deal using the absolute floor and ceil values of the respective To Do role. But, if the **Average Price Floor and Ceil Limits** field in the price item is set to **Spread Amount** or **Spread Percentage**, the system changes the status of the price item to **Error**.

Similarly, the system validates the average price of a price item when the product level approver, division level approver, deal level approver, or price item manager approves the price item in a deal.

Considering Pass Through Charges While Calculating Original Revenue

The system considers the recurring and non-recurring pass through charges of an account while calculating the original revenue of the account and customer in a deal. It also considers the recurring and non-recurring pass through charges which are generated through the **Transaction Aggregation** process (in the **Transaction Feed Management (TFM)** module). The system does the following while deriving the recurring and non-recurring pass through charges of an account:

1. Derives the usage period (i.e. usage start date and usage end date) using the price selection date specified in the deal
2. Considers those billable charges with the pass through amount where the usage start or end date falls within the billable charge start and end dates
3. Calculates the pass through charges for the usage period in the deal frequency
4. Converts the pass through charges in the account's invoice currency and deal currency when the pass through charges are in the different currency

You can view the pass through charges of a price item which are billed to the account in the **Pass Through Charge Information** section of the **Pricing and Commitments** screen. The system enables you to derive the pass through charges of an account in either of the following mode:

- **Online Mode** - If you set the **Refer Volume Aggregation** option type of the **C1-DEAL** feature configuration to **N**, the system derives the recurring and non-recurring pass through charges of an account in the online mode. The online mode means that the pass through charges of an account are derived for the usage period in the deal frequency at the runtime when you view the pricing and commitment details of the account.
- **Deferred Mode** - If you set the **Refer Volume Aggregation** option type of the **C1-DEAL** feature configuration to **Y**, the system derives the recurring and non-recurring pass through charges of an account in the deferred mode (i.e. in the background). The deferred mode means when you execute the following batches:
 - **Aggregate Account's Volume and Count (PREAGGR)** - The **Aggregate Account's Volume and Count (PREAGGR)** batch derives the recurring and non-recurring pass through charges of an account for all

deal frequencies (i.e. Monthly, Quarterly, Half Annually, and Annually) and stores the information in the **C1_CHARGE_AGGR** table. If you want to derive the pass through charges of an account in the deferred mode, you need to execute the **Aggregate Account's Volume and Count (PREAGGR)** batch before creating a deal for an existing account. For more information about the batch, refer to *Oracle Revenue Management and Billing Batch Guide*.

- **Aggregate Customer's Volume and Count (CSTPREAG)** - The **Aggregate Customer's Volume and Count (CSTPREAG)** batch aggregates the pass through charges of all accounts of a customer for all deal frequencies (i.e. Monthly, Quarterly, Half Annually, and Annually) and stores the information in the **C1_CHARGE_AGGR** table. If you want to aggregate the pass through charges of all accounts of a customer in the deferred mode, you need to execute the **Aggregate Customer's Volume and Count (CSTPREAG)** batch after executing the **Aggregate Account's Volume and Count (PREAGGR)** batch. For more information about these batches, refer to *Oracle Revenue Management and Billing Batch Guide*.

The system then extracts the pass through charges of an account from the **C1_CHARGE_AGGR** table while creating a deal. We recommend you to use this mode to experience a better system performance.

Recurring Pass Through Charge Calculation

Let us understand how the recurring pass through charges are calculated for a usage period in a deal frequency.

Example 1:

A deal is created for an account named A1 where the deal start date is set to 01-Jul-2020, deal end date is set to 31-Aug-2020, deal currency is set to USD, price selection date is set to 01-Aug-2020, usage period is set to Monthly, and deal frequency is set to Quarterly. Let us assume that the following recurring pass through charges exists for the A1 account where the invoice currency is set to INR:

Billable Charge Start Date	Billable Charge End Date	Recurring Method	Bill Period	Line 1	Line 1 Amount	Line 2	Line 2 Amount	Total Pass Through Charges	Price Item
1-Jul-20	31-Aug-20	Bill Period	Monthly	10	100 INR	20	200 INR	100 + 200 = 300 INR	PI1
15-Jul-20	20-Aug-20	Bill Period	Monthly	10	150 INR	20	350 INR	150 + 350 = 500 INR	PI2
1-Jan-20	31-Mar-20	Bill Period	Monthly	10	125 INR	20	325 INR	125 + 325 = 450 INR	PI2
1-Apr-20	31-May-20	Bill Period	Monthly	10	100 INR	20	450 INR	100 + 450 = 550 INR	PI1

Now, while calculating the original revenue, the system derives the recurring pass through charges for the usage period in the deal frequency. To derive the recurring pass through charges for the usage period in the deal frequency, the system does the following:

1. Derives the usage period (i.e. usage start date and usage end date) using the price selection date and usage frequency in the following manner:

```
Price Selection Date = 01-Aug-2020
Usage End Date = Price Selection Date = 01-Aug-2020
Usage Start Date = Usage End Date - Usage Frequency = 01-Aug-2020 - 1
Month (i.e. 30 days) = 02-Jul-2020
Usage Period = 02-Jul-2020 to 01-Aug-2020
```

2. Considers those recurring billable charges with the pass through amount where the usage start or end date falls within the billable charge start and end dates. For example, the system considers the following recurring billable charges of the A1 account:

Billable Charge Start Date	Billable Charge End Date	Recurring Method	Bill Period	Line 1	Line 1 Amount	Line 2	Line 2 Amount	Total Pass Through Charges	Price Item
1-Jul-20	31-Aug-20	Bill Period	Monthly	10	100 INR	20	200 INR	100 + 200 = 300 INR	PI1
15-Jul-20	20-Aug-20	Bill Period	Monthly	10	150 INR	20	350 INR	150 + 350 = 500 INR	PI2

3. Derives the final start and end dates for the selected billable charges in the following manner:

```
Final Start Date = Billable Charge Start Date or Usage Period Start Date
whichever is later
Final End Date = Billable Charge End Date or Usage Period End Date
whichever is earlier
```

The following table indicates the final start and end dates for the selected billable charges:

Billable Charge Start Date	Billable Charge End Date	Recurring Method	Bill Period	Total Pass Through Charges	Price Item	Final Start Date After Evaluation	Final End Date After Evaluation
1-Jul-20	31-Aug-20	Bill Period	Monthly	100 + 200 = 300 INR	PI1	2-Jul-20	1-Aug-20
15-Jul-20	20-Aug-20	Bill Period	Monthly	150 + 350 = 500 INR	PI2	15-Jul-20	1-Aug-20

4. Derives the factor using the final start and end dates and recurring method in the following manner:

Let us assume that the **Monthly** bill period contains the following schedules:

Bill Date	Bill Segment End Date
1-Jan-20	31-Jan-20
1-Feb-20	29-Feb-20
1-Mar-20	31-Mar-20
1-Apr-20	30-Apr-20
1-May-20	31-May-20
1-Jun-20	30-Jun-20
1-Jul-20	31-Jul-20
1-Aug-20	31-Aug-20

In such case, the system will derive the factor using the bill period in the following manner:

Billable Charge Start Date	Billable Charge End Date	Recurring Method	Bill Period	Total Pass Through Charges	Price Item	Final Start Date After Evaluation	Final End Date After Evaluation	Factor (Number of Bill Period Schedules between which Final Start and End Dates Fall)
1-Jul-20	31-Aug-20	Bill Period	Monthly	100 + 200 = 300 INR	PI1	2-Jul-20	1-Aug-20	2
15-Jul-20	20-Aug-20	Bill Period	Monthly	150 + 350 = 500 INR	PI2	15-Jul-20	1-Aug-20	2

5. Multiplies the total pass through charges with the factor, and thereby derives the final pass through charges in the following manner:

Total Recurring Pass Through Charges of PI1 = $(300 * 2) = 600$ INR
 Total Recurring Pass Through Charges of PI2 = $(500 * 2) = 1000$ INR

6. Calculates the pass through charges for the usage period in the deal frequency in the following manner:

Recurring Pass Through Charges of PI1 for the Usage Period in the Deal Frequency = $(\text{Total Recurring Pass Through Charges of PI1} * \text{Deal Frequency}) / \text{Usage Period} = (600 * 3 \text{ (i.e. Quarterly)}) / 1 \text{ (i.e. Monthly)} = 1800$ INR
 Recurring Pass Through Charges of PI2 for the Usage Period in the Deal Frequency = $(\text{Total Recurring Pass Through Charges of PI2} * \text{Deal Frequency}) / \text{Usage Period} = (1000 * 3 \text{ (i.e. Quarterly)}) / 1 \text{ (i.e. Monthly)} = 3000$ INR

7. Converts the pass through charges in the deal currency (i.e. USD) using the available exchange rate (for example, 0.013):

Recurring Pass Through Charges of PI1 in USD = $1800 * 0.013 = 23.4$ USD
 Recurring Pass Through Charges of PI2 in USD = $3000 * 0.013 = 39$ USD

In this way, the system calculates and derives the recurring pass through charges for the A1 account in the D1 deal.

Example 2:

A deal is created for an account named A2 where the deal start date is set to 01-Jan-2020, deal end date is set to 28-Feb-2020, deal currency is set to USD, price selection date is set to 20-Jan-2020, usage period is set to Annually, and

deal frequency is set to Quarterly. Let us assume that the following recurring pass through charges exists for the A2 account where the invoice currency is set to EURO:

Billable Charge Start Date	Billable Charge End Date	Recurring Method	Bill Period	Line 1	Line 1 Amount	Line 2	Line 2 Amount	Total Pass Through Charges	Price Item
1-Jan-19	31-Dec-19	Invoice Frequency	Quarterly	10	150 INR	20	350 INR	150 + 350 = 500 INR	PI2
1-Jun-19	31-Mar-20	Invoice Frequency	Quarterly	10	125 INR	20	325 INR	125 + 325 = 450 INR	PI2
1-Jan-20	31-May-20	Invoice Frequency	Quarterly	10	100 INR	20	450 INR	100 + 450 = 550 INR	PI1

Now, while calculating the original revenue, the system derives the recurring pass through charges for the usage period in the deal frequency. To derive the recurring pass through charges for the usage period in the deal frequency, the system does the following:

- Derives the usage period (i.e. usage start date and usage end date) using the price selection date and usage frequency in the following manner:

Price Selection Date = 20-Jan-2020

Usage End Date = Price Selection Date = 20-Jan-2020

Usage Start Date = Usage End Date - Usage Frequency = 20-Jan-2020 - 1 Year (i.e. Annually) = 21-Jan-2019

Usage Period = 21-Jan-2019 to 20-Jan-2020

- Considers those recurring billable charges with the pass through amount where the usage start or end date falls within the billable charge start and end dates. For example, the system considers the following recurring billable charges of the A2 account:

Billable Charge Start Date	Billable Charge End Date	Recurring Method	Bill Period	Line 1	Line 1 Amount	Line 2	Line 2 Amount	Total Pass Through Charges	Price Item
1-Jan-19	31-Dec-19	Invoice Frequency	Quarterly	10	150 INR	20	350 INR	150 + 350 = 500 INR	PI2
1-Jun-19	31-Mar-20	Invoice Frequency	Quarterly	10	125 INR	20	325 INR	125 + 325 = 450 INR	PI2
1-Jan-20	31-May-20	Invoice Frequency	Quarterly	10	100 INR	20	450 INR	100 + 450 = 550 INR	PI1

- Derives the final start and end dates for the selected billable charges in the following manner:

Final Start Date = Billable Charge Start Date or Usage Period Start Date whichever is later

Final End Date = Billable Charge End Date or Usage Period End Date whichever is earlier

The following table indicates the final start and end dates for the selected billable charges:

Billable Charge Start Date	Billable Charge End Date	Recurring Method	Bill Period	Total Pass Through Charges	Price Item	Final Start Date After Evaluation	Final End Date After Evaluation
1-Jan-19	31-Dec-19	Invoice Frequency	Quarterly	150 + 350 = 500 INR	PI2	21-Jan-19	31-Dec-19
1-Jun-19	31-Mar-20	Invoice Frequency	Quarterly	125 + 325 = 450 INR	PI2	1-Jun-19	20-Jan-20
1-Jan-20	31-May-20	Invoice Frequency	Quarterly	100 + 450 = 550 INR	PI1	1-Jan-20	20-Jan-20

- Derives the factor using the final start and end dates and recurring method in the following manner:

Let us assume that the **Quarterly** invoice frequency contains the following periodic intervals:

Start Date	End Date
1-Jan-19	31-Mar-19
1-Apr-19	30-Jun-19
1-Jul-19	30-Sep-19
1-Oct-19	31-Dec-19
1-Jan-20	31-Mar-20
1-Apr-20	30-Jun-20
1-Jul-20	30-Sep-20
1-Oct-20	31-Dec-20

In such case, the system will derive the factor using the invoice frequency in the following manner:

Billable Charge Start Date	Billable Charge End Date	Recurring Method	Bill Period	Total Pass Through Charges	Price Item	Final Start Date After Evaluation	Final End Date After Evaluation	Factor (Number of Periodic Intervals between which Final Start and End Dates Fall)
1-Jan-19	31-Dec-19	Invoice Frequency	Quarterly	150 + 350 = 500 INR	PI2	21-Jan-19	31-Dec-19	4
1-Jun-19	31-Mar-20	Invoice Frequency	Quarterly	125 + 325 = 450 INR	PI2	1-Jun-19	20-Jan-20	4
1-Jan-20	31-May-20	Invoice Frequency	Quarterly	100 + 450 = 550 INR	PI1	1-Jan-20	20-Jan-20	1

5. Multiplies the total pass through charges with the factor, and thereby derives the final pass through charges in the following manner:

Total Recurring Pass Through Charges of PI1 = $(550 * 1) = 550$ INR
 Total Recurring Pass Through Charges of PI2 = $(500 * 4) + (450 * 4) = 2000 + 1800 = 3800$ INR

6. Calculates the pass through charges for the usage period in the deal frequency in the following manner:

Recurring Pass Through Charges of PI1 for the Usage Period in the Deal Frequency = $(\text{Total Recurring Pass Through Charges of PI1} * \text{Deal Frequency}) / \text{Usage Period} = (550 * 3 \text{ (i.e. Quarterly)}) / 12 \text{ (i.e. Annually)} = (1650 / 12) = 137.5$ INR
 Recurring Pass Through Charges of PI2 for the Usage Period in the Deal Frequency = $(\text{Total Recurring Pass Through Charges of PI2} * \text{Deal Frequency}) / \text{Usage Period} = (3800 * 3 \text{ (i.e. Quarterly)}) / 12 \text{ (i.e. Annually)} = (11400 / 12) = 950$ INR

7. Converts the pass through charges in the account's invoice currency (i.e. EURO) and deal currency (i.e. USD) using the available exchange rates:

For example, to convert the pass through charges in the account's invoice currency, the exchange rate from INR to USD is 0.013:

Recurring Pass Through Charges of PI1 in USD = $137.5 * 0.013 = 1.79$ USD
 Recurring Pass Through Charges of PI2 in USD = $950 * 0.013 = 12.35$ USD

For example, to convert the pass through charges in the deal currency, the exchange rate from INR to EURO is 0.012:

Recurring Pass Through Charges of PI1 in EURO = $137.5 * 0.012 = 1.65$ EURO
 Recurring Pass Through Charges of PI2 in EURO = $950 * 0.012 = 11.4$ EURO

In this way, the system calculates and derives the recurring pass through charges for the A2 account in the D1 deal.

Non-Recurring Pass Through Charge Calculation

Let us understand how the non-recurring pass through charges are calculated for a usage period in a deal frequency.

Example 3:

A deal is created for an account named A1 where the deal start date is set to 01-Jul-2020, deal end date is set to 31-Aug-2020, deal currency is set to USD, price selection date is set to 01-Aug-2020, usage period is set to Monthly, and deal frequency is set to Quarterly. Let us assume that the following non-recurring pass through charges exists for the A1 account where the invoice currency is set to INR:

Billable Charge Start Date	Billable Charge End Date	Line 1	Line 1 Amount	Line 2	Line 2 Amount	Total Pass Through Charges	Price Item
1-Jul-20	31-Aug-20	10	100 INR	20	200 INR	100 + 200 = 300 INR	PI1
15-Jul-20	20-Aug-20	10	150 INR	20	350 INR	150 + 350 = 500 INR	PI2
1-Jan-20	31-Mar-20	10	125 INR	20	325 INR	125 + 325 = 450 INR	PI2
1-Apr-20	31-May-20	10	100 INR	20	450 INR	100 + 450 = 550 INR	PI1

Now, while calculating the original revenue, the system derives the non-recurring pass through charges for the usage period in the deal frequency. To derive the non-recurring pass through charges for the usage period in the deal frequency, the system does the following:

1. Derives the usage period (i.e. usage start date and usage end date) using the price selection date and usage frequency in the following manner:

```
Price Selection Date = 01-Aug-2020
Usage End Date = Price Selection Date = 01-Aug-2020
Usage Start Date = Usage End Date - Usage Frequency = 01-Aug-2020 - 1
Month (i.e. 30 days) = 02-Jul-2020
Usage Period = 02-Jul-2020 to 01-Aug-2020
```

2. Considers those non-recurring billable charges with the pass through amount where the usage start or end date falls within the billable charge start and end dates. For example, the system considers the following non-recurring billable charges of the A1 account:

Billable Charge Start Date	Billable Charge End Date	Line 1	Line 1 Amount	Line 2	Line 2 Amount	Total Pass Through Charges	Price Item
1-Jul-20	31-Aug-20	10	100 INR	20	200 INR	100 + 200 = 300 INR	PI1
15-Jul-20	20-Aug-20	10	150 INR	20	350 INR	150 + 350 = 500 INR	PI2

3. Derives the former start date and latter end date of the billable charges in the following manner:

```
Former Start Date = Compare the Start Dates of All Billable Charges and
Reterive the Earliest Start Date
Latter End Date = Compare the End Dates of All Billable Charges and
Reterive the Latest End Date
```

In this case, the former start date is 01-Jul-2020 and latter end date is 31-Aug-2020.

4. Derives the number of months between the former start date and latter end date. In this case, the number of months between 01-Jul-2020 and 31-Aug-2020 is 2.
5. Derives the monthly non-recurring pass through charges in the following manner:

```
Monthly Non-Recurring Pass Through Charges of PI1 = Total Non-Recurring
Pass Through Charges of PI1/Number of Months between Former Start and
Latter End Dates = 300/2 = 150 INR
Monthly Non-Recurring Pass Through Charges of PI2 = Total Non-Recurring
Pass Through Charges of PI2/Number of Months between Former Start and
Latter End Dates = 500/2 = 250 INR
```

6. Calculates the non-recurring pass through charges for the usage period in the deal frequency in the following manner:

```
Non-Recurring Pass Through Charges of PI1 for the Usage Period in the
Deal Frequency = (Monthly Non-Recurring Pass Through Charges * Deal
Frequency)/Usage Frequency = (150 * 3 (i.e. Quarterly))/1(i.e. Monthly) =
(450/1) = 450 INR
Non-Recurring Pass Through Charges of PI2 for the Usage Period in the
Deal Frequency = (Monthly Non-Recurring Pass Through Charges * Deal
Frequency)/Usage Frequency = (250 * 3 (i.e. Quarterly))/1(i.e. Monthly) =
(750/1) = 750 INR
```

7. Converts the pass through charges in the deal currency (i.e. USD) using the available exchange rate (for example, 0.013):

```
Non-Recurring Pass Through Charges of PI1 in USD = 450*0.013 = 5.85 USD
Non-Recurring Pass Through Charges of PI2 in USD = 750*0.013 = 9.75 USD
```

In this way, the system calculates and derives the non-recurring pass through charges for the A1 account in the D1 deal.

Considering SQI Based Billable Charges While Calculating Commitments

The system considers the recurring and non-recurring SQI based billable charges of an account while calculating the original and proposed commitments of the account and customer in a deal. It also considers the recurring and non-recurring SQI based billable charges which are generated through the **Transaction Aggregation** process (in the **Transaction Feed Management (TFM)** module). The system does the following while deriving the service quantities from the recurring and non-recurring billable charges of an account:

1. Derives the usage period (i.e. usage start date and usage end date) using the price selection date specified in the deal
2. Considers those SQI based billable charges where the usage start or end date falls within the billable charge start and end dates
3. Calculates the service quantities for the usage period in the deal frequency

The system enables you to derive the service quantities from the recurring and non-recurring billable charges of an account in either of the following mode:

- **Online Mode** - If you set the **Refer Volume Aggregation** option type of the **C1-DEAL** feature configuration to **N**, the system derives the service quantities from the recurring and non-recurring billable charges of an account in the online mode. The online mode means that the service quantities from the recurring and non-recurring billable charges of an account are derived for the usage period in the deal frequency at the runtime when you view the pricing and commitment details of the account.
- **Deferred Mode** - If you set the **Refer Volume Aggregation** option type of the **C1-DEAL** feature configuration to **Y**, the system derives the service quantities from the recurring and non-recurring billable charges of an account in the deferred mode (i.e. in the background). The deferred mode means when you execute the following batches:
 - **Aggregate Account's Volume and Count (PREAGGR)** - The **Aggregate Account's Volume and Count (PREAGGR)** batch derives the service quantities from the recurring and non-recurring billable charges of an account for all deal frequencies (i.e. Monthly, Quarterly, Half Annually, and Annually) and stores the information in the **C1_VOLUME_AGGR** table. If you want to derive the service quantities from the recurring and non-recurring billable charges of an account in the deferred mode, you need to execute the **Aggregate Account's Volume and Count (PREAGGR)** batch before creating a deal for an existing account. For more information about the batch, refer to *Oracle Revenue Management and Billing Batch Guide*.
 - **Aggregate Customer's Volume and Count (CSTPREAG)** - The **Aggregate Customer's Volume and Count (CSTPREAG)** batch aggregates the billed service quantities of all accounts of a customer for all deal frequencies (i.e. Monthly, Quarterly, Half Annually, and Annually) and stores the information in the **C1_VOLUME_AGGR** table. If you want to aggregate the billed service quantities of all accounts of a customer in the deferred mode, you need to execute the **Aggregate Customer's Volume and Count (CSTPREAG)** batch after executing the **Aggregate Account's Volume and Count (PREAGGR)** batch. For more information about these batches, refer to *Oracle Revenue Management and Billing Batch Guide*.

The system then extracts the billed service quantities of an account from the **C1_VOLUME_AGGR** table while creating a deal. We recommend you to use this mode to experience a better system performance.

Considering Recurring SQI Based Billable Charges for Commitment Calculation

Let us understand how the original and proposed commitments are calculated from the recurring SQI based billable charges for a usage period in a deal frequency.

Example 1:

A deal is created for an account named A1 where the deal start date is set to 01-Jul-2020, deal end date is set to 31-Aug-2020, deal currency is set to USD, price selection date is set to 01-Aug-2020, usage period is set to Monthly, and deal frequency is set to Quarterly. Let us assume that the following recurring SQI based billable charges exists for the A1 account where the invoice currency is set to INR:

Billable Charge Start Date	Billable Charge End Date	Recurring Method	Bill Period	SQI	Service Quantity	Price Item
1-Jul-20	31-Aug-20	Bill Period	Monthly	Number of Transactions	1000	PI1
				Transaction Volume	25000	
15-Jul-20	20-Aug-20	Bill Period	Monthly	Number of Transactions	1500	PI2
				Transaction Volume	50000	
1-Jan-20	31-Mar-20	Bill Period	Monthly	Number of Transactions	3500	PI2
				Transaction Volume	25000	
1-Apr-20	31-May-20	Bill Period	Monthly	Number of Transactions	4000	PI1
				Transaction Volume	25000	

Now, while calculating the original and proposed commitments, the system derives the service quantities from the recurring billable charges for the usage period in the deal frequency. To derive the service quantities from the recurring billable charges for the usage period in the deal frequency, the system does the following:

1. Derives the usage period (i.e. usage start date and usage end date) using the price selection date and usage frequency in the following manner:

```
Price Selection Date = 01-Aug-2020
Usage End Date = Price Selection Date = 01-Aug-2020
Usage Start Date = Usage End Date - Usage Frequency = 01-Aug-2020 - 1
Month (i.e. 30 days) = 02-Jul-2020
Usage Period = 02-Jul-2020 to 01-Aug-2020
```

2. Considers those recurring SQI based billable charges where the usage start or end date falls within the billable charge start and end dates. For example, the system considers the following recurring billable charges of the A1 account:

Billable Charge Start Date	Billable Charge End Date	Recurring Method	Bill Period	SQI	Service Quantity	Price Item
1-Jul-20	31-Aug-20	Bill Period	Monthly	Number of Transactions	1000	PI1
				Transaction Volume	25000	
15-Jul-20	20-Aug-20	Bill Period	Monthly	Number of Transactions	1500	PI2
				Transaction Volume	50000	

3. Derives the final start and end dates for the selected billable charges in the following manner:

```
Final Start Date = Billable Charge Start Date or Usage Period Start Date
whichever is later
Final End Date = Billable Charge End Date or Usage Period End Date
whichever is earlier
```

The following table indicates the final start and end dates for the selected billable charges:

Billable Charge Start Date	Billable Charge End Date	Recurring Method	Bill Period	SQI	Service Quantity	Price Item	Final Start Date After Evaluation	Final End Date After Evaluation
1-Jul-20	31-Aug-20	Bill Period	Monthly	Number of Transactions	1000	PI1	2-Jul-20	1-Aug-20
				Transaction Volume	25000			
15-Jul-20	20-Aug-20	Bill Period	Monthly	Number of Transactions	1500	PI2	15-Jul-20	1-Aug-20
				Transaction Volume	50000			

4. Derives the factor using the final start and end dates and recurring method in the following manner:

Let us assume that the **Monthly** bill period contains the following schedules:

Bill Date	Bill Segment End Date
1-Jan-20	31-Jan-20
1-Feb-20	29-Feb-20
1-Mar-20	31-Mar-20
1-Apr-20	30-Apr-20
1-May-20	31-May-20
1-Jun-20	30-Jun-20
1-Jul-20	31-Jul-20
1-Aug-20	31-Aug-20

In such case, the system will derive the factor using the bill period in the following manner:

Billable Charge Start Date	Billable Charge End Date	Recurring Method	Bill Period	SQI	Service Quantity	Price Item	Final Start Date After Evaluation	Final End Date After Evaluation	Factor (Number of Bill Period Schedules between which Final Start and End Dates Fall)
1-Jul-20	31-Aug-20	Bill Period	Monthly	Number of Transactions	1000	PI1	2-Jul-20	1-Aug-20	2
				Transaction Volume	25000				
15-Jul-20	20-Aug-20	Bill Period	Monthly	Number of Transactions	1500	PI2	15-Jul-20	1-Aug-20	2
				Transaction Volume	50000				

5. Multiplies the service quantities with the factor in the following manner:

Total Number of Transactions of PI1 = $(1000 * 2) = 2000$
 Total Transaction Volume of PI1 = $(25000 * 2) = 50000$

Total Number of Transactions of PI2 = $(1500 * 2) = 3000$
 Total Transaction Volume of PI2 = $(50000 * 2) = 100000$

6. Calculates the service quantities for the usage period in the deal frequency in the following manner:

Number of Transactions of PI1 for the Usage Period in the Deal Frequency =
 $(\text{Total Number of Transactions of PI1} * \text{Deal Frequency}) / \text{Usage Frequency} =$
 $(2000 * 3 \text{ (i.e. Quarterly)}) / 1 \text{ (i.e. Monthly)} = 6000$

Number of Transactions of PI2 for the Usage Period in the Deal Frequency =
 $(\text{Total Number of Transactions of PI2} * \text{Deal Frequency}) / \text{Usage Frequency} =$
 $(3000 * 3 \text{ (i.e. Quarterly)}) / 1 \text{ (i.e. Monthly)} = 9000$

Transaction Volume of PI1 for the Usage Period in the Deal Frequency =
 $(\text{Total Transaction Volume of PI1} * \text{Deal Frequency}) / \text{Usage Frequency} =$
 $(50000 * 3 \text{ (i.e. Quarterly)}) / 1 \text{ (i.e. Monthly)} = 150000$

Transaction Volume of PI2 for the Usage Period in the Deal Frequency =
 $(\text{Total Transaction Volume of PI2} * \text{Deal Frequency}) / \text{Usage Frequency} =$
 $(100000 * 3 \text{ (i.e. Quarterly)}) / 1 \text{ (i.e. Monthly)} = 300000$

In this way, the system derives the original and proposed commitments for the A1 account in the D1 deal.

Example 2:

A deal is created for an account named A2 where the deal start date is set to 01-Jan-2020, deal end date is set to 28-Feb-2020, deal currency is set to USD, price selection date is set to 20-Jan-2020, usage period is set to Annually, and deal frequency is set to Quarterly. Let us assume that the following recurring SQI based billable charges exists for the A2 account where the invoice currency is set to EURO:

Billable Charge Start Date	Billable Charge End Date	Recurring Method	Bill Period	SQI	Service Quantity	Price Item
1-Jan-19	31-Dec-19	Invoice Frequency	Quarterly	Number of Transactions	500	PI2
				Transaction Volume	2500	
1-Jun-19	31-Mar-20	Invoice Frequency	Quarterly	Number of Transactions	750	PI2
				Transaction Volume	5000	
1-Jan-20	31-May-20	Invoice Frequency	Quarterly	Number of Transactions	1000	PI1
				Transaction Volume	50000	

Now, while calculating the original and proposed commitments, the system derives the service quantities from the recurring billable charges for the usage period in the deal frequency. To derive the service quantities from the recurring billable charges for the usage period in the deal frequency, the system does the following:

- Derives the usage period (i.e. usage start date and usage end date) using the price selection date and usage frequency in the following manner:

Price Selection Date = 20-Jan-2020
 Usage End Date = Price Selection Date = 20-Jan-2020
 Usage Start Date = Usage End Date - Usage Frequency = 20-Jan-2020 - 1 Year
 (i.e. Annually) = 21-Jan-2019
 Usage Period = 21-Jan-2019 to 20-Jan-2020

- Considers those recurring SQI based billable charges where the usage start or end date falls within the billable charge start and end dates. For example, the system considers the following recurring billable charges of the A2 account:

Billable Charge Start Date	Billable Charge End Date	Recurring Method	Bill Period	SQI	Service Quantity	Price Item
1-Jan-19	31-Dec-19	Invoice Frequency	Quarterly	Number of Transactions	500	PI2
				Transaction Volume	2500	
1-Jun-19	31-Mar-20	Invoice Frequency	Quarterly	Number of Transactions	750	PI2
				Transaction Volume	5000	
1-Jan-20	31-May-20	Invoice Frequency	Quarterly	Number of Transactions	1000	PI1
				Transaction Volume	50000	

3. Derives the final start and end dates for the selected billable charges in the following manner:

Final Start Date = Billable Charge Start Date or Usage Period Start Date whichever is later

Final End Date = Billable Charge End Date or Usage Period End Date whichever is earlier

The following table indicates the final start and end dates for the selected billable charges:

Billable Charge Start Date	Billable Charge End Date	Recurring Method	Bill Period	SQI	Service Quantity	Price Item	Final Start Date After Evaluation	Final End Date After Evaluation
1-Jan-19	31-Dec-19	Invoice Frequency	Quarterly	Number of Transactions	500	PI2	21-Jan-19	31-Dec-19
				Transaction Volume	2500			
1-Jun-19	31-Mar-20	Invoice Frequency	Quarterly	Number of Transactions	750	PI2	1-Jun-19	20-Jan-20
				Transaction Volume	5000			
1-Jan-20	31-May-20	Invoice Frequency	Quarterly	Number of Transactions	1000	PI1	1-Jan-20	20-Jan-20
				Transaction Volume	50000			

4. Derives the factor using the final start and end dates and recurring method in the following manner:

Let us assume that the **Quarterly** invoice frequency contains the following periodic intervals:

Start Date	End Date
1-Jan-19	31-Mar-19
1-Apr-19	30-Jun-19
1-Jul-19	30-Sep-19
1-Oct-19	31-Dec-19
1-Jan-20	31-Mar-20
1-Apr-20	30-Jun-20
1-Jul-20	30-Sep-20
1-Oct-20	31-Dec-20

In such case, the system will derive the factor using the invoice frequency in the following manner:

Billable Charge Start Date	Billable Charge End Date	Recurring Method	Bill Period	SQI	Service Quantity	Price Item	Final Start Date After Evaluation	Final End Date After Evaluation	Factor (Number of Periodic Intervals between which Final Start and End Dates Fall)
1-Jan-19	31-Dec-19	Invoice Frequency	Quarterly	Number of Transactions	500	PI2	21-Jan-19	31-Dec-19	4
				Transaction Volume	2500				
1-Jun-19	31-Mar-20	Invoice Frequency	Quarterly	Number of Transactions	750	PI2	1-Jun-19	20-Jan-20	4
				Transaction Volume	5000				
1-Jan-20	31-May-20	Invoice Frequency	Quarterly	Number of Transactions	1000	PI1	1-Jan-20	20-Jan-20	1
				Transaction Volume	50000				

5. Multiplies the service quantities with the factor in the following manner:

Total Number of Transactions of PI1 = (1000*1) = 1000

Total Transaction Volume of PI1 = (50000*1) = 50000

Total Number of Transactions of PI2 = (500*4)+(750*4) = 2000+3000 = 5000

Total Transaction Volume of PI2 = (2500*4)+(5000*4) = 10000+20000 = 30000

6. Calculates the service quantities for the usage period in the deal frequency in the following manner:

Number of Transactions of PI1 for the Usage Period in the Deal Frequency =
 (Total Number of Transactions of PI1 * Deal Frequency)/Usage Frequency =
 (1000 * 3 (i.e. Quarterly))/12(i.e. Annually) = (3000/12) = 250

Number of Transactions of PI2 for the Usage Period in the Deal Frequency =
 (Total Number of Transactions of PI2 * Deal Frequency)/Usage Frequency =
 (5000 * 3 (i.e. Quarterly))/12(i.e. Annually) = (15000/12) = 1250

Transaction Volume of PI1 for the Usage Period in the Deal Frequency =
 (Total Transaction Volume of PI1 * Deal Frequency)/Usage Frequency =
 (50000 * 3 (i.e. Quarterly))/12(i.e. Annually) = (150000/12) = 12500

Transaction Volume of PI2 for the Usage Period in the Deal Frequency =
 (Total Transaction Volume of PI2 * Deal Frequency)/Usage Frequency =
 (30000 * 3 (i.e. Quarterly))/12(i.e. Annually) = (90000/12) = 7500

In this way, the system derives the original and proposed commitments for the A2 account in the D1 deal.

Considering Non-Recurring SQI Based Billable Charges for Commitment Calculation

Let us understand how the original and proposed commitments are calculated from the non-recurring SQI based billable charges for a usage period in a deal frequency.

Example 3:

A deal is created for an account named A1 where the deal start date is set to 01-Jul-2020, deal end date is set to 31-Aug-2020, deal currency is set to USD, price selection date is set to 01-Aug-2020, usage period is set to Monthly, and deal frequency is set to Quarterly. Let us assume that the following non-recurring SQI based billable charges exists for the A1 account where the invoice currency is set to INR:

Billable Charge Start Date	Billable Charge End Date	SQI	Service Quantity	Price Item
1-Jul-20	31-Aug-20	Number of Transactions	100	PI1
		Transaction Volume	2500	
15-Jul-20	20-Aug-20	Number of Transactions	150	PI2
		Transaction Volume	5000	
1-Jan-20	31-Mar-20	Number of Transactions	350	PI2
		Transaction Volume	2500	
1-Apr-20	31-May-20	Number of Transactions	400	PI1
		Transaction Volume	2500	

Now, while calculating the original and proposed commitments, the system derives the service quantities from the non-recurring billable charges for the usage period in the deal frequency. To derive the service quantities from the non-recurring billable charges for the usage period in the deal frequency, the system does the following:

1. Derives the usage period (i.e. usage start date and usage end date) using the price selection date and usage frequency in the following manner:

Price Selection Date = 01-Aug-2020
 Usage End Date = Price Selection Date = 01-Aug-2020
 Usage Start Date = Usage End Date - Usage Frequency = 01-Aug-2020 - 1
 Month (i.e. 30 days) = 02-Jul-2020
 Usage Period = 02-Jul-2020 to 01-Aug-2020

2. Considers those non-recurring SQI based billable charges where the usage start or end date falls within the billable charge start and end dates. For example, the system considers the following non-recurring billable charges of the A1 account:

Billable Charge Start Date	Billable Charge End Date	SQL	Service Quantity	Price Item
1-Jul-20	31-Aug-20	Number of Transactions	100	P11
		Transaction Volume	2500	
15-Jul-20	20-Aug-20	Number of Transactions	150	P12
		Transaction Volume	5000	

3. Derives the former start date and latter end date of the billable charges in the following manner:

Former Start Date = Compare the Start Dates of All Billable Charges and Retain the Earliest Start Date

Latter End Date = Compare the End Dates of All Billable Charges and Retain the Latest End Date

In this case, the former start date is 01-Jul-2020 and latter end date is 31-Aug-2020.

4. Derives the number of months between the former start date and latter end date. In this case, the number of months between 01-Jul-2020 and 31-Aug-2020 is 2.
5. Derives the monthly commitments in the following manner:

Monthly Number of Transactions of P11 = Total Number of Transactions of P11/Number of Months between Former Start and Latter End Dates = $100/2 = 50$

Monthly Number of Transactions of P12 = Total Number of Transactions of P12/Number of Months between Former Start and Latter End Dates = $150/2 = 75$

Monthly Transaction Volume of P11 = Total Transaction Volume of P11/Number of Months between Former Start and Latter End Dates = $2500/2 = 1250$

Monthly Transaction Volume of P12 = Total Transaction Volume of P12/Number of Months between Former Start and Latter End Dates = $5000/2 = 2500$

6. Calculates the commitments for the usage period in the deal frequency in the following manner:

Number of Transactions of P11 for the Usage Period in the Deal Frequency = $(\text{Monthly Number of Transactions of P11} * \text{Deal Frequency}) / \text{Usage Frequency} = (50 * 3 \text{ (i.e. Quarterly)}) / 1 \text{ (i.e. Monthly)} = 150$

Number of Transactions of P12 for the Usage Period in the Deal Frequency = $(\text{Monthly Number of Transactions of P12} * \text{Deal Frequency}) / \text{Usage Frequency} = (75 * 3 \text{ (i.e. Quarterly)}) / 1 \text{ (i.e. Monthly)} = 225$

Transaction Volume of P11 for the Usage Period in the Deal Frequency = $(\text{Monthly Transaction Volume of P11} * \text{Deal Frequency}) / \text{Usage Frequency} = (1250 * 3 \text{ (i.e. Quarterly)}) / 1 \text{ (i.e. Monthly)} = 3750$

Transaction Volume of P12 for the Usage Period in the Deal Frequency = $(\text{Monthly Transaction Volume of P12} * \text{Deal Frequency}) / \text{Usage Frequency} = (2500 * 3 \text{ (i.e. Quarterly)}) / 1 \text{ (i.e. Monthly)} = 7500$

In this way, the system derives the original and proposed commitments for the A1 account in the D1 deal.

Stacking Commitments in Deal

Oracle Revenue Management and Billing enables you to stack commitments of a customer in a deal when a price assignment of its account is defined at the parent customer, grandparent customer, or at the sibling customer level in the customer hierarchy. Stacking means aggregating the service quantities of the customer, parent customers, grandparent customers, and sibling customers in the customer hierarchy. The system then derives the tiered pricing based on the stacked commitments of the customer instead of using the actual commitments of the account. To enable the stacking feature for a deal, you need to do the following:

- Ensure that the **Stacking Required (Y/N)** parameter is set to **Y** in the rate value algorithm of the required rate components

- Attach the **C1_STACKDEAL** algorithm to the **Hierarchy Creation Completion** system event in the respective deal type

When you create a deal for an existing customer without reference, the system stacks the commitments (if required) and uses it as the original and proposed commitments of the customer during the customer hierarchy creation. The system then calculates the original and proposed average price and revenue using the stacked commitments of the customer. However, when you create a deal for an existing customer with reference or when you create a deal for an existing account with or without reference, the system stacks the commitments (if required) and uses it as the original commitments of the customer during the customer hierarchy creation. The system then calculates the original average price and revenue using the stacked commitments of the customer.

Terms and Conditions Selection in a Deal Based on Characteristic Value

Earlier, the system, by default, did not select the deal, price item, or hierarchy entity level terms and conditions while creating a deal. You had to manually select the required terms and conditions for the deal, price items, and hierarchy entities.

Now, the system provides an alternative solution wherein the terms and conditions at the deal, price item, and hierarchy entity levels are automatically selected based on their characteristic in the **Terms and Conditions** screen. Two new algorithm spots named **Terms and Conditions Filter** and **Terms and Conditions Selection Validation** are available while defining a deal type. A new algorithm type named **C1-DEAL-TCFL** is introduced in this release. This algorithm checks whether the selection characteristic type specified in the parameter is defined on the deal, price item and hierarchy entity level terms and conditions. A new characteristic type named **C1_SEL_T** is shipped with the product. It has three predefined values – **Standard**, **Mandatory**, and **Optional**. While creating a deal, the system checks whether the **C1-DEAL-TCFL** algorithm is attached to the **Terms and Conditions Filter** system event in the respective deal type. If the **C1-DEAL-TCFL** algorithm is not attached to the **Terms and Conditions Filter** system event in the respective deal type, the system behaves in the traditional manner. However, if the **C1-DEAL-TCFL** algorithm is attached to the **Terms and Conditions Filter** system event in the respective deal type, the system checks whether the selection characteristic type specified in the **C1-DEAL-TCFL** algorithm is defined for the deal, price item, and hierarchy entity level terms and conditions. If so, the system behavior for each terms and conditions varies depending on the value defined for the **C1_SEL_T** characteristic type on the respective terms and conditions. The following table explains the significance of each predefined characteristic value:

Characteristic Value	System Behavior
Standard	If the characteristic value is set to Standard , the system, by default, selects the check box corresponding to the deal, price item, or hierarchy entity level terms and conditions in the Terms and Conditions screen. The check box is editable.
Mandatory	If the characteristic value is set to Mandatory , the system, by default, selects the check box corresponding to the deal, price item, or hierarchy entity level terms and conditions in the Terms and Conditions screen. The check box is non-editable.
Optional	If the characteristic value is set to Optional , the system, by default, does not select the check box corresponding to the deal, price item, or hierarchy entity level terms and conditions in the Terms and Conditions screen. The check box is editable.

The following table explains the above scenarios with the help of an example:

Level	Terms and Conditions	Characteristic Value	Check Box Selected (Y or N)	Check Box Disabled (Y or N)
Deal	T1	Standard	Y	N
Deal	T2	Mandatory	Y	Y

Level	Terms and Conditions	Characteristic Value	Check Box Selected (Y or N)	Check Box Disabled (Y or N)
Deal	T3	Optional	N	N
Price Item	T4	Standard	Y	N
Price Item	T5	Mandatory	Y	Y
Price Item	T6	Optional	N	N
Hierarchy Entity	T7	Standard	Y	N
Hierarchy Entity	T8	Mandatory	Y	Y
Hierarchy Entity	T9	Optional	N	N

If required, you can anytime deselect or select any standard or optional terms and conditions at the deal, price item, or hierarchy entity level. If the selection characteristic type is not specified in the **C1-DEAL-TCFL** algorithm or if the selection characteristic type is not defined for the terms and conditions, the system considers the terms and conditions as optional at the respective level.

You can opt to validate the selection (if required) by designing a custom logic and then attaching the algorithm to the **Terms and Conditions Selection Validation** system event of the respective deal type. On clicking the **Save** button, the system will invoke the algorithm attached to the **Terms and Conditions Selection Validation** system event and accordingly validate the terms and conditions selection at the deal, price item, or hierarchy entity level. Now, on clicking the **Select All** button in the **Terms and Conditions** screen, the system selects all the terms and conditions at the respective level irrespective of the **C1_SEL_T** characteristic value. However, on clicking the **Deselect All** button in the **Terms and Conditions** screen, the system deselects all the terms and conditions at the respective level except the ones where the **C1_SEL_T** characteristic value is set to **Mandatory**.

Terms and Conditions Grouping in a Deal Based on Characteristic Value

Oracle Revenue Management and Billing provides the ability to automatically group the terms and conditions at the deal, price item, and hierarchy entity levels based on their characteristic in the **Terms and Conditions** screen. Two new algorithm spots named **Terms and Conditions Filter** and **Terms and Conditions Selection Validation** are available while defining a deal type. A new algorithm type named **C1-DEAL-TCFL** is introduced in this release. This algorithm checks whether the grouping characteristic type specified in the parameter is defined on the deal, price item and hierarchy entity level terms and conditions. You need to create a characteristic type for terms and conditions grouping and define the group names as its predefined characteristic values.

While creating a deal, the system checks whether the **C1-DEAL-TCFL** algorithm is attached to the **Terms and Conditions Filter** system event in the respective deal type. If the **C1-DEAL-TCFL** algorithm is attached to the **Terms and Conditions Filter** system event in the respective deal type, the system checks whether the grouping characteristic type specified in the **C1-DEAL-TCFL** algorithm is defined for the deal, price item, and hierarchy entity level terms and conditions. If so, the system logically groups the terms and conditions at the deal, price item, and hierarchy entity levels based on the group name (i.e. based on the value defined for the grouping characteristic type). If the **C1-DEAL-TCFL** algorithm is not attached to the **Terms and Conditions Filter** system event in the respective deal type or if the grouping characteristic type is not specified in the **C1-DEAL-TCFL** algorithm, or if the grouping characteristic is not defined for a terms and conditions, the system does not group the terms and conditions under any head.

The following table explains the grouping logic with the help of an example:

Level	Terms and Conditions	Characteristic Value
Deal	T1	G1
Deal	T2	G2
Deal	T3	G1

Level	Terms and Conditions	Characteristic Value
Deal	T10	-
Deal	T11	-
Price Item	T4	G3
Price Item	T5	G3
Price Item	T6	G3
Hierarchy Entity	T7	G4
Hierarchy Entity	T8	G4
Hierarchy Entity	T9	G4

In the above example, the system will group T1 and T3 under G1 and T2 under G2 at the deal level. Note that the system will not group T10 and T11 under any head at the deal level. Similarly, the system will group T4, T5, and T6 under G3 at the price item level and T7, T8, and T9 under G4 at the hierarchy entity level.

Overriding Terms and Conditions in a Deal

Oracle Revenue Management and Billing enables you to override the default terms and conditions at the deal, price item, and hierarchy entity levels and add specific information related to the deal. The system maintains the edited version of terms and conditions separately from the default version for each deal. You can view both the default and edited versions of the terms and conditions in the **Terms and Conditions (Used for Editing in Deal)** screen. On subsequent edits, the system overrides the edited version of the terms and conditions. The system highlights the edited and non-edited versions of the terms and conditions with different color scheme.

Refreshing Terms and Conditions in a Deal

Oracle Revenue Management and Billing enables you to refresh the terms and conditions at the deal, price item, and hierarchy entity levels. On refreshing the terms and conditions, the system updates the terms and conditions based on their selection and grouping characteristics. Note that while refreshing the terms and conditions, the system loses the manual selection and deselection of terms and conditions and edited version of the terms and conditions. The adhoc terms and conditions are retained while refreshing the terms and conditions at the deal, price item, and hierarchy entity levels.

Deal Approval Profile

The **Deal Approval Profile** screen allows you to define the approval hierarchy levels with the required limits and rights for approving a deal. This profile is then associated to the deal type to specify whether it will be used for product level, division level, or deal level approval. It also allows you to edit, copy, and delete a deal approval profile. It contains the following zones:

- [Deal Approval Profile List](#) on page 2674
- [Deal Approval Profile](#) on page 2675

Deal Approval Profile List

The **Deal Approval Profile List** zone lists the deal approval profiles that are already defined in the system. It contains the following columns:

Column Name	Column Description
Deal Approval Profile	Displays the deal approval profile.
Description	Displays the description of the deal approval profile.
Edit	On clicking the Edit (✎) icon, the Deal Approval Profile screen appears where you can edit the details of the deal approval profile.
Duplicate	On clicking the Duplicate (📄) icon, the Deal Approval Profile screen appears where you can define a new deal approval profile using an existing deal approval profile.
Delete	On clicking the Delete (🗑) icon, you can delete the deal approval profile. Note: You can delete a deal approval profile only when the deal approval profile is not yet used for creating a deal type.

Note: Pagination is used to display limited number of records in this zone. You can use the navigation links, such as **Previous** and **Next** to navigate between pages.

You can filter the list using various search criteria (such as, **Deal Approval Profile**, **Status**, **Description**, **To Do Type**, **Approval Profile Currency**, and **To Do Role**) available in the **Filter** area. By default, the **Filter** area is hidden. You can view the **Filter** area by clicking the **Filters** (🔍) icon in the upper right corner of this zone.

On clicking the **Broadcast** (📢) icon corresponding to a deal approval profile, the **Deal Approval Profile** zone appears where you can view the details of the respective deal approval profile.

Related Topics

For more information on...	See...
How to edit a deal approval profile	Editing a Deal Approval Profile on page 2683
How to copy a deal approval profile	Copying a Deal Approval Profile on page 2684
How to delete a deal approval profile	Deleting a Deal Approval Profile on page 2686
How to view the details of a deal approval profile	Viewing the Deal Approval Profile Details on page 2687

Deal Approval Profile

The **Deal Approval Profile** zone displays the details of the deal approval profile. It contains the following sections:

- **Main** - Displays basic information about the deal approval profile. It contains the following fields:

Field Name	Field Description
Deal Approval Profile	Indicates the deal approval profile.
Description	Displays the description of the deal approval profile.
Detailed Description	Displays additional information about the deal approval profile.
Approval Profile Currency	Indicates the currency in which the amounts are mentioned in the deal approval profile.
Status	Indicates the status of the deal approval profile. The valid values are:

Field Name	Field Description
	<ul style="list-style-type: none"> Active Inactive

- **Approval Hierarchy** - Displays the approval hierarchy levels with their required limits and rights defined for approving a deal. It contains the following columns:

Column Name	Column Description
Level	Indicates the approval level.
To Do Type	<p>Indicates the To Do Type using which the To Do task is assigned to the approver/user group for approving the deal at the specified hierarchy level.</p> <p>Note: It has a link. On clicking the link, the To Do Type screen appears where you can view the details of the respective To Do Type.</p>
To Do Role	<p>Indicates the approver/user group to whom the To Do task of the To Do Type is assigned for approving the deal at the specified hierarchy level.</p> <p>Note: It has a link. On clicking the link, the To Do Role screen appears where you can view the details of the respective To Do Role.</p>
Recommend Pricing	<p>Indicates whether the approver/user (other than the relationship manager) at the specified hierarchy level is entitled to recommend a change in the proposed pricing of the price item. The valid values are:</p> <ul style="list-style-type: none"> Yes No
Submit Price Item For Approval	<p>Indicates whether the approver/user at the specified hierarchy level is entitled to submit one or more price items to the product manager for approval. The valid values are:</p> <ul style="list-style-type: none"> Yes No
Approve Deal	<p>Indicates whether the approver/user at the specified hierarchy level is entitled to approve the deal after all the discretion check is confirmed. The valid values are:</p> <ul style="list-style-type: none"> Yes No
View Only Eligible Price Items	<p>Indicates whether the approver/user at the specified hierarchy level can view only those price items which meet the pricing limits as set in the approval hierarchy. The valid values are:</p> <ul style="list-style-type: none"> Yes No
Minimum Profitability (%)	Displays the minimum deal profitability percentage which is set for the approver/user at the specified hierarchy level for approving the deal.
Maximum Profitability (%)	Displays the maximum deal profitability percentage which is set for the approver/user at the specified hierarchy level for approving the deal.

Column Name	Column Description
Minimum Profit	Displays the minimum deal profitability amount which is set for the approver/user at the specified hierarchy level for approving the deal.
Maximum Profit	Displays the maximum deal profitability amount which is set for the approver/user at the specified hierarchy level for approving the deal.
Minimum Profit Variation (%)	Displays the minimum deal profitability variation percentage which is set for the approver/user at the specified hierarchy level for approving the deal.
Maximum Profit Variation (%)	Displays the maximum deal profitability variation percentage which is set for the approver/user at the specified hierarchy level for approving the deal.
Minimum Profit Variation	Displays the minimum deal profitability variation amount which is set for the approver/user at the specified hierarchy level for approving the deal.
Maximum Profit Variation	Displays the maximum deal profitability variation amount which is set for the approver/user at the specified hierarchy level for approving the deal.
Minimum Revenue	Displays the minimum deal revenue which can be approved by the approver/user at a specified hierarchy level.
Maximum Revenue	Displays the maximum deal revenue which can be approved by the approver/user at a specified hierarchy level.

- **Record Actions** - This section contains the following buttons:

Button Name	Button Description
Edit	Used to edit the details of the deal approval profile.
Delete	Used to delete the deal approval profile.
	Note: You can delete a deal approval profile only when the deal approval profile is not yet used for creating a deal type.
Duplicate	Used to create a new deal approval profile using an existing deal approval profile.

- **Record Information** - This section contains the following field:

Field Name	Field Description
Business Object	Indicates the business object using which the deal approval profile is created in the system. In addition, a context menu appears corresponding to this field which helps in navigating to other screens in the application.
	Note: It has a link. On clicking the link, the Business Object screen appears where you can view the details of the respective business object.

By default, the **Deal Approval Profile** zone does not appear in the **Deal Approval Profile** screen. It appears when you click the **Broadcast** () icon corresponding to a deal approval profile in the **Deal Approval Profile List** zone.

Related Topics

For more information on...	See...
Deal Approval Profile screen	Deal Approval Profile on page 2674
Deal Approval Profile List zone	Deal Approval Profile List on page 2674

Defining a Deal Approval Profile

Prerequisites

To define a deal approval profile, you should have:

- Currencies defined in the application
- Approval hierarchy levels defined in the application
- To Do roles and To Do types defined in the application

Procedure

To define a deal approval profile:

1. Click the **Admin** link in the **Application** toolbar.
A list appears.
2. From the **Admin** menu, select **D** and then click **Deal Approval Profile**.
A sub-menu appears.
3. Click the **Add** option from the **Deal Approval Profile** sub-menu.

The **Deal Approval Profile** screen appears. It contains the following sections:

- **Main** - Used to specify basic details about the deal approval profile.
- **Approval Hierarchy** - Used to define the approval levels in the approval hierarchy with their required limits and rights for approving a deal.

The **Main** section contains the following fields:

Field Name	Field Description	Mandatory (Yes or No)
Deal Approval Profile	Used to specify the deal approval profile.	Yes
Description	Used to specify the description for the deal approval profile.	Yes
Detailed Description	Used to specify additional information about the deal approval profile.	Yes
Approval Profile Currency	Used to indicate the currency in which the amounts are mentioned in the deal approval profile. Note: The list includes only those currencies which are already defined in the system.	Yes
Status	Used to indicate the status of the deal approval profile. The valid values are: <ul style="list-style-type: none"> • Active • Inactive Note: Only the active deal approval profiles can be assigned to the deal type for approving the deal.	Yes

Tip: Alternatively, you can access this screen by clicking the **Add** button in the **Page Title** area of the **Deal Approval Profile** screen.

4. Enter the required details in the **Main** section.
5. Define approval levels in the approval hierarchy with the required limits and rights for approving the deal.
6. Click **Save**.

The deal approval profile is defined.

Related Topics

For more information on...	See...
Deal Approval Profile screen	Deal Approval Profile on page 2674
How to define an approval level in the approval hierarchy	Defining an Approval Level in the Approval Hierarchy on page 2679

Defining an Approval Level in the Approval Hierarchy

Prerequisites

To define an approval level in the approval hierarchy, you should have:

- Approval hierarchy levels defined in the application.
- To Do roles and To Do types defined in the application.

Procedure

To define an approval level in the approval hierarchy:

1. Ensure that the **Approval Hierarchy** section is expanded in the **Deal Approval Profile** screen when you are defining, editing, or copying a deal approval profile.

The **Approval Hierarchy** section contains the following fields in a grid:

Field Name	Field Description	Mandatory (Yes or No)
Level	Used to indicate the approval level.	Yes
	<p>Note:</p> <p>The user who creates the deal i.e. the relationship manager (RM) should always belong to the first level (Level 0) in the deal approval hierarchy.</p> <p>There cannot be a parallel level for the first level (Level 0) in the approval hierarchy. In other words, there can be only one relationship manager (RM) in the entire deal approval hierarchy.</p>	
To Do Type	Used to specify the To Do task which is assigned to the approver/user group for approving the deal at the specified hierarchy level.	Yes

Field Name	Field Description	Mandatory (Yes or No)
	<p>Note:</p> <p>The Search (🔍) icon appears corresponding to the To Do Type field. On clicking the Search icon, the To Do Type Search window appears.</p> <p>On specifying the value for a predefined To Do type, the description of the To Do type appears corresponding to the To Do Type field.</p>	
To Do Role	Used to indicate the approver/user group to whom the To Do task is assigned for approving the deal at the specified hierarchy level.	Yes
Propose Pricing	<p>Used to indicate whether the approver/user (other than the relationship manager) at the specified hierarchy level is entitled to recommend a change in the proposed pricing of the price item. The valid values are:</p> <ul style="list-style-type: none"> • Yes • No <p>Note: By default, this field is read only and the value is set to No for the first level (Level 0) approver/user i.e. the relationship manager (RM) in the approval hierarchy.</p>	<p>Yes (Conditional)</p> <p>Note: This field is required while defining approval levels for the approving a deal.</p>
Submit Price Item for Approval	<p>Used to indicate whether the approver/user at the specified hierarchy level is entitled to submit one or more price items to the respective product managers for approval. The valid values are:</p> <ul style="list-style-type: none"> • Yes • No <p>Note: The approver/user can submit the price items to the respective product managers for approval when the values for the Price Item Manager To Do Type and Price Item Manager To Do Role fields are defined in the respective Price Item screen.</p>	<p>Yes (Conditional)</p> <p>Note: This field is required while defining approval levels for the approving a deal.</p>
Approve Deal	<p>Used to indicate whether the approver/user at the specified hierarchy level is entitled to approve the deal after all the discretion check is confirmed. The valid values are:</p> <ul style="list-style-type: none"> • Yes • No 	<p>Yes (Conditional)</p> <p>Note: This field is required while defining approval levels for the approving a deal.</p>

Field Name	Field Description	Mandatory (Yes or No)
	<p>Note:</p> <p>At least one approval hierarchy level must have the value of the Approve Deal field set to Yes.</p> <p>If the value of the Approve Deal field is set to Yes, then, the approver/user can change the status of the deal from Draft to Ready for Approval or Approved.</p>	
View Only Eligible Price Items	<p>Used to indicate whether the approver/user at the specified hierarchy level can approve only those price items which meet the pricing limits as set in the approval hierarchy. The valid values are:</p> <ul style="list-style-type: none"> • Yes • No <p>Note: By default, this field is read only and the value is set to No for the first level (Level 0) approver/user i.e. the relationship manager (RM) in the approval hierarchy.</p>	<p>Yes (Conditional)</p> <p>Note: This field is required while defining approval levels for the approving a deal.</p>
Minimum Profitability (%)	<p>Used to specify the minimum deal profitability percentage for the approver/user at the specified hierarchy level for approving the deal.</p> <p>Note: You can either specify the percentage or amount values for minimum and maximum limit.</p>	<p>Yes (Conditional)</p> <p>Note: This field is required while defining approval levels for the approving a deal.</p>
Maximum Profitability (%)	<p>Used to specify the maximum deal profitability percentage for the approver/user at the specified hierarchy level for approving the deal.</p> <p>Note: You can either specify the percentage or amount values for minimum and maximum limit.</p>	<p>Yes (Conditional)</p> <p>Note: This field is required while defining approval levels for the approving a deal.</p>
Minimum Profitability Amount	<p>Used to specify the minimum deal profitability amount for the approver/user at the specified hierarchy level for approving the deal.</p> <p>Note: You can either specify the percentage or amount values for minimum and maximum limit.</p>	<p>Yes (Conditional)</p> <p>Note: This field is required while defining approval levels for the approving a deal.</p>
Maximum Profitability Amount	<p>Used to specify the maximum deal profitability amount for the approver/user at the specified hierarchy level for approving the deal.</p>	<p>Yes (Conditional)</p>

Field Name	Field Description	Mandatory (Yes or No)
	Note: You can either specify the percentage or amount values for minimum and maximum limit.	Note: This field is required while defining approval levels for the approving a deal.
Minimum Deviation (%)	Used to specify the minimum deal variation percentage for the approver/user at the specified hierarchy level for approving the deal. Note: You can either specify the percentage or amount values for minimum and maximum limit.	Yes (Conditional) Note: This field is required while defining approval levels for the approving a deal.
Maximum Deviation (%)	Used to specify the maximum deal variation percentage for the approver/user at the specified hierarchy level for approving the deal. Note: You can either specify the percentage or amount values for minimum and maximum limit.	Yes (Conditional) Note: This field is required while defining approval levels for the approving a deal.
Minimum Deviation Amount	Used to specify the minimum deal variation amount for the approver/user at the specified hierarchy level for approving the deal. Note: You can either specify the percentage or amount values for minimum and maximum limit.	Yes (Conditional) Note: This field is required while defining approval levels for the approving a deal.
Maximum Deviation Amount	Used to specify the maximum deal variation amount for the approver/user at the specified hierarchy level for approving the deal. Note: You can either specify the percentage or amount values for minimum and maximum limit.	Yes (Conditional) Note: This field is required while defining approval levels for the approving a deal.
Minimum Revenue Amount	Used to specify the minimum deal revenue which can be approved by the approver/user at a specified hierarchy level.	Yes (Conditional) Note: This field is required while defining approval levels for the approving a deal.
Maximum Revenue Amount	Used to specify the maximum deal revenue which can be approved by the approver/user at a specified hierarchy level.	Yes (Conditional) Note: This field is required while defining approval levels for the approving a deal.

2. Enter the required details in the **Approval Hierarchy** section.

- If you want to define more than one approval level in the approval hierarchy, click the **Add (+)** icon and then repeat step 2.

Note:

However, if you want to remove an approval level from the approval hierarchy, click the **Delete (🗑)** icon corresponding to the approval hierarchy.

At present, you can add an approval level from 0 to 10. If required, you can add more approval levels in the system through the **C1_DEALHIERARCHYLEVEL** lookup field.

- Click **Save**.

The approval level is defined in the approval hierarchy.

Related Topics

For more information on...	See...
Deal Approval Profile screen	Deal Approval Profile on page 2674
How to define a deal approval profile	Defining a Deal Approval Profile on page 2678
How to edit a deal approval profile	Editing a Deal Approval Profile on page 2683
How to copy a deal approval profile	Copying a Deal Approval Profile on page 2684
How to delete a deal approval profile	Deleting a Deal Approval Profile on page 2686

Editing a Deal Approval Profile**Prerequisites**

To edit a deal approval profile, you should have:

- Currencies defined in the application
- Approval hierarchy levels defined in the application.
- To Do roles and To Do types defined in the application.

Procedure

To edit a deal approval profile:

- Click the **Admin** link in the **Application** toolbar.

A list appears.

- From the **Admin** menu, select **D** and then click **Deal Approval Profile**.

A sub-menu appears.

- Click the **Search** option from the **Deal Approval Profile** sub-menu.

The **Deal Approval Profile** screen appears.

- In the **Deal Approval Profile List** zone, click the **Edit (✎)** icon in the **Edit** column corresponding to the deal approval profile whose details you want to edit.

The **Deal Approval Profile** screen appears. It contains the following sections:

- Main** - Used to specify basic details about the deal approval profile.
- Approval Hierarchy** - Used to define the approval levels in the approval hierarchy with the required limits and rights for approving a deal.

The **Main** section contains the following fields:

Field Name	Field Description	Mandatory (Yes or No)
Deal Approval Profile	Used to specify the deal approval profile.	Not applicable
Description	Used to specify the description for the deal approval profile.	Yes
Detailed Description	Used to specify additional information about the deal approval profile.	Yes
Approval Profile Currency	Used to indicate the currency in which the amounts are mentioned in the deal approval profile.	Yes
	Note: The list includes only those currencies which are already defined in the system.	
Status	Used to indicate the status of the deal approval profile. The valid values are: <ul style="list-style-type: none"> Active Inactive 	Yes
	Note: Only the active deal approval profiles can be assigned to the deal type for approving the deal.	

Tip: Alternatively, you can edit the details of a deal approval profile by clicking the **Edit** button in the **Deal Approval Profile** zone.

5. Modify the required details in the **Main** section.
6. Add, edit, or remove approval levels in the approval hierarchy, if required.
7. Click **Save**.

The changes made to the deal approval profile are saved.

Related Topics

For more information on...	See...
Deal Approval Profile screen	Deal Approval Profile on page 2674
Deal Approval Profile List zone	Deal Approval Profile List on page 2674
How to define a deal approval profile	Defining a Deal Approval Profile on page 2678
How to define an approval level in the approval hierarchy	Defining an Approval Level in the Approval Hierarchy on page 2679

Copying a Deal Approval Profile

Instead of creating a deal approval profile from scratch, you can create a new deal approval profile using an existing deal approval profile. This is possible through copying a deal approval profile. On copying a deal approval profile, the details including the approval levels in the approval hierarchy are copied to the new deal approval profile. You can then edit the details, if required.

Prerequisites

To copy a deal approval profile, you should have:

- Deal approval profile (whose copy you want to create) defined in the application
- Currencies defined in the application
- Approval hierarchy levels defined in the application.
- To Do roles and To Do types defined in the application.

Procedure

To copy a deal approval profile:

1. Click the **Admin** link in the **Application** toolbar.
A list appears.
2. From the **Admin** menu, select **D** and then click **Deal Approval Profile**.
A sub-menu appears.
3. Click the **Search** option from the **Deal Approval Profile** sub-menu.
The **Deal Approval Profile** screen appears.
4. In the **Deal Approval Profile List** zone, click the **Duplicate** (📄) icon in the **Duplicate** column corresponding to the deal approval profile whose copy you want to create.

The **Deal Approval Profile** screen appears. It contains the following sections:

- **Main** - Used to specify basic details about the deal approval profile.
- **Approval Hierarchy** - Used to define the approval levels in the approval hierarchy with the required limits and rights for approving a deal.

The **Main** section contains the following fields:

Field Name	Field Description	Mandatory (Yes or No)
Deal Approval Profile	Used to specify the deal approval profile.	Yes
Description	Used to specify the description for the deal approval profile.	Yes
Detailed Description	Used to specify additional information about the deal approval profile.	Yes
Approval Profile Currency	Used to indicate the currency in which the amounts are mentioned in the deal approval profile.	Yes
	Note: The list includes only those currencies which are already defined in the system.	
Status	Used to indicate the status of the deal approval profile. The valid values are: <ul style="list-style-type: none"> • Active • Inactive 	Yes
	Note: Only the active deal approval profiles can be assigned to the deal type for approving the deal.	

Tip: Alternatively, you can copy a deal approval profile by clicking the **Duplicate** button in the **Deal Approval Profile** zone.

5. Enter the required details in the **Main** section.
6. Add, edit, or remove approval levels in the approval hierarchy, if required.
7. Click **Save**.

The new deal approval profile is defined.

Related Topics

For more information on...	See...
Deal Approval Profile screen	Deal Approval Profile on page 2674
Deal Approval Profile List zone	Deal Approval Profile List on page 2674
How to define a deal approval profile	Defining a Deal Approval Profile on page 2678
How to define an approval level in the approval hierarchy	Defining an Approval Level in the Approval Hierarchy on page 2679

Deleting a Deal Approval Profile

Procedure

To delete a deal approval:

1. Click the **Admin** link in the **Application** toolbar.
A list appears.
2. From the **Admin** menu, select **D** and then click **Deal Approval Profile**.
A sub-menu appears.
3. Click the **Search** option from the **Deal Approval Profile** sub-menu.
The **Deal Approval Profile** screen appears.
4. In the **Deal Approval Profile List** zone, click the **Delete** (🗑️) icon in the **Delete** column corresponding to the deal approval profile that you want to delete.
A message appears confirming whether you want to delete the deal approval profile.

Note: You can delete a deal approval profile only when the deal approval profile is not yet used for creating a deal type.

Tip: Alternatively, you can delete a deal approval profile by clicking the **Delete** button in the **Deal Approval Profile** zone.

5. Click **OK**.

The deal approval profile is deleted.

Related Topics

For more information on...	See...
Deal Approval Profile screen	Deal Approval Profile on page 2674
Deal Approval Profile List zone	Deal Approval Profile List on page 2674

For more information on...	See...
Deal Approval Profile zone	Deal Approval Profile on page 2675

Viewing the Deal Approval Profile Details

Procedure

To view the details of a deal approval profile:

1. Click the **Admin** link in the **Application** toolbar.
A list appears.
2. From the **Admin** menu, select **D** and then click **Deal Approval Profile**.
A sub-menu appears.
3. Click the **Search** option from the **Deal Approval Profile** sub-menu.
The **Deal Approval Profile** screen appears.
4. In the **Deal Approval Profile List** zone, click the **Broadcast** () icon corresponding to the deal approval profile whose details you want to view.
The **Deal Approval Profile** zone appears.
5. View the details of the deal approval profile in the **Deal Approval Profile** zone.

Related Topics

For more information on...	See...
Deal Approval Profile screen	Deal Approval Profile on page 2674
Deal Approval Profile List zone	Deal Approval Profile List on page 2674
Deal Approval Profile zone	Deal Approval Profile on page 2675

Deal Type

A deal type helps the system to determine:

- Whether the pricing for each price item should be approved in the deal
- Whether the deal should be assigned to users for approval as per the limits defined in the deal approval profile
- Whether the pricing and financial summary should be approved at the product level
- Whether the pricing and financial summary should be approved at the division level
- Whether the highest level approval in the approval hierarchy is required for the deal
- Whether the existing pricing should be pre-approved in the deal
- The questionnaire template using which you want to find references for creating a deal
- The deal approval profile that should be used for a product level approval
- The deal approval profile that should be used for a division level approval
- The deal approval profile that should be used for the deal level approval based on the division, customer segment, and customer tier combination

The **Deal Type** screen allows you to define, view, edit, copy, and delete a deal type. It contains the following zones:

- [Deal Type List](#) on page 2688

- [Deal Type](#) on page 2688
- [Deal Approval Profiles](#) on page 2692
- [Customer Characteristics](#) on page 2693

Deal Type List

The **Deal Type List** zone lists the deal types that are already defined in the system. It contains the following columns:

Column Name	Column Description
Deal Type	Displays the deal type.
Description	Displays the description of the deal type.
Edit	On clicking the Edit (✎) icon corresponding to a deal type, the Deal Type screen appears where you can edit the details of the deal type.
Duplicate	On clicking the Duplicate (📄) icon corresponding to a deal type, the Deal Type screen appears where you can define a new deal type using an existing deal type.
Delete	On clicking the Delete (🗑) icon corresponding to a deal type, you can delete the deal type. Note: You can delete a deal type only when the deal type is not yet used for creating a deal.

Note: Pagination is used to display limited number of records in this zone. You can use the navigation links, such as **Previous** and **Next** to navigate between pages.

You can filter the list using various search criteria (such as, **Deal Type**, **Description**, **Division**, **Customer Segment**, **Effective Date**, **Customer Tier**, **Status**, **Approval Type**, and **Deal Approval Profile**) available in the **Filter** area. By default, the **Filter** area is hidden. You can view the **Filter** area by clicking the **Filters** (🔍) icon in the upper right corner of this zone.

On clicking the **Broadcast** (📢) icon corresponding to a deal type, the **Deal Type** and **Deal Approval Profiles** zones appear with the respective details.

Related Topics

For more information on...	See...
How to edit a deal type	Editing a Deal Type on page 2704
How to copy a deal type	Copying a Deal Type on page 2709
How to delete a deal type	Deleting a Deal Type on page 2714
How to view the details of a deal type	Viewing the Details of a Deal Type on page 2714
Deal Type zone	Deal Type on page 2688
Deal Approval Profiles zone	Deal Approval Profiles on page 2692

Deal Type

The **Deal Type** zone displays the details of the deal type. It contains the following sections:

- **Main** - Displays basic information about the deal type. It contains the following fields:

Field Name	Field Description
Deal Type	Displays the deal type.
Description	Displays the description of the deal type.
Detailed Description	Displays additional information about the deal type.
Deal Commitment Frequency	Indicates the periodic analysis of deal usage as per the commitments made by the customer for calculating the deal financial summary. The valid values are: <ul style="list-style-type: none"> • Biannually • Monthly • Quarterly • Yearly
Price Item Approval Required	Indicates whether discretion check of the individual price item is required by the approver/user for approving the deal. The valid values are: <ul style="list-style-type: none"> • Yes • No
Assign Only If In Range	Indicates whether the deal is assigned to the approver/user as per the limits set in the Approval Hierarchy section of the Deal Approval Profile screen. The valid values are: <ul style="list-style-type: none"> • Yes • No
Product Level Approval Required	Indicates whether discretion check of the price items at the product level is required for approving a deal. The valid values are: <ul style="list-style-type: none"> • Yes • No
Division Level Approval Required	Indicates whether discretion check of the price items at the division level is required for approving a deal. The valid values are: <ul style="list-style-type: none"> • Yes • No
Highest Level Approval Required	Indicates whether hierarchical approval of the deal is required for approving a deal. The valid values are: <ul style="list-style-type: none"> • Yes • No
Status	Indicates the status of the deal type. The valid values are: <ul style="list-style-type: none"> • Active • Inactive
Pre-Approve Existing Pricing	Indicates whether the existing price items pricing and commitments are approved for confirming the financial summary before approving a deal. The valid values are: <ul style="list-style-type: none"> • Yes

Field Name	Field Description
	<ul style="list-style-type: none"> No
To Do Reminder Days	Indicates the number of days using which the system calculates the first To Do reminder date.
To Do High Priority Days	Indicates the number of days using which the system calculates the date when the To Do reminder of highest priority should be sent.
Days to Inactivate	<p>Displays the number of days prior to the last updated date of the deal after which you want to inactivate the deal.</p> <p>Note:</p> <p>The deal is automatically inactivated if no action is performed on the deal within the specified number of days in this field.</p> <p>The status of the deal is changed to Inactive when the deal inactivation date is equal to the system date.</p>
Reminder To Do Type	Indicates the To Do task that you want to send as a notification to the user for the priority days set for reviewing the deal.
Questionnaire Template	Indicates the questionnaire template that you want to associate with the deal type.

- **Algorithms** - Lists the algorithms associated with the deal type. It contains the following columns:

Column Name	Column Description
System Event	<p>Indicates the system event when the algorithm is executed. The valid values are:</p> <ul style="list-style-type: none"> • Customer/Deal References Using Quest - Indicates the algorithm that is triggered to search for deal references based on the questionnaire associated with the deal. • Deal Inactivation - Indicates the algorithm that is triggered to automatically inactivate the deals which are not updated in the system for a long time. • Hierarchy Creation Completion - Indicates the algorithm that is triggered for aggregating the service quantities of the customer, parent customers, grandparent customers, and sibling customers in the customer hierarchy of the deal. • Post Processing Price Item Post Simulation - Indicates the algorithm that is triggered after the price item with post processing price assignment type is simulated. • Price Item Group List Filter - Indicates the algorithm that is triggered to select the price items and the hierarchy entities of an entity automatically based on whether the selection characteristic type specified in the parameter is defined for the respective price item and hierarchy entity. • Price Item Selection Validation - Indicates the algorithm that is triggered to validate the price item and hierarchy entity selection of an entity in a deal.

Column Name	Column Description
	<p>Note: The algorithm attached to the Price Item Selection Validation system event is invoked when you click the Save & View Pricing & Commitment button in the Price Item Group Selection screen of the deal.</p> <ul style="list-style-type: none"> • Price Item Approval - Indicates the algorithm that is triggered for approving the price items assigned to the entities in the customer hierarchy of the deal. • Profitability Calculation - Indicates the algorithm that is triggered for calculating the profitability of the proposed commitments defined for the price items while simulating the deal. • Recommended Products Using Questionnaire - Indicates the algorithm that is triggered for searching the recommended products for the deal. • Regular Price Item Post Simulation - Indicates the algorithm that is triggered after the price item with regular price assignment type is simulated. • Simulation Completion - Indicates the algorithm that is triggered after the deal is simulated. • Standard Price List Search - Indicates the algorithm that is triggered to derive the standard price list for the entity. • Terms and Conditions Filter - Indicates the algorithm that is triggered for selecting the deal, price item, and hierarchy entity level terms and conditions automatically based on whether the selection characteristic type specified in the parameter is defined for the respective deal, price item, and hierarchy entity. • Terms and Conditions Search Validation - Indicates the algorithm that is triggered to validate the terms and conditions selection of an entity at the deal, price item, and hierarchy entity level. <p>Note: The algorithm attached to the Terms and Conditions Search Validation system event is invoked when you click the Save button in the Terms and Conditions screen.</p>
Sequence	Displays the order in which the algorithms with the same system event should be executed.
Algorithm	Indicates the algorithm attached to the system event.
	Note: It has a link. On clicking the link, the Algorithm screen appears where you can view the details of the respective algorithm.

- **Characteristics** - Lists the characteristics defined for the deal type. It contains the following columns:

Column Name	Column Description
Effective Date	Displays the date from when the characteristic is effective for the deal type.
Characteristic Type	Indicates the characteristic type.
Characteristic Value	Displays the value of the characteristic type.

- **Record Actions** - The **Record Actions** section contains the following buttons:

Button Name	Button Description
Edit	Used to edit the details of the deal type.
Delete	Used to delete the deal type.
	Note: You can delete a deal type only when the deal type is not yet used for creating a deal.
Duplicate	Used to create a new deal type using an existing deal type.

- **Record Information** - The **Record Information** section contains the following field:

Field Name	Field Description
Business Object	Indicates the business object using which the deal type is created in the system. In addition, a context menu appears corresponding to this field which helps in navigating to other screens in the application.
	Note: It has a link. On clicking the link, the Business Object screen appears where you can view the details of the respective business object.

By default, the **Deal Type** zone does not appear in the **Deal Type** screen. It appears when you click the **Broadcast** () icon corresponding to a deal type in the **Deal Type List** zone.

Related Topics

For more information on...	See...
How to edit a deal type	Editing a Deal Type on page 2704
How to copy a deal type	Copying a Deal Type on page 2709
How to delete a deal type	Deleting a Deal Type on page 2714
How to view the details of a deal type	Viewing the Details of a Deal Type on page 2714
Deal Type screen	Deal Type on page 2687
Deal Type List zone	Deal Type List on page 2688

Deal Approval Profiles

The **Deal Approval Profiles** zone lists the deal level, division level, or product level approval profiles associated with the deal type using which the deal is approved in the system. It contains the following columns:

Column Name	Column Description
Effective Start Date	Displays the date from when the deal approval profile is effective for the deal type.
Effective End Date	Displays the date till when the deal approval profile is effective for the deal type.
Approval Type	Indicates whether the deal type is used for approving a deal in the product level approval workflow, deal level approval workflow, or division level approval workflow. The valid values are: <ul style="list-style-type: none"> • Deal • Division

Column Name	Column Description
	<ul style="list-style-type: none"> Product
Division	<p>Indicates the division for which the deal level approval, division level approval, or product level approval is required.</p> <p>Note: It has a link. On clicking the link, the Division screen appears where you can view the details of the respective division.</p>
Customer Segment	Indicates the customer segment for which the deal approval profile is required.
Customer Tier	Indicates the customer tier for which the deal approval profile is required.
Product	<p>Indicates the product for which the product level approval is required.</p> <p>Note: It has a link. On clicking the link, the Product screen appears where you can view the details of the respective product.</p>
Deal Approval Profile	<p>Indicates the approval profile used for approving the deal.</p> <p>Note: It has a link. On clicking the link, the Deal Approval Profile screen appears where you can view the details of the respective deal approval profile.</p>

Note: Pagination is used to display limited number of records in this zone. You can use the navigation links, such as **Previous** and **Next** to navigate between pages.

By default, the **Deal Approval Profiles** zone does not appear in the **Deal Type** screen. It appears when you click the **Broadcast** (📡) icon corresponding to a deal type in the **Deal Type List** zone.

On clicking the **Broadcast** (📡) icon corresponding to a deal approval profile, the **Customer Characteristics** zone appears which lists the characteristics of the customers for whom the deal is defined using the deal type.

Related Topics

For more information on...	See...
How to edit a deal type	Editing a Deal Type on page 2704
How to copy a deal type	Copying a Deal Type on page 2709
How to delete a deal type	Deleting a Deal Type on page 2714
How to associate a deal approval profile with a deal type	Associating a Deal Approval Profile with a Deal Type on page 2698
Deal Type screen	Deal Type on page 2688
Deal Type List zone	Deal Type List on page 2688
Customer Characteristics zone	Customer Characteristics on page 2693

Customer Characteristics

The **Customer Characteristics** zone lists the characteristics of the customer for whom the deal is defined using the deal type to which the approval profile is associated. It contains the following columns:

Column Name	Column Description
Characteristic Type	Displays the characteristic type.

Column Name	Column Description
Characteristic Value	Displays the value of the characteristic type.

By default, the **Customer Characteristics** zone does not appear in the **Deal Type** screen. It appears when you click the **Broadcast** () icon corresponding to a deal approval profile in the **Deal Approval Profiles** zone.

Note: The information appears in the **Customer Characteristics** zone only when the **Approval Type** is selected as **Deal** and the customer characteristic is defined for the deal approval profile.

Related Topics

For more information on...	See...
How to edit a deal type	Editing a Deal Type on page 2704
How to copy a deal type	Copying a Deal Type on page 2709
How to delete a deal type	Deleting a Deal Type on page 2714
Deal Approval Profiles zone	Deal Approval Profiles on page 2692

Defining a Deal Type

Prerequisites

To define a deal type you should have:

- Business object defined for the deal type
- Values defined for the **FREQUENCY_FLG** lookup field.
- Deal approval profiles defined in the application
- Algorithms defined in the system
- Algorithms associated with the system events
- Characteristic types defined in the application (where the characteristic entity is set to **Deal Type**).
- Reminder To Do types defined in the application
- Questionnaire templates defined in the application

Procedure

To define a deal type:

1. Click the **Admin** link in the **Application** toolbar.
A list appears.
2. From the **Admin** menu, select **D** and then click **Deal Type**.
A sub-menu appears.
3. Click the **Add** option from the **Deal Type** sub-menu.

The **Deal Type** screen appears. It contains the following sections:

- **Main** - Used to specify basic details about the deal type.
- **Deal Approval Profiles** - Used to associate deal level, division level, or product level approval profiles with the deal type for approving the deal.
- **Algorithms** - Used to associate algorithms with the system events defined for the deal type
- **Characteristics** - Used to define the characteristics for the deal type

The **Main** section contains the following fields:

Field Name	Field Description	Mandatory (Yes or No)
Deal Type	Used to specify the deal type.	Yes
Description	Used to specify the description for the deal type.	Yes
Detailed Description	Used to specify additional information about the deal type.	No
Deal Commitment Frequency	Used to indicate the duration for the periodic analysis of deal usage as per the commitments made by the customer for calculating the deal financial summary. The valid values are: <ul style="list-style-type: none"> • Biannually • Monthly • Quarterly • Yearly 	Yes
	Note: The list includes only those values which are present in the FREQUENCY_FLG lookup field.	
Price Item Approval Required	Used to indicate whether the discretion check of an individual price item is required by the approver/user for approving the deal. The valid values are: <ul style="list-style-type: none"> • Yes • No 	Yes
Assign Only If In Range	Used to indicate whether the deal is assigned to the approver/user as per the limits set in the Approval Hierarchy section of the Deal Approval Profile screen. For example, if the deal profitability % range of the approver/user is set as follows: <ul style="list-style-type: none"> • RM (0% - 5%) • PM (6% - 15%) • SPM (16% - 50%) Then, <ul style="list-style-type: none"> • If the calculated deal profitability % is 4 %, then the deal will be assigned to the relationship manager (RM). • If the calculated deal profitability % is 11 %, then the deal will be assigned to the pricing manager (PM). • If the calculated deal profitability % is 25 %, then the deal will be assigned to the senior pricing manager (SPM). 	Yes (Conditional)
		Note: This field is required for assigning the deal when the deal financial summary falls within the specified limits defined for the approver/user.

Field Name	Field Description	Mandatory (Yes or No)
	<p>The valid values are:</p> <ul style="list-style-type: none"> • Yes • No <p>Note: This field is valid only for deal level approval profiles.</p>	
Product Level Approval Required	<p>Used to indicate whether the discretion check of the price items at the product level is required for approving a deal. The valid values are:</p> <ul style="list-style-type: none"> • Yes • No 	<p>Yes (Conditional)</p> <p>Note: This field is required for approving deal at product level.</p>
Division Level Approval Required	<p>Used to indicate whether the discretion check of the price items at the division level is required for approving a deal. The valid values are:</p> <ul style="list-style-type: none"> • Yes • No 	<p>Yes (Conditional)</p> <p>Note: This field is required for approving deal at division level.</p>
Highest Level Approval Required	<p>Used to indicate whether the hierarchical approval of the deal is required for approving a deal.</p> <p>For example, if the approval hierarchy has three levels L0 (RM), L1 (PM), and L2 (SPM), then the deal will pass through all the three levels for approval respectively. L0 (RM) will not be able to finalize the deal without the approval of L2 (SPM).</p> <p>The valid values are:</p> <ul style="list-style-type: none"> • Yes • No 	<p>Yes (Conditional)</p> <p>Note: This field is required for approving a deal by each level in the approval hierarchy.</p>
Status	<p>Used to indicate the status of the deal type. The valid values are:</p> <ul style="list-style-type: none"> • Active • Inactive <p>Note: Only an Active deal type can be used for creating a deal.</p>	Yes
Pre-Approve Existing Pricing	<p>Used to indicate whether the existing price items pricing and commitments should be pre-approved to confirm the financial summary of the deal. The valid values are:</p> <ul style="list-style-type: none"> • Yes • No 	<p>Yes (Conditional)</p> <p>Note: This field is required for approving the existing price item pricing and commitments of the entity.</p>

Field Name	Field Description	Mandatory (Yes or No)
To Do Reminder Days	Used to specify the number of days using which the system calculates the first To Do reminder date.	Yes
To Do High Priority Days	Used to specify the number of days using which the system calculates the date when the To Do reminder of highest priority should be sent. Note: You can set a maximum of 9 priority days for the To Do reminder days.	Yes
Days to Inactivate	Used to specify the number of days prior to the last updated date of the deal after which you want to inactivate the deal. Note: You must specify a numeric value greater than zero in this field. Also, the numeric value should be greater than the values specified in the To Do Reminder Days and To Do High Priority Days fields. The deal is automatically inactivated if no action is performed on the deal within the specified number of days in this field. The status of the deal is changed to Inactive when the deal inactivation date is equal to the system date.	Yes (Conditional) Note: This field is required for inactivating deals which are not updated in the system for a long time.
Reminder To Do Type	Used to indicate the To Do task that you want to send as a notification to the user for the priority days set for reviewing the deal. Note: The Search (🔍) icon appears corresponding to the Deal Monitor To Do Type field. On clicking the Search icon, the To Do Type Search window appears. On specifying the value for a To Do type, the description of the To Do type appears corresponding to the To Do Type field.	Yes
Questionnaire Template	Used to indicate the questionnaire template that you want to associate with the deal type using which the system searches for a list of deals which can be used as references while creating a deal.	Yes (Conditional) Note: This field is required for associating a questionnaire template with the deal type.

Field Name	Field Description	Mandatory (Yes or No)
	<p>Note:</p> <p>The Search (🔍) icon appears corresponding to the Questionnaire Template field. On clicking the Search icon, the Search Questionnaire Template window appears.</p> <p>On specifying the value for a questionnaire template, the description of the questionnaire template appears corresponding to the Questionnaire Template field.</p>	

4. Enter the required details in the **Main** section.
5. Associate deal approval profiles with the deal type in the **Deal Approval Profiles** section.
6. Associate algorithms with the deal type in the **Algorithms** section, if required.
7. Define characteristics for the deal type in the **Characteristics** section, if required.
8. Click **Save**.

The deal type is defined.

Related Topics

For more information on...	See...
Deal Type screen	Deal Type on page 2687
How to associate a deal approval profile with a deal type	Associating a Deal Approval Profile with a Deal Type on page 2698
How to associate an algorithm with a deal type	Associating an Algorithm with a Deal Type on page 2700
How to define a characteristic for a deal type	Defining a Characteristic for a Deal Type on page 2703

Associating a Deal Approval Profile with a Deal Type

Prerequisites

To associate a deal approval profile with a deal type, you should have:

- Approval types defined in the application
- Divisions defined in the application
- Customer segments and customer tiers defined in the application
- Products defined in the application
- Deal approval profiles defined in the application

Procedure

To associate a deal approval profile with a deal type:

1. Ensure that the **Deal Approval Profiles** section is expanded in the **Deal Type** screen when you are defining, editing, or copying a deal type.

The **Deal Approval Profiles** section contains the following fields in a grid:

Field Name	Field Description	Mandatory (Yes or No)
Effective Start Date	Used to indicate the date from when the deal approval profile is effective for the deal type.	Yes
	Note: The effective start date cannot be later than the effective end date.	
Effective End Date	Used to indicate the date till when the deal approval profile is effective for the deal type.	No
	Note: The effective end date cannot be earlier than the effective start date.	
Approval Type	Used to indicate whether the deal type is used for approving a deal in the product level approval workflow, deal level approval workflow, or division level approval workflow. The valid values are: <ul style="list-style-type: none"> • Deal • Division • Product 	Yes
Division	Used to indicate the division for which the deal level approval, division level approval, or product level approval is required.	Yes
	Note: You can only view those divisions to which you have access in the Division list.	
Customer Segment	Used to indicate the customer segment to which the deal type is associated.	Yes
	Note: This field is disabled when you select the Division or the Product option from the Approval Type field.	
Customer Tier	Used to indicate the customer tier to which the deal type is associated.	Yes
	Note: This field is disabled when you select the Division or the Product option from the Approval Type field.	
Product	Used t to indicate the product for which the product level approval is required.	Yes (Conditional)
		Note: This field is required for approving a deal in the product level approval workflow.

Field Name	Field Description	Mandatory (Yes or No)
	<p>Note:</p> <p>The Search (🔍) icon appears corresponding to the Product field. On clicking the Search icon, the Product Search window appears.</p> <p>On specifying a product, the description of the product appears corresponding to the Product field.</p> <p>This field is enabled only when you select the Product option from the Approval Type field.</p>	
Deal Approval Profile	<p>Used to indicate the approval profile which you want to use for approving the deal.</p> <p>Note:</p> <p>The Search (🔍) icon appears corresponding to the Deal Approval Profile field. On clicking the Search icon, the Deal Approval Profile Search window appears.</p> <p>On specifying the value for a deal approval profile, the description of the deal approval profile appears corresponding to the Deal Approval Profile field.</p>	Yes

- Enter the required details in the **Deal Approval Profiles** section.
- If you want to associate more than one deal approval profile with the deal type, click the **Add** (+) icon and then repeat step 2.

Note: However, if you want to disassociate a deal approval profile from the deal type, click the **Delete** (🗑️) icon corresponding to the deal approval profile.

- Click **Save**.

The deal approval profile is associated with the deal type.

Related Topics

For more information on...	See...
Deal Type screen	Deal Type on page 2687
How to define a deal type	Defining a Deal Type on page 2694
How to edit a deal type	Editing a Deal Type on page 2704
How to copy a deal type	Copying a Deal Type on page 2709

Associating an Algorithm with a Deal Type

Prerequisites

To associate an algorithm with a deal type, you should have:

- System events defined in the application
- Algorithms defined for the system events

Procedure

To associate an algorithm with a deal type:

1. Ensure that the **Algorithms** section is expanded in the **Deal Type** screen when you are defining, editing, or copying a deal type.

The **Algorithms** section contains the following fields in a grid:

Field Name	Field Description	Mandatory (Yes or No)
System Event	<p>Used to indicate the system event when the algorithm is executed. The valid values are:</p> <ul style="list-style-type: none"> • Customer/Deal References Using Quest - Used to indicate the algorithm that is triggered to search for deal references based on the questionnaire associated with the deal. • Deal Inactivation - Used to indicate the algorithm that is triggered to automatically inactivate the deals which are not updated in the system for a long time. • Hierarchy Creation Completion - Used to indicate the algorithm that is triggered for aggregating the service quantities of the customer, parent customers, grandparent customers, and sibling customers in the customer hierarchy of the deal. • Post Processing Price Item Post Simulation • Price Item Group List Filter - Used to indicate the algorithm that is triggered to select the price items and the hierarchy entities of an entity automatically based on whether the selection characteristic type specified in the parameter is defined for the respective price item and hierarchy entity. • Price Item Selection Validation - Used to indicate the algorithm that is triggered to validate the price item and hierarchy entity selection of an entity in a deal. <p>Note: The algorithm attached to the Price Item Selection Validation system event is invoked when you click the Save & View Pricing & Commitment button in the Price Item Group Selection screen of the deal.</p>	Yes

Field Name	Field Description	Mandatory (Yes or No)
	<ul style="list-style-type: none"> • Price Item Approval - Used to indicate the algorithm that is triggered for approving the price items assigned to the entities in the customer hierarchy of the deal. • Profitability Calculation - Used to indicate the algorithm that is triggered for calculating the profitability of the proposed commitments defined for the price items while simulating the deal. • Recommended Products Using Questionnaire - Used to indicate the algorithm that is triggered for searching the recommended products for the deal. • Regular Price Item Post Simulation • Simulation Completion • Standard Price List Search • Terms and Conditions Filter - Used to indicate the algorithm that is triggered for selecting the deal, price item, and hierarchy entity level terms and conditions automatically based on whether the selection characteristic type specified in the parameter is defined for the respective deal, price item, and hierarchy entity. • Terms and Conditions Search Validation - Used to indicate the algorithm that is triggered to validate the terms and conditions selection of an entity at the deal, price item, and hierarchy entity level. <div style="border: 1px solid black; padding: 5px; margin-top: 10px;"> <p>Note: The algorithm attached to the Terms and Conditions Search Validation system event is invoked when you click the Save button in the Terms and Conditions screen.</p> </div> <div style="border: 1px solid black; padding: 5px; margin-top: 10px;"> <p>Note: The list includes only those values which are specified in the DEAL_TYPE_ALG_ENT_FLG lookup field.</p> </div>	
Sequence	Used to specify the order in which the algorithms with the same system event is executed.	Yes
Algorithm	Used to indicate the algorithm attached to the system event.	Yes

Field Name	Field Description	Mandatory (Yes or No)
	<p>Note:</p> <p>The Search (🔍) icon appears corresponding to the Algorithm field. On clicking the Search icon, the Algorithm Search window appears.</p> <p>On specifying the value for an algorithm, the description of the algorithm appears corresponding to the Algorithm field.</p>	

- Enter the required details in the **Algorithms** section.
- If you want to associate more than one algorithm with the deal type, click the **Add** (+) icon and then repeat step 2.

Note: However, if you want to disassociate an algorithm from the deal type, click the **Delete** (🗑️) icon corresponding to the algorithm.

- Click **Save**.

The algorithm is associated with the deal type.

Related Topics

For more information on...	See...
Deal Type screen	Deal Type on page 2687
How to define a deal type	Defining a Deal Type on page 2694
How to edit a deal type	Editing a Deal Type on page 2704
How to copy a deal type	Copying a Deal Type on page 2709

Defining a Characteristic for a Deal Type

Prerequisites

To define a characteristic for a deal type, you should have:

- Characteristic types defined in the application (where the characteristic entity is set to **Deal Type**)

Procedure

To define a characteristic for a deal type:

- Ensure that the **Characteristics** section is expanded in the **Deal Type** screen when you are defining, editing, or copying a deal type.

The **Characteristics** section contains the following fields in a grid:

Field Name	Field Description	Mandatory (Yes or No)
Effective Date	Used to specify the date from when the characteristic is effective for the deal type.	Yes (Conditional)
		<p>Note: This field is required while defining a characteristic for the deal type.</p>

Field Name	Field Description	Mandatory (Yes or No)
Characteristic Type	Used to indicate the characteristic type.	Yes (Conditional)
	Note: The list includes only those characteristic types where the characteristic entity is set to Deal Type .	Note: This field is required while defining a characteristic for the deal type.
Characteristic Value	Used to specify the value for the characteristic type.	Yes (Conditional)
	Note: If you select a predefined characteristic type, the Search (🔍) icon appears corresponding to the Characteristic Value field. On clicking the Search icon, the Predefined Characteristic Search window appears. On specifying the value for a predefined characteristic type, the description of the characteristic value appears corresponding to the Characteristic Value field.	Note: This field is required while defining a characteristic for the deal type.

- Enter the required details in the **Characteristics** section.
- If you want to define more than one characteristic for the deal type, click the **Add** (+) icon and then repeat step 2.

Note: However, if you want to remove a characteristic from the deal type, click the **Delete** (🗑️) icon corresponding to the characteristic.

- Click **Save**.

The characteristic is defined for the deal type.

Related Topics

For more information on...	See...
Deal Type screen	Deal Type on page 2687
How to define a deal type	Defining a Deal Type on page 2694
How to edit a deal type	Editing a Deal Type on page 2704
How to copy a deal type	Copying a Deal Type on page 2709

Editing a Deal Type

Prerequisites

To edit a deal type you should have:

- Deal approval profiles defined in the application
- Values defined for the **FREQUENCY_FLG** lookup field.
- Deal approval profiles defined in the application

- Algorithms defined in the system
- Algorithms associated with the system events
- Characteristic types defined in the application (where the characteristic entity is set to **Deal Type**).
- Reminder To Do types defined in the application
- Questionnaire templates defined in the application

Procedure

To edit a deal type:

1. Click the **Admin** link in the **Application** toolbar.
A list appears.
2. From the **Admin** menu, select **D** and then click **Deal Type**.
A sub-menu appears.
3. Click the **Search** option from the **Deal Type** sub-menu.
The **Deal Type** screen appears.
4. In the **Deal Type List** zone, click the **Edit** (✎) icon in the **Edit** column corresponding to the deal type whose details you want to edit.

The **Deal Type** screen appears. It contains the following sections:

- **Main** - Used to specify basic details about the deal type.
- **Deal Approval Profiles** - Used to associate deal level, division level, or product level approval profiles with the deal type for approving the deal.
- **Algorithms** - Used to associate algorithms with the system events defined for the deal type
- **Characteristics** - Used to define the characteristics for the deal type

The **Main** section contains the following fields:

Field Name	Field Description	Mandatory (Yes or No)
Deal Type	Used to specify the deal type.	Not Applicable
Description	Used to specify the description for the deal type.	Yes
Detailed Description	Used to specify additional information about the deal type.	No
Deal Commitment Frequency	Used to indicate the duration for the periodic analysis of deal usage as per the commitments made by the customer for calculating the deal financial summary. The valid values are: <ul style="list-style-type: none"> • Biannually • Monthly • Quarterly • Yearly 	Yes
	Note: The list includes only those values which are present in the FREQUENCY_FLG lookup field.	

Field Name	Field Description	Mandatory (Yes or No)
Price Item Approval Required	Used to indicate whether the discretion check of an individual price item is required by the approver/user for approving the deal. The valid values are: <ul style="list-style-type: none"> • Yes • No 	Yes
Assign Only If In Range	Used to indicate whether the deal is assigned to the approver/user as per the limits set in the Approval Hierarchy section of the Deal Approval Profile screen. For example, if the deal profitability % range of the approver/user is set as follows: <ul style="list-style-type: none"> • RM (0% - 5%) • PM (6% - 15%) • SPM (16% - 50%) Then, <ul style="list-style-type: none"> • If the calculated deal profitability % is 4 %, then the deal will be assigned to the relationship manager (RM). • If the calculated deal profitability % is 11 %, then the deal will be assigned to the pricing manager (PM). • If the calculated deal profitability % is 25 %, then the deal will be assigned to the senior pricing manager (SPM). The valid values are: <ul style="list-style-type: none"> • Yes • No 	Yes (Conditional) Note: This field is required for assigning the deal when the deal financial summary falls within the specified limits defined for the approver/user.
Product Level Approval Required	Used to indicate whether the discretion check of the price items at the product level is required for approving a deal. The valid values are: <ul style="list-style-type: none"> • Yes • No 	Yes (Conditional) Note: This field is required for approving deal at product level.
Division Level Approval Required	Used to indicate whether the discretion check of the price items at the division level is required for approving a deal. The valid values are: <ul style="list-style-type: none"> • Yes • No 	Yes (Conditional) Note: This field is required for approving deal at division level.

Field Name	Field Description	Mandatory (Yes or No)
Highest Level Approval Required	<p>Used to indicate whether the hierarchical approval of the deal is required for approving a deal.</p> <p>For example, if the approval hierarchy has three levels L0 (RM), L1 (PM), and L2 (SPM), then the deal will pass through all the three levels for approval respectively. L0 (RM) will not be able to finalize the deal without the approval of L2 (SPM).</p> <p>The valid values are:</p> <ul style="list-style-type: none"> • Yes • No 	Yes (Conditional)
		<p>Note: This field is required for approving a deal by each level in the approval hierarchy.</p>
Status	<p>Used to indicate the status of the deal type. The valid values are:</p> <ul style="list-style-type: none"> • Active • Inactive 	Yes
	<p>Note: Only an Active deal type can be used for creating a deal.</p>	
Pre-Approve Existing Pricing	<p>Used to indicate whether the existing price items pricing and commitments should be pre-approved to confirm the financial summary of the deal. The valid values are:</p> <ul style="list-style-type: none"> • Yes • No 	Yes (Conditional)
		<p>Note: This field is required for approving the existing price item pricing and commitments of the entity.</p>
To Do Reminder Days	<p>Used to specify the number of days using which the system calculates the first To Do reminder date.</p>	Yes
To Do High Priority Days	<p>Used to specify the number of days using which the system calculates the date when the To Do reminder of highest priority should be sent.</p>	Yes
	<p>Note: You can set a maximum of 9 priority days for the To Do reminder days.</p>	
Days to Inactivate	<p>Used to specify the number of days prior to the last updated date of the deal after which you want to inactivate the deal.</p>	Yes (Conditional)
		<p>Note: This field is required for inactivating deals which are not updated in the system for a long time.</p>

Field Name	Field Description	Mandatory (Yes or No)
	<p>Note:</p> <p>You must specify a numeric value greater than zero in this field. Also, the numeric value should be greater than the values specified in the To Do Reminder Days and To Do High Priority Days fields.</p> <p>The deal is automatically inactivated if no action is performed on the deal within the specified number of days in this field.</p> <p>The status of the deal is changed to Inactive when the deal inactivation date is equal to the system date.</p>	
Reminder To Do Type	<p>Used to indicate the To Do task that you want to send as a notification to the user for the priority days set for reviewing the deal.</p> <p>Note:</p> <p>The Search (🔍) icon appears corresponding to the Deal Monitor To Do Type field. On clicking the Search icon, the To Do Type Search window appears.</p> <p>On specifying the value for a To Do type, the description of the To Do type appears corresponding to the To Do Type field.</p>	Yes
Questionnaire Template	<p>Used to indicate the questionnaire template that you want to associate with the deal type using which the system searches for a list of deals which can be used as references while creating a deal.</p> <p>Note:</p> <p>The Search (🔍) icon appears corresponding to the Questionnaire Template field. On clicking the Search icon, the Search Questionnaire Template window appears.</p> <p>On specifying the value for a questionnaire template, the description of the questionnaire template appears corresponding to the Questionnaire Template field.</p>	<p>Yes (Conditional)</p> <p>Note: This field is required for associating a questionnaire template with the deal type.</p>

5. Modify the required details in the **Main** section.

Note: You cannot edit the fields from the **Main** section when a deal is already created using the deal type.

6. Associate or disassociate deal approval profiles from the deal type, if required.
7. Associate or disassociate algorithms from the deal type, if required.

8. Define, edit, or remove characteristics from the deal type, if required.
9. Click **Save**.

The changes made to the deal type are saved.

Tip: Alternatively, you can edit the details of a deal type by clicking the **Edit** button in the **Deal Type** zone.

Related Topics

For more information on...	See...
Deal Type screen	Deal Type on page 2687
Deal Type List zone	Deal Type List on page 2688
How to associate a deal approval profile with a deal type	Associating a Deal Approval Profile with a Deal Type on page 2698
How to associate an algorithm with a deal type	Associating an Algorithm with a Deal Type on page 2700
How to define a characteristic for a deal type	Defining a Characteristic for a Deal Type on page 2703

Copying a Deal Type

Instead of creating a deal type from scratch, you can create a new deal type using an existing deal type. This is possible through copying a deal type. On copying a deal type, the details including the deal approval profiles, algorithms, and characteristics are copied to the new deal type. You can then edit the details, if required.

Prerequisites

To copy a deal type you should have:

- Deal type (whose copy you want to create) defined in the application
- Values defined for the **FREQUENCY_FLG** lookup field.
- Deal approval profiles defined in the application
- Algorithms defined in the system
- Algorithms associated with the system events
- Characteristic types defined in the application (where the characteristic entity is set to **Deal Type**).
- Deal monitor To Do types defined in the application
- Questionnaire templates defined in the application

Procedure

To copy a deal type:

1. Click the **Admin** link in the **Application** toolbar.
A list appears.
2. From the **Admin** menu, select **D** and then click **Deal Type**.
A sub-menu appears.
3. Click the **Search** option from the **Deal Type** sub-menu.
The **Deal Type** screen appears.

4. In the **Deal Type List** zone, click the **Duplicate** () icon in the **Duplicate** column corresponding to the deal type whose copy you want to create.

The **Deal Type** screen appears. It contains the following sections:

- **Main** - Used to specify basic details about the deal type.
- **Deal Approval Profiles** - Used to associate deal level, division level, or product level approval profiles with the deal type for approving the deal.
- **Algorithms** - Used to associate algorithms with the system events defined for the deal type
- **Characteristics** - Used to define the characteristics for the deal type

The **Main** section contains the following fields:

Field Name	Field Description	Mandatory (Yes or No)
Deal Type	Used to specify the deal type.	Yes
Description	Used to specify the description for the deal type.	Yes
Detailed Description	Used to specify additional information about the deal type.	No
Deal Commitment Frequency	Used to indicate the duration for the periodic analysis of deal usage as per the commitments made by the customer for calculating the deal financial summary. The valid values are: <ul style="list-style-type: none"> • Biannually • Monthly • Quarterly • Yearly 	Yes
	Note: The list includes only those values which are present in the FREQUENCY_FLG lookup field.	
Price Item Approval Required	Used to indicate whether the discretion check of an individual price item is required by the approver/user for approving the deal. The valid values are: <ul style="list-style-type: none"> • Yes • No 	Yes
Assign Only If In Range	Used to indicate whether the deal is assigned to the approver/user as per the limits set in the Approval Hierarchy section of the Deal Approval Profile screen. For example, if the deal profitability % range of the approver/user is set as follows: <ul style="list-style-type: none"> • RM (0% - 5%) • PM (6% - 15%) • SPM (16% - 50%) Then,	Yes (Conditional)
	Note: This field is required for assigning the deal when the deal financial summary falls within the specified limits defined for the approver/user.	

Field Name	Field Description	Mandatory (Yes or No)
	<ul style="list-style-type: none"> • If the calculated deal profitability % is 4 %, then the deal will be assigned to the relationship manager (RM). • If the calculated deal profitability % is 11 %, then the deal will be assigned to the pricing manager (PM). • If the calculated deal profitability % is 25 %, then the deal will be assigned to the senior pricing manager (SPM). <p>The valid values are:</p> <ul style="list-style-type: none"> • Yes • No <p>Note: This field is valid only for deal level approval profiles.</p>	
Product Level Approval Required	<p>Used to indicate whether the discretion check of the price items at the product level is required for approving a deal. The valid values are:</p> <ul style="list-style-type: none"> • Yes • No 	<p>Yes (Conditional)</p> <p>Note: This field is required for approving deal at product level.</p>
Division Level Approval Required	<p>Used to indicate whether the discretion check of the price items at the division level is required for approving a deal. The valid values are:</p> <ul style="list-style-type: none"> • Yes • No 	<p>Yes (Conditional)</p> <p>Note: This field is required for approving deal at division level.</p>
Highest Level Approval Required	<p>Used to indicate whether the hierarchical approval of the deal is required for approving a deal.</p> <p>For example, if the approval hierarchy has three levels L0 (RM), L1 (PM), and L2 (SPM), then the deal will pass through all the three levels for approval respectively. L0 (RM) will not be able to finalize the deal without the approval of L2 (SPM).</p> <p>The valid values are:</p> <ul style="list-style-type: none"> • Yes • No 	<p>Yes (Conditional)</p> <p>Note: This field is required for approving a deal by each level in the approval hierarchy.</p>
Status	<p>Used to indicate the status of the deal type. The valid values are:</p> <ul style="list-style-type: none"> • Active • Inactive 	<p>Yes</p>

Field Name	Field Description	Mandatory (Yes or No)
	Note: Only an Active deal type can be used for creating a deal.	
Pre-Approve Existing Pricing	Used to indicate whether the existing price items pricing and commitments should be pre-approved to confirm the financial summary of the deal. The valid values are: <ul style="list-style-type: none"> • Yes • No 	Yes (Conditional)
		Note: This field is required for approving the existing price item pricing and commitments of the entity.
To Do Reminder Days	Used to specify the number of days using which the system calculates the first To Do reminder date.	Yes
To Do High Priority Days	Used to specify the number of days using which the system calculates the date when the To Do reminder of highest priority should be sent.	Yes
	Note: You can set a maximum of 9 priority days for the To Do reminder days.	
Days to Inactivate	Used to specify the number of days prior to the last updated date of the deal after which you want to inactivate the deal.	Yes (Conditional)
	Note: You must specify a numeric value greater than zero in this field. Also, the numeric value should be greater than the values specified in the To Do Reminder Days and To Do High Priority Days fields. The deal is automatically inactivated if no action is performed on the deal within the specified number of days in this field. The status of the deal is changed to Inactive when the deal inactivation date is equal to the system date.	Note: This field is required for inactivating deals which are not updated in the system for a long time.
Deal Monitor To Do Type	Used to indicate the To Do task that you want to send as a notification to the user for the priority days set for reviewing the deal.	Yes

Field Name	Field Description	Mandatory (Yes or No)
	<p>Note:</p> <p>The Search (🔍) icon appears corresponding to the Deal Monitor To Do Type field. On clicking the Search icon, the To Do Type Search window appears.</p> <p>On specifying the value for a To Do type, the description of the To Do type appears corresponding to the To Do Type field.</p>	
Questionnaire Template	<p>Used to indicate the questionnaire template that you want to associate with the deal type using which the system searches for a list of deals which can be used as references while creating a deal.</p> <p>Note:</p> <p>The Search (🔍) icon appears corresponding to the Questionnaire Template field. On clicking the Search icon, the Search Questionnaire Template window appears.</p> <p>On specifying the value for a questionnaire template, the description of the questionnaire template appears corresponding to the Questionnaire Template field.</p>	<p>Yes (Conditional)</p> <p>Note: This field is required for associating a questionnaire template with the deal type.</p>

5. Enter the required details in the **Main** section.
6. Associate or disassociate deal approval profiles from the deal type, if required.
7. Associate or disassociate algorithms from the deal type, if required.
8. Define, edit, or remove characteristics of the deal type, if required.
9. Click **Save**.

The new deal type is defined.

Tip: Alternatively, you can copy a deal type by clicking the **Duplicate** button in the **Deal Type** zone.

Related Topics

For more information on...	See...
Deal Type screen	Deal Type on page 2687
Deal Type List zone	Deal Type List on page 2688
How to associate a deal approval profile with a deal type	Associating a Deal Approval Profile with a Deal Type on page 2698
How to associate an algorithm with a deal type	Associating an Algorithm with a Deal Type on page 2700

For more information on...	See...
How to define a characteristic for a deal type	Defining a Characteristic for a Deal Type on page 2703

Deleting a Deal Type

Procedure

To delete a deal type:

1. Click the **Admin** link in the **Application** toolbar.
A list appears.
2. From the **Admin** menu, select **D** and then click **Deal Type**.
A sub-menu appears.
3. Click the **Search** option from the **Deal Type** sub-menu.
The **Deal Type** screen appears.
4. In the **Deal Type List** zone, click the **Delete** () icon in the **Delete** column corresponding to the deal type that you want to delete.
A message appears confirming whether you want to delete the deal type.

Note: You can delete a deal type only when the deal type is not yet used for creating a deal.

Tip: Alternatively, you can delete a deal type by clicking the **Delete** button in the **Deal Type** zone.

5. Click **OK**.
The deal type is deleted.

Related Topics

For more information on...	See...
Deal Type screen	Deal Type on page 2687
Deal Type List zone	Deal Type List on page 2688

Viewing the Details of a Deal Type

Procedure

To view the details of type details:

1. Click the **Admin** link in the **Application** toolbar.
A list appears.
2. From the **Admin** menu, select **D** and then click **Deal Type**.
A sub-menu appears.
3. Click the **Search** option from the **Deal Type** sub-menu.
The **Deal Type** screen appears.
4. In the **Deal Type List** zone, click the **Broadcast** () icon corresponding to the deal type whose details you want to view.
The **Deal Type** zone appears.

- View the details of the deal type in the **Deal Type** zone.

Related Topics

For more information on...	See...
Deal Type screen	Deal Type on page 2687
Deal Type List zone	Deal Type List on page 2688
Deal Type zone	Deal Type on page 2688

Questionnaire Template (Used for Searching)

The **Questionnaire Template** screen allows you to search for a questionnaire template using various search criteria. It also allows you to define, edit, copy, delete, and preview a questionnaire template. It contains the following zone:

- [Search Questionnaire Template](#) on page 2715

Through this screen, you can navigate to the following screen:

- [Questionnaire Template \(Used for Viewing\)](#) on page 2733

Search Questionnaire Template

The **Search Questionnaire Template** zone allows you to search for a questionnaire template using various search criteria. It also allows you to edit, copy, delete, and preview an existing questionnaire template. It contains the following sections:

- Search Criteria** - The **Search Criteria** section contains the following fields:

Field Name	Field Description	Mandatory (Yes or No)
Questionnaire Template	Used to search a particular questionnaire template.	No
Description	Used to search questionnaire templates having a particular description.	No
Start Date	Used to search questionnaire templates which are effective from a particular date onwards.	No
End Date	Used to search questionnaire templates which are effective till a particular date.	No

- Search Results** - On clicking the **Search** button, the search results appear based on the specified search criteria. The **Search Results** section contains the following columns:

Column Name	Column Description
Questionnaire Template Information	Displays the concatenated string of information about the questionnaire template separated by a comma (.). Note: It has a link. On clicking the link, the Questionnaire Template screen appears where you can view the details of the respective questionnaire template.
Description	Displays the description of the questionnaire template.
Start Date	Displays the date from when the questionnaire template is effective.

Column Name	Column Description
End Date	Displays the date till when the questionnaire template is effective.
Edit	On clicking the Edit (✎) icon, the Questionnaire Template screen appears where you can edit the questionnaire template details.
Duplicate	On clicking the Duplicate (📄) icon, the Questionnaire Template screen appears where you can define a questionnaire template using an existing questionnaire template.
Delete	On clicking the Delete (🗑) icon, you can delete the questionnaire template.
Preview	On clicking the Preview (🔍) icon, Preview Questionnaire Template screen appears where you can preview the questions of a questionnaire template.

Note: Pagination is used to display limited number of records in the **Search Results** section. You can use the navigation links, such as **Previous** and **Next** to navigate between pages.

By default, the **Filter** area is hidden. You can view the **Filter** area by clicking the **Filters** (🔍) icon in the upper right corner of this zone.

Related Topics

For more information on...	See...
How to search for a questionnaire template	Searching for a Questionnaire Template on page 2716
How to edit a questionnaire template	Editing a Questionnaire Template on page 2722
How to delete a questionnaire template	Deleting a Questionnaire Template on page 2731
How to copy a questionnaire template	Copying a Questionnaire Template on page 2726
How to preview a questionnaire template	Previewing a Questionnaire Template on page 2732
How to view the details of a questionnaire template	Viewing the Details of a Questionnaire Template on page 2732

Searching for a Questionnaire Template

Procedure

To search for a questionnaire template:

1. Click the **Admin** link in the **Application** toolbar.
A list appears.
2. From the **Admin** menu, select **Q** and then click **Questionnaire Template**.
A sub-menu appears.
3. Click the **Search** option from the **Questionnaire Template** sub-menu.
The **Questionnaire Template** screen appears.
4. Enter the required details in the **Search Questionnaire Template** zone.
5. Click **Search**.

A list of questionnaire templates that meet the search criteria appears in the **Search Results** section.

Related Topics

For more information on...	See...
Questionnaire Template screen	Questionnaire Template (Used for Searching) on page 2715
Search Questionnaire Template zone	Search Questionnaire Template on page 2715

Defining a Questionnaire Template**Prerequisites**

To define a questionnaire template you should have:

- Questions defined in the application.
- Reference tables and reference columns defined in the application.
- Validation algorithms defined in the application.
- Reference parameter defined in the application.
- Rule types defined in the application.
- Values defined for the **DEAL_QUE_DISP_FLG**, **ANS_DISPLAY_FLG** and **APPLICABLE_FOR_FLG** lookup fields.

Procedure

To define a questionnaire template:

1. Click the **Admin** link in the **Application** toolbar.
A list appears.
2. From the **Admin** menu, select **Q** and then click **Questionnaire Template**.
A sub-menu appears.
3. Click the **Add** option from the **Questionnaire Template** sub-menu.

The **Questionnaire Template** screen appears. It contains the following sections:

- **Main** - Used to specify basic details about the questionnaire template. It contains the following fields:

Field Name	Field Description	Mandatory (Yes or No)
Questionnaire Template	Used to specify the questionnaire template.	Yes
Description	Used to specify the description for the questionnaire template.	Yes
Start Date	Used to specify the date from when the questionnaire template is effective.	Yes
End Date	Used to specify the date till when the questionnaire template is effective.	No
Question Display Order	Used to indicate the order in which the questions of the questionnaire template should appear in the Questionnaire Template screen. The valid values are: <ul style="list-style-type: none"> • Rule based • Sequence based 	Yes

- **Questions** - Used to associate the rule based or sequence based questions with the questionnaire template. It contains the following fields:

Field Name	Field Description	Mandatory (Yes or No)
Question	<p>Used to specify the question that you want to associate with the questionnaire template.</p> <p>Note: The Search (🔍) icon appears corresponding to this field. On clicking the Search icon, the Question Search window appears where you can search for a question.</p>	Yes
Question Text	Used to specify the question statement.	Yes
Sequence	Used to specify the sequence number of the question.	Yes
Answer Type	<p>Used to indicate the type in which you want to select the answer for the question. The valid values are:</p> <ul style="list-style-type: none"> • Date • Decimal Value • Multi Selection Check Box List • Multi Selection from Drop Down List • Numeric Value • Percentage • Radio Button List • Single Selection Drop Down List • Text 	Yes
Answer Value Set	<p>Indicates the references from where you want to search for the answer of the question. The valid values are:</p> <ul style="list-style-type: none"> • Reference Data <ul style="list-style-type: none"> - Used to indicate that you want to search for the answer from a specific reference table given in the system. <p>Note: This field is disabled when you select the Date, Decimal Value, Numeric Value, Percentage, or Text option from the Answer Type list.</p> <ul style="list-style-type: none"> • Predefined List 	Yes (Conditional)

Field Name	Field Description	Mandatory (Yes or No)
	<p>- Used to indicate that you want to search for the answer from a predefined list defined in the system.</p> <div data-bbox="800 348 1166 520" style="border: 1px solid black; padding: 5px;"> <p>Note: This field is disabled when you select the Date, Decimal Value, Numeric Value, Percentage, or Text option from the Answer Type list.</p> </div>	
Reference Table	<p>Used to indicate a specific table that you want to set as a source for searching the answer of the question.</p> <div data-bbox="732 680 1166 1150" style="border: 1px solid black; padding: 5px;"> <p>Note:</p> <p>The Search (🔍) icon appears corresponding to this field. On clicking the Search icon, the Table Search window appears.</p> <p>On specifying the table, the description of the table appears corresponding to the Reference Table field.</p> <p>This field is enabled only when the Reference Data option radio button is selected from the Answer Value Set field.</p> </div>	<p>Yes (Conditional)</p> <div data-bbox="1170 617 1468 758" style="border: 1px solid black; padding: 5px;"> <p>Note: This field is required for searching the answer from a reference table.</p> </div>
Reference Column	<p>Used to indicate the column in the reference table from where you want to search for the answer of the question.</p> <div data-bbox="732 1293 1166 1764" style="border: 1px solid black; padding: 5px;"> <p>Note:</p> <p>The Search (🔍) icon appears corresponding to this field. On clicking the Search icon, the Column Search window appears.</p> <p>On specifying the column, the description of the column appears corresponding to the Reference Column field.</p> <p>This field is enabled only when the Reference Data option radio button is selected from the Answer Value Set field.</p> </div>	<p>Yes (Conditional)</p> <div data-bbox="1170 1230 1468 1371" style="border: 1px solid black; padding: 5px;"> <p>Note: This field is required for searching the answer from a reference table.</p> </div>
Reference Criteria	Used to specify the criteria based on which you want to search for the answer from the given reference.	No

Field Name	Field Description	Mandatory (Yes or No)
Validation Algorithm	Used to indicate the algorithm that you want to use for validating the answer of the question.	Yes
	Note: The Search (🔍) icon appears corresponding to this field. On clicking the Search icon, the Algorithm Search window appears where you can search for an algorithm.	
Default Answer	Used to specify the answer that you want to set as default for the question.	No
Mandatory	Used to indicate whether the question is mandatory or not.	No
	Note: On selecting the check box of the Mandatory field, the question appears with an asterisk (*) sign in the questionnaire template.	
Reference Parameter	Used to indicate the parameter which is used to check the eligibility while recommending the reference customers / products / packages.	No
	Note: The Search (🔍) icon appears corresponding to this field. On clicking the Search icon, the Parameter Search window appears. On specifying the parameter, the description of the parameter appears corresponding to the Reference Parameter field.	
Rule Type	Used to indicate the rule type using which the next question appears in the Questionnaire Template screen.	Yes (Conditional)
		Note: This field is used for displaying the next question based on the answer provided for the previous question in the questionnaire template.

Field Name	Field Description	Mandatory (Yes or No)
	<p>Note:</p> <p>The Search (🔍) icon appears corresponding to this field. On clicking the Search icon, the Rule Type Search window appears.</p> <p>On specifying the rule type, the description of the rule type appears corresponding to the Rule Type field.</p> <p>This field is used when the Question Display Order is selected as Rule Based.</p>	
Question Applicability	<p>Used to indicate the question applicability based on which the references are derived. The valid values are:</p> <ul style="list-style-type: none"> • Customer and Deal References • Package and Product References • Others 	Yes
Predefined Value	<p>Used to specify the predefined list from where you want the system to search the answer for a question.</p> <p>Note: This field is enabled when the Predefined List option radio button is selected from the Answer Value Set field.</p>	<p>Yes (Conditional).</p> <p>Note: This field is required for searching the answer from a predefined list.</p>
Description	<p>Used to specify the description of the predefined list.</p>	<p>Yes (Conditional)</p> <p>Note: This field is required for searching the answer from a predefined list.</p>

4. Enter the required details in the **Main** section.
5. Define questions for the questionnaire template in the **Questions** section.
6. If you want to define more than one question for the questionnaire template, click the **Add** (+) icon in the **Questions** section.

Note: However, if you want to remove a question from the questionnaire template, click the **Delete** (🗑️) icon in the **Questions** section.

7. Click **Save**.

The questionnaire template is defined.

Related Topics

For more information on...	See...
Questionnaire Template screen	Questionnaire Template (Used for Searching) on page 2715

Editing a Questionnaire Template

Prerequisites

To edit a questionnaire template you should have:

- Questions defined in the application.
- Reference tables and reference columns defined in the application.
- Validation algorithms defined in the application.
- Reference parameter defined in the application.
- Rule types defined in the application.
- Values defined for the **DEAL_QUE_DISP_FLG**, **ANS_DISPLAY_FLG** and **APPLICABLE_FOR_FLG** lookup fields.

Procedure

To edit a questionnaire template:

1. Search for the questionnaire template in the **Questionnaire Template** screen.
2. In the **Search Results** section, click the **Edit** (✎) icon in the **Edit** column corresponding to the questionnaire template whose details you want to edit.

The **Questionnaire Template** screen appears. It contains the following sections:

- **Main** - Used to specify basic details about the questionnaire template. It contains the following fields:

Field Name	Field Description	Mandatory (Yes or No)
Questionnaire Template	Used to specify the questionnaire template.	Not applicable
Description	Used to specify the description for the questionnaire template.	No
Start Date	Used to specify the date from when the questionnaire template is effective.	Yes
End Date	Used to specify the date till when the questionnaire template is effective.	No
Question Display Order	Used to indicate the order in which the questions of the questionnaire template should appear in the Questionnaire Template screen. The valid values are: <ul style="list-style-type: none"> • Rule based • Sequence based 	Yes

- **Questions** - Used to associate the rule based or sequence based questions with the questionnaire template. It contains the following fields:

Field Name	Field Description	Mandatory (Yes or No)
Question	Used to specify the question that you want to associate with the questionnaire template.	Yes
	Note: The Search (🔍) icon appears corresponding to this field. On clicking the Search icon, the Question Search window appears where you can search for a question.	
Question Text	Used to specify the question statement.	Yes
Sequence	Used to specify the sequence number of the question.	Yes
Answer Type	Used to indicate the type in which you want to select the answer for the question. The valid values are: <ul style="list-style-type: none"> • Date • Decimal Value • Multi Selection Check Box List • Multi Selection from Drop Down List • Numeric Value • Percentage • Radio Button List • Single Selection Drop Down List • Text 	Yes
Answer Value Set	Indicates the references from where you want to search for the answer of the question. The valid values are: <ul style="list-style-type: none"> • Reference Data <ul style="list-style-type: none"> - Used to indicate that you want to search for the answer from a specific reference table given in the system. 	Yes (Conditional)
	<p>Note: This field is disabled when you select the Date, Decimal Value, Numeric Value, Percentage, or Text option from the Answer Type list.</p> <ul style="list-style-type: none"> • Predefined List <ul style="list-style-type: none"> - Used to indicate that you want to search for the answer from a predefined list defined in the system. 	

Field Name	Field Description	Mandatory (Yes or No)
	<p>Note: This field is disabled when you select the Date, Decimal Value, Numeric Value, Percentage, or Text option from the Answer Type list.</p>	
Reference Table	<p>Used to indicate a specific table that you want to set as a source for searching the answer of the question.</p> <p>Note:</p> <p>The Search (🔍) icon appears corresponding to this field. On clicking the Search icon, the Table Search window appears.</p> <p>On specifying the table, the description of the table appears corresponding to the Reference Table field.</p> <p>This field is enabled only when the Reference Data option radio button is selected from the Answer Value Set field.</p>	<p>Yes (Conditional)</p> <p>Note: This field is required for searching the answer from a reference table.</p>
Reference Column	<p>Used to indicate the column in the reference table from where you want to search for the answer of the question.</p> <p>Note:</p> <p>The Search (🔍) icon appears corresponding to this field. On clicking the Search icon, the Column Search window appears.</p> <p>On specifying the column, the description of the column appears corresponding to the Reference Column field.</p> <p>This field is enabled only when the Reference Data option radio button is selected from the Answer Value Set field.</p>	<p>Yes (Conditional)</p> <p>Note: This field is required for searching the answer from a reference table.</p>
Reference Criteria	<p>Used to specify the criteria based on which you want to search for the answer from the given reference.</p>	No
Validation Algorithm	<p>Used to indicate the algorithm that you want to use for validating the answer of the question.</p>	Yes

Field Name	Field Description	Mandatory (Yes or No)
	<p>Note: The Search (🔍) icon appears corresponding to this field. On clicking the Search icon, the Algorithm Search window appears where you can search for an algorithm.</p>	
Default Answer	Used to specify the answer that you want to set as default for the question.	No
Mandatory	<p>Used to indicate whether the question is mandatory or not.</p> <p>Note: On selecting the check box of the Mandatory field, the question appears with an asterisk (*) sign in the questionnaire template.</p>	No
Reference Parameter	<p>Used to indicate the parameter which is used to check the eligibility while recommending the reference customers / products / packages.</p> <p>Note:</p> <p>The Search (🔍) icon appears corresponding to this field. On clicking the Search icon, the Parameter Search window appears.</p> <p>On specifying the parameter, the description of the parameter appears corresponding to the Reference Parameter field.</p>	No
Rule Type	<p>Used to indicate the rule type using which the next question appears in the Questionnaire Template screen.</p> <p>Note:</p> <p>The Search (🔍) icon appears corresponding to this field. On clicking the Search icon, the Rule Type Search window appears.</p> <p>On specifying the rule type, the description of the rule type appears corresponding to the Rule Type field.</p> <p>This field is used when the Question Display Order is selected as Rule Based.</p>	<p>Yes (Conditional)</p> <p>Note: This field is used for displaying the next question based on the answer provided for the previous question in the questionnaire template.</p>

Field Name	Field Description	Mandatory (Yes or No)
Question Applicability	Used to indicate the question applicability based on which the references are derived. The valid values are: <ul style="list-style-type: none"> • Customer and Deal References • Package and Product References • Others 	Yes
Predefined Value	Used to specify the predefined list from where you want the system to search the answer for a question.	Yes (Conditional).
	Note: This field is enabled when the Predefined List option radio button is selected from the Answer Value Set field.	Note: This field is required for searching the answer from a predefined list.
Description	Used to specify the description of the predefined list.	Yes (Conditional)
		Note: This field is required for searching the answer from a predefined list.

3. Modify the required details in the **Main** section.
4. Add, edit, or remove questions from the questionnaire template, if required.

Note: Click the **Previous** (←) or **Next** (→) icons in the **Questions** section to navigate through the existing questions of the questionnaire template which you want to edit or delete.

5. Click **Save**.

The changes made to the questionnaire template are saved.

Tip: Alternatively, you can edit the details of a questionnaire template by clicking the **Edit** button in the **Questionnaire Template** zone of the **Questionnaire Template** screen.

Related Topics

For more information on...	See...
How to search for a questionnaire template	Searching for a Questionnaire Template on page 2716
Search Questionnaire Template zone	Search Questionnaire Template on page 2715
Questionnaire Template screen	Questionnaire Template (Used for Searching) on page 2715
Questionnaire Template zone	Questionnaire Template on page 2733
How to define a questionnaire template	Defining a Questionnaire Template on page 2717

Copying a Questionnaire Template

Instead of creating a questionnaire template from scratch, you can create a new questionnaire template using an existing questionnaire template. This is possible through copying a questionnaire template. On copying a

questionnaire template, the details including the questions are copied to the new questionnaire template. You can then edit the details, if required.

Prerequisites

To copy a questionnaire template you should have:

- Questions defined in the application.
- Reference tables and reference columns defined in the application.
- Validation algorithms defined in the application.
- Reference parameter defined in the application.
- Rule types defined in the application.
- Values defined for the **DEAL_QUE_DISP_FLG**, **ANS_DISPLAY_FLG** and **APPLICABLE_FOR_FLG** lookup fields.

Procedure

To copy a questionnaire template:

1. Search for the questionnaire template in the **Questionnaire Template** screen.
2. In the **Search Results** section, click the **Duplicate**  icon in the **Duplicate** column corresponding to the questionnaire template whose copy you want to create.

The **Questionnaire Template** screen appears. It contains the following sections:

- **Main** - Used to specify basic details about the questionnaire template. It contains the following fields:

Field Name	Field Description	Mandatory (Yes or No)
Questionnaire Template	Used to specify the questionnaire template.	Yes
Description	Used to specify the description for the questionnaire template.	Yes
Start Date	Used to specify the date from when the questionnaire template is effective.	Yes
End Date	Used to specify the date till when the questionnaire template is effective.	No
Question Display Order	Used to indicate the order in which the questions of the questionnaire template should appear in the Questionnaire Template screen. The valid values are: <ul style="list-style-type: none"> • Rule based • Sequence based 	Yes

- **Questions** - Used to associate the rule based or sequence based questions with the questionnaire template. It contains the following fields:

Field Name	Field Description	Mandatory (Yes or No)
Question	Used to specify the question that you want to associate with the questionnaire template.	Yes

Field Name	Field Description	Mandatory (Yes or No)
	<p>Note: The Search (🔍) icon appears corresponding to this field. On clicking the Search icon, the Question Search window appears where you can search for a question.</p>	
Question Text	Used to specify the question statement.	Yes
Sequence	Used to specify the sequence number of the question.	Yes
Answer Type	<p>Used to indicate the type in which you want to select the answer for the question. The valid values are:</p> <ul style="list-style-type: none"> • Date • Decimal Value • Multi Selection Check Box List • Multi Selection from Drop Down List • Numeric Value • Percentage • Radio Button List • Single Selection Drop Down List • Text 	Yes
Answer Value Set	<p>Indicates the references from where you want to search for the answer of the question. The valid values are:</p> <ul style="list-style-type: none"> • Reference Data <ul style="list-style-type: none"> - Used to indicate that you want to search for the answer from a specific reference table given in the system. <p>Note: This field is disabled when you select the Date, Decimal Value, Numeric Value, Percentage, or Text option from the Answer Type list.</p> <ul style="list-style-type: none"> • Predefined List <ul style="list-style-type: none"> - Used to indicate that you want to search for the answer from a predefined list defined in the system. 	<p>Yes (Conditional)</p> <p>Note: This field is required for searching answers from a given reference.</p>

Field Name	Field Description	Mandatory (Yes or No)
	<p>Note: This field is disabled when you select the Date, Decimal Value, Numeric Value, Percentage, or Text option from the Answer Type list.</p>	
Reference Table	<p>Used to indicate a specific table that you want to set as a source for searching the answer of the question.</p> <p>Note:</p> <p>The Search (🔍) icon appears corresponding to this field. On clicking the Search icon, the Table Search window appears.</p> <p>On specifying the table, the description of the table appears corresponding to the Reference Table field.</p> <p>This field is enabled only when the Reference Data option radio button is selected from the Answer Value Set field.</p>	<p>Yes (Conditional)</p> <p>Note: This field is required for searching the answer from a reference table.</p>
Reference Column	<p>Used to indicate the column in the reference table from where you want to search for the answer of the question.</p> <p>Note:</p> <p>The Search (🔍) icon appears corresponding to this field. On clicking the Search icon, the Column Search window appears.</p> <p>On specifying the column, the description of the column appears corresponding to the Reference Column field.</p> <p>This field is enabled only when the Reference Data option radio button is selected from the Answer Value Set field.</p>	<p>Yes (Conditional)</p> <p>Note: This field is required for searching the answer from a reference table.</p>
Reference Criteria	<p>Used to specify the criteria based on which you want to search for the answer from the given reference.</p>	No
Validation Algorithm	<p>Used to indicate the algorithm that you want to use for validating the answer of the question.</p>	Yes

Field Name	Field Description	Mandatory (Yes or No)
	<p>Note: The Search (🔍) icon appears corresponding to this field. On clicking the Search icon, the Algorithm Search window appears where you can search for an algorithm.</p>	
Default Answer	Used to specify the answer that you want to set as default for the question.	No
Mandatory	<p>Used to indicate whether the question is mandatory or not.</p> <p>Note: On selecting the check box of the Mandatory field, the question appears with an asterisk (*) sign in the questionnaire template.</p>	No
Reference Parameter	<p>Used to indicate the parameter which is used to check the eligibility while recommending the reference customers / products / packages.</p> <p>Note:</p> <p>The Search (🔍) icon appears corresponding to this field. On clicking the Search icon, the Parameter Search window appears.</p> <p>On specifying the parameter, the description of the parameter appears corresponding to the Reference Parameter field.</p>	No
Rule Type	<p>Used to indicate the rule type using which the next question appears in the Questionnaire Template screen.</p> <p>Note:</p> <p>The Search (🔍) icon appears corresponding to this field. On clicking the Search icon, the Rule Type Search window appears.</p> <p>On specifying the rule type, the description of the rule type appears corresponding to the Rule Type field.</p> <p>This field is used when the Question Display Order is selected as Rule Based.</p>	<p>Yes (Conditional)</p> <p>Note: This field is used for displaying the next question based on the answer provided for the previous question in the questionnaire template.</p>

Field Name	Field Description	Mandatory (Yes or No)
Question Applicability	Used to indicate the question applicability based on which the references are derived. The valid values are: <ul style="list-style-type: none"> • Customer and Deal References • Package and Product References • Others 	Yes
Predefined Value	Used to specify the predefined list from where you want the system to search the answer for a question.	Yes (Conditional).
	Note: This field is enabled when the Predefined List option radio button is selected from the Answer Value Set field.	Note: This field is required for searching the answer from a predefined list.
Description	Used to specify the description of the predefined list.	Yes (Conditional)
		Note: This field is required for searching the answer from a predefined list.

3. Enter the required details in the **Main** section.
4. Add, edit, or remove questions from the questionnaire template, if required.

Note: Click the **Previous** (←) or **Next** (→) icons in the **Questions** section to navigate through the existing questions of the questionnaire template which you want to edit or delete.

5. Click **Save**.

The new questionnaire template is defined.

Related Topics

For more information on...	See...
How to search for a questionnaire template	Searching for a Questionnaire Template on page 2716
Search Questionnaire Template zone	Search Questionnaire Template on page 2715
Questionnaire Template screen	Questionnaire Template (Used for Searching) on page 2715
How to define a questionnaire template	Defining a Questionnaire Template on page 2717

Deleting a Questionnaire Template

Procedure

To delete a questionnaire template:

1. Search for the questionnaire template in the **Questionnaire Template** screen.
2. In the **Search Results** section, click the **Delete** (🗑️) icon in the **Delete** column corresponding to the questionnaire template that you want to delete.

A message appears confirming whether you want to delete the questionnaire template.

3. Click **OK**.

The questionnaire template is deleted.

Related Topics

For more information on...	See...
How to search for a questionnaire template	Searching for a Questionnaire Template on page 2716
Questionnaire Template screen	Questionnaire Template (Used for Searching) on page 2715
Search Questionnaire Template zone	Search Questionnaire Template on page 2715

Previewing a Questionnaire Template



Procedure

To preview a questionnaire template:

1. Search for the questionnaire template in the **Questionnaire Template** screen.
2. In the **Search Results** section, click the **Preview** () icon in the **Preview** column corresponding to the questionnaire template that you want to preview.

The **Preview Questionnaire Template** screen appears.

3. Answer the questions as they appear to preview the rule based questionnaire template.

Note: Click the **Next Question** or **Previous Question** buttons to navigate through the questions of a rule based questionnaire template. Whereas, click the **Previous** () or **Next** () icons to navigate through the questions set of a sequence based questionnaire template.

4. Click **Cancel** to close the **Preview Questionnaire Template** screen..

The **Preview Questionnaire Template** screen is closed.

Related Topics:

For more information on...	See...
How to search for a questionnaire template	Searching for a Questionnaire Template on page 2716
Questionnaire Template screen	Questionnaire Template (Used for Searching) on page 2715
Search Questionnaire Template zone	Search Questionnaire Template on page 2715

Viewing the Details of a Questionnaire Template

Procedure

To view the details of a questionnaire template:

1. Search for the questionnaire template in the **Questionnaire Template** screen.
2. In the **Search Results** section, click the link in the **Questionnaire Template Information** column corresponding to the questionnaire template whose details you want to view.

The **Questionnaire Template** screen appears.

3. View the details of the questionnaire template in the **Questionnaire Template** zone.

Related Topics

For more information on...	See...
How to search for a questionnaire template	Searching for a Questionnaire Template on page 2716
Questionnaire Template screen	Questionnaire Template (Used for Viewing) on page 2733
Search Questionnaire Template zone	Search Questionnaire Template on page 2715
Questionnaire Template zone	Questionnaire Template on page 2733

Questionnaire Template (Used for Viewing)

The **Questionnaire Template** screen allows you to view the details of a questionnaire template. It also allows you to edit a questionnaire template. It contains the following zones:

- [Questionnaire Template](#) on page 2733
- [Questions](#) on page 2733

Questionnaire Template

The **Questionnaire Template** zone displays the details of the questionnaire template. It contains the following sections:

- **Main** - Displays basic information about the questionnaire template. It contains the following fields:

Field Name	Field Description
Questionnaire Template	Displays the questionnaire template.
Description	Displays the description of the questionnaire template.
Start Date	Displays the date from when the questionnaire template is effective.
End Date	Displays the date till when the questionnaire template is effective.
Question Display Order	Indicates the order in which the questions of the questionnaire template should appear in the Questionnaire Template screen. The valid values are: <ul style="list-style-type: none"> • Rule based • Sequence based

- **Record Actions** - The **Record Actions** section contains the following button:

Button Name	Button Description
Edit	Used to edit the details of the questionnaire template.

Related Topics

For more information on...	See...
How to view the details of a questionnaire template	Viewing the Details of a Questionnaire Template on page 2732
How to edit the details of a questionnaire template	Editing a Questionnaire Template on page 2722

Questions

The **Questions** zone displays the details of the questions associated with a questionnaire template. It contains the following columns:

Column Name	Column Description
Question	Displays the question that is associated with the questionnaire template.
Description	Displays the question statement.
Sequence	Displays the sequence number of the question.
Answer Type	Indicates the type in which the answer is preferred for the question. The valid values are: <ul style="list-style-type: none"> • Date • Decimal Value • Multi Selection Check Box List • Multi Selection from Drop Down List • Numeric Value • Percentage • Radio Button List • Single Selection Drop Down List • Text
Edit	On clicking the Edit () icon, the Question screen appears where you can edit the details of the question.

Note: Pagination is used to display limited number of records in this zone. You can use the navigation links, such as **Previous** and **Next** to navigate between pages.

Related Topics

For more information on...	See...
How to view the details of a question	Viewing the Details of a Question on page 2734
How to edit a question	Editing a Question on page 2735
Questionnaire Template screen	Questionnaire Template (Used for Viewing) on page 2733

Viewing the Details of a Question

Procedure

To view the details of a question:

1. Search for the questionnaire template in the **Questionnaire Template** screen.
2. In the **Search Results** section, click the link in the **Questionnaire Template Information** column corresponding to the questionnaire template whose question details you want to view.
The **Questionnaire Template** screen appears.
3. Ensure that the **Questions** zone is expanded in the **Questionnaire Template** screen.
4. Click the **Edit** () icon in the **Edit** column corresponding to the question whose details you want to view.
The **Questions** screen appears.
5. View the details of the question in the **Question** screen.

Related Topics

For more information on...	See...
How to search for a questionnaire template	Searching for a Questionnaire Template on page 2716
Search Questionnaire Template zone	Search Questionnaire Template on page 2715
Questionnaire Template screen	Questionnaire Template (Used for Viewing) on page 2733
Questions zone	Questions on page 2733

Editing a Question

Prerequisites

To edit a question of a questionnaire template you should have:

- Questions defined in the application.
- Reference tables and reference columns defined in the application.
- Validation algorithms defined in the application.
- Reference parameter defined in the application.
- Rule types defined in the application.
- Values defined for the **DEAL_QUE_DISP_FLG**, **ANS_DISPLAY_FLG** and **APPLICABLE_FOR_FLG** lookup fields.

Procedure

To edit a question:

1. Search for the questionnaire template in the **Questionnaire Template** screen.
2. In the **Search Results** section, click the link in the **Questionnaire Template Information** column corresponding to the questionnaire template whose question you want to edit.

The **Questionnaire Template** screen appears.

3. Ensure that the **Questions** zone is expanded in the **Questionnaire Template** screen.
4. Click the **Edit**  icon in the **Edit** column corresponding to the question that you want to edit.

The **Question** screen appears. It contains the following fields:

Field Name	Field Description	Mandatory (Yes or No)
Question	Used to specify the question that you want to associate with the questionnaire template. Note: The Search  icon appears corresponding to this field. On clicking the Search icon, the Question Search window appears where you can search for a question.	Yes
Question Text	Used to specify the question statement.	Yes
Sequence	Used to specify the sequence number of the question.	Yes
Answer Type	Used to indicate the type in which you want to select the answer for the question. The valid values are:	Yes

Field Name	Field Description	Mandatory (Yes or No)
	<ul style="list-style-type: none"> • Date • Decimal Value • Multi Selection Check Box List • Multi Selection from Drop Down List • Numeric Value • Percentage • Radio Button List • Single Selection Drop Down List • Text 	
Answer Value Set	<p>Indicates the references from where you want to search for the answer of the question. The valid values are:</p> <ul style="list-style-type: none"> • Reference Data <ul style="list-style-type: none"> - Used to indicate that you want to search for the answer from a specific reference table given in the system. <div data-bbox="760 978 1151 1157" style="border: 1px solid black; padding: 5px;"> <p>Note: This field is disabled when you select the Date, Decimal Value, Numeric Value, Percentage, or Text option from the Answer Type list.</p> </div> • Predefined List <ul style="list-style-type: none"> - Used to indicate that you want to search for the answer from a predefined list defined in the system. <div data-bbox="760 1367 1151 1545" style="border: 1px solid black; padding: 5px;"> <p>Note: This field is disabled when you select the Date, Decimal Value, Numeric Value, Percentage, or Text option from the Answer Type list.</p> </div> 	<p>Yes (Conditional)</p> <div data-bbox="1159 726 1468 835" style="border: 1px solid black; padding: 5px;"> <p>Note: This field is required for searching answers from a given reference.</p> </div>
Reference Table	<p>Used to indicate a specific table that you want to set as a source for searching the answer of the question.</p>	<p>Yes (Conditional)</p> <div data-bbox="1159 1623 1468 1732" style="border: 1px solid black; padding: 5px;"> <p>Note: This field is required for searching the answer from a reference table.</p> </div>

Field Name	Field Description	Mandatory (Yes or No)
	<p>Note:</p> <p>The Search (🔍) icon appears corresponding to this field. On clicking the Search icon, the Table Search window appears.</p> <p>On specifying the table, the description of the table appears corresponding to the Reference Table field.</p> <p>This field is enabled only when the Reference Data option radio button is selected from the Answer Value Set field.</p>	
Reference Column	<p>Used to indicate the column in the reference table from where you want to search for the answer of the question.</p> <p>Note:</p> <p>The Search (🔍) icon appears corresponding to this field. On clicking the Search icon, the Column Search window appears.</p> <p>On specifying the column, the description of the column appears corresponding to the Reference Column field.</p> <p>This field is enabled only when the Reference Data option radio button is selected from the Answer Value Set field.</p>	<p>Yes (Conditional)</p> <p>Note: This field is required for searching the answer from a reference table.</p>
Reference Criteria	Used to specify the criteria based on which you want to search for the answer from the given reference.	No
Validation Algorithm	<p>Used to indicate the algorithm that you want to use for validating the answer of the question.</p> <p>Note: The Search (🔍) icon appears corresponding to this field. On clicking the Search icon, the Algorithm Search window appears where you can search for an algorithm.</p>	Yes
Default Answer	Used to specify the answer that you want to set as default for the question.	No
Mandatory	Used to indicate whether the question is mandatory or not.	No

Field Name	Field Description	Mandatory (Yes or No)
	<p>Note: On selecting the check box of the Mandatory field, the question appears with an asterisk (*) sign in the questionnaire template.</p>	
Reference Parameter	<p>Used to indicate the parameter which is used to check the eligibility while recommending the reference customers / products / packages.</p> <p>Note:</p> <p>The Search (🔍) icon appears corresponding to this field. On clicking the Search icon, the Parameter Search window appears.</p> <p>On specifying the parameter, the description of the parameter appears corresponding to the Reference Parameter field.</p>	No
Rule Type	<p>Used to indicate the rule type using which the next question appears in the Questionnaire Template screen.</p> <p>Note:</p> <p>The Search (🔍) icon appears corresponding to this field. On clicking the Search icon, the Rule Type Search window appears.</p> <p>On specifying the rule type, the description of the rule type appears corresponding to the Rule Type field.</p> <p>This field is used when the Question Display Order is selected as Rule Based.</p>	<p>Yes (Conditional)</p> <p>Note: This field is used for displaying the next question based on the answer provided for the previous question in the questionnaire template.</p>
Question Applicability	<p>Used to indicate the question applicability based on which the references are derived. The valid values are:</p> <ul style="list-style-type: none"> • Customer and Deal References • Package and Product References • Others 	Yes
Predefined Value	<p>Used to specify the predefined list from where you want the system to search the answer for a question.</p>	<p>Yes (Conditional).</p> <p>Note: This field is required for searching the answer from a predefined list.</p>

Field Name	Field Description	Mandatory (Yes or No)
	Note: This field is enabled when the Predefined List option radio button is selected from the Answer Value Set field.	
Description	Used to specify the description of the predefined list.	Yes (Conditional)
		Note: This field is required for searching the answer from a predefined list.

5. Click **Save**.

The changes made to the question are saved.

Related Topics

For more information on...	See...
How to search for a questionnaire template	Searching for a Questionnaire Template on page 2716
Search Questionnaire Template zone	Search Questionnaire Template on page 2715
Questionnaire Template screen	Questionnaire Template (Used for Viewing) on page 2733
Questions zone	Questions on page 2733
How to define a questionnaire template	Defining a Questionnaire Template on page 2717

Prospect

The **Prospect** screen allows you to search for a prospect using various search criteria. It also allows you to define and edit a prospect. It contains the following zone:

- [Prospect](#) on page 2739

Prospect

The **Prospect** zone allows you to search for a prospect using various search criteria. It contains the following two sections:

- **Search Criteria** - The **Search Criteria** section contains the following fields:

Field Name	Field Description	Mandatory (Yes or No)
Division	Used to search prospects which are associated with a particular division.	No
	Note: You can only view those divisions to which you have access in the Division list.	
Prospect Person Name	Used to search for a particular prospect person.	No
Customer Segment	Used to search prospects which are associated to a particular business component.	No

Field Name	Field Description	Mandatory (Yes or No)
	Note: This field appears when you click the Advanced Search link in the top right corner of this zone.	
Prospect Person ID	Used to search for a particular prospect.	No
Prospect Person Identifier Type	Used to indicate the identifier type based on which you want to search for a prospect.	Yes (Conditional) Note: If you specify the prospect person identifier as a search criteria, you have to select the prospect person identifier type.
Prospect Person Identifier	Used to specify the identifier based on which you want to search for a prospect person.	Yes (Conditional) Note: If you indicate the prospect person identifier type as a search criteria, you have to enter the prospect person identifier.

Note: You must specify at least one search criterion while searching for a prospect.

- **Search Results** - On clicking the **Search** button, the search results appear based on the specified search criteria. The **Search Results** section contains the following columns:

Column Name	Column Description
Prospect Person Information	Displays the concatenated string of information about the prospect separated by a comma (.). Note: It has a link. On clicking the link, the Prospect Person screen appears where you can view or edit the details of the respective prospect.
Prospect Person Identifier Type	Indicates the identifier type of the prospect.
Prospect Person Identifier	Displays the value of the prospect person identifier type.
Division	Displays the division to which the prospect belongs.

Note: Pagination is used to display limited number of records in the **Search Results** section. You can use the navigation links, such as **Previous** and **Next** to navigate between pages.

By default, the **Filter** area is visible. You can hide the **Filter** area by clicking the **Filters** (Y) icon in the upper right corner of this zone.

Related Topics

For more information on...	See...
Prospect screen	Prospect on page 2739
How to edit a prospect person	Editing a Prospect Person on page 2741

For more information on...	See...
How to edit a prospect account	Editing a Prospect Account on page 2743
How to define a prospect person	Defining a Prospect Person on page 2746
How to define an account for a prospect person	Defining an Account for a Prospect Person on page 2753

Searching for a Prospect

Prerequisites

To search for a prospect, you should have:

- Divisions defined in the application
- Prospects associated with the division
- Customer segments defined in the application
- Prospects associated with the respective customer segment
- Prospect customer identifier types defined in the application

Procedure

To search for a prospect:

1. Click the **Menu** link in the **Application** toolbar.
A list appears.
2. From the **Main** menu, select **Deal Management** and then click **Prospect**.
A sub-menu appears.
3. Click the **Search** option from the **Prospect** sub-menu.
The **Prospect** screen appears.
4. Enter the search criteria in the **Prospect** zone.

Note: ORMB search engine supports wildcard search, where you can substitute the percentage (%) symbol as a stand in for any word or letter in a search criteria. You can use the ‘%’ wildcard character in all input fields except the date and ID fields. The ‘%’ wildcard character is suffixed automatically at the end of the partial search criteria. Therefore, you may or may not specify the wildcard character at the end of the partial search criteria. However, you have to prefix the wildcard character manually wherever required.

5. Click **Search**.

A list of prospects that meet the search criteria appears in the **Search Results** section.

Note: Pagination is used to display limited number of records in the **Search Results** section. You can use the navigation links, such as **Previous** and **Next** to navigate between pages.

Related Topics

For more information on...	See...
Prospect screen	Prospect on page 2739
Prospect zone	Prospect on page 2739

Editing a Prospect Person

Prerequisites

To edit a prospect person, you should have:

- Prospect (which you want to edit) defined in the application
- Customer segments and customer tiers defined in the application
- Access groups defined in the application
- Characteristic types defined in the application (where the characteristic entity is set to **Person**)
- Person identifier types defined in the application
- Relationship types defined in the application

Procedure

To edit a prospect person:

1. Search for the prospect person in the **Prospect** screen.
2. In the **Search Results** section, click the link in the **Prospect Person Information** column corresponding to the prospect whose details you want to edit.

The **Prospect Person** screen appears. It contains the following sections:

- **Main** - Used to specify basic details about the prospect person.
- **Prospect Person Address** - Used to define or edit the address of the prospect person.
- **Prospect Person Characteristics** - Used to define, edit, or remove characteristics of the prospect person.
- **Prospect Person Identifiers** - Used to associate or disassociate identifiers from the prospect person.
- **Prospect Person Relationships** - Used to associate or disassociate child persons with the prospect person.

The **Main** section contains the following fields:

Field Name	Field Description	Mandatory (Yes or No)
Prospect Person ID	Indicates the prospect person ID for which you want to edit the prospect person details.	Not applicable
	Note: By default, the Prospect Person ID field is in the read-only mode.	
Prospect Person Name	Used to specify the name for the prospect person.	No
Division	Used to indicate the division to which the prospect person is associated.	No
	Note: This field cannot be edited when an account is defined for the prospect person. You can only view those divisions to which you have access in the Division list.	
Customer Segment	Used to indicate the business component to which you want to associate the prospect person.	No

Field Name	Field Description	Mandatory (Yes or No)
	Note: The list includes only those values which are present in the CUST_SEG_FLG lookup field.	
Customer Tier	Used to indicate the customer tier. Note: The list includes only those values which are present in the CUST_TIER_FLG lookup field.	No
Access Group	Used to indicate the users who can view and edit the details of the prospect person.	Yes
Email Address	Used to specify the email address of the prospect person.	No
Date Of Birth	Used to specify the date of birth of the prospect person.	No

3. Modify the required details in the **Main** section.
4. Define or edit address of the prospect person, if required.
5. Define, edit, or remove characteristics of the prospect person, if required.
6. Associate or disassociate identifiers from the prospect person, if required.
7. Associate or disassociate child persons from the prospect person, if required.
8. Click **Save**.

The changes made to the prospect person are saved.

Related Topics

For more information on...	See...
Prospect screen	Prospect on page 2739
How to define an address for a prospect person	Defining an Address for a Prospect Person on page 2748
How to define a characteristic for a prospect person	Defining a Characteristic for a Prospect Person on page 2749
How to associate an identifier with a prospect person	Associating an Identifier with a Prospect Person on page 2750
How to associate a child person with a prospect person	Associating a Child Person with a Prospect Person on page 2751

Editing a Prospect Account

Prerequisites

To edit a prospect account, you should have:

- Prospect (whose account details you want to edit) defined in the application
- Customer class defined in the application
- Currencies defined in the application

- Bill Cycles defined in the application
- Characteristic types defined in the application (where the characteristic entity is set to **Account**)
- Account identifier types defined in the application

Procedure

To edit a prospect account:

1. Search for the prospect person whose account details you want to edit in the **Prospect** screen.
2. Modify the required details in the **Prospect Person** screen, if required.
3. Click **Save**.

The changes made to the prospect person are saved.

4. Click **Next**.

The **Prospect Account** screen appears. It contains the following sections:

- **Prospect Account List** - Lists the accounts which are associated with the prospect person.

Note: By default, the **Prospect Account List** section does not appear. It appears only when an account is defined for a prospect person.

- **Main** - Used to specify basic details about the prospect account.
- **Prospect Account Characteristics** - Used to define, edit, or remove characteristics of the prospect account.
- **Prospect Account Identifiers** - Used to add, edit, or remove identifiers from the prospect account.

The **Prospect Account List** section contains the following columns:

Column Name	Column Description	Mandatory (Yes or No)
Prospect Person ID	Displays the prospect person to which the account is associated.	Not applicable
Prospect Account Information	Displays information about the prospect account.	Yes
	Note: It has a link. On clicking the link, the details of the prospect account is accessible for editing in the Main , Prospect Account Characteristics , and Prospect Account Identifiers sections.	
Division	Indicates the division to which the prospect account is associated.	Not applicable
Set Up Date	Displays the date from when the prospect account is available for calculating the financial summary of the deal.	Not applicable

5. Click the link in the **Prospect Account Information** column corresponding to the account whose details you want to edit.

The details of the account is accessible for editing in the **Main**, **Prospect Account Characteristics** , and **Prospect Account Identifiers** sections.

The **Main** section contains the following fields:

Field Name	Field Description	Mandatory (Yes or No)
Prospect Person ID	Displays the prospect person to which the account is associated.	Not applicable
	Note: By default, the Prospect Person ID field is in the read-only mode.	
Prospect Account ID	Displays the account associated with the prospect person.	Not applicable
	Note: By default, the Prospect Account ID field is in the read-only mode.	
Customer Class	Used to indicate the customer class to which the prospect account belongs.	Yes
Division	Indicates the division to which the prospect account is associated.	Not applicable
	Note: By default, the Division field is in the read-only mode.	
Set Up Date	Used to specify the date from when the prospect account is available for calculating the financial summary of the deal.	Yes
Invoice Currency	Used to indicate the currency in which you want the financial summary of the prospect account to be calculated for the deal.	Yes
Bill Cycle	Used to indicate the time interval in which you want to create the financial summary of the account for the deal.	No
Access Group	Indicates the users who can view or edit the details of the account.	Not applicable
	Note: By default, the Access Group field is in the read-only mode.	

6. Modify the required details in the **Main** section.
7. Define, edit, or remove characteristics of the **Prospect Account Characteristics** section, if required.
8. Add, edit, or remove identifier details from the **Prospect Account Identifiers** section, if required.
9. Click **Save**.

The changes made to the prospect account are saved.

Related Topics

For more information on...	See...
Prospect screen	Prospect on page 2739
How to define an account for a prospect person	Defining an Account for a Prospect Person on page 2753

For more information on...	See...
How to define a characteristic for a prospect account	Defining a Characteristic for a Prospect Account on page 2754
How to associate an identifier with a prospect account	Associating an Identifier with a Prospect Account on page 2756

Defining a Prospect Person

Prerequisites

To define a prospect person, you should have:

- Divisions defined in the application
- Customer segments and customer tiers defined in the application
- Access groups defined in the application
- Characteristic types defined in the application (where the characteristic entity is set to **Person**)
- Person identifier types defined in the application
- Relationship types defined in the application

Procedure

To define a prospect person:

1. Click the **Menu** link in the **Application** toolbar.
A list appears.
2. From the **Main** menu, select **Deal Management** and then click **Prospect**.
A sub-menu appears.
3. Click the **Add** option from the **Prospect** sub-menu.

The **Prospect Person** screen appears. It contains the following sections:

- **Main** - Used to specify basic details about the prospect person.
- **Prospect Person Address** - Used to define or edit the address of the prospect person.
- **Prospect Person Characteristics** - Used to define a list of characteristics for the prospect person.
- **Prospect Person Identifiers** - Used to associate identifiers with the prospect person.
- **Prospect Person Relationships** - Used to associate child persons with the prospect person.

The **Main** section contains the following fields:

Field Name	Field Description	Mandatory (Yes or No)
Prospect Person ID	Indicates the person identification value that is generated for the prospect person. Note: By default, the Prospect Person ID field is in the read-only mode. The person identification value is created automatically when you click the Save button on the Prospect Person screen.	Not applicable
Prospect Person Name	Used to specify the name for the prospect person.	Yes

Field Name	Field Description	Mandatory (Yes or No)
Division	Used to indicate the division to which the prospect person is associated.	Yes
	Note: You can only view those divisions to which you have access in the Division list.	
Customer Segment	Used to indicate the business component to which you want to associate the prospect person.	No
	Note: The list includes only those values which are present in the CUST_SEG_FLG lookup field.	
Customer Tier	Used to indicate the customer tier.	No
	Note: The list includes only those values which are present in the CUST_TIER_FLG lookup field.	
Access Group	Used to indicate the users who can view and edit the details of the prospect person.	Yes
Email Address	Used to specify the email address of the prospect person.	No
Date Of Birth	Used to specify the date of birth of the prospect person.	No

4. Enter the required details in the **Main** section.
5. Define the address for the prospect person, if required.
6. Define characteristics for the prospect person, if required.
7. Associate identifiers with the prospect person, if required.
8. Associate child persons with the prospect person, if required.
9. Click **Save**.

The prospect person is defined.

Tip: Alternatively, you can define a prospect by clicking the **Add** button available in the **Prospect** screen or by clicking the **Add New Prospect** button available in the **Deal Information - Deal** page.

Note: When you create a prospect person or account, the system, by default sets the status of the prospect person and account to **ACTIVE**. You can view the status of the prospect person and account through the inbound web service.

Related Topics

For more information on...	See...
Prospect Person screen	Prospect on page 2739
How to define an address for a prospect person	Defining an Address for a Prospect Person on page 2748

For more information on...	See...
How to define a characteristic for a prospect person	Defining a Characteristic for a Prospect Person on page 2749
How to associate an identifier with a prospect person	Associating an Identifier with a Prospect Person on page 2750
How to associate a child person with a prospect person	Associating a Child Person with a Prospect Person on page 2751

Defining an Address for a Prospect Person

Prerequisites

To define an address for a prospect person, you should have:

- Countries defined in the application
- States defined in the application

Procedure

To define an address for a prospect person:

1. Ensure that the **Prospect Person Address** section is expanded when you are defining or editing a prospect person.

The **Prospect Person Address** section contains the following fields:

Field Name	Field Description	Mandatory (Yes or No)
Country	Used to indicate the country where the prospect person is located.	Yes (Conditional)
		Note: This field is required while defining or editing the address of a prospect person.
Address 1	Used to specify the first line of the address. It may contain details, such as the house number.	Yes (Conditional)
		Note: This field is required while defining or editing the address of a prospect person.
City	Used to specify the city where the prospect person is located.	Yes (Conditional)
		Note: This field is required while defining or editing the address of a prospect person.
Address 2	Used to specify the second line of the address. It may contain details, such as the apartment name.	Yes (Conditional)
		Note: This field is required while defining or editing the address of a prospect person.

Field Name	Field Description	Mandatory (Yes or No)
State	Used to indicate the state where the city is located.	Yes (Conditional) Note: This field is required while defining or editing the address of a prospect person.
Address 3	Used to specify the third line of the address. It may contain details, such as the street name.	Yes (Conditional) Note: This field is required while defining or editing the address of a prospect person.
Postal	Used to specify the postal or zip code of the address.	Yes (Conditional) Note: This field is required while defining or editing the address of a prospect person.
Address 4	Used to specify the fourth line of the address. It may contain the landmark details.	Yes (Conditional) Note: This field is required while defining or editing the address of a prospect person.

- Enter the required details in the **Prospect Person Address** section.
- Click **Save**.

The address is defined for the prospect person.

Related Topics

For more information on...	See...
How to define a prospect person	Defining a Prospect Person on page 2746
How to edit a prospect person	Editing a Prospect Person on page 2741

Defining a Characteristic for a Prospect Person

Prerequisites

To define a characteristic for a prospect person, you should have:

- Characteristic types defined in the application (where the characteristic entity is set to **Person**)

Procedure

To define a characteristic for a prospect person:

- Ensure that the **Prospect Person Characteristics** section is expanded when you are defining or editing a prospect person.

The **Prospect Person Characteristics** section contains the following fields in a grid:

Field Name	Field Description	Mandatory (Yes or No)
Effective Date	Used to specify the date from when the characteristic is effective for the prospect person.	Yes (Conditional) Note: This field is required while defining a characteristic for a prospect person.
Characteristic Type	Used to indicate the characteristic type.	Yes (Conditional)
	Note: The list includes only those characteristic types where the characteristic entity is set to Prospect Person .	Note: This field is required while defining a characteristic for a prospect person.
Characteristic Value	Used to specify the value for the characteristic type.	Yes (Conditional)
	Note: If you select a predefined characteristic type, the Search (🔍) icon appears corresponding to the Characteristic Value field. On clicking the Search icon, the Predefined Characteristic Search window appears. On specifying the value for a predefined characteristic type, the description of the characteristic value appears corresponding to the Characteristic Value field.	Note: This field is required while defining a characteristic for a prospect person.

- Enter the required details in the **Prospect Person Characteristics** section.
- If you want to define more than one characteristic for the prospect, click the **Add** (+) icon and then repeat step 2.

Note: However, if you want to remove a characteristic from the prospect, click the **Delete** (🗑️) icon corresponding to the characteristic.

- Click **Save**.

The characteristic is defined for the prospect person.

Related Topics

For more information on...	See...
How to define a prospect person	Defining a Prospect Person on page 2746
How to edit a prospect person	Editing a Prospect Person on page 2741

Associating an Identifier with a Prospect Person

Prerequisites

To associate an identifier with a prospect person, you should have:

- Prospect person identifier types defined in the application

Procedure

To associate an identifier with a prospect person:

1. Ensure that the **Prospect Person Identifiers** section is expanded when you are defining or editing a prospect person.

The **Prospect Person Identifiers** section contains the following fields in a grid:

Field Name	Field Description	Mandatory (Yes or No)
Primary ID	Used to specify whether the prospect person identifier is primary or not.	Yes (Conditional) Note: This field is required while associating an identifier with a prospect person.
Person Identifier Type	Used to indicate the identifier type based on which you want to define the prospect person.	Yes (Conditional) Note: This field is required while associating an identifier with a prospect person.
Person Identifier	Used to specify the value for the person identifier type.	Yes (Conditional) Note: This field is required while associating an identifier with a prospect person.

2. Enter the required details in the **Prospect Person Identifiers** section.
3. If you want to associate more than one identifier with the prospect person, click the **Add (+)** icon and then repeat step 2.

Note: However, if you want to disassociate an identifier from the prospect person, click the **Delete (🗑)** icon corresponding to the identifier.

4. Click **Save**.

The identifier is associated with the prospect person.

Related Topics

For more information on...	See...
How to define a prospect person	Defining a Prospect Person on page 2746
How to edit a prospect person	Editing a Prospect Person on page 2741

Associating a Child Person with a Prospect Person

Prerequisites

To associate a child person with a prospect person, you should have:

- Child persons defined in the application

- Relationship types defined in the application

Procedure

To associate a child person with a prospect person:

1. Ensure that the **Prospect Person Relationships** section is expanded when you are defining or editing a prospect person.

The **Prospect Person Relationships** section contains the following fields in a grid:

Field Name	Field Description	Mandatory (Yes or No)
Child Person	Used to indicate the child person you want to associate with the prospect person.	Yes (Conditional)
	Note: The Search (🔍) icon appears corresponding to the Child Person field. On clicking the Search icon, the Prospect Person Search window appears.	Note: This field is required while associating a child person with a prospect person.
Relationship Type	Used to indicate how the child person is associated with the prospect person.	Yes (Conditional)
		Note: This field is required while associating a child person with a prospect person.
Start Date	Used to specify the date from when the child person is associated with the prospect person.	Yes (Conditional)
	Note: The start date cannot be later than the end date.	Note: This field is required while associating a child person with a prospect person.
End Date	Used to specify the date till when the child person is associated with the prospect person.	Yes (Conditional)
	Note: The end date cannot be earlier than the start date.	Note: This field is required while associating a child person with a prospect person.

2. Enter the required details in the **Prospect Person Relationships** section.
3. If you want to associate more than one child person with the prospect person, click the **Add** (+) icon and then repeat step 2.

Note: However, if you want to disassociate a child person from the prospect person, click the **Delete** (🗑️) icon corresponding to the child person.

4. Click **Save** .

The child person is associated with the prospect person.

Related Topics

For more information on...	See...
How to define a prospect person	Defining a Prospect Person on page 2746
How to edit a prospect person	Editing a Prospect Person on page 2741

Defining an Account for a Prospect Person

Prerequisites

To define an account for a prospect person, you should have:

- Customer classes defined in the application
- Bill cycles defined in the application
- Currencies defined in the application
- Characteristic types defined in the application (where the characteristic entity is set to **Account**)
- Account identifier types defined in the application

Procedure

To define an account for a prospect person:

1. Ensure that the **Prospect Account** screen is open when you are defining or editing a prospect person.

The **Prospect Account** screen contains the following sections:

- **Prospect Account List** - Lists the accounts which are defined for the prospect person.

Note: By default, the **Prospect Account List** section does not appear. It appears when you define an account for a prospect person.

- **Main** - Used to specify basic details about the prospect account.
- **Prospect Account Characteristics** - Used to define a list of characteristics for the prospect account.
- **Prospect Account Identifiers** - Used to associate identifiers with the prospect account.

The **Main** section contains the following fields:

Field Name	Field Description	Mandatory (Yes or No)
Prospect Person ID	Indicates the prospect person for whom you want to define the account.	Not applicable
Prospect Account ID	Indicates the account identification value that is generated for the prospect person.	Not applicable
	Note: By default, the Prospect Account ID field is in the read-only mode. The account identification value is created automatically when you click the Save button on the Prospect Account screen.	
Customer Class	Used to indicate the customer class to which the account is associated.	Yes (Conditional)
		Note: This field is required when you are defining an account for a prospect person.

Field Name	Field Description	Mandatory (Yes or No)
Division	Indicates the division to which the prospect person is associated for whom you want to define the account.	Not applicable
Set Up Date	Used to specify the date from when the prospect account is available for calculating the financial summary of the deal.	Yes (Conditional) Note: This field is required when you are defining an account for a prospect person.
Invoice Currency	Used to indicate the currency in which you want the financial summary of the prospect account to be calculated for the deal.	Yes (Conditional) Note: This field is required when you are defining an account for a prospect person.
Bill Cycle	Used to indicate the time interval in which you want to create the financial summary of the account for the deal.	Yes (Conditional) Note: This field is required when you are defining an account for a prospect person.
Access Group	Indicates the users who can view and edit the details of the prospect account. Note: By default, the Access Group field is in the read-only mode.	Not applicable

2. Enter the required details in the **Main** section.
3. Define characteristics for the prospect account, if required.
4. Associate identifiers with the prospect account, if required.
5. Click **Save**.

The account is defined for the prospect person.

Related Topics

For more information on...	See...
How to edit a prospect account	Editing a Prospect Account on page 2743
How to define a characteristic for a prospect account	Defining a Characteristic for a Prospect Account on page 2754
How to associate an identifier with a prospect account	Associating an Identifier with a Prospect Account on page 2756

Defining a Characteristic for a Prospect Account

Prerequisites

To define a characteristic for a prospect account, you should have:

- Characteristic types defined in the application (where the characteristic entity is set to **Account**)

Procedure

To define a characteristic for a prospect account:

1. Ensure that the **Prospect Account Characteristics** section is expanded when you are defining or editing a prospect account.

The **Prospect Account Characteristics** section contains the following fields in a grid:

Field Name	Field Description	Mandatory (Yes or No)
Effective Date	Used to specify the date from when the characteristic is effective for the prospect account.	Yes (Conditional)
		Note: This field is required while defining a characteristic for a prospect account.
Characteristic Type	Used to indicate the characteristic type.	Yes (Conditional)
	Note: The list includes only those characteristic types where the characteristic entity is set to Account .	Note: This field is required while defining a characteristic for a prospect account.
Characteristic Value	Used to specify the value for the characteristic type.	Yes (Conditional)
	Note: If you select a predefined characteristic type, the Search (🔍) icon appears corresponding to the Characteristic Value field. On clicking the Search icon, the Predefined Characteristic Search window appears. On specifying the value for a predefined characteristic type, the description of the characteristic value appears corresponding to the Characteristic Value field.	Note: This field is required while defining a characteristic for a prospect account.

2. Enter the required details in the **Prospect Account Characteristics** section.
3. If you want to define more than one characteristic for the prospect account, click the **Add** (+) icon and then repeat step 2.

Note: However, if you want to remove a characteristic from the prospect account, click the **Delete** (🗑️) icon corresponding to the characteristic.

4. Click **Save**.

The characteristic is defined for the prospect account.

Related Topics

For more information on...	See...
How to define an account for a prospect person	Defining an Account for a Prospect Person on page 2753
How to edit a prospect account	Editing a Prospect Account on page 2743

Associating an Identifier with a Prospect Account

Prerequisites

To associate an identifier with a prospect account, you should have:

- Prospect account identifier types defined in the application

Procedure

To associate an identifier with a prospect account:

1. Ensure that the **Prospect Account Identifiers** section is expanded when you are defining or editing a prospect account.

The **Prospect Account Identifiers** section contains the following fields in a grid:

Field Name	Field Description	Mandatory (Yes or No)
Primary ID	Used to specify whether the prospect account identifier is primary or not.	Yes (Conditional) Note: This field is required while associating an identifier with a prospect account.
Account Identifier Type	Used to indicate the identifier type based on which you want to define the prospect account.	Yes (Conditional) Note: This field is required while associating an identifier with a prospect account.
Primary Account Identifier	Used to specify the value for the account identifier type.	Yes (Conditional) Note: This field is required while associating an identifier with a prospect account.

2. Enter the required details in the **Prospect Account Identifiers** section.
3. If you want to associate more than one identifier with the prospect account, click the **Add (+)** icon and then repeat step 2.

Note: However, if you want to disassociate an identifier from the prospect account, click the **Delete** (🗑️) icon corresponding to the identifier.

4. Click **Save**.

The identifier is associated with the prospect account.

Related Topics

For more information on...	See...
How to define an account for a prospect person	Defining an Account for a Prospect Person on page 2753
How to edit a prospect account	Editing a Prospect Account on page 2743

Deal Dashboard

The **Deal Dashboard** screen allows you to define a deal. It also enables you to do the following:

- View the metrics of the deals created by the user through a tiles chart, bar chart, or line chart
- View the details of a tile from the metrics in a pie chart
- View the To Do's assigned to the user
- Compare two deals versions

The **Deal Dashboard** screen contains the following zones:

- [Deal Metrics](#) on page 2757
- [Deal Statistics](#) on page 2758
- [Deal To Do](#) on page 2758
- [Search Deal](#) on page 2758
- [Deal Versions](#) on page 2771
- [Deal Comparison](#) on page 2772

Deal Metrics

The **Deal Metrics** zone enables you to view the following information through a tiles chart:

- Number of deals created by the user
- Number of deals in the **Pending for Approval** status
- Number of deals yet to be finalized
- Number of deals yet to be accepted by the customer
- Number of deals accepted by the customer
- Number of deals rejected by the customer

In addition, you can view the above information through a bar and line chart by toggling the **Tiles/Chart** switch available in the **Deal Metrics** zone.

The bar chart indicates the number of deals in different statuses for an existing customer, existing account, and prospect. Whereas, the line chart indicates the deal revenue from an existing customer, existing account, and prospect.

Note: By default, the above information is shown for the period which is specified in the **Deal Limits in Months** option type of the **C1-DEAL** feature configuration. You can change the period if required.

You can filter the information using various criteria (such as, **Period From**, **Period To**, **Division**, **Customer Tier**, and **Customer Segment**) available in the **Deal Metrics** zone.

Related Topics

For more information on...	See...
Deal Dashboard screen	Deal Dashboard on page 2757

For more information on...	See...
How to view the deal metrics in the tiles chart	Viewing the Deal Metrics in the Tiles Chart on page 2787
How to view the deal count in the bar chart	Viewing the Deal Count in the Bar Chart on page 2788
How to view the deal revenue in the line chart	Viewing the Deal Revenue in the Line Chart on page 2788

Deal Statistics

The **Deal Statistics** zone allows you to view information through a pie chart about a particular tile from the tiles chart available in the **Deal Metrics** zone. On clicking a tile in the tiles chart, the pie chart graphically represents the number of deals in percentage of an existing customer, existing account, and prospect in the respective status.

Related Topics

For more information on...	See...
Deal Dashboard screen	Deal Dashboard on page 2757
How to view statistics of deals in a particular status	Viewing Statistics of Deals in a Particular Status on page 2789

Deal To Do

The **Deal To Do** zone lists all the To Do's generated for the approving the deal. It contains the following columns:

Column name	Column Description
To Do	On clicking the To Do icon (📌), the To Do Entry screen appears where you can view the details of the respective To Do assigned to the user.
Deal Information	Displays the concatenated string of information about the deal separated by a comma (,) for which the To Do is created. Note: It has a link. On clicking the link, the Deal Information screen appears where you can perform the required action.

Note: By default, the system lists the To Do's that are created in the period which is specified in the **Deal Limits in Months** option type of the **C1-DEAL** feature configuration. You can change the period if required.

You can filter the list using various criteria (such as, **To Do Type**, **Priority**, **Start Date**, and **End Date**) available in the **Filter** area. By default, the **Filter** area is hidden. You can view the **Filter** area by clicking the **Filters** (🔍) icon in the upper right corner of this zone.

Note: Pagination is used to display limited number of records in this zone. You can use the navigation links, such as **Previous** and **Next** to navigate between pages.

Related Topics

For more information on...	See...
Deal Dashboard screen	Deal Dashboard on page 2757

Search Deal

The **Search Deal** zone allows you to search for deals using various search criteria. It contains the following two sections:

- **Search Criteria** - The **Search Criteria** section contains the following fields:

Field Name	Field Description	Mandatory (Yes or No)
Search By	Used to indicate whether you want to search for a deal using the deal, customer, account, or deal characteristic details. The valid values are: <ul style="list-style-type: none"> Deal Details Customer Details Account Details Deal Characteristics 	Yes
	Note: By default, the Deal Details option is selected.	
Deal ID	Used to search for a particular deal.	No
	Note: This field appears when the Deal Details option is selected from the Search By list.	
Deal Identifier	Used to search deals which are created using a particular deal identifier.	No
	Note: This field appears when the Deal Details option is selected from the Search By list.	
Division	Used to search deals which are associated with a particular division to which the user belongs.	No
	Note: You can only view those divisions to which you have access in the Division list.	
Deal Type	Used to search deals which are created using a particular deal type.	No
	<p>Note:</p> <p>The Search (🔍) icon appears corresponding to this field. On clicking the Search icon, the Deal Type Search window appears.</p> <p>On specifying the deal type, the description of the deal type appears corresponding to the Deal Type field.</p> <p>This field appears when the Deal Details option is selected from the Search By list.</p>	
Start Date	Used to search deals which are effective from a particular date onwards.	No

Field Name	Field Description	Mandatory (Yes or No)
	<p>Note:</p> <p>This field appears when the Deal Details option is selected from the Search By list.</p> <p>The start date cannot be later than the end date.</p>	
End Date	<p>Used to search deals which are effective till a particular date.</p> <p>Note:</p> <p>This field appears when the Deal Details option is selected from the Search By list.</p> <p>The end date cannot be earlier than the start date.</p>	No
Status	<p>Used to search deals with a particular status. The valid values are:</p> <ul style="list-style-type: none"> • Applied/Processed • Approved • Closed • Customer Accepted • Discarded • Draft • Error • Finalized • Fully Orchestrated • Hierarchy Creation Deferred • Inactive • Partially Orchestrated • Pending for Approval • Pending for Review • Pending Simulation • Pending for Orchestration • Ready for Approval • Rejected • Simulated • Simulation Deferred <p>Note: This field appears when the Deal Details option is selected from the Search By list.</p>	No

Field Name	Field Description	Mandatory (Yes or No)
Deal Entity	<p>Used to search deals which are created for a particular entity. The valid values are:</p> <ul style="list-style-type: none"> • Account - Used to search deals which are created for the existing accounts in the system. <p>Note: This option appears when you select the Deal Details or Account Details option from the Search By list.</p> <ul style="list-style-type: none"> • Customer - Used to search deals which are created for the existing customers in the system. <p>Note: This option appears when you select the Deal Details or Customer Details option from the Search By list.</p> <ul style="list-style-type: none"> • Prospect - Used to search deals which are created for the existing prospects in the system. <p>Note: This option appears when you select the Deal Details or Customer Details option from the Search By list.</p> <p>Note: By default, the Customer or Account option is selected when you search deals using the Customer Details or Account Details options respectively from the Search By field.</p>	<p>Yes (Conditional)</p> <p>Note: This field is required while searching deals created for the respective entities.</p>
Deal Creation From Date	<p>Used to search deals which are created from a particular date onwards.</p> <p>Note: By default, the system displays the date which is specified in the Deal Limits in Months option type of the C1-DEAL feature configuration. You can change the date if required.</p>	No
Deal Creation To Date	<p>Used to search deals which are created till a particular date.</p> <p>Note: By default, the system displays the date which is specified in the Deal Limits in Months option type of the C1-DEAL feature configuration. You can change the date if required.</p>	No
Created By	Used to search deals which are created by a particular user.	No

Field Name	Field Description	Mandatory (Yes or No)
	<p>Note:</p> <p>The Search (🔍) icon appears corresponding to this field. On clicking the Search icon, the User Search screen appears.</p> <p>On specifying the creator, the description of the creator appears corresponding to the Created By field.</p> <p>This field appears when the Deal Details option is selected from the Search By list.</p>	
Deal Effective Start date	<p>Used to search for deals whose proposed price list is effective from a particular date onwards.</p> <p>Note: This field appears when the Deal Details option is selected from the Search By list and the Advanced Search link at the upper right corner of the Search Deal zone is clicked.</p>	No
Deal Effective End Date	<p>Used to search for deals whose proposed price list is effective till a particular date.</p> <p>Note: This field appears when the Deal Details option is selected from the Search By list and the Advanced Search link at the upper right corner of the Search Deal zone is clicked.</p>	No
Proposed Revenue Filters	<p>Used to search for deals by specifying the proposed revenue amount in the deal level financial summary. The valid values are:</p> <ul style="list-style-type: none"> • Between - Used to search for deals whose proposed revenue amount falls between the specified range. • Greater Than - Used to search for deals whose proposed revenue amount in the deal level financial summary is greater than the specified revenue amount. • Less Than - Used to search for deals whose proposed revenue amount in the deal level financial summary is lesser than the specified revenue amount. <p>Note: This field appears when the Deal Details option is selected from the Search By list and the Advanced Search link at the upper right corner of the Search Deal zone is clicked.</p>	No

Field Name	Field Description	Mandatory (Yes or No)
Minimum Revenue Amount	<p>Used to search for deals by specifying the lower limit of the revenue amount in the deal level financial summary.</p> <p>Note: This field appears when the Between option is selected from the Proposed Revenue Filters list. If you specify the Maximum Revenue Amount, you must specify the Minimum Revenue Amount.</p>	No
Maximum Revenue Amount	<p>Used to search for deals by specifying the upper limit of the revenue amount in the deal level financial summary.</p> <p>Note: This field appears when the Between option is selected from the Proposed Revenue Filters list. If you specify the Minimum Revenue Amount, you must specify the Maximum Revenue Amount.</p>	No
Revenue Amount	<p>Used to search for deals by specifying the proposed revenue amount in the deal level financial summary.</p> <p>Note: This field appears when the Greater Than or the Less Than option is selected from the Proposed Revenue Filters list.</p>	No
Template Deal	<p>Used to search for deals which are used as a template for creating new deals in the system. The valid values are:</p> <ul style="list-style-type: none"> • No • Yes <p>Note: This field appears when the Deal Details option is selected from the Search By list and the Advanced Search link at the upper right corner of the Search Deal zone is clicked.</p>	No
Contracted Deal	<p>Used to search for contracted deals defined in the system. The valid values are:</p> <ul style="list-style-type: none"> • No • Yes 	No





Field Name	Field Description	Mandatory (Yes or No)
	<p>Note:</p> <p>A contracted deal is a deal whose price item pricing offered in the deal does not get affected if the price item pricing from the price list is changed in the system.</p> <p>This field appears when the Deal Details option is selected from the Search By list and the Advanced Search link at the upper right corner of the Search Deal zone is clicked.</p>	
Person ID	<p>Used to search deals which are created for a particular customer.</p> <p>Note: This field appears when the Customer Details option is selected from the Search By list.</p>	No
Customer Name	<p>Used to search deals which are created for customers having a particular name.</p> <p>Note: This field appears when the Customer Details option is selected from the Search By list.</p>	No
Person Identifier Type	<p>Used to search deals which are created for persons using a particular identifier type.</p> <p>Note: This field appears when the Customer Details option is selected from the Search By list.</p>	<p>Yes (Conditional)</p> <p>Note: If you enter person identifier as a search criteria, you have to select the person identifier type.</p>
Person Identifier	<p>Used to specify the value for the person identifier type for searching deals created for the persons.</p> <p>Note: This field appears when the Customer Details option is selected from the Search By list.</p>	<p>Yes (Conditional)</p> <p>Note: If you enter person identifier type as a search criteria, you have to specify the person identifier.</p>
Customer Segment	<p>Used to search deals which are created for customers associated to a particular business component.</p> <p>Note: This field appears when the Customer Details option is selected from the Search By list.</p>	No
Customer Tier	<p>Used to search deals created for customers which belong to a particular tier of the customer segment.</p>	No









Field Name	Field Description	Mandatory (Yes or No)
	Note: This field appears when the Customer Details option is selected from the Search By list.	
Relationship Manager	Used to search for deals which belong to a particular relationship manager in the system. Note: The Search (🔍) icon appears corresponding to the Relationship Manager field. On clicking the Search icon, the Fetch Relationship Manager window appears where you can search for a particular relationship manager. On specifying the relationship manager, the description of the relationship manager appears corresponding to the Relationship Manager field. This field appears when the Customer Details option is selected from the Search By list.	No
Account ID	Used to search deal which is created for a particular account. Note: This field appears when the Account Details option is selected from the Search By list.	No
Person Name	Used to search deals which are created for accounts of persons having a particular name. Note: This field appears when the Account Details option is selected from the Search By list.	No
Account Identifier Type	Used to search deals which are created for accounts using a particular identifier type. Note: This field appears when the Account Details option is selected from the Search By list.	Yes (Conditional) Note: If you enter account identifier as a search criteria, you have to select the account identifier type.
Account Identifier	Used to specify the value of the account identifier type for searching deals created for accounts. Note: This field appears when the Account Details option is selected from the Search By list.	Yes (Conditional) Note: If you enter account identifier type as a search criteria, you have to select the account identifier.



Field Name	Field Description	Mandatory (Yes or No)
Characteristic	<p>Used to search for a deal by specifying the deal characteristics. The valid values are:</p> <ul style="list-style-type: none"> • Bill ID • Contracted Deal • Deal Information • Deal To Do Type • Selection Type <p>Note:</p> <p>At a time, you can specify maximum five characteristics while searching for a deal.</p> <p>This field appears when the Deal Characteristics option is selected from the Search By list.</p>	No
Value	<p>Used to search for a deal by specifying the value of the characteristic selected from the Characteristic list.</p> <p>Note:</p> <p>This field appears when you select a characteristic from the Characteristic list.</p> <p>The Search (🔍) icon appears corresponding to the Value field when you select the Bill ID or the Deal Information option from the Characteristic list. On clicking the Search icon, the Bill Search or the Deal Information window appears where you can search for the respective characteristic value.</p> <p>If you select the Selection Type option from the Characteristic list, the following options appear in the Value list:</p> <ul style="list-style-type: none"> • Mandatory • Optional • Standard <p>If you select the Contracted Deal or the Deal To Do Type option from the Characteristic list, the following options appear in the Value list:</p> <ul style="list-style-type: none"> • No • Yes 	No

- **Search Results** - On clicking the **Search** button, a list of deals appear based on the specified search criteria. The **Search Results** section contains the following columns:

Column Name	Column Description
Deal Information	<p>Displays the concatenated string of information about the deal separated by a comma (,).</p> <p>Note:</p> <p>It has a link. On clicking the link, the Deal Information screen appears where you can view the details of the respective deal.</p> <p>The link appears in the Search Results section only for deals which have a single version. For deals having multiple versions, the link appears in the Deal Versions zone.</p>
Customer Information	<p>Displays the concatenated string of information about the main person for whom the deal is created in the system.</p> <p>Note:</p> <p>It has a link. On clicking the link, the Customer 360° Information or the Prospect Person screen appears where you can view the details of the respective person.</p> <p>The Customer 360° Information screen appears when you select the Account or Customer option from the Deal Entity list in the Search Criteria while searching for a deal. Whereas, the Prospect Person screen appears when you select the Prospect option from the Deal Entity list in the Search Criteria while searching for a deal.</p>
Deal Entity	<p>Indicates the entity for which the deal is created in the system. The valid values are:</p> <ul style="list-style-type: none"> • Account • Customer • Prospect
Start Date	Displays the date from when the deal is effective for the deal entity.
End Date	Displays the date till when the deal is effective for the deal entity.
Status	<p>Indicates the current status of the deal. The valid values are:</p> <ul style="list-style-type: none"> • Applied/Processed • Approved • Closed • Customer Accepted • Discarded • Draft • Error • Finalized • Fully Orchestrated • Hierarchy Creation Deferred • Inactive

Column Name	Column Description
	<ul style="list-style-type: none"> • Partially Orchestrated • Pending for Approval • Pending for Review • Pending Simulation • Pending for Orchestration • Ready for Approval • Rejected • Simulated • Simulation Deferred
Created By	Displays the user who has created the deal in the system.
View Approval Workflow	<p>On clicking the View Approval Workflow () icon, the Deal Approval Workflow screen appears where you can view the details of the approval workflow of the respective deal.</p> <p>Note: The Approval Workflow icon appears when a deal or its deal versions are in the Approved status or higher.</p>
Finalize Deal	<p>On clicking the Finalize Deal () icon, a message appears confirming whether you want to finalize the deal.</p> <p>Note: The Finalize Deal icon appears when a deal or its deal versions are in the Approved status or higher. The Finalize Deal () icon does not appear if the deal in the Inactive status.</p>
Ageing For Acceptance (In Days)	<p>Indicates the number of days between finalizing the deal by the relationship manager and the deal acceptance day by the relationship manager on receiving confirmation from the customer.</p> <p>Note: The number of days appears in the Ageing For Acceptance (In Days) column when a deal or its deal versions are in the Finalized status.</p>
Accept Deal	On clicking the Accept Deal () icon, the Deal Acceptance screen appears where you can accept the deal after receiving confirmation from the customer.

Column Name	Column Description
	<p>Note:</p> <p>On clicking the Save button on the Deal Acceptance screen, the deal is accepted in the system.</p> <p>The Accept Deal icon appears when a deal or its deal versions are in the Finalized status.</p> <p>The Accept Deal () icon does not appear if the deal is in the Inactive status.</p>
Reject Deal	<p>On clicking the Reject Deal () icon, the Deal Rejection screen appears where you can reject the deal after receiving confirmation from the customer.</p> <p>Note:</p> <p>On clicking the Save button on the Deal Rejection screen, the deal is rejected in the system.</p> <p>The Reject Deal icon appears when a deal or its deal versions are in the Finalized status.</p> <p>The Reject Deal () icon does not appear if the deal is in the Inactive status.</p>
Apply Back	<p>On clicking the Apply Back () icon, a message appears confirming whether you want to fully orchestrate the deal.</p> <p>Note:</p> <p>The Apply Back icon appears when a deal or its deal versions are in the Customer Accepted status.</p> <p>The Apply Back () icon does not appear if the deal is in the Inactive status.</p>
Print Deal	<p>On clicking the Print () icon, the Deal Extraction screen appears where you can filter the options as per your requirement and extract the deal information in the PDF or Excel format.</p>
Review Deal	<p>On clicking the Review Deal () icon, the Deal Review screen appears where you can add details about the deal at regular intervals for monitoring the deal.</p> <p>Note: You can review a deal when it is in the Pending for Review status.</p>
Profitability Details	<p>On clicking the Profitability Details () icon, the Deal Profitability screen appears where you can view the deal level, division level, and price item level profitability details about the deal.</p>

Column Name	Column Description
	<p>Note:</p> <p>You can view the profitability details of a deal when it is in the Simulated status.</p> <p>Also, the Profitability Details () icon appears in the Profitability Details column corresponding to a deal in the Search Results section when a single version of the deal is created in the system. For multiple deal versions, the Profitability Details () icon appears in the Profitability Details column corresponding to a deal version in the Deal Versions zone.</p>

<p>Note:</p> <p>By default, the Search Results section lists all the deals which are created by the user for the period as specified in the Deal Limits in Months option type of the C1-DEAL feature configuration.</p> <p>Pagination is used to display limited number of records in the Search Results section. You can use the navigation links, such as Previous and Next to navigate between pages.</p>

By default, the **Filter** area is hidden. You can view the **Filter** area by clicking the **Filters** () icon in the upper right corner of this zone.

On clicking the **Broadcast** () icon corresponding to a deal, the **Deal Versions** zone appears where you can view a list of deal versions created for the respective deal.

Also, you can select two deal versions for comparison by clicking the check box corresponding to the deals in the **Search Results** section or the **Deal Versions** zone.

On clicking the **Add to Compare** link after selecting two deal versions, the **Deal Comparison** zone appears where you can compare the deal versions.

Note: At a time, you can select only two deal versions for comparison.

Related Topics

For more information on...	See...
How to search for a deal	Searching for a Deal on page 2773
Deal Dashboard screen	Deal Dashboard on page 2757
Deal Versions zone	Deal Versions on page 2771
How to view the approval workflow details of a deal	Viewing the Approval Workflow Details of a Deal on page 2774
How to finalize a deal	Finalizing a Deal on page 2775
How to accept a deal	Accepting a Deal on page 2776
How to reject a deal	Rejecting a Deal on page 2777
How to extract a deal in the PDF or Excel format	Extracting a Deal in the PDF or Excel Format on page 2779
How to review a deal	Reviewing a Deal on page 2785

For more information on...	See...
Deal Profitability screen	Deal Profitability on page 2804
How to view the profitability details of a deal version	Viewing the Profitability Details of a Deal Version on page 2786
Deal Comparison zone	Deal Comparison on page 2772
How to compare two deal versions	Comparing Two Deal Versions on page 2787

Deal Versions

The **Deal Versions** zone allows you to view a list of deal versions created for a particular deal. It contains the following columns:

Column Name	Column Description
Deal Version Information	Displays the concatenated string of information about the deal version separated by a comma (.). Note: It has a link. On clicking the link, the Deal Information screen appears where you can view the details of the respective deal version.
Status	Indicates the current status of the deal version.
Creation Date	Displays the date when the deal version is created in the system.
Created By	Displays the user who has created the deal version in the system.
Proposed Revenue	Displays the revenue generated from the deal version.
Print Deal	On clicking the Print () icon, the Deal Extraction screen appears where you can select the options as per your requirement and extract the deal version information in the PDF or Excel format for printing.
Profitability Details	On clicking the Profitability Details icon, the Deal Profitability screen appears where you can view the deal level, division level, and price item level profitability details about the deal version. Note: You can view the profitability details of a deal version when it is in the Simulated status.

By default, the **Deal Versions** zone does not appear in the **Deal Dashboard** screen. It appears when you click the **Broadcast** () icon corresponding to a deal in the **Search Results** section of the **Search Deals** zone.

Also, you can select two deal versions for comparison by clicking the check box corresponding to the deal versions in the **Deal Versions** zone.

Related Topics

For more information on...	See...
How to search for a deal	Searching for a Deal on page 2773
Deal Dashboard screen	Deal Dashboard on page 2757
How to view the versions of a deal	Viewing the Versions of a Deal on page 2774
How to view the profitability details of a deal version	Viewing the Profitability Details of a Deal Version on page 2786

For more information on...	See...
How to compare two deal versions	Comparing Two Deal Versions on page 2787

Deal Comparison

The **Deal Comparison** zone lists the deal versions which you have selected for comparison. It contains the following columns:

Column Name	Column Description
Deal Information	<p>Displays the concatenated string of information about the deal for which the deal version is created in the system separated by a comma (,).</p> <p>Note: It has a link. On clicking the link, the Deal Information screen appears where you can view the details of the respective deal version.</p>
Customer Information	<p>Displays the concatenated string of information about the main person for whom the deal is created in the system.</p> <p>Note:</p> <p>It has a link. On clicking the link, the Customer 360° Information or the Prospect Person screen appears where you can view the details of the respective person.</p> <p>The Customer 360° Information screen appears when you select the deal version of a deal having the entity type as Account or Customer. Whereas, the Prospect Person screen appears when you select the deal version of a deal having the entity type as Account.</p>
Deal version	Displays the concatenated string of information about the deal version.
Deal Status	Indicates the current status of the deal for which the deal version is created.
Deal Revenue	Displays the revenue generated from the deal version.
Deal Creator ID	Displays the user who has created the deal in the system.

By default, the **Deal Comparison** zone does not appear in the **Deal Dashboard** screen. It appears when you select a deal or a deal version from the **Search Results** section or the **Deal Versions** zone respectively and click the **Add to Compare** link.

You can delete a deal version from the comparison list by clicking the **Delete** () icon corresponding to the respective deal version.

On clicking the **Compare** link, the **Deal Compare** screen appears with the comparison results.

Note:

At a time, you can select only two deal versions for comparison.

You cannot compare a deal version which is in the **Draft**, **Pending Simulation** or **Discarded** status.

You cannot compare a deal version of a deal which is in the **Draft**, **Pending Simulation** or **Discarded** status.

You cannot compare two deal versions having different currency codes.

Related Topics

For more information on...	See...
Deal Dashboard screen	Deal Dashboard on page 2757
Deal Versions zone	Deal Versions on page 2771
How to compare two deal versions	Comparing Two Deal Versions on page 2787

Searching for a Deal

Prerequisites

To search for a deal, you should have:

- Divisions defined in the application
- Deals or deal versions defined in the application
- Deals or deal versions associated with the division to which the user belongs
- Deal types defined in the application
- Deal entities defined in the application
- Customer segments and customer tiers defined in the application
- Person identifier types and person identifiers defined in the application
- Account identifier types and account identifiers defined in the application

Procedure

To search for a deal:

1. Click the **Menu** link in the **Application** toolbar.
A list appears.
2. From the **Main** menu, select **Deal Management** and then click **Deal Dashboard**.
The **Deal Dashboard** screen appears.
3. Enter the search criteria in the **Search Deal** zone.

Note: ORMB search engine supports wildcard search, where you can substitute the percentage (%) symbol as a stand in for any word or letter in a search criteria. You can use the ‘%’ wildcard character in all input fields except the date and ID fields. The ‘%’ wildcard character is suffixed automatically at the end of the partial search criteria. Therefore, you may or may not specify the wildcard character at the end of the partial search criteria. However, you have to prefix the wildcard character manually wherever required.

4. Click **Search**.
A list of deals that meet the search criteria appears in the **Search Results** section.

Note:

Pagination is used to display limited number of records in the **Search Results** section. You can use the navigation links, such as **Previous** and **Next** to navigate between pages.

By default, the **Search Results** section lists all the deals which are created by the user for the period as specified in the **Deal Limits in Months** option type of the **C1-DEAL** feature configuration.

You must specify at least one search criterion while searching for a deal. One more search criterion is required when you are searching for a deal using the deal entity or customer tier.

You must specify one more search criterion when you are searching for a deal using the division with the **Deal Details** option selected from the **Search By** list.

Related Topics

For more information on...	See...
Deal Dashboard screen	Deal Dashboard on page 2757
Search Deal zone	Search Deal on page 2758

Viewing the Versions of a Deal**Procedure**

To view the versions of a deal:

1. Search for the deal whose versions you want to view in the **Search Deal** zone of the **Deal Dashboard** screen.
2. In the **Search Results** section, click the **Broadcast** () icon corresponding to the deal whose deal versions you want to view.

The **Deal Versions** zone appears.

3. View the versions of the deal in the **Deal Versions** zone.

Related Topics

For more information on...	See...
How to search for a deal	Searching for a Deal on page 2773
Search Deal zone	Search Deal on page 2758
Deal Dashboard screen	Deal Dashboard on page 2757
Deal Versions zone	Deal Versions on page 2771

Viewing the Approval Workflow Details of a Deal**Procedure**

To view the approval workflow details of a deal:

1. Search for the deal whose approval workflow details you want to view in the **Search Deal** zone of the **Deal Dashboard** screen.
2. In the **Search Results** section, click the **View Approval Workflow** () icon in the **View Approval Workflow** column corresponding to the deal whose approval workflow details you want to view.

The **Deal Approval Workflow** screen appears.

- View the approval workflow details of the deal in the **Deal Approval Workflow** screen.

Note: You cannot view the approval workflow status of a deal which is in the **Draft, Pending Simulation, Simulation Deferred, Simulated, Hierarchy Creation Deferred, or Discarded** status.

Related Topics

For more information on...	See...
How to search for a deal	Searching for a Deal on page 2773
Deal Dashboard screen	Deal Dashboard on page 2757
Search Deal zone	Search Deal on page 2758
Deal Approval Workflow screen	Deal Approval Workflow on page 2814

Finalizing a Deal

Procedure

To finalize a deal:

- Do either of the following:

If you want to...	Then...
Finalize a deal from the Deal Dashboard screen	<ol style="list-style-type: none"> Search for the deal in the Search Deal zone of the Deal Dashboard screen. In the Search Results section, click the Finalize () icon in the Finalize Deal column corresponding to the deal which you want to finalize.
Finalize a deal from the Deal Information screen	<ol style="list-style-type: none"> Search for the deal in the Search Deal zone of the Deal Dashboard screen. In the Search Results section, click the link in the Deal Information column corresponding to the deal which you want to finalize. The Deal Information screen appears. In the Simulation Details zone, click the Finalize Deal button.

A message appears confirming whether you want to finalize the deal.

- Click **OK**.

The deal is finalized.

Note:

You can finalize a deal when it is in the **Approved** status.

After finalizing a deal, the status of the deal changes to **Finalized**.

Related Topics

For more information on...	See...
How to search for a deal	Searching for a Deal on page 2773
Deal Dashboard screen	Deal Dashboard on page 2757
Search Deal zone	Search Deal on page 2758
Deal Information screen	Deal Information on page 2815
Simulation Details zone	Simulation Details on page 2847

Accepting a Deal

Procedure

To accept a deal:

1. Do either of the following:

If you want to...	Then...
Accept a deal from the Deal Dashboard screen	<ol style="list-style-type: none"> 1. Search for the deal in the Search Deal zone of the Deal Dashboard screen. 2. In the Search Results section, click the Accept () icon in the Accept Deal column corresponding to the deal which you want to accept.
Accept a deal from the Deal Information screen	<ol style="list-style-type: none"> 1. Search for the deal in the Search Deal zone of the Deal Dashboard screen. 2. In the Search Results section, click the link in the Deal Information column corresponding to the deal which you want to accept. The Deal Information screen appears. 3. In the Simulation Details zone, click the Accept Deal button.

The **Deal Acceptance** screen appears. It contains the following fields:

Field Name	Field Description	Mandatory (Yes or No)
Status	Displays the status of the deal. The valid value is: <ul style="list-style-type: none"> • Customer Accepted 	Not applicable
Effective Start Date	Used to specify the date from when the deal is effective for the customer.	Yes

Field Name	Field Description	Mandatory (Yes or No)
	<p>Note:</p> <p>Earlier, the Effective Start Date was defaulted to the Deal Start Date. Now, while accepting a deal, the system defaults either of the following date:</p> <ul style="list-style-type: none"> Deal start date when the deal start date is equal to or later than the system date System date when the deal start date is earlier than the system date <p>You can then edit the Effective Start Date, if required.</p>	
Effective End Date	Used to specify the date till when the deal is effective for the customer.	No
Comments	Used to specify information about accepting the deal.	No

- Enter the required details in the **Deal Acceptance** screen.
- Click **Save**.

The deal is accepted.

Note:

You can accept a deal only when it is in the **Finalized** status.

After accepting a deal, the status of the deal changes to **Customer Accepted**.

Related Topics

For more information on...	See...
How to search for a deal	Searching for a Deal on page 2773
Deal Dashboard screen	Deal Dashboard on page 2757
Search Deal zone	Search Deal on page 2758
Deal Information screen	Deal Information on page 2815
Simulation Details zone	Simulation Details on page 2847

Rejecting a Deal

Procedure

To reject a deal:

- Do either of the following:

If you want to...	Then...
Reject a deal from the Deal Dashboard screen	<ol style="list-style-type: none"> Search for the deal in the Search Deal zone of the Deal Dashboard screen.

If you want to...	Then...
	<ol style="list-style-type: none"> In the Search Results section, click the Reject (✖) icon in the Reject Deal column corresponding to the deal which you want to reject.
Reject a deal from the Deal Information screen	<ol style="list-style-type: none"> Search for the deal in the Search Deal zone of the Deal Dashboard screen. In the Search Results section, click the link in the Deal Information column corresponding to the deal which you want to reject. The Deal Information screen appears. In the Simulation Details zone, click the Reject Deal button.

The **Deal Rejection** screen appears. It contains the following fields:

Field Name	Field Description	Mandatory (Yes or No)
Status	Displays the status of the deal. The valid value is: <ul style="list-style-type: none"> Rejected 	Not applicable
Comments	Used to specify information about rejecting the deal.	No

- Enter the required details in the **Deal Rejection** screen
- Click **Save**.

The deal is rejected.

Note:

You can reject a deal only when it is in the **Finalized** status.
After rejecting a deal, the status of the deal changes to **Rejected**.

Related Topics

For more information on...	See...
How to search for a deal	Searching for a Deal on page 2773
Deal Dashboard screen	Deal Dashboard on page 2757
Search Deal zone	Search Deal on page 2758
Deal Information screen	Deal Information on page 2815
Simulation Details zone	Simulation Details on page 2847

Orchestrating a Deal

Procedure

To orchestrate a deal:

1. Do either of the following:

If you want to...	Then...
Orchestrate a deal from the Deal Dashboard screen	<ol style="list-style-type: none"> 1. Search for the deal in the Search Deal zone of the Deal Dashboard screen. 2. In the Search Results section, click the Apply Back  icon in the Apply Back column corresponding to the deal which you want to orchestrate.
Orchestrate a deal from the Deal Information screen	<ol style="list-style-type: none"> 1. Search for the deal in the Search Deal zone of the Deal Dashboard screen. 2. In the Search Results section, click the link in the Deal Information column corresponding to the deal which you want to orchestrate. The Deal Information screen appears. 3. In the Simulation Details zone, click the Apply Back button.

A message appears confirming whether you want to apply back the deal.

2. Click **OK**.

The deal is orchestrated.

Note:

You can orchestrate a deal when it is in the **Customer Accepted** status.

After orchestrating a deal, the status of the deal changes to **Fully Orchestrated**.

Related Topics



For more information on...	See...
How to search for a deal	Searching for a Deal on page 2773
Deal Dashboard screen	Deal Dashboard on page 2757
Search Deal zone	Search Deal on page 2758
Deal Information screen	Deal Information on page 2815
Simulation Details zone	Simulation Details on page 2847

Extracting a Deal in the PDF or Excel Format

Procedure

To extract a deal in the pdf or excel format:

1. Do either of the following:

If you want to...	Then...
Extract a deal in the PDF or Excel format from the Deal Dashboard screen	<ol style="list-style-type: none"> 1. Search for the deal in the Search Deal zone of the Deal Dashboard screen. 2. In the Search Results section, click the Print () icon in the Print Deal column corresponding to the deal which you want to extract in the pdf or excel format. <p>Note: If the deal has multiple versions, click the Print () icon in the Print Deal column corresponding to the deal version in the Deal Versions zone.</p>
Extract a deal in the PDF or Excel format from the Deal Information screen	<ol style="list-style-type: none"> 1. Search for the deal in the Search Deal zone of the Deal Dashboard screen. 2. In the Search Results section, click the link in the Deal Information column corresponding to the deal which you want to extract in the pdf or excel format. <p>Note: If you want to extract the deal version in the pdf of excel format, click the link in the Deal Version Information column corresponding to the deal version from the Deal Versions zone.</p> <p>The Deal Information screen appears.</p> <ol style="list-style-type: none"> 3. In the Simulation Details zone, click the Print Deal button.
Extract a deal in the PDF or Excel format from the Deal Approver Dashboard screen	<ol style="list-style-type: none"> 1. Search for the deal in the Search Deal zone of the Deal Approver Dashboard screen. 2. In the Search Results section, click the Print () icon in the Print Deal column corresponding to the deal which you want to extract in the pdf or excel format.

The **Deal Extraction** screen appears. It contains the following fields:

Field Name	Field Description	Mandatory (Yes or No)
Extract Format	Used to specify the format in which you want to extract the deal information. The valid values are: <ul style="list-style-type: none"> • Excel • PDF 	Yes (Conditional) <p>Note: This field is required while extracting a deal in the pdf or excel format.</p>

Field Name	Field Description	Mandatory (Yes or No)
Extract Type	<p>Used to indicate the type of deal information that you want to extract for publishing. The valid values are:</p> <ul style="list-style-type: none"> • External - Used to extract deal information which is published to the customer for approval. It contains the following details: <ol style="list-style-type: none"> 1. Extraction information i.e. the extraction date-time and the user who has done the extraction. 2. Details of the filters selected for extraction. 3. Deal details such as the deal creator user ID, deal creation date and time, deal ID, deal type, prospect/customer, currency, deal status etc. 4. Customer hierarchy, accounts and price item details as per the filter option selected in the Deal Extraction screen. 5. Price item details such as the original price with assignment level, commitments, negotiated price with assignment level, approval status, etc. 6. Terms and conditions. <div data-bbox="688 1144 1182 1497" style="border: 1px solid black; padding: 5px;"> <p>Note:</p> <p>The External extract type controls the extraction of certain data which may or may not be published to the customer.</p> <p>You can select the External option from the Extract Type list when the deal is in the Finalized, Customer Accepted, Rejected, Fully Orchestrated, Pending for Review, or Closed status.</p> </div>	<p>Yes (Conditional)</p> <div data-bbox="1195 262 1469 405" style="border: 1px solid black; padding: 5px;"> <p>Note: This field is required while extracting a deal in the pdf or excel format.</p> </div>
	<ul style="list-style-type: none"> • Internal - Used to extract deal information which is published for internal reviews and validations. It contains the following details: <ol style="list-style-type: none"> 1. Deal summary details and Division summary details with the applicable cost, profitability, revenue and other calculations. 2. Price item details such as the cost and revenue details etc. 3. Adhoc revenue and cost entries. 	

Field Name	Field Description	Mandatory (Yes or No)
	<p>Note:</p> <p>By default, the Internal option is selected from the Extract Type list for deals which are not in the Finalized, Customer Accepted, Rejected, Fully Orchestrated, Pending for Review, or Closed status.</p> <p>The list includes only those values which are present in the DEAL_EXTRACT_TYPE_FLG lookup field.</p>	
Extract Filter	<p>Used to indicate the price item information that you want to extract in the pdf or excel format. The valid values are:</p> <ul style="list-style-type: none"> • Account • Additional Filter Criteria • All • Customer • Division • Only Hierarchy • Price Assignment Level • Price Item • Price Item Group <p>Note: The list includes only those values which are present in the DEAL_EXTRACT_FILTER_FLG lookup field.</p>	<p>Yes (Conditional)</p> <p>Note: This field is required while extracting a deal in the pdf or excel format.</p>

In addition, the **Deal Extraction** screen contains the following fields:

Field Name	Field Description	Mandatory (Yes or No)
Account ID	<p>Used to specify the persons or prospects account for which you want to extract the price item pricing details.</p> <p>Note:</p> <p>The Search (🔍) icon appears corresponding to this field. On clicking the Search icon, the Prospect Account Search window appears where you can search for the respective account.</p> <p>This field appears when you select the Account option from the Extract Filter list.</p>	<p>Yes (Conditional)</p> <p>Note: This field is required while extracting the proposed price item pricing details of an account.</p>

Field Name	Field Description	Mandatory (Yes or No)
Price Item	<p>Used to specify the price item for which you want to extract the pricing details.</p> <p>Note:</p> <p>The Search (🔍) icon appears corresponding to this field. On clicking the Search icon, the Price Item Search window appears where you can search for the respective price item.</p> <p>This field appears when you select the Account, Customer, and Price Item options from the Extract Filter list.</p>	No
Price Item Group Code	<p>Used to specify the root level hierarchy entity for which you want to extract the price item pricing details.</p> <p>Note:</p> <p>The Search (🔍) icon appears corresponding to this field. On clicking the Search icon, the Hierarchy Entity Search window appears where you can search for the respective root level hierarchy entity.</p> <p>This field appears when you select the Account, Customer, and Price Item Group options from the Extract Filter list.</p>	No
Proposed Price Assignment Level	<p>Used to extract the proposed price item pricing details for a particular assignment level.</p> <p>Note:</p> <p>The list includes only those values which are present in the PA_LVL_FLG lookup field.</p> <p>This field appears when you select the Account, Customer, Price Assignment Level, Price Item, and Price Item Group options from the Extract Filter list.</p> <p>This field is disabled when you select the Show Price Assignment for Child Entities field check box.</p>	No
Show Price Assignment for Child Entities	<p>Used to indicate whether you want to extract the proposed price item price assignment details of the non-root level hierarchy entity.</p> <p>Note: This field appears when you select the Account, Customer, Price Assignment Level, Price Item, and Price Item Group options from the Extract Filter list.</p>	No

Field Name	Field Description	Mandatory (Yes or No)
Current Approval User ID	Used to extract the details of the proposed price item pricing which is approved by a particular user.	Yes (Conditional)
	<p>Note:</p> <p>The Search (🔍) icon appears corresponding to this field. On clicking the Search icon, the User Search window appears where you can search for the respective root user.</p> <p>This field appears when you select the Additional Filter Criteria option from the Extract Filter list.</p> <p>This field is disabled when you specify the Price Item Manager To Do Role or Price Approval Status.</p>	<p>Note: This field is required while extracting the proposed price item pricing details approved by a particular user.</p>
Price Item Manager To Do Role	Used to extract the details of the proposed price item pricing which is assigned using a particular price item manager To Do role.	Yes (Conditional)
	<p>Note:</p> <p>This field appears when you select the Additional Filter Criteria option from the Extract Filter list.</p> <p>This field is disabled when you specify the Current Approval User ID or Price Approval Status.</p>	<p>Note: This field is required while extracting the proposed price item pricing details assigned to a particular price item manager To Do role.</p>
Price Approval Status	Used to extract the details of the proposed price item pricing which are in a particular status. The valid values are:	Yes (Conditional)
	<ul style="list-style-type: none"> • Approved • Approved-Existing • Approved-Recommended • Error • Initial • Unapproved <p>Note:</p> <p>This field appears when you select the Additional Filter Criteria option from the Extract Filter list.</p> <p>This field is disabled when you specify the Current Approval User ID or Price Item Manager To Do Role.</p>	<p>Note: This field is required while extracting the details of the proposed price item pricing in a particular status.</p>
Person ID	Used to extract the details of the proposed price items pricing of a particular person.	Yes (Conditional)

Field Name	Field Description	Mandatory (Yes or No)
	<p>Note:</p> <p>The Search (🔍) icon appears corresponding to this field. On clicking the Search icon, the Prospect Person Search window appears where you can search for the respective person.</p> <p>This field appears when you select the Additional Filter Criteria option from the Extract Filter list.</p>	<p>Note: This field is required while extracting the details of the proposed price item pricing of a particular person.</p>
Division	<p>Used to extract the details of the proposed price items pricing from a particular division.</p> <p>Note: This field appears when you select the Customer option from the Extract Filter list.</p>	<p>Yes (Conditional)</p> <p>Note: This field is required while extracting the details of the proposed price item pricing from a particular division.</p>

2. Enter the required details in the **Deal Extraction** screen.
3. Click **Extract**.

The deal is extracted in the pdf or excel format.

Note: You cannot extract a deal which is in the **Discarded** status.

Related Topics

For more information on...	See...
How to search for a deal	Searching for a Deal on page 2773
Deal Dashboard screen	Deal Dashboard on page 2757
Search Deal zone	Search Deal on page 2758
Deal Information screen	Deal Information on page 2815
Deal Approver Dashboard screen	Deal Approver Dashboard on page 3066
Simulation Details zone	Simulation Details on page 2847

Reviewing a Deal

Procedure

To review a deal:

1. Search for the deal in the **Deal Dashboard** screen.
2. In the **Search Results** section, click the **Review Deal** (📄) icon in the **Review Deal** column corresponding to the deal which you want to review.

The **Deal Review** screen appears. It contains the following fields:

Field Name	Field Description	Mandatory (Yes or No)
Status	Displays the status of the deal. The valid values is: <ul style="list-style-type: none"> Pending for Review 	Not applicable
Comment	Used to specify information about reviewing the deal.	Yes

- Enter the required details in the **Deal Review** screen.

Note: You can review a deal when it is in the **Pending for Review** status.

- Click **Save**.

The deal is reviewed.

Related Topics

For more information on...	See...
Deal Dashboard screen	Deal Dashboard on page 2757

Viewing the Profitability Details of a Deal Version

Procedure



To view the profitability details of a deal version:

- Search for the deal in the **Search Deal** zone of the **Deal Dashboard** screen.
- In the **Search Results** section, click the **Broadcast** () icon corresponding to the deal whose deal versions profitability details you want to view.

The **Deal Versions** zone appears.

- In the **Deal Versions** zone, click the **Profitability Details** () icon from the **Profitability Details** column corresponding to the deal version whose profitability details you want to view.

The **Deal Profitability** screen appears.

Note: The **Profitability Details** () icon for deals which do not have multiple versions appears in the **Profitability Details** column corresponding to the deal in the **Search Results** section of the **Search Deal** zone as well as in the **Deal Versions** zone. Whereas, the **Profitability Details** () icon for deals which have multiple versions appears in the **Profitability Details** column corresponding to the deal version in the **Deal Versions** zone.

- View the profitability details of the deal version in the **Deal Profitability** screen.

Note: You can view the profitability details of a deal or a deal version when it is in the **Simulated** status.

Related Topics

For more information on...	See...
How to search for a deal	Searching for a Deal on page 2773
How to view the versions of a deal	Viewing the Versions of a Deal on page 2774
Deal Dashboard screen	Deal Dashboard on page 2757
Search Deal zone	Search Deal on page 2758

For more information on...	See...
Deal Versions zone	Deal Versions on page 2771
Deal Profitability screen	Deal Profitability on page 2804

Comparing Two Deal Versions

Procedure

To compare two deal versions:

1. Search for the deal in the **Search Deal** zone of the **Deal Dashboard** screen.
2. In the **Search Results** section, click the **Broadcast** () icon corresponding to the deal whose deal version you want to compare.

The **Deal Versions** zone appears.

3. Select the check box corresponding to the deal version that you want to compare.

Note: Select the check box corresponding to the deal in the **Search Results** section of the **Search Deal** zone if only one deal version is created for the deal.

4. Click the **Add to Compare** link available in the **Deal Versions** zone.

The **Deal Comparison** zone appears enlisting the selected deal version.

Note: Click the **Add to Compare** link available in the **Search Deal** zone if you are selecting a deal from the **Search Results** section of the **Search Deal** zone for comparison.

5. Repeat steps 1 to 4 for selecting the other deal version which you want to use for comparison.
6. Click the **Compare** link available in the **Deal Comparison** zone.

The **Deal Compare** screen appears.

7. View the comparison report of the selected deals or deal versions in the **Deal Compare** screen.

Note: You can compare two deals or deal versions when they are in the **Simulated** status and are defined using the same currency.

Related Topics

For more information on...	See...
How to search for a deal	Searching for a Deal on page 2773
Search Deal zone	Search Deal on page 2758
Deal Dashboard screen	Deal Dashboard on page 2757
Deal Versions zone	Deal Versions on page 2771
Deal Comparison zone	Deal Comparison on page 2772
Deal Compare screen	Deal Compare on page 2798

Viewing the Deal Metrics in the Tiles Chart

Procedure

To view the deal metrics in the tiles chart:

1. Click the **Menu** link in the **Application** toolbar.

A list appears.

- From the **Main** menu, select **Deal Management** and then click **Deal Dashboard**.

The **Deal Dashboard** screen appears.

- In the **Deal Metrics** zone, enter the filter criteria using which you want to view the deal metrics.

Note: By default, the deal metrics appears for the period which is specified in the **Deal Limits in Months** option type of the **C1-DEAL** feature configuration. You can change the period if required.

- Click **Apply**.
- Ensure that the toggle switch is towards the **Tiles** option.
- View the tiles chart in the **Deal Metrics** zone.

Related Topics

For more information on...	See...
Deal Dashboard screen	Deal Dashboard on page 2757
Deal Metrics zone	Deal Metrics on page 2757

Viewing the Deal Count in the Bar Chart

Procedure

To view the deal count in the bar chart:

- Click the **Menu** link in the **Application** toolbar.
A list appears.
- From the **Main** menu, select **Deal Management** and then click **Deal Dashboard**.
The **Deal Dashboard** screen appears.
- In the **Deal Metrics** zone, enter the filter criteria using which you want to view the deal metrics.

Note: By default, the deal metrics appears for the period which is specified in the **Deal Limits in Months** option type of the **C1-DEAL** feature configuration. You can change the period if required.

- Click **Apply**.
- Ensure that the toggle switch is towards the **Chart** option.
- View the deal count for the existing account, existing customer, and prospect in the bar chart of the **Deal Metrics** zone.

Related Topics

For more information on...	See...
Deal Dashboard screen	Deal Dashboard on page 2757
Deal Metrics zone	Deal Metrics on page 2757

Viewing the Deal Revenue in the Line Chart

Procedure

To view the deal revenue in the line chart:

- Click the **Menu** link in the **Application** toolbar.

A list appears.

- From the **Main** menu, select **Deal Management** and then click **Deal Dashboard**.

The **Deal Dashboard** screen appears.

- In the **Deal Metrics** zone, enter the filter criteria using which you want to view the deal metrics.

Note: By default, the deal metrics appears for the period which is specified in the **Deal Limits in Months** option type of the **C1-DEAL** feature configuration. You can change the period if required.

- Click **Apply**.
- Ensure that the toggle switch is towards the **Chart** option.
- View the deal revenue for the existing account, existing customer, and prospect in the line chart of the **Deal Metrics** zone.

Related Topics

For more information on...	See...
Deal Dashboard screen	Deal Dashboard on page 2757
Deal Metrics zone	Deal Metrics on page 2757

Viewing Statistics of Deals in a Particular Status

Procedure

To view the statistics of deals in a particular status:

- Click the **Menu** link in the **Application** toolbar.

A list appears.

- From the **Main** menu, select **Deal Management** and then click **Deal Dashboard**.

The **Deal Dashboard** screen appears.

- In the **Deal Metrics** zone, enter the filter criteria using which you want to view the deal metrics.

Note: By default, the deal metrics appears for the period which is specified in the **Deal Limits in Months** option type of the **C1-DEAL** feature configuration. You can change the period if required.

- Click **Apply**.

The tiles chart for the deal metrics appears in the **Deal Metrics** zone as per the specified filter criteria.

- Click on the tile whose deal statistics you want to view for a particular status.

The pie chart appears in the **Deal Statistics** zone.

- View the statistics of deals in a particular status for the existing account, existing customer, and prospect in the **Deal Statistics** zone.

Related Topics

For more information on...	See...
Deal Dashboard screen	Deal Dashboard on page 2757
Deal Metrics zone	Deal Metrics on page 2757
Deal Statistics zone	Deal Statistics on page 2758

Defining a Deal

Prerequisites

To define a deal, you should have:

- Entities (i.e. customers, accounts, and prospects) defined in the application
- Deal identifiers defined in the application
- Deal types defined in the application
- Currencies defined in the application
- Values defined for **Review Frequency**, **Deal Frequency**, and **Usage Period** in the **REVIEW_FREQUENCY_FLG**, **FREQUENCY_FLG**, and **USAGE_PRIOD_FLG** lookup fields respectively
- Terms and conditions defined in the application
- Products defined in the application
- Characteristic types defined in the application (where the characteristic entity is set to **Deal**)
- Approval workflow reasons configured in the system.

Procedure

To define a deal:

1. Click the **Menu** link in the **Application** toolbar.

A list appears.

2. From the **Main** menu, select **Deal Management** and then click **Deal Dashboard**.

The **Deal Dashboard** screen appears.

3. In the **Deal Dashboard** screen, click the **Create Deal** button.

The **Deal Information - Deal** page appears. It contains the following zones:

- [Search Entity](#) on page 2816
- [Deal](#) on page 2822

Note: By default, the **Deal** zone does not appear in the **Deal Information - Deal** page. It appears when you click the **Broadcast** () icon corresponding to an entity (i.e. customer, account, or prospect) in the **Search Results** section of the **Search Entity** zone.

4. Search for the entity (i.e. customer, account, or prospect person) in the **Search Entity** zone for which you want to define a deal.
5. Click the **Broadcast** () icon corresponding to the entity (i.e. customer, account, or prospect) in the **Search Results** section for which you want to define a deal.

The **Deal** zone appears. It contains the following sections:

- **Main** - Used to specify basic details about the deal.
- **Product** - Used to associate reference products which you want the accounts of the deal entity to be enrolled.
- **Characteristics** - Used to define the characteristics for the deal.

The **Main** section contains the following fields:

Field Name	Field Description	Mandatory (Yes or No)
Deal Entity Information	Displays information about the entity (i.e. the customer, account, or prospect person) for which you want to define a deal.	Not applicable
Deal ID	Displays the deal ID. Note: The deal ID is generated automatically when you click the Save button in the Deal zone.	Not applicable
Contracted Deal	Used to indicate that the change in the price item pricing from the price list does not affect the price item pricing offered in the deal created for an existing customer, account, or prospect.	No
Copy Template	Used to indicate the deal template which you want to use for creating the deal. Note: The Search (🔍) icon appears corresponding to the Copy Template field. On clicking the Search icon, the Copy From window appears where you can select the respective details from the template.	No
Deal Entity	Indicates the entity (i.e. the customer, account, or prospect person) for which you want to create a deal. The valid values are: <ul style="list-style-type: none"> • Account • Customer • Prospect Note: This field cannot be edited. The list includes only those values which are present in the DEAL_ENTITY_TYPE_FLG lookup field.	Not applicable
Status	Indicates the current status of the deal. Note: This field cannot be edited. The value of this field is automatically populated when you click the Save button in the Deal zone. The list includes only those values which are present in the DEAL_STATUS lookup field.	Not applicable

Field Name	Field Description	Mandatory (Yes or No)
Customer Segment	<p>Indicates the business component to which the entity (i.e. the customer, account, or prospect person) belongs.</p> <p>Note: This field cannot be edited. The value of this field is set to the value that is specified in the Person screen. The list includes only those values which are present in the CUST_SEG_FLG lookup field.</p>	Not applicable
Customer Tier	<p>Indicates the customer tier to which the entity (i.e. the customer, account, or prospect person) belongs.</p> <p>Note: This field cannot be edited. The value of this field is set to the value that is specified in the Person screen. The list includes only those values which are present in the CUST_TIER_FLG lookup field.</p>	Not applicable
Access Group	<p>Indicates the user group that can view and edit the details of the entity (i.e. the customer, account, or prospect person).</p> <p>Note: The value of this field is set to the value that is specified in the Person screen.</p>	Not applicable
Division	<p>Indicates the division to which the entity (i.e. the customer, account, or prospect person) is associated.</p> <p>Note: This field cannot be edited. The value of this field is set to the value that is specified in the Person screen.</p>	Not applicable
Deal Identifier	Used to specify the primary identifier using which you want to create a deal in the system.	Yes

Field Name	Field Description	Mandatory (Yes or No)
	<p>Note:</p> <p>You should ensure that every deal has a unique deal identifier.</p> <p>An error message appears when you save a deal with a deal identifier which is already used while creating a deal.</p>	
Deal Type	<p>Used to indicate the deal type using which you want to create a deal in the system.</p> <p>Note:</p> <p>The Search (🔍) icon appears corresponding to the Deal Type field. On clicking the Search icon, the Deal Type Search window appears.</p> <p>On specifying the deal type, the description of the deal type appears corresponding to the Deal Type field.</p> <p>The Deal Type Search window lists only those deal types having the Division, Customer Segment, and Customer Tier combination which best fits with the Division, Customer Segment, and Customer Tier combination as specified in the Person screen of the entity (i.e. the customer, account, or prospect person).</p>	Yes
Deal Currency	<p>Used to specify the currency in which you want to calculate the deal or division specific financial summary and profitability of the deal.</p> <p>Note: The list includes only those currencies which are already defined in the system.</p>	Yes
Simulation Type	<p>Used to indicate the simulation type using which you want to analyze the cost, revenue, and profitability of the deal. The valid values are:</p> <ul style="list-style-type: none"> • Account • Customer • Deal 	Yes
Include Hierarchy	<p>Used to indicate whether you want to include the child persons, grandchild persons, and their accounts as well as the prospect persons and prospect accounts in the customer hierarchy while creating a deal.</p>	No

Field Name	Field Description	Mandatory (Yes or No)
	<p>Note:</p> <p>This option appears only when the Deal Entity is set to Customer and the Simulation Type is set to Customer.</p> <p>By default, the Include Hierarchy check box is selected when you are defining a deal.</p>	
Start Date	<p>Used to specify the date from when the deal is effective for the entity (i.e. the customer, account, or prospect person).</p> <p>Note: This date is also used as the Effective Start Date for the proposed price list assignment and Start Date for proposed product enrollment.</p>	Yes
Price Selection Date	Used to specify the date from when the price lists, pricing assignments, and product enrollments are effective for simulation.	Yes
End Date	Used to specify the date till when the deal is effective for the entity (i.e. the customer, account, or prospect person).	No
Review Frequency	<p>Used to indicate the timely monitoring of the deal usage as per the commitments made by the customer.</p> <p>Note:</p> <p>The list includes only those values which are present in the REVIEW_FREQUENCY_FLG lookup field.</p>	No
Deal Frequency	<p>Used to indicate the duration in which you want to simulate the deal for calculating the financial summary and profitability of the deal. The valid values are:</p> <ul style="list-style-type: none"> • Biannually • Monthly • Quarterly • Yearly <p>Note: The list includes only those values which are present in the FREQUENCY_FLG lookup field.</p>	Yes
Usage Period	Used to indicate the period for which you want to aggregate the deal data to determine the scope of the deal. The valid values are:	Yes

Field Name	Field Description	Mandatory (Yes or No)
	<ul style="list-style-type: none"> • Biannually • Monthly • Quarterly • Yearly <p>Note: The list includes only those values which are present in the USAGE_PERIOD_FLG lookup field.</p>	
Deal Description	Used to specify the description for the deal.	No
Deal Version Description	Used to specify the description for the deal version.	No
Skip Reference	<p>Used to indicate whether you want to use a deal which is already created in the system as a reference for copying the pricing and commitments in the deal or not.</p> <p>Note: If you select the check box corresponding to the Skip Reference field, the system will direct you to the Pricing/Commitments page to define the price lists, price assignments, and product enrollments for the deal.</p>	No
Skip Questionnaire	<p>Used to indicate whether you want to derive references for the deal using the questions of the questionnaire template associated with the deal type which is used for creating the deal.</p> <p>Note: The system considers the questionnaire template specified in the deal type only when it is effective on the deal start date.</p>	No

In addition, the **Deal** zone contains the following buttons:

Button Name	Button Description
Save as Template	<p>Used to save the deal as a template for defining other deals in the system.</p> <p>By default, the Save as Template button does not appear in the Deal zone. It appears only when the Change access mode is provided for the C1-DEALTEMPLATE application service to a user group. Users who belong to such user group can only view the Save as Template button in the Deal zone while creating a deal. If the user belongs to the user group which does not have the Change access mode provided for the C1-DEALTEMPLATE application service, the Save as Template button is disabled while creating a deal.</p> <p>Note: On clicking the Save as Template button, the system, by default, sets the Template Deal field to Y while saving the deal information.</p>
Save	Used to save the deal in the system.

Button Name	Button Description
	Note: On clicking the Save button, the system sets the Template Deal field to N while saving the deal information.
Next	Used to navigate to the next page.

6. Enter the required details in the **Main** section.
7. Associate terms and conditions with the deal, if required.
8. Recommend products to which the accounts in the customer hierarchy can be enrolled, if required.
9. Define characteristics for the deal, if required.
10. Click the **Save** button.

The deal is defined.

Related Topics

For more information on...	See...
Deal Dashboard screen	Deal Dashboard on page 2757
Deal Information - Deal page	Deal Information - Deal on page 2816
How to associate terms and conditions with a deal	Associating the Terms and Conditions with a Deal on page 3038
Recommending a product for a deal	Recommending a Product for a Deal on page 2830
How to define a characteristic for a deal	Defining a Characteristic for a Deal on page 2831

Creating a Deal using a Deal Template

Prerequisites

To create a deal using a deal template, you should have:

- Deal templates defined in the application
- Deal identifiers defined in the application
- Deal types defined in the application
- Currencies defined in the application
- Values defined for **Review Frequency**, **Deal Frequency**, and **Usage Period** in the **REVIEW_FREQUENCY_FLG**, **FREQUENCY_FLG**, and **USAGE_PRIOD_FLG** lookup fields respectively
- Terms and conditions defined in the application
- Products defined in the application
- Characteristic types defined in the application (where the characteristic entity is set to **Deal**)

Procedure

To create a deal from a deal template:

1. Click the **Menu** link in the **Application** toolbar.
A list appears.
2. From the **Main** menu, select **Deal Management** and then click **Deal Dashboard**.
The **Deal Dashboard** screen appears.

3. In the **Deal Dashboard** screen, click the **Create Deal** button.

The **Deal Information - Deal** page appears. It contains the following zones:

- [Search Entity](#) on page 2816
- [Deal](#) on page 2822

Note: By default, the **Deal** zone does not appear in the **Deal Information - Deal** page. It appears when you click the **Broadcast** () icon corresponding to an entity (i.e. customer, account, or prospect) in the **Search Results** section of the **Search Entity** zone.

4. Search for the entity (i.e. customer, account, or prospect person) in the **Search Entity** zone for which you want to define a deal.
5. Click the **Broadcast** () icon corresponding to the entity (i.e. customer, account, or prospect) in the **Search Results** section for which you want to define a deal.

The **Deal** zone appears. It contains the following sections:

- **Main** - Used to specify basic details about the deal.
- **Terms and Conditions** - Used to associate terms and conditions with the deal.
- **Product** - Used to associate reference products which you want the accounts of the deal entity to be enrolled.
- **Characteristics** - Used to define the characteristics for the deal.

Note: For more information about the fields available in the **Main** section, refer the [Defining a Deal](#) on page 2790 topic.

6. Click the **Search** () icon corresponding to the **Copy Template** field.

The **Copy From** window appears which contains a list of deal templates that you can use for creating the deal.

The **Copy From** window contains the following columns:

Column Name	Column Description
Basic Details	Used to indicate that you want to copy only the basic details of the deal template for creating the deal.
Pricing	Used to indicate that you want to copy only the price item pricing details of the deal template for creating the deal.
Usage	Used to indicate that you want to copy only the SQI details of the price items from the deal template for creating the deal.
Deal Information	Displays the concatenated string of information about the deal template separated by a comma (,).

7. Select the required option and/or options from the **Copy From** window.
8. Click **OK**.

The deal template data corresponding to the selected option and/or options from the **Copy From** window is copied to the new deal.

9. Modify the details in the **Main** section, if required.
10. Associate terms and conditions with the deal, if required.
11. Recommend products to which the accounts in the customer hierarchy can be enrolled, if required.
12. Define characteristics for the deal, if required.

13. Click the **Save** button.

The deal is created using the deal template.

Related Topics

For more information on...	See...
Deal zone	Deal on page 2822
How to associate terms and conditions with a deal	Associating the Terms and Conditions with a Deal on page 3038
Recommending a product for a deal	Recommending a Product for a Deal on page 2830
How to define a characteristic for a deal	Defining a Characteristic for a Deal on page 2831

Deal Compare

The **Deal Compare** screen enables you to compare two deals or two deal versions. It also enables you to extract the summary and detailed report in the excel format. It contains the following sections:

- **Main** - Used to specify basic information based on which you want to generate the comparison report for the selected deals or deal versions. It contains the following fields:

Field Name	Field Description	Mandatory (Yes or No)
Highlight Differences	Used to indicate whether you want to highlight the differences in the comparison report of two deals or deal versions.	No
	Note: By default the Highlight Differences check box is selected.	
Deal Compare Type	Used to indicate the comparison type using which you want to generate the comparison report of two deals or deal versions. The valid values are: <ul style="list-style-type: none"> • Detailed - Used to display the following: <ol style="list-style-type: none"> 1. Overall cost, proposed revenue, and profitability of two deals or deal versions 2. Proposed revenue for each division 3. Proposed revenue for each price item, root level hierarchy entity, non-root level hierarchy entity, and product. 4. Average price for each price item. • Summary - Used to display the following: <ol style="list-style-type: none"> 1. Overall cost, proposed revenue, and profitability of two deals or deal versions 2. Proposed revenue for each division 	No

Field Name	Field Description	Mandatory (Yes or No)
	Note: By default, the Summary option is selected from the Deal Compare Type field.	
Show Only Differences	Used to indicate whether you want to view only the difference for the revenue and average price of each price item in the customer hierarchy of the selected deals or deal versions while comparison. Note: This field is enabled when the Highlight Differences option check box is selected.	No
Deal Compare Based On	Used to compare the revenue and average price of each price item in the customer hierarchy of the selected deals or deal versions. The valid values are: <ul style="list-style-type: none"> • Average Price • Revenue Note: By default, the Deal Compare Based On field is disabled with the Revenue option selected. The Deal Compare Based On field is enabled when you select the Detailed option from the Deal Compare Type list.	No

- **Summary Report** - Used to display the following information:
 1. Overall cost, proposed revenue, and profitability of two deals or deal versions.
 2. Proposed revenue for each division.

The following table lists the data that appears in the **Summary Report** section:

Row name	Row Description
Deal Information	Displays the concatenated string of information about the deal which you want to compare separated by a comma (,).
Model ID	Displays the deal version ID for which you want to generate the comparison report.
Deal Identifier	Indicates the identifier using which the deal is created in the system.
Review Frequency	Indicates the period for which the deal usage is monitored as per the commitments made by the customer.
Summary Level	
Overall Proposed Revenue	Displays the total revenue generated through the proposed price item pricing and commitments.

Overall Profitability %	Displays the total profit in percentage that is generated from the proposed price item pricing and commitments.
Overall Cost	Displays the total cost of the price items based on the proposed usage.
Deal Status	Indicates the current status of the deal.
Start Date	Displays the date from when the deal is effective.
End Date	Displays the date till when the deal is effective.
Currency Code	Indicates the currency using which the deal is defined in the system.
Division Level Summary (Revenue)	
Displays the proposed revenue for each division.	

- **Detailed Report** - Used to display the following information:
 1. Overall cost, proposed revenue, and profitability of two deals or deal versions.
 2. Proposed revenue for each division.
 3. Proposed revenue for each price item, root level hierarchy entity, non-root level hierarchy entity, and product if the deal comparison is based on revenue.
 4. Average price for each price item if the deal comparison is based on average price.

The **Detailed Report** screen contains the following fields based on which you can view the detailed comparison of the revenue and average price of the price items in the customer hierarchy and the division of the selected deals or deal versions:

Field Name	Field Description	Mandatory (Yes or No)
Filter Type	Used to indicate the assignment level for which you want to compare the revenue or the average price of the price items in the customer hierarchy and the division. The valid values are: <ul style="list-style-type: none"> • Non-Root Level Hierarchy Entity • Price Item • Root Level Hierarchy Entity • Product 	No
Division	Used to indicate the division for which you want to compare the revenue or the average price of the product for which the accounts are enrolled. Note: This field appears when you select the Product option from the Filter Type list.	No
Product	Used to specify the product whose revenue or the average price you want to compare.	No

Field Name	Field Description	Mandatory (Yes or No)
	Note: This field appears when you select the Product option from the Filter Type list.	
Price Item	Used to specify the price item whose revenue or the average price you want to compare.	No

Comparing Cost, Revenue, and Profitability of Two Deal Versions

Procedure

To compare cost, revenue, and profitability of two deal versions:

1. Search for the deal in the **Search Deal** zone of the **Deal Dashboard** screen.
2. In the **Search Results** section, click the **Broadcast** () icon corresponding to the deal whose deal version you want to compare. The **Deal Versions** zone appears.
3. Select the check box corresponding to the deal version that you want to compare.

Note: Select the check box corresponding to the deal in the **Search Results** section of the **Search Deal** zone if only one deal version is created for the deal.

4. Click the **Add to Compare** link available in the **Deal Versions** zone. The **Deal Comparison** zone appears enlisting the selected deal version.

Note: Click the **Add to Compare** link available in the **Search Deal** zone if you are selecting a deal from the **Search Results** section of the **Search Deal** zone for comparison.

5. Repeat steps 1 to 4 for selecting the other deal version which you want to use for comparison.
6. Click the **Compare** link available in the **Deal Comparison** zone. The **Deal Compare** screen appears.
7. View the cost, revenue, and profitability comparison of two deals or deal versions in the **Summary Report** section.

Note: You can compare two deals or deal versions when they are in the **Simulated** status and are defined using the same currency.

Related Topics

For more information on...	See...
How to search for a deal	Searching for a Deal on page 2773
Search Deal zone	Search Deal on page 2758
Deal Dashboard screen	Deal Dashboard on page 2757
Deal Versions zone	Deal Versions on page 2771
Deal Comparison zone	Deal Comparison on page 2772
Deal Compare screen	Deal Compare on page 2798

Comparing Revenue from a Price Item or Hierarchy Entity in Two Deal Versions

Procedure

To compare revenue from a price item or hierarchy entity in to deal versions:

1. Search for the deal in the **Search Deal** zone of the **Deal Dashboard** screen.
2. In the **Search Results** section, click the **Broadcast** (📡) icon corresponding to the deal whose deal version you want to compare.

The **Deal Versions** zone appears.

3. Select the check box corresponding to the deal version that you want to compare.

Note: Select the check box corresponding to the deal in the **Search Results** section of the **Search Deal** zone if only one deal version is created for the deal.

4. Click the **Add to Compare** link available in the **Deal Versions** zone.

The **Deal Comparison** zone appears enlisting the selected deal version.

Note: Click the **Add to Compare** link available in the **Search Deal** zone if you are selecting a deal from the **Search Results** section of the **Search Deal** zone for comparison.

5. Repeat steps 1 to 4 for selecting the other deal version which you want to use for comparison.
6. Click the **Compare** link available in the **Deal Comparison** zone.
The **Deal Compare** screen appears.
7. Ensure that the **Detailed** option is selected from the **Deal Compare Type** list and the **Revenue** option is selected from the **Deal Compare Based On** list.
8. Select the price item or the hierarchy entity from the **Filter Type** list in the **Detailed Report** section.
9. View the revenue comparison of the price items or the hierarchy entities of the selected deals or deal versions in the **Detailed Report** section.

Note: You can compare two deals or deal versions when they are in the **Simulated** status and are defined using the same currency.

Related Topics

For more information on...	See...
How to search for a deal	Searching for a Deal on page 2773
Search Deal zone	Search Deal on page 2758
Deal Dashboard screen	Deal Dashboard on page 2757
Deal Versions zone	Deal Versions on page 2771
Deal Comparison zone	Deal Comparison on page 2772
Deal Compare screen	Deal Compare on page 2798

Comparing Average Price of a Price Item in Two Deal Versions**Procedure**

To compare the average price of a price item in two deal versions:

1. Search for the deal in the **Search Deal** zone of the **Deal Dashboard** screen.

- In the **Search Results** section, click the **Broadcast** () icon corresponding to the deal whose deal version you want to compare.

The **Deal Versions** zone appears.

- Select the check box corresponding to the deal version that you want to compare.

Note: Select the check box corresponding to the deal in the **Search Results** section of the **Search Deal** zone if only one deal version is created for the deal.

- Click the **Add to Compare** link available in the **Deal Versions** zone.

The **Deal Comparison** zone appears enlisting the selected deal version.

Note: Click the **Add to Compare** link available in the **Search Deal** zone if you are selecting a deal from the **Search Results** section of the **Search Deal** zone for comparison.

- Repeat steps 1 to 4 for selecting the other deal version which you want to use for comparison.

- Click the **Compare** link available in the **Deal Comparison** zone.

The **Deal Compare** screen appears.

- Ensure that the **Detailed** option is selected from the **Deal Compare Type** list and the **Average Price** option is selected from the **Deal Compare Based On** list.

- Specify the price item whose average price you want to compare in the **Price Item** field of the **Detailed Report** section.

- View the average price comparison of the price item in the **Detailed Report** section.

Note: You can compare two deals or deal versions when they are in the **Simulated** status and are defined using the same currency.

Related Topics

For more information on...	See...
How to search for a deal	Searching for a Deal on page 2773
Search Deal zone	Search Deal on page 2758
Deal Dashboard screen	Deal Dashboard on page 2757
Deal Versions zone	Deal Versions on page 2771
Deal Comparison zone	Deal Comparison on page 2772
Deal Compare screen	Deal Compare on page 2798

Deal Profitability Report

Oracle Revenue Management and Billing enables you to view the profitability report of a deal which is in the **Simulated** status. If a deal has one deal version, you can click the icon in the **Profitability Details** column corresponding to the deal in the **Deal Dashboard** screen. However, if a deal has two or more deal versions, you can click the icon in the **Profitability Details** column corresponding to the deal version in the **Deal Dashboard** screen. This is because the profitability details are shown for a particular deal version and not for all versions of a deal.

A new screen named **Deal Profitability** is introduced in this release. It appears when you click the icon in the **Profitability Details** column. This screen enables you to view the following:

- Deal Level Profitability Report** – Displays the profitability details (such as, proposed revenue, proposed cost, profit, original revenue, and revenue deviation) of each person in the customer hierarchy.

- **Division Level Profitability Report** – Displays the profitability details (such as, proposed revenue, proposed cost, profit, original revenue, and revenue deviation) of each division. If required, you can filter the profitability details of a particular division.
- **Price Item Level Profitability Report** – Displays the profitability details (such as, proposed commitment, proposed revenue, proposed cost, profit, original revenue, original commitment, and revenue deviation) of each price item. Here, you can also view the profitability details at the hierarchy entity level.
- **All** – Displays all the profitability details in the respective zones at once.

Deal Profitability

The **Deal Profitability** screen allows you to view the deal level, division level, and price item level profitability report of a simulated deal. It contains the following zones:

- [Search Profitability Report](#) on page 2804
- [Division Level Profitability](#) on page 2808
- [Price Item Level Profitability](#) on page 2809

Search Profitability Report

The **Search Profitability Report** zone allows you to search for the deal level, division level, or price item level the profitability report of the deal version. It contains the following two sections:

- **Search Criteria** - The **Search Criteria** contains the following fields:

Field Name	Field Description	Mandatory (Yes or No)
Search By	<p>Used to indicate whether you want to view deal level, division level, or price item level profitability report of the deal version. The valid values are:</p> <ul style="list-style-type: none"> • All - Used to indicate whether you want to view all the profitability report of the deal version at once. <div style="border: 1px solid black; padding: 5px; margin: 10px 0;"> <p>Note: On selecting this option from the Search By list, the Division Level Profitability and Price Item Level Profitability zones appear with the respective information in the Deal Profitability screen. Whereas, the Deal Level Profitability report appears in the Search Results section.</p> </div> <ul style="list-style-type: none"> • Deal Level Profitability Report - Used to indicate whether you want view the deal level profitability report. • Division Level Profitability Report - Used to indicate whether you want view the division level profitability report. • Price Item Level Profitability Report - Used to indicate whether you want view the profitability report at the price item level or hierarchy entity level. <div style="border: 1px solid black; padding: 5px; margin-top: 10px;"> <p>Note: By default, the All option is selected.</p> </div>	Yes

Field Name	Field Description	Mandatory (Yes or No)
Deal Information	Displays the concatenated string of information about the deal separated by a comma (,).	Not Applicable
Deal Version Information	Displays the concatenated string of information about the deal version whose profitability report you want to view separated by a comma (,).	Not Applicable
Division	Used to indicate the division for which you want to view the profitability report of the deal version.	Yes (Conditional)
	Note: This field appears when you select the Division Level Profitability Report option from the Search By list.	Note: This field is required for viewing the profitability report of a particular division.
Report Format	Used to indicate the format in which you want to view the price item profitability report. The valid values are: <ul style="list-style-type: none"> • Detailed Report - Used to indicate whether you want to view the profitability report at the price item level in the hierarchy. • Summary Report - Used to indicate whether you want to view the profitability report at the hierarchy entity level. 	Yes (Conditional)
	Note: By default, the Detailed Report option is selected. This field appears when you select the Price Item Level Profitability Report option from the Search By list.	Note: This field is required for viewing the profitability report of a price item.
Price Item	Used to search a particular price item whose profitability report you want to view for the deal version.	Yes (Conditional)
	Note: The Search (🔍) icon appears corresponding to this field. On clicking the Search icon, the Price Item Search window appears where you can search for the respective price item. This field appears when you select the Price Item Level Profitability Report option from the Search By list.	Note: This field is required for viewing the profitability report of a particular price item.

- **Search Results** - On clicking the **Search** button, the profitability report appears based on the specified search criteria. The **Search Results** section contains the following columns:

Column Name	Column Description
Person Information	Displays the concatenated string of information about the customer for whom the deal is created in the system separated by a comma (,).
	<p>Note:</p> <p>It has a link. On clicking the link, the Person screen appears where you can view the details of the respective person.</p> <p>This column appears when you select the All or Deal Level Profitability Report option from the Search By list.</p>
Primary Identifier	Indicates the primary identifier using which the customer is defined in the system.
	<p>Note: This column appears when you select the All or Deal Level Profitability Report option from the Search By list.</p>
Division	Indicates the division for which you want to view the profitability report.
	<p>Note: This column appears when you select the Division Level Profitability Report option from the Search By list.</p>
Root Level Hierarchy Entity	Indicates the root level hierarchy entity of the price item for which you want to view the profitability report.
	<p>Note: This column appears when you select the Price Item Level Profitability Report option from the Search By list.</p>
Non-Root Level Hierarchy Entity	Indicates the non-root level hierarchy entity of the price item for which you want to view the profitability report.
	<p>Note: This column appears when you select the Price Item Level Profitability Report option from the Search By list.</p>
Price Item Information	Displays the concatenated string of information about the price item for which you want to view the profitability report separated by a comma (,).
	<p>Note: This column appears when you select the Price Item Level Profitability Report option from the Search By list.</p>
Proposed Commitment	Displays the proposed usage of the price item.
	<p>Note: This column appears when you select the Price Item Level Profitability Report option from the Search By list.</p>
Proposed Revenue	Displays the revenue generated from the proposed price item pricing and commitments.
Proposed Cost	Displays the overall cost of the proposed price item based on the usage.
Profit	<p>Displays the overall profit generated from the proposed price assignments of price items. It is represented by the following formula:</p> <p>Proposed Profit = Proposed Revenue – Proposed Cost</p>

Column Name	Column Description
Profitability (%)	Displays the overall profit in percentage generated by the proposed price assignments of price items.
	Note: This column appears when you select the All or Deal Level Profitability Report option from the Search By list.
Original Revenue	Displays the revenue generated through the original price item pricing and commitments.
Original Commitment	Displays the original usage of the price item.
	Note: This column appears when you select the Price Item Level Profitability Report option from the Search By list.
Profit Variation (%)	Displays the difference between the original profit and proposed profit in percentage.
	Note: This column appears when you select the Deal Level Profitability Report or Division Level Profitability Report option from the Search By list.
	On selecting the All option from the Search By list in the Search Profitability Report zone, the Search Results displays the Deal Level Profitability Report by default.
Status	Indicates the current status of the deal.
	Note: This column appears when you select the All or Deal Level Profitability Report option from the Search By list.
Created By	Indicates the user who has created the deal.
	Note: This column appears when you select the All or Deal Level Profitability Report option from the Search By list.
Start Date	Displays the date from when the deal is effective for the entity (i.e. the customer, account, or prospect person).
	Note: This column appears when you select the All or Deal Level Profitability Report option from the Search By list.
End Date	Displays the date till when the deal is effective for the entity (i.e. the customer, account, or prospect person).
	Note: This column appears when you select the All or Deal Level Profitability Report option from the Search By list.
Next Review Date	Displays the date which is scheduled to review the deal usage as per the commitments made by the customer.
	Note: This column appears when you select the All or Deal Level Profitability Report option from the Search By list.

Column Name	Column Description
Deal Currency	Displays the currency using which the deal is defined in the system.
	Note: This column appears when you select the All or Deal Level Profitability Report option from the Search By list.
Revenue Variation (%)	Displays the average revenue generated from the price item pricing and commitments. It is represented by the following formula: Revenue Variation (%) = (Proposed Revenue – Original Revenue)*100 / Original Revenue
	Note: This column appears when you select the Price Item Level Profitability Report option from the Search By list.

Note: Pagination is used to display limited number of records in this zone. You can use the navigation links, such as **Previous** and **Next** to navigate between pages.

By default, the **Filter** area is hidden. You can view the **Filter** area by clicking the **Filters** (∨) icon in the upper right corner of this zone.

Related Topics

For more information on...	See...
Deal Profitability screen	Deal Profitability on page 2804
Division Level Profitability zone	Division Level Profitability on page 2808
Price Item Level Profitability zone	Price Item Level Profitability on page 2809
How to view the deal level profitability report	Viewing the Deal Level Profitability Report on page 2810
How to view the division level profitability report	Viewing the Division Level Profitability Report on page 2811
How to view the price item level profitability report	Viewing the Price Item Level Profitability Report on page 2812
How to view the hierarchy entity level profitability report	Viewing the Hierarchy Entity Level Profitability Report on page 2813

Division Level Profitability

The **Division Level Profitability** zone lists the division level profitability report for the deal version. It contains the following columns:

Column Name	Column Description
Division	Displays the division for which want to view the profitability report.
Proposed Revenue	Displays the revenue generated from the proposed price item pricing and commitments in a particular division.
Proposed Cost	Displays the overall cost of the proposed price items based on the usage in a particular division.
Profit	Displays the overall profit generated from the proposed price assignments in a particular division. It is represented by the following formula: Proposed Profit = Proposed Revenue – Proposed Cost

Column Name	Column Description
Original Revenue	Displays the revenue generated through the original price item pricing and commitments in a particular division.
Revenue Variation (%)	Displays the average revenue generated from the price item pricing and commitments in a particular division. It is represented by the following formula: Revenue Variation (%) = (Proposed Revenue – Original Revenue)*100 / Original Revenue

Note: Pagination is used to display limited number of records in this zone. You can use the navigation links, such as **Previous** and **Next** to navigate between pages.

Related Topics

For more information on...	See...
How to view the division level profitability report	Viewing the Division Level Profitability Report on page 2811
Search Profitability Report zone	Search Profitability Report on page 2804
Deal Profitability screen	Deal Profitability on page 2804

Price Item Level Profitability

The **Price Item Level Profitability** zone allows you to view the price item level profitability report of the deal version. It also allows you to view the price item profitability details at the hierarchy entity level. It contains the following columns:

Column Name	Column Description
Root Level Hierarchy Entity Information	Displays the root level hierarchy entity to which the price item is related. Note: It has a link. On clicking the link, the Entity Hierarchy Relationship screen appears where you can view the details of the respective root level hierarchy entity.
Non-Root Level Hierarchy Entity Information	Displays the non-root level hierarchy entity to which the price item is related.
Price Item Information	Displays the concatenated string of information about the price item whose profitability details you want to view separated by a comma (.). Note: It has a link. On clicking the link, the Price Item screen appears where you can view the details of the respective price item. The Price Item Information column appears when the Detailed Report option is selected from the Report Format list.
Proposed Commitment	Displays the proposed usage of the price item.
Proposed Revenue	Displays the revenue generated from the proposed price item pricing and commitment of the price item.
Proposed Cost	Displays the overall cost of the proposed price item based on the usage.
Profit	Displays the overall profit generated from the proposed price assignments of a particular price item. It is represented by the following formula:

Column Name	Column Description
	Proposed Profit = Proposed Revenue – Proposed Cost
Original Revenue	Displays the revenue generated through the original price item pricing and commitments of the price item.
Original commitment	Displays the original usage of the price item.
Revenue Variation (%)	Displays the average revenue generated from the pricing and commitments of a particular price item. It is represented by the following formula: Revenue Variation (%) = (Proposed Revenue – Original Revenue)*100 / Original Revenue

Note: Pagination is used to display limited number of records in this zone. You can use the navigation links, such as **Previous** and **Next** to navigate between pages.

Related Topics

For more information on...	See...
How to view the price item level profitability report	Viewing the Price Item Level Profitability Report on page 2812
How to view the hierarchy entity level profitability report	Viewing the Hierarchy Entity Level Profitability Report on page 2813
Search Profitability Report zone	Search Profitability Report on page 2804
Deal Profitability screen	Deal Profitability on page 2804

Viewing the Deal Level Profitability Report



Procedure

To view the deal level profitability report:

1. Search for the deal in the **Search Deal** zone of the **Deal Dashboard** screen.
2. In the **Search Results** section, click the **Broadcast** () icon corresponding to the deal whose deal versions profitability report you want to view.

The **Deal Versions** zone appears.
3. In the **Deal Versions** zone, click the **Profitability Details** () icon from the **Profitability Details** column corresponding to the deal version whose deal level profitability report you want to view.

The **Deal Profitability** screen appears.

Note: The **Profitability Details** () icon for deals which do not have multiple versions appears in the **Profitability Details** column corresponding to the deal in the **Search Results** section of the **Search Deal** zone as well as in the **Deal Versions** zone. Whereas, the **Profitability Details** () icon for deals which have multiple deal versions appear only in the **Profitability Details** column corresponding to the deal version in the **Deal Versions** zone.

4. View the deal level profitability details of the deal version in the **Search Results** section of the **Search Profitability Report** zone.

Tip: You can also view the deal level profitability details of a deal version by selecting the **Deal Level Profitability Report** option from the **Search By** list in the **Search Profitability Report** zone.

Note:

You can view the profitability report of a deal or a deal version when it is in the **Simulated** status.



Pagination is used to display limited number of records in the **Search Results** section. You can use the navigation links, such as **Previous** and **Next** to navigate between pages.

Related Topics



For more information on...	See...
How to search for a deal	Searching for a Deal on page 2773
How to view the versions of a deal	Viewing the Versions of a Deal on page 2774
Deal Dashboard screen	Deal Dashboard on page 2757
Search Deal zone	Search Deal on page 2758
Deal Versions zone	Deal Versions on page 2771
Deal Profitability screen	Deal Profitability on page 2804
Search Profitability Report zone.	Search Profitability Report on page 2804

Viewing the Division Level Profitability Report**Procedure**

To view the division level profitability report:

1. Search for the deal in the **Search Deal** zone of the **Deal Dashboard** screen.
2. In the **Search Results** section, click the **Broadcast** () icon corresponding to the deal whose deal versions profitability report you want to view.
The **Deal Versions** zone appears.
3. In the **Deal Versions** zone, click the **Profitability Details** () icon from the **Profitability Details** column corresponding to the deal version whose division level profitability report you want to view.

The **Deal Profitability** screen appears.

Note: The **Profitability Details** () icon for deals which do not have multiple versions appears in the **Profitability Details** column corresponding to the deal in the **Search Results** section of the **Search Deal** zone as well as in the **Deal Versions** zone. Whereas, the **Profitability Details** () icon for deals which have multiple deal versions appear only in the **Profitability Details** column corresponding to the deal version in the **Deal Versions** zone.

4. View the division level profitability report of the deal version in the **Division Level Profitability** zone.

Tip: You can also view the division level profitability report of a deal version in the **Search Results** section of the **Search Profitability Report** zone by selecting the **Division Level Profitability Report** option from the **Search By** list.

Note:

You can view the profitability report of a deal or a deal version when it is in the **Simulated** status.



Pagination is used to display limited number of records in this zone. You can use the navigation links, such as **Previous** and **Next** to navigate between pages.

Related Topics



For more information on...	See...
How to search for a deal	Searching for a Deal on page 2773
How to view the versions of a deal	Viewing the Versions of a Deal on page 2774
Deal Dashboard screen	Deal Dashboard on page 2757
Search Deal zone	Search Deal on page 2758
Deal Versions zone	Deal Versions on page 2771
Deal Profitability screen	Deal Profitability on page 2804
Division Level Profitability zone	Division Level Profitability on page 2808
Search Profitability Report zone.	Search Profitability Report on page 2804

Viewing the Price Item Level Profitability Report**Procedure**

To view the price item level profitability report:

1. Search for the deal in the **Search Deal** zone of the **Deal Dashboard** screen.
2. In the **Search Results** section, click the **Broadcast** () icon corresponding to the deal whose deal versions profitability report you want to view.
The **Deal Versions** zone appears.
3. In the **Deal Versions** zone, click the **Profitability Details** () icon from the **Profitability Details** column corresponding to the deal version whose price item level profitability report you want to view.

The **Deal Profitability** screen appears.

Note: The **Profitability Details** () icon for deals which do not have multiple versions appears in the **Profitability Details** column corresponding to the deal in the **Search Results** section of the **Search Deal** zone as well as in the **Deal Versions** zone. Whereas, the **Profitability Details** () icon for deals which have multiple deal versions appear only in the **Profitability Details** column corresponding to the deal version in the **Deal Versions** zone.

4. View the price item level profitability report of the deal version in the **Price Item Level Profitability** zone.

Tip: You can also view the price item level profitability report of a deal version in the **Search Results** section of the **Search Profitability Report** zone by selecting the **Price Item Level Profitability Report** option from the **Search By** list.

Note:

You can view the profitability report of a deal or a deal version when it is in the **Simulated** status.

Pagination is used to display limited number of records in this zone. You can use the navigation links, such as **Previous** and **Next** to navigate between pages.

Related Topics



For more information on...	See...
How to search for a deal	Searching for a Deal on page 2773

For more information on...	See...
How to view the versions of a deal	Viewing the Versions of a Deal on page 2774
Deal Dashboard screen	Deal Dashboard on page 2757
Search Deal zone	Search Deal on page 2758
Deal Versions zone	Deal Versions on page 2771
Deal Profitability screen	Deal Profitability on page 2804
Price Item Level Profitability zone	Price Item Level Profitability on page 2809
Search Profitability Report zone.	Search Profitability Report on page 2804



Viewing the Hierarchy Entity Level Profitability Report

Procedure

To view the hierarchy entity level profitability report:

1. Search for the deal in the **Search Deal** zone of the **Deal Dashboard** screen.
2. In the **Search Results** section, click the **Broadcast** () icon corresponding to the deal whose deal versions profitability report you want to view.
The **Deal Versions** zone appears.
3. In the **Deal Versions** zone, click the **Profitability Details** () icon from the **Profitability Details** column corresponding to the deal version whose hierarchy entity level profitability report you want to view.

The **Deal Profitability** screen appears.

Note: The **Profitability Details** () icon for deals which do not have multiple versions appears in the **Profitability Details** column corresponding to the deal in the **Search Results** section of the **Search Deal** zone as well as in the **Deal Versions** zone. Whereas, the **Profitability Details** () icon for deals which have multiple deal versions appear only in the **Profitability Details** column corresponding to the deal version in the **Deal Versions** zone.

4. Select the **Price Item Level Profitability Report** option from the **Search By** list in the **Search Profitability Report** zone.
5. Ensure that the **Filter** area is visible.
6. Select the **Summary Report** option from the **Report Format** list.
7. Click **Search**.
The search results appear in the **Search Results** section of the **Search Profitability Report** zone.
8. View the hierarchy entity level profitability report of the deal version in the **Search Results** section of the **Search Profitability Report** zone.

Note:

You can view the profitability report of a deal or a deal version when it is in the **Simulated** status.

Pagination is used to display limited number of records in the **Search Results** section. You can use the navigation links, such as **Previous** and **Next** to navigate between pages.

Related Topics

For more information on...	See...
How to search for a deal	Searching for a Deal on page 2773
How to view the versions of a deal	Viewing the Versions of a Deal on page 2774
Deal Dashboard screen	Deal Dashboard on page 2757
Search Deal zone	Search Deal on page 2758
Deal Versions zone	Deal Versions on page 2771
Deal Profitability screen	Deal Profitability on page 2804
Price Item Level Profitability zone	Price Item Level Profitability on page 2809
Search Profitability Report zone.	Search Profitability Report on page 2804



Deal Approval Workflow





The **Deal Approval Workflow** screen enables you to view the price item approval hierarchy and the product approval hierarchy details. It also enables you to view the approval history of the deal. It contains the following sections:

- **Main** - Displays basic information about the deal. It contains the following fields:

Field Name	Field Description
Deal Information	Displays the concatenated string of information about the deal separated by a comma (,).
Deal Version Information	Displays the concatenated string of information about the deal version separated by a comma (,).
Deal Type	Indicates the deal type using which the deal is created in the system.
Status	Indicates the current status of the deal.
Division	Indicates the division of the entity for which the deal is created in the system.

- **Approval Workflow Tracker** - Displays the price item approval hierarchy and the product level approval hierarchy of the deal. It also enables you to track the current approval status of the deal. It contains the following legends:

Legend	Legend Description
 Awaiting Action	Indicates the approver in the approval hierarchy has received the deal for approval and is yet to perform his/her actions.
 Acted On	Indicates the approver in the approval hierarchy has already performed his/her actions on the deal.
 Unassigned	Indicates the deal is not assigned to the approver in the approval hierarchy to perform his/her actions on the deal.
	Note: This indicates that the deal is already approved by the previous approver in the approval hierarchy.

Legend	Legend Description
 Returned	Indicates the approver has returned the deal to the submitter for approval.
 Awaiting Product Manager Approval	Indicates the approver needs the product manager's approval to perform his/her actions on the deal.
 Owner Action	Indicates the deal is not yet assigned to the approver in the approval hierarchy to perform his/her actions on the deal.
 Division Approval	Indicates the division level approval hierarchy.
 Product Approval	Indicates the product level approval hierarchy.

- **Approval History** - Displays the complete trail of actions performed on the deal. It contains the following columns:

Column Name	Column Description
Sequence	Displays the sequence in which the action is performed on the deal.
Process	Indicates the action that is performed on the deal.
Approval Type	Indicates the approval type using which the action is performed on the deal.
Division	Indicates the division for which the action is performed on the deal.
Product	Displays the product for which the action is performed on the deal.
Approval Level	Indicates the level in the approval hierarchy where the action is performed on the deal.
To Do Role	Indicates the To Do Role using which the To Do task is assigned for performing the action on the deal.
User Name	Displays the user who has performed the action on the deal.
Action Taken	Displays the action performed by the user on the deal with respect to the process.
Create Date Time	Displays the date and time when the action is performed by the user.
Update Date Time	Displays the date and time when the status of the deal is updated in the system due to the action performed.

Note: The deal approval workflow does not appear for deals which are in the **Draft, Pending Simulation, Simulation Deferred, Simulated, Hierarchy Creation Deferred, and Discarded** status.

For more information on how the approval workflow appears, refer [Deal Approval Scenarios](#) on page 2626

Deal Information

The **Deal Information** screen enables you to define a deal for the existing customers, accounts, or prospect persons. It also allows you to define a prospect person. It contains the following pages:

- [Deal Information - Deal](#) on page 2816

- [Deal Information - Questionnaire](#) on page 2832
- [Deal Information - Reference](#) on page 2834
- [Deal Information - Pricing and Commitments](#) on page 2844
- [Deal Information - Simulation](#) on page 2875
- [Deal Information - Approvals](#) on page 2887
- [Deal Information - Acceptance/Rejection](#) on page 2899
- [Deal Information - Orchestration](#) on page 2911
- [Deal Information - Discarded](#) on page 2922

Deal Information - Deal

The **Deal Information - Deal** page enables you to define a deal for the entities (i.e. customers, accounts, and prospect persons) which are already available in the system. It also enables you create a new prospect for which you want to define a deal. It contains the following zones:

- [Search Entity](#) on page 2816
- [Deal](#) on page 2822

Note: By default, the **Deal** zone does not appear in the **Deal Information - Deal** page. It appears when you click the **Broadcast** () icon corresponding to an entity (i.e. customer, account, or prospect person) in the **Search Results** section of the **Search Entity** zone.

Related Topics

For more information on...	See...
How to search for an entity	Searching for an Entity on page 2829
How to define a deal	Defining a Deal on page 2790

Search Entity

The **Search Entity** zone allows you to search for an existing customer, account, or prospect person for whom you want to define a deal. It contains the following two sections:

- **Search Criteria** - The **Search Criteria** section contains the following fields:

Field Name	Field Description	Mandatory (Yes or No)
Search By	Used to indicate whether you want to search for an existing customer, account, or prospect person for whom you want to define a deal. The valid values are: <ul style="list-style-type: none"> • Customer Details • Account Details • Prospect Details 	Yes
	Note: By default, the Customer Details option is selected.	
Division	Used to search for customers, accounts, or prospect persons associated with a particular division.	No

Field Name	Field Description	Mandatory (Yes or No)
	Note: You can only view those divisions to which you have access in the Division list.	
Person Name	Used to search for customers or accounts which belong to persons with a particular name.	Yes (Conditional)
	Note: This field appears when the Customer Details , and Account Details option is selected from the Search By list.	Note: This field is required while searching for an existing customer or account for which you want to define a deal.
Customer Segment	Used to search for customers or prospect persons which belong to a particular segment.	Yes (Conditional)
	Note: The list includes only those values which are present in the CUST_SEG_FLG lookup field. This field appears when the Customer Details or Prospect Details option is selected from the Search By list and the Advanced Search link is clicked in the top right corner of the Search Criteria section.	Note: This field is required while searching for an existing customer or prospect person for whom you want to define a deal.
City	Used to search for customers from a particular city.	Yes (Conditional)
	Note: This field appears when the Customer Details option is selected from the Search By list and the Advanced Search link is clicked in the top right corner of the Search Criteria section.	Note: This field is required while searching for an existing customer for whom you want to define a deal.
Address	Used to search for a customer residing at a particular address.	Yes (Conditional)
	Note: This field appears when the Customer Details option is selected from the Search By list and the Advanced Search link is clicked in the top right corner of the Search Criteria section.	Note: This field is required while searching for an existing customer for whom you want to define a deal.
Phone Number	Used to search for a customer having a specific phone number.	Yes (Conditional)
	Note: This field appears when the Customer Details option is selected from the Search By list and the Advanced Search link is clicked in the top right corner of the Search Criteria section.	Note: This field is required while searching for an existing customer for whom you want to define a deal.
Person ID	Used to search for a particular customer.	Yes (Conditional)
	Note: This field appears when the Customer Details option is selected from the Search By list.	

Field Name	Field Description	Mandatory (Yes or No)
		Note: This field is required while searching for an existing customer for whom you want to define a deal.
Person Identifier Type	Used to indicate the person identifier type based on which you want to search for a customer or account. Note: This field appears when the Customer Details option is selected from the Search By list. This field also appears when the Account Details option is selected from the Search By list and the Advanced Search link is clicked in the top right corner of the Search Criteria section.	Yes (Conditional) Note: This field is required while searching for an existing customer or account for which you want to define a deal.
Person Identifier	Used to specify the value for the person identifier type based on which you want to search for a customer or account. Note: This field appears when you select a person identifier type from the Person Identifier Type list.	Yes (Conditional) Note: This field is required while searching for an existing customer or account for which you want to define a deal. If you specify the person identifier type as a search criteria, you have to specify the person identifier.
Customer Class	Used to search for accounts which belong to a particular customer class. Note: This field appears when the Account Details option is selected from the Search By list and the Advanced Search link is clicked in the top right corner of the Search Criteria section.	Yes (Conditional) Note: This field is required while searching for an existing account for which you want to define a deal.
Account ID	Used to search for a particular account. Note: This field appears when the Account Details option is selected from the Search By list.	Yes (Conditional) Note: This field is required while searching for an existing account for which you want to define a deal.
Account Identifier Type	Used to indicate the identifier type based on which you want to search for the accounts.	Yes (Conditional)

Field Name	Field Description	Mandatory (Yes or No)
	<p>Note: This field appears when the Account Details option is selected from the Search By list.</p>	<p>Note: This field is required while searching for an existing account for which you want to define a deal.</p>
Account Identifier	<p>Used to specify the value for the account identifier type based on which you want to search for the accounts.</p> <p>Note: This field appears when you select an account identifier type from the Account Identifier Type list.</p>	<p>Yes (Conditional)</p> <p>Note: This field is required while searching for an existing account for which you want to define a deal. If you specify the account identifier type as a search criteria, you have to specify the account identifier.</p>
Account Category	<p>Used to search accounts which are associated with a particular category. The valid values are:</p> <ul style="list-style-type: none"> • Invoice Account • Settlement Account • Usage Account <p>Note: The list includes only those values which are present in the ACCT_USAGE_FLG lookup field. This field appears when the Account Details option is selected from the Search By list and the Advanced Search link is clicked in the top right corner of the Search Criteria section.</p>	<p>Yes (Conditional)</p> <p>Note: This field is required while searching for an existing account for which you want to define a deal.</p>
Prospect Person Name	<p>Used to search prospect persons with a particular name.</p> <p>Note: This field appears when the Prospect Details option is selected from the Search By list.</p>	<p>Yes (Conditional)</p> <p>Note: This field is required while searching for an existing prospect person for whom you want to define a deal.</p>
Prospect Person ID	<p>Used to search for a particular prospect person.</p> <p>Note: This field appears when the Prospect Details option is selected from the Search By list.</p>	<p>Yes (Conditional)</p> <p>Note: This field is required while searching for an existing prospect person for whom you want to define a deal.</p>

Field Name	Field Description	Mandatory (Yes or No)
Prospect Person Identifier Type	Used to indicate the identifier type based on which you want to search for the prospect persons.	Yes (Conditional)
	Note: This field appears when the Prospect Details option is selected from the Search By list.	Note: This field is required while searching for an existing prospect person for whom you want to define a deal.
Prospect Person Identifier	Used to specify the value for the prospect identifier type based on which you want to search for the prospect persons.	Yes (Conditional)
	Note: This field appears when you select a prospect identifier type from the Prospect Identifier Type list.	Note: This field is required while searching for an existing prospect person for whom you want to define a deal. If you specify the prospect person identifier type as a search criteria, you have to specify the prospect person identifier.

- **Search Results** - On clicking the **Search** button, a list of entities appear based on the specified search criteria. The **Search Results** section contains the following columns:

Column Name	Column Description
Person Information	Displays the concatenated string of customer information separated by a comma (.). In addition, a context menu appears corresponding to this field which helps in navigating to other screens in the application.
	Note: It has a link. On clicking the link, the Person screen appears where you can view the details of the respective customer. This column appears when the Customer Details option is selected from the Search By list in the Search Criteria section.
Person Name	Displays the name of the customer.
	Note: This column appears when the Customer Details option is selected from the Search By list in the Search Criteria section.
Primary Person Identifier Type	Indicates the identifier type using which the customer is defined in the system.
	Note: This column appears when the Customer Details option is selected from the Search By list in the Search Criteria section.
Primary Person Identifier	Displays the value for the primary person identifier type using which the customer is defined in the system.

Column Name	Column Description
	<p>Note: This column appears when the Customer Details option is selected from the Search By list in the Search Criteria section.</p>
Division	Indicates the division to which the customer, account, or prospect person belongs.
Account Information	<p>Displays the concatenated string of account information separated by a comma (.). In addition, a context menu appears corresponding to this field which helps in navigating to other screens in the application.</p> <p>Note:</p> <p>It has a link. On clicking the link, the Account screen appears where you can view the details of the respective account.</p> <p>This column appears when the Account Details option is selected from the Search By list in the Search Criteria section.</p>
Main Customer	<p>Displays the name of the main customer to whom the account belongs.</p> <p>Note: This column appears when the Account Details option is selected from the Search By list in the Search Criteria section.</p>
Primary Account Identifier Type	<p>Indicates the identifier type using which the account is defined in the system.</p> <p>Note: This column appears when the Account Details option is selected from the Search By list in the Search Criteria section.</p>
Primary Account Identifier	<p>Displays the value for the primary account identifier type using which the account is defined in the system.</p> <p>Note: This column appears when the Account Details option is selected from the Search By list in the Search Criteria section.</p>
Customer Class	<p>Indicates the customer class to which the account belongs.</p> <p>Note: This column appears when the Account Details option is selected from the Search By list in the Search Criteria section.</p>
Prospect Person Information	<p>Displays the concatenated string of prospect person information separated by a comma (.). In addition, a context menu appears corresponding to this field which helps in navigating to other screens in the application.</p> <p>Note:</p> <p>It has a link. On clicking the link, the Prospect Person screen appears where you can view the details of the respective prospect person.</p> <p>This column appears when the Prospect Details option is selected from the Search By list in the Search Criteria section.</p>
Prospect Person Identifier Type	Indicates the identifier type using which the prospect person is defined in the system.

Column Name	Column Description
	Note: This column appears when the Prospect Details option is selected from the Search By list in the Search Criteria section.
Prospect Person Identifier	Displays the value for the prospect person identifier type using which the prospect person is defined in the system. Note: This column appears when the Prospect Details option is selected from the Search By list in the Search Criteria section.

Note: Pagination is used to display limited number of records in the **Search Results** section. You can use the navigation links, such as **Previous** and **Next** to navigate between pages.

By default, the **Filter** area is visible. You can hide the **Filter** area by clicking the **Filters** (🔍) icon in the upper right corner of this zone.

On clicking the **Broadcast** (📢) icon corresponding to an entity, the **Deal** zone appears where you can define a deal for the respective entity.

Related Topics

For more information on...	See...
How to search for an entity	Searching for an Entity on page 2829
Deal Information screen	Deal Information on page 2815
Deal zone	Deal on page 2822
How to define a deal	Defining a Deal on page 2790

Deal

The **Deal** zone allows you to define a deal for the entity (i.e. the customer, account, or prospect person) which is already available in the system. It contains the following sections:

- **Main** - Used to specify basic details about the deal. It contains the following fields:

Field Name	Field Description	Mandatory (Yes or No)
Deal Entity Information	Displays information about the entity (i.e. the customer, account, or prospect person) for which you want to define a deal.	Not applicable
Deal ID	Displays the deal ID. Note: The value of this field is automatically populated when you enter all the details for creating a deal and press the Save button.	Not applicable
Contracted Deal	Used to indicate that the change in the price item pricing from the price list does not affect the price item pricing offered in the deal created for an existing customer, account, or prospect.	No
Copy Template	Used to indicate the deal template which you want to use for creating the deal.	No

Field Name	Field Description	Mandatory (Yes or No)
	<p>Note: The Search (🔍) icon appears corresponding to the Copy Template field. On clicking the Search icon, the Copy From window appears where you can select the respective details from the template.</p>	
Deal Entity	<p>Indicates the entity (i.e. the customer, account, or prospect person) for which you want to create a deal. The valid values are:</p> <ul style="list-style-type: none"> • Account • Customer • Prospect <p>Note: This field cannot be edited. The list includes only those values which are present in the DEAL_ENTITY_TYPE_FLG lookup field.</p>	Not applicable
Status	<p>Indicates the current status of the deal.</p> <p>Note: This field cannot be edited. The value of this field is automatically populated when you enter all the details for creating a deal and press the Save button. The list includes only those values which are present in the DEAL_STATUS lookup field.</p>	Not applicable
Customer Segment	<p>Indicates the business component to which the entity (i.e. the customer, account, or prospect person) belongs.</p> <p>Note: This field cannot be edited. The value of this field is set to the value that is specified in the Person screen. The list includes only those values which are present in the CUST_SEG_FLG lookup field.</p>	Not applicable
Customer Tier	<p>Indicates the customer tier of the customer segment to which the entity (i.e. the customer, account, or prospect person) belongs.</p>	Not applicable

Field Name	Field Description	Mandatory (Yes or No)
	<p>Note:</p> <p>This field cannot be edited.</p> <p>The value of this field is set to the value that is specified in the Person screen.</p> <p>The list includes only those values which are present in the CUST_TIER_FLG lookup field.</p>	
Access Group	<p>Indicates the user group who can view and edit the details of the entity (i.e. the customer, account, or prospect person).</p> <p>Note: The value of this field is set to the value that is specified in the Person screen.</p>	Not applicable
Division	<p>Indicates the division with which the entity (i.e. the customer, account, or prospect person) is associated.</p> <p>Note:</p> <p>This field cannot be edited.</p> <p>The value of this field is set to the value that is specified in the Person screen.</p>	Not applicable
Deal Identifier	<p>Used to specify the primary identifier using which you want to create a deal for the entity in the system.</p> <p>Note:</p> <p>You should ensure that every deal has a unique deal identifier.</p> <p>An error message appears when you save a deal with a deal identifier which is already used for creating a deal.</p>	Yes
Deal Type	Used to indicate the deal type using which you want to create a deal in the system.	Yes

Field Name	Field Description	Mandatory (Yes or No)
	<p>Note:</p> <p>The Search (🔍) icon appears corresponding to the Deal Type field. On clicking the Search icon, the Deal Type Search window appears.</p> <p>On specifying the deal type, the description of the deal type appears corresponding to the Deal Type field.</p> <p>The Deal Type Search window lists only those deal types having the Division, Customer Segment, and Customer Tier combination which best fits with the Division, Customer Segment, and Customer Tier combination as specified in the Person screen of the entity (i.e. the customer, account, or prospect person).</p>	
Deal Currency	<p>Used to specify the currency in which you want to calculate the deal level, division level, and the product level financial summary and profitability of the deal.</p> <p>Note: The list includes only those currencies which are already defined in the system.</p>	Yes
Simulation Type	<p>Used to indicate the simulation type using which you want to analyze the cost, revenue, and profitability of the deal. The valid values are:</p> <ul style="list-style-type: none"> • Account • Customer • Deal 	Yes
Include Hierarchy	<p>Used to indicate whether you want to include the child persons, grandchild persons, and their accounts in the customer hierarchy while creating a deal.</p> <p>Note:</p> <p>This option appears only when the Deal Entity is set to Customer and the Simulation Type is set to Customer.</p> <p>By default, the Include Hierarchy check box is selected when you are defining a deal.</p>	No
Start Date	Used to specify the date from when the deal is effective for the entity (i.e. the customer, account, or prospect person).	Yes

Field Name	Field Description	Mandatory (Yes or No)
	Note: This date is also used as the Effective Start Date for the proposed price list assignment, price assignment and Start Date for proposed product enrollment.	
Price Selection Date	Used to specify the date from when the price lists, pricing assignments, and product enrollments are effective for simulation.	Yes
End Date	Used to specify the date till when the deal is effective for the entity (i.e. the customer, account, or prospect person).	No
Review Frequency	Used to indicate the timely monitoring of the deal usage as per the commitments made by the customer. Note: The list includes only those values which are present in the REVIEW_FREQUENCY_FLG lookup field.	No
Deal Frequency	Used to indicate the duration for which you want to simulate the deal for calculating the financial summary and profitability of the deal. Note: The list includes only those values which are present in the FREQUENCY_FLG lookup field.	Yes
Usage Period	Used to indicate the period for which you want to aggregate the deal data to determine the scope of the deal. Note: The list includes only those values which are present in the USAGE_PERIOD_FLG lookup field.	Yes
Deal Description	Used to specify the description for the deal.	Yes
Deal Version Description	Used to specify the description for the deal version. Note: This field is required while creating a deal version.	Yes (conditional)
Skip Reference	Used to indicate whether you want to use a deal which is already created in the system as a reference for copying the pricing and commitments while creating a deal for the existing customer, account, or prospect person..	No

Field Name	Field Description	Mandatory (Yes or No)
	<p>Note:</p> <p>If you select the check box corresponding to the Skip Reference field and click Save, the system will direct you to the Deal Information - Pricing/Commitments page in the Pending Simulation status to define the price list assignments, price assignments, and product enrollments for the deal.</p> <p>If you do not select the check box corresponding to the Skip Reference field and click Save, the system will direct you to the Deal Information - Reference page in the Draft status to select reference whose price item pricing, price list assignments, and product enrollments you want to use for the deal</p>	
Skip Questionnaire	<p>Used to indicate whether you want to derive reference customers and deals during a deal creation using a questionnaire.</p> <p>Note: If a questionnaire template is not specified in the respective deal type or if the questionnaire template is not effective on the deal start date or if the Skip Questionnaire option is selected during the deal creation, the system derives the reference customers for the deal using the division, customer segment, and customer tier combination.</p>	No

- **Product** - Used to recommend a list of products to which the accounts in the customer hierarchy can be enrolled. It contains the following field in a grid:

Field Name	Field Description	Mandatory (Yes or No)
Product	<p>Used to indicate the product that you want to recommend for the deal.</p> <p>Note:</p> <p>The Search (🔍) icon appears corresponding to the Product field. On clicking the Search icon, the Product Search window appears.</p> <p>On specifying the product, the description of the product appears corresponding to the Product field. The Product Search window lists only those products which are effective on the deal start date.</p>	<p>Yes (Conditional)</p> <p>Note: This field is required while recommending a product for a deal.</p>

Note:

The system automatically derives recommended products for the deal when the questionnaire contains questions where the question applicability is set to **Package and Product Reference**.

The system derives the recommended products from the reference deals. It only considers automatically recommended products of the reference deals and not manually recommended products of the reference deals.

- **Characteristics** - Used to define a list of characteristics for the deal. It contains the following fields in a grid:

Field Name	Field Description	Mandatory (Yes or No)
Effective Date	Used to specify the date from when the characteristic is effective for the deal.	Yes (Conditional)
		Note: This field is required while defining a characteristic for the deal.
Characteristic Type	Used to indicate the characteristic type. Note: The list includes only those characteristic types where the characteristic entity is set to Deal .	Yes (Conditional)
		Note: This field is required while defining a characteristic for the deal.
Characteristic Value	Used to specify the value for the characteristic type. Note: If you select a predefined characteristic type, the Search (🔍) icon appears corresponding to the Characteristic Value field. On clicking the Search icon, the Predefined Characteristic Search window appears. On specifying the value for a predefined characteristic type, the description of the characteristic value appears corresponding to the Characteristic Value field.	Yes (Conditional)
		Note: This field is required while defining a characteristic for the deal.

In addition, the **Deal** zone contains the following buttons:

Button Name	Button Description
Save as Template	Used to save the deal as a template for defining other deals in the system. By default, the Save as Template button does not appear in the Deal zone. It appears only when the Change access mode is provided for the C1-DEALTEMPLATE application service to a user group. Users who belong to such user group can only view the Save as Template button in the Deal zone while creating a deal. If the user belongs to the user group which does not have the Change access mode provided for the C1-DEALTEMPLATE application service, the Save as Template button is disabled while creating a deal.

Button Name	Button Description
	Note: On clicking the Save as Template button, the system, by default, sets the Template Deal field to Y while saving the deal information.
Save	Used to save the deal in the system. Note: On clicking the Save button, the system sets the Template Deal field to N while saving the deal information.
Next	Used to navigate to the next page.

Related Topics

For more information on...	See...
Deal Information - Deal page	Deal Information - Deal on page 2816
How to define a deal	Defining a Deal on page 2790
How to associate terms and conditions with a deal	Associating the Terms and Conditions with a Deal on page 3038
How to recommend a product for a deal	Recommending a Product for a Deal on page 2830
How to define characteristics for a deal	Defining a Characteristic for a Deal on page 2831

Searching for an Entity

Prerequisites

To search for an entity, you should have:

- Entities (i.e. customers, accounts, and prospect persons) defined in the application

Procedure

To search for an entity:

1. Click the **Menu** link in the **Application** toolbar.
A list appears.
2. From the **Main** menu, select **Deal Management** and then click **Deal Dashboard**.
The **Deal Dashboard** screen appears.
3. Click the **Create New Deal** button in the page title area of the **Deal Dashboard** screen.
The **Deal Information - Deal** page appears.
4. Enter the search criteria in the **Search Entity** zone.

Note: ORMB search engine supports wildcard search, where you can substitute the percentage (%) symbol as a stand in for any word or letter in a search criteria. You can use the ‘%’ wildcard character in all input fields except the date and ID fields. The ‘%’ wildcard character is suffixed automatically at the end of the partial search criteria. Therefore, you may or may not specify the wildcard character at the end of the partial search criteria. However, you have to prefix the wildcard character manually wherever required.

5. Click **Search**.

A list of entities (i.e. customers, accounts, or prospect persons) that meet the search criteria appears in the **Search Results** section.

Note: Pagination is used to display limited number of records in the **Search Results** section. You can use the navigation links, such as **Previous** and **Next** to navigate between pages.

Related Topics

For more information on...	See...
Deal Dashboard screen	Deal Dashboard on page 2757
Deal Information - Deal page	Deal Information - Deal on page 2816
Search Entity zone	Search Entity on page 2816

Recommending a Product for a Deal

Prerequisites

To recommend a product for a deal, you should have:

- Products defined in the application

Procedure

To recommend a product for a deal:

1. Ensure that the **Product** section is expanded in the **Deal** zone when you are defining a *deal*.

The **Product** section contains the following field in a grid:

Field Name	Field Description	Mandatory (Yes or No)
Product	Used to indicate the product that you want to recommend for the deal. Note: The Search (🔍) icon appears corresponding to the Product field. On clicking the Search icon, the Product Search window appears. On specifying the product, the description of the product appears corresponding to the Product field.	No

Note:

The system automatically derives recommended products for the deal when the questionnaire contains questions where the question applicability is set to **Package and Product Reference**.

The system derives the recommended products from the reference deals. It only considers automatically recommended products of the reference deals and not manually recommended products of the reference deals.

2. Enter the required details in the **Product** section.
3. If you want to recommend more than one product for the deal, click the **Add** (+) icon and then repeat step 2.

Note: However, if you want to remove a recommended product from the deal, click the **Delete** (🗑️) icon corresponding to the product.

4. Click **Save**.

The products is recommended for the deal.

Related Topics

For more information on...	See...
How to define a deal	Defining a Deal on page 2790
Deal zone	Deal on page 2822

Defining a Characteristic for a Deal

Prerequisites

To define a characteristic for a deal, you should have:

- Characteristic types defined in the application (where the characteristic entity is set to **Deal**)

Procedure

To define a characteristic for a deal:

1. Ensure that the **Characteristics** section is expanded in the **Deal** zone when you are defining a deal.

The **Characteristics** section contains the following fields in a grid:

Field Name	Field Description	Mandatory (Yes or No)
Effective Date	Used to specify the date from when the characteristic is effective for the deal.	Yes (Conditional)
		Note: This field is required while defining a characteristic for the deal.
Characteristic Type	Used to indicate the characteristic type.	Yes (Conditional)
	Note: The list includes only those characteristic types where the characteristic entity is set to Deal .	Note: This field is required while defining a characteristic for the deal.
Characteristic Value	Used to specify the value for the characteristic type.	Yes (Conditional)
	Note: If you select a predefined characteristic type, the Search (🔍) icon appears corresponding to the Characteristic Value field. On clicking the Search icon, the Predefined Characteristic Search window appears. On specifying the value for a predefined characteristic type, the description of the characteristic value appears corresponding to the Characteristic Value field.	Note: This field is required while defining a characteristic for the deal.

2. Enter the required details in the **Characteristics** section.
3. If you want to define more than one characteristic for the deal, click the **Add** (+) icon and then repeat step 3.

Note: However, if you want to remove a characteristic from the deal, click the **Delete** (🗑️) icon corresponding to the characteristic.

4. Click **Save**.

The characteristic is defined for the deal.

Related Topics

For more information on...	See...
How to define a deal	Defining a Deal on page 2790
Deal zone	Deal on page 2822

Deal Information - Questionnaire

The **Deal Information - Questionnaire** page enables you to derive reference customers and deals during deal creation using a questionnaire.

Note:

The reference deals are those deals which belong to the reference customers which are derived using the questionnaire. The system displays the questions from the questionnaire template which is specified in the respective deal type. The system considers the questionnaire template specified in the deal type when it is effective on the deal start date.

Deal Information - Questionnaire page contains the following zone:

- [Questionnaire](#) on page 2832

Note: By default, the **Deal Information - Questionnaire** page does not appear while creating a deal. It appears when the **Skip Questionnaire** check box is unchecked in the **Deal** zone of **Deal Information - Deal** page and the **Questionnaire Template** is associated with the **Deal Type** using which the deal is created.

Related Topics

For more information on...	See...
Deal zone	Deal on page 2822
Deal Information - Deal page	Deal Information - Deal on page 2816
Deal Information screen	Deal Information on page 2815
Deal Type screen	Deal Type on page 2687

Questionnaire

The **Questionnaire** zone allows you to answer the questions of the questionnaire template associated with the deal type using which the deal is created in the system.

The system enables you to derive reference customers and deals based on the answer provided in the **Questionnaire** zone.

The display order of the questions in the **Questionnaire** zone depends on the value set for the **Question Display Order** field in the **Questionnaire Template** screen associated with the deal type.

If the question display order is rule based, then the questions appear in the **Questionnaire** zone based on the answer provided for the previous question.

Note: Click the **Previous** (←) or **Next** (→) icons to navigate through the questions of a rule based questionnaire.

If the question display order is sequence based, then a list of questions appear in the **Questionnaire** zone.

Note: Click the **Previous** (←) or **Next** (→) icons to navigate through the questions set of a sequence based questionnaire.

The mandatory questions in both rule based and sequence based question display orders are indicated by an asterisk (*) sign.

On clicking the **Skip Questionnaire** button on the top right corner of this zone, you can skip the questionnaire for deriving reference customers or deals based on the answers provided in the questionnaire.

Related Topics

For more information on...	See...
Deal Information - Questionnaire page	Deal Information - Questionnaire on page 2832
How to answer a questionnaire for a deal	Answering a Questionnaire for a Deal on page 2833
How to skip questionnaire for a deal	Skipping Questionnaire for a Deal on page 2833

Answering a Questionnaire for a Deal

Procedure

To answer a questionnaire for a deal:

1. Ensure that the **Questionnaire** zone is expanded in the **Deal Information - Questionnaire** page.

A list of questions appear in the **Questionnaire** zone if the **Question Display Order** is set to **Sequence Based** in the **Questionnaire Template** associated with the deal type. Whereas, if the **Question Display Order** is set to **Rule Based** in the **Questionnaire Template** associated with the deal type, the questions appear based on the answer provided for the previous question.

2. Click the **Previous** (←) or **Next** (→) icons to navigate through the questions or question sets of a rule based or sequence based questionnaire respectively.
3. Answer the questions as per the **Answer Type** set for the questions in the **Questionnaire Template**.
4. Click the **Next** button.

A list of reference customers appear based on the answers provided in the questionnaire.

Related Topics

For more information on...	See...
Deal Information - Questionnaire page	Deal Information - Questionnaire on page 2832
Questionnaire zone	Questionnaire on page 2832
Questionnaire Template screen	Questionnaire Template (Used for Searching) on page 2715

Skipping Questionnaire for a Deal

Procedure

To skip questionnaire for a deal:

1. Ensure that the **Questionnaire** zone is expanded in the **Deal Information - Questionnaire** page.

2. Click the **Skip Questionnaire** button in the top right corner of the **Questionnaire** zone.

A message appears confirming whether you want to skip the questionnaire.

3. Click **OK**.

The questionnaire is skipped.

Tip: Alternatively, you can skip a questionnaire by clicking the check box corresponding to the **Skip Questionnaire** field in the **Deal** zone of the **Deal Information - Deal** page while defining a deal.

Related Topics

For more information on...	See...
Questionnaire zone	Questionnaire on page 2832
Deal Information - Questionnaire page	Deal Information - Questionnaire on page 2832
Deal Information - Deal page	Deal Information - Deal on page 2816
Deal zone	Deal on page 2822

Deal Information - Reference

The **Deal Information - Reference** page enables you to search for a customer or a deal whose price item pricing, price list assignments, and product enrollments you want to use as a reference for creating a deal. It contains the following zones:

- [Select Reference](#) on page 2834
- [Reference Details](#) on page 2840

Note: By default, the **Deal Information - Reference** page does not appear while creating a deal. It appears when the **Skip Reference** check box is unchecked in the **Deal** zone of **Deal Information - Deal** page.

Related Topics

For more information on...	See...
Deal zone	Deal on page 2822
Deal Information - Deal page	Deal Information - Deal on page 2816

Select Reference

The **Select Reference** zone allows you to search for a customer or a deal whose price item pricing, price list assignments, and product enrollments you want to use as a reference for creating a deal.

Note:

By default, the **Select Reference** zone lists the reference customers for the deal based on the division, customer segment, and customer tier combination.

If a questionnaire template is specified in the respective deal type and if the questionnaire template is effective on the deal start date and if the **Skip Questionnaire** option is not selected during the deal creation, the **Select Reference** zone lists the reference customers based on the answers provided in the **Questionnaire** zone of the **Deal Information - Questionnaire** page.

The **Select Reference** zone contains the following sections:

- **Search Criteria** - The **Search Criteria** section contains the following fields:

Field Name	Field Description	Mandatory (Yes or No)
Search By	<p>Used to search for reference customer or deals whose price item pricing, price list assignments, and product enrollments you want to use as a reference to create a deal. The valid values are:</p> <ul style="list-style-type: none"> • Reference Customers <ul style="list-style-type: none"> - Lists the reference customers based on the division, customer segment, and customer tier combination or the answers provided in the Questionnaire zone of the Deal Information - Questionnaire page. • Customer <ul style="list-style-type: none"> - Used to specify whether you want to search for a reference customer whose price item pricing, price list assignments, and product enrollments you want to use as a reference to create a deal. • Deal <ul style="list-style-type: none"> - Used to specify whether you want to search for a reference deal whose price item pricing, price list assignments, and product enrollments you want to use as a reference to create a deal. • Reference Deals - Lists the reference deals based on the answers provided in the Questionnaire zone of the Deal Information - Questionnaire page. <div style="border: 1px solid black; padding: 5px; margin-top: 10px;"> <p>Note: The reference deals are not derived when the Skip Questionnaire option is selected during the deal creation or a questionnaire template is not specified in the respective deal type or if the questionnaire template is not effective on the deal start date.</p> </div>	Yes
Division	<p>Used to search for reference customers or deals which belongs to a particular division.</p> <div style="border: 1px solid black; padding: 5px; margin-top: 10px;"> <p>Note: This field appears when you select the Customer or Deal option from the Search By list. You can view only those divisions to which you have access in the Division list.</p> </div>	No
Person Name	Used to search for reference customers or deals whose primary person has a particular name.	No

Field Name	Field Description	Mandatory (Yes or No)
	<p>Note: This field appears when you select the Customer or Deal option from the Search By list.</p>	
Customer Segment	<p>Used to search for reference customers or deals which belong to a particular business component.</p> <p>Note: This field appears when the Customer option is selected from the Search By list and the Advanced Search link is clicked in the top right corner of this zone.</p> <p>This field also appears when the Deal option is selected from the Search By list .</p> <p>The list includes only those values which are specified in the CUST_SEG_FLG lookup field.</p>	No
City	<p>Used to search for reference customers from a particular city.</p> <p>Note: This field appears when the Customer option is selected from the Search By list and the Advanced Search link is clicked in the top right corner of this zone.</p>	No
Address	<p>Used to search for reference customer residing at a particular address.</p> <p>Note: This field appears when the Customer option is selected from the Search By list and the Advanced Search link is clicked in the top right corner of this zone.</p>	No
Phone Number	<p>Used to search for reference customer having a particular phone number.</p> <p>Note: This field appears when the Customer option is selected from the Search By list and the Advanced Search link is clicked in the top right corner of this zone.</p>	No
Person ID	<p>Used to search for a particular person whose price item pricing, price list assignments, and product enrollments you want to use as a reference.</p> <p>Note: This field appears when you select the Customer option from the Search By list.</p>	No

Field Name	Field Description	Mandatory (Yes or No)
Person Identifier Type	Used to indicate the person identifier type based on which you want to search for reference customers or deals.	No
	Note: This field appears when the Customer or Deal option is selected from the Search By list.	
Person Identifier	Used to specify the value for the person identifier type based on which you want to search for search for reference customers or deals.	Yes (Conditional)
	Note: This field appears when you select a person identifier type from the Person Identifier Type list.	Note: If you specify the person identifier type as a search criteria, you have to specify the person identifier.
Prospect Person	Used to indicate whether you want to search for reference deals created for a prospect person. The valid values are: <ul style="list-style-type: none"> • Yes • No 	No
	Note: This field appears when the Deal option is selected from the Search By list.	
Deal ID	Used to search for a particular deal whose price item pricing, price list assignments, and product enrollments you want to use as a reference.	No
	Note: This field appears when the Deal option is selected from the Search By list.	
Template Deal	Used to indicate whether you want to search for template deals whose price item pricing, price list assignments, and product enrollments you want to use as a reference. The valid values are: <ul style="list-style-type: none"> • Yes • No 	No
	Note: This field appears when the Deal option is selected from the Search By list.	
Deal Status	Used to search for reference deals with a particular status.	No

Field Name	Field Description	Mandatory (Yes or No)
	<p>Note:</p> <p>This field appears when the Deal option is selected from the Search By list.</p> <p>The list includes only those values which are specified in the DEAL_STATUS lookup field.</p>	
Deal Type	<p>Used to search for reference deals to which a particular deal type is associated.</p> <p>Note: This field appears when the Deal option is selected from the Search By list.</p>	No

Note: You must specify at least one search criterion while searching for reference customer or deal. One more search criterion is required when you are searching for reference customers using the division.

- **Search Results** - On clicking the **Search** button, a list of reference customers or deals appear based on the specified search criteria. The **Search Results** section contains the following columns:

Column Name	Column Description
Person Information	<p>Displays the concatenated string of person information separated by a comma (.). In addition, a context menu appears corresponding to this field which helps in navigating to other screens in the application.</p> <p>Note:</p> <p>It has a link. On clicking the link, the Person screen appears where you can view the details of the respective person.</p> <p>This column appears when you select the Reference Customers or Customer option from the Search By list.</p>
Person Name	<p>Displays the name of the primary customer.</p> <p>Note: This column appears when you select the Customer option from the Search By list in the Search Criteria section.</p>
Primary Person Identifier Type	Indicates the primary identifier type using which the customer or deal is defined in the system.
Primary Person Identifier	Indicates the value for the primary identifier type using which the customer or deal is defined in the system.
Division	Indicates the division to which the customer or deal is associated.
Customer Segment	Indicates the business component using which the customer or deal is defined in the system.
Customer Tier	Indicates the customer tier of the customer segment to which the customer or the deal belongs.
Deal Information	Displays the concatenated string of deal information separated by a comma (.).

Column Name	Column Description
	<p>Note:</p> <p>It has a link. On clicking the link, the Deal Information screen appears where you can view the details of the respective deal.</p> <p>This column appears when you select the Deal or Reference Deals option from the Search By list in the Search Criteria section.</p>
Deal Status	<p>Indicates the current status of the deal.</p> <p>Note: This column appears when you select the Deal or Reference Deals option from the Search By list in the Search Criteria section.</p>
Deal Version Information	<p>Displays the concatenated string of deal version information separated by a comma (,).</p> <p>Note:</p> <p>It has a link. On clicking the link, the Deal Information screen appears where you can view the details of the respective deal version.</p> <p>This column appears when you select the Deal or Reference Deals option from the Search By list in the Search Criteria section.</p>
Deal Version Status	<p>Indicates the current status of the deal version.</p> <p>Note: This column appears when you select the Deal or Reference Deals option from the Search By list in the Search Criteria section.</p>
Prospect Person Information	<p>Displays the concatenated string of prospect person information for whom the deal is created in the system separated by a comma (,).</p> <p>Note:</p> <p>It has a link. On clicking the link, the Prospect Person screen appears where you can view the details of the respective prospect person.</p> <p>This column appears when you select the Deal or Reference Deals option from the Search By list in the Search Criteria section.</p>
Deal ID	<p>Indicates the identification value of the deal.</p> <p>Note: This column appears when you select the Deal or Reference Deals option from the Search By list in the Search Criteria section.</p>

Note: Pagination is used to display limited number of records in the **Search Results** section. You can use the navigation links, such as **Previous** and **Next** to navigate between pages.

By default, the **Filter** area is visible. You can hide the **Filter** area by clicking the **Filters** () icon in the upper right corner of this zone.

On clicking the **Broadcast** () icon corresponding to a customer or deal the **Reference Details** zone appears where you can select the references for the deal.

Related Topics

For more information on...	See...
How to search for a reference	Searching for a Reference on page 2841
Deal Information - Reference page	Deal Information - Reference on page 2834
Reference Details zone	Reference Details on page 2840

Reference Details

The **Reference Details** zone allows you to indicate whether you want to copy the pricing or commitments from the reference customer or deal for defining the deal. It contains the following fields:

Field Name	Field Description	Mandatory (Yes or No)
Person Name	Displays the name of the primary person for whom the customer or deal is defined in the system whose pricing or commitments you want to use as a reference for defining the deal.	Not applicable
Reference Deal	Displays the concatenated string of deal information separated by a comma (,) whose pricing or commitments you want to use as a reference for defining the deal. Note: This field appears when you select a deal as a reference.	Not applicable
Reference Deal Version	Displays the concatenated string of deal version information separated by a comma (,) whose pricing or commitments you want to use as a reference for defining the deal. Note: This field appears when you are copying reference from a deal which is created for a prospect person.	Not applicable
Division	Indicates the division to which the reference customer or deal belongs.	Not applicable
Customer Segment	Indicates the business component using which the reference customer or deal is defined in the system.	Not applicable
Customer Tier	Indicates the customer tier of the customer segment using which the reference customer or deal is defined in the system.	Not applicable
Refer Usage	Used to indicate whether you want to copy commitments from the SQI-based billable charges of the reference customer or deal.	Yes
Usage Period	Indicates the period for which you want to aggregate the deal data to determine the scope of the deal. The valid values are: <ul style="list-style-type: none"> • Biannually • Monthly • Quarterly 	Not applicable

Field Name	Field Description	Mandatory (Yes or No)
	<ul style="list-style-type: none"> Yearly 	
Refer Pricing	Used to indicate whether you want to copy the price list assignments and price assignments of the reference customer or deal.	Yes
Price Selection Date	Displays the date from when the price lists, pricing assignments, and product enrollments are effective for simulation.	Not applicable

Note: By default, the **Reference Details** zone does not appear in the **Deal Information - Reference** page. It appears when you click the **Broadcast** () icon corresponding to a reference customer or deal in the **Search Results** section of the **Select Reference** zone.

Related Topics

For more information on...	See...
Deal Information - Reference page	Deal Information - Reference on page 2834
Select Reference zone	Select Reference on page 2834

Searching for a Reference

Prerequisites

To search for a reference, you should have:

- Reference customers and reference deals defined in the application
- Pricing and commitments defined for the references

Procedure

To search for a reference:

1. Ensure that the **Deal Information - Reference** page is open when you are searching a reference for a deal.

Note: The **Deal Information - Reference** page appears when you do not select the check box corresponding to the **Skip Reference** option in the **Deal** zone of the **Deal Information - Deal** page while creating a deal.

2. Enter the search criteria in the **Select Reference** zone.

Note: ORMB search engine supports wildcard search, where you can substitute the percentage (%) symbol as a stand in for any word or letter in a search criteria. You can use the ‘%’ wildcard character in all input fields except the date and ID fields. The ‘%’ wildcard character is suffixed automatically at the end of the partial search criteria. Therefore, you may or may not specify the wildcard character at the end of the partial search criteria. However, you have to prefix the wildcard character manually wherever required.

3. Click **Search**.

A list of reference customers or reference deals that meet the search criteria appears in the **Search Results** section.

Note: Pagination is used to display limited number of records in the **Search Results** section. You can use the navigation links, such as **Previous** and **Next** to navigate between pages.

Related Topics

For more information on...	See...
Deal Information - Reference page	Deal Information - Reference on page 2834
Deal zone	Deal on page 2822
Deal Information - Deal page	Deal Information - Deal on page 2816
Select Reference zone	Select Reference on page 2834

Selecting a Reference for a Deal

Prerequisites

To select a reference for a deal, you should have:

- Reference customers and reference deals defined in the application
- Pricing and commitments defined for the references

Procedure

To select a reference for a deal:

1. Search for the reference in the **Select Reference** zone of the **Deal Information - Reference** page.
2. Click the **Broadcast** () icon corresponding to the deal in the **Search Results** section of the **Select Reference** zone whose pricing and commitments you want to use as a reference for defining the deal.

The **Reference Details** zone appears. It contains the following fields:

Field Name	Field Description	Mandatory (Yes or No)
Person Name	Displays the name of the primary person for whom the customer or deal is defined in the system whose pricing or commitments you want to use as a reference for defining the deal.	Not applicable
Reference Deal	Displays the concatenated string of deal information separated by a comma (,) whose pricing or commitments you want to use as a reference for defining the deal. Note: This field appears when you select a deal as a reference.	Not applicable
Reference Deal Version	Displays the concatenated string of deal version information separated by a comma (,) whose pricing or commitments you want to use as a reference for defining the deal. Note: This field appears when you are copying reference from a deal which is created for a prospect person.	Not applicable
Division	Indicates the division to which the reference customer or deal belongs.	Not applicable
Customer Segment	Indicates the business component using which the reference customer or deal is defined in the system.	Not applicable

Field Name	Field Description	Mandatory (Yes or No)
Customer Tier	Indicates the customer tier of the customer segment using which the reference customer or deal is defined in the system.	Not applicable
Refer Usage	Used to indicate whether you want to copy commitments from the SQI-based billable charges of the reference customer or deal.	Yes
Usage Period	Indicates the period for which you want to aggregate the deal data to determine the scope of the deal. The valid values are: <ul style="list-style-type: none"> • Biannually • Monthly • Quarterly • Yearly 	Not applicable
Refer Pricing	Used to indicate whether you want to copy the price list assignments and price assignments of the reference customer or deal.	Yes
Price Selection Date	Displays the date from when the price lists, pricing assignments, and product enrollments are effective for simulation.	Not applicable

3. Enter the required details in the **Reference Details** zone.

4. Click **Save**.

The reference is selected for the deal.

Related Topics

For more information on...	See...
Deal Information - Deal page	Deal Information - Deal on page 2816
Deal zone	Deal on page 2822
Deal Information - Reference page	Deal Information - Reference on page 2834
How to search for a reference	Searching for a Reference on page 2841
Select Reference zone	Select Reference on page 2834

Skipping Reference for a Deal

Procedure

To skip reference for a deal:

1. Ensure that the **Select Reference** zone is expanded in the **Deal Information - Reference** page.
2. Click the **Skip Reference** button in the top right corner of the **Select Reference** zone.

A message appears confirming whether you want to skip the reference.

3. Click **OK**.

The reference is skipped.

Tip: Alternatively, you can skip reference by clicking the check box corresponding to the **Skip Reference** field in the **Deal** zone of the **Deal Information - Deal** page while defining a deal.

Related Topics

For more information on...	See...
Select Reference zone	Select Reference on page 2834
Deal Information - Reference page	Deal Information - Reference on page 2834
Deal Information - Deal page	Deal Information - Deal on page 2816
Deal zone	Deal on page 2822

Deal Information - Pricing and Commitments

The **Deal Information - Pricing and Commitments** page allows you to do the following:

- Assign a proposed price list to the prospect person or account
- Enroll the prospect account for a new product
- Edit the proposed commitments of the prospect account
- Simulate a deal
- Submit a deal for an approval
- Define multiple deal versions
- Discard deal
- Extract deal information in the pdf or excel format

It contains the following zones:

- [Deal Information](#) on page 2845
- [Simulation Details](#) on page 2847

Related Topics

For more information on...	See...
Deal Information screen	Deal Information on page 2815
How to assign a proposed price list to a person	Assigning a Proposed Price List to a Person on page 2983
How to assign a proposed price list to an account	Assigning a Proposed Price List to an Account on page 2984
How to enroll all accounts of a person for a product	Enrolling All Accounts of a Person for a Product on page 2992
How to enroll an account for a product	Enrolling an Account for a Product on page 2997
How to simulate a deal	Simulating a Deal on page 2861
How to submit a deal for an approval	Submitting a Deal for an Approval on page 2862
How to define a deal version	Defining a Deal Version on page 2874
How to discard a deal	Discarding a Deal on page 2865
How to extract a deal in the pdf or excel format	Extracting a Deal in the PDF or Excel Format on page 2779

Deal Information

The **Deal Information** zone allows you to do the following:

- View the details of the deal
- Associate, disassociate, view, or edit the terms and conditions of the deal
- View and add log entries for the deal or deal version
- View and add adhoc revenue charges for the deal or deal version

Field Name	Field Description
Deal Information	Displays the concatenated string of information about the deal separated by a comma (,).
Division	Indicates the division with which the deal is associated.
Deal Type	Indicates the deal type using which the deal is created in the system.
Review Date	Displays the date which is scheduled for calculating the deal usage as per the commitments made by the customer. Note: This field is populated when the deal has reached the Full Orchestrated status.
Deal Version Information	Displays the concatenated string of information about the deal version separated by a comma (,).
Access Group	Indicates the group of users who can view and edit the details of the entity (i.e. the customer, account, or prospect person) for which the deal is created.
Review Frequency	Indicates the duration for which the deal is monitored to calculate the usage of the deal as per the commitments made by the customer.
Effective Start Date	Displays the date from when the deal is effective for the entity (i.e. the customer, account, or prospect person). Note: This field is populated when the deal has reached the Customer Accepted status.
Deal Description	Displays the description of the deal.
Customer Segment	Displays the business component to which the entity (i.e. the customer, account, or prospect person) belongs.
Creation Date	Displays the date when the deal is created in the system.
Effective End Date	Displays the date till when the deal is effective for the entity (i.e. the customer, account, or prospect person). Note: This field is populated when the deal has reached the Customer Accepted status.
Deal Status	Indicates the current status of the deal. The valid values are: <ul style="list-style-type: none"> • Applied/Processed • Approved • Closed • Customer Accepted

Field Name	Field Description
	<ul style="list-style-type: none"> • Discarded • Draft • Error • Finalized • Fully Orchestrated • Hierarchy Creation Deferred • Inactive • Partially Orchestrated • Pending for Approval • Pending for Review • Pending Simulation • Pending for Orchestration • Ready for Approval • Rejected • Simulated • Simulation Deferred
Customer Tier	Indicates the customer tier of the customer segment to which the entity (i.e. the customer, account, or prospect person) belongs.
Start Date	Displays the date from when the price list, price assignment, and price item pricing is available for the deal.
Acceptance Date	<p>Displays the date when the customer has reviewed and accepted the deal.</p> <p>Note: This field is populated when the deal has reached the Customer Accepted status.</p> <p>If the Deal Status is Rejected then the Acceptance Date specifies the date when the deal is rejected by the customer.</p>
Deal Version Status	Indicates the status of the deal version.
Deal Currency	Indicates the currency in which the financial summary and profitability is calculated for the deal.
End Date	Displays the date till when the price list and price assignment is available for the deal.
Finalized Date	<p>Displays the date when the deal is finalized in the system.</p> <p>Note: This field is populated when the deal has reached the Customer Accepted status.</p>
Simulation Type	<p>Indicates the simulation type using which the financial summary and profitability is calculated for the deal. The valid values are:</p> <ul style="list-style-type: none"> • Account • Customer

Field Name	Field Description
	<ul style="list-style-type: none"> Deal
Usage Period	<p>Indicates the period for which you want to aggregate the deal data to determine the scope of the deal. The valid values are:</p> <ul style="list-style-type: none"> Biannually Monthly Quarterly Yearly
Deal Frequency	<p>Indicates the duration in which you want to simulate the deal for calculating the financial summary and deal profitability. The valid values are:</p> <ul style="list-style-type: none"> Biannually Monthly Quarterly Yearly

In addition, the **Deal Information** zone contains the following links:

Link Name	Link Description
Deal Terms and Conditions	Used to associate, disassociate, edit, or view the deal terms and conditions. It is also used to add adhoc terms and conditions for the deal.
Deal Log	Used to view the complete trail of actions performed on the deal. It also allows you to manually add a log entry for the deal.
Deal Version Log	Used to view the complete trail of actions performed on the deal version. It also allows you to manually add a log entry for the deal version.
Adhoc Revenue and Cost	Used to add, edit, or view additional charges that are applicable for the deal while deal creation.

Related Topics

For more information on...	See...
How to view the logs of a deal	Viewing the Logs of a Deal on page 3042
How to add a log entry for a deal	Adding a Log Entry for a Deal on page 3043
How to view the logs of a deal version	Viewing the Logs of a Deal Version on page 3045
How to add a log entry for a deal version	Adding a Log Entry for a Deal Version on page 3046
How to add adhoc revenue charges for a deal	Adding Adhoc Revenue and Cost for a Deal on page 3048
How to associate the terms and conditions with a deal	Associating the Terms and Conditions with a Deal on page 3038
How to view the terms and conditions of a deal	Viewing the Terms and Conditions of a Deal on page 3040
How to edit the terms and conditions of a deal	Editing the Terms and Conditions of a Deal on page 3039







Simulation Details

The **Simulation Details** zone allows you to do the following:

- View the deal financial summary
- View the division financial summary
- View the product financial summary
- View the customer hierarchy
- View the assigned price lists of a person or account
- View the proposed price list assignments of a person or account
- View the enrolled products for an account
- View the proposed product enrollments for an account
- View the pricing and commitment details of a person or account
- View the division financial summary in the division currency
- View the product financial summary in the division currency
- View the revenue and cost in the division or account currency

The **Simulation Details** zone contains the following sections:

- **Symbol Legends** - Indicates the symbols used to identify the current status of the deal level, division level, and product level financial summary. It also differentiates the existing, proposed and recommended pricing statistics. It contains the following symbols:

Symbol Name	Symbol Description
 IN APPROVER RANGE	Indicates that the deal level, division level, or product level financial summary is within the limits defined for the user for approval.
 NOT IN APPROVER RANGE	Indicates that the deal level, division level, or product level financial summary is not within the limits defined for the user for approval.
 PROJECTED	Indicates the revenue, cost, and profit generated from the proposed price item pricing and price assignments.
 RECOMMENDED	Indicates the revenue, cost, and profit generated from the recommended price item pricing and price assignments.
 ORIGINAL	Indicates the revenue, cost, and profit generated from the existing price item pricing and price assignments.
 APPROVED	Indicates whether the deal level, division level, or product level financial summary is approved or not.
 PENDING FOR APPROVAL	Indicates that the approval for deal level, division level, or product level financial summary is pending.

- **Deal Financial Summary** - Displays the financial summary at the deal level. It contains the following columns:

Column Name	Column Description
Approval Status	Indicates the current approval status of the financial summary at the deal level.
Revenue	Displays the proposed, recommended, and original revenue generated from the price item pricing and price assignments at the deal level. Note: If division level approval is required, then the revenue includes the sum of revenues calculated at each division level.

Column Name	Column Description
Cost	Displays the proposed, recommended, and original cost calculated at the deal level.
	<p>Note:</p> <p>The cost includes the total price item cost and the adhoc cost.</p> <p>If division level approval is required, then the cost includes the sum of costs calculated at each division level.</p>
Profit	Displays the proposed, recommended, and original profit in deal currency generated from the price item pricing and price assignments at the deal level. It is calculated using the following formula:
	<p>Profit = Revenue – Cost</p> <p>Note: If division level approval is required, then the profit includes the sum of profits calculated at each division level.</p>
Profitability (%)	Displays the proposed, recommended, and original profit created in percentage at the deal level from the price item pricing and price assignments. It is calculated using the following formula:
	Profitability % = (Revenue – Cost)*100/ Revenue
Profit Variation (%)	Displays the difference of profit in percentage generated from the original and the proposed price item pricing and commitments at the deal level. It is calculated using the following formula:
	Profit Variation (%) = (Proposed Profit – Original Profit)*100/ Original Profit

Note: The data in the **Deal Financial Summary** sections appears when the deal has reached the **Simulated** status.

- **Division Financial Summary** - Displays the financial summary at the division level. It contains the following columns:

Column Name	Column Description
Division	Indicates the division for which the financial summary is displayed.
Approval Status	Indicates the current approval status of the financial summary at the division level.
Revenue	Displays the proposed, recommended, and original revenue generated from the price item pricing and price assignments at the division level.
Cost	Displays the proposed, recommended, and original cost calculated at the division level.
	Note: The cost includes the total price item cost and the adhoc cost.
Profit	Displays the proposed, recommended, and original profit in deal currency generated from the price item pricing and price assignments at the division level. It is calculated using the following formula:
	Profit = Revenue – Cost

Column Name	Column Description
Profitability (%)	Displays the proposed, recommended, and original profit generated in percentage at the division level from the price item pricing and price assignments. It is calculated using the following formula: Profitability % = (Revenue – Cost)*100/ Revenue
Profit Variation (%)	Displays the difference of profit in percentage generated from the original and the proposed price item pricing and commitments at the division level. It is calculated using the following formula: Profit Variation (%) = (Proposed Profit – Original Profit)*100/ Original Profit

Note:

The **Division Financial Summary** sections appears in the **Simulation Details** zone when the **Division Level Approval Required** field is set to **Yes** in the **Deal Type** used for defining the deal.

The data in the **Division Financial Summary** sections appears when the deal has reached the **Simulated** status.

By default, the division financial summary is displayed in the deal currency. You can view the division financial summary in the division currency by clicking the toggle switch towards **Division Currency** available above the financial summary table.

- **Product Financial Summary** - Displays the financial summary at the product level. It contains the following columns:

Column Name	Column Description
Product	Indicates the product whose financial summary is displayed.
Division	Indicates the division to which the product belongs.
Approval Status	Indicates the current approval status of the financial summary at the product level.
Revenue	Displays the proposed, recommended, and original revenue generated from the product.
Cost	Displays the proposed, recommended, and original cost calculated for the product.
	Note: The cost includes the total price item cost and the adhoc cost.
Profit	Displays the proposed, recommended, and original profit in deal currency generated from the price item pricing and price assignments at the product level. It is calculated using the following formula: Profit = Revenue – Cost
Profitability (%)	Displays the proposed, recommended, and original profit generated in percentage from the price item pricing and price assignments at the product level . It is calculated using the following formula: Profitability % = (Revenue – Cost)*100/ Revenue
Profit Variation (%)	Displays the difference of profit in percentage generated from the original and the proposed price item pricing and commitments at the product level. It is calculated using the following formula:

Column Name	Column Description
	Profit Variation (%) = (Proposed Profit – Original Profit)*100/ Original Profit

Note:

The **Product Financial Summary** sections appears in the **Simulation Details** zone when the **Product Level Approval Required** field is set to **Yes** in the **Deal Type** used for defining the deal.

The data in the **Product Financial Summary** sections appears when the deal has reached the **Simulated** status.

By default, the product financial summary is displayed in the deal currency. You can view the product financial summary in the division currency by clicking the toggle switch towards **Division Currency** available above the financial summary table.

- **Customer Hierarchy** - Indicates the main customer and its associated accounts as well as the child persons and its accounts that are associated with the main customer. It also enables you to do the following:
 - View and edit the pricing and commitments at the person and account level
 - View the revenue variation from the proposed and original pricing and commitments
 - View the proposed price lists of a person or account
 - Assign proposed price list to a person or account
 - View the enrolled products of an account
 - Enroll accounts for a product
 - View the original price list of a person or account
 - View the original enrolled products for an account
 - View the proposed or the original revenue and cost generated at the person an account level.

The **Customer Hierarchy** section contains the following columns:



Column Name	Column Description
Person Name	Indicates the main customer and its related persons and accounts.
Division	Indicates the division to which the main customer and it related persons and accounts are associated.
Pricing and Commitments	<p>On clicking the Edit (✎) icon in the Pricing and Commitments column corresponding to a person or account in the hierarchy, the Pricing and Commitments screen appears where you can view and edit the pricing and commitments of the price items for the respective person or account.</p> <p>Note: You cannot edit the pricing or commitments of the price items if the deal has reached the Finalized status.</p>
Status	Indicates the approval status of the price item pricing and price assignments for the respective person or account.
Revenue Variation (%)	<p>Displays the average revenue generated from a customer or account in percentage. It is calculated using the following formula:</p> $\text{Revenue Variation (\%)} = (\text{Proposed Revenue} - \text{Original Revenue}) * 100 / \text{Original Revenue}.$

Column Name	Column Description
Price List Assignment	<p>On clicking the Edit (✎) icon in the Price List Assignment column corresponding to a person or account in the hierarchy, the Price List Assignment screen appears where you can view and assign proposed price list to the respective person or account.</p> <p>Note: You cannot assign proposed price list to the person or account if the deal has reached the Finalized status.</p>
Product Enrollment	<p>On clicking the Edit (✎) icon in the Product Enrollment column corresponding to the person or account in the hierarchy, the Product Enrollment screen appears where you can view or enroll the respective account or accounts of the customer for a product. You can also view a list of recommended products for which you want to enroll the account or accounts of the customer. The recommended products appear in the Product Enrollment screen when you add products in the Recommended Products section while defining a deal.</p> <p>Note: You cannot enroll an account for a product if the deal has reached the Finalized status.</p>
Price Item Group Selection	<p>On clicking the Edit (✎) icon in the Price Item Group Selection column corresponding to the main person in the hierarchy, the Select Price Item Group screen appears where you can select and/or deselect the price items and/or hierarchy entities based on which you want to simulate the deal.</p>
Revenue	<p>Indicates the revenue generated by the corresponding person or account in the hierarchy through the proposed price item pricing and commitments.</p>
Cost	<p>Indicates the sum of the proposed costs from all accounts under the customer.</p> <p>Note: If the person is a parent customer, then the sum of the proposed costs of all the child customers is considered.</p>
Pricelist	<p>On clicking the View (📄) icon in the Price List column corresponding to the person or account in the hierarchy, the Price List Assignment screen appears where you can view the original price list assigned to the respective person or account.</p>
Product	<p>On clicking the Edit (✎) icon in the Product column corresponding to the person or account in the hierarchy, the Product Enrollment screen appears where you can view the products to which the account is already enrolled.</p>
Revenue	<p>Indicates the revenue generated by the corresponding person or account in the hierarchy through the original price item pricing and commitments.</p>
Cost	<p>Indicates the sum of the original costs from all accounts under the customer.</p> <p>Note: If the person is a parent customer, then the sum of the original costs of all the child customers is considered.</p>

Note: The system also considers the prospect persons and prospect accounts associated with the main customer along with the child and grandchild persons and their accounts in the customer hierarchy.

In addition, the **Simulation Details** zone contains the following buttons:

Button Name	Button Description
Deal Pricing and Commitments	Used to define the consolidated pricing and commitments for the customers or accounts in a deal.
Simulate Deal	Used to perform different types of simulation based on the pricing and commitments of the price item to determine the best price that can be offered to the clients as per their requirements.
Check Limits	<p>Used to execute the price item ceil and floor validation for an approver as per the limits set on the price item screen.</p> <p>Note:</p> <p>The Check Limits is run only for the price items which are in the Pending for Approval or Error status after the Pricing Simulation is executed.</p> <p>The Check Limits button is activated when the Price Item Approval Required option is set to Yes in the Deal Type using which the deal is created.</p>
Send Deal for Approval	<p>Used to move the deal from the current role to the next role of the next level in the approval hierarchy for approval.</p> <p>Note:</p> <p>On clicking the Send Deal for Approval button, a To Do notification is created for the users of the next level to indicate that approval of the deal is required.</p> <p>A To Do is also created for the creator (i.e. the Relationship Manager) of the deal to indicate that the ownership of the deal has changed.</p> <p>This button is activated after Pricing Simulation is completed for the deal and if the Approve Deal option is set to Yes for the approver in the Approval Hierarchy of the Deal Approval Profile.</p>
Approve Deal	<p>Used to approve the deal. To approve a deal the following conditions should be met:</p> <ul style="list-style-type: none"> • All the price items should be in the Approved status if the Price Item Approval Required option is set to Yes in the Deal Type used for creating the deal. • All the division level approvals must be completed if the Division Level Approval Required field is set to Yes in the Deal Type used for creating the deal. • All the product level approvals must be completed if the Product Level Approval Required field is set to Yes in the Deal Type used for creating the deal. • The deal should be in the Ready for Approval status for the approver to initiate the deal approval process. <p>Note:</p> <p>The Approve Deal button is activated only when the deal is in the Ready for Approval status and the Approve Deal option is set to Yes for the approver in the Approval Hierarchy of the Deal Approval Profile.</p>
Return to Submitter	Used to move the deal from the current role to the previous role of the previous level in the approval hierarchy for approval. It is also used to send the deal to the

Button Name	Button Description
	<p>relationship manager for approval if you have recommended a new pricing for the price item.</p> <p>Note:</p> <p>On clicking the Return to Submitter button, a To Do notification is created for the users of the previous level to indicate that the deal is returned for approval.</p> <p>A To Do is also created for the creator (i.e. the Relationship Manager) of the deal to indicate that the ownership of the deal has changed.</p>
Finalize Deal	<p>Used to finalize the deal so that it is ready to be presented to the customer for approval.</p> <p>Note: This button is activated when the deal is in the Approved status.</p> <p>Tip: You can also finalize a deal by clicking the Finalize () icon in the Finalize Deal column corresponding to the deal in the Search Deal zone of the Deal Dashboard screen.</p>
Accept Deal	<p>Used to accept the deal in the system after receiving confirmation of acceptance from the customer.</p> <p>Note: This button is activated only when the deal is in the Finalized status.</p> <p>Tip: You can also accept a deal by clicking the Accept () icon in the Accept Deal column corresponding to the deal in the Search Deal zone of the Deal Dashboard screen.</p>
Reject Deal	<p>Used to reject the deal in the system after receiving confirmation of rejection from the customer.</p> <p>Note: This button is activated only when the deal is in the Finalized status.</p> <p>Tip: You can also reject a deal by clicking the Reject () icon in the Reject Deal column corresponding to the deal in the Search Deal zone of the Deal Dashboard screen.</p>
Create Deal Version	<p>Used to create a deal version for the existing deal to optimize the deal pricing process and to make better pricing decisions.</p> <p>Note: You can add a new deal version to a deal even if the version of any deal version of a deal is in the Finalized status and the status of the deal is Pending for Approval or Approved.</p>
Discard Deal	<p>Used to discard the deal.</p> <p>Note: You cannot discard a deal if it has reached the Finalized status.</p>
Print Deal	<p>Used to extract relevant information about the deal in the pdf or excel format which is published either to the customer for receiving approvals or for internal reviews and validations.</p>

Button Name	Button Description
Apply Back	Used to activate the proposed pricelist assignments, overridden pricing, and product enrollments for the existing customer or account in the system.
Previous	Used to view information about the previous status of the deal.

Related Topics

For more information on...	See...
Search Deal zone	Search Deal on page 2758
Price List Assignment screen	Price List Assignment on page 2979
Product Enrollment screen	Product Enrollment on page 2987
Pricing and Commitments screen	Pricing and Commitments on page 2934
Pricing and Commitments screen	Pricing and Commitments on page 3002
How to view the customer hierarchy of a deal	Viewing the Customer Hierarchy of a Deal on page 2856
How to view the existing price lists of a person or an account	Viewing the Assigned Price Lists of a Person or Account on page 2856
How to view the proposed price lists of a person or an account	Viewing the Proposed Price List Assignments of a Person or Account on page 2857
How to view the existing products enrolled for an account	Viewing the Enrolled Products of an Account on page 2857
How to view the proposed products enrolled for an account	Viewing the Proposed Product Enrollments for an Account on page 2858
How to view the pricing and commitment details of a prospect person	Viewing the Pricing and Commitment Details of a Person on page 2858
How to view the pricing and commitment details of a prospect account	Viewing the Pricing and Commitment Details of an Account on page 2859
How to view the division financial summary in the division currency	Viewing the Division Financial Summary in the Division Currency on page 2859
How to view the product financial summary in the division currency	Viewing the Product Financial Summary in the Division Currency on page 2860
How to view the revenue and cost in the division or account currency	Viewing the Revenue and Cost in the Division or Account Currency on page 2861
How to simulate a deal	Simulating a Deal on page 2861
How to submit a deal for approval	Submitting a Deal for an Approval on page 2862
How to approve a deal	Approving a Deal on page 2862
How to request the submitter to resubmit the deal for approval	Requesting the Submitter to Resubmit the Deal for Approval on page 2863
How to finalize a deal	Finalizing a Deal on page 2775
How to discard a deal	Discarding a Deal on page 2865
How to accept a deal	Accepting a Deal on page 2776
How to reject a deal	Rejecting a Deal on page 2777

For more information on...	See...
How to extract a deal in the pdf or excel format	Extracting a Deal in the PDF or Excel Format on page 2779
How to define a deal version	Defining a Deal Version on page 2874

Viewing the Customer Hierarchy of a Deal

Procedure

To view the customer hierarchy of a deal:

1. Search for the deal whose customer hierarchy you want to view in the **Search Deal** zone of the **Deal Dashboard** screen.
2. In the **Search Results** section, click the link in the **Deal Information** column corresponding to the deal whose customer hierarchy you want to view.

The **Deal Information** screen appears.

3. View the customer hierarchy in the **Simulation Details** zone.

Related Topics

For more information on...	See...
How to search for a deal	Searching for a Deal on page 2773
Deal Dashboard screen	Deal Dashboard on page 2757
Search Deal zone	Search Deal on page 2758
Simulation Details zone	Simulation Details on page 2847

Viewing the Assigned Price Lists of a Person or Account

Procedure

To view the assigned price lists of a person or account:

1. Search for the deal of an entity (i.e. the customer, account, or prospect person) whose existing price lists details you want to view in the **Search Deal** zone of the **Deal Dashboard** screen.
2. In the **Search Results** section, click the link in the **Deal Information** column corresponding to the deal whose assigned price lists details you want to view.

The **Deal Information** screen appears.

3. Ensure that the customer hierarchy is expanded in the **Simulation Details** zone.
4. Click the **View** () icon in the **Pricelist** column corresponding to the person or account whose assigned price lists details you want to view.

The **Price List Assignment** screen appears.

5. View the assigned price lists of the person or account in the **Existing Price Lists** section.

Related Topics

For more information on...	See...
How to search for a deal	Searching for a Deal on page 2773
Search Deal zone	Search Deal on page 2758
Deal Dashboard screen	Deal Dashboard on page 2757

For more information on...	See...
Deal Information screen	Deal Information on page 2815
Simulation Details zone	Simulation Details on page 2847

Viewing the Proposed Price List Assignments of a Person or Account

Procedure

To view the proposed price list assignments of a person or account:

1. Search for the deal of an entity (i.e. the customer, account, or prospect person) whose proposed price lists details you want to view in the **Search Deal** zone of the **Deal Dashboard** screen.
2. In the **Search Results** section, click the link in the **Deal Information** column corresponding to the deal whose proposed price lists details you want to view.
The **Deal Information** screen appears.
3. Ensure that the customer hierarchy is expanded in the **Simulation Details** zone.
4. Click the **Edit** () icon in the **Price List Assignment** column corresponding to the person or account whose proposed price list assignments you want to view.
The **Price List Assignment** screen appears.
5. View the proposed price list assignments of the person or account in the **Proposed Price Lists** zone.

Related Topics

For more information on...	See...
How to search for a deal	Searching for a Deal on page 2773
Search Deal zone	Search Deal on page 2758
Deal Dashboard screen	Deal Dashboard on page 2757
Deal Information screen	Deal Information on page 2815
Simulation Details zone	Simulation Details on page 2847
Price List Assignment screen	Price List Assignment on page 2979

Viewing the Enrolled Products of an Account

Procedure

To view the enrolled products of an account:

1. Search for the deal of an entity (i.e. customer, account, or prospect) whose existing enrolled products for the account you want to view in the **Search Deal** zone of the **Deal Dashboard** screen.
2. In the **Search Results** section, click the link in the **Deal Information** column corresponding to the deal whose enrolled products for the account you want to view.
The **Deal Information** screen appears.
3. Ensure that the customer hierarchy is expanded in the **Simulation Details** zone.
4. Click the **View** () icon in the **Product** column corresponding to the account whose enrolled products you want to view.
The **Product Enrollment** screen appears.
5. View the enrolled products of the account in the **Enrolled Products** section.

Related Topics

For more information on...	See...
How to search for a deal	Searching for a Deal on page 2773
Search Deal zone	Search Deal on page 2758
Deal Dashboard screen	Deal Dashboard on page 2757
Deal Information screen	Deal Information on page 2815
Simulation Details zone	Simulation Details on page 2847

Viewing the Proposed Product Enrollments for an Account**Procedure**

To view the proposed product enrollments for an account:

1. Search for the deal of an entity (i.e. the customer, account, or prospect person) whose proposed product enrollments for the account are listed in the **Search Deal** zone of the **Deal Dashboard** screen.
2. In the **Search Results** section, click the link in the **Deal Information** column corresponding to the deal whose proposed product enrollments for the account you want to view.
The **Deal Information** screen appears.
3. Ensure that the customer hierarchy is expanded in the **Simulation Details** zone.
4. Click the **Edit**  icon in the **Product Enrollment** column corresponding to the account whose proposed product enrollments you want to view.
The **Product Enrollment** screen appears.
5. View the proposed product enrollments for the account in the **Proposed Products** section.

Related Topics

For more information on...	See...
How to search for a deal	Searching for a Deal on page 2773
Search Deal zone	Search Deal on page 2758
Deal Dashboard screen	Deal Dashboard on page 2757
Deal Information screen	Deal Information on page 2815
Simulation Details zone	Simulation Details on page 2847
Product Enrollment screen	Product Enrollment on page 2987

Viewing the Pricing and Commitment Details of a Person**Procedure**

To view the pricing and commitment details of a person:

1. Search for the deal of an entity (i.e. the customer, account, or prospect person) whose pricing and commitment details for the person you want to view in the **Search Deal** zone of the **Deal Dashboard** screen.
2. In the **Search Results** section, click the link in the **Deal Information** column corresponding to the deal whose pricing and commitment details for the person you want to view.
The **Deal Information** screen appears.
3. Ensure that the customer hierarchy is expanded in the **Simulation Details** zone.

- Click the **Edit** (✎) icon in the **Pricing and Commitments** column corresponding to the person whose pricing and commitment details you want to view.

The **Pricing and Commitments** screen appears.

- View the pricing and commitment details of the person in the **Pricing and Commitments** section.

Related Topics

For more information on...	See...
How to search for a deal	Searching for a Deal on page 2773
Search Deal zone	Search Deal on page 2758
Deal Dashboard screen	Deal Dashboard on page 2757
Deal Information screen	Deal Information on page 2815
Simulation Details zone	Simulation Details on page 2847
Pricing and Commitments screen	Pricing and Commitments on page 2934

Viewing the Pricing and Commitment Details of an Account

Procedure

To view the pricing and commitment details of an account:

- Search for the deal of an entity (i.e. the customer, account, or prospect person) whose pricing and commitment details for the account you want to view in the **Search Deal** zone of the **Deal Dashboard** screen.
- In the **Search Results** section, click the link in the **Deal Information** column corresponding to the deal whose pricing and commitment details for the account you want to view.

The **Deal Information** screen appears.

- Ensure that the customer hierarchy is expanded in the **Simulation Details** zone.
- Click the **Edit** (✎) icon in the **Pricing and Commitments** column corresponding to the account whose pricing and commitment details you want to view.

The **Pricing and Commitments** screen appears.

- View the pricing and commitment details of the account in the **Pricing and Commitments** section.

Related Topics

For more information on...	See...
How to search for a deal	Searching for a Deal on page 2773
Search Deal zone	Search Deal on page 2758
Deal Dashboard screen	Deal Dashboard on page 2757
Deal Information screen	Deal Information on page 2815
Simulation Details zone	Simulation Details on page 2847
Pricing and Commitments screen	Pricing and Commitments on page 2934

Viewing the Division Financial Summary in the Division Currency

Procedure

To view the division financial summary in the division currency:

1. Search for the deal in the **Search Deal** zone of the **Deal Dashboard** screen whose division financial summary you want to view in the division currency.
2. In the **Search Results** section, click the link in the **Deal Information** column corresponding to the deal whose division financial summary you want to view in the division currency.
The **Deal Information** screen appears.
3. Ensure that the **Simulation Details** zone is expanded in the **Deal Information** screen.
4. Click the toggle switch available in the **Division Financial Summary** section towards the **Division Currency** option.

The division financial summary is displayed in the division currency.

Note: By default, the toggle switch is engaged towards the **Deal Currency** option.

5. View the division financial summary in the division currency.

Related Topics

For more information on...	See...
How to search for a deal	Searching for a Deal on page 2773
Search Deal zone	Search Deal on page 2758
Deal Dashboard screen	Deal Dashboard on page 2757
Deal Information screen	Deal Information on page 2815
Simulation Details zone	Simulation Details on page 2847

Viewing the Product Financial Summary in the Division Currency

Procedure

To view the product financial summary in the division currency:

1. Search for the deal in the **Search Deal** zone of the **Deal Dashboard** screen whose product financial summary you want to view in the division currency.
2. In the **Search Results** section, click the link in the **Deal Information** column corresponding to the deal whose product financial summary you want to view in the division currency.
The **Deal Information** screen appears.
3. Ensure that the **Simulation Details** zone is expanded in the **Deal Information** screen.
4. Click the toggle switch available in the **Product Financial Summary** section towards the **Division Currency** option.

The product financial summary is displayed in the division currency.

Note: By default, the toggle switch is engaged towards the **Deal Currency** option.

5. View the product financial summary in the division currency.

Related Topics

For more information on...	See...
How to search for a deal	Searching for a Deal on page 2773
Search Deal zone	Search Deal on page 2758

For more information on...	See...
Deal Dashboard screen	Deal Dashboard on page 2757
Deal Information screen	Deal Information on page 2815
Simulation Details zone	Simulation Details on page 2847

Viewing the Revenue and Cost in the Division or Account Currency

Procedure

To view the revenue and cost in the division or account currency:

1. Search for the deal in the **Search Deal** zone of the **Deal Dashboard** screen whose revenue and cost you want to view in the division or account currency.
2. In the **Search Results** section, click the link in the **Deal Information** column corresponding to the deal whose revenue and cost you want to view in the division or account currency.
The **Deal Information** screen appears.
3. Ensure that the **Simulation Details** zone is expanded in the **Deal Information** screen.
4. Click the toggle switch available in the **Customer Hierarchy** section towards the **Customer Division / Account Currency** option.
The revenue and cost is displayed in the division or account currency.

Note: By default, the toggle switch is engaged towards the **Deal Currency** option.

5. View the revenue and cost in the division or account currency.

Related Topics

For more information on...	See...
How to search for a deal	Searching for a Deal on page 2773
Search Deal zone	Search Deal on page 2758
Deal Dashboard screen	Deal Dashboard on page 2757
Deal Information screen	Deal Information on page 2815
Simulation Details zone	Simulation Details on page 2847

Simulating a Deal

Procedure

To simulate a deal:

1. Search for the deal in the **Search Deal** zone of the **Deal Dashboard** screen.
2. In the **Search Results** section, click the link in the **Deal Information** column corresponding to the deal that you want to simulate.
The **Deal Information** screen appears.
3. Click the **Simulate Deal** button in the **Simulation Details** zone.
A message appears confirming the simulation of the deal.
4. Click **OK**.
The deal is simulated.

Note:

A deal can be simulated when it is in the **Pending Simulation** status.

Related Topics

For more information on...	See...
How to search for a deal	Searching for a Deal on page 2773
Deal Dashboard screen	Deal Dashboard on page 2757
Search Deal zone	Search Deal on page 2758
Simulation Details zone	Simulation Details on page 2847

Submitting a Deal for an Approval**Procedure**

To submit a deal for an approval:

1. Search for the deal in the **Search Deal** zone of the **Deal Dashboard** screen.
2. In the **Search Results** section, click the link in the **Deal Information** column corresponding to the deal that you want to send for an approval.

The **Deal Information** screen appears.

3. Click the **Send Deal for Approval** button in the **Simulation Details** zone.

A message appears confirming that the deal is successfully submitted for approval.

4. Click **OK**.

The deal is submitted for an approval.

Note:

A deal can be submitted for an approval when it is in the **Simulated** status.

Only the creator (i.e. the relationship manager) can submit a deal for an approval.

Related Topics

For more information on...	See...
How to search for a deal	Searching for a Deal on page 2773
Deal Dashboard screen	Deal Dashboard on page 2757
Search Deal zone	Search Deal on page 2758
Simulation Details zone	Simulation Details on page 2847

Approving a Deal**Procedure**

To approve a deal:

1. Search for the deal in the **Search Deal** zone of the **Deal Dashboard** screen.

Tip: You can also click the link on the deal that is assigned to you for an approval in the **Deal To Do** zone.

- In the **Search Results** section, click the link in the **Deal Information** column corresponding to the deal that you want to approve.

The **Deal Information** screen appears.

- Click the **Approve Deal** button in the **Simulation Details** zone.

A message appears confirming the deal is approved successfully.

- Click **OK**.

The deal is approved.

Note:

A deal can be approved only when it is in the **Pending For Approval** status.

A user can approve a deal when the **Approve Deal** field is set to **Yes** for the user in the **Approval Hierarchy** section of the **Deal Approval Profile** zone.

Related Topics

For more information on...	See...
How to search for a deal	Searching for a Deal on page 2773
Deal Dashboard screen	Deal Dashboard on page 2757
Search Deal zone	Search Deal on page 2758
Simulation Details zone	Simulation Details on page 2847
Deal Approval Profile zone	Deal Approval Profile on page 2675
Deal Approval Profile screen	Deal Approval Profile on page 2674

Requesting the Submitter to Resubmit the Deal for Approval

Procedure

To request the submitter to resubmit the deal for approval:

- Search for the deal in the **Search Deal** zone of the **Deal Dashboard** screen.

Tip: You can also click the link on the deal that is assigned to you for an approval in the **Deal To Do** zone.

- In the **Search Results** section, click the link in the **Deal Information** column corresponding to the deal that you want to resubmit to the submitter for approval.

The **Deal Information** screen appears.

- Click the **Return to Submitter** button in the **Simulation Details** zone.

A message appears confirming whether you want to return the deal to the submitter for approval.

- Click **OK**.

The deal is resubmitted to the submitter for approval.

Related Topics

For more information on...	See...
How to search for a deal	Searching for a Deal on page 2773
Deal Dashboard screen	Deal Dashboard on page 2757

For more information on...	See...
Search Deal zone	Search Deal on page 2758
Simulation Details zone	Simulation Details on page 2847

Finalizing a Deal

Procedure

To finalize a deal:

1. Do either of the following:

If you want to...	Then...
Finalize a deal from the Deal Dashboard screen	<ol style="list-style-type: none"> 1. Search for the deal in the Search Deal zone of the Deal Dashboard screen. 2. In the Search Results section, click the Finalize () icon in the Finalize Deal column corresponding to the deal which you want to finalize.
Finalize a deal from the Deal Information screen	<ol style="list-style-type: none"> 1. Search for the deal in the Search Deal zone of the Deal Dashboard screen. 2. In the Search Results section, click the link in the Deal Information column corresponding to the deal which you want to finalize. The Deal Information screen appears. 3. In the Simulation Details zone, click the Finalize Deal button.

A message appears confirming whether you want to finalize the deal.

2. Click **OK**.

The deal is finalized.

Note:

You can finalize a deal when it is in the **Approved** status.

After finalizing a deal, the status of the deal changes to **Finalized**.

Related Topics

For more information on...	See...
How to search for a deal	Searching for a Deal on page 2773
Deal Dashboard screen	Deal Dashboard on page 2757
Search Deal zone	Search Deal on page 2758
Deal Information screen	Deal Information on page 2815

For more information on...	See...
Simulation Details zone	Simulation Details on page 2847

Discarding a Deal

Procedure

To discard a deal:

1. Search for the deal in the **Search Deal** zone of the **Deal Dashboard** screen.
2. In the **Search Results** section, click the link in the **Deal Information** column corresponding to the deal which you want to discard.

The **Deal Information** screen appears.

3. In the **Simulation Details** zone, click the **Discard Deal** button.

A message appears confirming whether you want to discard the deal.

4. Click **OK**.

The deal is discarded.

Note: You cannot discard a deal if it has reached the **Finalized** status.

Related Topics

For more information on...	See...
How to search for a deal	Searching for a Deal on page 2773
Deal Dashboard screen	Deal Dashboard on page 2757
Search Deal zone	Search Deal on page 2758

Accepting a Deal

Procedure

To accept a deal:

1. Do either of the following:

If you want to...	Then...
Accept a deal from the Deal Dashboard screen	<ol style="list-style-type: none"> 1. Search for the deal in the Search Deal zone of the Deal Dashboard screen. 2. In the Search Results section, click the Accept () icon in the Accept Deal column corresponding to the deal which you want to accept.
Accept a deal from the Deal Information screen	<ol style="list-style-type: none"> 1. Search for the deal in the Search Deal zone of the Deal Dashboard screen. 2. In the Search Results section, click the link in the Deal Information column corresponding to the deal which you want to accept.

If you want to...	Then...
	<p>The Deal Information screen appears.</p> <p>3. In the Simulation Details zone, click the Accept Deal button.</p>

The **Deal Acceptance** screen appears. It contains the following fields:

Field Name	Field Description	Mandatory (Yes or No)
Status	<p>Displays the status of the deal. The valid value is:</p> <ul style="list-style-type: none"> Customer Accepted 	Not applicable
Effective Start Date	<p>Used to specify the date from when the deal is effective for the customer.</p> <p>Note:</p> <p>Earlier, the Effective Start Date was defaulted to the Deal Start Date. Now, while accepting a deal, the system defaults either of the following date:</p> <ul style="list-style-type: none"> Deal start date when the deal start date is equal to or later than the system date System date when the deal start date is earlier than the system date <p>You can then edit the Effective Start Date, if required.</p>	Yes
Effective End Date	Used to specify the date till when the deal is effective for the customer.	No
Comments	Used to specify information about accepting the deal.	No

- Enter the required details in the **Deal Acceptance** screen.
- Click **Save**.

The deal is accepted.

Note:

You can accept a deal only when it is in the **Finalized** status.

After accepting a deal, the status of the deal changes to **Customer Accepted**.

Related Topics

For more information on...	See...
How to search for a deal	Searching for a Deal on page 2773
Deal Dashboard screen	Deal Dashboard on page 2757

For more information on...	See...
Search Deal zone	Search Deal on page 2758
Deal Information screen	Deal Information on page 2815
Simulation Details zone	Simulation Details on page 2847

Rejecting a Deal

Procedure

To reject a deal:

1. Do either of the following:

If you want to...	Then...
Reject a deal from the Deal Dashboard screen	<ol style="list-style-type: none"> 1. Search for the deal in the Search Deal zone of the Deal Dashboard screen. 2. In the Search Results section, click the Reject (✖) icon in the Reject Deal column corresponding to the deal which you want to reject.
Reject a deal from the Deal Information screen	<ol style="list-style-type: none"> 1. Search for the deal in the Search Deal zone of the Deal Dashboard screen. 2. In the Search Results section, click the link in the Deal Information column corresponding to the deal which you want to reject. The Deal Information screen appears. 3. In the Simulation Details zone, click the Reject Deal button.

The **Deal Rejection** screen appears. It contains the following fields:

Field Name	Field Description	Mandatory (Yes or No)
Status	Displays the status of the deal. The valid value is: <ul style="list-style-type: none"> • Rejected 	Not applicable
Comments	Used to specify information about rejecting the deal.	No

2. Enter the required details in the **Deal Rejection** screen
3. Click **Save**.

The deal is rejected.

Note:

You can reject a deal only when it is in the **Finalized** status.

After rejecting a deal, the status of the deal changes to **Rejected**.



Related Topics

For more information on...	See...
How to search for a deal	Searching for a Deal on page 2773
Deal Dashboard screen	Deal Dashboard on page 2757
Search Deal zone	Search Deal on page 2758
Deal Information screen	Deal Information on page 2815
Simulation Details zone	Simulation Details on page 2847

Extracting a Deal in the PDF or Excel Format**Procedure**

To extract a deal in the pdf or excel format:

1. Do either of the following:

If you want to...	Then...
Extract a deal in the PDF or Excel format from the Deal Dashboard screen	<ol style="list-style-type: none"> 1. Search for the deal in the Search Deal zone of the Deal Dashboard screen. 2. In the Search Results section, click the Print () icon in the Print Deal column corresponding to the deal which you want to extract in the pdf or excel format. <p>Note: If the deal has multiple versions, click the Print () icon in the Print Deal column corresponding to the deal version in the Deal Versions zone.</p>
Extract a deal in the PDF or Excel format from the Deal Information screen	<ol style="list-style-type: none"> 1. Search for the deal in the Search Deal zone of the Deal Dashboard screen. 2. In the Search Results section, click the link in the Deal Information column corresponding to the deal which you want to extract in the pdf or excel format. <p>Note: If you want to extract the deal version in the pdf or excel format, click the link in the Deal Version Information column corresponding to the deal version from the Deal Versions zone.</p> <p>The Deal Information screen appears.</p>

If you want to...	Then...
	<ol style="list-style-type: none"> 3. In the Simulation Details zone, click the Print Deal button.
Extract a deal in the PDF or Excel format from the Deal Approver Dashboard screen	<ol style="list-style-type: none"> 1. Search for the deal in the Search Deal zone of the Deal Approver Dashboard screen. 2. In the Search Results section, click the Print () icon in the Print Deal column corresponding to the deal which you want to extract in the pdf or excel format.

The **Deal Extraction** screen appears. It contains the following fields:

Field Name	Field Description	Mandatory (Yes or No)
Extract Format	Used to specify the format in which you want to extract the deal information. The valid values are: <ul style="list-style-type: none"> • Excel • PDF 	Yes (Conditional) Note: This field is required while extracting a deal in the pdf or excel format.
Extract Type	Used to indicate the type of deal information that you want to extract for publishing. The valid values are: <ul style="list-style-type: none"> • External - Used to extract deal information which is published to the customer for approval. It contains the following details: <ol style="list-style-type: none"> 1. Extraction information i.e. the extraction date-time and the user who has done the extraction. 2. Details of the filters selected for extraction. 3. Deal details such as the deal creator user ID, deal creation date and time, deal ID, deal type, prospect/customer, currency, deal status etc. 4. Customer hierarchy, accounts and price item details as per the filter option selected in the Deal Extraction screen. 5. Price item details such as the original price with assignment level, commitments, negotiated price with assignment level, approval status, etc. 6. Terms and conditions. 	Yes (Conditional) Note: This field is required while extracting a deal in the pdf or excel format.

Field Name	Field Description	Mandatory (Yes or No)
	<p>Note:</p> <p>The External extract type controls the extraction of certain data which may or may not be published to the customer.</p> <p>You can select the External option from the Extract Type list when the deal is in the Finalized, Customer Accepted, Rejected, Fully Orchestrated, Pending for Review, or Closed status.</p>	
	<ul style="list-style-type: none"> • Internal - Used to extract deal information which is published for internal reviews and validations. It contains the following details: <ol style="list-style-type: none"> 1. Deal summary details and Division summary details with the applicable cost, profitability, revenue and other calculations. 2. Price item details such as the cost and revenue details etc. 3. Adhoc revenue and cost entries. <p>Note:</p> <p>By default, the Internal option is selected from the Extract Type list for deals which are not in the Finalized, Customer Accepted, Rejected, Fully Orchestrated, Pending for Review, or Closed status.</p> <p>The list includes only those values which are present in the DEAL_EXTRACT_TYPE_FLG lookup field.</p>	
Extract Filter	<p>Used to indicate the price item information that you want to extract in the pdf or excel format. The valid values are:</p> <ul style="list-style-type: none"> • Account • Additional Filter Criteria • All • Customer • Division • Only Hierarchy • Price Assignment Level • Price Item 	<p>Yes (Conditional)</p> <p>Note: This field is required while extracting a deal in the pdf or excel format.</p>

Field Name	Field Description	Mandatory (Yes or No)
	<ul style="list-style-type: none"> Price Item Group <p>Note: The list includes only those values which are present in the DEAL_EXTRACT_FILTER_FLG lookup field.</p>	

In addition, the **Deal Extraction** screen contains the following fields:

Field Name	Field Description	Mandatory (Yes or No)
Account ID	<p>Used to specify the persons or prospects account for which you want to extract the price item pricing details.</p> <p>Note:</p> <p>The Search (🔍) icon appears corresponding to this field. On clicking the Search icon, the Prospect Account Search window appears where you can search for the respective account.</p> <p>This field appears when you select the Account option from the Extract Filter list.</p>	<p>Yes (Conditional)</p> <p>Note: This field is required while extracting the proposed price item pricing details of an account.</p>
Price Item	<p>Used to specify the price item for which you want to extract the pricing details.</p> <p>Note:</p> <p>The Search (🔍) icon appears corresponding to this field. On clicking the Search icon, the Price Item Search window appears where you can search for the respective price item.</p> <p>This field appears when you select the Account, Customer, and Price Item options from the Extract Filter list.</p>	No
Price Item Group Code	<p>Used to specify the root level hierarchy entity for which you want to extract the price item pricing details.</p> <p>Note:</p> <p>The Search (🔍) icon appears corresponding to this field. On clicking the Search icon, the Hierarchy Entity Search window appears where you can search for the respective root level hierarchy entity.</p> <p>This field appears when you select the Account, Customer, and Price Item Group options from the Extract Filter list.</p>	No

Field Name	Field Description	Mandatory (Yes or No)
Proposed Price Assignment Level	Used to extract the proposed price item pricing details for a particular assignment level.	No
	<p>Note:</p> <p>The list includes only those values which are present in the PA_LVL_FLG lookup field.</p> <p>This field appears when you select the Account, Customer, Price Assignment Level, Price Item, and Price Item Group options from the Extract Filter list.</p> <p>This field is disabled when you select the Show Price Assignment for Child Entities field check box.</p>	
Show Price Assignment for Child Entities	Used to indicate whether you want to extract the proposed price item price assignment details of the non-root level hierarchy entity.	No
	<p>Note: This field appears when you select the Account, Customer, Price Assignment Level, Price Item, and Price Item Group options from the Extract Filter list.</p>	
Current Approval User ID	Used to extract the details of the proposed price item pricing which is approved by a particular user.	Yes (Conditional)
	<p>Note:</p> <p>The Search (🔍) icon appears corresponding to this field. On clicking the Search icon, the User Search window appears where you can search for the respective root user.</p> <p>This field appears when you select the Additional Filter Criteria option from the Extract Filter list.</p> <p>This field is disabled when you specify the Price Item Manager To Do Role or Price Approval Status.</p>	
Price Item Manager To Do Role	Used to extract the details of the proposed price item pricing which is assigned using a particular price item manager To Do role.	Yes (Conditional)
	<p>Note:</p> <p>This field appears when you select the Additional Filter Criteria option from the Extract Filter list.</p> <p>This field is disabled when you specify the Current Approval User ID or Price Approval Status.</p>	

Field Name	Field Description	Mandatory (Yes or No)
Price Approval Status	Used to extract the details of the proposed price item pricing which are in a particular status. The valid values are: <ul style="list-style-type: none"> • Approved • Approved-Existing • Approved-Recommended • Error • Initial • Unapproved 	Yes (Conditional)
	<p>Note:</p> <p>This field appears when you select the Additional Filter Criteria option from the Extract Filter list.</p> <p>This field is disabled when you specify the Current Approval User ID or Price Item Manager To Do Role.</p>	<p>Note: This field is required while extracting the details of the proposed price item pricing in a particular status.</p>
Person ID	Used to extract the details of the proposed price items pricing of a particular person.	Yes (Conditional)
	<p>Note:</p> <p>The Search (🔍) icon appears corresponding to this field. On clicking the Search icon, the Prospect Person Search window appears where you can search for the respective person.</p> <p>This field appears when you select the Additional Filter Criteria option from the Extract Filter list.</p>	<p>Note: This field is required while extracting the details of the proposed price item pricing of a particular person.</p>
Division	Used to extract the details of the proposed price items pricing from a particular division.	Yes (Conditional)
	<p>Note: This field appears when you select the Customer option from the Extract Filter list.</p>	<p>Note: This field is required while extracting the details of the proposed price item pricing from a particular division.</p>

2. Enter the required details in the **Deal Extraction** screen.
3. Click **Extract**.

The deal is extracted in the pdf or excel format.

Note: You cannot extract a deal which is in the **Discarded** status.

Related Topics

For more information on...	See...
How to search for a deal	Searching for a Deal on page 2773
Deal Dashboard screen	Deal Dashboard on page 2757
Search Deal zone	Search Deal on page 2758
Deal Information screen	Deal Information on page 2815
Deal Approver Dashboard screen	Deal Approver Dashboard on page 3066
Simulation Details zone	Simulation Details on page 2847

Defining a Deal Version

Prerequisites

To define a deal version, you should have:

- Deal for which you want to define a deal version defined in the application

Procedure

To define a deal version:

1. Search for the deal for which you want to define a deal version in the **Deal Dashboard** screen.
2. In the **Search Results** section, click the link in the **Deal Information** column corresponding to the deal for which you want to define a deal version.

The **Deal Information** screen appears.

3. In the **Simulation Details** zone, click the **Create Deal Version** button.

The **Deal Version** screen appears. It contains the following fields:

Field Name	Field Description	Mandatory (Yes or No)
Deal Information	Displays a concatenated string of information about the deal separated by a comma (,) for which you want to define a deal version.	Not applicable
Deal Version Description	Used to specify the description for the deal version	Yes.
Deal Version Creation Method	Used to indicate the method using which you want to create the deal version. The valid values are: <ul style="list-style-type: none"> • Copy From Current Version With Changes - Used to indicate that you want to copy the customer hierarchy and pricing and commitment details from the current deal version to the new deal version. • Fetch Latest Hierarchy - Used to indicate that you want to derive the latest customer hierarchy from the system. 	Yes

Field Name	Field Description	Mandatory (Yes or No)
	<p>Note:</p> <p>In this case, you will have to select the price items, assign the required price lists to the entities, override or edit the required proposed pricing, and add commitments from scratch in the new deal version.</p> <p>Also, the system will include all the prospect persons and accounts associated with the customer in the customer hierarchy of the deal version.</p>	

4. Enter the required details in the **Deal Version** screen.
5. Click **Save**.

The deal version is created and the **Deal Information** screen appears with the details of the deal version updated in the **Deal Information** zone.

Note: Earlier, when any deal version of a deal was in the **Finalized** status and deal was in the **Pending for Approval** or **Approved** status, you were not able to add a new deal version to the deal. Now, in such scenarios, you can add a new deal version to the deal. In addition, after adding a new deal version to the deal, the deal status would be set to the highest deal version status.

Related Topics

For more information on...	See...
How to search for a deal	Searching for a Deal on page 2773
Deal Dashboard screen	Deal Dashboard on page 2757
Search Deal zone	Search Deal on page 2758
Deal Information zone	Deal Information on page 2845

Deal Information - Simulation

The **Deal Information - Simulation** page enables you to execute the pricing analysis against different price points and generate the deal level, division level, and product level financial summary with the optimum profitability. It also allows you to do the following:

- Submit a deal for an approval
- Define multiple deal versions
- Discard deal
- Extract deal information in the pdf or excel format

It contains the following zones:

- [Deal Information](#) on page 2845
- [Simulation Details](#) on page 2847

Note: You can access the **Deal Information - Simulation** page when the deal is in the **Simulated** status.

Related Topics

For more information on...	See...
Deal Information screen	Deal Information on page 2815
How to simulate a deal	Simulating a Deal on page 2861
How to submit a deal for an approval	Submitting a Deal for an Approval on page 2862
How to define a deal version	Defining a Deal Version on page 2874
How to discard a deal	Discarding a Deal on page 2865
How to extract a deal in the pdf or excel format	Extracting a Deal in the PDF or Excel Format on page 2779

Deal Information

The **Deal Information** zone allows you to do the following:

- View the details of the deal
- Associate, disassociate, view, or edit the terms and conditions of the deal
- View and add log entries for the deal or deal version
- View and add adhoc revenue charges for the deal or deal version

Field Name	Field Description
Deal Information	Displays the concatenated string of information about the deal separated by a comma (,).
Division	Indicates the division with which the deal is associated.
Deal Type	Indicates the deal type using which the deal is created in the system.
Review Date	Displays the date which is scheduled for calculating the deal usage as per the commitments made by the customer. Note: This field is populated when the deal has reached the Full Orchestrated status.
Deal Version Information	Displays the concatenated string of information about the deal version separated by a comma (,).
Access Group	Indicates the group of users who can view and edit the details of the entity (i.e. the customer, account, or prospect person) for which the deal is created.
Review Frequency	Indicates the duration for which the deal is monitored to calculate the usage of the deal as per the commitments made by the customer.
Effective Start Date	Displays the date from when the deal is effective for the entity (i.e. the customer, account, or prospect person). Note: This field is populated when the deal has reached the Customer Accepted status.
Deal Description	Displays the description of the deal.
Customer Segment	Displays the business component to which the entity (i.e. the customer, account, or prospect person) belongs.
Creation Date	Displays the date when the deal is created in the system.

Field Name	Field Description
Effective End Date	Displays the date till when the deal is effective for the entity (i.e. the customer, account, or prospect person).
	Note: This field is populated when the deal has reached the Customer Accepted status.
Deal Status	<p>Indicates the current status of the deal. The valid values are:</p> <ul style="list-style-type: none"> • Applied/Processed • Approved • Closed • Customer Accepted • Discarded • Draft • Error • Finalized • Fully Orchestrated • Hierarchy Creation Deferred • Inactive • Partially Orchestrated • Pending for Approval • Pending for Review • Pending Simulation • Pending for Orchestration • Ready for Approval • Rejected • Simulated • Simulation Deferred
Customer Tier	Indicates the customer tier of the customer segment to which the entity (i.e. the customer, account, or prospect person) belongs.
Start Date	Displays the date from when the price list, price assignment, and price item pricing is available for the deal.
Acceptance Date	Displays the date when the customer has reviewed and accepted the deal.
	<p>Note: This field is populated when the deal has reached the Customer Accepted status.</p> <p>If the Deal Status is Rejected then the Acceptance Date specifies the date when the deal is rejected by the customer.</p>
Deal Version Status	Indicates the status of the deal version.

Field Name	Field Description
Deal Currency	Indicates the currency in which the financial summary and profitability is calculated for the deal.
End Date	Displays the date till when the price list and price assignment is available for the deal.
Finalized Date	Displays the date when the deal is finalized in the system.
	Note: This field is populated when the deal has reached the Customer Accepted status.
Simulation Type	Indicates the simulation type using which the financial summary and profitability is calculated for the deal. The valid values are: <ul style="list-style-type: none"> • Account • Customer • Deal
Usage Period	Indicates the period for which you want to aggregate the deal data to determine the scope of the deal. The valid values are: <ul style="list-style-type: none"> • Biannually • Monthly • Quarterly • Yearly
Deal Frequency	Indicates the duration in which you want to simulate the deal for calculating the financial summary and deal profitability. The valid values are: <ul style="list-style-type: none"> • Biannually • Monthly • Quarterly • Yearly

In addition, the **Deal Information** zone contains the following links:

Link Name	Link Description
Deal Terms and Conditions	Used to associate, disassociate, edit, or view the deal terms and conditions. It is also used to add adhoc terms and conditions for the deal.
Deal Log	Used to view the complete trail of actions performed on the deal. It also allows you to manually add a log entry for the deal.
Deal Version Log	Used to view the complete trail of actions performed on the deal version. It also allows you to manually add a log entry for the deal version.
Adhoc Revenue and Cost	Used to add, edit, or view additional charges that are applicable for the deal while deal creation.

Related Topics

For more information on...	See...
How to view the logs of a deal	Viewing the Logs of a Deal on page 3042

For more information on...	See...
How to add a log entry for a deal	Adding a Log Entry for a Deal on page 3043
How to view the logs of a deal version	Viewing the Logs of a Deal Version on page 3045
How to add a log entry for a deal version	Adding a Log Entry for a Deal Version on page 3046
How to add adhoc revenue charges for a deal	Adding Adhoc Revenue and Cost for a Deal on page 3048
How to associate the terms and conditions with a deal	Associating the Terms and Conditions with a Deal on page 3038
How to view the terms and conditions of a deal	Viewing the Terms and Conditions of a Deal on page 3040
How to edit the terms and conditions of a deal	Editing the Terms and Conditions of a Deal on page 3039





Simulation Details



The **Simulation Details** zone allows you to do the following:

- View the deal financial summary
- View the division financial summary
- View the product financial summary
- View the customer hierarchy
- View the assigned price lists of a person or account
- View the proposed price list assignments of a person or account
- View the enrolled products for an account
- View the proposed product enrollments for an account
- View the pricing and commitment details of a person or account
- View the division financial summary in the division currency
- View the product financial summary in the division currency
- View the revenue and cost in the division or account currency

The **Simulation Details** zone contains the following sections:

- **Symbol Legends** - Indicates the symbols used to identify the current status of the deal level, division level, and product level financial summary. It also differentiates the existing, proposed and recommended pricing statistics. It contains the following symbols:

Symbol Name	Symbol Description
 IN APPROVER RANGE	Indicates that the deal level, division level, or product level financial summary is within the limits defined for the user for approval.
 NOT IN APPROVER RANGE	Indicates that the deal level, division level, or product level financial summary is not within the limits defined for the user for approval.
 PROJECTED	Indicates the revenue, cost, and profit generated from the proposed price item pricing and price assignments.
 RECOMMENDED	Indicates the revenue, cost, and profit generated from the recommended price item pricing and price assignments.
 ORIGINAL	Indicates the revenue, cost, and profit generated from the existing price item pricing and price assignments.

Symbol Name	Symbol Description
 APPROVED	Indicates whether the deal level, division level, or product level financial summary is approved or not.
 PENDING FOR APPROVAL	Indicates that the approval for deal level, division level, or product level financial summary is pending.

- **Deal Financial Summary** - Displays the financial summary at the deal level. It contains the following columns:

Column Name	Column Description
Approval Status	Indicates the current approval status of the financial summary at the deal level.
Revenue	Displays the proposed, recommended, and original revenue generated from the price item pricing and price assignments at the deal level. Note: If division level approval is required, then the revenue includes the sum of revenues calculated at each division level.
Cost	Displays the proposed, recommended, and original cost calculated at the deal level. Note: The cost includes the total price item cost and the adhoc cost. If division level approval is required, then the cost includes the sum of costs calculated at each division level.
Profit	Displays the proposed, recommended, and original profit in deal currency generated from the price item pricing and price assignments at the deal level. It is calculated using the following formula: Profit = Revenue – Cost Note: If division level approval is required, then the profit includes the sum of profits calculated at each division level.
Profitability (%)	Displays the proposed, recommended, and original profit created in percentage at the deal level from the price item pricing and price assignments. It is calculated using the following formula: Profitability % = (Revenue – Cost)*100/ Revenue
Profit Variation (%)	Displays the difference of profit in percentage generated from the original and the proposed price item pricing and commitments at the deal level. It is calculated using the following formula: Profit Variation (%) = (Proposed Profit – Original Profit)*100/ Original Profit

Note: The data in the **Deal Financial Summary** sections appears when the deal has reached the **Simulated** status.

- **Division Financial Summary** - Displays the financial summary at the division level. It contains the following columns:

Column Name	Column Description
Division	Indicates the division for which the financial summary is displayed.
Approval Status	Indicates the current approval status of the financial summary at the division level.
Revenue	Displays the proposed, recommended, and original revenue generated from the price item pricing and price assignments at the division level.
Cost	Displays the proposed, recommended, and original cost calculated at the division level.
	Note: The cost includes the total price item cost and the adhoc cost.
Profit	Displays the proposed, recommended, and original profit in deal currency generated from the price item pricing and price assignments at the division level. It is calculated using the following formula: Profit = Revenue – Cost
Profitability (%)	Displays the proposed, recommended, and original profit generated in percentage at the division level from the price item pricing and price assignments. It is calculated using the following formula: Profitability % = (Revenue – Cost)*100/ Revenue
Profit Variation (%)	Displays the difference of profit in percentage generated from the original and the proposed price item pricing and commitments at the division level. It is calculated using the following formula: Profit Variation (%) = (Proposed Profit – Original Profit)*100/ Original Profit

Note:

The **Division Financial Summary** sections appears in the **Simulation Details** zone when the **Division Level Approval Required** field is set to **Yes** in the **Deal Type** used for defining the deal.

The data in the **Division Financial Summary** sections appears when the deal has reached the **Simulated** status.

By default, the division financial summary is displayed in the deal currency. You can view the division financial summary in the division currency by clicking the toggle switch towards **Division Currency** available above the financial summary table.

- **Product Financial Summary** - Displays the financial summary at the product level. It contains the following columns:

Column Name	Column Description
Product	Indicates the product whose financial summary is displayed.
Division	Indicates the division to which the product belongs.
Approval Status	Indicates the current approval status of the financial summary at the product level.
Revenue	Displays the proposed, recommended, and original revenue generated from the product.
Cost	Displays the proposed, recommended, and original cost calculated for the product.

Column Name	Column Description
	Note: The cost includes the total price item cost and the adhoc cost.
Profit	Displays the proposed, recommended, and original profit in deal currency generated from the price item pricing and price assignments at the product level. It is calculated using the following formula: Profit = Revenue – Cost
Profitability (%)	Displays the proposed, recommended, and original profit generated in percentage from the price item pricing and price assignments at the product level . It is calculated using the following formula: Profitability % = (Revenue – Cost)*100/ Revenue
Profit Variation (%)	Displays the difference of profit in percentage generated from the original and the proposed price item pricing and commitments at the product level. It is calculated using the following formula: Profit Variation (%) = (Proposed Profit – Original Profit)*100/ Original Profit

Note:

The **Product Financial Summary** sections appears in the **Simulation Details** zone when the **Product Level Approval Required** field is set to **Yes** in the **Deal Type** used for defining the deal.

The data in the **Product Financial Summary** sections appears when the deal has reached the **Simulated** status.

By default, the product financial summary is displayed in the deal currency. You can view the product financial summary in the division currency by clicking the toggle switch towards **Division Currency** available above the financial summary table.

- **Customer Hierarchy** - Indicates the main customer and its associated accounts as well as the child persons and its accounts that are associated with the main customer. It also enables you to do the following:
 - View and edit the pricing and commitments at the person and account level
 - View the revenue variation from the proposed and original pricing and commitments
 - View the proposed price lists of a person or account
 - Assign proposed price list to a person or account
 - View the enrolled products of an account
 - Enroll accounts for a product
 - View the original price list of a person or account
 - View the original enrolled products for an account
 - View the proposed or the original revenue and cost generated at the person an account level.

The **Customer Hierarchy** section contains the following columns:

Column Name	Column Description
Person Name	Indicates the main customer and its related persons and accounts.
Division	Indicates the division to which the main customer and it related persons and accounts are associated.



Column Name	Column Description
Pricing and Commitments	<p>On clicking the Edit (✎) icon in the Pricing and Commitments column corresponding to a person or account in the hierarchy, the Pricing and Commitments screen appears where you can view and edit the pricing and commitments of the price items for the respective person or account.</p> <p>Note: You cannot edit the pricing or commitments of the price items if the deal has reached the Finalized status.</p>
Status	Indicates the approval status of the price item pricing and price assignments for the respective person or account.
Revenue Variation (%)	<p>Displays the average revenue generated from a customer or account in percentage. It is calculated using the following formula:</p> $\text{Revenue Variation (\%)} = (\text{Proposed Revenue} - \text{Original Revenue}) * 100 / \text{Original Revenue}.$
Price List Assignment	<p>On clicking the Edit (✎) icon in the Price List Assignment column corresponding to a person or account in the hierarchy, the Price List Assignment screen appears where you can view and assign proposed price list to the respective person or account.</p> <p>Note: You cannot assign proposed price list to the person or account if the deal has reached the Finalized status.</p>
Product Enrollment	<p>On clicking the Edit (✎) icon in the Product Enrollment column corresponding to the person or account in the hierarchy, the Product Enrollment screen appears where you can view or enroll the respective account or accounts of the customer for a product. You can also view a list of recommended products for which you want to enroll the account or accounts of the customer. The recommended products appear in the Product Enrollment screen when you add products in the Recommended Products section while defining a deal.</p> <p>Note: You cannot enroll an account for a product if the deal has reached the Finalized status.</p>
Price Item Group Selection	On clicking the Edit (✎) icon in the Price Item Group Selection column corresponding to the main person in the hierarchy, the Select Price Item Group screen appears where you can select and/or deselect the price items and/or hierarchy entities based on which you want to simulate the deal.
Revenue	Indicates the revenue generated by the corresponding person or account in the hierarchy through the proposed price item pricing and commitments.
Cost	<p>Indicates the sum of the proposed costs from all accounts under the customer.</p> <p>Note: If the person is a parent customer, then the sum of the proposed costs of all the child customers is considered.</p>
Pricelist	On clicking the View (📄) icon in the Price List column corresponding to the person or account in the hierarchy, the Price List Assignment screen appears where you can view the original price list assigned to the respective person or account.

Column Name	Column Description
Product	On clicking the Edit (✎) icon in the Product column corresponding to the person or account in the hierarchy, the Product Enrollment screen appears where you can view the products to which the account is already enrolled.
Revenue	Indicates the revenue generated by the corresponding person or account in the hierarchy through the original price item pricing and commitments.
Cost	Indicates the sum of the original costs from all accounts under the customer. Note: If the person is a parent customer, then the sum of the original costs of all the child customers is considered.

Note: The system also considers the prospect persons and prospect accounts associated with the main customer along with the child and grandchild persons and their accounts in the customer hierarchy.

In addition, the **Simulation Details** zone contains the following buttons:

Button Name	Button Description
Deal Pricing and Commitments	Used to define the consolidated pricing and commitments for the customers or accounts in a deal.
Simulate Deal	Used to perform different types of simulation based on the pricing and commitments of the price item to determine the best price that can be offered to the clients as per their requirements.
Check Limits	Used to execute the price item ceil and floor validation for an approver as per the limits set on the price item screen. Note: The Check Limits is run only for the price items which are in the Pending for Approval or Error status after the Pricing Simulation is executed. The Check Limits button is activated when the Price Item Approval Required option is set to Yes in the Deal Type using which the deal is created.
Send Deal for Approval	Used to move the deal from the current role to the next role of the next level in the approval hierarchy for approval. Note: On clicking the Send Deal for Approval button, a To Do notification is created for the users of the next level to indicate that approval of the deal is required. A To Do is also created for the creator (i.e. the Relationship Manager) of the deal to indicate that the ownership of the deal has changed. This button is activated after Pricing Simulation is completed for the deal and if the Approve Deal option is set to Yes for the approver in the Approval Hierarchy of the Deal Approval Profile .
Approve Deal	Used to approve the deal. To approve a deal the following conditions should be met: <ul style="list-style-type: none"> All the price items should be in the Approved status if the Price Item Approval Required option is set to Yes in the Deal Type used for creating the deal.

Button Name	Button Description
	<ul style="list-style-type: none"> All the division level approvals must be completed if the Division Level Approval Required field is set to Yes in the Deal Type used for creating the deal. All the product level approvals must be completed if the Product Level Approval Required field is set to Yes in the Deal Type used for creating the deal. The deal should be in the Ready for Approval status for the approver to initiate the deal approval process. <div style="border: 1px solid black; padding: 5px; margin-top: 10px;"> <p>Note:</p> <p>The Approve Deal button is activated only when the deal is in the Ready for Approval status and the Approve Deal option is set to Yes for the approver in the Approval Hierarchy of the Deal Approval Profile.</p> </div>
Return to Submitter	<p>Used to move the deal from the current role to the previous role of the previous level in the approval hierarchy for approval. It is also used to send the deal to the relationship manager for approval if you have recommended a new pricing for the price item.</p> <div style="border: 1px solid black; padding: 5px; margin-top: 10px;"> <p>Note:</p> <p>On clicking the Return to Submitter button, a To Do notification is created for the users of the previous level to indicate that the deal is returned for approval.</p> <p>A To Do is also created for the creator (i.e. the Relationship Manager) of the deal to indicate that the ownership of the deal has changed.</p> </div>
Finalize Deal	<p>Used to finalize the deal so that it is ready to be presented to the customer for approval.</p> <div style="border: 1px solid black; padding: 5px; margin-top: 10px;"> <p>Note: This button is activated when the deal is in the Approved status.</p> </div> <div style="border: 1px solid black; padding: 5px; margin-top: 10px;"> <p>Tip: You can also finalize a deal by clicking the Finalize () icon in the Finalize Deal column corresponding to the deal in the Search Deal zone of the Deal Dashboard screen.</p> </div>
Accept Deal	<p>Used to accept the deal in the system after receiving confirmation of acceptance from the customer.</p> <div style="border: 1px solid black; padding: 5px; margin-top: 10px;"> <p>Note: This button is activated only when the deal is in the Finalized status.</p> </div> <div style="border: 1px solid black; padding: 5px; margin-top: 10px;"> <p>Tip: You can also accept a deal by clicking the Accept () icon in the Accept Deal column corresponding to the deal in the Search Deal zone of the Deal Dashboard screen.</p> </div>
Reject Deal	<p>Used to reject the deal in the system after receiving confirmation of rejection from the customer.</p> <div style="border: 1px solid black; padding: 5px; margin-top: 10px;"> <p>Note: This button is activated only when the deal is in the Finalized status.</p> </div>

Button Name	Button Description
	Tip: You can also reject a deal by clicking the Reject (✖) icon in the Reject Deal column corresponding to the deal in the Search Deal zone of the Deal Dashboard screen.
Create Deal Version	Used to create a deal version for the existing deal to optimize the deal pricing process and to make better pricing decisions. Note: You can add a new deal version to a deal even if the version of any deal version of a deal is in the Finalized status and the status of the deal is Pending for Approval or Approved .
Discard Deal	Used to discard the deal. Note: You cannot discard a deal if it has reached the Finalized status.
Print Deal	Used to extract relevant information about the deal in the pdf or excel format which is published either to the customer for receiving approvals or for internal reviews and validations.
Apply Back	Used to activate the proposed pricelist assignments, overridden pricing, and product enrollments for the existing customer or account in the system.
Previous	Used to view information about the previous status of the deal.

Related Topics

For more information on...	See...
Search Deal zone	Search Deal on page 2758
Price List Assignment screen	Price List Assignment on page 2979
Product Enrollment screen	Product Enrollment on page 2987
Pricing and Commitments screen	Pricing and Commitments on page 2934
Pricing and Commitments screen	Pricing and Commitments on page 3002
How to view the customer hierarchy of a deal	Viewing the Customer Hierarchy of a Deal on page 2856
How to view the existing price lists of a person or an account	Viewing the Assigned Price Lists of a Person or Account on page 2856
How to view the proposed price lists of a person or an account	Viewing the Proposed Price List Assignments of a Person or Account on page 2857
How to view the existing products enrolled for an account	Viewing the Enrolled Products of an Account on page 2857
How to view the proposed products enrolled for an account	Viewing the Proposed Product Enrollments for an Account on page 2858
How to view the pricing and commitment details of a prospect person	Viewing the Pricing and Commitment Details of a Person on page 2858
How to view the pricing and commitment details of a prospect account	Viewing the Pricing and Commitment Details of an Account on page 2859
How to view the division financial summary in the division currency	Viewing the Division Financial Summary in the Division Currency on page 2859

For more information on...	See...
How to view the product financial summary in the division currency	Viewing the Product Financial Summary in the Division Currency on page 2860
How to view the revenue and cost in the division or account currency	Viewing the Revenue and Cost in the Division or Account Currency on page 2861
How to simulate a deal	Simulating a Deal on page 2861
How to submit a deal for approval	Submitting a Deal for an Approval on page 2862
How to approve a deal	Approving a Deal on page 2862
How to request the submitter to resubmit the deal for approval	Requesting the Submitter to Resubmit the Deal for Approval on page 2863
How to finalize a deal	Finalizing a Deal on page 2775
Hoe to discard a deal	Discarding a Deal on page 2865
How to accept a deal	Accepting a Deal on page 2776
How to reject a deal	Rejecting a Deal on page 2777
How to extract a deal in the pdf or excel format	Extracting a Deal in the PDF or Excel Format on page 2779
How to define a deal version	Defining a Deal Version on page 2874

Deal Information - Approvals

The **Deal Information - Approvals** page enables you to do the following:

- Approve a deal
- Request the submitter to resubmit the deal for approval
- Recommend pricing for a price item
- Finalize deal
- Extract deal in the pdf or excel format

It contains the following zones:

- [Deal Information](#) on page 2845
- [Simulation Details](#) on page 2847

Note: You can access the **Deal Information - Approvals** page when the deal is in the **Pending for Approval** status.

Related Topics

For more information on...	See...
Deal Information screen	Deal Information on page 2815
How to approve a deal	Approving a Deal on page 2862
How to request the submitter to resubmit the deal for approval	Requesting the Submitter to Resubmit the Deal for Approval on page 2863
How to recommend pricing for a price item	Recommending a New Pricing for a Price Item on page 2955
How to finalize a deal	Finalizing a Deal on page 2775

For more information on...	See...
How to extract a deal in the pdf or excel format	Extracting a Deal in the PDF or Excel Format on page 2779

Deal Information

The **Deal Information** zone allows you to do the following:

- View the details of the deal
- Associate, disassociate, view, or edit the terms and conditions of the deal
- View and add log entries for the deal or deal version
- View and add adhoc revenue charges for the deal or deal version

Field Name	Field Description
Deal Information	Displays the concatenated string of information about the deal separated by a comma (,).
Division	Indicates the division with which the deal is associated.
Deal Type	Indicates the deal type using which the deal is created in the system.
Review Date	Displays the date which is scheduled for calculating the deal usage as per the commitments made by the customer. Note: This field is populated when the deal has reached the Full Orchestrated status.
Deal Version Information	Displays the concatenated string of information about the deal version separated by a comma (,).
Access Group	Indicates the group of users who can view and edit the details of the entity (i.e. the customer, account, or prospect person) for which the deal is created.
Review Frequency	Indicates the duration for which the deal is monitored to calculate the usage of the deal as per the commitments made by the customer.
Effective Start Date	Displays the date from when the deal is effective for the entity (i.e. the customer, account, or prospect person). Note: This field is populated when the deal has reached the Customer Accepted status.
Deal Description	Displays the description of the deal.
Customer Segment	Displays the business component to which the entity (i.e. the customer, account, or prospect person) belongs.
Creation Date	Displays the date when the deal is created in the system.
Effective End Date	Displays the date till when the deal is effective for the entity (i.e. the customer, account, or prospect person). Note: This field is populated when the deal has reached the Customer Accepted status.
Deal Status	Indicates the current status of the deal. The valid values are: <ul style="list-style-type: none"> • Applied/Processed

Field Name	Field Description
	<ul style="list-style-type: none"> • Approved • Closed • Customer Accepted • Discarded • Draft • Error • Finalized • Fully Orchestrated • Hierarchy Creation Deferred • Inactive • Partially Orchestrated • Pending for Approval • Pending for Review • Pending Simulation • Pending for Orchestration • Ready for Approval • Rejected • Simulated • Simulation Deferred
Customer Tier	Indicates the customer tier of the customer segment to which the entity (i.e. the customer, account, or prospect person) belongs.
Start Date	Displays the date from when the price list, price assignment, and price item pricing is available for the deal.
Acceptance Date	<p>Displays the date when the customer has reviewed and accepted the deal.</p> <div style="border: 1px solid black; padding: 5px;"> <p>Note: This field is populated when the deal has reached the Customer Accepted status.</p> <p>If the Deal Status is Rejected then the Acceptance Date specifies the date when the deal is rejected by the customer.</p> </div>
Deal Version Status	Indicates the status of the deal version.
Deal Currency	Indicates the currency in which the financial summary and profitability is calculated for the deal.
End Date	Displays the date till when the price list and price assignment is available for the deal.
Finalized Date	<p>Displays the date when the deal is finalized in the system.</p> <div style="border: 1px solid black; padding: 5px;"> <p>Note: This field is populated when the deal has reached the Customer Accepted status.</p> </div>

Field Name	Field Description
Simulation Type	Indicates the simulation type using which the financial summary and profitability is calculated for the deal. The valid values are: <ul style="list-style-type: none"> • Account • Customer • Deal
Usage Period	Indicates the period for which you want to aggregate the deal data to determine the scope of the deal. The valid values are: <ul style="list-style-type: none"> • Biannually • Monthly • Quarterly • Yearly
Deal Frequency	Indicates the duration in which you want to simulate the deal for calculating the financial summary and deal profitability. The valid values are: <ul style="list-style-type: none"> • Biannually • Monthly • Quarterly • Yearly

In addition, the **Deal Information** zone contains the following links:

Link Name	Link Description
Deal Terms and Conditions	Used to associate, disassociate, edit, or view the deal terms and conditions. It is also used to add adhoc terms and conditions for the deal.
Deal Log	Used to view the complete trail of actions performed on the deal. It also allows you to manually add a log entry for the deal.
Deal Version Log	Used to view the complete trail of actions performed on the deal version. It also allows you to manually add a log entry for the deal version.
Adhoc Revenue and Cost	Used to add, edit, or view additional charges that are applicable for the deal while deal creation.

Related Topics

For more information on...	See...
How to view the logs of a deal	Viewing the Logs of a Deal on page 3042
How to add a log entry for a deal	Adding a Log Entry for a Deal on page 3043
How to view the logs of a deal version	Viewing the Logs of a Deal Version on page 3045
How to add a log entry for a deal version	Adding a Log Entry for a Deal Version on page 3046
How to add adhoc revenue charges for a deal	Adding Adhoc Revenue and Cost for a Deal on page 3048
How to associate the terms and conditions with a deal	Associating the Terms and Conditions with a Deal on page 3038

For more information on...	See...
How to view the terms and conditions of a deal	Viewing the Terms and Conditions of a Deal on page 3040
How to edit the terms and conditions of a deal	Editing the Terms and Conditions of a Deal on page 3039







Simulation Details

The **Simulation Details** zone allows you to do the following:

- View the deal financial summary
- View the division financial summary
- View the product financial summary
- View the customer hierarchy
- View the assigned price lists of a person or account
- View the proposed price list assignments of a person or account
- View the enrolled products for an account
- View the proposed product enrollments for an account
- View the pricing and commitment details of a person or account
- View the division financial summary in the division currency
- View the product financial summary in the division currency
- View the revenue and cost in the division or account currency

The **Simulation Details** zone contains the following sections:

- **Symbol Legends** - Indicates the symbols used to identify the current status of the deal level, division level, and product level financial summary. It also differentiates the existing, proposed and recommended pricing statistics. It contains the following symbols:

Symbol Name	Symbol Description
 IN APPROVER RANGE	Indicates that the deal level, division level, or product level financial summary is within the limits defined for the user for approval.
 NOT IN APPROVER RANGE	Indicates that the deal level, division level, or product level financial summary is not within the limits defined for the user for approval.
 PROJECTED	Indicates the revenue, cost, and profit generated from the proposed price item pricing and price assignments.
 RECOMMENDED	Indicates the revenue, cost, and profit generated from the recommended price item pricing and price assignments.
 ORIGINAL	Indicates the revenue, cost, and profit generated from the existing price item pricing and price assignments.
 APPROVED	Indicates whether the deal level, division level, or product level financial summary is approved or not.
 PENDING FOR APPROVAL	Indicates that the approval for deal level, division level, or product level financial summary is pending.

- **Deal Financial Summary** - Displays the financial summary at the deal level. It contains the following columns:

Column Name	Column Description
Approval Status	Indicates the current approval status of the financial summary at the deal level.
Revenue	Displays the proposed, recommended, and original revenue generated from the price item pricing and price assignments at the deal level. Note: If division level approval is required, then the revenue includes the sum of revenues calculated at each division level.
Cost	Displays the proposed, recommended, and original cost calculated at the deal level. Note: The cost includes the total price item cost and the adhoc cost. If division level approval is required, then the cost includes the sum of costs calculated at each division level.
Profit	Displays the proposed, recommended, and original profit in deal currency generated from the price item pricing and price assignments at the deal level. It is calculated using the following formula: Profit = Revenue – Cost Note: If division level approval is required, then the profit includes the sum of profits calculated at each division level.
Profitability (%)	Displays the proposed, recommended, and original profit created in percentage at the deal level from the price item pricing and price assignments. It is calculated using the following formula: Profitability % = (Revenue – Cost)*100/ Revenue
Profit Variation (%)	Displays the difference of profit in percentage generated from the original and the proposed price item pricing and commitments at the deal level. It is calculated using the following formula: Profit Variation (%) = (Proposed Profit – Original Profit)*100/ Original Profit

Note: The data in the **Deal Financial Summary** sections appears when the deal has reached the **Simulated** status.

- **Division Financial Summary** - Displays the financial summary at the division level. It contains the following columns:

Column Name	Column Description
Division	Indicates the division for which the financial summary is displayed.
Approval Status	Indicates the current approval status of the financial summary at the division level.
Revenue	Displays the proposed, recommended, and original revenue generated from the price item pricing and price assignments at the division level.

Column Name	Column Description
Cost	Displays the proposed, recommended, and original cost calculated at the division level.
	Note: The cost includes the total price item cost and the adhoc cost.
Profit	Displays the proposed, recommended, and original profit in deal currency generated from the price item pricing and price assignments at the division level. It is calculated using the following formula: Profit = Revenue – Cost
Profitability (%)	Displays the proposed, recommended, and original profit generated in percentage at the division level from the price item pricing and price assignments. It is calculated using the following formula: Profitability % = (Revenue – Cost)*100/ Revenue
Profit Variation (%)	Displays the difference of profit in percentage generated from the original and the proposed price item pricing and commitments at the division level. It is calculated using the following formula: Profit Variation (%) = (Proposed Profit – Original Profit)*100/ Original Profit

Note:

The **Division Financial Summary** sections appears in the **Simulation Details** zone when the **Division Level Approval Required** field is set to **Yes** in the **Deal Type** used for defining the deal.

The data in the **Division Financial Summary** sections appears when the deal has reached the **Simulated** status.

By default, the division financial summary is displayed in the deal currency. You can view the division financial summary in the division currency by clicking the toggle switch towards **Division Currency** available above the financial summary table.

- **Product Financial Summary** - Displays the financial summary at the product level. It contains the following columns:

Column Name	Column Description
Product	Indicates the product whose financial summary is displayed.
Division	Indicates the division to which the product belongs.
Approval Status	Indicates the current approval status of the financial summary at the product level.
Revenue	Displays the proposed, recommended, and original revenue generated from the product.
Cost	Displays the proposed, recommended, and original cost calculated for the product.
	Note: The cost includes the total price item cost and the adhoc cost.
Profit	Displays the proposed, recommended, and original profit in deal currency generated from the price item pricing and price assignments at the product level. It is calculated using the following formula: Profit = Revenue – Cost

Column Name	Column Description
Profitability (%)	Displays the proposed, recommended, and original profit generated in percentage from the price item pricing and price assignments at the product level . It is calculated using the following formula: Profitability % = (Revenue – Cost)*100/ Revenue
Profit Variation (%)	Displays the difference of profit in percentage generated from the original and the proposed price item pricing and commitments at the product level. It is calculated using the following formula: Profit Variation (%) = (Proposed Profit – Original Profit)*100/ Original Profit

Note:

The **Product Financial Summary** sections appears in the **Simulation Details** zone when the **Product Level Approval Required** field is set to **Yes** in the **Deal Type** used for defining the deal.

The data in the **Product Financial Summary** sections appears when the deal has reached the **Simulated** status.

By default, the product financial summary is displayed in the deal currency. You can view the product financial summary in the division currency by clicking the toggle switch towards **Division Currency** available above the financial summary table.

- **Customer Hierarchy** - Indicates the main customer and its associated accounts as well as the child persons and its accounts that are associated with the main customer. It also enables you to do the following:
 - View and edit the pricing and commitments at the person and account level
 - View the revenue variation from the proposed and original pricing and commitments
 - View the proposed price lists of a person or account
 - Assign proposed price list to a person or account
 - View the enrolled products of an account
 - Enroll accounts for a product
 - View the original price list of a person or account
 - View the original enrolled products for an account
 - View the proposed or the original revenue and cost generated at the person an account level.

The **Customer Hierarchy** section contains the following columns:

Column Name	Column Description
Person Name	Indicates the main customer and its related persons and accounts.
Division	Indicates the division to which the main customer and it related persons and accounts are associated.
Pricing and Commitments	On clicking the Edit (✎) icon in the Pricing and Commitments column corresponding to a person or account in the hierarchy, the Pricing and Commitments screen appears where you can view and edit the pricing and commitments of the price items for the respective person or account. Note: You cannot edit the pricing or commitments of the price items if the deal has reached the Finalized status.



Column Name	Column Description
Status	Indicates the approval status of the price item pricing and price assignments for the respective person or account.
Revenue Variation (%)	Displays the average revenue generated from a customer or account in percentage. It is calculated using the following formula: Revenue Variation (%) = (Proposed Revenue – Original Revenue)*100/Original Revenue.
Price List Assignment	On clicking the Edit (✎) icon in the Price List Assignment column corresponding to a person or account in the hierarchy, the Price List Assignment screen appears where you can view and assign proposed price list to the respective person or account. Note: You cannot assign proposed price list to the person or account if the deal has reached the Finalized status.
Product Enrollment	On clicking the Edit (✎) icon in the Product Enrollment column corresponding to the person or account in the hierarchy, the Product Enrollment screen appears where you can view or enroll the respective account or accounts of the customer for a product. You can also view a list of recommended products for which you want to enroll the account or accounts of the customer. The recommended products appear in the Product Enrollment screen when you add products in the Recommended Products section while defining a deal. Note: You cannot enroll an account for a product if the deal has reached the Finalized status.
Price Item Group Selection	On clicking the Edit (✎) icon in the Price Item Group Selection column corresponding to the main person in the hierarchy, the Select Price Item Group screen appears where you can select and/or deselect the price items and/or hierarchy entities based on which you want to simulate the deal.
Revenue	Indicates the revenue generated by the corresponding person or account in the hierarchy through the proposed price item pricing and commitments.
Cost	Indicates the sum of the proposed costs from all accounts under the customer. Note: If the person is a parent customer, then the sum of the proposed costs of all the child customers is considered.
Pricelist	On clicking the View (📄) icon in the Price List column corresponding to the person or account in the hierarchy, the Price List Assignment screen appears where you can view the original price list assigned to the respective person or account.
Product	On clicking the Edit (✎) icon in the Product column corresponding to the person or account in the hierarchy, the Product Enrollment screen appears where you can view the products to which the account is already enrolled.
Revenue	Indicates the revenue generated by the corresponding person or account in the hierarchy through the original price item pricing and commitments.
Cost	Indicates the sum of the original costs from all accounts under the customer.

Column Name	Column Description
	Note: If the person is a parent customer, then the sum of the original costs of all the child customers is considered.

Note: The system also considers the prospect persons and prospect accounts associated with the main customer along with the child and grandchild persons and their accounts in the customer hierarchy.

In addition, the **Simulation Details** zone contains the following buttons:

Button Name	Button Description
Deal Pricing and Commitments	Used to define the consolidated pricing and commitments for the customers or accounts in a deal.
Simulate Deal	Used to perform different types of simulation based on the pricing and commitments of the price item to determine the best price that can be offered to the clients as per their requirements.
Check Limits	Used to execute the price item ceil and floor validation for an approver as per the limits set on the price item screen. Note: The Check Limits is run only for the price items which are in the Pending for Approval or Error status after the Pricing Simulation is executed. The Check Limits button is activated when the Price Item Approval Required option is set to Yes in the Deal Type using which the deal is created.
Send Deal for Approval	Used to move the deal from the current role to the next role of the next level in the approval hierarchy for approval. Note: On clicking the Send Deal for Approval button, a To Do notification is created for the users of the next level to indicate that approval of the deal is required. A To Do is also created for the creator (i.e. the Relationship Manager) of the deal to indicate that the ownership of the deal has changed. This button is activated after Pricing Simulation is completed for the deal and if the Approve Deal option is set to Yes for the approver in the Approval Hierarchy of the Deal Approval Profile .
Approve Deal	Used to approve the deal. To approve a deal the following conditions should be met: <ul style="list-style-type: none"> • All the price items should be in the Approved status if the Price Item Approval Required option is set to Yes in the Deal Type used for creating the deal. • All the division level approvals must be completed if the Division Level Approval Required field is set to Yes in the Deal Type used for creating the deal. • All the product level approvals must be completed if the Product Level Approval Required field is set to Yes in the Deal Type used for creating the deal.

Button Name	Button Description
	<ul style="list-style-type: none"> The deal should be in the Ready for Approval status for the approver to initiate the deal approval process. <div style="border: 1px solid black; padding: 5px; margin-top: 10px;"> <p>Note:</p> <p>The Approve Deal button is activated only when the deal is in the Ready for Approval status and the Approve Deal option is set to Yes for the approver in the Approval Hierarchy of the Deal Approval Profile.</p> </div>
Return to Submitter	<p>Used to move the deal from the current role to the previous role of the previous level in the approval hierarchy for approval. It is also used to send the deal to the relationship manager for approval if you have recommended a new pricing for the price item.</p> <div style="border: 1px solid black; padding: 5px; margin-top: 10px;"> <p>Note:</p> <p>On clicking the Return to Submitter button, a To Do notification is created for the users of the previous level to indicate that the deal is returned for approval.</p> <p>A To Do is also created for the creator (i.e. the Relationship Manager) of the deal to indicate that the ownership of the deal has changed.</p> </div>
Finalize Deal	<p>Used to finalize the deal so that it is ready to be presented to the customer for approval.</p> <div style="border: 1px solid black; padding: 5px; margin-top: 10px;"> <p>Note: This button is activated when the deal is in the Approved status.</p> </div> <div style="border: 1px solid black; padding: 5px; margin-top: 10px;"> <p>Tip: You can also finalize a deal by clicking the Finalize () icon in the Finalize Deal column corresponding to the deal in the Search Deal zone of the Deal Dashboard screen.</p> </div>
Accept Deal	<p>Used to accept the deal in the system after receiving confirmation of acceptance from the customer.</p> <div style="border: 1px solid black; padding: 5px; margin-top: 10px;"> <p>Note: This button is activated only when the deal is in the Finalized status.</p> </div> <div style="border: 1px solid black; padding: 5px; margin-top: 10px;"> <p>Tip: You can also accept a deal by clicking the Accept () icon in the Accept Deal column corresponding to the deal in the Search Deal zone of the Deal Dashboard screen.</p> </div>
Reject Deal	<p>Used to reject the deal in the system after receiving confirmation of rejection from the customer.</p> <div style="border: 1px solid black; padding: 5px; margin-top: 10px;"> <p>Note: This button is activated only when the deal is in the Finalized status.</p> </div> <div style="border: 1px solid black; padding: 5px; margin-top: 10px;"> <p>Tip: You can also reject a deal by clicking the Reject () icon in the Reject Deal column corresponding to the deal in the Search Deal zone of the Deal Dashboard screen.</p> </div>
Create Deal Version	<p>Used to create a deal version for the existing deal to optimize the deal pricing process and to make better pricing decisions.</p>

Button Name	Button Description
	Note: You can add a new deal version to a deal even if the version of any deal version of a deal is in the Finalized status and the status of the deal is Pending for Approval or Approved .
Discard Deal	Used to discard the deal. Note: You cannot discard a deal if it has reached the Finalized status.
Print Deal	Used to extract relevant information about the deal in the pdf or excel format which is published either to the customer for receiving approvals or for internal reviews and validations.
Apply Back	Used to activate the proposed pricelist assignments, overridden pricing, and product enrollments for the existing customer or account in the system.
Previous	Used to view information about the previous status of the deal.

Related Topics

For more information on...	See...
Search Deal zone	Search Deal on page 2758
Price List Assignment screen	Price List Assignment on page 2979
Product Enrollment screen	Product Enrollment on page 2987
Pricing and Commitments screen	Pricing and Commitments on page 2934
Pricing and Commitments screen	Pricing and Commitments on page 3002
How to view the customer hierarchy of a deal	Viewing the Customer Hierarchy of a Deal on page 2856
How to view the existing price lists of a person or an account	Viewing the Assigned Price Lists of a Person or Account on page 2856
How to view the proposed price lists of a person or an account	Viewing the Proposed Price List Assignments of a Person or Account on page 2857
How to view the existing products enrolled for an account	Viewing the Enrolled Products of an Account on page 2857
How to view the proposed products enrolled for an account	Viewing the Proposed Product Enrollments for an Account on page 2858
How to view the pricing and commitment details of a prospect person	Viewing the Pricing and Commitment Details of a Person on page 2858
How to view the pricing and commitment details of a prospect account	Viewing the Pricing and Commitment Details of an Account on page 2859
How to view the division financial summary in the division currency	Viewing the Division Financial Summary in the Division Currency on page 2859
How to view the product financial summary in the division currency	Viewing the Product Financial Summary in the Division Currency on page 2860
How to view the revenue and cost in the division or account currency	Viewing the Revenue and Cost in the Division or Account Currency on page 2861
How to simulate a deal	Simulating a Deal on page 2861

For more information on...	See...
How to submit a deal for approval	Submitting a Deal for an Approval on page 2862
How to approve a deal	Approving a Deal on page 2862
How to request the submitter to resubmit the deal for approval	Requesting the Submitter to Resubmit the Deal for Approval on page 2863
How to finalize a deal	Finalizing a Deal on page 2775
How to discard a deal	Discarding a Deal on page 2865
How to accept a deal	Accepting a Deal on page 2776
How to reject a deal	Rejecting a Deal on page 2777
How to extract a deal in the pdf or excel format	Extracting a Deal in the PDF or Excel Format on page 2779
How to define a deal version	Defining a Deal Version on page 2874

Deal Information - Acceptance/Rejection

The **Deal Information - Acceptance/Rejection** page enables you to either accept or reject a finalized deal based on the customer feedback. It also enables you to fully orchestrate the customer accepted deal. You can also extract the deal information in the pdf of excel format. It contains the following zones:

- [Deal Information](#) on page 2845

The following fields in the **Deal Information** zone are updated when the deal or deal version has been accepted or rejected by the customer:

Field Name	Field Description
Effective Start Date	Displays the date from when the deal is effective for the customer or prospect. Note: The effective date specified for the proposed price list pricing and price assignment is considered as the Effective Start Date for the deal. Also, the end date for the existing price list pricing and price assignment is calculated by the below formula: End Date = Effective Start Date of the deal - 1 day.
Effective End Date	Displays the date till when the deal is effective for the customer or prospect.
Acceptance Date	Displays the date when the customer or prospect has accepted the deal. Note: If the Deal Status is Rejected then the Acceptance Date specifies the date when the deal is rejected by the customer.
Finalized Date	Displays the date when the deal has been finalized in the system.

- [Simulation Details](#) on page 2847

Note: You can access the **Deal Information - Acceptance/Rejection** page when the deal is in the **Finalized** or **Customer Accepted** status.

Related Topics

For more information on...	See...
Deal Information screen	Deal Information on page 2815
How to accept a deal	Accepting a Deal on page 2776
How to reject a deal	Rejecting a Deal on page 2777
How to orchestrate a deal	Orchestrating a Deal on page 2778
How to extract a deal in the pdf or excel format	Extracting a Deal in the PDF or Excel Format on page 2779

Deal Information

The **Deal Information** zone allows you to do the following:

- View the details of the deal
- Associate, disassociate, view, or edit the terms and conditions of the deal
- View and add log entries for the deal or deal version
- View and add adhoc revenue charges for the deal or deal version

Field Name	Field Description
Deal Information	Displays the concatenated string of information about the deal separated by a comma (,).
Division	Indicates the division with which the deal is associated.
Deal Type	Indicates the deal type using which the deal is created in the system.
Review Date	Displays the date which is scheduled for calculating the deal usage as per the commitments made by the customer. Note: This field is populated when the deal has reached the Full Orchestrated status.
Deal Version Information	Displays the concatenated string of information about the deal version separated by a comma (,).
Access Group	Indicates the group of users who can view and edit the details of the entity (i.e. the customer, account, or prospect person) for which the deal is created.
Review Frequency	Indicates the duration for which the deal is monitored to calculate the usage of the deal as per the commitments made by the customer.
Effective Start Date	Displays the date from when the deal is effective for the entity (i.e. the customer, account, or prospect person). Note: This field is populated when the deal has reached the Customer Accepted status.
Deal Description	Displays the description of the deal.
Customer Segment	Displays the business component to which the entity (i.e. the customer, account, or prospect person) belongs.
Creation Date	Displays the date when the deal is created in the system.
Effective End Date	Displays the date till when the deal is effective for the entity (i.e. the customer, account, or prospect person).

Field Name	Field Description
	<p>Note: This field is populated when the deal has reached the Customer Accepted status.</p>
Deal Status	<p>Indicates the current status of the deal. The valid values are:</p> <ul style="list-style-type: none"> • Applied/Processed • Approved • Closed • Customer Accepted • Discarded • Draft • Error • Finalized • Fully Orchestrated • Hierarchy Creation Deferred • Inactive • Partially Orchestrated • Pending for Approval • Pending for Review • Pending Simulation • Pending for Orchestration • Ready for Approval • Rejected • Simulated • Simulation Deferred
Customer Tier	Indicates the customer tier of the customer segment to which the entity (i.e. the customer, account, or prospect person) belongs.
Start Date	Displays the date from when the price list, price assignment, and price item pricing is available for the deal.
Acceptance Date	<p>Displays the date when the customer has reviewed and accepted the deal.</p> <p>Note: This field is populated when the deal has reached the Customer Accepted status.</p> <p>If the Deal Status is Rejected then the Acceptance Date specifies the date when the deal is rejected by the customer.</p>
Deal Version Status	Indicates the status of the deal version.
Deal Currency	Indicates the currency in which the financial summary and profitability is calculated for the deal.

Field Name	Field Description
End Date	Displays the date till when the price list and price assignment is available for the deal.
Finalized Date	Displays the date when the deal is finalized in the system.
	Note: This field is populated when the deal has reached the Customer Accepted status.
Simulation Type	Indicates the simulation type using which the financial summary and profitability is calculated for the deal. The valid values are: <ul style="list-style-type: none"> • Account • Customer • Deal
Usage Period	Indicates the period for which you want to aggregate the deal data to determine the scope of the deal. The valid values are: <ul style="list-style-type: none"> • Biannually • Monthly • Quarterly • Yearly
Deal Frequency	Indicates the duration in which you want to simulate the deal for calculating the financial summary and deal profitability. The valid values are: <ul style="list-style-type: none"> • Biannually • Monthly • Quarterly • Yearly

In addition, the **Deal Information** zone contains the following links:

Link Name	Link Description
Deal Terms and Conditions	Used to associate, disassociate, edit, or view the deal terms and conditions. It is also used to add adhoc terms and conditions for the deal.
Deal Log	Used to view the complete trail of actions performed on the deal. It also allows you to manually add a log entry for the deal.
Deal Version Log	Used to view the complete trail of actions performed on the deal version. It also allows you to manually add a log entry for the deal version.
Adhoc Revenue and Cost	Used to add, edit, or view additional charges that are applicable for the deal while deal creation.

Related Topics

For more information on...	See...
How to view the logs of a deal	Viewing the Logs of a Deal on page 3042
How to add a log entry for a deal	Adding a Log Entry for a Deal on page 3043

For more information on...	See...
How to view the logs of a deal version	Viewing the Logs of a Deal Version on page 3045
How to add a log entry for a deal version	Adding a Log Entry for a Deal Version on page 3046
How to add adhoc revenue charges for a deal	Adding Adhoc Revenue and Cost for a Deal on page 3048
How to associate the terms and conditions with a deal	Associating the Terms and Conditions with a Deal on page 3038
How to view the terms and conditions of a deal	Viewing the Terms and Conditions of a Deal on page 3040
How to edit the terms and conditions of a deal	Editing the Terms and Conditions of a Deal on page 3039







Simulation Details

The **Simulation Details** zone allows you to do the following:

- View the deal financial summary
- View the division financial summary
- View the product financial summary
- View the customer hierarchy
- View the assigned price lists of a person or account
- View the proposed price list assignments of a person or account
- View the enrolled products for an account
- View the proposed product enrollments for an account
- View the pricing and commitment details of a person or account
- View the division financial summary in the division currency
- View the product financial summary in the division currency
- View the revenue and cost in the division or account currency

The **Simulation Details** zone contains the following sections:

- **Symbol Legends** - Indicates the symbols used to identify the current status of the deal level, division level, and product level financial summary. It also differentiates the existing, proposed and recommended pricing statistics. It contains the following symbols:

Symbol Name	Symbol Description
 IN APPROVER RANGE	Indicates that the deal level, division level, or product level financial summary is within the limits defined for the user for approval.
 NOT IN APPROVER RANGE	Indicates that the deal level, division level, or product level financial summary is not within the limits defined for the user for approval.
 PROJECTED	Indicates the revenue, cost, and profit generated from the proposed price item pricing and price assignments.
 RECOMMENDED	Indicates the revenue, cost, and profit generated from the recommended price item pricing and price assignments.
 ORIGINAL	Indicates the revenue, cost, and profit generated from the existing price item pricing and price assignments.
 APPROVED	Indicates whether the deal level, division level, or product level financial summary is approved or not.

Symbol Name	Symbol Description
 PENDING FOR APPROVAL	Indicates that the approval for deal level, division level, or product level financial summary is pending.

- **Deal Financial Summary** - Displays the financial summary at the deal level. It contains the following columns:

Column Name	Column Description
Approval Status	Indicates the current approval status of the financial summary at the deal level.
Revenue	Displays the proposed, recommended, and original revenue generated from the price item pricing and price assignments at the deal level. Note: If division level approval is required, then the revenue includes the sum of revenues calculated at each division level.
Cost	Displays the proposed, recommended, and original cost calculated at the deal level. Note: The cost includes the total price item cost and the adhoc cost. If division level approval is required, then the cost includes the sum of costs calculated at each division level.
Profit	Displays the proposed, recommended, and original profit in deal currency generated from the price item pricing and price assignments at the deal level. It is calculated using the following formula: Profit = Revenue – Cost Note: If division level approval is required, then the profit includes the sum of profits calculated at each division level.
Profitability (%)	Displays the proposed, recommended, and original profit created in percentage at the deal level from the price item pricing and price assignments. It is calculated using the following formula: Profitability % = (Revenue – Cost)*100/ Revenue
Profit Variation (%)	Displays the difference of profit in percentage generated from the original and the proposed price item pricing and commitments at the deal level. It is calculated using the following formula: Profit Variation (%) = (Proposed Profit – Original Profit)*100/ Original Profit

Note: The data in the **Deal Financial Summary** sections appears when the deal has reached the **Simulated** status.

- **Division Financial Summary** - Displays the financial summary at the division level. It contains the following columns:

Column Name	Column Description
Division	Indicates the division for which the financial summary is displayed.

Column Name	Column Description
Approval Status	Indicates the current approval status of the financial summary at the division level.
Revenue	Displays the proposed, recommended, and original revenue generated from the price item pricing and price assignments at the division level.
Cost	Displays the proposed, recommended, and original cost calculated at the division level.
	Note: The cost includes the total price item cost and the adhoc cost.
Profit	Displays the proposed, recommended, and original profit in deal currency generated from the price item pricing and price assignments at the division level. It is calculated using the following formula: Profit = Revenue – Cost
Profitability (%)	Displays the proposed, recommended, and original profit generated in percentage at the division level from the price item pricing and price assignments. It is calculated using the following formula: Profitability % = (Revenue – Cost)*100/ Revenue
Profit Variation (%)	Displays the difference of profit in percentage generated from the original and the proposed price item pricing and commitments at the division level. It is calculated using the following formula: Profit Variation (%) = (Proposed Profit – Original Profit)*100/ Original Profit

Note:

The **Division Financial Summary** sections appears in the **Simulation Details** zone when the **Division Level Approval Required** field is set to **Yes** in the **Deal Type** used for defining the deal.

The data in the **Division Financial Summary** sections appears when the deal has reached the **Simulated** status.

By default, the division financial summary is displayed in the deal currency. You can view the division financial summary in the division currency by clicking the toggle switch towards **Division Currency** available above the financial summary table.

- **Product Financial Summary** - Displays the financial summary at the product level. It contains the following columns:

Column Name	Column Description
Product	Indicates the product whose financial summary is displayed.
Division	Indicates the division to which the product belongs.
Approval Status	Indicates the current approval status of the financial summary at the product level.
Revenue	Displays the proposed, recommended, and original revenue generated from the product.
Cost	Displays the proposed, recommended, and original cost calculated for the product.
	Note: The cost includes the total price item cost and the adhoc cost.

Column Name	Column Description
Profit	Displays the proposed, recommended, and original profit in deal currency generated from the price item pricing and price assignments at the product level. It is calculated using the following formula: Profit = Revenue – Cost
Profitability (%)	Displays the proposed, recommended, and original profit generated in percentage from the price item pricing and price assignments at the product level . It is calculated using the following formula: Profitability % = (Revenue – Cost)*100/ Revenue
Profit Variation (%)	Displays the difference of profit in percentage generated from the original and the proposed price item pricing and commitments at the product level. It is calculated using the following formula: Profit Variation (%) = (Proposed Profit – Original Profit)*100/ Original Profit

Note:

The **Product Financial Summary** sections appears in the **Simulation Details** zone when the **Product Level Approval Required** field is set to **Yes** in the **Deal Type** used for defining the deal.

The data in the **Product Financial Summary** sections appears when the deal has reached the **Simulated** status.

By default, the product financial summary is displayed in the deal currency. You can view the product financial summary in the division currency by clicking the toggle switch towards **Division Currency** available above the financial summary table.

- **Customer Hierarchy** - Indicates the main customer and its associated accounts as well as the child persons and its accounts that are associated with the main customer. It also enables you to do the following:
 - View and edit the pricing and commitments at the person and account level
 - View the revenue variation from the proposed and original pricing and commitments
 - View the proposed price lists of a person or account
 - Assign proposed price list to a person or account
 - View the enrolled products of an account
 - Enroll accounts for a product
 - View the original price list of a person or account
 - View the original enrolled products for an account
 - View the proposed or the original revenue and cost generated at the person an account level.

The **Customer Hierarchy** section contains the following columns:

Column Name	Column Description
Person Name	Indicates the main customer and its related persons and accounts.
Division	Indicates the division to which the main customer and it related persons and accounts are associated.
Pricing and Commitments	On clicking the Edit  icon in the Pricing and Commitments column corresponding to a person or account in the hierarchy, the Pricing and Commitments screen appears where you can view and edit the pricing and commitments of the price items for the respective person or account.



Column Name	Column Description
	Note: You cannot edit the pricing or commitments of the price items if the deal has reached the Finalized status.
Status	Indicates the approval status of the price item pricing and price assignments for the respective person or account.
Revenue Variation (%)	Displays the average revenue generated from a customer or account in percentage. It is calculated using the following formula: Revenue Variation (%) = (Proposed Revenue – Original Revenue)*100/Original Revenue.
Price List Assignment	On clicking the Edit (✎) icon in the Price List Assignment column corresponding to a person or account in the hierarchy, the Price List Assignment screen appears where you can view and assign proposed price list to the respective person or account. Note: You cannot assign proposed price list to the person or account if the deal has reached the Finalized status.
Product Enrollment	On clicking the Edit (✎) icon in the Product Enrollment column corresponding to the person or account in the hierarchy, the Product Enrollment screen appears where you can view or enroll the respective account or accounts of the customer for a product. You can also view a list of recommended products for which you want to enroll the account or accounts of the customer. The recommended products appear in the Product Enrollment screen when you add products in the Recommended Products section while defining a deal. Note: You cannot enroll an account for a product if the deal has reached the Finalized status.
Price Item Group Selection	On clicking the Edit (✎) icon in the Price Item Group Selection column corresponding to the main person in the hierarchy, the Select Price Item Group screen appears where you can select and/or deselect the price items and/or hierarchy entities based on which you want to simulate the deal.
Revenue	Indicates the revenue generated by the corresponding person or account in the hierarchy through the proposed price item pricing and commitments.
Cost	Indicates the sum of the proposed costs from all accounts under the customer. Note: If the person is a parent customer, then the sum of the proposed costs of all the child customers is considered.
Pricelist	On clicking the View (📄) icon in the Price List column corresponding to the person or account in the hierarchy, the Price List Assignment screen appears where you can view the original price list assigned to the respective person or account.
Product	On clicking the Edit (✎) icon in the Product column corresponding to the person or account in the hierarchy, the Product Enrollment screen appears where you can view the products to which the account is already enrolled.

Column Name	Column Description
Revenue	Indicates the revenue generated by the corresponding person or account in the hierarchy through the original price item pricing and commitments.
Cost	Indicates the sum of the original costs from all accounts under the customer. Note: If the person is a parent customer, then the sum of the original costs of all the child customers is considered.

Note: The system also considers the prospect persons and prospect accounts associated with the main customer along with the child and grandchild persons and their accounts in the customer hierarchy.

In addition, the **Simulation Details** zone contains the following buttons:

Button Name	Button Description
Deal Pricing and Commitments	Used to define the consolidated pricing and commitments for the customers or accounts in a deal.
Simulate Deal	Used to perform different types of simulation based on the pricing and commitments of the price item to determine the best price that can be offered to the clients as per their requirements.
Check Limits	Used to execute the price item ceil and floor validation for an approver as per the limits set on the price item screen. Note: The Check Limits is run only for the price items which are in the Pending for Approval or Error status after the Pricing Simulation is executed. The Check Limits button is activated when the Price Item Approval Required option is set to Yes in the Deal Type using which the deal is created.
Send Deal for Approval	Used to move the deal from the current role to the next role of the next level in the approval hierarchy for approval. Note: On clicking the Send Deal for Approval button, a To Do notification is created for the users of the next level to indicate that approval of the deal is required. A To Do is also created for the creator (i.e. the Relationship Manager) of the deal to indicate that the ownership of the deal has changed. This button is activated after Pricing Simulation is completed for the deal and if the Approve Deal option is set to Yes for the approver in the Approval Hierarchy of the Deal Approval Profile .
Approve Deal	Used to approve the deal. To approve a deal the following conditions should be met: <ul style="list-style-type: none"> All the price items should be in the Approved status if the Price Item Approval Required option is set to Yes in the Deal Type used for creating the deal. All the division level approvals must be completed if the Division Level Approval Required field is set to Yes in the Deal Type used for creating the deal.

Button Name	Button Description
	<ul style="list-style-type: none"> All the product level approvals must be completed if the Product Level Approval Required field is set to Yes in the Deal Type used for creating the deal. The deal should be in the Ready for Approval status for the approver to initiate the deal approval process. <div style="border: 1px solid black; padding: 5px; margin-top: 10px;"> <p>Note:</p> <p>The Approve Deal button is activated only when the deal is in the Ready for Approval status and the Approve Deal option is set to Yes for the approver in the Approval Hierarchy of the Deal Approval Profile.</p> </div>
Return to Submitter	<p>Used to move the deal from the current role to the previous role of the previous level in the approval hierarchy for approval. It is also used to send the deal to the relationship manager for approval if you have recommended a new pricing for the price item.</p> <div style="border: 1px solid black; padding: 5px; margin-top: 10px;"> <p>Note:</p> <p>On clicking the Return to Submitter button, a To Do notification is created for the users of the previous level to indicate that the deal is returned for approval.</p> <p>A To Do is also created for the creator (i.e. the Relationship Manager) of the deal to indicate that the ownership of the deal has changed.</p> </div>
Finalize Deal	<p>Used to finalize the deal so that it is ready to be presented to the customer for approval.</p> <div style="border: 1px solid black; padding: 5px; margin-top: 10px;"> <p>Note: This button is activated when the deal is in the Approved status.</p> </div> <div style="border: 1px solid black; padding: 5px; margin-top: 10px;"> <p>Tip: You can also finalize a deal by clicking the Finalize () icon in the Finalize Deal column corresponding to the deal in the Search Deal zone of the Deal Dashboard screen.</p> </div>
Accept Deal	<p>Used to accept the deal in the system after receiving confirmation of acceptance from the customer.</p> <div style="border: 1px solid black; padding: 5px; margin-top: 10px;"> <p>Note: This button is activated only when the deal is in the Finalized status.</p> </div> <div style="border: 1px solid black; padding: 5px; margin-top: 10px;"> <p>Tip: You can also accept a deal by clicking the Accept () icon in the Accept Deal column corresponding to the deal in the Search Deal zone of the Deal Dashboard screen.</p> </div>
Reject Deal	<p>Used to reject the deal in the system after receiving confirmation of rejection from the customer.</p> <div style="border: 1px solid black; padding: 5px; margin-top: 10px;"> <p>Note: This button is activated only when the deal is in the Finalized status.</p> </div> <div style="border: 1px solid black; padding: 5px; margin-top: 10px;"> <p>Tip: You can also reject a deal by clicking the Reject () icon in the Reject Deal column corresponding to the deal in the Search Deal zone of the Deal Dashboard screen.</p> </div>

Button Name	Button Description
Create Deal Version	Used to create a deal version for the existing deal to optimize the deal pricing process and to make better pricing decisions. Note: You can add a new deal version to a deal even if the version of any deal version of a deal is in the Finalized status and the status of the deal is Pending for Approval or Approved .
Discard Deal	Used to discard the deal. Note: You cannot discard a deal if it has reached the Finalized status.
Print Deal	Used to extract relevant information about the deal in the pdf or excel format which is published either to the customer for receiving approvals or for internal reviews and validations.
Apply Back	Used to activate the proposed pricelist assignments, overridden pricing, and product enrollments for the existing customer or account in the system.
Previous	Used to view information about the previous status of the deal.

Related Topics

For more information on...	See...
Search Deal zone	Search Deal on page 2758
Price List Assignment screen	Price List Assignment on page 2979
Product Enrollment screen	Product Enrollment on page 2987
Pricing and Commitments screen	Pricing and Commitments on page 2934
Pricing and Commitments screen	Pricing and Commitments on page 3002
How to view the customer hierarchy of a deal	Viewing the Customer Hierarchy of a Deal on page 2856
How to view the existing price lists of a person or an account	Viewing the Assigned Price Lists of a Person or Account on page 2856
How to view the proposed price lists of a person or an account	Viewing the Proposed Price List Assignments of a Person or Account on page 2857
How to view the existing products enrolled for an account	Viewing the Enrolled Products of an Account on page 2857
How to view the proposed products enrolled for an account	Viewing the Proposed Product Enrollments for an Account on page 2858
How to view the pricing and commitment details of a prospect person	Viewing the Pricing and Commitment Details of a Person on page 2858
How to view the pricing and commitment details of a prospect account	Viewing the Pricing and Commitment Details of an Account on page 2859
How to view the division financial summary in the division currency	Viewing the Division Financial Summary in the Division Currency on page 2859
How to view the product financial summary in the division currency	Viewing the Product Financial Summary in the Division Currency on page 2860

For more information on...	See...
How to view the revenue and cost in the division or account currency	Viewing the Revenue and Cost in the Division or Account Currency on page 2861
How to simulate a deal	Simulating a Deal on page 2861
How to submit a deal for approval	Submitting a Deal for an Approval on page 2862
How to approve a deal	Approving a Deal on page 2862
How to request the submitter to resubmit the deal for approval	Requesting the Submitter to Resubmit the Deal for Approval on page 2863
How to finalize a deal	Finalizing a Deal on page 2775
Hoe to discard a deal	Discarding a Deal on page 2865
How to accept a deal	Accepting a Deal on page 2776
How to reject a deal	Rejecting a Deal on page 2777
How to extract a deal in the pdf or excel format	Extracting a Deal in the PDF or Excel Format on page 2779
How to define a deal version	Defining a Deal Version on page 2874

Deal Information - Orchestration

You can view the **Deal Information - Orchestration** page of a deal when the **Deal Status** is **Fully Orchestrated**. It contains the following zones:

- [Deal Information](#) on page 2845
- [Simulation Details](#) on page 2847

Related Topics

For more information on...	See...
Deal Information screen	Deal Information on page 2815

Deal Information

The **Deal Information** zone allows you to do the following:

- View the details of the deal
- Associate, disassociate, view, or edit the terms and conditions of the deal
- View and add log entries for the deal or deal version
- View and add adhoc revenue charges for the deal or deal version

Field Name	Field Description
Deal Information	Displays the concatenated string of information about the deal separated by a comma (,).
Division	Indicates the division with which the deal is associated.
Deal Type	Indicates the deal type using which the deal is created in the system.
Review Date	Displays the date which is scheduled for calculating the deal usage as per the commitments made by the customer.

Field Name	Field Description
	Note: This field is populated when the deal has reached the Full Orchestrated status.
Deal Version Information	Displays the concatenated string of information about the deal version separated by a comma (,).
Access Group	Indicates the group of users who can view and edit the details of the entity (i.e. the customer, account, or prospect person) for which the deal is created.
Review Frequency	Indicates the duration for which the deal is monitored to calculate the usage of the deal as per the commitments made by the customer.
Effective Start Date	Displays the date from when the deal is effective for the entity (i.e. the customer, account, or prospect person). Note: This field is populated when the deal has reached the Customer Accepted status.
Deal Description	Displays the description of the deal.
Customer Segment	Displays the business component to which the entity (i.e. the customer, account, or prospect person) belongs.
Creation Date	Displays the date when the deal is created in the system.
Effective End Date	Displays the date till when the deal is effective for the entity (i.e. the customer, account, or prospect person). Note: This field is populated when the deal has reached the Customer Accepted status.
Deal Status	Indicates the current status of the deal. The valid values are: <ul style="list-style-type: none"> • Applied/Processed • Approved • Closed • Customer Accepted • Discarded • Draft • Error • Finalized • Fully Orchestrated • Hierarchy Creation Deferred • Inactive • Partially Orchestrated • Pending for Approval • Pending for Review • Pending Simulation • Pending for Orchestration

Field Name	Field Description
	<ul style="list-style-type: none"> • Ready for Approval • Rejected • Simulated • Simulation Deferred
Customer Tier	Indicates the customer tier of the customer segment to which the entity (i.e. the customer, account, or prospect person) belongs.
Start Date	Displays the date from when the price list, price assignment, and price item pricing is available for the deal.
Acceptance Date	Displays the date when the customer has reviewed and accepted the deal.
	<p>Note: This field is populated when the deal has reached the Customer Accepted status.</p> <p>If the Deal Status is Rejected then the Acceptance Date specifies the date when the deal is rejected by the customer.</p>
Deal Version Status	Indicates the status of the deal version.
Deal Currency	Indicates the currency in which the financial summary and profitability is calculated for the deal.
End Date	Displays the date till when the price list and price assignment is available for the deal.
Finalized Date	Displays the date when the deal is finalized in the system.
	<p>Note: This field is populated when the deal has reached the Customer Accepted status.</p>
Simulation Type	<p>Indicates the simulation type using which the financial summary and profitability is calculated for the deal. The valid values are:</p> <ul style="list-style-type: none"> • Account • Customer • Deal
Usage Period	<p>Indicates the period for which you want to aggregate the deal data to determine the scope of the deal. The valid values are:</p> <ul style="list-style-type: none"> • Biannually • Monthly • Quarterly • Yearly
Deal Frequency	<p>Indicates the duration in which you want to simulate the deal for calculating the financial summary and deal profitability. The valid values are:</p> <ul style="list-style-type: none"> • Biannually • Monthly • Quarterly

Field Name	Field Description
	<ul style="list-style-type: none"> Yearly

In addition, the **Deal Information** zone contains the following links:

Link Name	Link Description
Deal Terms and Conditions	Used to associate, disassociate, edit, or view the deal terms and conditions. It is also used to add adhoc terms and conditions for the deal.
Deal Log	Used to view the complete trail of actions performed on the deal. It also allows you to manually add a log entry for the deal.
Deal Version Log	Used to view the complete trail of actions performed on the deal version. It also allows you to manually add a log entry for the deal version.
Adhoc Revenue and Cost	Used to add, edit, or view additional charges that are applicable for the deal while deal creation.

Related Topics

For more information on...	See...
How to view the logs of a deal	Viewing the Logs of a Deal on page 3042
How to add a log entry for a deal	Adding a Log Entry for a Deal on page 3043
How to view the logs of a deal version	Viewing the Logs of a Deal Version on page 3045
How to add a log entry for a deal version	Adding a Log Entry for a Deal Version on page 3046
How to add adhoc revenue charges for a deal	Adding Adhoc Revenue and Cost for a Deal on page 3048
How to associate the terms and conditions with a deal	Associating the Terms and Conditions with a Deal on page 3038
How to view the terms and conditions of a deal	Viewing the Terms and Conditions of a Deal on page 3040
How to edit the terms and conditions of a deal	Editing the Terms and Conditions of a Deal on page 3039







Simulation Details

The **Simulation Details** zone allows you to do the following:

- View the deal financial summary
- View the division financial summary
- View the product financial summary
- View the customer hierarchy
- View the assigned price lists of a person or account
- View the proposed price list assignments of a person or account
- View the enrolled products for an account
- View the proposed product enrollments for an account
- View the pricing and commitment details of a person or account
- View the division financial summary in the division currency
- View the product financial summary in the division currency
- View the revenue and cost in the division or account currency

The **Simulation Details** zone contains the following sections:

- **Symbol Legends** - Indicates the symbols used to identify the current status of the deal level, division level, and product level financial summary. It also differentiates the existing, proposed and recommended pricing statistics. It contains the following symbols:

Symbol Name	Symbol Description
 IN APPROVER RANGE	Indicates that the deal level, division level, or product level financial summary is within the limits defined for the user for approval.
 NOT IN APPROVER RANGE	Indicates that the deal level, division level, or product level financial summary is not within the limits defined for the user for approval.
 PROJECTED	Indicates the revenue, cost, and profit generated from the proposed price item pricing and price assignments.
 RECOMMENDED	Indicates the revenue, cost, and profit generated from the recommended price item pricing and price assignments.
 ORIGINAL	Indicates the revenue, cost, and profit generated from the existing price item pricing and price assignments.
 APPROVED	Indicates whether the deal level, division level, or product level financial summary is approved or not.
 PENDING FOR APPROVAL	Indicates that the approval for deal level, division level, or product level financial summary is pending.

- **Deal Financial Summary** - Displays the financial summary at the deal level. It contains the following columns:

Column Name	Column Description
Approval Status	Indicates the current approval status of the financial summary at the deal level.
Revenue	Displays the proposed, recommended, and original revenue generated from the price item pricing and price assignments at the deal level. Note: If division level approval is required, then the revenue includes the sum of revenues calculated at each division level.
Cost	Displays the proposed, recommended, and original cost calculated at the deal level. Note: The cost includes the total price item cost and the adhoc cost. If division level approval is required, then the cost includes the sum of costs calculated at each division level.
Profit	Displays the proposed, recommended, and original profit in deal currency generated from the price item pricing and price assignments at the deal level. It is calculated using the following formula: Profit = Revenue – Cost Note: If division level approval is required, then the profit includes the sum of profits calculated at each division level.

Column Name	Column Description
Profitability (%)	Displays the proposed, recommended, and original profit created in percentage at the deal level from the price item pricing and price assignments. It is calculated using the following formula: Profitability % = (Revenue – Cost)*100/ Revenue
Profit Variation (%)	Displays the difference of profit in percentage generated from the original and the proposed price item pricing and commitments at the deal level. It is calculated using the following formula: Profit Variation (%) = (Proposed Profit – Original Profit)*100/ Original Profit

Note: The data in the **Deal Financial Summary** sections appears when the deal has reached the **Simulated** status.

- **Division Financial Summary** - Displays the financial summary at the division level. It contains the following columns:

Column Name	Column Description
Division	Indicates the division for which the financial summary is displayed.
Approval Status	Indicates the current approval status of the financial summary at the division level.
Revenue	Displays the proposed, recommended, and original revenue generated from the price item pricing and price assignments at the division level.
Cost	Displays the proposed, recommended, and original cost calculated at the division level. Note: The cost includes the total price item cost and the adhoc cost.
Profit	Displays the proposed, recommended, and original profit in deal currency generated from the price item pricing and price assignments at the division level. It is calculated using the following formula: Profit = Revenue – Cost
Profitability (%)	Displays the proposed, recommended, and original profit generated in percentage at the division level from the price item pricing and price assignments. It is calculated using the following formula: Profitability % = (Revenue – Cost)*100/ Revenue
Profit Variation (%)	Displays the difference of profit in percentage generated from the original and the proposed price item pricing and commitments at the division level. It is calculated using the following formula: Profit Variation (%) = (Proposed Profit – Original Profit)*100/ Original Profit

Note:

The **Division Financial Summary** sections appears in the **Simulation Details** zone when the **Division Level Approval Required** field is set to **Yes** in the **Deal Type** used for defining the deal.

The data in the **Division Financial Summary** sections appears when the deal has reached the **Simulated** status.

By default, the division financial summary is displayed in the deal currency. You can view the division financial summary in the division currency by clicking the toggle switch towards **Division Currency** available above the financial summary table.

- **Product Financial Summary** - Displays the financial summary at the product level. It contains the following columns:

Column Name	Column Description
Product	Indicates the product whose financial summary is displayed.
Division	Indicates the division to which the product belongs.
Approval Status	Indicates the current approval status of the financial summary at the product level.
Revenue	Displays the proposed, recommended, and original revenue generated from the product.
Cost	Displays the proposed, recommended, and original cost calculated for the product.
	Note: The cost includes the total price item cost and the adhoc cost.
Profit	Displays the proposed, recommended, and original profit in deal currency generated from the price item pricing and price assignments at the product level. It is calculated using the following formula: Profit = Revenue – Cost
Profitability (%)	Displays the proposed, recommended, and original profit generated in percentage from the price item pricing and price assignments at the product level . It is calculated using the following formula: Profitability % = (Revenue – Cost)*100/ Revenue
Profit Variation (%)	Displays the difference of profit in percentage generated from the original and the proposed price item pricing and commitments at the product level. It is calculated using the following formula: Profit Variation (%) = (Proposed Profit – Original Profit)*100/ Original Profit

Note:

The **Product Financial Summary** sections appears in the **Simulation Details** zone when the **Product Level Approval Required** field is set to **Yes** in the **Deal Type** used for defining the deal.

The data in the **Product Financial Summary** sections appears when the deal has reached the **Simulated** status.

By default, the product financial summary is displayed in the deal currency. You can view the product financial summary in the division currency by clicking the toggle switch towards **Division Currency** available above the financial summary table.

- **Customer Hierarchy** - Indicates the main customer and its associated accounts as well as the child persons and its accounts that are associated with the main customer. It also enables you to do the following:
 - View and edit the pricing and commitments at the person and account level
 - View the revenue variation from the proposed and original pricing and commitments
 - View the proposed price lists of a person or account
 - Assign proposed price list to a person or account
 - View the enrolled products of an account
 - Enroll accounts for a product
 - View the original price list of a person or account
 - View the original enrolled products for an account
 - View the proposed or the original revenue and cost generated at the person an account level.

The **Customer Hierarchy** section contains the following columns:

Column Name	Column Description
Person Name	Indicates the main customer and its related persons and accounts.
Division	Indicates the division to which the main customer and it related persons and accounts are associated.
Pricing and Commitments	<p>On clicking the Edit (✎) icon in the Pricing and Commitments column corresponding to a person or account in the hierarchy, the Pricing and Commitments screen appears where you can view and edit the pricing and commitments of the price items for the respective person or account.</p> <p>Note: You cannot edit the pricing or commitments of the price items if the deal has reached the Finalized status.</p>
Status	Indicates the approval status of the price item pricing and price assignments for the respective person or account.
Revenue Variation (%)	<p>Displays the average revenue generated from a customer or account in percentage. It is calculated using the following formula:</p> $\text{Revenue Variation (\%)} = (\text{Proposed Revenue} - \text{Original Revenue}) * 100 / \text{Original Revenue}.$
Price List Assignment	<p>On clicking the Edit (✎) icon in the Price List Assignment column corresponding to a person or account in the hierarchy, the Price List Assignment screen appears where you can view and assign proposed price list to the respective person or account.</p> <p>Note: You cannot assign proposed price list to the person or account if the deal has reached the Finalized status.</p>
Product Enrollment	<p>On clicking the Edit (✎) icon in the Product Enrollment column corresponding to the person or account in the hierarchy, the Product Enrollment screen appears where you can view or enroll the respective account or accounts of the customer for a product. You can also view a list of recommended products for which you want to enroll the account or accounts of the customer. The recommended products appear in the Product Enrollment screen when you add products in the Recommended Products section while defining a deal.</p>



Column Name	Column Description
	Note: You cannot enroll an account for a product if the deal has reached the Finalized status.
Price Item Group Selection	On clicking the Edit (✎) icon in the Price Item Group Selection column corresponding to the main person in the hierarchy, the Select Price Item Group screen appears where you can select and/or deselect the price items and/or hierarchy entities based on which you want to simulate the deal.
Revenue	Indicates the revenue generated by the corresponding person or account in the hierarchy through the proposed price item pricing and commitments.
Cost	Indicates the sum of the proposed costs from all accounts under the customer. Note: If the person is a parent customer, then the sum of the proposed costs of all the child customers is considered.
Pricelist	On clicking the View (📄) icon in the Price List column corresponding to the person or account in the hierarchy, the Price List Assignment screen appears where you can view the original price list assigned to the respective person or account.
Product	On clicking the Edit (✎) icon in the Product column corresponding to the person or account in the hierarchy, the Product Enrollment screen appears where you can view the products to which the account is already enrolled.
Revenue	Indicates the revenue generated by the corresponding person or account in the hierarchy through the original price item pricing and commitments.
Cost	Indicates the sum of the original costs from all accounts under the customer. Note: If the person is a parent customer, then the sum of the original costs of all the child customers is considered.

Note: The system also considers the prospect persons and prospect accounts associated with the main customer along with the child and grandchild persons and their accounts in the customer hierarchy.

In addition, the **Simulation Details** zone contains the following buttons:

Button Name	Button Description
Deal Pricing and Commitments	Used to define the consolidated pricing and commitments for the customers or accounts in a deal.
Simulate Deal	Used to perform different types of simulation based on the pricing and commitments of the price item to determine the best price that can be offered to the clients as per their requirements.
Check Limits	Used to execute the price item ceil and floor validation for an approver as per the limits set on the price item screen.

Button Name	Button Description
	<p>Note:</p> <p>The Check Limits is run only for the price items which are in the Pending for Approval or Error status after the Pricing Simulation is executed.</p> <p>The Check Limits button is activated when the Price Item Approval Required option is set to Yes in the Deal Type using which the deal is created.</p>
Send Deal for Approval	<p>Used to move the deal from the current role to the next role of the next level in the approval hierarchy for approval.</p> <p>Note:</p> <p>On clicking the Send Deal for Approval button, a To Do notification is created for the users of the next level to indicate that approval of the deal is required.</p> <p>A To Do is also created for the creator (i.e. the Relationship Manager) of the deal to indicate that the ownership of the deal has changed.</p> <p>This button is activated after Pricing Simulation is completed for the deal and if the Approve Deal option is set to Yes for the approver in the Approval Hierarchy of the Deal Approval Profile.</p>
Approve Deal	<p>Used to approve the deal. To approve a deal the following conditions should be met:</p> <ul style="list-style-type: none"> • All the price items should be in the Approved status if the Price Item Approval Required option is set to Yes in the Deal Type used for creating the deal. • All the division level approvals must be completed if the Division Level Approval Required field is set to Yes in the Deal Type used for creating the deal. • All the product level approvals must be completed if the Product Level Approval Required field is set to Yes in the Deal Type used for creating the deal. • The deal should be in the Ready for Approval status for the approver to initiate the deal approval process. <p>Note:</p> <p>The Approve Deal button is activated only when the deal is in the Ready for Approval status and the Approve Deal option is set to Yes for the approver in the Approval Hierarchy of the Deal Approval Profile.</p>
Return to Submitter	<p>Used to move the deal from the current role to the previous role of the previous level in the approval hierarchy for approval. It is also used to send the deal to the relationship manager for approval if you have recommended a new pricing for the price item.</p>

Button Name	Button Description
	<p>Note:</p> <p>On clicking the Return to Submitter button, a To Do notification is created for the users of the previous level to indicate that the deal is returned for approval.</p> <p>A To Do is also created for the creator (i.e. the Relationship Manager) of the deal to indicate that the ownership of the deal has changed.</p>
Finalize Deal	<p>Used to finalize the deal so that it is ready to be presented to the customer for approval.</p> <p>Note: This button is activated when the deal is in the Approved status.</p> <p>Tip: You can also finalize a deal by clicking the Finalize () icon in the Finalize Deal column corresponding to the deal in the Search Deal zone of the Deal Dashboard screen.</p>
Accept Deal	<p>Used to accept the deal in the system after receiving confirmation of acceptance from the customer.</p> <p>Note: This button is activated only when the deal is in the Finalized status.</p> <p>Tip: You can also accept a deal by clicking the Accept () icon in the Accept Deal column corresponding to the deal in the Search Deal zone of the Deal Dashboard screen.</p>
Reject Deal	<p>Used to reject the deal in the system after receiving confirmation of rejection from the customer.</p> <p>Note: This button is activated only when the deal is in the Finalized status.</p> <p>Tip: You can also reject a deal by clicking the Reject () icon in the Reject Deal column corresponding to the deal in the Search Deal zone of the Deal Dashboard screen.</p>
Create Deal Version	<p>Used to create a deal version for the existing deal to optimize the deal pricing process and to make better pricing decisions.</p> <p>Note: You can add a new deal version to a deal even if the version of any deal version of a deal is in the Finalized status and the status of the deal is Pending for Approval or Approved.</p>
Discard Deal	<p>Used to discard the deal.</p> <p>Note: You cannot discard a deal if it has reached the Finalized status.</p>
Print Deal	<p>Used to extract relevant information about the deal in the pdf or excel format which is published either to the customer for receiving approvals or for internal reviews and validations.</p>
Apply Back	<p>Used to activate the proposed pricelist assignments, overridden pricing, and product enrollments for the existing customer or account in the system.</p>
Previous	<p>Used to view information about the previous status of the deal.</p>

Related Topics

For more information on...	See...
Search Deal zone	Search Deal on page 2758
Price List Assignment screen	Price List Assignment on page 2979
Product Enrollment screen	Product Enrollment on page 2987
Pricing and Commitments screen	Pricing and Commitments on page 2934
Pricing and Commitments screen	Pricing and Commitments on page 3002
How to view the customer hierarchy of a deal	Viewing the Customer Hierarchy of a Deal on page 2856
How to view the existing price lists of a person or an account	Viewing the Assigned Price Lists of a Person or Account on page 2856
How to view the proposed price lists of a person or an account	Viewing the Proposed Price List Assignments of a Person or Account on page 2857
How to view the existing products enrolled for an account	Viewing the Enrolled Products of an Account on page 2857
How to view the proposed products enrolled for an account	Viewing the Proposed Product Enrollments for an Account on page 2858
How to view the pricing and commitment details of a prospect person	Viewing the Pricing and Commitment Details of a Person on page 2858
How to view the pricing and commitment details of a prospect account	Viewing the Pricing and Commitment Details of an Account on page 2859
How to view the division financial summary in the division currency	Viewing the Division Financial Summary in the Division Currency on page 2859
How to view the product financial summary in the division currency	Viewing the Product Financial Summary in the Division Currency on page 2860
How to view the revenue and cost in the division or account currency	Viewing the Revenue and Cost in the Division or Account Currency on page 2861
How to simulate a deal	Simulating a Deal on page 2861
How to submit a deal for approval	Submitting a Deal for an Approval on page 2862
How to approve a deal	Approving a Deal on page 2862
How to request the submitter to resubmit the deal for approval	Requesting the Submitter to Resubmit the Deal for Approval on page 2863
How to finalize a deal	Finalizing a Deal on page 2775
How to discard a deal	Discarding a Deal on page 2865
How to accept a deal	Accepting a Deal on page 2776
How to reject a deal	Rejecting a Deal on page 2777
How to extract a deal in the pdf or excel format	Extracting a Deal in the PDF or Excel Format on page 2779
How to define a deal version	Defining a Deal Version on page 2874

Deal Information - Discarded

You can view the **Deal Information - Discarded** page of a deal when the deal is in the **Discarded** status. It contains the following zones:

- [Deal Information](#) on page 2845
- [Simulation Details](#) on page 2847

Note:

You cannot discard a deal if it has reached the **Finalized** status.

If you discard a deal version, the status of the deal for which the deal version is created is changed to **Discarded**.

Related Topics

For more information on...	See...
Deal Information screen	Deal Information on page 2815
How to discard a deal	Discarding a Deal on page 2865

Deal Information

The **Deal Information** zone allows you to do the following:

- View the details of the deal
- Associate, disassociate, view, or edit the terms and conditions of the deal
- View and add log entries for the deal or deal version
- View and add adhoc revenue charges for the deal or deal version

Field Name	Field Description
Deal Information	Displays the concatenated string of information about the deal separated by a comma (,).
Division	Indicates the division with which the deal is associated.
Deal Type	Indicates the deal type using which the deal is created in the system.
Review Date	Displays the date which is scheduled for calculating the deal usage as per the commitments made by the customer. Note: This field is populated when the deal has reached the Full Orchestrated status.
Deal Version Information	Displays the concatenated string of information about the deal version separated by a comma (,).
Access Group	Indicates the group of users who can view and edit the details of the entity (i.e. the customer, account, or prospect person) for which the deal is created.
Review Frequency	Indicates the duration for which the deal is monitored to calculate the usage of the deal as per the commitments made by the customer.
Effective Start Date	Displays the date from when the deal is effective for the entity (i.e. the customer, account, or prospect person). Note: This field is populated when the deal has reached the Customer Accepted status.

Field Name	Field Description
Deal Description	Displays the description of the deal.
Customer Segment	Displays the business component to which the entity (i.e. the customer, account, or prospect person) belongs.
Creation Date	Displays the date when the deal is created in the system.
Effective End Date	Displays the date till when the deal is effective for the entity (i.e. the customer, account, or prospect person).
	Note: This field is populated when the deal has reached the Customer Accepted status.
Deal Status	<p>Indicates the current status of the deal. The valid values are:</p> <ul style="list-style-type: none"> • Applied/Processed • Approved • Closed • Customer Accepted • Discarded • Draft • Error • Finalized • Fully Orchestrated • Hierarchy Creation Deferred • Inactive • Partially Orchestrated • Pending for Approval • Pending for Review • Pending Simulation • Pending for Orchestration • Ready for Approval • Rejected • Simulated • Simulation Deferred
Customer Tier	Indicates the customer tier of the customer segment to which the entity (i.e. the customer, account, or prospect person) belongs.
Start Date	Displays the date from when the price list, price assignment, and price item pricing is available for the deal.
Acceptance Date	Displays the date when the customer has reviewed and accepted the deal.

Field Name	Field Description
	<p>Note: This field is populated when the deal has reached the Customer Accepted status.</p> <p>If the Deal Status is Rejected then the Acceptance Date specifies the date when the deal is rejected by the customer.</p>
Deal Version Status	Indicates the status of the deal version.
Deal Currency	Indicates the currency in which the financial summary and profitability is calculated for the deal.
End Date	Displays the date till when the price list and price assignment is available for the deal.
Finalized Date	Displays the date when the deal is finalized in the system.
	<p>Note: This field is populated when the deal has reached the Customer Accepted status.</p>
Simulation Type	Indicates the simulation type using which the financial summary and profitability is calculated for the deal. The valid values are: <ul style="list-style-type: none"> • Account • Customer • Deal
Usage Period	Indicates the period for which you want to aggregate the deal data to determine the scope of the deal. The valid values are: <ul style="list-style-type: none"> • Biannually • Monthly • Quarterly • Yearly
Deal Frequency	Indicates the duration in which you want to simulate the deal for calculating the financial summary and deal profitability. The valid values are: <ul style="list-style-type: none"> • Biannually • Monthly • Quarterly • Yearly

In addition, the **Deal Information** zone contains the following links:

Link Name	Link Description
Deal Terms and Conditions	Used to associate, disassociate, edit, or view the deal terms and conditions. It is also used to add adhoc terms and conditions for the deal.
Deal Log	Used to view the complete trail of actions performed on the deal. It also allows you to manually add a log entry for the deal.
Deal Version Log	Used to view the complete trail of actions performed on the deal version. It also allows you to manually add a log entry for the deal version.

Link Name	Link Description
Adhoc Revenue and Cost	Used to add, edit, or view additional charges that are applicable for the deal while deal creation.

Related Topics

For more information on...	See...
How to view the logs of a deal	Viewing the Logs of a Deal on page 3042
How to add a log entry for a deal	Adding a Log Entry for a Deal on page 3043
How to view the logs of a deal version	Viewing the Logs of a Deal Version on page 3045
How to add a log entry for a deal version	Adding a Log Entry for a Deal Version on page 3046
How to add adhoc revenue charges for a deal	Adding Adhoc Revenue and Cost for a Deal on page 3048
How to associate the terms and conditions with a deal	Associating the Terms and Conditions with a Deal on page 3038
How to view the terms and conditions of a deal	Viewing the Terms and Conditions of a Deal on page 3040
How to edit the terms and conditions of a deal	Editing the Terms and Conditions of a Deal on page 3039



Simulation Details





The **Simulation Details** zone allows you to do the following:

- View the deal financial summary
- View the division financial summary
- View the product financial summary
- View the customer hierarchy
- View the assigned price lists of a person or account
- View the proposed price list assignments of a person or account
- View the enrolled products for an account
- View the proposed product enrollments for an account
- View the pricing and commitment details of a person or account
- View the division financial summary in the division currency
- View the product financial summary in the division currency
- View the revenue and cost in the division or account currency

The **Simulation Details** zone contains the following sections:

- **Symbol Legends** - Indicates the symbols used to identify the current status of the deal level, division level, and product level financial summary. It also differentiates the existing, proposed and recommended pricing statistics. It contains the following symbols:

Symbol Name	Symbol Description
 IN APPROVER RANGE	Indicates that the deal level, division level, or product level financial summary is within the limits defined for the user for approval.
 NOT IN APPROVER RANGE	Indicates that the deal level, division level, or product level financial summary is not within the limits defined for the user for approval.

Symbol Name	Symbol Description
 PROJECTED	Indicates the revenue, cost, and profit generated from the proposed price item pricing and price assignments.
 RECOMMENDED	Indicates the revenue, cost, and profit generated from the recommended price item pricing and price assignments.
 ORIGINAL	Indicates the revenue, cost, and profit generated from the existing price item pricing and price assignments.
 APPROVED	Indicates whether the deal level, division level, or product level financial summary is approved or not.
 PENDING FOR APPROVAL	Indicates that the approval for deal level, division level, or product level financial summary is pending.

- **Deal Financial Summary** - Displays the financial summary at the deal level. It contains the following columns:

Column Name	Column Description
Approval Status	Indicates the current approval status of the financial summary at the deal level.
Revenue	<p>Displays the proposed, recommended, and original revenue generated from the price item pricing and price assignments at the deal level.</p> <p>Note: If division level approval is required, then the revenue includes the sum of revenues calculated at each division level.</p>
Cost	<p>Displays the proposed, recommended, and original cost calculated at the deal level.</p> <p>Note: The cost includes the total price item cost and the adhoc cost. If division level approval is required, then the cost includes the sum of costs calculated at each division level.</p>
Profit	<p>Displays the proposed, recommended, and original profit in deal currency generated from the price item pricing and price assignments at the deal level. It is calculated using the following formula:</p> <p>Profit = Revenue – Cost</p> <p>Note: If division level approval is required, then the profit includes the sum of profits calculated at each division level.</p>
Profitability (%)	<p>Displays the proposed, recommended, and original profit created in percentage at the deal level from the price item pricing and price assignments. It is calculated using the following formula:</p> <p>Profitability % = (Revenue – Cost)*100/ Revenue</p>
Profit Variation (%)	<p>Displays the difference of profit in percentage generated from the original and the proposed price item pricing and commitments at the deal level. It is calculated using the following formula:</p> <p>Profit Variation (%) = (Proposed Profit – Original Profit)*100/ Original Profit</p>

Note: The data in the **Deal Financial Summary** sections appears when the deal has reached the **Simulated** status.

- **Division Financial Summary** - Displays the financial summary at the division level. It contains the following columns:

Column Name	Column Description
Division	Indicates the division for which the financial summary is displayed.
Approval Status	Indicates the current approval status of the financial summary at the division level.
Revenue	Displays the proposed, recommended, and original revenue generated from the price item pricing and price assignments at the division level.
Cost	Displays the proposed, recommended, and original cost calculated at the division level.
	Note: The cost includes the total price item cost and the adhoc cost.
Profit	Displays the proposed, recommended, and original profit in deal currency generated from the price item pricing and price assignments at the division level. It is calculated using the following formula: Profit = Revenue – Cost
Profitability (%)	Displays the proposed, recommended, and original profit generated in percentage at the division level from the price item pricing and price assignments. It is calculated using the following formula: Profitability % = (Revenue – Cost)*100/ Revenue
Profit Variation (%)	Displays the difference of profit in percentage generated from the original and the proposed price item pricing and commitments at the division level. It is calculated using the following formula: Profit Variation (%) = (Proposed Profit – Original Profit)*100/ Original Profit

Note:

The **Division Financial Summary** sections appears in the **Simulation Details** zone when the **Division Level Approval Required** field is set to **Yes** in the **Deal Type** used for defining the deal.

The data in the **Division Financial Summary** sections appears when the deal has reached the **Simulated** status.

By default, the division financial summary is displayed in the deal currency. You can view the division financial summary in the division currency by clicking the toggle switch towards **Division Currency** available above the financial summary table.

- **Product Financial Summary** - Displays the financial summary at the product level. It contains the following columns:

Column Name	Column Description
Product	Indicates the product whose financial summary is displayed.
Division	Indicates the division to which the product belongs.
Approval Status	Indicates the current approval status of the financial summary at the product level.

Column Name	Column Description
Revenue	Displays the proposed, recommended, and original revenue generated from the product.
Cost	Displays the proposed, recommended, and original cost calculated for the product.
	Note: The cost includes the total price item cost and the adhoc cost.
Profit	Displays the proposed, recommended, and original profit in deal currency generated from the price item pricing and price assignments at the product level. It is calculated using the following formula: Profit = Revenue – Cost
Profitability (%)	Displays the proposed, recommended, and original profit generated in percentage from the price item pricing and price assignments at the product level . It is calculated using the following formula: Profitability % = (Revenue – Cost)*100/ Revenue
Profit Variation (%)	Displays the difference of profit in percentage generated from the original and the proposed price item pricing and commitments at the product level. It is calculated using the following formula: Profit Variation (%) = (Proposed Profit – Original Profit)*100/ Original Profit

Note:

The **Product Financial Summary** sections appears in the **Simulation Details** zone when the **Product Level Approval Required** field is set to **Yes** in the **Deal Type** used for defining the deal.

The data in the **Product Financial Summary** sections appears when the deal has reached the **Simulated** status.

By default, the product financial summary is displayed in the deal currency. You can view the product financial summary in the division currency by clicking the toggle switch towards **Division Currency** available above the financial summary table.

- **Customer Hierarchy** - Indicates the main customer and its associated accounts as well as the child persons and its accounts that are associated with the main customer. It also enables you to do the following:
 - View and edit the pricing and commitments at the person and account level
 - View the revenue variation from the proposed and original pricing and commitments
 - View the proposed price lists of a person or account
 - Assign proposed price list to a person or account
 - View the enrolled products of an account
 - Enroll accounts for a product
 - View the original price list of a person or account
 - View the original enrolled products for an account
 - View the proposed or the original revenue and cost generated at the person an account level.

The **Customer Hierarchy** section contains the following columns:



Column Name	Column Description
Person Name	Indicates the main customer and its related persons and accounts.
Division	Indicates the division to which the main customer and it related persons and accounts are associated.
Pricing and Commitments	<p>On clicking the Edit (✎) icon in the Pricing and Commitments column corresponding to a person or account in the hierarchy, the Pricing and Commitments screen appears where you can view and edit the pricing and commitments of the price items for the respective person or account.</p> <p>Note: You cannot edit the pricing or commitments of the price items if the deal has reached the Finalized status.</p>
Status	Indicates the approval status of the price item pricing and price assignments for the respective person or account.
Revenue Variation (%)	<p>Displays the average revenue generated from a customer or account in percentage. It is calculated using the following formula:</p> $\text{Revenue Variation (\%)} = (\text{Proposed Revenue} - \text{Original Revenue}) * 100 / \text{Original Revenue}.$
Price List Assignment	<p>On clicking the Edit (✎) icon in the Price List Assignment column corresponding to a person or account in the hierarchy, the Price List Assignment screen appears where you can view and assign proposed price list to the respective person or account.</p> <p>Note: You cannot assign proposed price list to the person or account if the deal has reached the Finalized status.</p>
Product Enrollment	<p>On clicking the Edit (✎) icon in the Product Enrollment column corresponding to the person or account in the hierarchy, the Product Enrollment screen appears where you can view or enroll the respective account or accounts of the customer for a product. You can also view a list of recommended products for which you want to enroll the account or accounts of the customer. The recommended products appear in the Product Enrollment screen when you add products in the Recommended Products section while defining a deal.</p> <p>Note: You cannot enroll an account for a product if the deal has reached the Finalized status.</p>
Price Item Group Selection	On clicking the Edit (✎) icon in the Price Item Group Selection column corresponding to the main person in the hierarchy, the Select Price Item Group screen appears where you can select and/or deselect the price items and/or hierarchy entities based on which you want to simulate the deal.
Revenue	Indicates the revenue generated by the corresponding person or account in the hierarchy through the proposed price item pricing and commitments.
Cost	<p>Indicates the sum of the proposed costs from all accounts under the customer.</p> <p>Note: If the person is a parent customer, then the sum of the proposed costs of all the child customers is considered.</p>

Column Name	Column Description
Pricelist	On clicking the View (📄) icon in the Price List column corresponding to the person or account in the hierarchy, the Price List Assignment screen appears where you can view the original price list assigned to the respective person or account.
Product	On clicking the Edit (✎) icon in the Product column corresponding to the person or account in the hierarchy, the Product Enrollment screen appears where you can view the products to which the account is already enrolled.
Revenue	Indicates the revenue generated by the corresponding person or account in the hierarchy through the original price item pricing and commitments.
Cost	Indicates the sum of the original costs from all accounts under the customer. Note: If the person is a parent customer, then the sum of the original costs of all the child customers is considered.

Note: The system also considers the prospect persons and prospect accounts associated with the main customer along with the child and grandchild persons and their accounts in the customer hierarchy.

In addition, the **Simulation Details** zone contains the following buttons:

Button Name	Button Description
Deal Pricing and Commitments	Used to define the consolidated pricing and commitments for the customers or accounts in a deal.
Simulate Deal	Used to perform different types of simulation based on the pricing and commitments of the price item to determine the best price that can be offered to the clients as per their requirements.
Check Limits	Used to execute the price item ceil and floor validation for an approver as per the limits set on the price item screen. Note: The Check Limits is run only for the price items which are in the Pending for Approval or Error status after the Pricing Simulation is executed. The Check Limits button is activated when the Price Item Approval Required option is set to Yes in the Deal Type using which the deal is created.
Send Deal for Approval	Used to move the deal from the current role to the next role of the next level in the approval hierarchy for approval. Note: On clicking the Send Deal for Approval button, a To Do notification is created for the users of the next level to indicate that approval of the deal is required. A To Do is also created for the creator (i.e. the Relationship Manager) of the deal to indicate that the ownership of the deal has changed. This button is activated after Pricing Simulation is completed for the deal and if the Approve Deal option is set to Yes for the approver in the Approval Hierarchy of the Deal Approval Profile .

Button Name	Button Description
Approve Deal	<p>Used to approve the deal. To approve a deal the following conditions should be met:</p> <ul style="list-style-type: none"> • All the price items should be in the Approved status if the Price Item Approval Required option is set to Yes in the Deal Type used for creating the deal. • All the division level approvals must be completed if the Division Level Approval Required field is set to Yes in the Deal Type used for creating the deal. • All the product level approvals must be completed if the Product Level Approval Required field is set to Yes in the Deal Type used for creating the deal. • The deal should be in the Ready for Approval status for the approver to initiate the deal approval process. <div style="border: 1px solid black; padding: 5px; margin-top: 10px;"> <p>Note:</p> <p>The Approve Deal button is activated only when the deal is in the Ready for Approval status and the Approve Deal option is set to Yes for the approver in the Approval Hierarchy of the Deal Approval Profile.</p> </div>
Return to Submitter	<p>Used to move the deal from the current role to the previous role of the previous level in the approval hierarchy for approval. It is also used to send the deal to the relationship manager for approval if you have recommended a new pricing for the price item.</p> <div style="border: 1px solid black; padding: 5px; margin-top: 10px;"> <p>Note:</p> <p>On clicking the Return to Submitter button, a To Do notification is created for the users of the previous level to indicate that the deal is returned for approval.</p> <p>A To Do is also created for the creator (i.e. the Relationship Manager) of the deal to indicate that the ownership of the deal has changed.</p> </div>
Finalize Deal	<p>Used to finalize the deal so that it is ready to be presented to the customer for approval.</p> <div style="border: 1px solid black; padding: 5px; margin-top: 10px;"> <p>Note: This button is activated when the deal is in the Approved status.</p> </div> <div style="border: 1px solid black; padding: 5px; margin-top: 10px;"> <p>Tip: You can also finalize a deal by clicking the Finalize () icon in the Finalize Deal column corresponding to the deal in the Search Deal zone of the Deal Dashboard screen.</p> </div>
Accept Deal	<p>Used to accept the deal in the system after receiving confirmation of acceptance from the customer.</p> <div style="border: 1px solid black; padding: 5px; margin-top: 10px;"> <p>Note: This button is activated only when the deal is in the Finalized status.</p> </div> <div style="border: 1px solid black; padding: 5px; margin-top: 10px;"> <p>Tip: You can also accept a deal by clicking the Accept () icon in the Accept Deal column corresponding to the deal in the Search Deal zone of the Deal Dashboard screen.</p> </div>
Reject Deal	<p>Used to reject the deal in the system after receiving confirmation of rejection from the customer.</p>

Button Name	Button Description
	<p>Note: This button is activated only when the deal is in the Finalized status.</p>
	<p>Tip: You can also reject a deal by clicking the Reject (✖) icon in the Reject Deal column corresponding to the deal in the Search Deal zone of the Deal Dashboard screen.</p>
Create Deal Version	<p>Used to create a deal version for the existing deal to optimize the deal pricing process and to make better pricing decisions.</p> <p>Note: You can add a new deal version to a deal even if the version of any deal version of a deal is in the Finalized status and the status of the deal is Pending for Approval or Approved.</p>
Discard Deal	<p>Used to discard the deal.</p> <p>Note: You cannot discard a deal if it has reached the Finalized status.</p>
Print Deal	Used to extract relevant information about the deal in the pdf or excel format which is published either to the customer for receiving approvals or for internal reviews and validations.
Apply Back	Used to activate the proposed pricelist assignments, overridden pricing, and product enrollments for the existing customer or account in the system.
Previous	Used to view information about the previous status of the deal.

Related Topics

For more information on...	See...
Search Deal zone	Search Deal on page 2758
Price List Assignment screen	Price List Assignment on page 2979
Product Enrollment screen	Product Enrollment on page 2987
Pricing and Commitments screen	Pricing and Commitments on page 2934
Pricing and Commitments screen	Pricing and Commitments on page 3002
How to view the customer hierarchy of a deal	Viewing the Customer Hierarchy of a Deal on page 2856
How to view the existing price lists of a person or an account	Viewing the Assigned Price Lists of a Person or Account on page 2856
How to view the proposed price lists of a person or an account	Viewing the Proposed Price List Assignments of a Person or Account on page 2857
How to view the existing products enrolled for an account	Viewing the Enrolled Products of an Account on page 2857
How to view the proposed products enrolled for an account	Viewing the Proposed Product Enrollments for an Account on page 2858
How to view the pricing and commitment details of a prospect person	Viewing the Pricing and Commitment Details of a Person on page 2858
How to view the pricing and commitment details of a prospect account	Viewing the Pricing and Commitment Details of an Account on page 2859

For more information on...	See...
How to view the division financial summary in the division currency	Viewing the Division Financial Summary in the Division Currency on page 2859
How to view the product financial summary in the division currency	Viewing the Product Financial Summary in the Division Currency on page 2860
How to view the revenue and cost in the division or account currency	Viewing the Revenue and Cost in the Division or Account Currency on page 2861
How to simulate a deal	Simulating a Deal on page 2861
How to submit a deal for approval	Submitting a Deal for an Approval on page 2862
How to approve a deal	Approving a Deal on page 2862
How to request the submitter to resubmit the deal for approval	Requesting the Submitter to Resubmit the Deal for Approval on page 2863
How to finalize a deal	Finalizing a Deal on page 2775
How to discard a deal	Discarding a Deal on page 2865
How to accept a deal	Accepting a Deal on page 2776
How to reject a deal	Rejecting a Deal on page 2777
How to extract a deal in the pdf or excel format	Extracting a Deal in the PDF or Excel Format on page 2779
How to define a deal version	Defining a Deal Version on page 2874

Pricing and Commitments

The **Pricing and Commitments** screen allows you to view the existing and proposed price items pricing and commitments for the person or account in the customer hierarchy of a deal. It also allows you to do the following:

- View the pass through charge information of an account
- View the product financial summary of a person or an account
- Filter the pricing of a person or an account

The **Pricing and Commitments** screen contains the following sections:

- [Pass Through Charge Information](#) on page 2935
- [Product Financial Summary](#) on page 2935
- [Filters](#) on page 2935
- [Pricing and Commitments](#) on page 2936
-

Related Topics

For more information on...	See...
How to view the pass through charge information of an account	Viewing the Pass Through Charge Information of an Account on page 2941
How to view the product financial summary of a person or an account	Viewing the Product Financial Summary of a Person or an Account on page 2942

For more information on...	See...
How to filter the pricing of a person or account	Filtering the Pricing of a Person or an Account on page 2943

Pass Through Charge Information

The **Pass Through Charge Information** section allows you to view the pass through billable charges of an account while calculating the original revenue of the account and customer in a deal. It contains the following columns:

Field Name	Field Description
Price Item	Displays the price item for which you want to view the pass through billable charge for an account in the customer hierarchy.
Amount in Deal Currency	Displays the pass through billable charge in the deal currency.
Amount in Account Currency	Displays the pass through billable charge in the account's invoice currency.

Related Topics

For more information on...	See...
Pricing and Commitments screen	Pricing and Commitments on page 2934

Product Financial Summary

The **Product Financial Summary** section allows you to view the financial summary of the products to which the account is enrolled in the customer hierarchy. It contains the following columns:

Field Name	Field Description
Product	Displays the product for which the account is enrolled.
Revenue Variation (%)	Displays the average revenue generated from the product in percentage. It is calculated using the following formula: Revenue Variation (%) = (Proposed Revenue – Original Revenue)*100/Original Revenue.
Revenue	Displays the proposed, recommended, and original revenue generated from the product.
Cost	Displays the proposed, recommended, and original cost calculated for the product. Note: The cost includes the total price item cost and the adhoc cost.

Related Topics

For more information on...	See...
Pricing and Commitments screen	Pricing and Commitments on page 2934

Filters

The **Filters** section allows you to filter the pricing and commitments of a person or account in the customer hierarchy using various criteria. It contains the following fields in a grid:

Field Name	Field Description
Search	Used to search for the pricing and commitments of a price item associated with a person or account using a specific search criteria.
Effective Date	Used to search for price items pricing whose effective date is later than the deal start date.

In addition, the **Filters** section contains the following buttons:

Button Name	Button Description
Search	Used to search for price item pricing as per the criteria specified in the Search or Effective Date fields.
Show All Pricing	Used to show all the pricing and commitments of the price items associated with the person or account in the customer hierarchy.
Show Customer or Account Level Pricing	Used to filter customer agreed or account agreed price item pricing for the person or account in the customer hierarchy.
Show Changed Data	Used to display the following for the existing customer, account, or prospect: <ul style="list-style-type: none"> • Agreed pricing of a price item assigned to the customer, account, or prospect in the deal • Seasonal pricing of a price item assigned to the customer, account, or prospect in the deal • Proposed pricing of a price item from the price list with higher priority when the pricing is inherited from two or more price lists assigned to the customer, account, or prospect • Proposed pricing of a price item which is edited in the deal • Price item pricing whose default or reference commitments are edited in the deal • Price item pricing for which commitments are added in the deal from the Pricing and Commitments screen • Price item pricing where there is difference between original and proposed cost • Price item pricing where there is difference between original and proposed average price • Price item pricing where there is difference between original and proposed revenue

Related Topics

For more information on...	See...
Pricing and Commitments screen	Pricing and Commitments on page 2934

Pricing and Commitments





The **Pricing and Commitments** section allows you to do the following:

- View the original and proposed commitments of a price item
- View the original and proposed pricing of a price item
- Viewing the original pricing and commitments of a person or an account

- View the pricing and commitments of a person in the division currency
- View the pricing and commitments of an account in the account's invoice currency
- Approve pricing of a price item
- Submit a price item for approval
- Recommend a new pricing for a price item
- View the deal-specific terms and conditions of a price item or a hierarchy entity
- Edit the deal-specific terms and conditions of a price item or a hierarchy entity



The **Pricing and Commitments** section contains the following sub-sections:



- **Symbol Legends** - Used to differentiate between the original, proposed, recommended, and changed pricing and commitments of the price item. It contains the following color codes:

Symbol Name	Symbol Description
 PROJECTED	Indicates the proposed price item pricing and commitments.
 RECOMMENDED	Indicates the recommended price item pricing and commitments.
 ORIGINAL	Indicates the original price item pricing and commitments.
 CHANGED	Indicates the changed price item pricing and commitments.

- **Price Item Hierarchy** - Lists the price items and its pricing and commitments information along with the price item hierarchy associated with the person or account. It contains the following columns:

Column Name	Column Description
Price Item Hierarchy	<p>Displays the price item, non-root level hierarchy entity, and root level hierarchy entity associated with the person or account.</p> <p>Note:</p> <p>The hierarchy entities and price items are sorted in the price item hierarchy based on their respective sort sequence.</p> <p>If two or more hierarchy entities and price items have the same sort sequence, then the system sorts them in the ascending alphabetical order of the information string.</p> <p>Also, if the sort sequence is not defined for the hierarchy entities and price items, then the system sorts them in the ascending alphabetical order of the information string.</p>
Parameters	Indicates the parameters using which the pricing for the price item is defined.
Start Date	Displays the date from when the price item pricing is effective.

Column Name	Column Description
	<p>Note:</p> <p>This column appears only when you define a seasonal pricing for the price item.</p> <p>The Expand or Collapse () icon appears in the Start Date column corresponding to the proposed pricing of the price item.</p> <p>On clicking the Expand or Collapse icon, you can view the row for seasonal pricing of the price item.</p>
End Date	<p>Displays the date till when the price item pricing is effective.</p> <p>Note: This column appears only when you define a seasonal pricing for the price item.</p>
Pricing Information	<p>Displays the concatenated string of information about the proposed, original, recommended, and changed price item pricing separated by a comma (,).</p> <p>Note:</p> <p>It has a link. On clicking the link, the Pricing and Commitments screen appears where you can view the details of the original and proposed price item pricing.</p> <p>The Delete () icon appears in the Pricing Information column corresponding to the proposed, seasonal, and recommended pricing of the price item. On clicking the Delete icon, you can delete the proposed, seasonal, and recommended pricing of the price item.</p> <p>The Delete icon appears corresponding to the proposed pricing only when its price assignment level is different from the price assignment level of the original pricing.</p> <p>The recommended pricing of the price item can only be deleted by the approver who has recommended the new price for the price item.</p> <p>The Expand or Collapse () icon appears in the Pricing Information column corresponding to the proposed pricing of the price item.</p> <p>On clicking the Expand or Collapse icon, you can view the row for original pricing of the price item.</p> <p>You can also edit or override the proposed pricing of the price item through this screen.</p> <p>You can directly change the rate of a price item from this screen when there is only one price component in the pricing and the pricing is negotiable for the price item.</p>
Average Price	<p>Displays the average proposed, original, and recommended cost of the price item as per the proposed, original, and recommended commitments respectively. It is calculated using the following formula:</p> <p>Avg. Price = Proposed Revenue/Proposed Usage</p> <p>Avg. Price = Original Revenue/Original Usage</p>

Column Name	Column Description
	Avg. Price = Recommended Revenue/Recommended Usage
Volume	<p>On clicking the Edit  icon corresponding to a price item, the Pricing and Commitments screen appears where you can view the original and proposed commitments of the price item. Whereas, on clicking the View icon () corresponding to a hierarchy entity, the Pricing and Commitments screen appears where you can view the original and proposed commitments of the price item at the hierarchy entity level.</p> <p>Note: You can directly change the proposed commitment of a price item when there is only one SQI used in the SQI-based billable charges.</p>
Revenue	Displays the proposed, original, and recommended revenue generated from the proposed, original, and recommended price item pricing and commitments respectively.
Revenue Variation (%)	<p>Displays the variation between the original, proposed, and recommended revenue in percentage generated from the original, proposed, and recommended pricing of the price item. It is calculated using the following formula:</p> $\text{Revenue Variation (\%)} = (\text{Proposed Revenue} - \text{Original Revenue}) * 100 / \text{Original Revenue}.$
Cost	Displays the proposed, original, and recommended cost of the price item based on the proposed, original, and recommended usage.
Price List Information	Indicates the price list from where the proposed and original pricing of the price item is derived for the person or account in the customer hierarchy.
Assignment Level	<p>Indicates the level at which the proposed and original pricing of the price item is defined in the customer hierarchy. The valid values are:</p> <ul style="list-style-type: none"> • Account Agreed - Indicates whether the price item pricing is agreed for the account. • Account Inherited Price List - Indicates whether the price item pricing is inherited from the parent price list hierarchy defined for the price list which is assigned to the account. • Account Price List - Indicates whether the price item pricing is defined in the price list which is assigned to the account. • Bundle Pricing - Indicates whether the price item pricing is defined for the bundle which is available for the retail banking. • Customer Agreed - Indicates whether the price item pricing is agreed for the customer in the customer hierarchy. • Customer Inherited Price List - Indicates whether the price item pricing is inherited from the parent price list hierarchy defined for the price list which is assigned to the customer. • Customer Price List - Indicates whether the price item pricing is defined in the price list which is assigned to the customer. • Default Price List - Indicates whether the price item pricing defined in the price list is available in the default price list.

Column Name	Column Description
	<ul style="list-style-type: none"> • Global Price List - Indicates whether the price item pricing defined in the price list is available in the global price list. • Market Product Pricing - Indicates whether the price item pricing is defined for the market product which is available for the retail banking. • Offer Pricing - Indicates whether the price item pricing is defined for the offer which is available for the retail banking. • Parent Customer Agreed - Indicates whether the price item pricing is agreed for the parent customer in the customer hierarchy. • Parent Customer Inherited Price List - Indicates whether the price item pricing is inherited from the parent price list hierarchy defined for the price list which is assigned to the parent customer. • Parent Customer Price List - Indicates whether the price item pricing is defined in the price list which is assigned to the parent customer. • Price List - Indicates whether the price item pricing is defined in the price list. • Product Pricing - Indicates whether the price item pricing defined in the price list is available for the product pricing.
Status	Indicates the current approval status of the price item pricing and commitments.
Approver	Indicates the user who has approved the price item pricing and commitments.
Terms and Conditions	On clicking the Edit  icon, the Mapping Terms and Conditions screen appears where you can view or delete the deal-specific terms and conditions associated with the price item.

Note:

In addition, a check box appears corresponding to the price item which is assigned to the user for approval.

By default, you can view the proposed and recommended pricing details of the price item in the price item hierarchy table. To view or hide the original pricing details of the price item, click the **Original Data** toggle switch available in the **Pricing and Commitments** section.

By default, the price item pricing details are displayed in the deal currency. You can view the price item pricing details in the division currency by clicking the **Currency** toggle switch available in the **Pricing and Commitments** section.

In addition, the **Pricing and Commitments** section contains the following buttons:

Button Name	Button Description
Send Price Items for Approval	On clicking the Send Price Items for Approval button, the status of the price item is changed to Assigned to Price Item Manager .

Button Name	Button Description
	<p>Note: An approver can send a price item for approval when the following conditions are met:</p> <ul style="list-style-type: none"> • The price item is assigned to the approver for approval • The Propose Pricing option is set to Yes in the Deal Approval Profile for the approver • The Submit Price Item for Approval option is set to Yes in the Deal Approval Profile for the approver
Check Limits	<p>On clicking the Check Limits button the system verifies whether the average price of the price item falls within the floor and ceil values defined for the approver in the price item screen.</p> <p>Note:</p> <p>If the average price falls within the floor and ceil values defined for the approver, then the status of the price item is changed to Approved.</p> <p>If the average price does not fall within the floor and ceil values defined for the approver, then the status of the price item is changed to Pending For Approval.</p>

Related Topics

For more information on...	See...
How to view the original and proposed commitments of a price item	Viewing the Original and Proposed Commitments of a Price Item on page 2946
How to view the original and proposed pricing of a price item	Viewing the Original and Proposed Pricing of a Price Item on page 2947
How to view the original pricing and commitments of a person or an account	Viewing the Original Pricing and Commitments of a Person or an Account on page 2946
How to view the pricing and commitments of a person in the division currency	Viewing the Pricing and Commitments of a Person in the Division Currency on page 2944
How to view the pricing and commitments of an account in the account's invoice currency	Viewing the Pricing and Commitments of an Account in the Account's Invoice Currency on page 2945
How to recommend a new pricing for a price item	Recommending a New Pricing for a Price Item on page 2955
How to approve pricing of a price item	Approving Pricing of a Price Item on page 2948
How to submit a price item for approval	Submitting a Price Item for an Approval on page 2949
How to recommend a new pricing for a price item	Recommending a New Pricing for a Price Item on page 2955
How to view the deal-specific terms and conditions of a price item or a hierarchy entity	Viewing the Deal-Specific Terms and Conditions of a Price Item or a Hierarchy Entity on page 2967
How to edit the deal-specific terms and conditions of a price item or a hierarchy entity	Editing the Deal-Specific Terms and Conditions of a Price Item or a Hierarchy Entity on page 2966

Viewing the Pass Through Charge Information of an Account

Procedure

To view the pass through charge information of an account:

1. Search for the deal in the **Search Deal** zone of the **Deal Dashboard** screen.
2. In the **Search Results** section, click the link in the **Deal Information** column corresponding to the deal whose accounts pass through charge information you want to view.
The **Deal Information** screen appears.
3. Ensure that the **Customer Hierarchy** section is expanded in the **Simulation Details** zone.
4. Click the **Edit** (✎) icon in the **Pricing and Commitments** column corresponding to the account whose pass through charge information you want to view.
The **Pricing and Commitments** screen appears.
5. Ensure that the **Pass Through Charge Information** section is expanded in the **Pricing and Commitments** screen.
6. View the pass through charge information of the account in the **Pass Through Charge Information** section.

Related Topics

For more information on...	See...
How to search for a deal	Searching for a Deal on page 2773
Search Deal zone	Search Deal on page 2758
Deal Dashboard screen	Deal Dashboard on page 2757
Deal Information screen	Deal Information on page 2815
Simulation Details zone	Simulation Details on page 2847
Pricing and Commitments screen	Pricing and Commitments on page 2934
Pass Through Charge Information section	Pass Through Charge Information on page 2935

Viewing the Product Financial Summary of a Person or an Account

Procedure

To view the product financial summary of a person or an account:

1. Search for the deal in the **Search Deal** zone of the **Deal Dashboard** screen.
2. In the **Search Results** section, click the link in the **Deal Information** column corresponding to the deal whose persons or accounts product financial summary you want to view.
The **Deal Information** screen appears.
3. Ensure that the **Customer Hierarchy** section is expanded in the **Simulation Details** zone.
4. Click the **Edit** (✎) icon in the **Pricing and Commitments** column corresponding to the person or account whose product financial summary you want to view.
The **Pricing and Commitments** screen appears.
5. Ensure that the **Product Financial Summary** section is expanded in the **Pricing and Commitments** screen.
6. View the product financial summary of the person or account in the **Product Financial Summary** section.

Related Topics

For more information on...	See...
How to search for a deal	Searching for a Deal on page 2773

For more information on...	See...
Search Deal zone	Search Deal on page 2758
Deal Dashboard screen	Deal Dashboard on page 2757
Deal Information screen	Deal Information on page 2815
Simulation Details zone	Simulation Details on page 2847
Pricing and Commitments screen	Pricing and Commitments on page 2934
Product Financial Summary section	Product Financial Summary on page 2935

Filtering the Pricing of a Person or an Account

Procedure

To filter the pricing of a person or an account:

1. Search for the deal in the **Search Deal** zone of the **Deal Dashboard** screen.
2. In the **Search Results** section, click the link in the **Deal Information** column corresponding to the deal whose persons or accounts pricing you want to filter.
The **Deal Information** screen appears.
3. Ensure that the **Customer Hierarchy** section is expanded in the **Simulation Details** zone.
4. Click the **Edit** (✎) icon in the **Pricing and Commitments** column corresponding to the person or account whose pricing you want to filter.
The **Pricing and Commitments** screen appears.
5. Ensure that the **Filters** section is expanded in the **Pricing and Commitments** screen.
The **Filters** section contains the following fields:

Field Name	Field Description
Search	Used to search for the pricing and commitments of a price item associated with a person or account using a specific search criteria.
Effective Date	Used to search for price items pricing whose effective date is later than the deal start date.

In addition, the **Filters** section contains the following buttons:

Button Name	Button Description
Search	Used to search for price item pricing as per the criteria specified in the Search or Effective Date fields.
Show All Pricing	Used to show all the pricing and commitments of the price items associated with the person or account in the customer hierarchy.
Show Customer or Account Level Pricing	Used to filter customer agreed or account agreed price item pricing for the person or account in the customer hierarchy.
Show Changed Data	Used to display the following for the existing customer, account, or prospect: <ul style="list-style-type: none"> • Agreed pricing of a price item assigned to the customer, account, or prospect in the deal

Button Name	Button Description
	<ul style="list-style-type: none"> Seasonal pricing of a price item assigned to the customer, account, or prospect in the deal Proposed pricing of a price item from the price list with higher priority when the pricing is inherited from two or more price lists assigned to the customer, account, or prospect Proposed pricing of a price item which is edited in the deal Price item pricing whose default or reference commitments are edited in the deal Price item pricing for which commitments are added in the deal from the Pricing and Commitments screen Price item pricing where there is difference between original and proposed cost Price item pricing where there is difference between original and proposed average price Price item pricing where there is difference between original and proposed revenue

6. Enter the required details in the **Filters** section.

7. Click **Search**.

The pricing of the person or the account is filtered in the **Pricing and Commitments** section.

Related Topics

For more information on...	See...
How to search for a deal	Searching for a Deal on page 2773
Search Deal zone	Search Deal on page 2758
Deal Dashboard screen	Deal Dashboard on page 2757
Deal Information screen	Deal Information on page 2815
Simulation Details zone	Simulation Details on page 2847
Pricing and Commitments screen	Pricing and Commitments on page 2934
Filters section	Filters on page 2935
Pricing and Commitments section	Pricing and Commitments on page 2936

Viewing the Pricing and Commitments of a Person in the Division Currency

Procedure

To view the pricing and commitments of a person in the division currency:

1. Search for the deal in the **Search Deal** zone of the **Deal Dashboard** screen.
2. In the **Search Results** section, click the link in the **Deal Information** column corresponding to the deal whose persons pricing and commitments you want to view in the division currency.
The **Deal Information** screen appears.
3. Ensure that the **Customer Hierarchy** section is expanded in the **Simulation Details** zone.

4. Click the **Edit** (✎) icon in the **Pricing and Commitments** column corresponding to the person whose pricing and commitments you want to view in the division currency.
The **Pricing and Commitments** screen appears.
5. Ensure that the **Pricing and Commitments** section is expanded in the **Pricing and Commitments** screen.
6. Ensure that the **Price Item Hierarchy** is expanded in the **Pricing and Commitments** section.
7. Click the toggle switch available in the **Pricing and Commitments** section towards the **Customer Division Currency** option.
The pricing and commitments of the person appears in the division currency.

Note: By default the pricing and commitments of the person appears in the deal currency.

Related Topics

For more information on...	See...
How to search for a deal	Searching for a Deal on page 2773
Search Deal zone	Search Deal on page 2758
Deal Dashboard screen	Deal Dashboard on page 2757
Deal Information screen	Deal Information on page 2815
Simulation Details zone	Simulation Details on page 2847
Pricing and Commitments screen	Pricing and Commitments on page 2934
Pricing and Commitments section	Pricing and Commitments on page 2936

Viewing the Pricing and Commitments of an Account in the Account's Invoice Currency

Procedure

To view the pricing and commitments of an account in the account's invoice currency:

1. Search for the deal in the **Search Deal** zone of the **Deal Dashboard** screen.
2. In the **Search Results** section, click the link in the **Deal Information** column corresponding to the deal whose accounts pricing and commitments you want to view in the account's invoice currency.
The **Deal Information** screen appears.
3. Ensure that the **Customer Hierarchy** section is expanded in the **Simulation Details** zone.
4. Click the **Edit** (✎) icon in the **Pricing and Commitments** column corresponding to the account whose pricing and commitments you want to view in the account's invoice currency.
The **Pricing and Commitments** screen appears.
5. Ensure that the **Pricing and Commitments** section is expanded in the **Pricing and Commitments** screen.
6. Ensure that the **Price Item Hierarchy** is expanded in the **Pricing and Commitments** section.
7. Click the toggle switch available in the **Pricing and Commitments** section towards the **Account Currency** option.
The pricing and commitments of the person appears in the account's invoice currency.

Note: By default the pricing and commitments of the account appears in the deal currency.

Related Topics

For more information on...	See...
How to search for a deal	Searching for a Deal on page 2773
Search Deal zone	Search Deal on page 2758
Deal Dashboard screen	Deal Dashboard on page 2757
Deal Information screen	Deal Information on page 2815
Simulation Details zone	Simulation Details on page 2847
Pricing and Commitments screen	Pricing and Commitments on page 2934
Pricing and Commitments section	Pricing and Commitments on page 2936

Viewing the Original Pricing and Commitments of a Person or an Account

Procedure

To view the original pricing and commitments of a person or an account:

1. Search for the deal in the **Search Deal** zone of the **Deal Dashboard** screen.
2. In the **Search Results** section, click the link in the **Deal Information** column corresponding to the deal whose persons or accounts original pricing and commitments you want to view.
The **Deal Information** screen appears.
3. Ensure that the **Customer Hierarchy** section is expanded in the **Simulation Details** zone.
4. Click the **Edit**  icon in the **Pricing and Commitments** column corresponding to the person or account whose original pricing and commitments you want to view.
The **Pricing and Commitments** screen appears.
5. Ensure that the **Pricing and Commitments** section is expanded in the **Pricing and Commitments** screen.
6. Ensure that the **Price Item Hierarchy** is expanded in the **Pricing and Commitments** section.
7. Click the toggle switch corresponding to the **Original Data** field available in the **Pricing and Commitments** section towards the **Show** option.
The original pricing and commitments of the person or account appears in the **Pricing and Commitments** section.
8. View the original pricing and commitments of the person or account in the **Pricing and Commitments** section.

Related Topics

For more information on...	See...
How to search for a deal	Searching for a Deal on page 2773
Search Deal zone	Search Deal on page 2758
Deal Dashboard screen	Deal Dashboard on page 2757
Deal Information screen	Deal Information on page 2815
Simulation Details zone	Simulation Details on page 2847
Pricing and Commitments screen	Pricing and Commitments on page 2934
Pricing and Commitments section	Pricing and Commitments on page 2936

Viewing the Original and Proposed Commitments of a Price Item

Procedure

To view the original and proposed commitments of a price item:

1. Search for the deal in the **Search Deal** zone of the **Deal Dashboard** screen.
2. In the **Search Results** section, click the link in the **Deal Information** column corresponding to the deal.
The **Deal Information** screen appears.
3. Ensure that the **Customer Hierarchy** section is expanded in the **Simulation Details** zone.
4. Click the **Edit** (✎) icon in the **Pricing and Commitments** column corresponding to the person or account whose price items original and proposed commitments you want to view.
The **Pricing and Commitments** screen appears.
5. Ensure that the **Pricing and Commitments** section is expanded in the **Pricing and Commitments** screen.
6. Ensure that the **Price Item Hierarchy** is expanded in the **Pricing and Commitments** section.
7. Click the **Edit** (✎) icon in the **Commitments** column corresponding to the price item whose original and proposed commitments you want to view.
The **Pricing and Commitments** screen appears.
8. View the original and proposed commitments of the price item in the **Pricing and Commitments** screen.

Related Topics

For more information on...	See...
How to search for a deal	Searching for a Deal on page 2773
Search Deal zone	Search Deal on page 2758
Deal Dashboard screen	Deal Dashboard on page 2757
Deal Information screen	Deal Information on page 2815
Simulation Details zone	Simulation Details on page 2847
Pricing and Commitments screen	Pricing and Commitments on page 2934
Pricing and Commitments section	Pricing and Commitments on page 2936

Viewing the Original and Proposed Pricing of a Price Item

Procedure

To view the original and proposed pricing of a price item:

1. Search for the deal in the **Search Deal** zone of the **Deal Dashboard** screen.
2. In the **Search Results** section, click the link in the **Deal Information** column corresponding to the deal.
The **Deal Information** screen appears.
3. Ensure that the **Customer Hierarchy** section is expanded in the **Simulation Details** zone.
4. Click the **Edit** (✎) icon in the **Pricing and Commitments** column corresponding to the person or account whose price items original and proposed pricing you want to view.
The **Pricing and Commitments** screen appears.
5. Ensure that the **Pricing and Commitments** section is expanded in the **Pricing and Commitments** screen.
6. Ensure that the **Price Item Hierarchy** is expanded in the **Pricing and Commitments** section.
7. Click the link in the **Pricing Information** column corresponding to the price item whose original and proposed pricing you want to view.

The **Pricing and Commitments** screen appears.

- View the original and proposed pricing of the price item in the **Pricing and Commitments** screen.

Related Topics

For more information on...	See...
How to search for a deal	Searching for a Deal on page 2773
Search Deal zone	Search Deal on page 2758
Deal Dashboard screen	Deal Dashboard on page 2757
Deal Information screen	Deal Information on page 2815
Simulation Details zone	Simulation Details on page 2847
Pricing and Commitments screen	Pricing and Commitments on page 2934
Pricing and Commitments section	Pricing and Commitments on page 2936

Approving Pricing of a Price Item

Procedure

To approve a price item in a deal:

- In the **Simulation Details** zone, click the **Edit** (✎) icon in the **Pricing and Commitments** column corresponding to the person or account whose price item pricing you want to approve.

The **Pricing and Commitments** screen appears.

- In the **Pricing and Commitments** section, ensure that the **Price Item Hierarchy** sub-section is expanded when you are approving the pricing of a price item.
- Click the check box corresponding to the price item that you want to approve for the deal.

Note:

The check box appears when the price item is assigned to the user for approval.

You can select multiple price items at a time for approving.

The **Check Limits** button is activated.

- Click the **Check Limits** button.

A message appears confirming the approval status of the price item.

- Click **OK**

The price item is approved for the deal.

Note:

The price item can be approved by the approver when the average price of the price item falls within the floor and ceil values defined for the approver in the price item screen.

If the average price of the price item falls within the floor and ceil values defined for the approver, then the status of the price item is changed to **Approved**.

If the average price of the price item does not fall within the floor and ceil values defined for the approver, then the status of the price item is changed to **Pending For Approval**.

Related Topics

For more information on...	See...
How to search for a deal	Searching for a Deal on page 2773
Deal Dashboard screen	Deal Dashboard on page 2757
Search Deal zone	Search Deal on page 2758
Simulation Details zone	Simulation Details on page 2847
Pricing and Commitments screen	Pricing and Commitments on page 2934
Pricing and Commitments section	Pricing and Commitments on page 2936

Submitting a Price Item for an Approval**Procedure**

To submit a price item for an approval:

1. In the **Simulation Details** zone, click the **Edit** (✎) icon in the **Pricing and Commitments** column corresponding to the person or account whose price item you want to send for an approval.
The **Pricing and Commitments** screen appears.
2. In the **Pricing and Commitments** section, ensure that the **Price Item Hierarchy** sub-section is expanded when you are sending a price item for an approval.
3. Click the check box corresponding to the price item which you want to send for an approval.

Note:

The check box appears when the price item is assigned to the user for an approval.

You can select multiple price items at a time to submit for an approval.

The **Send Price Items for Approval** button is activated.

4. Click the **Send Price Items for Approval** button.
A message appears confirming the price item is sent for an approval.
5. Click **OK**
The price item is sent for an approval and the status of the price item is changed to **Assigned to Price Item Manager**.

Related Topics





For more information on...	See...
How to search for a deal	Searching for a Deal on page 2773
Deal Dashboard screen	Deal Dashboard on page 2757
Search Deal zone	Search Deal on page 2758
Simulation Details zone	Simulation Details on page 2847
Pricing and Commitments screen	Pricing and Commitments on page 2934
Pricing and Commitments section	Pricing and Commitments on page 2936

Selecting a Price Item or Hierarchy Entity

Procedure

To select a price item or hierarchy entity:

1. Do either of the following:

If you want to...	Then...
<p>Select a price item or hierarchy entity from the Deal Information screen</p>	<ol style="list-style-type: none"> 1. Search for the deal in the Search Deal zone of the Deal Dashboard screen. 2. In the Search Results section, click the Broadcast () icon corresponding to the deal for which you want to select the price item or hierarchy entity. The Deal Versions zone appears. 3. In the Deal Versions zone, click the deal version in the Deal Version Information column for which you want to select the price item or hierarchy entity. The Deal Information screen appears. 4. Ensure that the customer hierarchy is expanded in the Simulation Details zone. 5. Click the Edit () icon in the Price Item Group Selection column corresponding to the main person of the customer hierarchy.
<p>Select a price item or hierarchy entity from the Pricing and Commitments screen</p>	<ol style="list-style-type: none"> 1. Ensure that the customer hierarchy is expanded in the Simulation Details zone. 2. Click the Edit () icon in the Pricing and Commitments column corresponding to the person or account for which you want to select the price item or hierarchy entity. The Pricing and Commitments screen appears. 3. Click the Select Price Item Group button available in the header area of the Pricing and Commitments screen.
<p>Select a price item or hierarchy entity from the Price List Assignment screen</p>	<ol style="list-style-type: none"> 1. Ensure that the customer hierarchy is expanded in the Simulation Details zone. 2. Click the Edit () icon in the Price List Assignment column corresponding to the person or account for whose price list you want to select the price item or hierarchy entity. The Price List Assignment screen appears.

If you want to...	Then...
	<p data-bbox="846 201 1390 327">3. In the Proposed Price Lists zone, click the link in the Price List Information column corresponding to price list whose price item or hierarchy entity you want to select.</p> <div data-bbox="875 348 1390 520" style="border: 1px solid black; padding: 5px;"> <p data-bbox="881 354 1383 512">Note: You can also search for a price list that you want to assign to the person or account in the Assign Price List zone of the Price List Assignment screen and then select the required price item or hierarchy entity.</p> </div> <p data-bbox="846 548 1390 611">4. Click the Save and Select Price Item Group button.</p>

The **Select Price Item Group** screen appears. It contains the following sections:

- **Filters** - Used to filter the price assignment in the price item hierarchy which you want to consider while simulating the deal. It contains the following fields:

Field Name	Field Description
Search	Used to search for a particular price item, root level hierarchy entity, or non-root level hierarchy entity in the customer hierarchy.
Assignment Level	<p data-bbox="738 940 1463 1003">Used to search for price items in the price item hierarchy whose price assignment is defined at a particular level. The valid values are:</p> <ul data-bbox="768 1024 1463 1892" style="list-style-type: none"> • Account Agreed - Used to indicate whether the price item pricing is agreed for the account. • Account Inherited Price List - Used to indicate whether the price item pricing is inherited from the parent price list hierarchy defined for the price list which is assigned to the account. • Account Price List - Used to indicate whether the price item pricing is defined in the price list which is assigned to the account. • Bundle Pricing - Used to indicate whether the price item pricing is defined for the bundle which is available for the retail banking. • Customer Agreed - Used to indicate whether the price item pricing is agreed for the customer in the customer hierarchy. • Customer Inherited Price List - Used to indicate whether the price item pricing is inherited from the parent price list hierarchy defined for the price list which is assigned to the customer. • Customer Price List - Used to indicate whether the price item pricing is defined in the price list which is assigned to the customer. • Default Price List - Used to indicate whether the price item pricing defined in the price list is available in the default price list.

Field Name	Field Description
	<ul style="list-style-type: none"> • Global Price List - Used to indicate whether the price item pricing defined in the price list is available in the global price list. • Market Product Pricing - Used to indicate whether the price item pricing is defined for the market product which is available for the retail banking. • Offer Pricing - Used to indicate whether the price item pricing is defined for the offer which is available for the retail banking. • Parent Customer Agreed - Used to indicate whether the price item pricing is agreed for the parent customer in the customer hierarchy. • Parent Customer Inherited Price List - Used to indicate whether the price item pricing is inherited from the parent price list hierarchy defined for the price list which is assigned to the parent customer. • Parent Customer Price List - Used to indicate whether the price item pricing is defined in the price list which is assigned to the parent customer. • Price List - Used to indicate whether the price item pricing is defined in the price list. • Product Pricing - Used to indicate whether the price item pricing defined in the price list is available for the product pricing.

- **Price Item Group** - Displays the price item hierarchy. It contains the following columns:

Column Name	Column Description
Price Item Hierarchy	<p>Displays the price items, root level hierarchy entities, and non-root level hierarchy entities in the price item hierarchy which you can select for simulating the deal.</p> <p>Note:</p> <p>A check box appears corresponding to the price items and the hierarchy entities which you can select to include the respective price assignments for deal simulation.</p> <p>The hierarchy entities and price items are sorted in the price item hierarchy based on their respective sort sequence. If two or more hierarchy entities and price items have the same sort sequence, then the system sorts them in the ascending alphabetical order of the information string. Also, if the sort sequence is not defined for the hierarchy entities and price items, then the system sorts them in the ascending alphabetical order of the information string.</p> <p>Similarly, the system sorts the hierarchy entities and price items in the price item hierarchy when the deal information is extracted in the Excel or PDF format for internal or external use.</p>
Parameter	Displays the comma separated parameters using which the pricing of the price item is determined.

Column Name	Column Description
	<p>Note: All price assignments of a price item are sorted in the alphabetical order of the pricing information in the Parameter column.</p>
Assignment Level	<p>Displays the level at which the price assignment is defined for the price item. The valid values are:</p> <ul style="list-style-type: none"> • Account Agreed - Indicates whether the price item pricing is agreed for the account. • Account Inherited Price List - Indicates whether the price item pricing is inherited from the parent price list hierarchy defined for the price list which is assigned to the account. • Account Price List - Indicates whether the price item pricing is defined in the price list which is assigned to the account. • Bundle Pricing - Indicates whether the price item pricing is defined for the bundle which is available for the retail banking. • Customer Agreed - Indicates whether the price item pricing is agreed for the customer in the customer hierarchy. • Customer Inherited Price List - Indicates whether the price item pricing is inherited from the parent price list hierarchy defined for the price list which is assigned to the customer. • Customer Price List - Indicates whether the price item pricing is defined in the price list which is assigned to the customer. • Default Price List - Indicates whether the price item pricing defined in the price list is available in the default price list. • Global Price List - Indicates whether the price item pricing defined in the price list is available in the global price list. • Market Product Pricing - Indicates whether the price item pricing is defined for the market product which is available for the retail banking. • Offer Pricing - Indicates whether the price item pricing is defined for the offer which is available for the retail banking. • Parent Customer Agreed - Indicates whether the price item pricing is agreed for the parent customer in the customer hierarchy. • Parent Customer Inherited Price List - Indicates whether the price item pricing is inherited from the parent price list hierarchy defined for the price list which is assigned to the parent customer. • Parent Customer Price List - Indicates whether the price item pricing is defined in the price list which is assigned to the parent customer. • Price List - Indicates whether the price item pricing is defined in the price list. • Product Pricing - Indicates whether the price item pricing defined in the price list is available for the product pricing.

Note: The width of the columns in the **Price Item Group** section of the **Select Price Item Group** screen can now be resized and adjusted based on the requirement.

In addition, the **Price Item Group** section contains the following buttons:

Button Name	Button Description
Expand All	On clicking the Expand All button, all nodes in the price item hierarchy are expanded at once.
Collapse All	On clicking the Collapse All button, all nodes in the price item hierarchy are collapsed at once.
Select All	On clicking the Select All button, all the price items and the hierarchy entities in the price item hierarchy are selected i.e. the check box corresponding to each price item and hierarchy entity in the price item hierarchy is selected.
De-Select All	On clicking the De-Select All button, all the price items and the hierarchy entities in the price item hierarchy are de-selected i.e. the check box corresponding to each price item and hierarchy entity in the price item hierarchy is unchecked.
Save	On clicking the Save button, the price item selection made in the price item hierarchy is saved.
Save & View Pricing & Commitment	On clicking the Save & View Pricing & Commitment button, the price item selection made in the price item hierarchy is saved and the Pricing and Commitments screen appears.
Back	Used to access the previous screen.

2. Ensure that the price item hierarchy is expanded in the **Price Item Group** section.

Note:

The system, by default, selects the price items and hierarchy entities in the **Select Price Item Group** screen when the following conditions are met:

- Deal is created for an existing customer or account
- Default commitments are not defined in the respective deal type

However, if the deal is created for a proposed customer or if the default commitments are defined in the respective deal type, the system does not select the price items and hierarchy entities, by default, in the **Select Price Item Group** screen. You have to manually select the required price items and hierarchy entities in the **Select Price Item Group** screen. Only then, the system considers the pricing and commitments of the selected price items in the deal.

3. Select the check box corresponding to the price item or the hierarchy entity that you want to consider while simulating the deal.

Note: If you select a hierarchy entity, then all its corresponding non-root level hierarchy entities and price items are selected for the deal simulation.

4. Click **Save**.

The price item or hierarchy entity is selected.

Related Topics

For more information on...	See...
How to search for a deal	Searching for a Deal on page 2773

For more information on...	See...
Deal Dashboard screen	Deal Dashboard on page 2757
Search Deal zone	Search Deal on page 2758
Deal Information screen	Deal Information on page 2815
Simulation Details zone	Simulation Details on page 2847
Pricing and Commitments screen	Pricing and Commitments on page 2934
Price List Assignment screen	Price List Assignment on page 2979

Recommending a New Pricing for a Price Item

Procedure

To recommend a new pricing for a price item:

1. Ensure that the price item hierarchy is expanded in the **Pricing and Commitments** section of the **Pricing and Commitments** screen when you are recommending a new pricing for a price item of a person or account in a deal.
2. Click the **Recommend** link in the **Pricing Information** column corresponding to the price item for which you want to recommend a new pricing.

The **Pricing and Commitments** screen appears.

Note: The **Recommend** link appears in the **Pricing Information** column only when the **Propose Pricing** option is set to **Yes** for the user in the **Deal Approval Profile** associated with the **Deal Type** using which the deal is created in the system.

3. Ensure that the **Recommend Pricing** zone is expanded in the **Pricing and Commitments** screen.

The **Recommend Pricing** zone contains the following sections:

- **Main** - Used to specify basic details about the recommended price item pricing. It contains the following fields:

Field Name	Field Description	Mandatory (Yes or No)
Price Assignment ID	Displays the price assignment ID. Note: It is a read-only field and cannot be edited. A new price assignment ID is created automatically by the system when you recommend a new pricing for a price item.	Not Applicable
Price Item	Displays the price item whose pricing you want to edit. Note: It is a read-only field and cannot be edited.	Not Applicable
Start Date	Displays the date from when the pricing of the price item is effective for the deal.	Not Applicable
Price Assignment Type	Used to indicate the type of price assignment. The valid values are:	No

Field Name	Field Description	Mandatory (Yes or No)
	<ul style="list-style-type: none"> • Regular - Used to indicate that the pricing is used to generate regular bill segment. • Post Processing - Used to indicate that the pricing is used to generate post processing bill segment. This type of price assignment can be done on usage accounts. The post processing bill segment is generated when you generate the bill for the usage account and not when you bill the usage account through an invoice account. <div style="border: 1px solid black; padding: 5px; margin: 5px 0;"> <p>Note: The post processing bill segment is generated when the Post Processing Sequence (PPSEQ) characteristic is defined for the price item and when the price item is associated with another price item using the Price Item Relationship Type.</p> </div> <ul style="list-style-type: none"> • Post Processing – Invoice Based - Used to indicate that the pricing is used to generate post processing bill segment. This type of price assignment can be done on an invoice account, and, as a result, the post processing bill segment is generated on the invoice account. <div style="border: 1px solid black; padding: 5px; margin: 5px 0;"> <p>Note: This is not applicable for price items whose Price Item Usage field is set to Pricing.</p> </div> <ul style="list-style-type: none"> • Post Processing – Price Item Based - Used to indicate that the pricing is used to generate post processing bill segment. This type of price assignment can be done on both invoice and usage accounts, but the post processing bill segment is generated only on the invoice account. <div style="border: 1px solid black; padding: 5px; margin: 5px 0;"> <p>Note: This field is not applicable for price items whose Price Item Usage field is set to Pricing.</p> </div>	
End Date	Displays the date till when the pricing of the price item is effective for the deal.	Not Applicable
Pricing Currency	Used to indicate the currency in which you want to define the pricing of the price item.	No
Pricing Eligibility	Used to define the pricing eligibility criteria for the price item pricing.	No

Field Name	Field Description	Mandatory (Yes or No)
	<p>Note: If you select the check box you can define the pricing eligibility of the price item in the Price Component section of this zone.</p>	
Print Zero	<p>Used to indicate whether zero pricing should be displayed in the bill. The valid values are:</p> <ul style="list-style-type: none"> • Yes • No 	No
Rate Schedule	<p>Used to specify the rate schedule that you want to use while defining price item pricing.</p> <p>Note: Rate schedules control how the bills for the price item will be calculated.</p> <p>The Search (🔍) icon appears corresponding to this field. On clicking the Search icon, the Rate Schedule Search window appears where you can search for the respective rate schedule.</p>	No

- **TFM Information** - Used to map the transaction details with the price item. It contains the following fields:

Field Name	Field Description	Mandatory (Yes or No)
Transaction Rating Criteria	<p>Used to indicate how and when the transaction legs mapped to the price item are rated. The valid values are:</p> <ul style="list-style-type: none"> • Aggregate Transactions and Then Rate Aggregated SQs • Do Not Rate Transactions • Rate Transaction and Aggregate Calc Lines Across Transaction • Rate Transactions 	No
Aggregation Schedule	<p>Used to indicate the transaction aggregation cycle. The valid values are:</p> <ul style="list-style-type: none"> • Daily • Weekly • Monthly • Quarterly • Yearly 	No
Do Not Aggregate Switch	<p>Used to Indicate whether aggregation is required while rating the transactions before billing. The valid values are:</p>	No

Field Name	Field Description	Mandatory (Yes or No)
	<ul style="list-style-type: none"> • Yes - Used to Indicate aggregation is not required while rating the transactions before billing. • No - Used to Indicate aggregation is required while rating the transactions before billing. 	
Ignore Transaction	Used to indicate whether the transactions mapped to the price item is considered for billing. The valid values are: <ul style="list-style-type: none"> • Yes • No 	No

- **Parameters** - Used to associate the parameters based on which you want to recommend the pricing of the price item. It contains the following columns:

Column Name	Column Description	Mandatory (Yes or No)
Parameter	Used to indicate the parameter that you want to associate with the price item pricing. <div style="border: 1px solid black; padding: 5px;"> <p>Note:</p> <p>The Search (🔍) icon appears corresponding to this field. On clicking the Search icon, the Price Item Parameter Search window appears.</p> <p>The parameter search results displays only those parameters where the Price Item check box is selected.</p> </div>	No
Parameter Value	Used to specify the value of the parameter.	No







- **Characteristics** - Used to define a list of characteristics for the recommended price item pricing. It contains the following columns:

Column Name	Column Description	Mandatory (Yes or No)
Effective Date	Used to specify the date from when the characteristic is effective for price item pricing.	No
Characteristic Type	Used to indicate the characteristic type. <div style="border: 1px solid black; padding: 5px;"> <p>Note: The list includes only those characteristic types where the characteristic entity is set to Projected Pricing.</p> </div>	No
Characteristic Value	Used to specify the value for the characteristic type.	No

Column Name	Column Description	Mandatory (Yes or No)
	<p>Note:</p> <p>If you select a predefined characteristic type, the Search (🔍) icon appears corresponding to the Characteristic Value field. On clicking the Search icon, the Predefined Characteristic Search window appears.</p> <p>On specifying the value for a predefined characteristic type, the description of the characteristic value appears corresponding to the Characteristic Value field.</p>	

- **Price Component** - Used to define a list of price components of the rate component that you want to map with the recommended price item pricing. It contains the following columns:

Column Name	Column Description	Mandatory (Yes or No)
Rate Component	<p>Displays the concatenated string of information about the rate component separated by comma (,).</p> <p>Note:</p> <p>It is a read-only field and cannot be edited.</p> <p>This ID is generated automatically when you define the tiering setup of the rate component.</p>	Not applicable
Display Sequence	Used to specify the sequence of price component whose rate is used for calculating the pricing of the price item.	No
Description	Used to specify the description of the price component.	No
Show Price Component	Used to indicate whether you want to display the price component in the bill.	No
Rate	Used to specify the rate defined for the price component.	Yes
Eligibility and Tier Details	Used to specify the tiering criteria and eligibility criteria of the price component for the price item pricing.	No
Tier Details	On clicking the Add (+) icon, you can view and edit the Tiering Criteria of the price component for the price item pricing. It contains the following columns:	No

Column Name	Column Description	Mandatory (Yes or No)										
	<table border="1"> <thead> <tr> <th>Column Name</th> <th>Column Description</th> </tr> </thead> <tbody> <tr> <td>Display Sequence</td> <td>Used to specify the sequence of the tiering criteria.</td> </tr> <tr> <td>Tiering Criterion</td> <td>Used to indicate the tiering criteria.</td> </tr> <tr> <td>Lower Limit</td> <td>Used to specify the lower limit of the tiering range.</td> </tr> <tr> <td>Upper Limit</td> <td>Used to specify the upper limit of the tiering range.</td> </tr> </tbody> </table> <p>Note: You can edit the tiering criteria of a price component only when the Tiering Type of its rate component is STEP or THRESHOLD.</p>	Column Name	Column Description	Display Sequence	Used to specify the sequence of the tiering criteria.	Tiering Criterion	Used to indicate the tiering criteria.	Lower Limit	Used to specify the lower limit of the tiering range.	Upper Limit	Used to specify the upper limit of the tiering range.	
Column Name	Column Description											
Display Sequence	Used to specify the sequence of the tiering criteria.											
Tiering Criterion	Used to indicate the tiering criteria.											
Lower Limit	Used to specify the lower limit of the tiering range.											
Upper Limit	Used to specify the upper limit of the tiering range.											
Eligibility Details	<p>On clicking the Add  icon, you can view and edit the eligibility criteria of the price component for the price item pricing. It contains the following columns:</p> <table border="1"> <thead> <tr> <th>Column Name</th> <th>Column Description</th> </tr> </thead> <tbody> <tr> <td>Display Sequence</td> <td>Used to specify the order in which the eligibility criteria should be executed in the rule.</td> </tr> <tr> <td>Parameter</td> <td>Used to indicate the left hand side parameter which you want to use along with the price item for price determination. <table border="1"> <tr> <td> <p>Note: The Search  icon appears corresponding to the Parameter field. On clicking the Search icon, the Parameter Search window appears.</p> </td> </tr> </table> </td> </tr> <tr> <td>Operator</td> <td>Used to specify the relational operator to define the relation between the left hand</td> </tr> </tbody> </table>	Column Name	Column Description	Display Sequence	Used to specify the order in which the eligibility criteria should be executed in the rule.	Parameter	Used to indicate the left hand side parameter which you want to use along with the price item for price determination. <table border="1"> <tr> <td> <p>Note: The Search  icon appears corresponding to the Parameter field. On clicking the Search icon, the Parameter Search window appears.</p> </td> </tr> </table>	<p>Note: The Search  icon appears corresponding to the Parameter field. On clicking the Search icon, the Parameter Search window appears.</p>	Operator	Used to specify the relational operator to define the relation between the left hand	No	
Column Name	Column Description											
Display Sequence	Used to specify the order in which the eligibility criteria should be executed in the rule.											
Parameter	Used to indicate the left hand side parameter which you want to use along with the price item for price determination. <table border="1"> <tr> <td> <p>Note: The Search  icon appears corresponding to the Parameter field. On clicking the Search icon, the Parameter Search window appears.</p> </td> </tr> </table>	<p>Note: The Search  icon appears corresponding to the Parameter field. On clicking the Search icon, the Parameter Search window appears.</p>										
<p>Note: The Search  icon appears corresponding to the Parameter field. On clicking the Search icon, the Parameter Search window appears.</p>												
Operator	Used to specify the relational operator to define the relation between the left hand											

Column Name	Column Description		Mandatory (Yes or No)
	Column Name	Column Description	
		side and right hand side parameters.	
	Parameter Value Type	Used to indicate the type of pricing eligibility. The valid values are: <ul style="list-style-type: none"> • Parameter - Used to indicate the type of parameter. • Value - Used to indicate the type of value. 	
	Parameter	Used to specify the value for the Parameter Value Type as the right hand side parameter which you want to use along with the price item for price determination. <div style="border: 1px solid black; padding: 5px; margin-top: 10px;"> <p>Note:</p> <p>If you select the Parameter Value Type as Parameter, the Search (🔍) icon appears corresponding to the Parameter field. On clicking the Search icon, the Parameter Search window appears.</p> <p>If you select the Parameter Value Type as Value then you can specify any special characters except ampersand (&), comma (,), underscore (_), equal to (=), tilde (~), and semi-colon (;) in the Parameter field.</p> </div>	
	Is True	Used to indicate what happens when the condition is true	

Column Name	Column Description		Mandatory (Yes or No)				
	<table border="1"> <thead> <tr> <th data-bbox="683 237 896 285">Column Name</th> <th data-bbox="896 237 1183 285">Column Description</th> </tr> </thead> <tbody> <tr> <td data-bbox="683 285 896 1110"></td> <td data-bbox="896 285 1183 1110"> <p>(satisfied). The valid values are:</p> <ul style="list-style-type: none"> • Check next condition - Used to indicate that the condition with the consecutive sequence number is executed. • Rule is false - Used to indicate that the action specified in the Rule False Action field is executed. • Rule is true - Used to indicate that the action specified in the Rule True Action field is executed. </td> </tr> </tbody> </table>	Column Name	Column Description		<p>(satisfied). The valid values are:</p> <ul style="list-style-type: none"> • Check next condition - Used to indicate that the condition with the consecutive sequence number is executed. • Rule is false - Used to indicate that the action specified in the Rule False Action field is executed. • Rule is true - Used to indicate that the action specified in the Rule True Action field is executed. 		
Column Name	Column Description						
	<p>(satisfied). The valid values are:</p> <ul style="list-style-type: none"> • Check next condition - Used to indicate that the condition with the consecutive sequence number is executed. • Rule is false - Used to indicate that the action specified in the Rule False Action field is executed. • Rule is true - Used to indicate that the action specified in the Rule True Action field is executed. 						
	Is False	<p>Used to indicate what happens when the condition is false (not satisfied). The valid values are:</p> <ul style="list-style-type: none"> • Check next condition - Used to indicate that the condition with the consecutive sequence number is executed. • Rule is false - Used to indicate that the action specified in the Rule False Action field is executed. • Rule is true - Used to indicate that the action specified 					

Column Name	Column Description		Mandatory (Yes or No)
	Column Name	Column Description	
		in the Rule True Action field is executed.	
	Is Insufficient	<p>Used to indicate what happens when the data is insufficient. The valid values are:</p> <ul style="list-style-type: none"> • Check next condition - Used to indicate that the condition with the consecutive sequence number is executed. • Rule is false - Used to indicate that the action specified in the Rule False Action field is executed. • Rule is true - Used to indicate that the action specified in the Rule True Action field is executed. 	
	<p>Note: You can edit the eligibility criteria of a price component only when the Pricing Eligibility check box is selected.</p>		

4. Enter the required details in the **Main** section.
5. Map the transaction details in the **TFM Information** section, if required.
6. Associate or disassociate parameters with the price item pricing in the **Pricing Parameter Information** section, if required.
7. Add, edit, or delete characteristics from the price item pricing in the **Characteristics** section, if required.
8. Define price component for the rate component associated with the price item pricing in the **Price Component** section, if required.
9. Click **Recommend**.

A new pricing is recommended for the price item.

Note: On recommending a new pricing for a price item, the **Delete** (🗑️) icon appears corresponding to the recommended pricing of the respective price item in the **Pricing and Commitments** zone of the **Pricing and Commitments** screen.

Related Topics

For more information on...	See...
Pricing and Commitments section	Pricing and Commitments on page 2936
Pricing and Commitments screen	Pricing and Commitments on page 2934

Associating Deal-Specific Terms and Conditions with a Price Item

Prerequisites

To associate deal-specific terms and conditions with a price item you should have:

- Terms and conditions defined in the application
- Terms and conditions mapped to the price item

Procedure

To associate deal-specific terms and conditions with a price item:

1. Ensure that the **Pricing and Commitments** zone is expanded when you are associating deal-specific terms and conditions with a price item of the **Pricing and Commitments** screen.
2. In the **Pricing and Commitments** zone, click the **Edit** (✎) icon in the **Terms and Conditions** column corresponding to the price item to which you want to associate deal-specific terms and conditions.

The **Terms and Conditions** screen appears. It contains the following field:

Field Name	Field Description
Price Item Information	Indicates the price item to which you want to associate deal-specific terms and conditions.

In addition, the **Terms and Conditions** screen contains the following sections:

- **Terms and Conditions Section** - Lists the terms and conditions that are mapped to the price item. It contains the following buttons:

Button Name	Button Description
Select All	Used to select all the available terms and conditions for the price item from the list.
De-select All	Used to de-select all the terms and conditions from the list.
Refresh Terms and Conditions	Used to de-select the terms and conditions that are selected for the price item from the list.

Note: You can also select or de-select the terms and conditions by clicking the check box corresponding to the respective terms and conditions.

On clicking the **Edit** (✎) icon corresponding to the terms and conditions in the **Terms and Conditions Section** section, you can view and edit the terms and conditions of the price item.

- **Adhoc Terms and Conditions** - Used to add deal-specific adhoc terms and conditions for the price item.
3. Select the required terms and conditions for the price item from the **Terms and Conditions Section** section.
 4. Click **Save**.

The deal-specific terms and conditions are associated with the price item.

Note: You can associate deal-specific terms and conditions with a price item until the deal is in the **Customer Accepted** or **Rejected** status.

Related Topics

For more information on...	See...
How to search for a deal	Searching for a Deal on page 2773
Deal Dashboard screen	Deal Dashboard on page 2757
Search Deal zone	Search Deal on page 2758
Simulation Details zone	Simulation Details on page 2847
Mapping Terms and Conditions screen	Mapping Terms and Conditions on page 3035

Associating Deal-Specific Terms and Conditions with a Hierarchy Entity

Prerequisites

To associate deal-specific terms and conditions with a hierarchy entity you should have:

- Terms and conditions defined in the application
- Terms and conditions mapped to the hierarchy entity

Procedure

To associate deal-specific terms and conditions with a hierarchy entity:

1. Ensure that the **Pricing and Commitments** zone is expanded when you are associating deal-specific terms and conditions with a hierarchy entity in the **Pricing and Commitments** screen.
2. In the **Pricing and Commitments** zone, click the **Edit**  icon in the **Terms and Conditions** column corresponding to the hierarchy entity to which you want to associate deal-specific terms and conditions.

The **Terms and Conditions** screen appears. It contains the following field:

Field Name	Field Description
Hierarchy Entity Information	Indicates the hierarchy entity to which you want to associate deal-specific terms and conditions.

In addition, the **Terms and Conditions** screen contains the following sections:

- **Terms and Conditions Section** - Lists the terms and conditions that are mapped to the hierarchy entity. It contains the following buttons:

Button Name	Button Description
Select All	Used to select all the available terms and conditions for the hierarchy entity from the list.
De-select All	Used to de-select all the terms and conditions from the list.

Button Name	Button Description
Refresh Terms and Conditions	Used to de-select the terms and conditions that are selected for the hierarchy entity from the list.

Note: You can also select or de-select the terms and conditions by clicking the check box corresponding to the respective terms and conditions.

On clicking the **Edit** (✎) icon corresponding to the terms and conditions in the **Terms and Conditions Section** section, you can view and edit the terms and conditions of the price item.

- **Adhoc Terms and Conditions** - Used to add deal-specific adhoc terms and conditions for the hierarchy entity.
3. Select the required terms and conditions for the hierarchy entity from the **Terms and Conditions Section** section.
 4. Click **Save**.

The deal-specific terms and conditions are associated with the hierarchy entity.

Note: You can associate deal-specific terms and conditions with a hierarchy entity until the deal is in the **Customer Accepted** or **Rejected** status.

Related Topics

For more information on...	See...
How to search for a deal	Searching for a Deal on page 2773
Deal Dashboard screen	Deal Dashboard on page 2757
Search Deal zone	Search Deal on page 2758
Simulation Details zone	Simulation Details on page 2847
Mapping Terms and Conditions screen	Mapping Terms and Conditions on page 3035

Editing the Deal-Specific Terms and Conditions of a Price Item or a Hierarchy Entity

Prerequisites

To edit the deal-specific terms and conditions of a price item or a hierarchy entity, you should have:

- Terms and conditions associated with the price item
- Terms and conditions associated with the hierarchy entity.

Procedure

To edit the deal-specific terms and conditions of a price item or a hierarchy entity:

1. Ensure that the **Pricing and Commitments** section is expanded in the **Pricing and Commitments** screen.
2. In the **Pricing and Commitments** section, click the **Edit** (✎) icon in the **Terms and Conditions** column corresponding to the price item or the hierarchy entity whose deal-specific terms and conditions you want to edit.

The **Terms and Conditions** screen appears.

3. Ensure that the **Terms and Conditions Section** section is expanded in the **Terms and Conditions** screen.
4. Click the **Edit** (✎) icon corresponding to the terms and conditions which you want to edit.

The **Terms and Conditions** window appears. It contains the following fields:

Field Name	Field Description
Terms and Conditions	Indicates the terms and conditions associated with the price item or the hierarchy entity.
Description	Displays the description of the terms and conditions.
Attached File Name	Indicates the terms and conditions document name.
Terms and Conditions Text	Displays the terms and conditions.

5. Click **Edit**.

The **Terms and Conditions Text** field is enabled.

6. Modify the required information from the terms and conditions in the **Terms and Conditions Text** field.

7. Click **Save**.

The changes made to the terms and conditions are saved.

Note: You can edit the terms and conditions of a price item or a hierarchy entity until the deal is in the **Customer Accepted** or **Rejected** status.

Related Topics

For more information on...	See...
Pricing and Commitments section	Pricing and Commitments on page 2936
Pricing and Commitments screen	Pricing and Commitments on page 2934
Terms and Conditions screen	Terms and Conditions on page 3038

Viewing the Deal-Specific Terms and Conditions of a Price Item or a Hierarchy Entity

Prerequisites

To view the deal-specific terms and conditions of a price item or a hierarchy entity, you should have:

- Terms and conditions associated with the price item
- Terms and conditions associated with the hierarchy entity.

Procedure

To view the deal-specific terms and conditions of a price item or a hierarchy entity:

1. Ensure that the **Pricing and Commitments** section is expanded in the **Pricing and Commitments** screen.
2. In the **Pricing and Commitments** section, click the **Edit** (✎) icon in the **Terms and Conditions** column corresponding to the price item or the hierarchy entity whose deal-specific terms and conditions you want to view.
The **Terms and Conditions** screen appears.
3. Ensure that the **Terms and Conditions Section** section is expanded in the **Terms and Conditions** screen.
4. Click the **Edit** (✎) icon corresponding to the terms and conditions which you want to view.
The **Terms and Conditions** window appears.
5. View the deal-specific terms and conditions of the price item or the hierarchy entity in the **Terms and Conditions Text** field of the **Terms and Conditions** window.

Related Topics

For more information on...	See...
Pricing and Commitments section	Pricing and Commitments on page 2936
Pricing and Commitments screen	Pricing and Commitments on page 2934
Terms and Conditions screen	Terms and Conditions on page 3038

Deal Pricing and Commitments

The **Deal Pricing and Commitments** screen allows you to view the original and proposed price item pricing and commitments along with the price item hierarchy and the hierarchy entity. It also allows you to edit the proposed pricing and commitments of the price items. It contains the following sections:

- **Deal Information** - Displays information about the deal version. It contains the following field:

Field Name	Field Description
Deal Version Information	Displays the concatenated string consisting of deal ID, deal version ID and deal description separated by a comma (,).

- **Search Pricing and Commitments** - Used to search pricing and commitments of a price item using various criteria. It contains the following fields in a grid:

Field Name	Field Description	Mandatory (Yes or No)
Search By	Used to indicate the criteria using which you want to search for the pricing and commitments of a price item. The valid values are: <ul style="list-style-type: none"> • Account - Used to indicate whether you want to search for the pricing and commitments of price items which belong to a particular account. • All - Used to indicate whether you want to view the pricing and commitments of all the price items in the deal. • Customer - Used to indicate whether you want to search for the pricing and commitments of price items which belong to a particular person. • Price Item - Used to indicate whether you want to search for the pricing and commitments of a particular price item. • Root Level Hierarchy Entity - Used to indicate whether you want to search for the pricing and commitments of price items which belong to a particular hierarchy entity. 	Yes
Account ID	Used to search for the pricing and commitments of a price item which belongs to a particular account in the customer hierarchy.	Yes (Conditional)

Field Name	Field Description	Mandatory (Yes or No)
	<p>Note: The Search (🔍) icon appears corresponding to the Account ID field. On clicking the Search icon, the Prospect Account Search window appears where you can search for the respective account.</p>	<p>Note: This field is required for searching the price item pricing and commitments of a particular account.</p>
Price Item	<p>Used to search for the price item pricing and commitments of a particular person, account, or hierarchy entity.</p> <p>Note:</p> <p>The Search (🔍) icon appears corresponding to the Price Item field. On clicking the Search icon, the Price Item Search window appears where you can search for the respective price item.</p> <p>You can specify a list of price items whose pricing and commitments you want to view when you select the Price Item option from the Search By list.</p>	<p>Yes (Conditional)</p> <p>Note: This field is required for searching the pricing and commitments of a particular price item.</p>
Price Item Approval Status	<p>Used to search for the pricing and commitments of price items which are in a particular approval status. The valid values are:</p> <ul style="list-style-type: none"> • Approved • Approved-Existing • Approver-Recommended • Error • Unapproved 	No
Assignment Level	<p>Used to search for the pricing and commitments of price items which are defined at a particular level in the customer hierarchy. The valid values are:</p> <ul style="list-style-type: none"> • Account Agreed - Indicates whether the price item pricing is agreed for the account. • Account Inherited Price List - Indicates whether the price item pricing is inherited from the parent price list hierarchy defined for the price list which is assigned to the account. • Account Price List - Indicates whether the price item pricing is defined in 	No





Field Name	Field Description	Mandatory (Yes or No)
	<p>the price list which is assigned to the account.</p> <ul style="list-style-type: none"> • Bundle Pricing - Indicates whether the price item pricing is defined for the bundle which is available for the retail banking. • Customer Agreed - Indicates whether the price item pricing is agreed for the customer in the customer hierarchy. • Customer Inherited Price List - Indicates whether the price item pricing is inherited from the parent price list hierarchy defined for the price list which is assigned to the customer. • Customer Price List - Indicates whether the price item pricing is defined in the price list which is assigned to the customer. • Default Price List - Indicates whether the price item pricing defined in the price list is available in the default price list. • Global Price List - Indicates whether the price item pricing defined in the price list is available in the global price list. • Market Product Pricing - Indicates whether the price item pricing is defined for the market product which is available for the retail banking. • Offer Pricing - Indicates whether the price item pricing is defined for the offer which is available for the retail banking. • Parent Customer Agreed - Indicates whether the price item pricing is agreed for the parent customer in the customer hierarchy. • Parent Customer Inherited Price List - Indicates whether the price item pricing is inherited from the parent price list hierarchy defined for the price list which is assigned to the parent customer. • Parent Customer Price List - Indicates whether the price item pricing is defined in the price list which is assigned to the parent customer. 	



Field Name	Field Description	Mandatory (Yes or No)
	<ul style="list-style-type: none"> Price List - Indicates whether the price item pricing is defined in the price list. Product Pricing - Indicates whether the price item pricing defined in the price list is available for the product pricing. 	
Person ID	Used to search for the pricing and commitments of a price item which belongs to a particular person in the customer hierarchy.	Yes (Conditional)
	Note: The Search (🔍) icon appears corresponding to the Account ID field. On clicking the Search icon, the Prospect Account Search window appears where you can search for the respective account.	Note: This field is required for searching the price item pricing and commitments of a particular person.
Root Level Hierarchy Entity	Used to search for the pricing and commitments of price items which belongs to a particular hierarchy entity.	Yes (Conditional)
	Note: The Search (🔍) icon appears corresponding to the Root Level Hierarchy Entity field. On clicking the Search icon, the Root Level Hierarchy Entity Search window appears where you can search for the respective hierarchy entity.	Note: This field is required for searching the price item pricing and commitments of a particular hierarchy entity.

In addition, the **Search Pricing and Commitments** section contains the following buttons:

Button Name	Button Description
Show All Pricing	Used to display all the price item pricing and commitments available for the specified search criteria.
Show Customer or Account Level Pricing	Used to show only the customer agreed and account agreed price item pricing and commitments available for the specified search criteria.

- **Symbol Legends** - Used to indicate the current status of the price item pricing and commitments. It also differentiates between the proposed and the original price item pricing statistics. It contains the following symbols:

Symbol Name	Symbol Description
 PROJECTED	Indicates the proposed price item pricing statistics.
 ORIGINAL	Indicates the existing price item pricing statistics.
 APPROVED	Indicates whether the pricing of the price item is approved.
 PENDING FOR APPROVAL	Indicates whether the pricing of the price item is pending for approval.
 Pre-Approved	Indicates whether the original pricing of the price item is approved for the deal.

Symbol Name	Symbol Description
 APPROVER-RECOMMENDED	Indicates whether a new pricing for the price item is recommended by the approver.
 Error	<p>Indicates whether an error occurred while validating the price item pricing during pricing simulation.</p> <p>Note:</p> <p>If the approver clicks the Check Limits button in the Pricing And Commitment Details screen and if the price item floor and ceil value falls within the approvers limit, then the status of the price item is changed to Approved.</p> <p>If the approver clicks the Check Limits button in the Pricing And Commitment Details screen and if the price item floor and ceil value does not fall within the approvers limit, then the status of the price item is changed to Pending For Approval.</p> <p>If the approver clicks the Send Price Items for Approval button in the Pricing And Commitment Details screen, the status of the price item is changed to Assigned to Price Item Manager.</p>
 Assigned to Price Item Manager	Indicates whether the price item pricing is sent to the price item manager for approval.

- **Pricing and Commitments** - Lists the price items as specified in the search criteria whose proposed and original pricing and commitment details you want to view. It contains the following columns:

Column Name	Column Description
Entity Information	<p>Displays the concatenated string of information about the person or account in the customer hierarchy whose price item pricing and commitment details you want to view separated by a comma (,).</p> <p>Note:</p> <p>The hierarchy entity is sorted in the price item hierarchy based on its respective sort sequence.</p> <p>If two or more hierarchy entities have the same sort sequence, then the system sorts them in the ascending alphabetical order of the information string.</p> <p>Also, if the sort sequence is not defined for the hierarchy entities, then the system sorts them in the ascending alphabetical order of the information string.</p>
Price Item	Displays the price item whose pricing and commitment details you want to view.

Column Name	Column Description
	<p>Note:</p> <p>The price item is sorted in the price item hierarchy based on its respective sort sequence.</p> <p>If two or more price items have the same sort sequence, then the system sorts them in the ascending alphabetical order of the information string.</p> <p>Also, if the sort sequence is not defined for the price items, then the system sorts them in the ascending alphabetical order of the information string.</p>
Price Item Hierarchy	Displays the concatenated string consisting of the root level and non-root level hierarchy entity of the price item separated by a comma (,).
Pricing Parameters	Indicates the parameters using which the pricing of the price item is defined.
Revenue Variation (%)	<p>Displays the variation between the original, proposed, and recommended revenue in percentage generated from the original, proposed, and recommended pricing of the price item. It is calculated using the following formula:</p> $\text{Revenue Variation (\%)} = (\text{Proposed Revenue} - \text{Original Revenue}) * 100 / \text{Original Revenue}.$
Status	Indicates the current approval status of the price item pricing and commitments.
Approver	Indicates the user who has approved the price item pricing and commitments.
Pricing Information	<p>Displays the concatenated string of information about the proposed and original price item pricing separated by a comma (,).</p> <p>Note: It has a link. On clicking the link, the Deal Pricing screen appears where you can view the details of the original and proposed price item pricing. You can also edit or override the proposed pricing of the price item through this screen.</p>
Price List Information	Indicates the price list from where the proposed and original pricing of the price item is derived for the person or account in the customer hierarchy.
Assignment Level	<p>Indicates the level at which the proposed and original pricing of the price item is defined in the customer hierarchy. The valid values are:</p> <ul style="list-style-type: none"> • Account Agreed - Indicates whether the price item pricing is agreed for the account. • Account Inherited Price List - Indicates whether the price item pricing is inherited from the parent price list hierarchy defined for the price list which is assigned to the account. • Account Price List - Indicates whether the price item pricing is defined in the price list which is assigned to the account. • Bundle Pricing - Indicates whether the price item pricing is defined for the bundle which is available for the retail banking.

Column Name	Column Description
	<ul style="list-style-type: none"> • Customer Agreed - Indicates whether the price item pricing is agreed for the customer in the customer hierarchy. • Customer Inherited Price List - Indicates whether the price item pricing is inherited from the parent price list hierarchy defined for the price list which is assigned to the customer. • Customer Price List - Indicates whether the price item pricing is defined in the price list which is assigned to the customer. • Default Price List - Indicates whether the price item pricing defined in the price list is available in the default price list. • Global Price List - Indicates whether the price item pricing defined in the price list is available in the global price list. • Market Product Pricing - Indicates whether the price item pricing is defined for the market product which is available for the retail banking. • Offer Pricing - Indicates whether the price item pricing is defined for the offer which is available for the retail banking. • Parent Customer Agreed - Indicates whether the price item pricing is agreed for the parent customer in the customer hierarchy. • Parent Customer Inherited Price List - Indicates whether the price item pricing is inherited from the parent price list hierarchy defined for the price list which is assigned to the parent customer. • Parent Customer Price List - Indicates whether the price item pricing is defined in the price list which is assigned to the parent customer. • Price List - Indicates whether the price item pricing is defined in the price list. • Product Pricing - Indicates whether the price item pricing defined in the price list is available for the product pricing.
Average Price	<p>Displays the average proposed and original cost of the price item as per the proposed and original commitments. It is calculated using the following formula:</p> $\text{Avg. Price} = \text{Proposed Revenue} / \text{Proposed Usage}$
Volume and Commitments	<p>On clicking the Edit (✎) icon, the Pricing and Commitments screen appears where you can view the original and proposed commitments of the price item.</p>
Revenue	<p>Displays the proposed and original revenue generated from the proposed and original price item pricing and commitments.</p>
Cost	<p>Displays the proposed and original cost of the price item based on the proposed and original usage.</p>
Terms and Conditions	<p>On clicking the Edit (✎) icon, the Mapping Terms and Conditions screen appears where you can view or delete the deal-specific terms and conditions associated with the price item.</p>

In addition, the **Pricing and Commitments** section contains the following buttons:

Button Name	Button Description
Send Price Items for Approval	<p>On clicking the Send Price Items for Approval button, the status of the price item is changed to Assigned to Price Item Manager.</p> <p>Note: An approver can send a price item for approval when the following conditions are met:</p> <ul style="list-style-type: none"> • The price item is assigned to the approver for approval • The Propose Pricing option is set to Yes in the Deal Approval Profile for the approver • The Submit Price Item for Approval option is set to Yes in the Deal Approval Profile for the approver
Check Limits	<p>On clicking the Check Limits button the system verifies whether the average price of the price item falls within the floor and ceil values defined for the approver in the price item screen.</p> <p>Note:</p> <p>If the average price falls within the floor and ceil values defined for the approver, then the status of the price item is changed to Approved.</p> <p>If the average price does not fall within the floor and ceil values defined for the approver, then the status of the price item is changed to Pending For Approval.</p>

Note: A check box appears corresponding to the price item if the price item is assigned to the approver for approval.

Related Topics

For more information on...	See...
How to view the pricing and commitments of all entities in a customer hierarchy	Viewing the Pricing and Commitments of All Entities in a Customer Hierarchy on page 2975
Viewing the Pricing and Commitments of a Particular Account	Viewing the Pricing and Commitments of a Particular Account on page 2976
Viewing the Pricing and Commitments of a Particular Customer	Viewing the Pricing and Commitments of a Particular Customer on page 2977
Viewing the Pricing and Commitments of a Particular Price Item	Viewing the Pricing and Commitments of a Particular Price Item on page 2977
Viewing the Pricing and Commitments of a Particular Hierarchy Entity	Viewing the Pricing and Commitments of a Particular Hierarchy Entity on page 2978

Viewing the Pricing and Commitments of All Entities in a Customer Hierarchy

Procedure

To view the pricing and commitments of all entities in a customer hierarchy:

1. Search for the deal in the **Search Deal** zone of the **Deal Dashboard** screen.

2. In the **Search Results** section, click the link in the **Deal Information** column corresponding to the deal whose entities pricing and commitments you want to view.
The **Deal Information** screen appears.
3. Click the **Deal Pricing and Commitments** button in the **Simulation Details** zone.
The **Deal Pricing and Commitments** screen appears.
4. Ensure that the **Search Pricing and Commitments** section is expanded in the **Deal Pricing and Commitments** screen.
5. Select the **All** option from the **Search By** list.
6. Click the **Show All Pricing** button available in the **Search Pricing and Commitments** section.
The pricing and commitments of all entities in the customer hierarchy appears in the **Pricing and Commitments** section.
7. View the pricing and commitments of all entities in the **Pricing and Commitments** section.

Related Topics

For more information on...	See...
How to search for a deal	Searching for a Deal on page 2773
Search Deal zone	Search Deal on page 2758
Deal Dashboard screen	Deal Dashboard on page 2757
Deal Information screen	Deal Information on page 2815
Simulation Details zone	Simulation Details on page 2847
Deal Pricing and Commitments screen	Deal Pricing and Commitments on page 2968

Viewing the Pricing and Commitments of a Particular Account

Procedure

To view the pricing and commitments of a particular account:

1. Search for the deal in the **Search Deal** zone of the **Deal Dashboard** screen.
2. In the **Search Results** section, click the link in the **Deal Information** column corresponding to the deal whose accounts pricing and commitments you want to view.
The **Deal Information** screen appears.
3. Click the **Deal Pricing and Commitments** button in the **Simulation Details** zone.
The **Deal Pricing and Commitments** screen appears.
4. Ensure that the **Search Pricing and Commitments** section is expanded in the **Deal Pricing and Commitments** screen.
5. Select the **Account** option from the **Search By** list.
6. Specify the account whose pricing and commitments you want to view in the **Account ID** field.
7. Click the **Show All Pricing** button available in the **Search Pricing and Commitments** section.
The pricing and commitments of the account appears in the **Pricing and Commitments** section.
8. View the pricing and commitments of the account in the **Pricing and Commitments** section.

Related Topics

For more information on...	See...
How to search for a deal	Searching for a Deal on page 2773
Search Deal zone	Search Deal on page 2758
Deal Dashboard screen	Deal Dashboard on page 2757
Deal Information screen	Deal Information on page 2815
Simulation Details zone	Simulation Details on page 2847
Deal Pricing and Commitments screen	Deal Pricing and Commitments on page 2968

Viewing the Pricing and Commitments of a Particular Customer

Procedure

To view the pricing and commitments a particular customer:

1. Search for the deal in the **Search Deal** zone of the **Deal Dashboard** screen.
2. In the **Search Results** section, click the link in the **Deal Information** column corresponding to the deal whose customers pricing and commitments you want to view.
The **Deal Information** screen appears.
3. Click the **Deal Pricing and Commitments** button in the **Simulation Details** zone.
The **Deal Pricing and Commitments** screen appears.
4. Ensure that the **Search Pricing and Commitments** section is expanded in the **Deal Pricing and Commitments** screen.
5. Select the **Customer** option from the **Search By** list.
6. Specify the customer whose pricing and commitments you want to view in the **Person ID** field.
7. Click the **Show All Pricing** button available in the **Search Pricing and Commitments** section.
The pricing and commitments of the customer appears in the **Pricing and Commitments** section.
8. View the pricing and commitments of the customer in the **Pricing and Commitments** section.

Related Topics

For more information on...	See...
How to search for a deal	Searching for a Deal on page 2773
Search Deal zone	Search Deal on page 2758
Deal Dashboard screen	Deal Dashboard on page 2757
Deal Information screen	Deal Information on page 2815
Simulation Details zone	Simulation Details on page 2847
Deal Pricing and Commitments screen	Deal Pricing and Commitments on page 2968

Viewing the Pricing and Commitments of a Particular Price Item

Procedure

To view the pricing and commitments a particular price item:

1. Search for the deal in the **Search Deal** zone of the **Deal Dashboard** screen.

2. In the **Search Results** section, click the link in the **Deal Information** column corresponding to the deal whose price items pricing and commitments you want to view.
The **Deal Information** screen appears.
3. Click the **Deal Pricing and Commitments** button in the **Simulation Details** zone.
The **Deal Pricing and Commitments** screen appears.
4. Ensure that the **Search Pricing and Commitments** section is expanded in the **Deal Pricing and Commitments** screen.
5. Select the **Price Item** option from the **Search By** list.
6. Specify the price item whose pricing and commitments you want to view in the **Price Item** field.
7. Click the **Show All Pricing** button available in the **Search Pricing and Commitments** section.
The pricing and commitments of the price item appears in the **Pricing and Commitments** section.
8. View the pricing and commitments of the price item in the **Pricing and Commitments** section.

Related Topics

For more information on...	See...
How to search for a deal	Searching for a Deal on page 2773
Search Deal zone	Search Deal on page 2758
Deal Dashboard screen	Deal Dashboard on page 2757
Deal Information screen	Deal Information on page 2815
Simulation Details zone	Simulation Details on page 2847
Deal Pricing and Commitments screen	Deal Pricing and Commitments on page 2968

Viewing the Pricing and Commitments of a Particular Hierarchy Entity

Procedure

To view the pricing and commitments a particular hierarchy entity:

1. Search for the deal in the **Search Deal** zone of the **Deal Dashboard** screen.
2. In the **Search Results** section, click the link in the **Deal Information** column corresponding to the deal whose hierarchy entities pricing and commitments you want to view.
The **Deal Information** screen appears.
3. Click the **Deal Pricing and Commitments** button in the **Simulation Details** zone.
The **Deal Pricing and Commitments** screen appears.
4. Ensure that the **Search Pricing and Commitments** section is expanded in the **Deal Pricing and Commitments** screen.
5. Select the **Root Level Hierarchy Entity** option from the **Search By** list.
6. Specify the hierarchy entity whose pricing and commitments you want to view in the **Root Level Hierarchy Entity** field.
7. Click the **Show All Pricing** button available in the **Search Pricing and Commitments** section.
The pricing and commitments of the hierarchy entity appears in the **Pricing and Commitments** section.
8. View the pricing and commitments of the hierarchy entity in the **Pricing and Commitments** section.

Related Topics

For more information on...	See...
How to search for a deal	Searching for a Deal on page 2773
Search Deal zone	Search Deal on page 2758
Deal Dashboard screen	Deal Dashboard on page 2757
Deal Information screen	Deal Information on page 2815
Simulation Details zone	Simulation Details on page 2847
Deal Pricing and Commitments screen	Deal Pricing and Commitments on page 2968

Price List Assignment

The **Price List Assignment** screen enables you to view the existing and proposed price lists of the person or account in a deal. It also enables you to edit or assign proposed price list to the person or account in a deal. It contains the following sections:

- **Deal** - Displays basic information about the deal. It contains the following fields:

Field Name	Field Description
Deal Version Information	Displays the deal version to which the person or account belongs.
Person ID	<p>Displays the person whose price list assignment details you want to view or edit.</p> <p>Note: This field appears in the following scenarios:</p> <ul style="list-style-type: none"> • If you are viewing the existing price lists of a person. • If you are editing the proposed price list of a person. • If you are assigning a proposed price list to a person. <p>This field appears when you are viewing, editing, or assigning a price list to a person in the customer hierarchy.</p>
Person Information	<p>Displays the concatenated string of information about the person separated by a comma (,).</p> <p>Note: This field appears when you are viewing, editing, or assigning a price list to a person in the customer hierarchy.</p>
Account ID	Displays the account whose price list assignment details you want to view or edit.

Field Name	Field Description
	<p>Note:</p> <p>This field appears in the following scenarios:</p> <ul style="list-style-type: none"> • If you are viewing the existing price lists of an account. • If you are editing the proposed price list of an account. • If you are assigning a proposed price list to an account <p>This field appears when you are viewing, editing, or assigning a price list to an account in the customer hierarchy.</p>
Account Information	<p>Displays the concatenated string of information about the account separated by a comma (,).</p> <p>Note: This field appears when you are viewing, editing, or assigning a price list to an account in the customer hierarchy.</p>

- **Existing Price Lists** - Lists the price lists that are already assigned to the person or account of the customer hierarchy in a deal. It contains the following columns:

Column Name	Column Description
Price List ID	Displays the existing price list of the person or account of the customer hierarchy.
Price List Information	<p>Displays the description of the price list.</p> <p>Note: It has a link. On clicking the link, the Price List screen appears where you can view the details of the respective price list.</p>
Effective Start Date	<p>Displays the date from when the price list is effective for the deal.</p> <p>Note: By default, this date is set to the deal start date and cannot be edited.</p>
Effective End Date	<p>Displays the date till when the price list is effective for the deal.</p> <p>Note: The Effective End Date cannot be earlier than the Effective Start Date.</p>
Price List Inheritance	Indicates whether the person or account can avail the price item pricing listed on the parent or grandparent price list if it is not available on the assigned price list. In other words, it indicates whether the person or account can inherit the price item pricing from the price list hierarchy.
Assignment Status	<p>Indicates the current status of the price list. The valid values are:</p> <ul style="list-style-type: none"> • Active • Inactive
Priority	Indicates the order in which the price list must be considered while determining the price item pricing for the person or account.

Note: The **Existing Price Lists** section appears in the **Price List Assignment** screen when you are viewing the original pricelist assignment of the person or account from the customer hierarchy.

Proposed Price Lists - Lists the price lists that are proposed for the person or account in the customer hierarchy of a deal. It contains the following columns:

Column Name	Column Description
Price List ID	Displays the price list that is proposed for the person or account of the customer hierarchy.
Price List Information	<p>Displays the description of the price list.</p> <p>Note: It has a link. On clicking the link, the details of the respective price list appears in the Assign Price List section for editing. You can activate or deactivate a proposed price list by editing its Effective End Date in the Assign Price List section.</p>
Effective Start Date	<p>Displays the date from when the proposed price list is effective for the deal.</p> <p>Note: By default, this date is set to the deal start date and cannot be edited.</p>
Effective End Date	<p>Displays the date till when the proposed price list is effective for the deal.</p> <p>Note: The Effective End Date cannot be earlier than the Effective Start Date.</p>
Price List Inheritance	Indicates whether the person or account can avail the price item pricing listed on the parent or grandparent price list if it is not available on the assigned price list. In other words, it indicates whether the person or account can inherit the price item pricing from the price list hierarchy.
Assignment Status	Indicates the current status of the proposed price list. The valid value is: <ul style="list-style-type: none"> Proposed
Priority	Indicates the order in which the price list must be considered while determining the price item pricing for the person or account.

Note:

The **Proposed Price List** section appears in the **Price List Assignment** screen when you are viewing, editing, or assigning a proposed price list to a person or an account of the customer hierarchy.

You can delete a proposed price list by clicking the **Delete** (🗑️) icon corresponding to the respective proposed price list.

The **Delete** icon appears corresponding to only those price lists which are newly assigned to the customer or account in the deal.

You cannot delete a proposed price list assignment which is created using the original price list assignments.

If you delete a proposed price list, the price item pricing inherited from the price list is also deleted from the **Pricing and Commitments** screen. But, if you have created the customer or account agreed pricing using the price list pricing, then such customer or account agreed pricing is not deleted from the **Pricing and Commitments** screen.

Assign Price List - Enables you to assign a proposed price list to a person or an account of the customer hierarchy in a deal. It contains the following fields:

Field Name	Field Description
Price List ID	<p>Used to indicate a particular price list that you want to assign to the proposed price list of a person or account.</p> <p>Note:</p> <p>The Search (🔍) icon appears corresponding to the Price List ID field. On clicking the Search icon, the Fetch Eligible Price Lists window appears.</p> <p>On indicating the price list, the price list information appears corresponding to the Price List ID field separated by a comma (,).</p>
Effective Start Date	<p>Displays the date from when the price list assignment is effective for the person or account.</p> <p>Note: By default this field is set to the deal start date and cannot be changed.</p>
Effective End Date	Used to specify the date till when the price list assignment is effective for the person or account.
Priority	Used to specify the order in which the assigned price list must be considered while determining the price item pricing for the person or account.
Price list Inheritance	<p>Indicates whether the person or account can avail the price item pricing listed on the parent or grandparent price list if it is not available on the assigned price list. In other words, it indicates whether the person or account can inherit the price item pricing from the price list hierarchy. The valid values are:</p> <ul style="list-style-type: none"> • Yes - Used to indicate that the person can inherit the price item pricing from the price list hierarchy. • No -Used to indicate that the person cannot inherit the price item pricing from the price list hierarchy.

Note: You cannot assign a proposed price list to a person or account if a deal has reached the **Finalized** status.

In addition, the **Price List Assignment** screen contains the following button:

Button Name	Button Description
Save and Select Price Item Group	On clicking the Save and Select Price Item Group button, the assigned price list is saved as the proposed price list and the Select Price Item Group screen appears where you can select and/or deselect the price items and/or hierarchy entities from the respective price list.

Related Topics

For more information on...	See...
How to view the existing price lists of a person or account	Viewing the Assigned Price Lists of a Person or Account on page 2856

For more information on...	See...
How to view the proposed price lists of a person or account	Viewing the Proposed Price List Assignments of a Person or Account on page 2857
How to assign a proposed price list to a person	Assigning a Proposed Price List to a Person on page 2983
How to assign a proposed price list to an account	Assigning a Proposed Price List to an Account on page 2984

Assigning a Proposed Price List to a Person

Procedure

To assign a proposed price list to a person:

1. Search for the deal in the **Search Deal** zone of the **Deal Dashboard** screen.
2. In the **Search Results** section, click the link in the **Deal Information** column corresponding to the deal in which you want to assign a proposed price list to a person.
The **Deal Information** screen appears.
3. In the **Simulation Details** zone, ensure that the customer hierarchy section is expanded when you are assigning a proposed price list to a person.
4. Click the **Edit** (✎) icon in the **Price List Assignment** column corresponding to the person to whom you want to assign a proposed price list.

The **Price List Assignment** screen appears. It contains the following sections:

- **Deal** - Displays information about the deal or the deal version.
- **Proposed Price Lists** - Lists the price lists which are already proposed for the person.
- **Assign Price List** - Used to assign a proposed price list to the person.

The **Assign Price List** section contains the following fields:

Field Name	Field Description	Mandatory (Yes or No)
Price List ID	Used to indicate a particular price list that you want to assign to the proposed price list of a person. Note: The Search (🔍) icon appears corresponding to the Price List ID field. On clicking the Search icon, the Fetch Eligible Price Lists window appears. On indicating the price list, the price list information appears corresponding to the Price List ID field separated by a comma (,).	Yes
Effective Start Date	Displays the date from when the price list assignment is effective for the person. Note: By default this field is set to the deal start date and cannot be changed.	Not applicable

Field Name	Field Description	Mandatory (Yes or No)
Effective End Date	Used to specify the date till when the price list assignment is effective for the person.	No
	Note: The Effective End Date cannot be earlier than the Effective Start Date .	
Priority	Used to specify the order in which the assigned price list must be considered while determining the price item pricing for the person.	Yes
Price list Inheritance	Used to indicate whether the person can avail the price item pricing listed on the parent or grandparent price list if it is not available on the assigned price list. In other words, it indicates whether the person can inherit the price item pricing from the price list hierarchy. The valid values are: <ul style="list-style-type: none"> • Yes - Used to indicate that the person can inherit the price item pricing from the price list hierarchy. • No -Used to indicate that the person cannot inherit the price item pricing from the price list hierarchy. 	Yes

5. Enter the required details in the **Assign Price List** section.
6. Click the **Save and Select Price Item Group** button.
The **Select Price Item Group** screen appears.
7. Select the price items whose pricing you want to inherit from the price list.

Note: Only price list pricing of the selected price items is listed in the **Pricing and Commitments** screen.

The proposed price list is assigned to the person.

Related Topics

For more information on...	See...
How to search for a deal	Searching for a Deal on page 2773
Deal Dashboard screen	Deal Dashboard on page 2757
Search Deal zone	Search Deal on page 2758
Simulation Details zone	Simulation Details on page 2847
Price List Assignment screen	Price List Assignment on page 2979
Pricing and Commitments screen	Pricing and Commitments on page 2934

Assigning a Proposed Price List to an Account

Procedure

To assign a proposed price list to an account:

1. Search for the deal in the **Search Deal** zone of the **Deal Dashboard** screen.

- In the **Search Results** section, click the link in the **Deal Information** column corresponding to the deal in which you want to assign a proposed price lists to an account.

The **Deal Information** screen appears.

- In the **Simulation Details** zone, ensure that the customer hierarchy section is expanded when you are assigning a proposed price list to an account.

- Click the **Edit**  icon in the

Price List Assignment column corresponding to the account to which you want to assign a proposed price list.

The **Price List Assignment** screen appears. It contains the following sections:

- **Deal** - Displays information about the deal or the deal version.
- **Proposed Price Lists** - Lists the price lists which are already proposed for the account.
- **Assign Price List** - Used to assign a proposed price list to the account.

The **Assign Price List** section contains the following fields:

Field Name	Field Description	Mandatory (Yes or No)
Price List ID	Used to indicate a particular price list that you want to assign to a proposed price list of an account. Note: The Search  icon appears corresponding to the Price List ID field. On clicking the Search icon, the Fetch Eligible Price Lists window appears. On indicating the price list, the price list information appears corresponding to the Price List ID field separated by a comma (.).	Yes
Effective Start Date	Displays the date from when the price list assignment is effective for the account. Note: By default this field is set to the deal start date and cannot be changed.	Not applicable
Effective End Date	Used to specify the date till when the price list assignment is effective for the account. Note: The Effective End Date cannot be earlier than the Effective Start Date .	No
Priority	Used to specify the order in which the assigned price list must be considered while determining the price item pricing for the account.	Yes
Price list Inheritance	Used to indicate whether the account can avail the price item pricing listed on the parent or grandparent price list if it is not available on the assigned price list. In other words, it indicates whether the account can inherit the price item pricing from the price list hierarchy. The valid values are:	Yes

Field Name	Field Description	Mandatory (Yes or No)
	<ul style="list-style-type: none"> Yes - Used to indicate that the account can inherit the price item pricing from the price list hierarchy. No -Used to indicate that the account cannot inherit the price item pricing from the price list hierarchy. 	

- Enter the required details in the **Assign Price List** section.
- Click the **Save and Select Price Item Group** button.
The **Select Price Item Group** screen appears.
- Select the price items whose pricing you want to inherit from the price list.

Note: Only price list pricing of the selected price items is listed in the **Pricing and Commitments** screen.

The proposed price list is assigned to the person.

Related Topics

For more information on...	See...
How to search for a deal	Searching for a Deal on page 2773
Deal Dashboard screen	Deal Dashboard on page 2757
Search Deal zone	Search Deal on page 2758
Simulation Details zone	Simulation Details on page 2847
Price List Assignment screen	Price List Assignment on page 2979
Pricing and Commitments screen	Pricing and Commitments on page 2934

Deleting a Proposed Price List of a Person or an Account

Procedure

To delete a proposed price list of a person or an account:

- Ensure that the customer hierarchy is expanded in the **Simulation Details** zone.
- Click the **Edit** (✎) icon in the **Price List Assignment** column corresponding to the person or account whose proposed price list you want to delete.
The **Price List Assignment** screen appears.
- Ensure that the **Proposed Price Lists** section is expanded in the **Price List Assignment** screen.
- In the **Proposed Price Lists** section, click the **Delete** (🗑) icon corresponding to the price list that you want to delete.
A message appears confirming whether you want to delete the proposed price list.
- Click **OK**.
The proposed price list is deleted.

Related Topics

For more information on...	See...
Simulation Details zone	Simulation Details on page 2847
Price List Assignment screen	Price List Assignment on page 2979

Product Enrollment

The **Product Enrollment** screen enables you to view the existing and proposed products to which the account is enrolled. It also enables you to edit or enroll an account or accounts of a person for a product. It contains the following sections:

- **Deal** - Displays basic information about the deal. It contains the following fields:

Field Name	Field Description
Deal Version Information	Displays the deal version to which the person or account belongs.
Person ID	Displays the person whose accounts you want to enroll for a product.. Note: This field appears when you want to enroll all the accounts of the person for a product.
Person Information	Displays the concatenated string of information about the person separated by a comma (.). Note: This field appears when you want to enroll all the accounts of the person for a product.
Account ID	Displays the account whose product enrollment details you want to view. Note: This field appears in the following scenarios: <ul style="list-style-type: none"> • If you are viewing the existing products enrolled for an account. • If you are editing the existing products enrolled for an account. • If you are enrolling an account for a product.
Account Information	Displays the concatenated string of information about the account separated by a comma (.). Note: This field appears when you are viewing, editing, or enrolling an account for a product.

- **Enrolled Products** - Lists the products to which the account is enrolled. It contains the following columns:

Column Name	Column Description
Enrollment ID	Displays the enrollment ID of the enrolled product.
Product Code	Displays the code of the enrolled product. Note: This column appears only when you are viewing the proposed product enrollment details of an account.
Product Description	Displays the description of the enrolled product.

Column Name	Column Description
	<p>Note:</p> <p>It has a link. On clicking the link while viewing the existing product to which the account is enrolled, the Product screen appears where you can view the details of the respective product.</p>
Version Description	<p>Displays the version of the enrolled product.</p> <p>Note: This column appears only when you are viewing the proposed product enrollment details of an account.</p>
Product Type	<p>Displays the type of product which is enrolled for the account.</p> <p>Note:</p> <p>Whereas, if you click the link while editing the proposed products to which the account is enrolled, the details of the product and its services appears in the Products and Services section of the Product Enrollment screen where you can edit the respective product.</p> <p>You cannot edit an enrolled product if the deal version has reached the Finalized status.</p>
Product Category	<p>Indicates the category to which the product belongs.</p> <p>Note: This column appears only when you are viewing the proposed product enrollment details of an account.</p>
Priority	<p>Displays the priority in which the enrolled product is considered for the account.</p> <p>Note: This column appears only when you are viewing the proposed product enrollment details of an account.</p>
Start Date	<p>Displays the date from when the enrolled product is effective for the account.</p> <p>Note: By default, this date is set to the deal start date and cannot be edited.</p>
End Date	<p>Displays the date till when the enrolled product is effective for the account.</p> <p>Note: The End Date cannot be earlier than the Start Date.</p>

- **Proposed Products** - Lists the products that are proposed for the account for enrollment. It contains the following columns:

Column Name	Column Description
Product Code	Displays the code of the enrolled product.
Product Description	Displays the description of the enrolled product.
Version Description	Displays the version of the enrolled product.

Column Name	Column Description
Product Type	Displays the type of product which is enrolled for the account.
Product Category	Indicates the category to which the product belongs.
Priority	Displays the priority in which the enrolled product is considered for the account.
Start Date	Displays the date from when the enrolled product is effective for the account.
	Note: By default, this date is set to the deal start date and cannot be edited.
End Date	Displays the date till when the enrolled product is effective for the account.
	Note: The End Date cannot be earlier than the Start Date .

Note:

On clicking the **Broadcast** () icon corresponding to a proposed enrolled product, the details of the product appears in the **Enroll Product** and **Product and Services** sections for editing.

Note: You cannot edit an enrolled product if the deal or deal version has reached the **Finalized** status.

You can delete the proposed product to which the account is enrolled by clicking the **Delete** () icon corresponding to a proposed enrolled product.

- **System Recommended Products & Packages** - Lists the products that you have recommended for enrollment while creating the deal. It contains the following columns:

Column Name	Column Description
Product Code	Displays the code of the recommended product.
Product Description	Displays the description of the recommended product.
Version Description	Displays the version of the recommended product.
Product Type	Displays the type of product which is recommended for the account.
Product Category	Indicates the category to which the recommended product belongs.
Start Date	Displays the date from when the recommended product is effective for the account.
	Note: By default, this date is set to the deal start date and cannot be edited.
End Date	Displays the date till when the recommended product is effective for the account.
	Note: The End Date cannot be earlier than the Start Date .

- **Enroll Product** - The **Enroll Product** section contains the following fields:

Field Name	Field Description
Enrollment ID	Used to specify the enrollment ID once the product is defined for an enrollment.
	Note: Enrollment ID is displayed when the product is added for enrollment.
Start Date	Displays the date from when the product enrollment is effective.
	Note: By default, this date is set to the deal start date and cannot be changed.
End Date	Displays the date till when the product enrollment is effective.

Note:

The **Enroll Product** section appears in the **Product Enrollment** screen only when you are enrolling an account or accounts of a person for a product.

- **Products and Services** - Used to define products and services for a product. It contains the following fields in a grid:

Field Name	Field Description
Product	Used to indicate the product to which you want to enroll an account or accounts of a person.
	<p>Note:</p> <p>The Search (🔍) icon appears corresponding to the Product field. On clicking the Search icon, the Fetch Eligible Products window appears. On indicating the product, the description of the product appears in the Product field.</p> <p>Also, when you select a product, the Standard Product, Product Services, and the Add-On Product Services that are eligible for the product appears corresponding to the product.</p>
Start Date	Used to specify the date from when the product is effective for the account or accounts of a person.
	Note: By default this field is set to the deal start date and cannot be changed.
End Date	Used to specify the date till when the product is effective for the account or accounts of a person.
	Note: The End Date cannot be earlier than the Start Date .
Priority	Used to specify the priority in which you want the product to be considered while calculating the financial summary of the deal.
Inclusion	Used to indicate whether you want to include the services of the product for the account.

Field Name	Field Description
	Note: By default, all the check boxes of the services provided by the product are selected. You can exclude a service by deselecting the check box corresponding to the respective service.
Standard Product	Displays the standard product which is included within the main product.
Start Date	Used to specify the date from when the standard product is effective. Note: By default this field is set to the deal start date and cannot be changed.
End Date	Used to specify the date till when the standard product is effective. Note: The End Date cannot be earlier than the Start Date .
Inclusion	Used to indicate whether the standard product is used for enrollment.
Product Services	Displays the service that is a part of the standard product.
Start Date	Used to specify the date from when the service is effective. Note: By default this field is set to the deal start date and cannot be changed.
End Date	Used to specify the date till when the service is effective. Note: The End Date cannot be earlier than the Start Date .
Inclusion	Used to indicate whether the service is used for enrollment.
Add on Services	Displays the add-on service which is a part of the packaged product.
Start Date	Used to specify the date from when the add-on service is effective. Note: By default this field is set to the deal start date and cannot be changed.
End Date	Used to specify the date till when the add-on service is effective. Note: The End Date cannot be earlier than the Start Date .
Inclusion	Used to indicate whether the add-on service is used for enrollment.

Related Topics

For more information on...	See...
How to view the existing products enrolled for an account	Viewing the Enrolled Products of an Account on page 2857
How to view the proposed products enrolled for an account	Viewing the Proposed Product Enrollments for an Account on page 2858
How to enroll an account for a product	Enrolling an Account for a Product on page 2997

For more information on...	See...
How to enroll all accounts of a person for a product	Enrolling All Accounts of a Person for a Product on page 2992

Enrolling All Accounts of a Person for a Product

Procedure

To enroll all accounts of person for a product:

1. Search for the deal in the **Search Deal** zone of the **Deal Dashboard** screen.
2. In the **Search Results** section, click the link in the **Deal Information** column corresponding to the deal whose persons accounts you want to enroll for a product.

The **Deal Information** screen appears.

3. In the **Simulation Details** zone, ensure that the customer hierarchy section is expanded when you are enrolling all accounts of a person.
4. Click the **Edit**  icon in the **Product Enrollment** column corresponding to the person whose accounts you want to enroll for a product.

The **Product Enrollment** screen appears. It contains the following sections:

- **Deal** - Displays basic information about the deal. It contains the following fields:

Field Name	Field Description
Deal Version Information	Displays the deal version to which the person or account belongs.
Person ID	Displays the person whose accounts you want to enroll for a product.. Note: This field appears when you want to enroll all the accounts of the person for a product.
Person Information	Displays the concatenated string of information about the person separated by a comma (,). Note: This field appears when you want to enroll all the accounts of the person for a product.

- **Enrolled Products** - Lists the products to which the accounts of the person are enrolled. It contains the following columns:

Column Name	Column Description
Enrollment ID	Displays the enrollment ID of the enrolled product.
Product Code	Displays the code of the enrolled product. Note: This column appears only when you are viewing the proposed product enrollment details of an account.
Product Description	Displays the description of the enrolled product.

Column Name	Column Description
	<p>Note:</p> <p>It has a link. On clicking the link while viewing the existing product to which the account is enrolled, the Product screen appears where you can view the details of the respective product.</p>
Version Description	<p>Displays the version of the enrolled product.</p> <p>Note: This column appears only when you are viewing the proposed product enrollment details of an account.</p>
Product Type	<p>Displays the type of product which is enrolled for the account.</p> <p>Note:</p> <p>Whereas, if you click the link while editing the proposed products to which the account is enrolled, the details of the product and its services appears in the Products and Services section of the Product Enrollment screen where you can edit the respective product.</p> <p>You cannot edit an enrolled product if the deal version has reached the Finalized status.</p>
Product Category	<p>Indicates the category to which the product belongs.</p> <p>Note: This column appears only when you are viewing the proposed product enrollment details of an account.</p>
Priority	<p>Displays the priority in which the enrolled product is considered for the account.</p> <p>Note: This column appears only when you are viewing the proposed product enrollment details of an account.</p>
Start Date	<p>Displays the date from when the enrolled product is effective for the account.</p> <p>Note: By default, this date is set to the deal start date and cannot be edited.</p>
End Date	<p>Displays the date till when the enrolled product is effective for the account.</p> <p>Note: The End Date cannot be earlier than the Start Date.</p>

- **Proposed Products** - Lists the products that are proposed for the accounts of the person for enrollment. It contains the following columns:

Column Name	Column Description
Product Code	Displays the code of the enrolled product.
Product Description	Displays the description of the enrolled product.

Column Name	Column Description
Version Description	Displays the version of the enrolled product.
Product Type	Displays the type of product which is enrolled for the account.
Product Category	Indicates the category to which the product belongs.
Priority	Displays the priority in which the enrolled product is considered for the account.
Start Date	Displays the date from when the enrolled product is effective for the account.
	Note: By default, this date is set to the deal start date and cannot be edited.
End Date	Displays the date till when the enrolled product is effective for the account.
	Note: The End Date cannot be earlier than the Start Date .

Note:

On clicking the **Broadcast** () icon corresponding to a proposed enrolled product, the details of the product appears in the **Enroll Product** and **Product and Services** sections for editing.

Note: You cannot edit an enrolled product if the deal or deal version has reached the **Finalized** status.

You can delete the proposed product to which the account is enrolled by clicking the **Delete** () icon corresponding to a proposed enrolled product.

- **System Recommended Products & Packages** - Lists the products that you have recommended for enrollment while creating the deal. It contains the following columns:

Column Name	Column Description
Product Code	Displays the code of the recommended product.
Product Description	Displays the description of the recommended product.
Version Description	Displays the version of the recommended product.
Product Type	Displays the type of product which is recommended for the account.
Product Category	Indicates the category to which the recommended product belongs.
Start Date	Displays the date from when the recommended product is effective for the account.
	Note: By default, this date is set to the deal start date and cannot be edited.
End Date	Displays the date till when the recommended product is effective for the account.
	Note: The End Date cannot be earlier than the Start Date .

- **Enroll Product** - The **Enroll Product** section contains the following fields:

Field Name	Field Description
Enrollment ID	Displays the enrollment ID once the product is defined for an enrollment.
	Note: This field is auto-populated when a product is added for enrollment.
Start Date	Displays the date from when the product enrollment is effective.
	Note: By default, this date is set to the deal start date and cannot be changed.
End Date	Used to specify the date till when the product enrollment is effective for the accounts of the person.

Note:

The **Enroll Product** section appears in the **Product Enrollment** screen only when you are enrolling an account or accounts of a person for a product.

- **Products and Services** - Used to define the product and its services for enrollment. It contains the following fields in a grid:

Field Name	Field Description
Product	Used to indicate the product to which you want to enroll the accounts of a person.
	<p>Note:</p> <p>The Search (🔍) icon appears corresponding to the Product field. On clicking the Search icon, the Fetch Eligible Products window appears.</p> <p>On indicating the product, the description of the product appears in the Product field.</p> <p>Also, when you select a product, the Standard Product, Product Services, and the Add-On Product Services that are eligible for the product appears corresponding to the product.</p>
Start Date	Used to specify the date from when the product is effective for the accounts of the person.
	Note: By default this field is set to the deal start date and cannot be changed.
End Date	Used to specify the date till when the product is effective for the accounts of the person.
	Note: The End Date cannot be earlier than the Start Date .
Priority	Used to specify the priority in which you want the product to be considered while calculating the financial summary of the deal.

Field Name	Field Description
Inclusion	Used to indicate whether you want to include the services of the product for the accounts of the person.
	Note: By default, all the check boxes of the services provided by the product are selected. You can exclude a service by deselecting the check box corresponding to the respective service.
Standard Product	Displays the standard product which is included within the main product.
Start Date	Used to specify the date from when the standard product is effective.
	Note: By default this field is set to the deal start date and cannot be changed.
End Date	Used to specify the date till when the standard product is effective.
	Note: The End Date cannot be earlier than the Start Date .
Inclusion	Used to indicate whether the standard product is used for enrollment.
Product Services	Displays the service that is a part of the standard product.
Start Date	Used to specify the date from when the service is effective.
	Note: By default this field is set to the deal start date and cannot be changed.
End Date	Used to specify the date till when the service is effective.
	Note: The End Date cannot be earlier than the Start Date .
Inclusion	Used to indicate whether the service is used for enrollment.
Add on Services	Displays the add-on service which is a part of the packaged product.
Start Date	Used to specify the date from when the add-on service is effective.
	Note: By default this field is set to the deal start date and cannot be changed.
End Date	Used to specify the date till when the add-on service is effective.
	Note: The End Date cannot be earlier than the Start Date .
Inclusion	Used to indicate whether the add-on service is used for enrollment.

5. Enter the required details in the **Products and Services** section.
6. Click **Save**.

The accounts of the person are enrolled for the product.

Related Topics

For more information on...	See...
How to search for a deal	Searching for a Deal on page 2773

For more information on...	See...
Deal Dashboard screen	Deal Dashboard on page 2757
Search Deal zone	Search Deal on page 2758
Simulation Details zone	Simulation Details on page 2847
Product Enrollment screen	Product Enrollment on page 2987

Enrolling an Account for a Product

Procedure

To enroll an account for a product:

1. Search for the deal in the **Search Deal** zone of the **Deal Dashboard** screen.
2. In the **Search Results** section, click the link in the **Deal Information** column corresponding to the deal whose account you want to enroll for a product.

The **Deal Information** screen appears.

3. In the **Simulation Details** zone, ensure that the customer hierarchy section is expanded when you are enrolling an account for a product.
4. Click the **Edit** (✎) icon in the **Product Enrollment** column corresponding to the account which you want to enroll for a product.

The **Product Enrollment** screen appears. It contains the following sections:

- **Deal** - Displays basic information about the deal. It contains the following fields:

Field Name	Field Description
Deal Version Information	Displays the deal version to which the person or account belongs.
Account ID	Displays the account whose product enrollment details you want to view. Note: This field appears in the following scenarios: <ul style="list-style-type: none"> • If you are viewing the existing products enrolled for an account. • If you are editing the existing products enrolled for an account. • If you are enrolling an account for a product.
Account Information	Displays the concatenated string of information about the account separated by a comma (,). Note: This field appears when you are viewing, editing, or enrolling an account for a product.



- **Enrolled Products** - Lists the products to which the account is enrolled. It contains the following columns:

Column Name	Column Description
Enrollment ID	Displays the enrollment ID of the enrolled product.
Product Code	Displays the code of the enrolled product.

Column Name	Column Description
	Note: This column appears only when you are viewing the proposed product enrollment details of an account.
Product Description	Displays the description of the enrolled product. Note: It has a link. On clicking the link while viewing the existing product to which the account is enrolled, the Product screen appears where you can view the details of the respective product.
Version Description	Displays the version of the enrolled product. Note: This column appears only when you are viewing the proposed product enrollment details of an account.
Product Type	Displays the type of product which is enrolled for the account. Note: Whereas, if you click the link while editing the proposed products to which the account is enrolled, the details of the product and its services appears in the Products and Services section of the Product Enrollment screen where you can edit the respective product. You cannot edit an enrolled product if the deal version has reached the Finalized status.
Product Category	Indicates the category to which the product belongs. Note: This column appears only when you are viewing the proposed product enrollment details of an account.
Priority	Displays the priority in which the enrolled product is considered for the account. Note: This column appears only when you are viewing the proposed product enrollment details of an account.
Start Date	Displays the date from when the enrolled product is effective for the account. Note: By default, this date is set to the deal start date and cannot be edited.
End Date	Displays the date till when the enrolled product is effective for the account. Note: The End Date cannot be earlier than the Start Date .

- **Proposed Products** - Lists the products that are proposed for the account for enrollment. It contains the following columns:

Column Name	Column Description
Product Code	Displays the code of the enrolled product.
Product Description	Displays the description of the enrolled product.
Version Description	Displays the version of the enrolled product.
Product Type	Displays the type of product which is enrolled for the account.
Product Category	Indicates the category to which the product belongs.
Priority	Displays the priority in which the enrolled product is considered for the account.
Start Date	Displays the date from when the enrolled product is effective for the account.
	Note: By default, this date is set to the deal start date and cannot be edited.
End Date	Displays the date till when the enrolled product is effective for the account.
	Note: The End Date cannot be earlier than the Start Date .

Note: On clicking the Broadcast () icon corresponding to a proposed enrolled product, the details of the product appears in the Enroll Product and Product and Services sections for editing.
Note: You cannot edit an enrolled product if the deal or deal version has reached the Finalized status.
You can delete the proposed product to which the account is enrolled by clicking the Delete () icon corresponding to a proposed enrolled product.

- **System Recommended Products & Packages** - Lists the products that you have recommended for enrollment while creating the deal. It contains the following columns:

Column Name	Column Description
Product Code	Displays the code of the recommended product.
Product Description	Displays the description of the recommended product.
Version Description	Displays the version of the recommended product.
Product Type	Displays the type of product which is recommended for the account.
Product Category	Indicates the category to which the recommended product belongs.
Start Date	Displays the date from when the recommended product is effective for the account.
	Note: By default, this date is set to the deal start date and cannot be edited.
End Date	Displays the date till when the recommended product is effective for the account.

Column Name	Column Description
	Note: The End Date cannot be earlier than the Start Date .

- **Enroll Product** - The **Enroll Product** section contains the following fields:

Field Name	Field Description
Enrollment ID	Displays the enrollment ID once the product is defined for an enrollment.
	Note: This field is auto-populated when a product is added for enrollment.
Start Date	Displays the date from when the product enrollment is effective.
	Note: By default, this date is set to the deal start date and cannot be changed.
End Date	Used to specify the date till when the product enrollment is effective for the accounts of the person.

Note:

The **Enroll Product** section appears in the **Product Enrollment** screen only when you are enrolling an account or accounts of a person for a product.

- **Products and Services** - Used to define the product and its services for enrollment. It contains the following fields in a grid:

Field Name	Field Description
Product	Used to indicate the product to which you want to enroll the account.
	<p>Note:</p> <p>The Search (🔍) icon appears corresponding to the Product field. On clicking the Search icon, the Fetch Eligible Products window appears.</p> <p>On indicating the product, the description of the product appears in the Product field.</p> <p>Also, when you select a product, the Standard Product, Product Services, and the Add-On Product Services that are eligible for the product appears corresponding to the product.</p>
Start Date	Used to specify the date from when the product is effective for the account.
	Note: By default this field is set to the deal start date and cannot be changed.
End Date	Used to specify the date till when the product is effective for the account.

Field Name	Field Description
	Note: The End Date cannot be earlier than the Start Date .
Priority	Used to specify the priority in which you want the product to be considered while calculating the financial summary of the deal.
Inclusion	Used to indicate whether you want to include the services of the product for the account. Note: By default, all the check boxes of the services provided by the product are selected. You can exclude a service by deselecting the check box corresponding to the respective service.
Standard Product	Displays the standard product which is included within the main product.
Start Date	Used to specify the date from when the standard product is effective. Note: By default this field is set to the deal start date and cannot be changed.
End Date	Used to specify the date till when the standard product is effective. Note: The End Date cannot be earlier than the Start Date .
Inclusion	Used to indicate whether the standard product is used for enrollment.
Product Services	Displays the service that is a part of the standard product.
Start Date	Used to specify the date from when the service is effective. Note: By default this field is set to the deal start date and cannot be changed.
End Date	Used to specify the date till when the service is effective. Note: The End Date cannot be earlier than the Start Date .
Inclusion	Used to indicate whether the service is used for enrollment.
Add on Services	Displays the add-on service which is a part of the packaged product.
Start Date	Used to specify the date from when the add-on service is effective. Note: By default this field is set to the deal start date and cannot be changed.
End Date	Used to specify the date till when the add-on service is effective. Note: The End Date cannot be earlier than the Start Date .
Inclusion	Used to indicate whether the add-on service is used for enrollment.

5. Enter the required details in the **Products and Services** section.
6. Click **Save**.

The account is enrolled for a product.

Related Topics

For more information on...	See...
How to search for a deal	Searching for a Deal on page 2773
Deal Dashboard screen	Deal Dashboard on page 2757
Search Deal zone	Search Deal on page 2758
Simulation Details zone	Simulation Details on page 2847
Product Enrollment screen	Product Enrollment on page 2987

Deleting a Proposed Product Enrollment of an Account**Procedure**

To delete a proposed product enrollment of an account:

1. Ensure that the customer hierarchy is expanded in the **Simulation Details** zone.
2. Click the **Edit** (✎) icon in the **Product Enrollment** column corresponding to the account whose proposed product enrollment you want to delete.
The **Product Enrollment** screen appears.
3. Ensure that the **Proposed Products** section is expanded in the **Product Enrollment** screen.
4. In the **Proposed Products** section, click the **Delete** (🗑) icon corresponding to the product that you want to delete.
A message appears confirming whether you want to delete the proposed product enrollment.
5. Click **OK**.

The proposed product enrollment of the account is deleted.

Related Topics

For more information on...	See...
Simulation Details zone	Simulation Details on page 2847
Product Enrollment screen	Product Enrollment on page 2987

Pricing and Commitments

The **Pricing and Commitments** screen allows you to do the following:

- View the original and proposed pricing of the price item
- Edit the proposed pricing of the price item
- Override the proposed pricing of the price item
- View the original and proposed commitments of the price item
- Edit the proposed commitments of the price item

The **Pricing and Commitments** screen contains the following sections:

- **Pricing** - Used to view the original and proposed pricing of the price item. It also allows you to edit or override the proposed pricing of the price item. It contains the following zones:
 - [Projected Pricing](#) on page 3003

- [Original Pricing](#) on page 3009
- **Commitments** - Used to view the original and proposed commitments of the price item. It also allows you to edit the proposed commitments of the price item. It contains the following zones:
 - [Proposed Commitments](#) on page 3013
 - [Original Volume](#) on page 3014

Projected Pricing

The **Projected Pricing** zone allows to view, edit, or override the proposed pricing of the price item. It contains the following field:

Field Name	Field Description
Override	Used to indicate whether you want to override the price item pricing.

In addition, the **Projected Pricing** zone contains the following sections:

- **Main** - Displays basic information about the price item pricing. It contains the following fields:

Field Name	Field Description
Price Assignment ID	<p>Displays the price assignment ID.</p> <p>Note: It is a read-only field and cannot be edited. A new Price Assignment ID is generated if you override the proposed pricing of the price item.</p>
Price Item	<p>Displays the price item for which the proposed pricing is defined.</p> <p>Note: It is a read-only field and cannot be edited.</p>
Start Date	<p>Use to specify the date from when the pricing of the price item is effective for the deal.</p> <p>Note: By default the deal start date appears in this field. You can define a seasonal pricing for the price item by overriding the price item pricing with a price assignment start date greater than the deal start date.</p>
Price Assignment Type	<p>Used to indicate the type of price assignment. The valid values are:</p> <ul style="list-style-type: none"> • Regular - Used to indicate that the pricing is used to generate regular bill segment. • Post Processing - Used to indicate that the pricing is used to generate post processing bill segment. This type of price assignment can be done on usage accounts. The post processing bill segment is generated when you generate the bill for the usage account and not when you bill the usage account through an invoice account.

Field Name	Field Description
	<p data-bbox="751 212 1463 338">Note: The post processing bill segment is generated when the Post Processing Sequence (PPSEQ) characteristic is defined for the price item and when the price item is associated with another price item using the Price Item Relationship Type.</p> <ul data-bbox="719 369 1463 495" style="list-style-type: none"> • Post Processing – Invoice Based - Used to indicate that the pricing is used to generate post processing bill segment. This type of price assignment can be done on an invoice account, and, as a result, the post processing bill segment is generated on the invoice account. <p data-bbox="751 516 1463 579">Note: This is not applicable for price items whose Price Item Usage field is set to Pricing.</p> <ul data-bbox="719 611 1463 758" style="list-style-type: none"> • Post Processing – Price Item Based - Used to indicate that the pricing is used to generate post processing bill segment. This type of price assignment can be done on both invoice and usage accounts, but the post processing bill segment is generated only on the invoice account. <p data-bbox="751 789 1463 852">Note: This field is not applicable for price items whose Price Item Usage field is set to Pricing.</p>
End Date	Used to specify the date till when the pricing of the price item is effective for the deal.
Pricing Currency	Used to indicate the currency in which you want to define the pricing of the price item.
Pricing Eligibility	<p data-bbox="691 1077 1433 1108">Used to select the pricing eligibility criteria for the price item pricing.</p> <p data-bbox="691 1136 1463 1199">Note: If you select the check box you can define the pricing eligibility of the price item in the Price Component section of this zone.</p>
Print Zero	<p data-bbox="691 1234 1463 1297">Used to indicate whether zero pricing should be displayed in the bill. The valid values are:</p> <ul data-bbox="719 1318 800 1392" style="list-style-type: none"> • Yes • No
Rate Schedule	<p data-bbox="691 1423 1463 1486">Used to specify the rate schedule that you want to use while defining price item pricing.</p> <p data-bbox="691 1514 1463 1713">Note: Rate schedules control how the bills for the price item will be calculated. The Search (🔍) icon appears corresponding to this field. On clicking the Search icon, the Rate Schedule Search window appears where you can search for the respective rate schedule.</p>

- **TFM Information** - Displays the transaction information mapped with the price item. It contains the following fields:

Field Name	Field Description
Transaction Rating Criteria	Used to indicate how and when the transaction legs mapped to the price item are rated. The valid values are: <ul style="list-style-type: none"> Aggregate Transactions and Then Rate Aggregated SQs Do Not Rate Transactions Rate Transaction and Aggregate Calc Lines Across Transaction Rate Transactions
Aggregation Schedule	Used to indicate the transaction aggregation cycle. The valid values are: <ul style="list-style-type: none"> Daily Weekly Monthly Quarterly Yearly
Do Not Aggregate Switch	Used to Indicate whether aggregation is required while rating the transactions before billing. The valid values are: <ul style="list-style-type: none"> Yes - Used to Indicate aggregation is not required while rating the transactions before billing. No - Used to Indicate aggregation is required while rating the transactions before billing.
Ignore Transaction	Used to indicate whether the transactions mapped to the price item is considered for billing. The valid values are: <ul style="list-style-type: none"> Yes No

- **Pricing Parameter Information** - Displays the parameters based on which the price item pricing is defined. It contains the following columns:

Column Name	Column Description
Parameter	Indicates the parameter that is associated with the price item pricing. Note: The Search (🔍) icon appears corresponding to this field. On clicking the Search icon, the Price Item Parameter Search window appears. The parameter search results displays only those parameters where the Price Item check box is selected.
Parameter Value	Displays the value of the parameter.





- **Characteristics** - Lists the characteristics defined for the price item pricing. It contains the following columns:

Column Name	Column Description
Effective Date	Used to specify the date from when the characteristic is effective for the price item pricing.

Column Name	Column Description
Characteristic Type	Used to indicate the characteristic type.
	Note: The list includes only those characteristic types where the characteristic entity is set to Projected Pricing .
Characteristic Value	Used to specify the value for the characteristic type.
	<p>Note:</p> <p>If you select a predefined characteristic type, the Search (🔍) icon appears corresponding to the Characteristic Value field. On clicking the Search icon, the Predefined Characteristic Search window appears.</p> <p>On specifying the value for a predefined characteristic type, the description of the characteristic value appears corresponding to the Characteristic Value field.</p>

- **Price Component** - Used to define a list of price components of the rate component that you want to map with the price item pricing. It contains the following columns:

Column Name	Column Description								
Rate Component	Displays the concatenated string of information about the rate component separated by comma (,).								
	<p>Note:</p> <p>It is a read-only field and cannot be edited.</p> <p>This ID is generated automatically when you define the tiering setup of the rate component.</p>								
Display Sequence	Used to specify the sequence of price component whose rate is used for calculating the pricing of the price item.								
Description	Used to specify the description of the price component.								
Show Price Component	Used to indicate whether you want to display the price component in the bill.								
Rate	Used to specify the rate defined for the price component.								
Eligibility and Tier Details	Used to specify the tiering criteria and eligibility criteria of the price component for the price item pricing.								
Tier Details	On clicking the Add (+) icon, you can define the Tiering Criteria of the price component for the price item pricing. It contains the following columns:								
	<table border="1"> <thead> <tr> <th>Column Name</th> <th>Column Description</th> </tr> </thead> <tbody> <tr> <td>Display Sequence</td> <td>Used to specify the sequence of the tiering criteria.</td> </tr> <tr> <td>Tiering Criterion</td> <td>Used to indicate the tiering criteria.</td> </tr> <tr> <td>Lower Limit</td> <td>Used to specify the lower limit of the tiering range.</td> </tr> </tbody> </table>	Column Name	Column Description	Display Sequence	Used to specify the sequence of the tiering criteria.	Tiering Criterion	Used to indicate the tiering criteria.	Lower Limit	Used to specify the lower limit of the tiering range.
	Column Name	Column Description							
	Display Sequence	Used to specify the sequence of the tiering criteria.							
	Tiering Criterion	Used to indicate the tiering criteria.							
Lower Limit	Used to specify the lower limit of the tiering range.								

Column Name	Column Description													
	Column Name	Column Description												
	Upper Limit	Used to specify the upper limit of the tiering range.												
	Note: You can define the tiering criteria of a price component only when the Tiering Type of its rate component is STEP or THRESHOLD .													
Eligibility Details	<p>On clicking the Add  icon, you can define the eligibility criteria of the price component for the price item pricing. It contains the following columns:</p> <table border="1"> <thead> <tr> <th>Column Name</th> <th>Column Description</th> </tr> </thead> <tbody> <tr> <td>Display Sequence</td> <td>Used to specify the order in which the eligibility criteria should be executed in the rule.</td> </tr> <tr> <td>Parameter</td> <td>Used to indicate the left hand side parameter which you want to use along with the price item for price determination. <div data-bbox="1036 919 1458 1066" style="border: 1px solid black; padding: 5px;"> <p>Note: The Search  icon appears corresponding to the Parameter field. On clicking the Search icon, the Parameter Search window appears.</p> </div> </td> </tr> <tr> <td>Operator</td> <td>Used to specify the relational operator to define the relation between the left hand side and right hand side parameters.</td> </tr> <tr> <td>Parameter Value Type</td> <td>Used to indicate the type of pricing eligibility. The valid values are: <ul style="list-style-type: none"> • Parameter - Used to indicate the type of parameter. • Value - Used to indicate the type of value. </td> </tr> <tr> <td>Parameter</td> <td>Used to specify the value for the Parameter Value Type as the right hand side parameter which you want to use along with the price item for price determination.</td> </tr> </tbody> </table>		Column Name	Column Description	Display Sequence	Used to specify the order in which the eligibility criteria should be executed in the rule.	Parameter	Used to indicate the left hand side parameter which you want to use along with the price item for price determination. <div data-bbox="1036 919 1458 1066" style="border: 1px solid black; padding: 5px;"> <p>Note: The Search  icon appears corresponding to the Parameter field. On clicking the Search icon, the Parameter Search window appears.</p> </div>	Operator	Used to specify the relational operator to define the relation between the left hand side and right hand side parameters.	Parameter Value Type	Used to indicate the type of pricing eligibility. The valid values are: <ul style="list-style-type: none"> • Parameter - Used to indicate the type of parameter. • Value - Used to indicate the type of value. 	Parameter	Used to specify the value for the Parameter Value Type as the right hand side parameter which you want to use along with the price item for price determination.
Column Name	Column Description													
Display Sequence	Used to specify the order in which the eligibility criteria should be executed in the rule.													
Parameter	Used to indicate the left hand side parameter which you want to use along with the price item for price determination. <div data-bbox="1036 919 1458 1066" style="border: 1px solid black; padding: 5px;"> <p>Note: The Search  icon appears corresponding to the Parameter field. On clicking the Search icon, the Parameter Search window appears.</p> </div>													
Operator	Used to specify the relational operator to define the relation between the left hand side and right hand side parameters.													
Parameter Value Type	Used to indicate the type of pricing eligibility. The valid values are: <ul style="list-style-type: none"> • Parameter - Used to indicate the type of parameter. • Value - Used to indicate the type of value. 													
Parameter	Used to specify the value for the Parameter Value Type as the right hand side parameter which you want to use along with the price item for price determination.													

Column Name	Column Description	
	Column Name	Column Description
		<p>Note:</p> <p>If you select the Parameter Value Type as Parameter, the Search (🔍) icon appears corresponding to the Parameter field. On clicking the Search icon, the Parameter Search window appears.</p> <p>If you select the Parameter Value Type as Value then you can specify any special characters except ampersand (&), comma (,), underscore (_), equal to (=), tilde (~), and semi-colon (;) in the Parameter field.</p>
	Is True	<p>Used to indicate what happens when the condition is true (satisfied). The valid values are:</p> <ul style="list-style-type: none"> • Check next condition - Used to indicate that the condition with the consecutive sequence number is executed. • Rule is false - Used to indicate that the action specified in the Rule False Action field is executed. • Rule is true - Used to indicate that the action specified in the Rule True Action field is executed.
Is False	<p>Used to indicate what happens when the condition is false (not satisfied). The valid values are:</p> <ul style="list-style-type: none"> • Check next condition - Used to indicate that the condition with the consecutive sequence number is executed. • Rule is false - Used to indicate that the action specified in the Rule False Action field is executed. • Rule is true - Used to indicate that the action specified in the Rule True Action field is executed. 	

Column Name	Column Description	
	Column Name	Column Description
	Is Insufficient	Used to indicate what happens when the data is insufficient. The valid values are: <ul style="list-style-type: none"> • Check next condition - Used to indicate that the condition with the consecutive sequence number is executed. • Rule is false - Used to indicate that the action specified in the Rule False Action field is executed. • Rule is true - Used to indicate that the action specified in the Rule True Action field is executed.
	Note: You can define the eligibility criteria of a price component only when the Pricing Eligibility check box is selected.	

In addition, the **Projected Pricing** zone contains the following sections:

Related Topics

For more information on...	See...
Pricing and Commitments screen	<i>Pricing and Commitments</i> on page 3002

Original Pricing

The **Original Pricing** zone allows you to view the details of the existing pricing of the price item. It contains the following sections:

- **Main** - Displays basic information about the price item pricing. It contains the following fields:

Field Name	Field Description
Price Assignment ID	Displays the price assignment ID.
Price Item	Displays the price item for which the original pricing is defined.
Start Date	Displays the date from when the pricing of the price item is effective for the deal.
Price Assignment Type	Indicates the type of price assignment. The valid values are: <ul style="list-style-type: none"> • Regular - Indicates that the pricing is used to generate regular bill segment. • Post Processing - Indicates that the pricing is used to generate post processing bill segment. This type of price assignment can be done on usage accounts. The post processing bill segment is generated when you generate the bill for the usage account and not when you bill the usage account through an invoice account.

Field Name	Field Description
	<p>Note: The post processing bill segment is generated when the Post Processing Sequence (PPSEQ) characteristic is defined for the price item and when the price item is associated with another price item using the Price Item Relationship Type.</p> <ul style="list-style-type: none"> • Post Processing – Invoice Based - Indicates that the pricing is used to generate post processing bill segment. This type of price assignment can be done on an invoice account, and, as a result, the post processing bill segment is generated on the invoice account. <p>Note: This is not applicable for price items whose Price Item Usage field is set to Pricing.</p> <ul style="list-style-type: none"> • Post Processing – Price Item Based - Indicates that the pricing must be used to generate post processing bill segment. This type of price assignment can be done on both invoice and usage accounts, but the post processing bill segment is generated only on the invoice account. <p>Note: This is not applicable for price items whose Price Item Usage field is set to Pricing.</p>
End Date	Displays the date till when the pricing of the price item is effective for the deal.
Pricing Currency	Indicates the currency in which you want to define the pricing of the price item.
Pricing Eligibility	Indicates whether the pricing eligibility criteria is defined for the price item pricing in the Price Component section.
Print Zero	Indicates whether zero pricing should be displayed in the bill. The valid values are: <ul style="list-style-type: none"> • Yes • No
Rate Schedule	Displays the rate schedule that you want to use while defining price item pricing. <p>Note: Rate schedules control how the bills for the price item is calculated.</p>

- **TFM Information** - Displays the transaction information mapped with the price item. It contains the following fields:

Field Name	Field Description
Transaction Rating Criteria	Indicates how and when the transaction legs mapped to the price item are rated. The valid values are: <ul style="list-style-type: none"> • Aggregate Transactions and Then Rate Aggregated SQs • Do Not Rate Transactions • Rate Transaction and Aggregate Calc Lines Across Transaction • Rate Transactions

Field Name	Field Description
Do Not Aggregate Switch	Indicates whether aggregation is required while rating the transactions before billing. The valid values are: <ul style="list-style-type: none"> • Yes - Indicates aggregation is not required while rating the transactions before billing. • No - Indicates aggregation is required while rating the transactions before billing.
Ignore Transaction	Indicates whether the transactions mapped to the price item is considered for billing. The valid values are: <ul style="list-style-type: none"> • Yes • No
Aggregation Schedule	Indicates the transaction aggregation cycle. The valid values are: <ul style="list-style-type: none"> • Daily • Weekly • Monthly • Quarterly • Yearly

- **Pricing Parameter Information** - Displays the parameters based on which the price item pricing is defined. It contains the following columns:

Column Name	Column Description
Parameter	Indicates the parameter that is associated with the price item pricing.
Parameter Value	Displays the value of the parameter.

- **Characteristics** - Lists the characteristics defined for the price item pricing. It contains the following columns:

Column Name	Column Description
Effective Date	Displays the date from when the characteristic is effective for the price item pricing.
Characteristic Type	Indicates the characteristic type.
Characteristic Value	Displays the value for the characteristic type.

- **Price Component** - Lists the price components of the rate component that is mapped with the price item pricing. It contains the following columns:

Column Name	Column Description
Rate Component	Displays the concatenated string of information about the rate component separated by comma (.).
Display Sequence	Displays the sequence of price component whose rate is used for calculating the pricing of the price item.
Description	Displays the description of the price component.
Show Price Component	Indicates whether you want to display the price component in the bill.

Column Name	Column Description														
Rate	Displays the rate defined for the price component.														
Eligibility and Tier Details	Displays the tiering criteria and eligibility criteria for the price item pricing.														
Tier Details	<p>Displays information about the tiering criteria of the price component for the price item pricing. It contains the following columns:</p> <table border="1"> <thead> <tr> <th>Column Name</th> <th>Column Description</th> </tr> </thead> <tbody> <tr> <td>Display Sequence</td> <td>Displays the sequence of the tiering criteria.</td> </tr> <tr> <td>Tiering Criterion</td> <td>Indicates the tiering criteria.</td> </tr> <tr> <td>Lower Limit</td> <td>Displays the lower limit of the tiering range.</td> </tr> <tr> <td>Upper Limit</td> <td>Displays the upper limit of the tiering range.</td> </tr> </tbody> </table> <p>Note: You can define the tiering criteria of a price component only when the Tiering Type of its rate component is STEP or THRESHOLD.</p>	Column Name	Column Description	Display Sequence	Displays the sequence of the tiering criteria.	Tiering Criterion	Indicates the tiering criteria.	Lower Limit	Displays the lower limit of the tiering range.	Upper Limit	Displays the upper limit of the tiering range.				
Column Name	Column Description														
Display Sequence	Displays the sequence of the tiering criteria.														
Tiering Criterion	Indicates the tiering criteria.														
Lower Limit	Displays the lower limit of the tiering range.														
Upper Limit	Displays the upper limit of the tiering range.														
Eligibility Details	<p>Displays information about the eligibility criteria of the price component for the price item pricing. It contains the following columns:</p> <table border="1"> <thead> <tr> <th>Column Name</th> <th>Column Description</th> </tr> </thead> <tbody> <tr> <td>Display Sequence</td> <td>Displays the order in which the eligibility criteria is executed in the rule.</td> </tr> <tr> <td>Parameter</td> <td>Indicates the left hand side parameter which is used along with the price item for price determination.</td> </tr> <tr> <td>Operator</td> <td>Indicates the relational operator that is used to define the relation between the left hand side and the right hand side parameters.</td> </tr> <tr> <td>Parameter Value Type</td> <td> Indicates the type of pricing eligibility. The valid values are: <ul style="list-style-type: none"> • Parameter - Indicates the type of parameter. • Value - Indicates the type of value. </td> </tr> <tr> <td>Parameter</td> <td>Displays the value for the Parameter Value Type as the right hand side parameter which you want to use along with the price item for price determination.</td> </tr> <tr> <td>Is True</td> <td>Indicates what happens when the condition is true (satisfied). The valid values are:</td> </tr> </tbody> </table>	Column Name	Column Description	Display Sequence	Displays the order in which the eligibility criteria is executed in the rule.	Parameter	Indicates the left hand side parameter which is used along with the price item for price determination.	Operator	Indicates the relational operator that is used to define the relation between the left hand side and the right hand side parameters.	Parameter Value Type	Indicates the type of pricing eligibility. The valid values are: <ul style="list-style-type: none"> • Parameter - Indicates the type of parameter. • Value - Indicates the type of value. 	Parameter	Displays the value for the Parameter Value Type as the right hand side parameter which you want to use along with the price item for price determination.	Is True	Indicates what happens when the condition is true (satisfied). The valid values are:
Column Name	Column Description														
Display Sequence	Displays the order in which the eligibility criteria is executed in the rule.														
Parameter	Indicates the left hand side parameter which is used along with the price item for price determination.														
Operator	Indicates the relational operator that is used to define the relation between the left hand side and the right hand side parameters.														
Parameter Value Type	Indicates the type of pricing eligibility. The valid values are: <ul style="list-style-type: none"> • Parameter - Indicates the type of parameter. • Value - Indicates the type of value. 														
Parameter	Displays the value for the Parameter Value Type as the right hand side parameter which you want to use along with the price item for price determination.														
Is True	Indicates what happens when the condition is true (satisfied). The valid values are:														

Column Name	Column Description	
	Column Name	Column Description
		<ul style="list-style-type: none"> • Check next condition - Indicates that the condition with the consecutive sequence number is executed. • Rule is false - Indicates that the action specified in the Rule False Action field is executed. • Rule is true - Indicates that the action specified in the Rule True Action field is executed.
	Is False	<p>Indicates what happens when the condition is false (not satisfied). The valid values are:</p> <ul style="list-style-type: none"> • Check next condition - Indicates that the condition with the consecutive sequence number is executed. • Rule is false - Indicates that the action specified in the Rule False Action field is executed. • Rule is true - UIndicates that the action specified in the Rule True Action field is executed.
	Is Insufficient	<p>Indicates what happens when the data is insufficient. The valid values are:</p> <ul style="list-style-type: none"> • Check next condition - Indicates that the condition with the consecutive sequence number is executed. • Rule is false - Indicates that the action specified in the Rule False Action field is executed. • Rule is true - Indicates that the action specified in the Rule True Action field is executed.
<p>Note: You can define the eligibility criteria of a price component only when the Pricing Eligibility check box is selected.</p>		

Related Topics

For more information on...	See...
Pricing and Commitments screen	Pricing and Commitments on page 3002

Proposed Commitments

The **Proposed Commitments** zone allows to view or edit the proposed commitments of the price item for a person or account based on which the revenue is calculated for the deal. It contains the following columns:

Column Name	Column Description
Price Item	Displays the price item.
Pricing Parameters	Indicates the parameter based on which the pricing is defined for the price item.
SQI	Indicates the service quantity identifier that is associated with the price item.
Service Quantity	Used to specify the proposed SQI value using which the rates engine calculates the price item pricing.

Related Topics

For more information on...	See...
Pricing and Commitments screen	Pricing and Commitments on page 3002

Original Volume

The **Original Volume** zone displays information about the existing volume of the price item. It contains the following columns:

Column Name	Column Description
Price Item	Displays the price item.
Pricing Parameters	Displays the parameter based on which the pricing is defined for the price item.
SQI	Displays the service quantity identifier that is associated with the price item.
Service Quantity	Displays the existing SQI value used by the rates engine for calculating the price item pricing.

Related Topics

For more information on...	See...
Pricing and Commitments screen	Pricing and Commitments on page 3002

Editing a Proposed Price Item Pricing

Prerequisites

To edit a proposed price item pricing, you should have:

- Values defined for the **Price Assignment Type** in the **PA_TYPE_FLAG** lookup field
- Currencies defined in the application
- Rate schedules, rate versions, and rate components defined in the application
- Values defined for **Transaction Rating Criteria** in the **TXN_RATING_CRITERIA** lookup field
- Values defined for **Pricing Rule Type** in the **PRC_RULE_TYPE_FLG** lookup field
- Aggregation schedules defined in the application
- Parameters defined in the application (where the **Price Item** option is selected in the **Parameter Usage** section)
- Characteristic types defined in the application (where the characteristic entity is set to **Price Item Pricing**)

- Transactions mapped to the price item defined in the application
- Tiering criteria defined in the application
- Tiering setup for the rate components defined in the application
- Pricing eligibility defined in the application

Procedure

To edit a proposed price item pricing:

1. Ensure that the **Projected Pricing** zone is expanded in the **Pricing and Commitments** screen when you are editing the proposed pricing of a price item.

The **Projected Pricing** zone contains the following field:

Field Name	Field Description	Mandatory (Yes or No)
Override	Used to indicate whether you want to override the price item pricing.	No
		Note: This field is required only while overriding the price item pricing.

In addition, the **Projected Pricing** zone contains the following sections:

- **Main** - Used to specify basic details about the price item pricing. It contains the following fields:

Field Name	Field Description	Mandatory (Yes or No)
Price Assignment ID	Displays the price assignment ID. Note: It is a read-only field and cannot be edited.	Not Applicable
Price Item	Displays the price item whose pricing you want to edit. Note: It is a read-only field and cannot be edited.	Not Applicable
Start Date	Use to specify the date from when the pricing of the price item is effective for the deal. Note: By default the deal start date appears in this field.	Yes
Price Assignment Type	Used to indicate the type of price assignment. The valid values are: <ul style="list-style-type: none"> • Regular - Used to indicate that the pricing is used to generate regular bill segment. • Post Processing - Used to indicate that the pricing is used to generate post processing bill segment. This type of price assignment can be done on usage accounts. The post processing bill segment is generated when you generate 	Yes

Field Name	Field Description	Mandatory (Yes or No)
	<p>the bill for the usage account and not when you bill the usage account through an invoice account.</p> <div data-bbox="740 348 1192 583" style="border: 1px solid black; padding: 5px;"> <p>Note: The post processing bill segment is generated when the Post Processing Sequence (PPSEQ) characteristic is defined for the price item and when the price item is associated with another price item using the Price Item Relationship Type.</p> </div> <ul style="list-style-type: none"> <li data-bbox="711 604 1192 835">• Post Processing – Invoice Based - Used to indicate that the pricing is used to generate post processing bill segment. This type of price assignment can be done on an invoice account, and, as a result, the post processing bill segment is generated on the invoice account. <div data-bbox="740 846 1192 957" style="border: 1px solid black; padding: 5px;"> <p>Note: This is not applicable for price items whose Price Item Usage field is set to Pricing.</p> </div> <ul style="list-style-type: none"> <li data-bbox="711 978 1192 1209">• Post Processing – Price Item Based - Used to indicate that the pricing is used to generate post processing bill segment. This type of price assignment can be done on both invoice and usage accounts, but the post processing bill segment is generated only on the invoice account. <div data-bbox="740 1220 1192 1331" style="border: 1px solid black; padding: 5px;"> <p>Note: This field is not applicable for price items whose Price Item Usage field is set to Pricing.</p> </div>	
End Date	Used to specify the date till when the pricing of the price item is effective for the deal.	No
Pricing Currency	Used to indicate the currency in which you want to define the pricing of the price item.	Yes
Pricing Eligibility	<p>Used to define the pricing eligibility criteria for the price item pricing.</p> <div data-bbox="678 1608 1192 1719" style="border: 1px solid black; padding: 5px;"> <p>Note: If you select the check box you can define the pricing eligibility of the price item in the Price Component section of this zone.</p> </div>	No
Print Zero	<p>Used to indicate whether zero pricing should be displayed in the bill. The valid values are:</p> <ul style="list-style-type: none"> <li data-bbox="711 1818 792 1850">• Yes <li data-bbox="711 1871 792 1902">• No 	Yes

Field Name	Field Description	Mandatory (Yes or No)
Rate Schedule	Used to specify the rate schedule that you want to use while defining price item pricing. Note: Rate schedules control how the bills for the price item will be calculated. The Search (🔍) icon appears corresponding to this field. On clicking the Search icon, the Rate Schedule Search window appears where you can search for the respective rate schedule.	Yes

- **TFM Information** - Used to map the transaction details with the price item. It contains the following fields:

Field Name	Field Description	Mandatory (Yes or No)
Transaction Rating Criteria	Used to indicate how and when the transaction legs mapped to the price item are rated. The valid values are: <ul style="list-style-type: none"> • Aggregate Transactions and Then Rate Aggregated SQs • Do Not Rate Transactions • Rate Transaction and Aggregate Calc Lines Across Transaction • Rate Transactions 	Yes
Aggregation Schedule	Used to indicate the transaction aggregation cycle. The valid values are: <ul style="list-style-type: none"> • Daily • Weekly • Monthly • Quarterly • Yearly 	Yes
Do Not Aggregate Switch	Used to Indicate whether aggregation is required while rating the transactions before billing. The valid values are: <ul style="list-style-type: none"> • Yes - Used to Indicate aggregation is not required while rating the transactions before billing. • No - Used to Indicate aggregation is required while rating the transactions before billing. 	Yes
Ignore Transaction	Used to indicate whether the transactions mapped to the price item is considered for billing. The valid values are:	Yes

Field Name	Field Description	Mandatory (Yes or No)
	<ul style="list-style-type: none"> • Yes • No 	

- **Parameters** - Used to associate the parameters based on which you want to define the pricing of the price item. It contains the following columns:

Column Name	Column Description	Mandatory (Yes or No)
Parameter	Used to indicate the parameter that you want to associate with the price item pricing.	Yes (Conditional)
	<p>Note:</p> <p>The Search (🔍) icon appears corresponding to this field. On clicking the Search icon, the Price Item Parameter Search window appears.</p> <p>The parameter search results displays only those parameters where the Price Item check box is selected.</p>	<p>Note: This field is required while associating parameters with the price item pricing.</p>
Parameter Value	Used to specify the value of the parameter.	Yes (Conditional)
		<p>Note: This field is required while associating parameters with the price item pricing.</p>



- **Characteristics** - Used to define a list of characteristics for the price item pricing. It contains the following columns:

Column Name	Column Description	Mandatory (Yes or No)
Effective Date	Used to specify the date from when the characteristic is effective for price item pricing.	Yes (Conditional)
		<p>Note: This field is required while defining characteristics for the price item pricing</p>
Characteristic Type	Used to indicate the characteristic type.	Yes (Conditional)
	<p>Note: The list includes only those characteristic types where the characteristic entity is set to Projected Pricing.</p>	<p>Note: This field is required while defining characteristics for the price item pricing</p>
Characteristic Value	Used to specify the value for the characteristic type.	Yes (Conditional)

Column Name	Column Description	Mandatory (Yes or No)
	<p>Note:</p> <p>If you select a predefined characteristic type, the Search (🔍) icon appears corresponding to the Characteristic Value field. On clicking the Search icon, the Predefined Characteristic Search window appears.</p> <p>On specifying the value for a predefined characteristic type, the description of the characteristic value appears corresponding to the Characteristic Value field.</p>	<p>Note: This field is required while defining characteristics for the price item pricing</p>

- **Price Component** - Used to define a list of price components of the rate component that you want to map with the price item pricing. It contains the following columns:

Column Name	Column Description	Mandatory (Yes or No)
Rate Component	<p>Displays the concatenated string of information about the rate component separated by comma (,).</p> <p>Note:</p> <p>It is a read-only field and cannot be edited.</p> <p>This ID is generated automatically when you define the tiering setup of the rate component.</p>	Not applicable
Display Sequence	Used to specify the sequence of price component whose rate is used for calculating the pricing of the price item.	Yes
Description	Used to specify the description of the price component.	Yes
Show Price Component	Used to indicate whether you want to display the price component in the bill.	Yes (Conditional)
		Note: This field is required for displaying the price component in the bill.
Rate	Used to specify the rate defined for the price component.	Yes
Eligibility and Tier Details	Used to specify the tiering criteria and eligibility criteria of the price component for the price item pricing.	Yes (Conditional)

Column Name	Column Description	Mandatory (Yes or No)										
		Note: This field is required for specifying the tiering criteria and eligibility criteria of the price component for the price item pricing.										
Tier Details	<p>On clicking the Add  icon, you can view and edit the Tiering Criteria of the price component for the price item pricing. It contains the following columns:</p> <table border="1"> <thead> <tr> <th>Column Name</th> <th>Column Description</th> </tr> </thead> <tbody> <tr> <td>Display Sequence</td> <td>Used to specify the sequence of the tiering criteria.</td> </tr> <tr> <td>Tiering Criterion</td> <td>Used to indicate the tiering criteria.</td> </tr> <tr> <td>Lower Limit</td> <td>Used to specify the lower limit of the tiering range.</td> </tr> <tr> <td>Upper Limit</td> <td>Used to specify the upper limit of the tiering range.</td> </tr> </tbody> </table> <p>Note: You can edit the tiering criteria of a price component only when the Tiering Type of its rate component is STEP or THRESHOLD.</p>	Column Name	Column Description	Display Sequence	Used to specify the sequence of the tiering criteria.	Tiering Criterion	Used to indicate the tiering criteria.	Lower Limit	Used to specify the lower limit of the tiering range.	Upper Limit	Used to specify the upper limit of the tiering range.	<p>Yes (Conditional)</p> <p>Note: This field is required for specifying the tiering criteria of the price component for the price item pricing.</p>
Column Name	Column Description											
Display Sequence	Used to specify the sequence of the tiering criteria.											
Tiering Criterion	Used to indicate the tiering criteria.											
Lower Limit	Used to specify the lower limit of the tiering range.											
Upper Limit	Used to specify the upper limit of the tiering range.											
Eligibility Details	<p>On clicking the Add  icon, you can view and edit the eligibility criteria of the price component for the price item pricing. It contains the following columns:</p> <table border="1"> <thead> <tr> <th>Column Name</th> <th>Column Description</th> </tr> </thead> <tbody> <tr> <td>Display Sequence</td> <td>Used to specify the order in which the eligibility criteria should be executed in the rule.</td> </tr> <tr> <td>Parameter</td> <td>Used to indicate the left hand side parameter which you want to use along with the price item for price determination.</td> </tr> </tbody> </table>	Column Name	Column Description	Display Sequence	Used to specify the order in which the eligibility criteria should be executed in the rule.	Parameter	Used to indicate the left hand side parameter which you want to use along with the price item for price determination.	<p>Yes (Conditional)</p> <p>Note: This field is required for specifying the eligibility criteria of the price component for the price item pricing.</p>				
Column Name	Column Description											
Display Sequence	Used to specify the order in which the eligibility criteria should be executed in the rule.											
Parameter	Used to indicate the left hand side parameter which you want to use along with the price item for price determination.											

Column Name	Column Description		Mandatory (Yes or No)
	Column Name	Column Description	
		<p>Note: The Search (🔍) icon appears corresponding to the Parameter field. On clicking the Search icon, the Parameter Search window appears.</p>	
	Operator	Used to specify the relational operator to define the relation between the left hand side and right hand side parameters.	
	Parameter Value Type	<p>Used to indicate the type of pricing eligibility. The valid values are:</p> <ul style="list-style-type: none"> • Parameter - Used to indicate the type of parameter. • Value - Used to indicate the type of value. 	
	Parameter	Used to specify the value for the Parameter Value Type as the right hand side parameter which you want to use along with the price item for price determination.	

Column Name	Column Description		Mandatory (Yes or No)				
	<table border="1"> <thead> <tr> <th data-bbox="683 239 896 281">Column Name</th> <th data-bbox="896 239 1182 281">Column Description</th> </tr> </thead> <tbody> <tr> <td data-bbox="683 281 896 1039"></td> <td data-bbox="896 281 1182 1039"> <p>Note:</p> <p>If you select the Parameter Value Type as Parameter, the Search (🔍) icon appears corresponding to the Parameter field. On clicking the Search icon, the Parameter Search window appears.</p> <p>If you select the Parameter Value Type as Value then you can specify any special characters except ampersand (&), comma (,), underscore (_), equal to (=), tilde (~), and semi-colon (;) in the Parameter field.</p> </td> </tr> </tbody> </table>	Column Name	Column Description		<p>Note:</p> <p>If you select the Parameter Value Type as Parameter, the Search (🔍) icon appears corresponding to the Parameter field. On clicking the Search icon, the Parameter Search window appears.</p> <p>If you select the Parameter Value Type as Value then you can specify any special characters except ampersand (&), comma (,), underscore (_), equal to (=), tilde (~), and semi-colon (;) in the Parameter field.</p>		
Column Name	Column Description						
	<p>Note:</p> <p>If you select the Parameter Value Type as Parameter, the Search (🔍) icon appears corresponding to the Parameter field. On clicking the Search icon, the Parameter Search window appears.</p> <p>If you select the Parameter Value Type as Value then you can specify any special characters except ampersand (&), comma (,), underscore (_), equal to (=), tilde (~), and semi-colon (;) in the Parameter field.</p>						
	Is True	<p>Used to indicate what happens when the condition is true (satisfied). The valid values are:</p> <ul style="list-style-type: none"> • Check next condition - Used to indicate that the condition with the consecutive sequence number is executed. • Rule is false - Used to indicate that the action specified in the Rule False Action field is executed. • Rule is true - Used to indicate that the action specified in the Rule True 					

Column Name	Column Description		Mandatory (Yes or No)
	Column Name	Column Description	
		Action field is executed.	
	Is False	<p>Used to indicate what happens when the condition is false (not satisfied). The valid values are:</p> <ul style="list-style-type: none"> • Check next condition - Used to indicate that the condition with the consecutive sequence number is executed. • Rule is false - Used to indicate that the action specified in the Rule False Action field is executed. • Rule is true - Used to indicate that the action specified in the Rule True Action field is executed. 	
	Is Insufficient	<p>Used to indicate what happens when the data is insufficient. The valid values are:</p> <ul style="list-style-type: none"> • Check next condition - Used to indicate that the condition with the consecutive sequence number is executed. • Rule is false - Used to indicate that the action specified in the Rule False Action field is executed. 	

Column Name	Column Description		Mandatory (Yes or No)
	Column Name	Column Description	
		<ul style="list-style-type: none"> • Rule is true <ul style="list-style-type: none"> - Used to indicate that the action specified in the Rule True Action field is executed. 	
	<p>Note: You can edit the eligibility criteria of a price component only when the Pricing Eligibility check box is selected.</p>		

2. Modify the required details in the **Projected Pricing** zone.

3. Click **Save**

The changes made to the proposed price item pricing are saved.

Related Topics

For more information on...	See...
Projected Pricing zone	Projected Pricing on page 3003
Pricing and Commitments screen	Pricing and Commitments on page 3002

Overriding a Proposed Price Item Pricing

Prerequisites

To override a proposed price item pricing, you should have:

- Values defined for the **Price Assignment Type** in the **PA_TYPE_FLAG** lookup field
- Currencies defined in the application
- Rate schedules, rate versions, and rate components defined in the application
- Values defined for **Transaction Rating Criteria** in the **TXN_RATING_CRITERIA** lookup field
- Values defined for **Pricing Rule Type** in the **PRC_RULE_TYPE_FLG** lookup field
- Aggregation schedules defined in the application
- Parameters defined in the application (where the **Price Item** option is selected in the **Parameter Usage** section)
- Characteristic types defined in the application (where the characteristic entity is set to **Price Item Pricing**)
- Transactions mapped to the price item defined in the application
- Tiering criteria defined in the application
- Tiering setup for the rate components defined in the application
- Pricing eligibility defined in the application

Procedure

To override a proposed price item pricing:

1. Ensure that the **Projected Pricing** zone is expanded in the **Pricing and Commitments** screen when you are overriding the *proposed pricing* of a price item.

The **Projected Pricing** zone contains the following field:

Field Name	Field Description	Mandatory (Yes or No)
Override	Used to indicate whether you want to override the price item pricing.	Yes

Note:

A new price assignment ID is created when you override a proposed price item pricing.

While overriding a price item pricing, you can define a seasonal pricing for a price item by changing the pricing effective date to a date greater than the deal start date.

In addition, the **Projected Pricing** zone contains the following sections:

- **Main** - Used to specify basic details about the price item pricing. It contains the following fields:

Field Name	Field Description	Mandatory (Yes or No)
Price Assignment ID	Displays the price assignment ID.	Not Applicable
	Note: It is a read-only field and cannot be edited.	
Price Item	Displays the price item whose pricing you want to edit.	Not Applicable
	Note: It is a read-only field and cannot be edited.	
Start Date	Use to specify the date from when the pricing of the price item is effective for the deal.	Yes
	Note: By default the deal start date appears in this field.	
Price Assignment Type	Used to indicate the type of price assignment. The valid values are: <ul style="list-style-type: none"> • Regular - Used to indicate that the pricing is used to generate regular bill segment. • Post Processing - Used to indicate that the pricing is used to generate post processing bill segment. This type of price assignment can be done on usage accounts. The post processing bill segment is generated when you generate the bill for the usage account and not when you bill the usage account through an invoice account. 	Yes

Field Name	Field Description	Mandatory (Yes or No)
	<p data-bbox="743 239 1187 474">Note: The post processing bill segment is generated when the Post Processing Sequence (PPSEQ) characteristic is defined for the price item and when the price item is associated with another price item using the Price Item Relationship Type.</p> <ul data-bbox="711 491 1187 709" style="list-style-type: none"> • Post Processing – Invoice Based - Used to indicate that the pricing is used to generate post processing bill segment. This type of price assignment can be done on an invoice account, and, as a result, the post processing bill segment is generated on the invoice account. <p data-bbox="743 737 1187 842">Note: This is not applicable for price items whose Price Item Usage field is set to Pricing.</p> <ul data-bbox="711 863 1187 1081" style="list-style-type: none"> • Post Processing – Price Item Based - Used to indicate that the pricing is used to generate post processing bill segment. This type of price assignment can be done on both invoice and usage accounts, but the post processing bill segment is generated only on the invoice account. <p data-bbox="743 1108 1187 1213">Note: This field is not applicable for price items whose Price Item Usage field is set to Pricing.</p>	
End Date	Used to specify the date till when the pricing of the price item is effective for the deal.	No
Pricing Currency	Used to indicate the currency in which you want to define the pricing of the price item.	Yes
Pricing Eligibility	<p data-bbox="680 1423 1187 1486">Used to define the pricing eligibility criteria for the price item pricing.</p> <p data-bbox="680 1514 1187 1608">Note: If you select the check box you can define the pricing eligibility of the price item in the Price Component section of this zone.</p>	No
Print Zero	<p data-bbox="680 1646 1187 1709">Used to indicate whether zero pricing should be displayed in the bill. The valid values are:</p> <ul data-bbox="711 1730 792 1801" style="list-style-type: none"> • Yes • No 	Yes
Rate Schedule	Used to specify the rate schedule that you want to use while defining price item pricing.	Yes

Field Name	Field Description	Mandatory (Yes or No)
	<p>Note:</p> <p>Rate schedules control how the bills for the price item will be calculated.</p> <p>The Search (🔍) icon appears corresponding to this field. On clicking the Search icon, the Rate Schedule Search window appears where you can search for the respective rate schedule.</p>	

- **TFM Information** - Used to map the transaction details with the price item. It contains the following fields:

Field Name	Field Description	Mandatory (Yes or No)
Transaction Rating Criteria	<p>Used to indicate how and when the transaction legs mapped to the price item are rated. The valid values are:</p> <ul style="list-style-type: none"> • Aggregate Transactions and Then Rate Aggregated SQs • Do Not Rate Transactions • Rate Transaction and Aggregate Calc Lines Across Transaction • Rate Transactions 	Yes
Aggregation Schedule	<p>Used to indicate the transaction aggregation cycle. The valid values are:</p> <ul style="list-style-type: none"> • Daily • Weekly • Monthly • Quarterly • Yearly 	Yes
Do Not Aggregate Switch	<p>Used to Indicate whether aggregation is required while rating the transactions before billing. The valid values are:</p> <ul style="list-style-type: none"> • Yes - Used to Indicate aggregation is not required while rating the transactions before billing. • No - Used to Indicate aggregation is required while rating the transactions before billing. 	Yes
Ignore Transaction	<p>Used to indicate whether the transactions mapped to the price item is considered for billing. The valid values are:</p> <ul style="list-style-type: none"> • Yes 	Yes

Field Name	Field Description	Mandatory (Yes or No)
	<ul style="list-style-type: none"> No 	

- **Parameters** - Used to associate the parameters based on which you want to define the pricing of the price item. It contains the following columns:

Column Name	Column Description	Mandatory (Yes or No)
Parameter	Used to indicate the parameter that you want to associate with the price item pricing.	Yes (Conditional)
	<p>Note:</p> <p>The Search (🔍) icon appears corresponding to this field. On clicking the Search icon, the Price Item Parameter Search window appears.</p> <p>The parameter search results displays only those parameters where the Price Item check box is selected.</p>	<p>Note: This field is required while associating parameters with the price item pricing.</p>
Parameter Value	Used to specify the value of the parameter.	Yes (Conditional)
		<p>Note: This field is required while associating parameters with the price item pricing.</p>



- **Characteristics** - Used to define a list of characteristics for the price item pricing. It contains the following columns:

Column Name	Column Description	Mandatory (Yes or No)
Effective Date	Used to specify the date from when the characteristic is effective for price item pricing.	Yes (Conditional)
		<p>Note: This field is required while defining characteristics for the price item pricing</p>
Characteristic Type	Used to indicate the characteristic type.	Yes (Conditional)
	<p>Note: The list includes only those characteristic types where the characteristic entity is set to Projected Pricing.</p>	<p>Note: This field is required while defining characteristics for the price item pricing</p>
Characteristic Value	Used to specify the value for the characteristic type.	Yes (Conditional)

Column Name	Column Description	Mandatory (Yes or No)
	<p>Note:</p> <p>If you select a predefined characteristic type, the Search (🔍) icon appears corresponding to the Characteristic Value field. On clicking the Search icon, the Predefined Characteristic Search window appears.</p> <p>On specifying the value for a predefined characteristic type, the description of the characteristic value appears corresponding to the Characteristic Value field.</p>	<p>Note: This field is required while defining characteristics for the price item pricing</p>

- **Price Component** - Used to define a list of price components of the rate component that you want to map with the price item pricing. It contains the following columns:

Column Name	Column Description	Mandatory (Yes or No)
Rate Component	<p>Displays the concatenated string of information about the rate component separated by comma (,).</p> <p>Note:</p> <p>It is a read-only field and cannot be edited.</p> <p>This ID is generated automatically when you define the tiering setup of the rate component.</p>	Not applicable
Display Sequence	Used to specify the sequence of price component whose rate is used for calculating the pricing of the price item.	Yes
Description	Used to specify the description of the price component.	Yes
Show Price Component	Used to indicate whether you want to display the price component in the bill.	Yes (Conditional)
		Note: This field is required for displaying the price component in the bill.
Rate	Used to specify the rate defined for the price component.	Yes
Eligibility and Tier Details	Used to specify the tiering criteria and eligibility criteria of the price component for the price item pricing.	Yes (Conditional)

Column Name	Column Description	Mandatory (Yes or No)										
		Note: This field is required for specifying the tiering criteria and eligibility criteria of the price component for the price item pricing.										
Tier Details	<p>On clicking the Add  icon, you can view and edit the Tiering Criteria of the price component for the price item pricing. It contains the following columns:</p> <table border="1"> <thead> <tr> <th>Column Name</th> <th>Column Description</th> </tr> </thead> <tbody> <tr> <td>Display Sequence</td> <td>Used to specify the sequence of the tiering criteria.</td> </tr> <tr> <td>Tiering Criterion</td> <td>Used to indicate the tiering criteria.</td> </tr> <tr> <td>Lower Limit</td> <td>Used to specify the lower limit of the tiering range.</td> </tr> <tr> <td>Upper Limit</td> <td>Used to specify the upper limit of the tiering range.</td> </tr> </tbody> </table> <p>Note: You can edit the tiering criteria of a price component only when the Tiering Type of its rate component is STEP or THRESHOLD.</p>	Column Name	Column Description	Display Sequence	Used to specify the sequence of the tiering criteria.	Tiering Criterion	Used to indicate the tiering criteria.	Lower Limit	Used to specify the lower limit of the tiering range.	Upper Limit	Used to specify the upper limit of the tiering range.	<p>Yes (Conditional)</p> <p>Note: This field is required for specifying the tiering criteria of the price component for the price item pricing.</p>
Column Name	Column Description											
Display Sequence	Used to specify the sequence of the tiering criteria.											
Tiering Criterion	Used to indicate the tiering criteria.											
Lower Limit	Used to specify the lower limit of the tiering range.											
Upper Limit	Used to specify the upper limit of the tiering range.											
Eligibility Details	<p>On clicking the Add  icon, you can view and edit the eligibility criteria of the price component for the price item pricing. It contains the following columns:</p> <table border="1"> <thead> <tr> <th>Column Name</th> <th>Column Description</th> </tr> </thead> <tbody> <tr> <td>Display Sequence</td> <td>Used to specify the order in which the eligibility criteria should be executed in the rule.</td> </tr> <tr> <td>Parameter</td> <td>Used to indicate the left hand side parameter which you want to use along with the price item for price determination.</td> </tr> </tbody> </table>	Column Name	Column Description	Display Sequence	Used to specify the order in which the eligibility criteria should be executed in the rule.	Parameter	Used to indicate the left hand side parameter which you want to use along with the price item for price determination.	<p>Yes (Conditional)</p> <p>Note: This field is required for specifying the eligibility criteria of the price component for the price item pricing.</p>				
Column Name	Column Description											
Display Sequence	Used to specify the order in which the eligibility criteria should be executed in the rule.											
Parameter	Used to indicate the left hand side parameter which you want to use along with the price item for price determination.											

Column Name	Column Description		Mandatory (Yes or No)
	Column Name	Column Description	
		<p>Note: The Search (🔍) icon appears corresponding to the Parameter field. On clicking the Search icon, the Parameter Search window appears.</p>	
	Operator	Used to specify the relational operator to define the relation between the left hand side and right hand side parameters.	
	Parameter Value Type	<p>Used to indicate the type of pricing eligibility. The valid values are:</p> <ul style="list-style-type: none"> • Parameter - Used to indicate the type of parameter. • Value - Used to indicate the type of value. 	
	Parameter	Used to specify the value for the Parameter Value Type as the right hand side parameter which you want to use along with the price item for price determination.	

Column Name	Column Description		Mandatory (Yes or No)
	Column Name	Column Description	
		<p>Note:</p> <p>If you select the Parameter Value Type as Parameter, the Search (🔍) icon appears corresponding to the Parameter field. On clicking the Search icon, the Parameter Search window appears.</p> <p>If you select the Parameter Value Type as Value then you can specify any special characters except ampersand (&), comma (,), underscore (_), equal to (=), tilde (~), and semi-colon (;) in the Parameter field.</p>	
	Is True	<p>Used to indicate what happens when the condition is true (satisfied). The valid values are:</p> <ul style="list-style-type: none"> • Check next condition - Used to indicate that the condition with the consecutive sequence number is executed. • Rule is false - Used to indicate that the action specified in the Rule False Action field is executed. • Rule is true - Used to indicate that the action specified in the Rule True 	

Column Name	Column Description		Mandatory (Yes or No)								
	<table border="1"> <thead> <tr> <th data-bbox="673 233 906 281">Column Name</th> <th data-bbox="906 233 1192 281">Column Description</th> </tr> </thead> <tbody> <tr> <td data-bbox="673 281 906 365"></td> <td data-bbox="906 281 1192 365"> <p>Action field is executed.</p> </td> </tr> <tr> <td data-bbox="673 365 906 1297">Is False</td> <td data-bbox="906 365 1192 1297"> <p>Used to indicate what happens when the condition is false (not satisfied). The valid values are:</p> <ul style="list-style-type: none"> • Check next condition - Used to indicate that the condition with the consecutive sequence number is executed. • Rule is false - Used to indicate that the action specified in the Rule False Action field is executed. • Rule is true - Used to indicate that the action specified in the Rule True Action field is executed. </td> </tr> <tr> <td data-bbox="673 1297 906 1944">Is Insufficient</td> <td data-bbox="906 1297 1192 1944"> <p>Used to indicate what happens when the data is insufficient. The valid values are:</p> <ul style="list-style-type: none"> • Check next condition - Used to indicate that the condition with the consecutive sequence number is executed. • Rule is false - Used to indicate that the action specified in the Rule False Action field is executed. </td> </tr> </tbody> </table>	Column Name	Column Description		<p>Action field is executed.</p>	Is False	<p>Used to indicate what happens when the condition is false (not satisfied). The valid values are:</p> <ul style="list-style-type: none"> • Check next condition - Used to indicate that the condition with the consecutive sequence number is executed. • Rule is false - Used to indicate that the action specified in the Rule False Action field is executed. • Rule is true - Used to indicate that the action specified in the Rule True Action field is executed. 	Is Insufficient	<p>Used to indicate what happens when the data is insufficient. The valid values are:</p> <ul style="list-style-type: none"> • Check next condition - Used to indicate that the condition with the consecutive sequence number is executed. • Rule is false - Used to indicate that the action specified in the Rule False Action field is executed. 		
Column Name	Column Description										
	<p>Action field is executed.</p>										
Is False	<p>Used to indicate what happens when the condition is false (not satisfied). The valid values are:</p> <ul style="list-style-type: none"> • Check next condition - Used to indicate that the condition with the consecutive sequence number is executed. • Rule is false - Used to indicate that the action specified in the Rule False Action field is executed. • Rule is true - Used to indicate that the action specified in the Rule True Action field is executed. 										
Is Insufficient	<p>Used to indicate what happens when the data is insufficient. The valid values are:</p> <ul style="list-style-type: none"> • Check next condition - Used to indicate that the condition with the consecutive sequence number is executed. • Rule is false - Used to indicate that the action specified in the Rule False Action field is executed. 										

Column Name	Column Description		Mandatory (Yes or No)
	Column Name	Column Description	
		<ul style="list-style-type: none"> • Rule is true <ul style="list-style-type: none"> - Used to indicate that the action specified in the Rule True Action field is executed. 	
	<p>Note: You can edit the eligibility criteria of a price component only when the Pricing Eligibility check box is selected.</p>		

2. Enter the required details in the **Projected Pricing** zone.

3. Click **Override**.

The proposed price item pricing is overridden.

Related Topics

For more information on...	See...
Projected Pricing zone	Projected Pricing on page 3003
Pricing and Commitments screen	Pricing and Commitments on page 3002

Editing a Proposed Commitment

Prerequisites

To edit a proposed commitment you should have:

- Proposed commitments defined for a price item

Procedure

To edit a proposed commitment:

1. Ensure that price item hierarchy is expanded in the **Pricing and Commitments** section of the **Pricing and Commitments** screen.
2. In the **Pricing and Commitments** section, click the **Edit** (✎) icon in the **Volume and Commitments** column corresponding to the price item whose proposed commitment you want to edit.

The **Pricing and Commitments** screen appears. It contains the following sections:

- **Proposed Commitments** - Used to view or edit the proposed commitments of the price item for a customer or an account in a deal.
- **Original Volume** - Displays information about the existing commitments of the price item.

The **Proposed Commitments** section contains the following columns:

Column Name	Column Description	Mandatory (Yes or No)
Price Item	Displays the price item.	Not applicable

Column Name	Column Description	Mandatory (Yes or No)
Pricing Parameters	Indicates the price item parameters which are used along with the price item for determining the price item pricing.	Not applicable
SQI	Indicates the service quantity identifier.	Not applicable
Service Quantity	Used to specify the SQI value using which the rates engine calculates the price item pricing.	Yes

- Modify the required details in the **Proposed Commitments** section.

Note: You cannot edit a proposed commitment of a price item if the deal or deal version is in the **Finalized** status.

- Click **Save**.

The changes made to the proposed commitment is saved.

Related Topics

For more information on...	See...
Pricing and Commitments section	Pricing and Commitments on page 2936
Pricing and Commitments screen	Pricing and Commitments on page 2934
Price Assignment Commitments screen	Price Assignment Commitments

Mapping Terms and Conditions

The **Mapping Terms and Conditions** screen enables you to associate deal-specific terms and conditions with a price item or hierarchy entity of a person or account from the customer hierarchy in a deal. It contains the following sections:

- Main** - The **Main** section indicates the price item or hierarchy entity with which you want to associate deal-specific terms and conditions. It contains the following fields:

Field Name	Field Description
Price Item	Indicates the price item of the person or account from the customer hierarchy in a deal with which you want to associate deal-specific terms and conditions. Note: This field appears when you are associating deal-specific terms and conditions with a price item.
Hierarchy Entity	Indicates the hierarchy entity of the person or account from the customer hierarchy in a deal with which you want to associate deal-specific terms and conditions. Note: This field appears when you are associating deal-specific terms and conditions with a hierarchy entity.

- Deal-Specific Terms and Conditions** - The **Deal-Specific Terms and Conditions** section allows you to associate or disassociate deal-specific terms and conditions from the price item or hierarchy entity of a person or account from the customer hierarchy in a deal. It contains the following columns:

Column Name	Column Description
Terms and Conditions	Used to indicate a deal-specific term and condition which you want to associate with the price item or the hierarchy entity of the person or account.
Default	Used to indicate whether the term and condition is default or not.

Related Topics

For more information on...	See...
How to search for a deal	Searching for a Deal on page 2773
Deal Dashboard screen	Deal Dashboard on page 2757
Search Deal zone	Search Deal on page 2758
Simulation Details zone	Simulation Details on page 2847
Pricing and Commitments screen	Pricing and Commitments on page 2934
How to associate deal-specific terms and conditions with a price item	Associating Deal-Specific Terms and Conditions with a Price Item on page 2964
How to associate deal-specific terms and conditions with a hierarchy entity	Associating Deal-Specific Terms and Conditions with a Hierarchy Entity on page 2965

Editing Deal-Specific Terms and Conditions

Prerequisites

To edit deal-specific terms and conditions you should have:

- Terms and conditions associated with the deal

Procedure

To edit deal-specific terms and conditions:

1. Search for the deal in the **Deal Dashboard** screen.
2. In the **Search Results** section, click the link in the **Deal Information** column corresponding to the deal whose terms and conditions you want to edit.
The **Deal Information** screen appears.
3. Ensure that the customer hierarchy is expanded in the **Simulation Details** zone.
4. Click the **Edit** (✎) icon in the **Pricing and Commitments** column corresponding to the person or account whose terms and conditions you want to edit.
The **Pricing and Commitments** screen appears.
5. Ensure that the **Price Item Hierarchy** sub-section is expanded in the **Pricing and Commitments** section when you are editing the deal-specific terms and conditions.

6. Click the **Edit** (✎) icon in the **Terms and Conditions** column corresponding to the price item, root level hierarchy entity, or non-level hierarchy entity whose terms and conditions you want to edit.

The **Mapping Terms and Conditions** screen appears. It contains the following sections:

- **Main** - The **Main** section displays the hierarchy entity to which the deal-specific terms and conditions are associated. It contains the following fields:

Field Name	Field Description	Mandatory (Yes or No)
Price Item	Indicates the price item whose deal-specific terms and conditions you want to edit.	Not applicable
	Note: This field appears when you are editing the deal-specific terms and conditions of a price item.	
Root Level Hierarchy Entity	Indicates the root level hierarchy entity whose deal-specific terms and conditions you want to edit.	Not applicable
	Note: This field appears only when you are editing the deal-specific terms and conditions of a root level hierarchy entity.	
Non-Root Level Hierarchy Entity	Indicates the non-root level hierarchy entity whose deal-specific terms and conditions you want to edit.	Not applicable
	Note: This field appears only when you are editing the deal-specific terms and conditions of a non-root level hierarchy entity.	

- **Deal-Specific Terms and Conditions** - The **Deal-Specific Terms and Conditions** section lists the deal-specific terms and conditions associated with the hierarchy entity. It contains the following columns:

Column Name	Column Description	Mandatory (Yes or No)
Terms and Conditions	Indicates the deal-specific terms and conditions associated with the price item, root level hierarchy entity, or non-root level hierarchy entity.	Not applicable
Default	Indicates whether the term and condition is default or not.	Not applicable

7. Edit the required term and condition in the **Deal-Specific Terms and Conditions** section.

Note: You can only disassociate a deal-specific term and condition from the **Deal-Specific Terms and Conditions** section.

8. Click the **Delete** (🗑️) icon corresponding to the term and condition that you want to disassociate from the deal.

Note: You cannot delete a term and condition which is set as default for the hierarchy entity.

9. Click **Save**.

The changes are made to the deal-specific terms and conditions.

Related Topics

For more information on...	See...
How to search for a deal	Searching for a Deal on page 2773

For more information on...	See...
Deal Dashboard screen	Deal Dashboard on page 2757
Search Deal zone	Search Deal on page 2758
Simulation Details zone	Simulation Details on page 2847
Pricing and Commitments screen	Pricing and Commitments on page 2934
Pricing and Commitments section	Pricing and Commitments on page 2936

Terms and Conditions

The **Terms and Conditions** screen allows you to associate, disassociate, edit, or view the terms and conditions of the deal. It also allows you to add adhoc terms and conditions for the deal. It contains the following field:

Field Name	Field Description
Deal Information	Displays the concatenated string of information about the deal.

In addition, the **Terms and Conditions** screen contains the following sections:

- **Terms and Conditions Section** - Lists the terms and conditions that are mapped to the deal. It contains the following buttons:

Button Name	Button Description
Select All	Used to select all the available terms and conditions for the deal from the list.
De-select All	Used to de-select all the terms and conditions from the list.
Refresh Terms and Conditions	Used to de-select the terms and conditions that are selected for the deal from the list.

Note: You can also select or de-select the terms and conditions by clicking the check box corresponding to the respective terms and conditions.

On clicking the **Edit** () icon corresponding to the terms and conditions in the **Terms and Conditions Section** section, you can view and edit the terms and conditions of the deal.

- **Adhoc Terms and Conditions** - Used to add adhoc terms and conditions for the deal.

Related Topics

For more information on...	See...
How to associate the terms and conditions with a deal	Associating the Terms and Conditions with a Deal on page 3038
How to edit the terms and conditions of a deal	Editing the Terms and Conditions of a Deal on page 3039
How to view the terms and conditions of the deal	Viewing the Terms and Conditions of a Deal on page 3040

Associating the Terms and Conditions with a Deal

Prerequisites

To associate terms and conditions with a deal you should have:

- Terms and conditions defined in the application

Procedure

To associate terms and conditions with a deal:

1. Search for the deal in the **Search Deal** zone of the **Deal Dashboard** screen to which you want to associate the terms and conditions.
2. Click the **Terms and Conditions** link at the top right corner of the **Deal Information** zone.
The **Terms and Conditions** screen appears.
3. Ensure that the **Terms and Conditions** section is expanded in the **Terms and Conditions** screen.
4. Select the required terms and conditions by clicking the check box corresponding to the terms and conditions in the **Terms and Conditions** section.
5. Click **Save**.

The terms and conditions are associated with the deal.

Note: You can associate terms and conditions with a deal until the deal is in the **Customer Accepted** or **Rejected** status.

Related Topics

For more information on...	See...
How to search for a deal	Searching for a Deal on page 2773
Search Deal zone	Search Deal on page 2758
Deal Dashboard screen	Deal Dashboard on page 2757
Deal Information zone	Deal Information on page 2845
Terms and Conditions screen	Terms and Conditions on page 3038

Editing the Terms and Conditions of a Deal

Prerequisites

To edit the terms and conditions of a deal you should have:

- Terms and conditions associated with the deal

Procedure

To edit the terms and conditions of a deal:

1. Search for the deal in the **Search Deal** zone of the **Deal Dashboard** screen.
2. Click the **Deal Terms and Conditions** link at the top right corner of the **Deal Information** zone.
The **Terms and Conditions** screen appears.
3. Ensure that the **Terms and Conditions Section** section is expanded in the **Terms and Conditions** screen.
4. Click the **Edit**  icon corresponding to the terms and conditions which you want to edit.

The **Terms and Conditions** window appears. It contains the following fields:

Field Name	Field Description
Terms and Conditions	Indicates the terms and conditions associated with the deal.
Description	Displays the description of the terms and conditions.
Attached File Name	Indicates the terms and conditions document name.

Field Name	Field Description
Terms and Conditions Text	Displays the terms and conditions.

5. Click **Edit**.

The **Terms and Conditions Text** field is enabled.

6. Modify the required information from the terms and conditions in the **Terms and Conditions Text** field.

7. Click **Save**.

The changes made to the terms and conditions are saved.

Note: You can edit the terms and conditions of a deal until the deal is in the **Customer Accepted** or **Rejected** status.

Related Topics

For more information on...	See...
How to search for a deal	Searching for a Deal on page 2773
Search Deal zone	Search Deal on page 2758
Deal Dashboard screen	Deal Dashboard on page 2757
Deal Information zone	Deal Information on page 2845
Terms and Conditions screen	Terms and Conditions on page 3038

Viewing the Terms and Conditions of a Deal

Prerequisites

To view the terms and conditions of a deal you should have:

- Terms and conditions associated with the deal

Procedure

To view the terms and conditions of a deal:

1. Search for the deal in the **Search Deal** zone of the **Deal Dashboard** screen.
2. Click the **Deal Terms and Conditions** link at the top right corner of the **Deal Information** zone.
The **Terms and Conditions** screen appears.
3. Ensure that the **Terms and Conditions Section** section is expanded in the **Terms and Conditions** screen.
4. Click the **Edit**  icon corresponding to the terms and conditions which you want to view.
The **Terms and Conditions** window appears.
5. View the terms and conditions in the **Terms and Conditions Text** field of the **Terms and Conditions** window.

Related Topics

For more information on...	See...
How to search for a deal	Searching for a Deal on page 2773
Search Deal zone	Search Deal on page 2758
Deal Dashboard screen	Deal Dashboard on page 2757
Deal Information zone	Deal Information on page 2845

For more information on...	See...
Terms and Conditions screen	Terms and Conditions on page 3038

Deal Log and Comments

The **Deal Log and Comments** screen allows you to view the complete trail of actions performed on the deal. It also allows you to manually add a log entry for the deal. It contains the following sections:

- **Log** - The **Log** section contains the following fields:

Field Name	Field Description
Deal ID	Displays the deal ID.
Deal Information	Displays the concatenated string of deal information separated by a comma (,).

In addition, the **Log** section contains the following columns:

Column Name	Column Description
Creation Date Time	Displays the date and time when the action was performed on the deal due to which the log is created in the system.
Details	Displays the details of the actions performed on the deal.
User	Indicates the user who has performed the action on the deal.
Log Type	Indicates the type of log using which the action is performed on the deal.
Related Object	Indicates the object or entity which is created when the action is performed on the deal. Note: At present, no data appears in this column. The implementation team can build the custom logic to meet the business requirements.
Status Reason	Indicates the reason why the action is performed on the deal.

- **Comments** - The **Comments** section contains the following columns:

Column Name	Column Description
Creation Date Time	Displays the date and time when the log entry is created for the deal in the system.
User	Indicates the user who has created the log entry for the deal in the system.
Comments	Displays the reason why the log entry is created for the deal.

In addition, the **Comments** section contains the following field:

Field Name	Field Description
Comment	Used to specify the reason for creating a new log entry for the deal.

Related Topics

For more information on...	See...
Deal Information screen	Deal Information on page 2815

For more information on...	See...
Deal Information zone	Deal Information on page 2845
How to view the logs of a deal	Viewing the Logs of a Deal on page 3042
How to add a log entry for a deal	Adding a Log Entry for a Deal on page 3043

Viewing the Logs of a Deal

Procedure

To view the logs of a deal:

1. Search for the deal in the **Search Deal** zone of the **Deal Dashboard** screen whose logs you want to view.
2. Click the **Deal Log** link at the top right corner of the **Deal Information** zone.

The **Deal Log and Comments** screen appears.

3. Click the **Log** or **Show All** link in the **Section** pane of the **Deal Log and Comments** screen.

The **Log** section appears. It contains the following fields:

Field Name	Field Description
Deal ID	Displays the deal ID.
Deal Information	Displays the concatenated string of deal information separated by a comma (,).

In addition, the **Log** section contains the following columns:

Column Name	Column Description
Creation Date Time	Displays the date and time when the action was performed on the deal due to which the log is created in the system.
Details	Displays the details of the actions performed on the deal.
User	Indicates the user who has performed the action on the deal.
Log Type	Indicates the type of log using which the action is performed on the deal.
Related Object	Indicates the object or entity which is created when the action is performed on the deal. Note: At present, no data appears in this column. The implementation team can build the custom logic to meet the business requirements.
Status Reason	Indicates the reason why the action is performed on the deal.

4. View the logs of the deal in the **Log** and the **Comments** sections.

Related Topics

For more information on...	See...
Deal Dashboard screen	Deal Dashboard on page 2757
Search Deal zone	Search Deal on page 2758
Deal Information screen	Deal Information on page 2815
Deal Information zone	Deal Information on page 2845

For more information on...	See...
Deal Log and Comments screen	Deal Log and Comments on page 3041

Adding a Log Entry for a Deal

Procedure

To add a log entry for a deal:

1. Search for the deal in the **Search Deal** zone of the **Deal Dashboard** screen for which you want to add a log entry.
2. Click the **Deal Log** link at the top right corner of the **Deal Information** zone.
The **Deal Log and Comments** screen appears.
3. Click the **Comments** or **Show All** link in the **Section** pane of the **Deal Log and Comments** screen.

The **Comments** section appears. It contains the following columns:

Column Name	Column Description	Mandatory (Yes or No)
Creation Date Time	Displays the date and time when the log entry is created for the deal in the system.	Not applicable
User	Indicates the user who has created the log entry for the deal in the system.	Not applicable
Comments	Displays the reason why the log entry is created for the deal.	Not applicable

In addition, the **Comments** section contains the following field:

Field Name	Field Description	Mandatory (Yes or No)
Comment	Used to specify the reason for creating a new log entry for the deal.	Yes

4. Enter the required details in the **Comment** field.
5. Click **Save**.

The log entry is created for the deal.

Related Topics

For more information on...	See...
Deal Dashboard screen	Deal Dashboard on page 2757
Search Deal zone	Search Deal on page 2758
Deal Information screen	Deal Information on page 2815
Deal Information zone	Deal Information on page 2845
Deal Log and Comments screen	Deal Log and Comments on page 3041

Deal Version Log and Comments

The **Deal Version Log and Comments** screen allows you to view the complete trail of actions performed on the deal version. It also allows you to manually add a log entry for the deal version. It contains the following sections:

- **Log** - The **Log** section contains the following fields:

Field Name	Field Description
Deal ID	Displays the deal ID for which the deal version is created in the system.
Deal Information	Displays the concatenated string of deal information separated by a comma (,) for which the deal version is created in the system.
Deal Version ID	Displays the deal version ID.
Deal Version Information	Displays the concatenated string of deal version information separated by a comma (,).

In addition, the **Log** section contains the following columns:

Column Name	Column Description
Creation Date Time	Displays the date and time when the action was performed on the deal version due to which the log is created in the system.
Details	Displays the details of the actions performed on the deal version.
User	Indicates the user who has performed the action on the deal version.
Log Type	Indicates the type of log using which the action is performed on the deal version.
Related Object	Indicates the object or entity which is created when the action is performed on the deal version.
	Note: At present, no data appears in this column. The implementation team can build the custom logic to meet the business requirements.

- **Comments** - The **Comments** section contains the following columns:

Column Name	Column Description
Creation Date Time	Displays the date and time when the log entry is created for the deal version in the system.
User	Indicates the user who has created the log entry for the deal version in the system.
Comments	Displays the reason why the log entry is created for the deal version.

In addition, the **Comments** section contains the following field:

Field Name	Field Description
Comment	Used to specify the reason for creating a new log entry for the deal version.

Related Topics

For more information on...	See...
Deal Information screen	Deal Information on page 2815
Deal Information zone	Deal Information on page 2845
How to view the logs of a deal version	Viewing the Logs of a Deal Version on page 3045

For more information on...	See...
How to add a log entry for a deal version	Adding a Log Entry for a Deal Version on page 3046

Viewing the Logs of a Deal Version

Procedure

To view the logs of a deal version:

1. Search for the deal version in the **Search Deal** zone of the **Deal Dashboard** screen whose logs you want to view.
2. Click the **Deal Version Log** link at the top right corner of the **Deal Information** zone.
The **Deal Version Log and Comments** screen appears.
3. Click the **Log** or **Show All** link in the **Section** pane of the **Deal Version Log and Comments** screen.

The **Log** section appears. It contains the following fields:

Field Name	Field Description
Deal ID	Displays the deal ID for which the deal version is created in the system.
Deal Information	Displays the concatenated string of deal information separated by a comma (,) for which the deal version is created in the system.
Deal Version ID	Displays the deal version ID.
Deal Version Information	Displays the concatenated string of deal version information separated by a comma (,).

In addition, the **Log** section contains the following columns:

Column Name	Column Description
Creation Date Time	Displays the date and time when the action was performed on the deal version due to which the log is created in the system.
Details	Displays the details of the actions performed on the deal version.
User	Indicates the user who has performed the action on the deal version.
Log Type	Indicates the type of log using which the action is performed on the deal version.
Related Object	Indicates the object or entity which is created when the action is performed on the deal version. Note: At present, no data appears in this column. The implementation team can build the custom logic to meet the business requirements.

4. View the logs of the deal version in the **Log** and the **Comments** sections.

Related Topics

For more information on...	See...
Deal Dashboard screen	Deal Dashboard on page 2757
Search Deal zone	Search Deal on page 2758

For more information on...	See...
Deal Information screen	Deal Information on page 2815
Deal Information zone	Deal Information on page 2845
Deal Version Log and Comments screen	Deal Version Log and Comments on page 3043

Adding a Log Entry for a Deal Version

Procedure

To add a log entry for a deal version:

1. Search for the deal version in the **Search Deal** zone of the **Deal Dashboard** screen for which you want to add a log entry.
2. Click the **Deal Version Log** link at the top right corner of the **Deal Information** zone.
The **Deal Version Log and Comments** screen appears.
3. Click the **Comments** or **Show All** link in the **Section** pane of the **Deal Version Log and Comments** screen.
The **Comments** section appears. It contains the following columns:

Column Name	Column Description	Mandatory (Yes or No)
Creation Date Time	Displays the date and time when the log entry is created for the deal version in the system.	Not applicable
User	Indicates the user who has created the log entry for the deal version in the system.	Not applicable
Comments	Displays the reason why the log entry is created for the deal version.	Not applicable

In addition, the **Comments** section contains the following field:

Field Name	Field Description	Mandatory (Yes or No)
Comment	Used to specify the reason for creating a log entry for the deal version.	Yes

4. Enter the required details in the **Comment** field.
5. Click **Save**.

The log entry is created for the deal version.

Related Topics

For more information on...	See...
Deal Dashboard screen	Deal Dashboard on page 2757
Search Deal zone	Search Deal on page 2758
Deal Information screen	Deal Information on page 2815
Deal Information zone	Deal Information on page 2845
Deal Version Log and Comments screen	Deal Version Log and Comments on page 3043

Adhoc Revenue and Cost

The **Adhoc Revenue and Cost** screen allows you to add, edit, or view the additional charges applicable for the deal while deal creation. It also allows you to add price item level adhoc charges for the deal. It contains the following fields in a grid:

Field Name	Field Description
Sequence	Used to specify the sequence number of the adhoc revenue or cost for the deal.
Currency	Used to indicate the currency in which you want to specify the adhoc charge for the deal. Note: The list includes only those currencies which are defined in the system.
Amount	Used to specify the amount for the adhoc revenue or cost. Note: You can also specify negative value in this field.
Division	Used to indicate the division for which the adhoc charge is applicable. Note: You can view only those divisions to which you have access in the Division list.
Price Item	Used to indicate the price item for which you want to add the adhoc charge. Note: By default, this field is inactive. This field appears when the Price Item Level option is selected from the Revenue/Cost Type list. The Search (🔍) icon appears corresponding to the Price Item field. On clicking the Search icon, the Price Item Search window appears. On indicating the price item, the description of the price item appears corresponding to the Price Item field.
Revenue/Cost Type	Used to indicate the group to which the adhoc charge belong. The valid values are: <ul style="list-style-type: none">• Adhoc Revenue• Courier Cost• Deal Commission• Price Item Level• Travel Cost Note: The list includes only those values which are present in the REVENU_COST_GRP_FLG lookup field.
Amount Type	Used to indicate the type of amount using which you want to add an adhoc charge for the deal. The valid values are: <ul style="list-style-type: none">• Cost• Revenue

Field Name	Field Description
	Note: The list includes only those values which are present in the REV_TYPE_FLG lookup field.

Related Topics

For more information on...	See...
Deal Information screen	Deal Information on page 2815
Deal Information zone	Deal Information on page 2845
How to add an adhoc revenue or cost for a deal	Adding Adhoc Revenue and Cost for a Deal on page 3048

Adding Adhoc Revenue and Cost for a Deal

Prerequisites

To add an adhoc revenue and cost for a deal, you should have:

- Currencies defined in the application
- Values defined for the **Revenue/Cost Type** and **Revenue Type** in the **REVENU_COST_GRP_FLG** and **REV_TYPE_FLG** lookup fields respectively.

Procedure

To add an adhoc revenue and cost for a deal:

1. Search for the deal or deal version in the **Search Deal** zone of the **Deal Dashboard** screen for which you want to add an adhoc revenue and cost.
2. Click the **Adhoc Revenue and Cost** link at the top right corner of the **Deal Information** zone.

The **Adhoc Revenue And Cost** screen appears. It contains the following fields in a grid:

Field Name	Field Description	Mandatory (Yes or No)
Sequence	Used to specify the sequence number of the adhoc revenue or cost for the deal.	Yes
Currency	Used to indicate the currency in which you want to specify the adhoc charge for the deal. Note: The list includes only those currencies which are defined in the system.	Yes
Amount	Used to specify the amount for the adhoc revenue or cost. Note: You can also specify negative value in this field.	Yes
Division	Used to indicate the division for which the adhoc charge is applicable. Note: You can view only those divisions to which you have access in the Division list.	Yes

Field Name	Field Description	Mandatory (Yes or No)
Price Item	Used to indicate the price item for which you want to add the adhoc charge.	Yes (Conditional)
	<p>Note:</p> <p>By default, this field is inactive. This field appears when the Price Item Level option is selected from the Revenue/Cost Type list.</p> <p>The Search (🔍) icon appears corresponding to the Price Item field. On clicking the Search icon, the Price Item Search window appears.</p> <p>On indicating the price item, the description of the price item appears corresponding to the Price Item field.</p>	<p>Note: This field is required while adding adhoc revenue and cost for price items.</p>
Revenue/Cost Type	Used to indicate the group to which the adhoc charge belongs. The valid values are:	Yes
	<ul style="list-style-type: none"> • Adhoc Revenue • Courier Cost • Deal Commission • Price Item Level • Travel Cost <p>Note: The list includes only those values which are present in the REVENU_COST_GRP_FLG lookup field.</p>	
Amount Type	Used to indicate the type of revenue using which you want to add an adhoc charge for the deal. The valid values are:	Yes
	<ul style="list-style-type: none"> • Cost • Revenue <p>Note: The list includes only those values which are present in the REV_TYPE_FLG lookup field.</p>	

3. Enter the required details in the **Adhoc Revenue And Cost** screen.
4. If you want to associate more than one adhoc revenue and cost for the deal, click the **Add** (+) icon corresponding to the adhoc revenue and cost and then repeat step 3.

Note: However, if you want to remove an adhoc revenue and cost from the deal, click the **Delete** (🗑️) icon corresponding to the adhoc revenue and cost.

5. Click **Save**.

The adhoc revenue and cost is added for the deal.

Note: You cannot add or edit an adhoc revenue and cost if the deal has reached the **Finalized** status.

Related Topics

For more information on...	See...
Deal Dashboard screen	Deal Dashboard on page 2757
Search Deal zone	Search Deal on page 2758
Deal Information zone	Deal Information on page 2845
Adhoc Revenue and Cost screen	Adhoc Revenue and Cost on page 3047

Terms and Conditions Mapping

The **Terms and Conditions Mapping** screen enables you to associate terms and conditions with a price item, root level hierarchy entity, or non-root level hierarchy entity. It also allows you to view and edit the terms and conditions of a price item, root level hierarchy entity, or non-root level hierarchy entity. It contains the following zones:

- [Terms and Conditions Mapping List](#) on page 3050
- [Terms and Conditions Mapping Details](#) on page 3051

Related Topics

For more information on...	See...
How to associate terms and conditions with a price item	Associating the Terms and Conditions with a Price Item on page 3053
How to associate terms and conditions with a root level hierarchy entity	Associating the Terms and Conditions with a Root Level Hierarchy Entity on page 3055
How to associate terms and conditions with a non-root level hierarchy entity	Associating the Terms and Conditions with a Non-Root Level Hierarchy Entity on page 3058
How to edit the terms and conditions of a price item	Editing the Terms and Conditions of a Price Item on page 3060
How to edit the terms and conditions of a root level hierarchy entity	Editing the Terms and Conditions of a Root Level Hierarchy Entity on page 3062
How to edit the terms and conditions of a non-root level hierarchy entity	Editing the Terms and Conditions of a Non-Root Level Hierarchy Entity on page 3064
How to view the terms and conditions mapping details	Viewing the Terms and Conditions Mapping Details on page 3066

Terms and Conditions Mapping List

The **Terms and Conditions Mapping List** zone lists the terms and conditions that are already mapped to a price item, root-level hierarchy entity, or a non-root level hierarchy entity in the system. It contains the following columns:

Column Name	Column Description
Mapping Information	Displays the concatenated string of information about the mapped terms and conditions.
	Note: It has a link. On clicking the link, the Terms and Conditions Mapping Details zone appears where you can view the mapping details of the respective terms and conditions.

Column Name	Column Description
Mapping Entity Type	Indicates the type of entity using which the terms and conditions are mapped in the system. The valid values are: <ul style="list-style-type: none"> • Price Item • Non-Root Level Hierarchy Entity • Root Level Hierarchy Entity
Mapping Entity	Displays the entity to which the terms and conditions are mapped.

You can filter the list using various search criteria (such as, **Mapping ID**, **Terms and Conditions**, and **Mapping Entity Type**) available in the **Filter** area. By default, the **Filter** area is hidden. You can view the **Filter** area by clicking the **Filters** (🔍) icon in the upper right corner of this zone.

On clicking the **Broadcast** (📡) icon corresponding to the terms and conditions mapping information, the **Terms and Conditions Mapping Details** zone appears with the mapping details of the respective terms and conditions.

Note: Pagination is used to display limited number of records in this zone. You can use the navigation links, such as **Previous** and **Next** to navigate between pages.

Related Topics

For more information on...	See...
Terms and Conditions Mapping Details zone	Terms and Conditions Mapping Details on page 3051
How to view the terms and conditions mapping details	Viewing the Terms and Conditions Mapping Details on page 3066

Terms and Conditions Mapping Details

The **Terms and Conditions Mapping Details** zone displays the mapping details of the terms and conditions. It contains the following sections:

- **Main** - Displays the basic mapping information about the terms and conditions. It contains the following fields:

Field Name	Field Description
Mapping ID	Displays the mapping ID of the terms and conditions.
Mapping Entity Type	Indicates the type of entity using which the terms and conditions are mapped in the system. The valid values are: <ul style="list-style-type: none"> • Price Item • Non-Root Level Hierarchy Entity • Root Level Hierarchy Entity
Mapping Entity	Indicates the entity to which the terms and conditions are mapped.
Price Item	Indicates the price item to which the terms and conditions are mapped. <p>Note: This field appears when the terms and conditions are mapped using the Mapping Entity Type as Price Item.</p>
Non-Root Level Hierarchy Entity	Indicates the non-root level hierarchy entity to which the terms and conditions are mapped.

Field Name	Field Description
	Note: This field appears when the terms and conditions are mapped using the Mapping Entity Type as Non-Root Level Hierarchy Entity .
Root Level Hierarchy Entity	Indicates the root level hierarchy entity to which the terms and conditions are mapped. Note: This field appears when the terms and conditions are mapped using the Mapping Entity Type as Root Level Hierarchy Entity .

- **Record Actions** - This section contains the following button:

Button Name	Button Description
Edit	Used to edit the mapping details of the terms and conditions.

- **Record Information** - This section contains the following field:

Field Name	Field Description
Business Object	Indicates the business object using which the terms and conditions are mapped to the entity. In addition, a context menu appears corresponding to this field which helps in navigating to other screens in the application. Note: It has a link. On clicking the link, the Business Object screen appears where you can view the details of the respective business object.

- **Terms and Conditions** - Lists the terms and conditions which are mapped to the entity. It contains the following columns:

Column Name	Column Description
Terms and Conditions	Displays the terms and conditions which are mapped to the entity. Note: It has a link. On clicking the link, the Terms and Conditions screen appears where you can view the details of the respective terms and conditions.
Start Date	Displays the date from when the terms and conditions are effective for the entity. Note: The start date cannot be later than the end date.
End Date	Displays the date till when the terms and conditions are effective for the entity. Note: The end date cannot be earlier than the start date.
Default	Indicates whether the mapped term and condition is default or not.

By default, the **Terms and Conditions Mapping Details** zone does not appear in the **Terms and Conditions Mapping** screen. It appears when you click the **Broadcast** () icon corresponding to the terms and conditions mapping information in the **Terms and Conditions Mapping List** zone.

Related Topics

For more information on...	See...
How to view the terms and conditions mapping details	Viewing the Terms and Conditions Mapping Details on page 3066
Terms and Conditions Mapping screen	Terms and Conditions Mapping on page 3050
Terms and Conditions Mapping List zone	Terms and Conditions Mapping List on page 3050

Associating the Terms and Conditions with a Price Item

Prerequisites

To associate the terms and conditions with a price item, you should have:

- Price item with which you want to associate the terms and conditions defined in the application
- Terms and conditions defined in the application

Procedure

To associate the terms and conditions with a price item:

1. Click the **Menu** link in the **Application** toolbar.
A list appears.
2. From the **Main** menu, select **Deal Management** and then click **Terms and Conditions Mapping**.
A sub-menu appears.
3. Click the **Add** option from the **Terms and Conditions Mapping** sub-menu.

The **Terms and Conditions Mapping** screen appears. It contains the following sections:

- **Main** - Used to specify basic details about the entity (i.e. price item, non-root level hierarchy entity, or root level hierarchy entity) with which you want to associate the terms and conditions. It contains the following fields:

Field Name	Field Description	Mandatory (Yes or No)
Mapping Entity Type	Used to indicate the type of entity using which you want to associate the terms and conditions. The valid values are: <ul style="list-style-type: none"> • Price Item - Used to indicate that you want to associate the terms and conditions with a price item. • Non-Root Level Hierarchy Entity - Used to indicate that you want to associate the terms and conditions with a non-root level hierarchy entity. • Root Level Hierarchy Entity - Used to indicate that you want to associate the terms and conditions with a root level hierarchy entity. 	Yes
Mapping Entity	Used to indicate the entity with which you want to associate the terms and conditions.	Yes

Field Name	Field Description	Mandatory (Yes or No)
	<p>Note:</p> <p>The Search (🔍) icon appears corresponding to the Mapping Entity field. On clicking the Search icon, the Price Item Terms and Conditions Mapping Search, Non-Root Level Hierarchy Entity Terms and Conditions Mapping Search, or Root Level Hierarchy Entity Terms and Conditions Mapping Search window appears depending upon whether you select the Price Item, Non-Root Level Hierarchy Entity, or Root-Level Hierarchy Entity option from the Mapping Entity Type field respectively.</p> <p>On indicating the mapping entity, the description of the mapping entity appears corresponding to the Mapping Entity field.</p> <p>This field appears when you select the mapping entity type from the Mapping Entity Type field.</p>	

- **Terms and Conditions** - Used to associate the terms and conditions with the entity (i.e. price item, non-root level hierarchy entity, or root level hierarchy entity). It contains the following fields in a grid:

Field Name	Field Description	Mandatory (Yes or No)
Terms and Conditions	Used to indicate the terms and conditions that you want to associate with the entity.	Yes
	<p>Note:</p> <p>The Search (🔍) icon appears corresponding to the Terms and Conditions field. On clicking the Search icon, the Terms and Conditions Search window appears.</p> <p>On indicating the terms and conditions, the description of the terms and conditions appear corresponding to the Terms and Conditions field.</p> <p>You can search for only those terms and conditions whose Terms and Conditions Usage is set to Deal or Invoice and Deal.</p>	
Start Date	Used to specify the date from when the terms and conditions are associated with the entity.	Yes
	Note: The start date cannot be later than the end date.	

Field Name	Field Description	Mandatory (Yes or No)
End Date	Used to specify the date till when the terms and conditions are associated with the entity.	No
	Note: The end date cannot be earlier than the start date.	
Default	Used to indicate whether the terms and conditions should be defaulted for the entity.	No
	Note: You must specify atleast one default terms and conditions for an entity.	

4. Select the **Price Item** option from the **Mapping Entity Type** field in the **Main** section.

The **Mapping Entity** field appears.

5. Search for the price item with which you want to associate the terms and conditions in the **Mapping Entity** field.
6. Associate terms and conditions with the price item in the **Terms and Conditions** section.

Note: The valid file extensions for associating terms and conditions are doc, xls, pdf, jpg, txt, avi, bmp, mp3 and rtf.

7. If you want to associate more than one terms and conditions with the price item, click the **Add (+)** icon.

Note: However, if you want to disassociate the terms and conditions from the price item, click the **Delete (🗑)** icon corresponding to the respective terms and conditions.

8. Click **Save**.

The terms and conditions are associated with the price item.

Related Topics

For more information on...	See...
Terms and Conditions Mapping screen	Terms and Conditions Mapping on page 3050

Associating the Terms and Conditions with a Root Level Hierarchy Entity

Prerequisites

To associate the terms and conditions with a root level hierarchy entity, you should have:

- Hierarchy entity with which you want to associate the terms and conditions defined in the application
- Terms and conditions defined in the application

Procedure

To associate the terms and conditions with a root level hierarchy entity:

1. Click the **Menu** link in the **Application** toolbar.
A list appears.
2. From the **Main** menu, select **Deal Management** and then click **Terms and Conditions Mapping**.
A sub-menu appears.

- Click the **Add** option from the **Terms and Conditions Mapping** sub-menu.

The **Terms and Conditions Mapping** screen appears. It contains the following sections:

- Main** - Used to specify basic details about the entity (i.e. price item, non-root level hierarchy entity, or root level hierarchy entity) with which you want to associate the terms and conditions. It contains the following fields:

Field Name	Field Description	Mandatory (Yes or No)
Mapping Entity Type	<p>Used to indicate the type of entity using which you want to associate the terms and conditions. The valid values are:</p> <ul style="list-style-type: none"> Price Item - Used to indicate that you want to associate the terms and conditions with a price item. Non-Root Level Hierarchy Entity - Used to indicate that you want to associate the terms and conditions with a non-root level hierarchy entity. Root Level Hierarchy Entity - Used to indicate that you want to associate the terms and conditions with a root level hierarchy entity. 	Yes
Mapping Entity	<p>Used to indicate the entity with which you want to associate the terms and conditions.</p> <p>Note:</p> <p>The Search (🔍) icon appears corresponding to the Mapping Entity field. On clicking the Search icon, the Price Item Terms and Conditions Mapping Search, Non-Root Level Hierarchy Entity Terms and Conditions Mapping Search, or Root Level Hierarchy Entity Terms and Conditions Mapping Search window appears depending upon whether you select the Price Item, Non-Root Level Hierarchy Entity, or Root-Level Hierarchy Entity option from the Mapping Entity Type field respectively.</p> <p>On indicating the mapping entity, the description of the mapping entity appears corresponding to the Mapping Entity field.</p> <p>This field appears when you select the mapping entity type from the Mapping Entity Type field.</p>	Yes

- Terms and Conditions** - Used to associate the terms and conditions with the entity (i.e. price item, non-root level hierarchy entity, or root level hierarchy entity). It contains the following fields in a grid:

Field Name	Field Description	Mandatory (Yes or No)
Terms and Conditions	Used to indicate the terms and conditions that you want to associate with the entity.	Yes
	<p>Note:</p> <p>The Search (🔍) icon appears corresponding to the Terms and Conditions field. On clicking the Search icon, the Terms and Conditions Search window appears.</p> <p>On indicating the terms and conditions, the description of the terms and conditions appear corresponding to the Terms and Conditions field.</p> <p>You can search for only those terms and conditions whose Terms and Conditions Usage is set to Deal or Invoice and Deal.</p>	
Start Date	Used to specify the date from when the terms and conditions are associated with the entity.	Yes
	<p>Note: The start date cannot be later than the end date.</p>	
End Date	Used to specify the date till when the terms and conditions are associated with the entity.	No
	<p>Note: The end date cannot be earlier than the start date.</p>	
Default	Used to indicate whether the terms and conditions should be defaulted for the entity.	No
	<p>Note: You must specify atleast one default terms and conditions for an entity.</p>	

4. Select the **Root Level Hierarchy Entity** option from the **Mapping Entity Type** field in the **Main** section.

The **Mapping Entity** field appears.

5. Search for the root level hierarchy entity with which you want to associate the terms and conditions in the **Mapping Entity** field.
6. Associate terms and conditions with the root level hierarchy entity in the **Terms and Conditions** section.

Note: The valid file extensions for associating terms and conditions are doc, xls, pdf, jpg, txt, avi, bmp, mp3 and rtf.

7. If you want to associate more than one terms and conditions with the root level hierarchy entity, click the **Add** (+) icon.

Note: However, if you want to disassociate the terms and conditions from the root level hierarchy entity, click the **Delete** (🗑️) icon corresponding to the respective terms and conditions.

8. Click **Save**.

The terms and conditions are associated with the root level hierarchy entity.

Related Topics

For more information on...	See...
Terms and Conditions Mapping screen	Terms and Conditions Mapping on page 3050

Associating the Terms and Conditions with a Non-Root Level Hierarchy Entity

Prerequisites

To associate the terms and conditions with a non-root level hierarchy entity, you should have:

- Hierarchy entity with which you want to associate the terms and conditions defined in the application
- Terms and conditions defined in the application

Procedure

To associate the terms and conditions with a non-root level hierarchy entity:

1. Click the **Menu** link in the **Application** toolbar.
A list appears.
2. From the **Main** menu, select **Deal Management** and then click **Terms and Conditions Mapping**.
A sub-menu appears.
3. Click the **Add** option from the **Terms and Conditions Mapping** sub-menu.

The **Terms and Conditions Mapping** screen appears. It contains the following sections:

- **Main** - Used to specify basic details about the entity (i.e. price item, non-root level hierarchy entity, or root level hierarchy entity) with which you want to associate the terms and conditions. It contains the following fields:

Field Name	Field Description	Mandatory (Yes or No)
Mapping Entity Type	Used to indicate the type of entity using which you want to associate the terms and conditions. The valid values are: <ul style="list-style-type: none"> • Price Item - Used to indicate that you want to associate the terms and conditions with a price item. • Non-Root Level Hierarchy Entity - Used to indicate that you want to associate the terms and conditions with a non-root level hierarchy entity. • Root Level Hierarchy Entity - Used to indicate that you want to associate the terms and conditions with a root level hierarchy entity. 	Yes
Mapping Entity	Used to indicate the entity with which you want to associate the terms and conditions.	Yes

Field Name	Field Description	Mandatory (Yes or No)
	<p>Note:</p> <p>The Search (🔍) icon appears corresponding to the Mapping Entity field. On clicking the Search icon, the Price Item Terms and Conditions Mapping Search, Non-Root Level Hierarchy Entity Terms and Conditions Mapping Search, or Root Level Hierarchy Entity Terms and Conditions Mapping Search window appears depending upon whether you select the Price Item, Non-Root Level Hierarchy Entity, or Root-Level Hierarchy Entity option from the Mapping Entity Type field respectively.</p> <p>On indicating the mapping entity, the description of the mapping entity appears corresponding to the Mapping Entity field.</p> <p>This field appears when you select the mapping entity type from the Mapping Entity Type field.</p>	

- **Terms and Conditions** - Used to associate the terms and conditions with the entity (i.e. price item, non-root level hierarchy entity, or root level hierarchy entity). It contains the following fields in a grid:

Field Name	Field Description	Mandatory (Yes or No)
Terms and Conditions	Used to indicate the terms and conditions that you want to associate with the entity.	Yes
	<p>Note:</p> <p>The Search (🔍) icon appears corresponding to the Terms and Conditions field. On clicking the Search icon, the Terms and Conditions Search window appears.</p> <p>On indicating the terms and conditions, the description of the terms and conditions appear corresponding to the Terms and Conditions field.</p> <p>You can search for only those terms and conditions whose Terms and Conditions Usage is set to Deal or Invoice and Deal.</p>	
Start Date	Used to specify the date from when the terms and conditions are associated with the entity.	Yes
	Note: The start date cannot be later than the end date.	

Field Name	Field Description	Mandatory (Yes or No)
End Date	Used to specify the date till when the terms and conditions are associated with the entity.	No
	Note: The end date cannot be earlier than the start date.	
Default	Used to indicate whether the terms and conditions should be defaulted for the entity.	No
	Note: You must specify atleast one default terms and conditions for an entity.	

4. Select the **Non-Root Level Hierarchy Entity** option from the **Mapping Entity Type** field in the **Main** section. The **Mapping Entity** field appears.

5. Search for the non-root level hierarchy entity with which you want to associate the terms and conditions in the **Mapping Entity** field.

6. Associate terms and conditions with the non-root level hierarchy entity in the **Terms and Conditions** section.

Note: The valid file extensions for associating terms and conditions are doc, xls, pdf, jpg, txt, avi, bmp, mp3 and rtf.

7. If you want to associate more than one terms and conditions with the non-root level hierarchy entity, click the **Add (+)** icon.

Note: However, if you want to disassociate the terms and conditions from the non-root level hierarchy entity, click the **Delete (🗑)** icon corresponding to the respective terms and conditions.

8. Click **Save**.

The terms and conditions are associated with the non-root level hierarchy entity.

Related Topics

For more information on...	See...
Terms and Conditions Mapping screen	Terms and Conditions Mapping on page 3050

Editing the Terms and Conditions of a Price Item

Prerequisites

To edit the terms and conditions of a price item, you should have:

- Terms and conditions associated with the price item.

Procedure

To edit the terms and conditions of a price item:

1. Search for the price item in the **Terms and Conditions Mapping** screen.
2. In the **Search Results** section, click the **Broadcast (📡)** icon corresponding to the price item whose terms and conditions you want to edit. The **Terms And Conditions Mapping Details** zone appears.
3. Click the **Edit** button in the **Terms And Conditions Mapping Details** zone.

The **Terms And Conditions Mapping** screen appears. It contains the following sections:

- **Main** - Displays the basic information about the price item whose terms and conditions you want to edit. It contains the following fields:

Field Name	Field Description	Mandatory (Yes or No)
Mapping ID	Displays the terms and conditions mapping ID for the price item.	Not applicable
Mapping Entity Type	Indicates the type of entity using which the terms and conditions are associated with the price item. The valid value is: <ul style="list-style-type: none"> • Price Item 	Not applicable
Mapping Entity	Indicates the price item with which the terms and conditions are associated.	Not applicable

- **Terms and Conditions** - Lists the terms and conditions that are associated with the price item. It contains the following columns:

Column Name	Column Description	Mandatory (Yes or No)
Terms and Conditions	Used to indicate the terms and conditions that you want to associate with the price item.	Yes (Conditional)
	<p>Note:</p> <p>The Search (🔍) icon appears corresponding to the Terms and Conditions field. On clicking the Search icon, the Price Item Terms and Conditions Search window appears.</p> <p>On indicating the terms and conditions, the description of the terms and conditions appear corresponding to the Terms and Conditions field.</p> <p>You can search for only those terms and conditions whose Terms and Conditions Usage is set to Deal or Invoice and Deal and the Terms and Conditions Applicability is set to Price Item.</p>	<p>Note: This field is required while editing the terms and conditions of the price item.</p>
Start Date	Used to specify the date from when the terms and conditions are associated with the price item.	Yes (Conditional)
	<p>Note: The start date cannot be later than the end date.</p>	<p>Note: This field is required while editing the terms and conditions of the price item.</p>
End Date	Used to specify the date till when the terms and conditions are associated with the price item.	No

Column Name	Column Description	Mandatory (Yes or No)
	Note: The end date cannot be earlier than the start date.	
Default	Used to indicate whether the terms and conditions should be defaulted for the price item. Note: You must specify atleast one default terms and conditions for a price item.	Yes

4. Modify the required details in the **Terms and Conditions** section, if required.
5. Associate or disassociate the terms and conditions from the price item, if required.
6. Click **Save**.

The changes made to the terms and conditions of the price item are saved.

Related Topics

For more information on...	See...
Terms and Conditions Mapping screen	Terms and Conditions Mapping on page 3050
Terms And Conditions Mapping Details zone	Terms and Conditions Mapping Details on page 3051
How to associate the terms and conditions with a price item	Associating the Terms and Conditions with a Price Item on page 3053

Editing the Terms and Conditions of a Root Level Hierarchy Entity

Prerequisites

To edit the terms and conditions of a root level hierarchy entity, you should have:

- Terms and conditions associated with the root level hierarchy entity.

Procedure

To edit the terms and conditions of a root level hierarchy entity:

1. Search for the root level hierarchy entity in the **Terms and Conditions Mapping** screen.
2. In the **Search Results** section, click the **Broadcast** () icon corresponding to the root level hierarchy entity whose terms and conditions you want to edit. The **Terms And Conditions Mapping Details** zone appears.
3. Click the **Edit** button in the **Terms And Conditions Mapping Details** zone.

The **Terms And Conditions Mapping** screen appears. It contains the following sections:

- **Main** - Displays the basic information about the root level hierarchy entity whose terms and conditions you want to edit. It contains the following fields:

Field Name	Field Description	Mandatory (Yes or No)
Mapping ID	Displays the terms and conditions mapping ID for the root level hierarchy entity.	Not applicable
Mapping Entity Type	Indicates the type of entity using which the terms and conditions are associated with the	Not applicable

Field Name	Field Description	Mandatory (Yes or No)
	root level hierarchy entity. The valid value is: <ul style="list-style-type: none"> Root Level Hierarchy Entity 	
Mapping Entity	Indicates the root level hierarchy entity with which the terms and conditions are associated.	Not applicable

- **Terms and Conditions** - Lists the terms and conditions that are associated with the root level hierarchy entity. It contains the following columns:

Column Name	Column Description	Mandatory (Yes or No)
Terms and Conditions	Used to indicate the terms and conditions that you want to associate with the root level hierarchy entity.	Yes (Conditional)
	<p>Note:</p> <p>The Search (🔍) icon appears corresponding to the Terms and Conditions field. On clicking the Search icon, the Root Level Hierarchy Entity Terms and Conditions Search window appears.</p> <p>On indicating the terms and conditions, the description of the terms and conditions appear corresponding to the Terms and Conditions field.</p> <p>You can search for only those terms and conditions whose Terms and Conditions Usage is set to Deal or Invoice and Deal and the Terms and Conditions Applicability is set to Root Level Hierarchy Entity.</p>	<p>Note: This field is required while editing the terms and conditions of the root level hierarchy entity.</p>
Start Date	Used to specify the date from when the terms and conditions are associated with the root level hierarchy entity.	Yes (Conditional)
	<p>Note: The start date cannot be later than the end date.</p>	<p>Note: This field is required while editing the terms and conditions of the root level hierarchy entity.</p>
End Date	Used to specify the date till when the terms and conditions are associated with the root level hierarchy entity.	No
	<p>Note: The end date cannot be earlier than the start date.</p>	
Default	Used to indicate whether the terms and conditions should be defaulted for the root level hierarchy entity.	Yes

Column Name	Column Description	Mandatory (Yes or No)
	Note: You must specify atleast one default terms and conditions for a root level hierarchy entity.	

4. Modify the required details in the **Terms and Conditions** section, if required.
5. Associate or disassociate the terms and conditions from the root level hierarchy entity, if required.
6. Click **Save**.

The changes made to the terms and conditions of the root level hierarchy entity are saved.

Related Topics

For more information on...	See...
Terms and Conditions Mapping screen	Terms and Conditions Mapping on page 3050
Terms And Conditions Mapping Details zone	Terms and Conditions Mapping Details on page 3051
How to associate the terms and conditions with a root level hierarchy entity	Associating the Terms and Conditions with a Root Level Hierarchy Entity on page 3055

Editing the Terms and Conditions of a Non-Root Level Hierarchy Entity

Prerequisites

To edit the terms and conditions of a non-root level hierarchy entity, you should have:

- Terms and conditions associated with the non-root level hierarchy entity.

Procedure

To edit the terms and conditions of a non-root level hierarchy entity:

1. Search for the non-root level hierarchy entity in the **Terms and Conditions Mapping** screen.
2. In the **Search Results** section, click the **Broadcast** () icon corresponding to the non-root level hierarchy entity whose terms and conditions you want to edit. The **Terms And Conditions Mapping Details** zone appears.
3. Click the **Edit** button in the **Terms And Conditions Mapping Details** zone.

The **Terms And Conditions Mapping** screen appears. It contains the following sections:

- **Main** - Displays the basic information about the non-root level hierarchy entity whose terms and conditions you want to edit. It contains the following fields:

Field Name	Field Description	Mandatory (Yes or No)
Mapping ID	Displays the terms and conditions mapping ID for the non-root level hierarchy entity.	Not applicable
Mapping Entity Type	Indicates the type of entity using which the terms and conditions are associated with the non-root level hierarchy entity. The valid value is: <ul style="list-style-type: none"> • Non-Root Level Hierarchy Entity 	Not applicable

Field Name	Field Description	Mandatory (Yes or No)
Mapping Entity	Indicates the non-root level hierarchy entity with which the terms and conditions are associated.	Not applicable

- **Terms and Conditions** - Lists the terms and conditions that are associated with the non-root level hierarchy entity. It contains the following columns:

Column Name	Column Description	Mandatory (Yes or No)
Terms and Conditions	Used to indicate the terms and conditions that you want to associate with the non-root level hierarchy entity.	Yes (Conditional)
	<p>Note:</p> <p>The Search (🔍) icon appears corresponding to the Terms and Conditions field. On clicking the Search icon, the Non-Root Level Hierarchy Entity Terms and Conditions Search window appears.</p> <p>On indicating the terms and conditions, the description of the terms and conditions appear corresponding to the Terms and Conditions field.</p> <p>You can search for only those terms and conditions whose Terms and Conditions Usage is set to Deal or Invoice and Deal and the Terms and Conditions Applicability is set to Non-Root Level Hierarchy Entity.</p>	Note: This field is required while editing the terms and conditions of the non-root level hierarchy entity.
Start Date	Used to specify the date from when the terms and conditions are associated with the non-root level hierarchy entity.	Yes (Conditional)
	Note: The start date cannot be later than the end date.	Note: This field is required while editing the terms and conditions of the non-root level hierarchy entity.
End Date	Used to specify the date till when the terms and conditions are associated with the non-root level hierarchy entity.	No
	Note: The end date cannot be earlier than the start date.	
Default	Used to indicate whether the terms and conditions should be defaulted for the non-root level hierarchy entity.	Yes
	Note: You must specify atleast one default terms and conditions for a non-root level hierarchy entity.	

4. Modify the required details in the **Terms and Conditions** section, if required.

5. Associate or disassociate the terms and conditions from the non-root level hierarchy entity, if required.
6. Click **Save**.

The changes made to the terms and conditions of the non-root level hierarchy entity are saved.

Related Topics

For more information on...	See...
Terms and Conditions Mapping screen	Terms and Conditions Mapping on page 3050
Terms And Conditions Mapping Details zone	Terms and Conditions Mapping Details on page 3051
How to associate the terms and conditions with a non-root level hierarchy entity	Associating the Terms and Conditions with a Non-Root Level Hierarchy Entity on page 3058

Viewing the Terms and Conditions Mapping Details

Prerequisites

To view the terms and conditions mapping details, you should have:

- Terms and conditions mapped with the entity (i.e. price item, root level hierarchy entity, or non-root level hierarchy entity).

Procedure

To view the terms and conditions mapping details:

1. Search for the entity in the **Terms and Conditions Mapping** screen.
2. In the **Search Results** section, click the **Broadcast** () icon corresponding to the entity whose terms and conditions mapping details you want to view. The **Terms And Conditions Mapping Details** zone appears.
3. View the terms and conditions mapping details in the **Terms And Conditions Mapping Details** zone.

Related Topics

For more information on...	See...
Terms and Conditions Mapping screen	Terms and Conditions Mapping on page 3050
Terms And Conditions Mapping Details zone	Terms and Conditions Mapping Details on page 3051

Deal Approver Dashboard

The **Deal Approver Dashboard** screen allows you to view the To Do tasks assigned to the user that belongs to the access group as defined in the approval hierarchy of the **Deal Approval Profile** screen. It also allows you to search for deals which are assigned to the user for approval. It contains the following zones:

- [Deal Metrics](#) on page 3066
- [Deal To Do](#) on page 3067
- [Search Deal](#) on page 3067

Deal Metrics

The **Deal Metrics** zone enables you to view the following information through a tiles chart for deals which are assigned to the user for approval:

- Number of deals created by the user

- Number of deals in the **Pending for Approval** status
- Number of deals yet to be finalized
- Number of deals yet to be accepted by the customer
- Number of deals accepted by the customer
- Number of deals rejected by the customer

In addition, you can view the above information through a bar and line chart by toggling the **Tiles/Chart** switch available in the **Deal Metrics** zone.

The bar chart indicates the number of deals in different statuses for an existing customer, existing account, and prospect. Whereas, the line chart indicates the deal revenue from an existing customer, existing account, and prospect.

Note: By default, the above information is shown for the period which is specified in the **Deal Limits in Months** option type of the **C1-DEAL** feature configuration. You can change the period if required.

You can filter the information using various criteria (such as, **Period From**, **Period To**, **Division**, **Customer Tier**, and **Customer Segment**) available in the **Deal Metrics** zone.

Related Topics

For more information on...	See...
Deal Dashboard screen	Deal Dashboard on page 2757
How to view the deal metrics in the tiles chart	Viewing the Deal Metrics in the Tiles Chart on page 2787
How to view the deal count in the bar chart	Viewing the Deal Count in the Bar Chart on page 2788
How to view the deal revenue in the line chart	Viewing the Deal Revenue in the Line Chart on page 2788

Deal To Do

The **Deal To Do** zone lists the deal approval To Do's assigned to the user that belongs to the access group as defined in the approval hierarchy of the **Deal Approval Profile** screen. It also lists the deal information for which the deal approval To Do is generated. It contains the following columns:

Column name	Column Description
To Do	On clicking the To Do icon () , the To Do Entry screen appears where you can view the details of the respective To Do assigned to the user.
Deal Information	Displays the concatenated string of information about the deal separated by a comma (,) for which the To Do is created. Note: It has a link. On clicking the link, the Deal Information screen appears where you can perform the required action.

Note: By default, the system lists the To Do's for the user that are created in the period which is specified in the **Deal Limits in Months** option type of the **C1-DEAL** feature configuration. You can change the period if required.

You can filter the list using various criteria (such as, **To Do Type**, **Priority**, **Start Date**, and **End Date**) available in the **Filter** area. By default, the **Filter** area is hidden. You can view the **Filter** area by clicking the **Filters** () icon in the upper right corner of this zone.

Search Deal

The **Search Deal** zone allows you to search deals for which the next required action has to be performed by the user as per the deal approval workflow. It contains the following two sections:

- **Search Criteria** - The **Search Criteria** section contains the following fields:

Field Name	Field Description	Mandatory (Yes or No)
Search By	Used to indicate whether you want to search for a deal using the deal, customer, or account details. The valid values are: <ul style="list-style-type: none"> • Deal Details • Customer Details • Account Details <p>Note: By default, the Deal Details option is selected.</p>	Yes
Division	Used to search deals which are associated with a particular division to which the user belongs. <p>Note: You can only view those divisions to which you have access in the Division list.</p>	No
Deal ID	Used to search for a particular deal. <p>Note: This field appears when the Deal Details option is selected from the Search By list.</p>	No
Start Date	Used to search deals which are effective from a particular date onwards. <p>Note: This field appears when the Deal Details option is selected from the Search By list. The start date cannot be later than the end date.</p>	No
End Date	Used to search deals which are effective till a particular date. <p>Note: This field appears when the Deal Details option is selected from the Search By list. The end date cannot be earlier than the start date.</p>	No
Status	Used to search deals with a particular status. <p>Note: This field appears when the Deal Details option is selected from the Search By list.</p>	No
Created By	Used to search deals which are created by a particular user.	No



Field Name	Field Description	Mandatory (Yes or No)
	<p>Note:</p> <p>The Search (🔍) icon appears corresponding to this field. On clicking the Search icon, the User Search window appears.</p> <p>On specifying the creator, the description of the creator appears corresponding to the Created By field.</p> <p>This field appears when the Deal Details option is selected from the Search By list.</p>	
Customer Segment	<p>Used to search deals which are created for customers associated to a particular business component.</p> <p>Note: This field appears when the Customer Details option is selected from the Search By list.</p>	No
Person ID	<p>Used to search deals which are created for a particular customer.</p> <p>Note: This field appears when the Customer Details option is selected from the Search By list.</p>	No
Person Name	<p>Used to search deals which are created for persons or accounts with a particular name.</p> <p>Note: This field appears when the Customer Details or Account Details option is selected from the Search By list.</p>	No
Person Identifier Type	<p>Used to search deals which are created for persons using a particular identifier type.</p> <p>Note: This field appears when the Customer Details option is selected from the Search By list.</p>	<p>Yes (Conditional)</p> <p>Note: If you enter person identifier as a search criteria, you have to select the person identifier type.</p>
Person Identifier	<p>Used to specify the value for the person identifier type for searching deals created for the persons.</p> <p>Note: This field appears when the Customer Details option is selected from the Search By list.</p>	<p>Yes (Conditional)</p> <p>Note: If you enter person identifier type as a search criteria, you have to specify the person identifier.</p>
Account ID	<p>Used to search deal which is created for a particular account.</p>	No

Field Name	Field Description	Mandatory (Yes or No)
	Note: This field appears when the Account Details option is selected from the Search By list.	
Account Identifier Type	Used to search deals which are created for accounts using a particular identifier type. Note: This field appears when the Account Details option is selected from the Search By list.	Yes (Conditional) Note: If you enter account identifier as a search criteria, you have to select the account identifier type.
Account Identifier	Used to specify the value of the account identifier type for searching deals created for accounts. Note: This field appears when the Account Details option is selected from the Search By list.	Yes (Conditional) Note: If you enter account identifier type as a search criteria, you have to select the primary account identifier.
Deal Entity	Used to search deals which are created for a particular entity. The valid values are: <ul style="list-style-type: none"> Account - Used to search deals which are created for the existing accounts in the system. Note: This value appears when you select the Deal Details or Account Details option from the Search By list. Customer - Used to search deals which are created for the existing customers in the system. Note: This value appears when you select the Deal Details or Customer Details option from the Search By list. Prospect - Used to search deals which are created for the existing prospects in the system. Note: This value appears when you select the Deal Details or Customer Details option from the Search By list. 	Yes (Conditional) Note: This field is required while searching for deals created for the respective entities.
Deal Type	Used to search deals which are created using a particular deal type.	Yes (Conditional) Note: This field is required while searching deals using the Deal Details .

Field Name	Field Description	Mandatory (Yes or No)
	<p>Note:</p> <p>The Search (🔍) icon appears corresponding to this field. On clicking the Search icon, the Deal Type Search window appears.</p> <p>On specifying the deal type, the description of the deal type appears corresponding to the Deal Type field.</p> <p>This field appears when the Deal Details option is selected from the Search By list.</p>	
Deal Creation From Date	<p>Used to search deals which are created from a particular date onwards.</p> <p>Note: By default, the system displays the date which is specified in the Deal Limits in Months option type of the C1-DEAL feature configuration. You can change the date if required.</p>	No
Deal Creation To Date	<p>Used to search deals which are created till a particular date.</p> <p>Note: By default, the system displays the date which is specified in the Deal Limits in Months option type of the C1-DEAL feature configuration. You can change the date if required.</p>	No
Deal Identifier	<p>Used to search deals which are created using a particular deal identifier.</p> <p>Note: This field appears when the Deal Details option is selected from the Search By list.</p>	No
Assigned To My Role	<p>Used to search only those deals to which the user has access for approval.</p> <p>Note: On clicking the check box you can search for deals as per the access group defined in the Approval Hierarchy of the Deal Approval Profile to which the user belongs.</p>	<p>Yes (Conditional)</p> <p>Note: This field is required while searching deals which are assigned to the user for approval.</p>

- **Search Results** - On clicking the **Search** button, a list of deals appear based on the specified search criteria. The **Search Results** section contains the following columns:

Column Name	Column Description
Deal Information	Displays the concatenated string of information about the deal separated by a comma (,).

Column Name	Column Description
	Note: It has a link. On clicking the link, the Deal Information screen appears where you can view the details of the respective deal.
Person Information	<p>Displays the concatenated string of information about the main person for whom the deal is created in the system.</p> <p>Note:</p> <p>It has a link. On clicking the link, the Customer 360° Information or the Prospect Person screen appears where you can view the details of the respective person.</p> <p>The Customer 360° Information screen appears when you select the Account or Customer option from the Deal Entity list in the Search Criteria while searching for a deal. Whereas, the Prospect Person screen appears when you select the Prospect option from the Deal Entity list in the Search Criteria while searching for a deal.</p>
Deal Entity	<p>Indicates the entity for which the deal is created in the system. The valid values are:</p> <ul style="list-style-type: none"> • Account • Customer • Prospect
Start Date	Displays the date from when the deal is effective for the deal entity.
End Date	Displays the date till when the deal is effective for the deal entity.
Status	Indicates the current status of the deal.
Created By	Displays the user who has created the deal in the system.
View Approval Workflow	On clicking the View Approval Workflow () icon, the Deal Approval Workflow screen appears where you can view the details of the approval workflow of the respective deal.
Print Deal	On clicking the Print () icon, the Deal Extraction screen appears where you can filter the options as per your requirement and extract the deal information in the PDF or Excel format.

Note:

By default, the **Search Results** section lists all the deals which are assigned to the user for the period as specified in the **Deal Limits in Months** option type of the **C1-DEAL** feature configuration.

Pagination is used to display limited number of records in the **Search Results** section. You can use the navigation links, such as **Previous** and **Next** to navigate between pages.

By default, the **Filter** area is hidden. You can view the **Filter** area by clicking the **Filters** () icon in the upper right corner of this zone.

Searching for a Deal

Prerequisites

To search for a deal, you should have:

- Divisions defined in the application
- Deals or deal versions associated with the division to which the user belongs
- Deal types defined in the application
- Deal entities defined in the application

Procedure

To search for a deal:

1. Click the **Menu** link in the **Application** toolbar.
A list appears.
2. From the **Main** menu, select **Deal Management** and then click **Deal Approver Dashboard**.
The **Deal Approver Dashboard** screen appears.
3. Enter the search criteria in the **Search Deal** zone.

Note: ORMB search engine supports wildcard search, where you can substitute the percentage (%) symbol as a stand in for any word or letter in a search criteria. You can use the ‘%’ wildcard character in all input fields except the date and ID fields. The ‘%’ wildcard character is suffixed automatically at the end of the partial search criteria. Therefore, you may or may not specify the wildcard character at the end of the partial search criteria. However, you have to prefix the wildcard character manually wherever required.

4. Click **Search**.

A list of deals that meet the search criteria appears in the **Search Results** section.

Note:

Pagination is used to display limited number of records in the **Search Results** section. You can use the navigation links, such as **Previous** and **Next** to navigate between pages.

By default, the **Search Results** section lists all the deals which are assigned to user and are in the **Pending for Approval** status for the period as specified in the **Deal Limits in Months** option type of the **C1-DEAL** feature configuration.

You must specify at least one search criterion while searching for a deal. One more search criterion is required when you are searching for a deal using the deal entity.

You must specify one more search criterion when you are searching for a deal using the division with the **Deal Details** option selected from the **Search By** list.

Related Topics

For more information on...	See...
Deal Approver Dashboard screen	Deal Approver Dashboard on page 3066
Search Deal zone	Search Deal on page 3067

Viewing the Deal Approval Information

Procedure

To view the deal approval information:

1. Search for the deal whose approval information you want to view in the **Search Deal** zone of the **Deal Approver Dashboard** screen.

2. In the **Search Results** section, click the link in the **Deal Information** column corresponding to the deal whose approval information you want to view.

The **Deal Information** screen appears.

3. View the approval information of the deal in the **Deal Information** screen.

Related Topics

For more information on...	See...
How to search for a deal	Searching for a Deal on page 3072
Deal Approver Dashboard screen	Deal Approver Dashboard on page 3066
Search Deal zone	Search Deal on page 3067
Deal Information screen	Deal Information on page 2815

Viewing the Person Information

Procedure

To view the person information:

1. Search for the deal whose person information you want to view in the **Search Deal** zone of the **Deal Approver Dashboard** screen.
2. In the **Search Results** section, click the link in the **Person Information** column corresponding to the deal whose person information you want to view.

The **Customer 360° Information** or the **Prospect Person** screen appears.

Note: The **Customer 360° Information** screen appears when you select the **Account** or **Customer** option from the **Deal Entity** list in the **Search Criteria** while searching for a deal. Whereas, the **Prospect Person** screen appears when you select the **Prospect** option from the **Deal Entity** list in the **Search Criteria** while searching for a deal.

3. View the person information of the deal in the **Customer 360° Information - Person** tab or the **Prospect Person** screen.

Related Topics

For more information on...	See...
How to search for a deal	Searching for a Deal on page 3072
Deal Approver Dashboard screen	Deal Approver Dashboard on page 3066
Search Deal zone	Search Deal on page 3067
Customer 360° Information - Person tab	Customer 360° Information - Person on page 213

Viewing the Deal Approval Workflow Details

Procedure

To view the deal approval workflow:

1. Search for the deal whose approval workflow details you want to view in the **Search Deal** zone of the **Deal Approver Dashboard** screen.
2. In the **Search Results** section, click the **View Approval Workflow** () icon in the **View Approval Workflow** column corresponding to the deal whose approval workflow details you want to view.

The **Deal Approval Workflow** screen appears.

- View the approval workflow details of the deal in the **Deal Approval Workflow** screen.

Related Topics



For more information on...	See...
How to search for a deal	Searching for a Deal on page 3072
Deal Approver Dashboard screen	Deal Approver Dashboard on page 3066
Search Deal zone	Search Deal on page 3067
Deal Approval Workflow screen	Deal Approval Workflow on page 2814

Extracting a Deal in the PDF or Excel Format

Procedure

To extract a deal in the pdf or excel format:

- Do either of the following:

If you want to...	Then...
Extract a deal in the PDF or Excel format from the Deal Dashboard screen	<ol style="list-style-type: none"> Search for the deal in the Search Deal zone of the Deal Dashboard screen. In the Search Results section, click the Print () icon in the Print Deal column corresponding to the deal which you want to extract in the pdf or excel format. <p>Note: If the deal has multiple versions, click the Print () icon in the Print Deal column corresponding to the deal version in the Deal Versions zone.</p>
Extract a deal in the PDF or Excel format from the Deal Information screen	<ol style="list-style-type: none"> Search for the deal in the Search Deal zone of the Deal Dashboard screen. In the Search Results section, click the link in the Deal Information column corresponding to the deal which you want to extract in the pdf or excel format. <p>Note: If you want to extract the deal version in the pdf of excel format, click the link in the Deal Version Information column corresponding to the deal version from the Deal Versions zone.</p> <p>The Deal Information screen appears.</p> <ol style="list-style-type: none"> In the Simulation Details zone, click the Print Deal button.
Extract a deal in the PDF or Excel format from the Deal Approver Dashboard screen	<ol style="list-style-type: none"> Search for the deal in the Search Deal zone of the Deal Approver Dashboard screen.

If you want to...	Then...
	<p>2. In the Search Results section, click the Print () icon in the Print Deal column corresponding to the deal which you want to extract in the pdf or excel format.</p>

The **Deal Extraction** screen appears. It contains the following fields:

Field Name	Field Description	Mandatory (Yes or No)
Extract Format	<p>Used to specify the format in which you want to extract the deal information. The valid values are:</p> <ul style="list-style-type: none"> • Excel • PDF 	<p>Yes (Conditional)</p> <p>Note: This field is required while extracting a deal in the pdf or excel format.</p>
Extract Type	<p>Used to indicate the type of deal information that you want to extract for publishing. The valid values are:</p> <ul style="list-style-type: none"> • External - Used to extract deal information which is published to the customer for approval. It contains the following details: <ol style="list-style-type: none"> 1. Extraction information i.e. the extraction date-time and the user who has done the extraction. 2. Details of the filters selected for extraction. 3. Deal details such as the deal creator user ID, deal creation date and time, deal ID, deal type, prospect/customer, currency, deal status etc. 4. Customer hierarchy, accounts and price item details as per the filter option selected in the Deal Extraction screen. 5. Price item details such as the original price with assignment level, commitments, negotiated price with assignment level, approval status, etc. 6. Terms and conditions. 	<p>Yes (Conditional)</p> <p>Note: This field is required while extracting a deal in the pdf or excel format.</p>

Field Name	Field Description	Mandatory (Yes or No)
	<p>Note:</p> <p>The External extract type controls the extraction of certain data which may or may not be published to the customer.</p> <p>You can select the External option from the Extract Type list when the deal is in the Finalized, Customer Accepted, Rejected, Fully Orchestrated, Pending for Review, or Closed status.</p>	
	<ul style="list-style-type: none"> • Internal - Used to extract deal information which is published for internal reviews and validations. It contains the following details: <ol style="list-style-type: none"> 1. Deal summary details and Division summary details with the applicable cost, profitability, revenue and other calculations. 2. Price item details such as the cost and revenue details etc. 3. Adhoc revenue and cost entries. <p>Note:</p> <p>By default, the Internal option is selected from the Extract Type list for deals which are not in the Finalized, Customer Accepted, Rejected, Fully Orchestrated, Pending for Review, or Closed status.</p> <p>The list includes only those values which are present in the DEAL_EXTRACT_TYPE_FLG lookup field.</p>	
Extract Filter	<p>Used to indicate the price item information that you want to extract in the pdf or excel format. The valid values are:</p> <ul style="list-style-type: none"> • Account • Additional Filter Criteria • All • Customer • Division • Only Hierarchy • Price Assignment Level • Price Item 	<p>Yes (Conditional)</p> <p>Note: This field is required while extracting a deal in the pdf or excel format.</p>

Field Name	Field Description	Mandatory (Yes or No)
	<ul style="list-style-type: none"> Price Item Group <p>Note: The list includes only those values which are present in the DEAL_EXTRACT_FILTER_FLG lookup field.</p>	

In addition, the **Deal Extraction** screen contains the following fields:

Field Name	Field Description	Mandatory (Yes or No)
Account ID	<p>Used to specify the persons or prospects account for which you want to extract the price item pricing details.</p> <p>Note:</p> <p>The Search (🔍) icon appears corresponding to this field. On clicking the Search icon, the Prospect Account Search window appears where you can search for the respective account.</p> <p>This field appears when you select the Account option from the Extract Filter list.</p>	<p>Yes (Conditional)</p> <p>Note: This field is required while extracting the proposed price item pricing details of an account.</p>
Price Item	<p>Used to specify the price item for which you want to extract the pricing details.</p> <p>Note:</p> <p>The Search (🔍) icon appears corresponding to this field. On clicking the Search icon, the Price Item Search window appears where you can search for the respective price item.</p> <p>This field appears when you select the Account, Customer, and Price Item options from the Extract Filter list.</p>	No
Price Item Group Code	<p>Used to specify the root level hierarchy entity for which you want to extract the price item pricing details.</p> <p>Note:</p> <p>The Search (🔍) icon appears corresponding to this field. On clicking the Search icon, the Hierarchy Entity Search window appears where you can search for the respective root level hierarchy entity.</p> <p>This field appears when you select the Account, Customer, and Price Item Group options from the Extract Filter list.</p>	No

Field Name	Field Description	Mandatory (Yes or No)
Proposed Price Assignment Level	Used to extract the proposed price item pricing details for a particular assignment level.	No
	<p>Note:</p> <p>The list includes only those values which are present in the PA_LVL_FLG lookup field.</p> <p>This field appears when you select the Account, Customer, Price Assignment Level, Price Item, and Price Item Group options from the Extract Filter list.</p> <p>This field is disabled when you select the Show Price Assignment for Child Entities field check box.</p>	
Show Price Assignment for Child Entities	Used to indicate whether you want to extract the proposed price item price assignment details of the non-root level hierarchy entity.	No
	<p>Note: This field appears when you select the Account, Customer, Price Assignment Level, Price Item, and Price Item Group options from the Extract Filter list.</p>	
Current Approval User ID	Used to extract the details of the proposed price item pricing which is approved by a particular user.	Yes (Conditional)
	<p>Note:</p> <p>The Search (🔍) icon appears corresponding to this field. On clicking the Search icon, the User Search window appears where you can search for the respective root user.</p> <p>This field appears when you select the Additional Filter Criteria option from the Extract Filter list.</p> <p>This field is disabled when you specify the Price Item Manager To Do Role or Price Approval Status.</p>	
Price Item Manager To Do Role	Used to extract the details of the proposed price item pricing which is assigned using a particular price item manager To Do role.	Yes (Conditional)
	<p>Note:</p> <p>This field appears when you select the Additional Filter Criteria option from the Extract Filter list.</p> <p>This field is disabled when you specify the Current Approval User ID or Price Approval Status.</p>	

Field Name	Field Description	Mandatory (Yes or No)
Price Approval Status	Used to extract the details of the proposed price item pricing which are in a particular status. The valid values are: <ul style="list-style-type: none"> • Approved • Approved-Existing • Approved-Recommended • Error • Initial • Unapproved 	Yes (Conditional)
	<p>Note:</p> <p>This field appears when you select the Additional Filter Criteria option from the Extract Filter list.</p> <p>This field is disabled when you specify the Current Approval User ID or Price Item Manager To Do Role.</p>	<p>Note: This field is required while extracting the details of the proposed price item pricing in a particular status.</p>
Person ID	Used to extract the details of the proposed price items pricing of a particular person.	Yes (Conditional)
	<p>Note:</p> <p>The Search (🔍) icon appears corresponding to this field. On clicking the Search icon, the Prospect Person Search window appears where you can search for the respective person.</p> <p>This field appears when you select the Additional Filter Criteria option from the Extract Filter list.</p>	<p>Note: This field is required while extracting the details of the proposed price item pricing of a particular person.</p>
Division	Used to extract the details of the proposed price items pricing from a particular division.	Yes (Conditional)
	<p>Note: This field appears when you select the Customer option from the Extract Filter list.</p>	<p>Note: This field is required while extracting the details of the proposed price item pricing from a particular division.</p>

- Enter the required details in the **Deal Extraction** screen.
- Click **Extract**.

The deal is extracted in the pdf or excel format.

Note: You cannot extract a deal which is in the **Discarded** status.

Related Topics

For more information on...	See...
How to search for a deal	Searching for a Deal on page 2773
Deal Dashboard screen	Deal Dashboard on page 2757
Search Deal zone	Search Deal on page 2758
Deal Information screen	Deal Information on page 2815
Deal Approver Dashboard screen	Deal Approver Dashboard on page 3066
Simulation Details zone	Simulation Details on page 2847

Chapter 43

Relationship Manager Workbench

Topics:

- [Relationship Manager Workbench](#)
- [Unpaid Invoices Page](#)
- [Inactive Customer Details](#)
- [Revenue Trends](#)

Oracle Revenue Management and Billing provides you one-point-destination for all the relationship/account managers an unified view of all customers under a single relationship manager on a screen named **Relationship Manager Workbench**. This data can then be easily used for analysis, such as:

- Cumulated revenue, average revenue, and unpaid revenue details of the customers
- Cumulated details, active, inactive, and newly added customers under the relationship manager based on number of months that customer has done the transaction from any account
- Number of deals in difference status

In other words, this feature allows you to drill down to see or act on all current and historical revenue management and billing details. This allows you professionally and efficiently to drive the customer engagement effectively and elevate customer relationships.

Relationship Manager Workbench

The **Relationship Manager Workbench** screen is designed for a relationship manager wherein the relationship manager can obtain a holistic view of all its customers. It is designed to provide the following statistics to a relationship manager:

- [Revenue Metrics](#) on page 3085
- [Customer Metrics](#) on page 3085
- [Customer Hierarchy](#) on page 3086
- [Deal Snapshot](#) on page 3089
- [Top 10 Customers by Revenue](#) on page 3091
- [Top 10 Product By Revenue](#) on page 3092
- [Top 10 Price Items by Revenue](#) on page 3091
- [Top 10 Customers Revenue Variations](#) on page 3091

In addition, a relationship manager can also view all the assigned To Dos from the **Relationship Manager Workbench** screen.

For more information on...	See...
RM Workbench To Do Notification zone	RM Workbench To Do Notification on page 3090

RM Workbench

The **RM Workbench** zone allows you to search for a customer using various search criteria. It contains the following fields:

- **Search Criteria-** The **Search Criteria** contains the following fields:

Field Name	Field Description	Mandatory (Yes or No)
Period From	Used to indicate the period from when the customer is active.	Yes
	Note: By default, month and year is selected.	
Period To	Used to indicate the period till when the customer is active.	Yes
	Note: By default, month and year is selected.	
Relationship Manager	Used to search customers which belong to a particular relationship manager.	Yes
	Note: The list includes only those users where the Supervisor Role Flag (C1SUPFLG) characteristic is set to Y.	
Division	Used to search customers which belong to a particular division.	No
Customer Segment	Used to search for a customers which belong to a particular customer segment.	No

Field Name	Field Description	Mandatory (Yes or No)
	Note: The list includes only those values which are defined in the CUST_SEG_FLG lookup field.	
Customer Tier	Used to search for a customers which belong to a particular customer tier. Note: The list includes only those values which are defined in the CUST_TIER_FLG lookup field.	No

Note:

You must specify at least one search criterion while searching for customers. One more search criterion is required when you are searching for customers using the division and/or customer segment.

If you have specified any other search criterion along with the system ignores the additional search criterion and searches using the respectively.

Related Topics

For more information on...	See...
Searching for a customer	Searching for a Customer on page 3088
Searching for an account	Searching for an Account on page 3089
How to view RM Customer Compare UI	Viewing the RM Compare UI on page 3093

Revenue Metrics

The **Revenue Metrics** zone enables you to view the following information through a tiles chart:

- Total revenue from all the customers under the relationship manager
- Average revenue under the relationship manager
- Total bill amount from all invoices that are unpaid for all the customers under relationship manager

In addition, you can view the above information through a trend by selecting the **Trend** option available in the **Revenue Metrics** zone.

Note: By default, the above information is shown for the period which is specified in the **RM Workbench** zone. You can change the period if required.

You can filter the information using various criteria (such as, **Period From**, **Period To**, **Division**, **Customer Tier**, and **Customer Segment**) available in the **Deal Metrics** zone.

Related Topics

For more information on...	See...
Relation Manager Workbench screen	Relationship Manager Workbench on page 3084
How to view the Revenue Metrics in the trends	Viewing the Revenue Trends on page 3094

Customer Metrics

The **Customer Metrics** zone enables you to view the following information through a tiles chart:

- Total number of distinct customers under the relationship manager
- Total number of inactive customers whose transaction from any account has not done in selected period
- Total number of new customers added during the selected period under relationship manager

Note: By default, the above information is shown for the period which is specified in the **RM Workbench** zone. You can change the period if required.

You can filter the information using various criteria (such as, **Period From**, **Period To**, **Division**, **Customer Tier**, and **Customer Segment**) available in the **RM Workbench** zone.

Related Topics

For more information on...	See...
Relation Manager Workbench screen	Relationship Manager Workbench on page 3084
How to view the inactive customer details	Viewing the Inactive Customer's Details on page 3093

Customer Hierarchy

The **Customer Hierarchy** zone allows you to search for a person and account using various search criteria. It contains the following two sections:

- **Search Criteria** - The **Search Criteria** section contains the following fields:

Field Name	Field Description	Mandatory (Yes or No)
Search By	Used to indicate whether you want to search for a customer. The valid values are: <ul style="list-style-type: none"> • Customer • Account <p>Note: By default, the Customer option is selected.</p>	Yes
Division	Used to search customers which belong to a particular division. <p>Note:</p> This field appears when: <ul style="list-style-type: none"> • The Customer option is selected from the Search By list. • The Account option is selected from the Search By list. 	No
Customer Name	Used to search a particular a customer using its primary or secondary name. <p>Note: This field appears when the Customer option is selected from the Search By list.</p>	No
Customer Segment	Used to search for customers which belong to a particular customer segment.	No

Field Name	Field Description	Mandatory (Yes or No)
	Note: This field appears when the Customer option is selected from the Search By list.	
Person ID	Used to search a particular customer. Note: This field appears when the Customer option is selected from the Search By list. The Search icon () appears to the Person ID field. On clicking the Search icon, the Person Search window appears.	No
Identifier Type	Used to indicate the identifier type based on which you want to search for a customer. Note: This field appears when: <ul style="list-style-type: none"> • The Customer option is selected from the Search By list. • The Account option is selected from the Search By list. 	Yes (Conditional) Note: If you specify the identifier value as a search criteria, you have to select the identifier type.
Identifier Value	Used to search customers with a particular identifier. Note: This field appears when: <ul style="list-style-type: none"> • The Customer option is selected from the Search By list. • The Account option is selected from the Search By list. 	Yes (Conditional) Note: If you specify the identifier type as a search criteria, you have to enter the identifier value.
Customer Tier	Used to indicate the customer tier to which the customer is associated. Note: This field appears when the Customer option is selected from the Search By list.	No
Account ID	Used to search a particular customer. Note: This field appears when the Account option is selected from the Search By list.	No

Note:

By default, the **Customer Hierarchy** zone displays details of all customers under the relationship manager along with their child customers.

You must specify at least one search criterion while searching for a customer. One more search criterion is required when you are searching for a customer using the division and/or customer tier.

- **Search Results** - On clicking the **Search** button, the search results appear based on the specified search criteria. The **Search Results** section contains the following columns:

Column Name	Column Description
Customer Identifier	Displays the customer identifier. In addition, this column has a context menu which helps to view the list in ascending and descending order.
Customer Name	Displays the name of the customer. In addition, this column has a context menu which helps to view the list in ascending and descending order.
Actual Revenue	Displays the revenue generated from all accounts which are billed for the customer.
Committed Revenue	Displays the revenue committed from customer.
Revenue Variation	Displays revenue variation of the customer. Note: It has a link. On clicking the link, the Customer 360° Information screen appears where you can view the details of the respective customer.
Revenue Contribution	

Related Topics

For more information on...	See...
How to search for a customer	Searching for a Customer on page 3088
How to search for an account	Searching for an Account on page 3089

Searching for a Customer**Procedure**

To search for a customer:

1. Click the **Menu** link in the **Application** toolbar.
A list appears.
2. From the **Main** menu, select **Relationship Manager Workbench**.
The **Relationship Manager Workbench** screen appears.
3. Enter the search criteria in the **Customer Hierarchy** zone.

Note: ORMB search engine supports wildcard search, where you can substitute the percentage (%) symbol as a stand in for any word or letter in a search criteria. You can use the ‘%’ wildcard character in all input fields except the date and ID fields. The ‘%’ wildcard character is suffixed automatically at the end of the partial search criteria. Therefore, you may or may not specify the wildcard character at the end of the partial search criteria. However, you have to prefix the wildcard character manually wherever required.

4. Click **Search**.

A list of customers that meet the search criteria appears in the **Search Results** section.

Related Topics

For more information on...	See...
Relationship Manager Workbench screen	Relationship Manager Workbench on page 3084
Customer Hierarchy zone	Customer Hierarchy on page 3086

Searching for an Account

Procedure

To search for an account:

1. Click the **Menu** link in the **Application** toolbar.
A list appears.
2. From the **Main** menu, select **Relationship Manager Workbench**.
The **Relationship Manager Workbench** screen appears.
3. Select **Account** in **Search By** option.
4. Enter the search criteria in the **Customer Hierarchy** zone.

Note: ORMB search engine supports wildcard search, where you can substitute the percentage (%) symbol as a stand in for any word or letter in a search criteria. You can use the ‘%’ wildcard character in all input fields except the date and ID fields. The ‘%’ wildcard character is suffixed automatically at the end of the partial search criteria. Therefore, you may or may not specify the wildcard character at the end of the partial search criteria. However, you have to prefix the wildcard character manually wherever required.

5. Click **Search**.

A list of customers that meet the search criteria appears in the **Search Results** section.

Related Topics

For more information on...	See...
Relationship Manager Workbench screen	Relationship Manager Workbench on page 3084
Customer Hierarchy zone	Customer Hierarchy on page 3086

Deal Snapshot

The **Deal Snapshot** zone allows you to view information through a pie chart about different status of deals. The pie chart graphically represents the number of deals of an existing customer and existing account in the respective status.

In addition, you can view the above information through a tiles chart by selecting the () icon available in the **Deal Snapshot** zone.

Note: By default, the above information is shown for the period which is specified in the **RM Workbench** zone. You can change the period if required.

You can filter the information using various criteria (such as, **Period From**, **Period To**, **Division**, **Customer Tier**, and **Customer Segment**) available in the **RM Workbench** zone.

Related Topics

For more information on...	See...
Relation Manager Workbench screen	Relationship Manager Workbench on page 3084

RM Workbench To Do Notification

The **RM Workbench** zone allows you to search for all To Do's generated for the approving the deal using various search criteria. It contains the following sections:

- **Search Criteria** - The **Search Criteria** section contains the following fields:

Field Name	Field Description	Mandatory (Yes or No)
To Do Type	Used to specify the To Do task which is assigned to the approver/user group for approving the deal at the specified hierarchy level. Note: The Search () icon appears corresponding to do To Do Type field. On clicking the Search icon, the To Do Search window appears. On specifying the value for a predefined To Do type, the description of the To Do type appears corresponding to the To Do Type field.	Yes
Priority	Used to indicates the order in which the To Do list should be considered for the relationship manager.	No
Start Date	Used to indicate the date from when the deal approval profile is effective from the deal type. Note: The effective start date cannot be later than the effective end date.	No
End Date	Used to indicate the date till when the deal approval profile is effective from the deal type. Note: The effective end date cannot be earlier than the effective start date.	No

- **Search Results** - On clicking the **Search** button, the search results appear based on the specified search criteria. The **Search Results** section contains the following columns:

Column Name	Column Description
To Do	On clicking the To Do icon (), the To Do Entry screen appears where you can view the details of the respective To Do assigned to the user.
To Do Info	Displays the concatenated string of information about the deal separated by a comma (,) for which the To Do is created.

Note: By default, the above information is shown for the period which is specified in the **RM Workbench** zone. You can change the period if required.

You can filter the list using various criteria (such as, **To Do Type**, **Priority**, **Start Date**, and **End Date** available in the **Filter** area. You can view the **Filter** area by clicking the **Filter's** () icon in the upper right corner of this zone.

Note: Pagination is used to display limited number of records in this zone. You can use the navigation links, such as **Previous** and **Next** to navigate between pages.

Related Topics

For more information on...	See...
Relation Manager Workbench screen	Relationship Manager Workbench on page 3084

Top 10 Customers by Revenue

The **Top 10 Customers By Revenue** zone lists you to view the following information through a graph. The graph represent top 10 customers by revenue under the relationship manager for the selected period.

Note: By default, the above information is shown for the period which is specified in the **RM Workbench** zone. You can change the period if required.

By default, the graph displays top 10 customers. You can view the graph from bottom 10 customers by clicking the toggle switch towards Bottom 10 available above in **Top 10 Customers by Revenue** zone.

You can filter the information using various criteria (such as, **Period From, Period To, Division, Customer Tier,** and **Customer Segment**) available in the **RM Workbench** zone.

Related Topics

For more information on...	See...
Relation Manager Workbench screen	Relationship Manager Workbench on page 3084
How to view the revenue trends	Viewing the Revenue Trends on page 3094

Top 10 Price Items by Revenue

The **Top 10 Price Items By Revenue** zone lists you to view the following information through a graph. The graph represent top 10 price items by revenue under the relationship manager for the selected period.

Note: By default, the above information is shown for the period which is specified in the **RM Workbench** zone. You can change the period if required.

By default, the graph displays top 10 price items. You can view the graph from bottom 10 price items by clicking the toggle switch towards Bottom 10 available above in **Top 10 Price Items by Revenue** zone.

You can filter the information using various criteria (such as, **Period From, Period To, Division, Customer Tier,** and **Customer Segment**) available in the **RM Workbench** zone.

Related Topics

For more information on...	See...
Relation Manager Workbench screen	Relationship Manager Workbench on page 3084
How to view the revenue trends	Viewing the Revenue Trends on page 3094

Top 10 Customers Revenue Variations

The **Top 10 Customers Revenue Variations** zone lists you to view the following information through a graph. The graph represent top 10 customers revenue variations under the relationship manager for the selected period.

Note: By default, the above information is shown for the period which is specified in the **RM Workbench** zone. You can change the period if required.

By default, the graph displays top 10 customers. You can view the graph from bottom 10 customers by clicking the toggle switch towards Bottom 10 available above in **Top 10 Customers Revenue Variations** zone.

You can filter the information using various criteria (such as, **Period From, Period To, Division, Customer Tier,** and **Customer Segment**) available in the **RM Workbench** zone.

Related Topics

For more information on...	See...
Relation Manager Workbench screen	Relationship Manager Workbench on page 3084
How to view the revenue trends	Viewing the Revenue Trends on page 3094

Top 10 Product By Revenue

The **Top 10 Products By Revenue** zone lists you to view the following information through a graph. The graph represent top 10 products by revenue under the relationship manager for the selected period.

Note: By default, the above information is shown for the period which is specified in the **RM Workbench** zone. You can change the period if required.

By default, the graph displays top 10 products. You can view the graph from bottom 10 products by clicking the toggle switch towards Bottom 10 available above in **Top 10 Customers by Revenue** zone.

You can filter the information using various criteria (such as, **Period From, Period To, Division, Customer Tier,** and **Customer Segment**) available in the **RM Workbench** zone.

Related Topics

For more information on...	See...
Relation Manager Workbench screen	Relationship Manager Workbench on page 3084
How to view the revenue trends	Viewing the Revenue Trends on page 3094

Viewing the Unpaid Invoices Details

Procedure

To view the details of the unpaid invoices:

1. Search for the customers in the **Relationship Workbench Manager** screen.
2. In the **Revenue Metrics** section, click on the **Unpaid Revenue** tile whose details you want to view.

The **Unpaid Invoices Page** screen appears.

3. View the details of the unpaid revenue in the **Recievables by Age Chart** zone.

Related Topics

For more information on...	See...
How to search for a customer	Searching for a Customer on page 3088
How to search for an account	Searching for an Account on page 3089

For more information on...	See...
Relationship Manager Workbench screen	Relationship Manager Workbench on page 3084
RM Workbench zone	RM Workbench on page 3084

Viewing the Inactive Customer's Details

Procedure

To view the details of the inactive customers:

1. Search for the customers in the **Relationship Workbench Manager** screen.
2. In the **Customer Metrics** section, click on the **Inactive Customers** tile whose details you want to view.
The **Inactive Customer Details** screen appears.
3. View the details of the inactive customers in the **Inactive Customer Details** zone.

Related Topics

For more information on...	See...
How to search for a customer	Searching for a Customer on page 3088
How to search for an account	Searching for an Account on page 3089
Relationship Manager Workbench screen	Relationship Manager Workbench on page 3084
Customer Metrics zone	Customer Metrics on page 3085

Viewing the RM Compare UI

Procedure

To view the RM compare UI:

1. Search for the customers in the **Relationship Manager Workbench** screen.
2. In the **Customer Hierarchy** zone, click the checkbox corresponding to the *Customer Identifier* column whose comparison you want to view.
3. In the **Customer Hierarchy** zone, click the **Compare** button available in the right corner of the section.
The **RM Customer Compare UI** window appears.

Note: The **Compare** button appears when the more than one customers selected in the **Customer Hierarchy** zone.

4. View the comparison for the customers in the **RM Customer Compare UI** screen.

Related Topics

For more information on...	See...
How to search for a customer	Searching for a Customer on page 3088
How to search for an account	Searching for an Account on page 3089
Relationship Manager Workbench screen	Relationship Manager Workbench on page 3084
Customer Hierarchy zone	Customer Hierarchy on page 3086

Viewing the Revenue Trends

Procedure

To view the trends of the revenue:

1. Search for the customers in the **Relationship Workbench Manager** screen.
2. In the **Revenue Metrics** zone, click the **Trend** icon to view revenue in trends.
The **Revenue Trends** screen appears.
3. Ensure that the **Main** tab is selected.
4. Enter the search criteria in the **RM Trends Input** zone.

Note:

The **RM Trends Input** zone appears is in the **Revenue Trends** zone.

The date range specified in the **Period From** and **Period To** fields should not exceed the number of days specified in the **RM Workbench** zone.

ORMB search engine supports wildcard search, where you can substitute the percentage (%) symbol as a stand in for any word or letter in a search criteria. You can use the ‘%’ wildcard character in all input fields except the date and ID fields. The ‘%’ wildcard character is suffixed automatically at the end of the partial search criteria. Therefore, you may or may not specify the wildcard character at the end of the partial search criteria. However, you have to prefix the wildcard character manually wherever required.

5. Click **Search**.

You can view the trend in the **Revenue Trends** zone.

Related Topics

For more information on...	See...
Relationship Manager Workbench screen	Relationship Manager Workbench on page 3084
Revenue Metrics zone	Revenue Metrics on page 3085

Unpaid Invoices Page

The **Unpaid Invoices Page** screen is designed to obtain details of unpaid revenue of the customers. The **Unpaid Invoices Page** screen contains the following zones:

- [Receivables by Age Chart](#) on page 3094
- [Unpaid Revenue Customer's Details](#) on page 3095

Related Topics

For more information on...	See...
How to view the unpaid invoices details	Viewing the Unpaid Invoices Details on page 3092

Receivables by Age Chart

The **Receivable by Age Chart** zone enables you to view the following information through a graph:

- The receivable amount from all the bills in different age buckets

Note: By default, the above information is shown for the period which is specified in the **RM Workbench** zone. You can change the period if required.

You can filter the information using various criteria (such as, **Period From**, **Period To**, **Division**, **Customer Tier**, and **Customer Segment**) available in the **RM Workbench** zone.

Related Topics

For more information on...	See...
Relation Manager Workbench screen	Relationship Manager Workbench on page 3084
How to view the unpaid invoices page	Viewing the Unpaid Invoices Details on page 3092

Unpaid Revenue Customer's Details

The **Unpaid Revenue Customer's Details** zone lists the information about the unpaid revenue customers.

It contains the following columns:

Column Name	Column Description
Customer Information	Displays the information about the customer for whom the amount is receivable in the system. In addition, a context menu appears corresponding to this field which helps in navigating to other screens in the application. Note: It has a link. On clicking the link, the Customer 360° Information screen appears where you can view the details of the customer.
No Label Defined	
Unpaid Amount	Displays the total receivable amount for the customer in corporate currency.
Last TXN Date	Displays the date when the last transaction has done from the account of the customer.
Division	Displays the division to which the customer belongs.
Segment	Displays the segment to which customer belongs.
Contact Number	Displays the contact number of the customer in the system.
City	Displays the city of the customer in the system.
Country	Displays the country of the customer in the system.

Note:

Pagination is used to display limited number of records in the **Unpaid Revenue Customer's Details** zone. You can use the navigation links, such as **Previous** and **Next** to navigate between pages.

By default, the **Filter** area is hidden. You can view the **Filter** area by clicking the **Filters** () icon in the upper right corner of this zone.

Note: By default, the above information is shown for the period which is specified in the **RM Workbench** zone. You can change the period if required.

You can filter the information using various criteria (such as, **Period From**, **Period To**, **Division**, **Customer Tier**, and **Customer Segment**) available in the **RM Workbench** zone.

Related Topics

For more information on...	See...
Relation Manager Workbench screen	Relationship Manager Workbench on page 3084

Customer's Unpaid Bills Information

The **Customer's Unpaid Bills Information** zone lists the information about the unpaid bills from accounts of the customer.

It contains the following columns:

Column Name	Column Description
Account Information	Displays the concatenated string of information about the bill separated by a comma (.). In addition, a context menu appears corresponding to this field which helps in navigating to other screens in the application. Note: It has a link. On clicking the link, the Customer 360° Information screen appears where you can view the details of the customer.
Bill Information	Displays information about the bill. Note: It has a link. On clicking the link, the Bill screen appears where you can view the details of the bill.
Bill Amount	Displays the total receivable amount for the customer in corporate currency.
Invoice Date	Displays the information on which bill is created for a particular date.
Payment Date	Displays the information on which payment is to be paid on a particular date.

Note: By default, the above information is shown for the period which is specified in the **RM Workbench** zone. You can change the period if required.

You can filter the information using various criteria (such as, **Period From**, **Period To**, **Division**, **Customer Tier**, and **Customer Segment**) available in the **RM Workbench** zone.

Related Topics

For more information on...	See...
Relation Manager Workbench screen	Relationship Manager Workbench on page 3084

Inactive Customer Details

The **Inactive Customer Details** screen allows you to view the information about inactive customers listed in the descending order of period of inactivity. It contains the following zones:

- [Inactive Customer Details](#) on page 3097
- [Inactive Customers Account's Details](#) on page 3097

Related Topics

For more information on...	See...
How to view the inactive customers account details	Viewing the Inactive Customer's Account Details on page 3098

Inactive Customer Details

The **Inactive Customer Details** zone list the inactive customers listed in the descending order of period of inactivity. It contains the following columns:

Column Name	Column Description
Customer Information	Displays the information about the inactive customer. In addition, a context menu appears corresponding to this field which helps in navigating to other screens in the application. Note: It has a link. On clicking the link, the Customer 360° Information screen appears where you can view the details of the customer.
Name	Displays the name of the customer.
Division	Displays the division to which the customer belongs.
City	Displays the city of the customer.
Country	Displays the country of the customer in the system.
Hold	Displays the information about hold situation for the customer.
Collection	Displays the information about the collection process for the customer.
Customer Segment	Displays the segment to which customer belongs.
Inactive Since	Indicate the date from which the customer is inactive.

On clicking the **Broadcast** () icon corresponding to an inactive customer, the **Inactive Customers Account's Details** zone appears with the details of the respective customer.

Note:
Pagination is used to display limited number of records in the **Inactive Customer Details** zone. You can use the navigation links, such as **Previous** and **Next** to navigate between pages.

You can filter the information using various criteria (such as, **Period From**, **Period To**, **Division**, **Customer Tier**, and **Customer Segment**) available in the **Deal Metrics** zone.

Related Topics

For more information on...	See...
Relation Manager Workbench screen	Relationship Manager Workbench on page 3084
How to view the inactive customers accounts details	Viewing the Inactive Customer's Account Details on page 3098

Inactive Customers Account's Details

The **Inactive Customers Account's Details** zone lists the information about the accounts of the inactive customer. It contains the following columns:

Column Name	Column Description
Account Information	Displays the information of the account. In addition, a context menu appears corresponding to this field which helps in navigating to other screens in the application.

Column Name	Column Description
	Note: It has a link. On clicking the link, the Customer 360° Information screen appears where you can view the details of the account.
Division	Displays the division to which the account belongs.
Deliquent	Displays the information about deliquent situation for the account.
Last TXN Date	Indicate the date of last transaction from account.

Note: By default, the above information is shown for the period which is specified in the **RM Workbench** zone. You can change the period if required.

You can filter the information using various criteria (such as, **Period From**, **Period To**, **Division**, **Customer Tier**, and **Customer Segment**) available in the **Deal Metrics** zone.

Related Topics

For more information on...	See...
Relation Manager Workbench screen	Relationship Manager Workbench on page 3084
How to view the inactive customers accounts details	Viewing the Inactive Customer's Account Details on page 3098

Viewing the Inactive Customer's Account Details

Procedure

To view the details of the inactive customers account:

1. Search for the customers under the relationship manager in the **RM Workbench** zone.
2. In the **Customer Metrics** zone, click the **Inactive Customers** tile whose details you want to view.
The **Inactive Customer Details** screen appears.
3. Ensure that the **Main** tab is selected.
4. In the **Inactive Customer Details** zone, click the **Broadcast** () icon corresponding to the customer information whose account details you want to view.
The **Inactive Customers Account's Details** zone appears.
5. View the inactive customers accounts details in the **Inactive Customers Account's Details** zone.

Related Topics

For more information on...	See...
How to search for a customer	Searching for a Customer on page 3088
How to search for an account	Searching for an Account on page 3089
Relationship Manager Workbench screen	Relationship Manager Workbench on page 3084
Customer Metrics zone	Customer Metrics on page 3085

Revenue Trends

The **Revenue Trends** screen is designed to view of revenue and price item usage across the relationship manager portfolio. The **Revenue Trends** screen contains the following zones:

- [RM Trends Input](#) on page 3099
- [Revenue Trends](#) on page 3100
- [Price Item Revenue Vs Usage Trend](#) on page 3100

Related Topics

For more information on...	See...
How to view the revenue trend details	Viewing the Revenue Trends on page 3094

RM Trends Input

The **RM Trend Input** zone enables you to search for a view the information through trends. It contains the following fields:

- **Search Criteria** - The **Search Criteria** contains the following fields:

Field Name	Field Description	Mandatory (Yes or No)
Period From	Used to indicate the period from when revenue varies.	Yes
	Note: By default, month and year is selected.	
Period To	Used to indicate the period till when the revenue varies.	Yes
	Note: By default, month and year is selected.	
Relationship Manager	Used to search revenue variation belong to a particular relationship manager.	Yes
	Note: By default, the Relationship Manager is selected.	
Division	Used to indicate division.	No
Customer Segment	Used to indicate customer segment.	No
Customer Tier	Used to indicate customer tier.	No
Entity Type	Used to indicate the entity type	No
Entity Value	Used to indicate a valid value for the selected entity type.	Yes (Conditional)
		Note: his field is required if you select an option from the Entity Type field.
Price Item Type Flag	Used to indicate a price item type flag.	No
Price Item	Used to indicate a price item.	No

Note:

You must specify at least one search criterion while searching for a customer. One more search criterion is required when you want to view revenue trend.

Related Topics

For more information on...	See...
Relation Manager Workbench screen	Relationship Manager Workbench on page 3084
How to view the revenue metrics in the trends	Viewing the Revenue Trends on page 3094

Revenue Trends

The **Revenue trends** zone allows you to view information through a trend. The trend graphically represents the revenue of an existing customer and existing account over the past twelve period.

Note: By default, the above information is shown for the period which is specified in the **RM Trends Input** zone. You can change the period if required.

You can filter the information using various criteria (such as, **Period From, Period To, Division, Customer Tier, Entity Type, Entity Value, Price Item type Flag, and Price Item**) available in the **RM Trends Input** zone.

Related Topics

For more information on...	See...
Relation Manager Workbench screen	Relationship Manager Workbench on page 3084

Price Item Revenue Vs Usage Trend

The **Price Item Revenue Vs Usage Trend** zone allows you to view information through a trend. The trend graphically represents the piece item revenue of an existing customer and existing account over the past twelve period.

Note: By default, the above information is shown for the period which is specified in the **RM Trends Input** zone. You can change the period if required.

You can filter the information using various criteria (such as, **Period From, Period To, Division, Customer Tier, Entity Type, Entity Value, Price Item type Flag, and Price Item**) available in the **RM Trends Input** zone.

Related Topics

For more information on...	See...
Relation Manager Workbench screen	Relationship Manager Workbench on page 3084

Chapter 44

Hold Request Creation, Modification, Release, and View Through Inbound Web Service

Topics:

- [Prerequisites](#)
- [C1-CreateHoldRequest Business Service](#)
- [C1-GetHoldRequestHistory Business Service](#)
- [C1-ReleaseHoldRequest Business Service](#)
- [C1-UpdateHoldRequest Business Service](#)

Oracle Revenue Management and Billing enables you to create, edit, and release a hold request through a web service. It also enables you to view the details of a hold request through a web service. You can send the hold request creation, modification, release, or view request from the external system through an inbound web service. The following business services are shipped with the product to support different hold request operations:

Business Service	Description
C1-CreateHoldRequest	Used to create a hold request for a single entity (i.e. for a particular person, account, or bill). For more information, see C1-CreateHoldRequest Business Service on page 3103
C1-UpdateHoldRequest	Used to edit an active hold request. For more information, see C1-UpdateHoldRequest Business Service on page 3139
C1-GetHoldRequestHistory	Used to fetch the details of an active hold request with a single entity (i.e. person, account, or bill). The system enables you to track the hold request view response sent to the external system using the Inbound Web Service History feature. For more information, see C1-GetHoldRequestHistory Business Service on page 3119
C1-ReleaseHoldRequest	Used to release an active hold request with a single entity (i.e. person, account, or bill). For more information, see C1-ReleaseHoldRequest Business Service on page 3131

You can create one inbound web service which supports all four operations - hold request creation, hold request update, hold request release, and hold request view. Alternatively, you can create four different inbound web services - one for hold request creation, another for hold request update, third for hold request release, and fourth for hold request view.

You can create a SOAP or REST based inbound web service. If you want to send the request in the XML and/or JSON format, you need to ensure that you create a REST based inbound web service. However, if you want to send the request in the XML format, you can create a SOAP or REST based inbound web service.

For more information on how to setup this feature, see [Prerequisites](#) on page 3102.

Prerequisites

The following table lists the prerequisites for hold request creation, modification, release, and view through an inbound web service:

If you want to...	Then...
C1-CreateHoldRequest	<p>You need to do the following:</p> <ul style="list-style-type: none"> • Define a REST or SOAP based inbound web service to call the C1-CreateHoldRequest business service. • Authorize the ORMB user to access the required application service • Define the required hold request type for the hold request where the Approval Required flag is configured as No. • Define the required hold reason and comments • Define the required values for the HOLD_ENTITY_LVL_FLG lookup field. • Define the required values for the HOLD_PROCESS_FLG lookup field. • Define the required characteristic types where the characteristic entity is set to Hold Request
C1-UpdateHoldRequest	<p>Used to edit an active hold request. Through this service, you can edit the following details of an active hold request:</p> <ul style="list-style-type: none"> • End date, comments, and characteristics of a hold request • End date of a single hold entity in a hold request • End date of multiple hold processes in a hold request <p>It also allows you to delete a characteristic of a hold request. While sending the request for hold request modification, you need to specify the following details:</p> <ul style="list-style-type: none"> • Hold request ID • Hold entity ID (i.e. person ID, account ID, or bill ID) <p>Once the hold request is edited through the service, the hold request ID is sent in the response. The system enables you to track the hold request modification response sent to the external system using the Inbound Web Service History feature.</p>
C1-GetHoldRequestHistory	<p>Used to fetch the details of an active hold request with a single entity (i.e. person, account, or bill). The system enables you to track the hold request view response sent to the external system using the Inbound Web Service History feature.</p>
C1-ReleaseHoldRequest	<p>Used to release an active hold request with a single entity (i.e. person, account, or bill). While sending the request for hold request release, you need to specify the following details:</p> <ul style="list-style-type: none"> • Hold request ID • Hold release reason and comments <p>Once the hold request is released through the service, the hold request ID is sent in the response along with its status and end date. Note that the hold request end date is set to the system date. The system enables you to track the hold request release response sent to the external system using the Inbound Web Service History feature.</p>

Related Topics

For more information on...	See...
How to setup the C1-HOLDSRCH feature configuration	Setting the C1-HOLDSRCH Feature Configuration

C1-CreateHoldRequest Business Service

The **Create Hold Request (C1-CreateHoldRequest)** business service enables you to create a hold request for a single entity (i.e. for a particular account, bill, or person). You can call this business service from an external system through an inbound web service. If you want to send the hold request creation request in the XML and/or JSON format, you need to ensure that you create a REST based inbound web service in Oracle Revenue Management and Billing. However, if you want to send the hold request creation request in the XML format, you can create a SOAP or REST based inbound web service in Oracle Revenue Management and Billing.

While sending the request for hold request creation, you need to specify the following details:

- Hold request type, hold request start date, and hold request end date or hold days (which is used to calculate hold request end date if not specified)
- Entity (i.e. ACCT, BILL, or PERS) for which you want to create the hold request
- Hold reason and comments
- Entity identifiers when the entity is an account or a person, and the entity ID when the entity is a bill.
- Hold entity and hold process end dates
- Business processes (i.e. ATPY, BILL, FNDG, OVDU, REFD) which you want to hold for the entity
- Characteristics of the hold request

Points to Note:

- You must specify an active hold request type where the approval process is not configured for activation and release.
- If you do not specify the hold request type, the system, by default, considers the hold request type specified in the **Default Hold Request Type for IWS** option type of the **C1-HOLDSRCH** feature configuration.
- This business service does not allow you to create past dated or future dated hold request. Therefore, you must always set the hold request start date to the system date.
- Even if you explicitly specify a value for the defer processing count in the hold request type, it is no longer considered by this business service while creating a hold request.
- The upstream system may provide the hold request type to override the default hold request type, mentioned in the hold request inbound web service.
- If the hold request is in **DRAFT** status, this business service continues to operate in the background until the status of the hold request is set to **ACTIVE**.

On creating a hold request, the status of the hold request is set to **ACTIVE**. Once the hold request is created through the service, the hold request ID is sent in the response along with its status. The system enables you to track the hold request creation response sent to the external system using the Inbound Web Service History feature. For more information, see [Inbound Web Service History](#)

Related Topics

For more information on...	See...
Hold Request Creation Request in the XML Format	Hold Request Creation Request in the XML Format on page 3104
Hold Request Creation Response in the XML Format	Hold Request Creation Response in the XML Format on page 3105
Hold Request Creation Request in the JSON Format	Hold Request Creation Request in the JSON Format on page 3109
Hold Request Creation Response in the JSON Format	Hold Request Creation Response in the JSON Format on page 3110
Hold Request Creation Request and Response - Tags in XML Format	Hold Request Creation Request and Response - Tags in XML Format on page 3106
Hold Request Creation Request and Response - Attribute/Value Pairs in JSON Format	Hold Request Creation Request and Response - Attribute/Value Pairs in JSON Format on page 3111
Sample Hold Request Creation Request and Response in the XML Format	Sample Hold Request Creation Request and Response in the XML Format on page 3115
Sample Hold Request Creation Request and Response in the JSON Format	Sample Hold Request Creation Request and Response in the JSON Format on page 3117

Hold Request Creation Request in the XML Format

The following code snippet illustrates how the tags should be nested while receiving the hold request creation request in the XML format:

```
<C1-CreateHoldRequest>
  <holdRequest>
    <sourceSystem></sourceSystem>
    <externalTransactionId></externalTransactionId>
    <externalSourceId></externalSourceId>
    <holdStartDate></holdStartDate>
    <holdEndDate></holdEndDate>
    <holdDays></holdDays>
    <holdRequestType></holdRequestType>
    <holdEntity></holdEntity>
    <holdReason></holdReason>
    <holdComments></holdComments>
    <entityIdentifierType></entityIdentifierType>
    <entityIdentifierValue></entityIdentifierValue>
    <entityId></entityId>
    <holdEntityEndDate></holdEntityEndDate>
    <hierarchySwitch></hierarchySwitch>
    <holdProcessData>
      <holdProcess></holdProcess>
      <holdProcessEndDate></holdProcessEndDate>
    </holdProcessData>
    <characteristics>
      <characteristicType></characteristicType>
      <characteristicValue></characteristicValue>
      <effectiveDate></effectiveDate>
    </characteristics>
  </holdRequest>
</C1-CreateHoldRequest>
```

Related Topics

For more information on...	See...
Hold Request Creation Response in the XML Format	Hold Request Creation Response in the XML Format on page 3105
Hold Request Creation Request and Response - Tags in XML Format	Hold Request Creation Request and Response - Tags in XML Format on page 3106
Sample Hold Request Creation Request and Response in the XML Format	Sample Hold Request Creation Request and Response in the XML Format on page 3115

Hold Request Creation Response in the XML Format

The following code snippet illustrates how the tags should be nested while sending the hold request creation response in the XML format:

```
<C1-CreateHoldRequest>
  <holdRequest>
    <statusCd></statusCd>
    <holdRequestId></holdRequestId>
    <holdStatus></holdStatus>
    <messageText></messageText>
    <sourceSystem></sourceSystem>
    <externalTransactionId></externalTransactionId>
    <externalSourceId></externalSourceId>
    <holdStartDate></holdStartDate>
    <holdEndDate></holdEndDate>
    <holdDays></holdDays>
    <holdRequestType></holdRequestType>
    <holdEntity></holdEntity>
    <holdReason></holdReason>
    <holdComments></holdComments>
    <entityIdentifierType></entityIdentifierType>
    <entityIdentifierValue></entityIdentifierValue>
    <entityId></entityId>
    <holdEntityEndDate></holdEntityEndDate>
    <hierarchySwitch></hierarchySwitch>
    <holdProcessData>
      <holdProcess></holdProcess>
      <holdProcessEndDate></holdProcessEndDate>
    </holdProcessData>
    <characteristics>
      <characteristicType></characteristicType>
      <characteristicValue></characteristicValue>
      <effectiveDate></effectiveDate>
    </characteristics>
  </holdRequest>
</C1-CreateHoldRequest>
```

Related Topics

For more information on...	See...
Hold Request Creation Request in the XML Format	Hold Request Creation Request in the XML Format on page 3104
Hold Request Creation Request and Response - Tags in XML Format	Hold Request Creation Request and Response - Tags in XML Format on page 3106

For more information on...	See...
Sample Hold Request Creation Request and Response in the XML Format	Sample Hold Request Creation Request and Response in the XML Format on page 3115

Hold Request Creation Request and Response - Tags in XML Format

Note: We recommend you to refer the [Hold Request Creation Request in the XML Format](#) on page 3104 and [Hold Request Creation Response in the XML Format](#) on page 3105 topics in parallel while understanding the below mentioned tags. This will help you to understand how the tags are nested in the XML format.

Before calling the **C1-CreateHoldRequest** business service through an inbound web service, you need to ensure that the hold request creation request contains the following tags:

Tag Name	Tag Description	Mandatory (Yes or No)
C1-CreateHoldRequest	Used to indicate that you want to invoke the C1-CreateHoldRequest business service.	Yes
holdRequest	Used to specify the details of the hold request.	Yes
sourceSystem	Used to indicate the external system from which the hold creation request is sent. Note: You must specify an external system which is already defined in the system. The external system is used when the Inbound Web Service History feature is enabled. The specified external system should match the external system which is associated with the outbound message type specified in the C1-IWSHIST algorithm. If the external system is not specified in the hold request creation request, the system, by default, stamps the external system associated with the outbound message type (specified in the C1-IWSHIST algorithm) corresponding to the record in the C1_IWS_HIST table. For more information, see Inbound Web Service History .	No
externalTransactionId	Used to indicate the transaction in the external system through which the hold request creation request is sent. Note: The external transaction ID is used when the Inbound Web Service History feature is enabled.	No
externalSourceId	Used to specify the external source system ID. Note: The external source system ID is used when the Inbound Web Service History feature is enabled.	No
holdStartDate	Used to specify the date from when the hold request is effective.	Yes
holdEndDate	Used to specify the date till when the hold request is effective.	Yes (Conditional)

Tag Name	Tag Description	Mandatory (Yes or No)								
	<p>Note: The hold request end date must be either derived or provided by the upstream system before creating a hold request in an Active status.</p>	<p>Note: This data is required if the holdDays is not specified.</p>								
holdDays	<p>Used to specify the number of days an entity should be kept on hold in the hold request.</p> <p>Note: If the holdEndDate is not specified, the system calculates the holdEndDate by adding the holdDays to the holdStartDate. The system considers the holdDays as calendar days which include all the 7 days in a week.</p>	<p>Yes (Conditional)</p> <p>Note: This data is required if holdEndDate is not specified.</p>								
holdRequestType	<p>Used to specify an active hold request type where the approval process is not configured for activation and release.</p> <p>Note: If an active hold request type is used where the approval process is configured, the system throws an error with a failure response.</p>	No								
holdEntity	<p>Used to indicate the type of the entity for which you want to create the hold request. The valid values are:</p> <ul style="list-style-type: none"> • ACCT - Used when you want to specify the account. • BILL - Used when you want to specify the bill. • PERS - Used when you want to specify the person. <p>Note:</p> <table border="1" data-bbox="480 1188 1157 1581"> <thead> <tr> <th data-bbox="480 1188 792 1241">If...</th> <th data-bbox="792 1188 1157 1241">Then</th> </tr> </thead> <tbody> <tr> <td data-bbox="480 1241 792 1383">You are creating the hold request for an ACCT entity</td> <td data-bbox="792 1241 1157 1383">You can add Auto Pay, Bill Generation, Funding, and Overdue process in the hold request.</td> </tr> <tr> <td data-bbox="480 1383 792 1465">You are creating the hold request for a BILL entity</td> <td data-bbox="792 1383 1157 1465">You can only add Funding process in the hold request.</td> </tr> <tr> <td data-bbox="480 1465 792 1581">You are creating the hold request for a PERS entity</td> <td data-bbox="792 1465 1157 1581">You can add Bill Generation and Funding process in the hold request.</td> </tr> </tbody> </table> <p>You must specify a value which is already defined in the HOLD_ENTITY_LVL_FLG lookup field. It must be in the Active status.</p>	If...	Then	You are creating the hold request for an ACCT entity	You can add Auto Pay , Bill Generation , Funding , and Overdue process in the hold request.	You are creating the hold request for a BILL entity	You can only add Funding process in the hold request.	You are creating the hold request for a PERS entity	You can add Bill Generation and Funding process in the hold request.	Yes
If...	Then									
You are creating the hold request for an ACCT entity	You can add Auto Pay , Bill Generation , Funding , and Overdue process in the hold request.									
You are creating the hold request for a BILL entity	You can only add Funding process in the hold request.									
You are creating the hold request for a PERS entity	You can add Bill Generation and Funding process in the hold request.									
holdReason	<p>Used to specify the reason for the hold request.</p> <p>Note: You must specify a value which is already defined in the HOLD_REASON_FLG lookup field and is in the Active status.</p>	Yes								

Tag Name	Tag Description	Mandatory (Yes or No)
holdComments	Used to specify additional information about the hold request.	No
entityIdentifierType	Used to specify the entity type.	Yes (Conditional)
	Note: You cannot specify BILL as a type for the entity identifier.	Note: This data is required while defining or editing a hold request.
entityIdentifierValue	Used to specify the entity identifier (i.e. account or person).	Yes (Conditional)
	Note: You cannot specify BILL as a value for the entity identifier.	Note: This data is required while defining or editing a hold request.
entityId	Used to specify a list of entities for which you want to create a hold request.	Yes (Conditional)
	Note: You need to specify the entity ID when the hold entity is BILL .	Note: This data is required while defining or editing a hold request.
holdEntityEndDate	Used to specify the date till when the entity is effective for hold request.	No
hierarchySwitch	Used to associate the hold entity with the entity hierarchy relationship.	No
holdProcessData	Used to specify process information for the hold request.	Yes
holdProcess	Used to specify the process that you want to keep on hold in the hold request. The valid values are: <ul style="list-style-type: none"> • ATPY - Used when you want to specify the auto pay process. • BILL - Used when you want to specify the bill generation process. • FNDG - Used when you want to specify the funding process. • OVDU - Used when you want to specify the overdue process. 	Yes
	Note: You must specify a value which is already defined in the HOLD_PROCESS_FLG lookup field. It must be in the Active status.	
holdProcessEndDate	Used to specify the date till when the entity is effective for hold request.	No
characteristics	Used to specify a characteristic for the hold request.	Yes
characteristicType	Used to indicate the characteristic type.	Yes
	Note: You must specify a characteristic type where the characteristic entity is set to Hold Request and which is associated with the hold request type.	

Tag Name	Tag Description	Mandatory (Yes or No)
characteristicValue	Used to specify the value for the characteristic type.	Yes
effectiveDate	Used to specify the date from when the characteristic is effective.	Yes

The following table lists and describes the tags which appear in the hold request creation response in the XML format:

Tag Name	Tag Description
statusCd	Indicates whether the hold request creation request is successfully processed or not. The valid values are: <ul style="list-style-type: none"> • Success • Failure
holdRequestId	Displays the hold request ID.
holdStatus	Indicates the current status of the hold request.
messageText	Indicates the error that occurred while creating the hold request.
	Note: This tag appears when the value in the statusCd tag is set to Failure .

Related Topics

For more information on...	See...
Sample Hold Request Creation Request and Response in the XML Format	Sample Hold Request Creation Request and Response in the XML Format on page 3115

Hold Request Creation Request in the JSON Format

The following code snippet illustrates how the attribute/value pairs should be structured while receiving the hold request creation request in the JSON format:

```
{
  "C1-CreateHoldRequest": {
    "holdRequest": {
      "sourceSystem": ""
      "externalTransactionId": ""
      "externalSourceId": ""
      "holdStartDate": ""
      "holdEndDate": ""
      "holdDays": ""
      "holdRequestType": ""
      "holdEntity": ""
      "holdReason": ""
      "holdComments": ""
      "entityIdentifierType": ""
      "entityIdentifierValue": ""
      "entityId": ""
      "holdEntityEndDate": ""
      "hierarchySwitch": ""
      "holdProcessData": {
        "holdProcess": ""
        "holdProcessEndDate": ""
      }
    }
  }
}
```

```

    }
    characteristics":
    {
        "characteristicType": ""
        "characteristicValue": ""
        "effectiveDate": ""
    }
}
}
}

```

Related Topics

For more information on...	See...
Hold Request Creation Response in the JSON Format	Hold Request Creation Response in the JSON Format on page 3110
Hold Request Creation Request and Response - Attribute/Value Pairs in JSON Format	Hold Request Creation Request and Response - Attribute/Value Pairs in JSON Format on page 3111
Sample Hold Request Creation Request and Response in the JSON Format	Sample Hold Request Creation Request and Response in the JSON Format on page 3117

Hold Request Creation Response in the JSON Format

The following code snippet illustrates how the attribute/value pairs are structured while sending the hold request creation response in the JSON format:

```

{
  "Cl-CreateHoldRequest":
  {
    "holdRequest": ""
    {
      "statusCd": ""
      "holdRequestId": ""
      "holdStatus": ""
      "messageText": ""
      "sourceSystem": ""
      "externalTransactionId": ""
      "externalSourceId": ""
      "holdStartDate": ""
      "holdEndDate": ""
      "holdDays": ""
      "holdRequestType": ""
      "holdEntity": ""
      "holdReason": ""
      "holdComments": ""
      "entityIdentifierType": ""
      "entityIdentifierValue": ""
      "entityId": ""
      "holdEntityEndDate": ""
      "hierarchySwitch": ""
      "holdProcessData":
      {
        "holdProcess": ""
        "holdProcessEndDate": ""
      }
    }
    characteristics":
    {
      "characteristicType": ""
      "characteristicValue": ""
    }
  }
}

```

```

    "effectiveDate": ""
  }
}
}

```

Related Topics

For more information on...	See...
Hold Request Creation Request in the JSON Format	Hold Request Creation Request in the JSON Format on page 3109
Hold Request Creation Request and Response - Attribute/Value Pairs in JSON Format	Hold Request Creation Request and Response - Attribute/Value Pairs in JSON Format on page 3111
Sample Hold Request Creation Request and Response in the JSON Format	Sample Hold Request Creation Request and Response in the JSON Format on page 3117

Hold Request Creation Request and Response - Attribute/Value Pairs in JSON Format

Note: We recommend you to refer the [Hold Request Creation Request in the JSON Format](#) on page 3109 and [Hold Request Creation Response in the JSON Format](#) on page 3110 topics in parallel while understanding the below mentioned attributes. This will help you to understand how the attribute/value pairs are structured in the JSON format.

Before calling the **C1-CreateHoldRequest** business service through an inbound web service, you need to ensure that the hold request creation request contains the following attributes:

Attribute Name	Attribute Description	Mandatory (Yes or No)
C1-CreateHoldRequest	Used to indicate that you want to invoke the C1-CreateHoldRequest business service.	Yes
holdRequest	Used to specify the details of the hold request.	Yes
sourceSystem	Used to indicate the external system from which the hold creation request is sent. Note: You must specify an external system which is already defined in the system. The external system is used when the Inbound Web Service History feature is enabled. The specified external system should match the external system which is associated with the outbound message type specified in the C1-IWSHIST algorithm. If the external system is not specified in the hold request creation request, the system, by default, stamps the external system associated with the outbound message type (specified in the C1-IWSHIST algorithm) corresponding to the record in the C1_IWS_HIST table. For more information, see Inbound Web Service History .	No
externalTransactionId	Used to indicate the transaction in the external system through which the hold request creation request is sent.	No

Attribute Name	Attribute Description	Mandatory (Yes or No)
	<p>Note: The external transaction ID is used when the Inbound Web Service History feature is enabled.</p>	
externalSourceId	<p>Used to specify the external source system ID.</p> <p>Note: The external source system ID is used when the Inbound Web Service History feature is enabled.</p>	No
holdStartDate	Used to specify the date from when the hold request is effective.	Yes
holdEndDate	Used to specify the date till when the hold request is effective.	<p>Yes (Conditional)</p> <p>Note: This data is required if the holdDays is not specified.</p>
holdDays	<p>Used to specify the number of days an entity should be kept on hold in the hold request.</p> <p>Note: If the holdEndDate is not specified, the system calculates the holdEndDate by adding the holdDays to the holdStartDate. The system considers the holdDays as calendar days which include all the 7 days in a week.</p>	<p>Yes (Conditional)</p> <p>Note: This data is required if holdEndDate is not specified.</p>
holdRequestType	<p>Used to specify an active hold request type where the approval process is not configured for activation and release.</p> <p>Note: If an active hold request type is used where the approval process is configured, the system throws an error with a failure response.</p>	No
holdEntity	<p>Used to indicate the type of the entity for which you want to create the hold request. The valid values are:</p> <ul style="list-style-type: none"> • ACCT - Used when you want to specify the account. • BILL - Used when you want to specify the bill. • PERS - Used when you want to specify the person. 	Yes

Attribute Name	Attribute Description	Mandatory (Yes or No)								
	<p>Note:</p> <table border="1" data-bbox="493 300 1203 688"> <thead> <tr> <th data-bbox="493 300 820 348">If...</th> <th data-bbox="820 300 1203 348">Then</th> </tr> </thead> <tbody> <tr> <td data-bbox="493 348 820 495">You are creating the hold request for an ACCT entity</td> <td data-bbox="820 348 1203 495">You can add Auto Pay, Bill Generation, Funding, and Overdue process in the hold request.</td> </tr> <tr> <td data-bbox="493 495 820 579">You are creating the hold request for a BILL entity</td> <td data-bbox="820 495 1203 579">You can only add Funding process in the hold request.</td> </tr> <tr> <td data-bbox="493 579 820 688">You are creating the hold request for a PERS entity</td> <td data-bbox="820 579 1203 688">You can add Bill Generation and Funding process in the hold request.</td> </tr> </tbody> </table> <p>You must specify a value which is already defined in the HOLD_ENTITY_LVL_FLG lookup field. It must be in the Active status.</p>	If...	Then	You are creating the hold request for an ACCT entity	You can add Auto Pay, Bill Generation, Funding, and Overdue process in the hold request.	You are creating the hold request for a BILL entity	You can only add Funding process in the hold request.	You are creating the hold request for a PERS entity	You can add Bill Generation and Funding process in the hold request.	
If...	Then									
You are creating the hold request for an ACCT entity	You can add Auto Pay, Bill Generation, Funding, and Overdue process in the hold request.									
You are creating the hold request for a BILL entity	You can only add Funding process in the hold request.									
You are creating the hold request for a PERS entity	You can add Bill Generation and Funding process in the hold request.									
holdReason	<p>Used to specify the reason for the hold request.</p> <p>Note: You must specify a value which is already defined in the HOLD_REASON_FLG lookup field. It must be in the Active status.</p>	Yes								
holdComments	Used to specify additional information about the hold request.	No								
entityIdentifierType	<p>Used to specify the entity type.</p> <p>Note: You cannot specify BILL as a type for the entity identifier.</p>	<p>Yes (Conditional)</p> <p>Note: This data is required while defining or editing a hold request.</p>								
entityIdentifierValue	<p>Used to specify the entity identifier (i.e. account or person).</p> <p>Note: You cannot specify BILL as a value for the entity identifier.</p>	<p>Yes (Conditional)</p> <p>Note: This data is required while defining or editing a hold request.</p>								
entityId	<p>Used to specify a list of entities for which you want to create a hold request.</p> <p>Note: You need to specify the entityId when BILL is used as a hold entity.</p>	<p>Yes (Conditional)</p> <p>Note: This data is required while defining or editing a hold request.</p>								
holdEntityEndDate	Used to specify the date till when the entity is effective for hold request.	No								
hierarchySwitch	Used to associate the hold entity with the entity hierarchy relationship.	No								

Attribute Name	Attribute Description	Mandatory (Yes or No)
holdProcessData	Used to specify process information for the hold request.	Yes
holdProcess	Used to specify the process that you want to keep on hold in the hold request. The valid values are: <ul style="list-style-type: none"> • ATPY - Used when you want to specify the auto pay process. • BILL - Used when you want to specify the bill generation process. • FNDG - Used when you want to specify the funding process. • OVDU - Used when you want to specify the overdue process. <p>Note: You must specify a value which is already defined in the HOLD_PROCESS_FLG lookup field. It must be in the Active status.</p>	Yes
holdProcessEndDate	Used to specify the date till when the entity is effective for hold request.	No
characteristics	Used to specify a characteristic for the hold request.	Yes
characteristicType	Used to indicate the characteristic type. <p>Note: You must specify a characteristic type where the characteristic entity is set to Hold Request and which is associated with the hold request type.</p>	Yes
characteristicValue	Used to specify the value for the characteristic type.	Yes
effectiveDate	Used to specify the date from when the characteristic is effective.	Yes

The following table lists and describes the tags which appear in the hold request creation response in the JSON format:

Attribute Name	Attribute Description
statusCd	Indicates whether the hold request creation request is successfully processed or not. The valid values are: <ul style="list-style-type: none"> • Success • Failure
holdRequestId	Displays the hold request ID.
holdStatus	Indicates the current status of the hold request.
messageText	Indicates the error that occurred while creating the hold request. <p>Note: This tag appears when the value in the statusCd tag is set to Failure.</p>

Related Topics

For more information on...	See...
Sample Hold Request Creation Request and Response in the JSON Format	Sample Hold Request Creation Request and Response in the JSON Format on page 3117

Sample Hold Request Creation Request and Response in the XML Format

Using the below example, you can create a hold request for an account entity where the bill generation and auto pay process are kept on hold.

Sample Hold Request Creation Request in the XML Format

```
<C1-CreateHoldRequest>
  <holdRequest>
    <sourceSystem>SMALL_PRIME</sourceSystem>
    <externalTransactionId>567888876666</externalTransactionId>
    <externalSourceId>656565</externalSourceId>
    <holdStartDate>2021-12-01</holdStartDate>
    <holdEndDate>2021-12-31</holdEndDate>
    <holdDays>31</holdDays>
    <holdRequestType>HOLD_WITHOUT_APPROVAL</holdRequestType>
    <holdEntity>ACCT</holdEntity>
    <holdReason>4</holdReason>
    <holdComments>DUE_TO_TORNADO</holdComments>
    <entityIdentifierType>EIN</entityIdentifierType>
    <entityIdentifierValue>1446QIA</entityIdentifierValue>
    <entityId>1144444710</entityId>
    <holdEntityEndDate>2021-12-30</holdEntityEndDate>
    <hierarchySwitch>N</hierarchySwitch>
    <holdProcessData>
      <holdProcess>BILL</holdProcess>
      <holdProcessEndDate>2021-12-20</holdProcessEndDate>
    </holdProcessData>
    <holdProcessData>
      <holdProcess>ATPY</holdProcess>
      <holdProcessEndDate>2021-12-20</holdProcessEndDate>
    </holdProcessData>
    <characteristics>
      <characteristicType>ZZ_HLRQ</characteristicType>
      <characteristicValue>1</characteristicValue>
      <effectiveDate>2021-12-01</effectiveDate>
    </characteristics>
    <characteristics>
      <characteristicType>ZZ_HLDCH</characteristicType>
      <characteristicValue>5</characteristicValue>
      <effectiveDate>2021-12-01</effectiveDate>
    </characteristics>
  </holdRequest>
</C1-CreateHoldRequest>
```

Sample Hold Request Creation Response in the XML Format

The following information is received as response when the hold request is created successfully.

```
<C1-CreateHoldRequest>
  <holdRequest>
    <statusCd>SUCCESS</statusCd>
    <holdRequestId>790420762398</holdRequestId>
    <holdStatus>ACTIVE</holdStatus>
    <messageText></messageText>
    <sourceSystem>SMALL_PRIME</sourceSystem>
    <externalTransactionId>567888876666</externalTransactionId>
    <externalSourceId>656565</externalSourceId>
    <holdStartDate>2021-12-01</holdStartDate>
    <holdEndDate>2021-12-31</holdEndDate>
    <holdDays>31</holdDays>
    <holdRequestType>HOLD_WITHOUT_APPROVAL</holdRequestType>
    <holdEntity>ACCT</holdEntity>
    <holdReason>4</holdReason>
```

```

<holdComments>DUE_TO_TORNADO</holdComments>
<entityIdentifierType>EIN</entityIdentifierType>
<entityIdentifierValue>1446RAI</entityIdentifierValue>
<entityId>1144444710</entityId>
<holdEntityEndDate>2021-12-30</holdEntityEndDate>
<hierarchySwitch>N</hierarchySwitch>
<holdProcessData>
  <holdProcess>BILL</holdProcess>
  <holdProcessEndDate>2021-12-20</holdProcessEndDate>
</holdProcessData>
<holdProcessData>
  <holdProcess>ATPY</holdProcess>
  <holdProcessEndDate>2021-12-20</holdProcessEndDate>
</holdProcessData>
<characteristics>
  <characteristicType>ZZ_HLRQ</characteristicType>
  <characteristicValue>10</characteristicValue>
  <effectiveDate>2021-12-01</effectiveDate>
</characteristics>
<characteristics>
  <characteristicType>ZZ_HLDCH</characteristicType>
  <characteristicValue>55</characteristicValue>
  <effectiveDate>2021-12-01</effectiveDate>
</characteristics>
</holdRequest>
</C1-CreateAdjustment>

```

The following information is received when the hold request creation responds with a failure.

```

<C1-CreateHoldRequest>
  <holdRequest>
    <statusCd>FAILURE</statusCd>
    <holdRequestId>590525732377</holdRequestId>
    <holdStatus>ACTIVE</holdStatus>
    <messageText>The system could not retrieve the Account Id
    using the Account Identifier Type and Value combination.
    </messageText>
    <sourceSystem>ZZ_PRIME_SS</sourceSystem>
    <externalTransactionId>567888875445</externalTransactionId>
    <externalSourceId>256525</externalSourceId>
    <holdStartDate>2021-12-01</holdStartDate>
    <holdEndDate>2021-12-31</holdEndDate>
    <holdDays>31</holdDays>
    <holdRequestType>HOLD_WITHOUT_APPROVAL</holdRequestType>
    <holdEntity>ACCT</holdEntity>
    <holdReason>3</holdReason>
    <holdComments>FLOODS_IN_FL</holdComments>
    <entityIdentifierType>EIN</entityIdentifierType>
    <entityIdentifierValue>2345VB</entityIdentifierValue>
    <entityId>2344444730</entityId>
    <holdEntityEndDate>2021-12-30</holdEntityEndDate>
    <hierarchySwitch>N</hierarchySwitch>
    <holdProcessData>
      <holdProcess>BILL</holdProcess>
      <holdProcessEndDate>2021-12-20</holdProcessEndDate>
    </holdProcessData>
    <holdProcessData>
      <holdProcess>ATPY</holdProcess>
      <holdProcessEndDate>2021-12-20</holdProcessEndDate>
    </holdProcessData>
    <characteristics>
      <characteristicType>ZZ_CHR_HLRQ</characteristicType>
      <characteristicValue>1001</characteristicValue>
      <effectiveDate>2021-12-01</effectiveDate>
    </characteristics>
  </holdRequest>
</C1-CreateHoldRequest>

```



```

    </characteristics>
    <characteristics>
      <characteristicType>ZZ_CHR_HLRQ</characteristicType>
      <characteristicValue>7003</characteristicValue>
      <effectiveDate>2021-12-01</effectiveDate>
    </characteristics>
  </holdRequest>
</Cl-CreateAdjustment>

```

Note: We have given the above request and response samples to illustrate how the tags should be nested while sending a hold creation request from the external system. However, you should not seamlessly use this request sample in your environment because the required pre-requisite data may not be available in your environment. In such case, the system will give erroneous results.

Related Topics

For more information on...	See...
Hold Request Creation Request and Response - Tags in XML Format	Hold Request Creation Request and Response - Tags in XML Format on page 3106

Sample Hold Request Creation Request and Response in the JSON Format

Using the below example, you can create a hold request for an account entity where the overdue process is kept on hold.

Sample Hold Request Creation Request in the JSON Format

```

{
  "CreateHoldRequest": {
    "holdRequest": {
      "sourceSystem": "HOLD_TEST_TEXT",
      "externalTransactionId": "567888876666",
      "externalSourceId": "YERFDDD",
      "holdStartDate": "2022-01-10",
      "holdEndDate": "2022-12-30",
      "holdDays": "20",
      "holdRequestType": "HOLD_WITHOUT_APPROVAL",
      "holdEntity": "ACCT",
      "holdReason": "3",
      "holdComments": "FIRE_IN_SEAWOODS",
      "entityIdentifierType": "EIN",
      "entityIdentifierValue": "1446IC",
      "entityId": "2334454617",
      "holdEntityEndDate": "2022-12-30",
      "hierarchySwitch": "N",
      "holdProcessData": {
        "holdProcess": "OVDU",
        "holdProcessEndDate": "2021-12-30"
      }
    }
  }
}

```

Sample Hold Request Creation Response in the JSON Format

The following information is received as response when the hold request is created successfully.

```

{
  "CreateHoldRequest": {
    "holdRequest":

```

```

    {
      "statusCd": "SUCCESS",
      "holdRequestId": "790420762398",
      "holdStatus": "Active",
      "sourceSystem": "HOLDTESTEXT",
      "externalTransactionId": "567888876666",
      "externalSourceId": "YERFDDD",
      "holdStartDate": "2022-01-10",
      "holdEndDate": "2022-12-30",
      "holdDays": "20",
      "holdRequestType": "HOLD_WITHOUT_APPROVAL",
      "holdEntity": "ACCT",
      "holdReason": "3",
      "holdComments": "FIRE_IN_SEAWOODS",
      "entityIdentifierType": "EIN",
      "entityIdentifierValue": "1446IC",
      "entityId": "2334454617",
      "holdEntityEndDate": "2022-12-30",
      "hierarchySwitch": "N",
      "holdProcessData":
        {
          "holdProcess": "OVDU"
          "holdProcessEndDate": "2021-12-30"
        }
    }
  }
}

```

The following information is received when the hold request creation responds with a failure.

```

{
  "CreateHoldRequest":
  {
    "holdRequest":
    {
      "statusCd": "FAILURE",
      "messageText": "The system could not fetch the account id"
        "using the Account Identifier Type / Value combination.",
      "holdRequestId": "790420762398",
      "holdStatus": "Active",
      "sourceSystem": "ZZ_PRIME_TEST",
      "externalTransactionId": "323233478998",
      "externalSourceId": "YERFDDD",
      "holdStartDate": "2022-01-10",
      "holdEndDate": "2022-12-30",
      "holdDays": "20",
      "holdRequestType": "HOLD_WITHOUT_APPROVAL",
      "holdEntity": "ACCT",
      "holdReason": "3",
      "holdComments": "FLOODS_IN_CONNECTICUT",
      "entityIdentifierType": "EIN",
      "entityIdentifierValue": "2346IC",
      "entityId": "1237864231",
      "holdEntityEndDate": "2022-12-30",
      "hierarchySwitch": "N",
      "holdProcessData":
        {
          "holdProcess": "OVDU"
          "holdProcessEndDate": "2021-12-30"
        }
    }
  }
}

```

Note: We have given the above request and response samples to illustrate how the attribute value pairs should be structured while sending a hold creation request from the external system. However, you should not seamlessly use this request sample in your environment because the required pre-requisite data may not be available in your environment. In such case, the system will give erroneous results.

Related Topics

For more information on...	See...
Hold Request Creation Request and Response - Attribute/Value Pairs in JSON Format	Hold Request Creation Request and Response - Attribute/Value Pairs in JSON Format on page 3111

C1-GetHoldRequestHistory Business Service

The **Inquire Hold Request Details (C1-GetHoldRequestHistory)** business service enables you to view the details of an active hold request for a single entity (i.e. person, account, or bill). You can call this business service from an external system through an inbound web service. If you want to send the hold request view request in the XML and/or JSON format, you need to ensure that you create a REST based inbound web service in Oracle Revenue Management and Billing. However, if you want to send the hold request view request in the XML format, you can create a SOAP or REST based inbound web service in Oracle Revenue Management and Billing.

While sending the hold request view request, you need to specify the following details:

- Either the entity identifier type and entity identifier value or the entity ID.

Note: Specify a valid entity ID in the hold request view request which is used in the system.

The system enables you to track the hold request view response sent to the external system using the Inbound Web Service History feature. For more information, see [Inbound Web Service History](#)

Related Topics

For more information on...	See...
Hold Request View Request in the XML Format	Hold Request View Request in the XML Format on page 3120
Hold Request View Response in the XML Format	Hold Request View Response in the XML Format on page 3120
Hold Request View Request in the JSON Format	Hold Request View Request in the JSON Format on page 3123
Hold Request View Response in the JSON Format	Hold Request View Response in the JSON Format on page 3124
Hold Request View Request and Response - Tags in XML Format	Hold Request View Request and Response - Tags in XML Format on page 3121
Hold Request View Request and Response - Attribute/Value Pairs in JSON Format	Hold Request View Request and Response - Attribute/Value Pairs in JSON Format on page 3125
Sample Hold Request View Request and Response in the XML Format	Sample Hold Request View Request and Response in the XML Format on page 3127
Sample Hold Request View Request and Response in the JSON Format	Sample Hold Request View Request and Response in the JSON Format on page 3129

Hold Request View Request in the XML Format

The following code snippet illustrates how the tags should be nested while receiving the hold request view request in the XML format:

```
<Cl-GetHoldRequestHistory>
  <getHoldReqHistRequest>
    <sourceSystem></sourceSystem>
    <externalSourceId></externalSourceId>
    <clExternalTransactionId></clExternalTransactionId>
    <getHoldReqStartDt></getHoldReqStartDt>
    <getHoldReqEndDt></getHoldReqEndDt>
    <getHoldReqEntity></getHoldReqEntity>
    <getHoldReqReason></getHoldReqReason>
    <getHoldReqEntIdentType></getHoldReqEntIdentType>
    <getHoldReqEntIdentValue></getHoldReqEntIdentValue>
    <getHoldReqEntityId></getHoldReqEntityId>
    <getHoldReqProcess></getHoldReqProcess>
  </getHoldReqHistRequest>
</Cl-GetHoldRequestHistory>
```

Related Topics

For more information on...	See...
Hold Request View Response in the XML Format	Hold Request View Response in the XML Format on page 3120
Hold Request View Request and Response - Tags in XML Format	Hold Request View Request and Response - Tags in XML Format on page 3121
Sample Hold Request View Request and Response in the XML Format	Sample Hold Request View Request and Response in the XML Format on page 3127

Hold Request View Response in the XML Format

The following code snippet illustrates how the tags should be nested while sending the hold request view response in the XML format:

```
<Cl-GetHoldRequestHistory>
  <getHoldReqHistRequest>
    <sourceSystem></sourceSystem>
    <externalSourceId></externalSourceId>
    <clExternalTransactionId></clExternalTransactionId>
    <getHoldReqStartDt></getHoldReqStartDt>
    <getHoldReqEndDt></getHoldReqEndDt>
    <getHoldReqEntity></getHoldReqEntity>
    <getHoldReqReason></getHoldReqReason>
    <getHoldReqEntIdentType></getHoldReqEntIdentType>
    <getHoldReqEntIdentValue></getHoldReqEntIdentValue>
    <getHoldReqEntityId></getHoldReqEntityId>
    <getHoldReqProcess></getHoldReqProcess>
  </getHoldReqHistRequest>
  <holdReqHistResponse>
    <statusCd></statusCd>
    <messageText></messageText>
    <holdReqHistList>
      <holdReqId></holdReqId>
      <holdReqStartDt></holdReqStartDt>
      <holdReqEndDt></holdReqEndDt>
      <holdReqStatus></holdReqStatus>
      <holdReqType></holdReqType>
    </holdReqHistList>
  </holdReqHistResponse>
</Cl-GetHoldRequestHistory>
```

```

    <holdReqReason></holdReqReason>
    <holdReqEntity></holdReqEntity>
    <holdReqProcesses></holdReqProcesses>
  </holdReqHistList>
</holdReqHistResponse>
</C1-GetHoldRequestHistory>

```

Related Topics

For more information on...	See...
Hold Request View Request in the XML Format	Hold Request View Request in the XML Format on page 3120
Hold Request View Request and Response - Tags in XML Format	Hold Request View Request and Response - Tags in XML Format on page 3121
Sample Hold Request View Request and Response in the XML Format	Sample Hold Request View Request and Response in the XML Format on page 3127

Hold Request View Request and Response - Tags in XML Format

Note: We recommend you to refer the [Hold Request View Request in the XML Format](#) on page 3120 and [Hold Request View Response in the XML Format](#) on page 3120 topics in parallel while understanding the below mentioned tags. This will help you to understand how the tags are nested in the XML format.

Before calling the **C1-GetHoldRequestHistory** business service through an inbound web service, you need to ensure that the hold request view request contains the following tags:

Tag Name	Tag Description	Mandatory (Yes or No)
C1-GetHoldRequestHistory	Used to indicate that you want to invoke the C1-GetHoldRequestHistory business service.	Yes
getHoldReqHistRequest	Used to specify the details of the hold request which you want to view.	Yes
sourceSystem	Used to indicate the external system from which the hold view request is received. Note: You must specify an external system which is already defined in the system. The external system is used when the Inbound Web Service History feature is enabled. The specified external system should match the external system which is associated with the outbound message type specified in the C1-IWSHIST algorithm. If the external system is not specified in the hold request view request, the system, by default, stamps the external system associated with the outbound message type (specified in the C1-IWSHIST algorithm) corresponding to the record in the C1_IWS_HIST table. For more information, see Inbound Web Service History .	No
c1ExternalTransactionId	Used to indicate the transaction in the external system through which the hold request view request is sent.	No

Tag Name	Tag Description	Mandatory (Yes or No)
	Note: The external transaction ID is used when the Inbound Web Service History feature is enabled.	
externalSourceId	Used to specify the external source system ID. Note: The external source system ID is used when the Inbound Web Service History feature is enabled.	No
getHoldReqStartDt	Used when you want to view hold request details which are created from a particular date onwards.	Yes
getHoldReqEndDt	Used when you want to view hold request details which are created till a particular date.	No
getHoldReqEntity	Used when you want to view the hold request details for a particular entity. The valid values are: <ul style="list-style-type: none"> • ACCT • BILL • PERS 	Yes
getHoldReqReason	Used when you want to view the hold request details based on a specific reason. Note: You must specify a value which is already defined in the HOLD_REASON_FLG lookup field and is in the Active status.	Yes
getHoldReqEntIdentType	Used to specify the entity type. Note: You cannot specify BILL as a type for the entity identifier.	Yes (Conditional) Note: This data is required while viewing a hold request.
getHoldReqEntIdentValue	Used to specify the entity identifier (i.e. account or person). Note: You cannot specify BILL as a value for the entity identifier.	Yes (Conditional) Note: This data is required while viewing a hold request.
getHoldReqEntityId	Used to specify a list of entities for which you want to create a hold request. Note: You need to specify the entityId when BILL is used as a hold entity.	Yes (Conditional) Note: This data is required while viewing a hold request.
getHoldReqProcess	Used when you want to view the hold request details for a specific process. The valid values are: <ul style="list-style-type: none"> • ATPY • BILL 	Yes

Tag Name	Tag Description	Mandatory (Yes or No)
	<ul style="list-style-type: none"> • FNDG • OVDU 	

The following table lists and describes the tags which appear in the hold request view response in the XML format:

Tag Name	Tag Description
holdReqHistResponse	Displays the response returned by the business service in relation to the hold request.
statusCd	Indicates whether the hold request view request is successfully processed or not. The valid values are: <ul style="list-style-type: none"> • Success • Failure
messageText	Indicates the error that occurred while creating the hold request. Note: This tag appears when the value in the statusCd tag is set to Failure .
holdReqHistList	Displays the details of a hold request.
holdRequestId	Displays the hold request ID.
holdReqStartDt	Displays the date from when the hold request was effective.
holdReqEndDt	Displays the date till when the hold request was effective.
holdStatus	Indicates the current status of the hold request.
holdReqType	Indicates the type using which the hold request was created.
holdReqReason	Indicates the reason which was specified when the hold request was created.
holdReqEntity	Indicates the entity for which the hold request was created.
holdReqProcesses	Indicates the process which was kept on hold in the hold request.

Related Topics

For more information on...	See...
Sample Hold Request View Request and Response in the XML Format	Sample Hold Request View Request and Response in the XML Format on page 3127

Hold Request View Request in the JSON Format

The following code snippet illustrates how the attribute/value pairs should be structured while receiving the hold request view request in the JSON format:

```
{
  "Cl-GetHoldRequestHistory":
  {
    "getHoldReqHistRequest": ""
    {
      "sourceSystem": ""
      "externalSourceId": ""
      "clExternalTransactionId": ""
      "getHoldReqStartDt": ""
    }
  }
}
```

```

        "getHoldReqEndDt": ""
        "getHoldReqEntity": ""
        "getHoldReqReason": ""
        "getHoldReqEntIdentType": ""
        "getHoldReqEntIdentValue": ""
        "getHoldReqEntityId": ""
        "getHoldReqProcess": ""
    }
}
}

```

Related Topics

For more information on...	See...
Hold Request View Response in the JSON Format	Hold Request View Response in the JSON Format on page 3124
Hold Request View Request and Response - Attribute/Value Pairs in JSON Format	Hold Request View Request and Response - Attribute/Value Pairs in JSON Format on page 3125
Sample Hold Request View Request and Response in the JSON Format	Sample Hold Request View Request and Response in the JSON Format on page 3129

Hold Request View Response in the JSON Format

The following code snippet illustrates how the attribute/value pairs should be structured while receiving the hold request creation request in the JSON format:

```

{
  "Cl-GetHoldRequestHistory":
  {
    "getHoldReqHistRequest": ""
    {
      "sourceSystem": ""
      "externalSourceId": ""
      "clExternalTransactionId": ""
      "getHoldReqStartDt": ""
      "getHoldReqEndDt": ""
      "getHoldReqEntity": ""
      "getHoldReqReason": ""
      "getHoldReqEntIdentType": ""
      "getHoldReqEntIdentValue": ""
      "getHoldReqEntityId": ""
      "getHoldReqProcess": ""
    }
    "holdReqHistResponse": ""
    {
      "statusCd": ""
      "messageText": ""
      "holdReqHistList": ""
      {
        "holdReqId": ""
        "holdReqStartDt": ""
        "holdReqEndDt": ""
        "holdReqStatus": ""
        "holdReqType": ""
        "holdReqReason": ""
        "holdReqEntity": ""
        "holdReqProcesses": ""
      }
    }
  }
}

```



```
}
}
```

Related Topics

For more information on...	See...
Hold Request View Request in the JSON Format	Hold Request View Request in the JSON Format on page 3123
Hold Request View Request and Response - Attribute/Value Pairs in JSON Format	Hold Request View Request and Response - Attribute/Value Pairs in JSON Format on page 3125
Sample Hold Request View Request and Response in the JSON Format	Sample Hold Request View Request and Response in the JSON Format on page 3129

Hold Request View Request and Response - Attribute/Value Pairs in JSON Format

Note: We recommend you to refer the [Hold Request View Request in the JSON Format](#) on page 3123 and [Hold Request View Response in the JSON Format](#) on page 3124 topics in parallel while understanding the below mentioned attributes. This will help you to understand how the attribute/value pairs are structured in the JSON format.

Before calling the **C1-GetHoldRequestHistory** business service through an inbound web service, you need to ensure that the hold request view request contains the following tags:

Tag Name	Tag Description	Mandatory (Yes or No)
C1-GetHoldRequestHistory	Used to indicate that you want to invoke the C1-GetHoldRequestHistory business service.	Yes
getHoldReqHistRequest	Used to specify the details of the hold request which you want to view.	Yes
sourceSystem	Used to indicate the external system from which the hold view request is received. Note: You must specify an external system which is already defined in the system. The external system is used when the Inbound Web Service History feature is enabled. The specified external system should match the external system which is associated with the outbound message type specified in the C1-IWSHIST algorithm. If the external system is not specified in the hold request view request, the system, by default, stamps the external system associated with the outbound message type (specified in the C1-IWSHIST algorithm) corresponding to the record in the C1_IWS_HIST table. For more information, see Inbound Web Service History .	No
c1ExternalTransactionId	Used to indicate the transaction in the external system through which the hold request view request is sent. Note: The external transaction ID is used when the Inbound Web Service History feature is enabled.	No

Tag Name	Tag Description	Mandatory (Yes or No)
externalSourceId	Used to specify the external source system ID.	No
	Note: The external source system ID is used when the Inbound Web Service History feature is enabled.	
getHoldReqStartDt	Used when you want to view hold request details which are created from a particular date onwards.	Yes
getHoldReqEndDt	Used when you want to view hold request details which are created till a particular date.	No
getHoldReqEntity	Used when you want to view the hold request details for a particular entity. The valid values are: <ul style="list-style-type: none"> • ACCT • BILL • PERS 	Yes
getHoldReqReason	Used when you want to view the hold request details based on a specific reason.	Yes
	Note: You must specify a value which is already defined in the HOLD_REASON_FLG lookup field and is in the Active status.	
getHoldReqEntIdentType	Used to specify the entity type.	Yes (Conditional)
	Note: You cannot specify BILL as a type for the entity identifier.	
getHoldReqEntIdentValue	Used to specify the entity identifier (i.e. account or person).	Yes (Conditional)
	Note: You cannot specify BILL as a value for the entity identifier.	
getHoldReqEntityId	Used to specify a list of entities for which you want to create a hold request.	Yes (Conditional)
	Note: You need to specify the entityId when BILL is used as a hold entity.	
getHoldReqProcess	Used when you want to view the hold request details for a specific process. The valid values are: <ul style="list-style-type: none"> • ATPY • BILL • FNDG • OVDU 	Yes

The following table lists and describes the tags which appear in the hold request view response in the XML format:

Tag Name	Tag Description
holdReqHistResponse	Displays the response returned by the business service in relation to the hold request.
statusCd	Indicates whether the hold request view request is successfully processed or not. The valid values are: <ul style="list-style-type: none"> • Success • Failure
messageText	Indicates the error that occurred while creating the hold request. Note: This tag appears when the value in the statusCd tag is set to Failure .
holdReqHistList	Displays the details of a hold request.
holdRequestId	Displays the hold request ID.
holdReqStartDt	Displays the date from when the hold request was effective.
holdReqEndDt	Displays the date till when the hold request was effective.
holdStatus	Indicates the current status of the hold request.
holdReqType	Indicates the type using which the hold request was created.
holdReqReason	Indicates the reason which was specified when the hold request was created.
holdReqEntity	Indicates the entity for which the hold request was created.
holdReqProcesses	Indicates the process which was kept on hold in the hold request.

Related Topics

For more information on...	See...
Sample Hold Request View Request and Response in the JSON Format	Sample Hold Request View Request and Response in the JSON Format on page 3129

Sample Hold Request View Request and Response in the XML Format

Using the below example, you can view a hold request for the **ACCT** account entity where **ATPY** auto pay process is on hold.

Sample Hold Request View Request in the XML Format

```
<C1-GetHoldRequestHistory>
  <getHoldReqHistRequest>
    <sourceSystem>SIMPLE_PRIME_HOLD</sourceSystem>
    <externalSourceId>ESI1</externalSourceId>
    <c1ExternalTransactionId>ETI1</c1ExternalTransactionId>
    <getHoldReqStartDt>2022-01-01</getHoldReqStartDt>
    <getHoldReqEndDt></getHoldReqEndDt>
    <getHoldReqEntity>ACCT</getHoldReqEntity>
    <getHoldReqReason>TORNADO_IN_TX</getHoldReqReason>
    <getHoldReqEntIdentType>SSN_NO</getHoldReqEntIdentType>
    <getHoldReqEntIdentValue>987-65-4321</getHoldReqEntIdentValue>
    <getHoldReqEntityId>003526636627</getHoldReqEntityId>
    <getHoldReqProcess>ATPY</getHoldReqProcess>
  </getHoldReqHistRequest>
</C1-GetHoldRequestHistory>
```

Sample Hold Request View Response in the XML Format

The following information is received as response when the hold request is processed successfully.

```
<C1-GetHoldRequestHistory>
  <getHoldReqHistRequest>
    <sourceSystem>SIMPLE_PRIME_HOLD</sourceSystem>
    <externalSourceId>ESI1</externalSourceId>
    <c1ExternalTransactionId>ETI1</c1ExternalTransactionId>
    <getHoldReqStartDt>2022-01-01</getHoldReqStartDt>
    <getHoldReqEndDt></getHoldReqEndDt>
    <getHoldReqEntity>ACCT</getHoldReqEntity>
    <getHoldReqReason>TORNADO_IN_TX</getHoldReqReason>
    <getHoldReqEntIdentType>SSN_NO</getHoldReqEntIdentType>
    <getHoldReqEntIdentValue>987-65-4321</getHoldReqEntIdentValue>
    <getHoldReqEntityId>003526636627</getHoldReqEntityId>
    <getHoldReqProcess>ATPY</getHoldReqProcess>
  </getHoldReqHistRequest>
  <holdReqHistResponse>
    <statusCd>SUCCESS</statusCd>
    <messageText></messageText>
    <holdReqHistList>
      <holdReqId>006046575162</holdReqId>
      <holdReqStartDt>2022-01-01</holdReqStartDt>
      <holdReqEndDt></holdReqEndDt>
      <holdReqStatus>ACTIVE</holdReqStatus>
      <holdReqType>HOLD_WITHOUT_APPROVAL</holdReqType>
      <holdReqReason>TORNADO_IN_TX</holdReqReason>
      <holdReqEntity>003526636627</holdReqEntity>
      <holdReqProcesses>ATPY</holdReqProcesses>
    </holdReqHistList>
  </holdReqHistResponse>
</C1-GetHoldRequestHistory>
```

The following information is received from the hold request when the requested search parameters fail to return any search results.

```
<C1-GetHoldRequestHistory>
  <getHoldReqHistRequest>
    <sourceSystem>SIMPLE_PRIME_TEST</sourceSystem>
    <externalSourceId>ESI55</externalSourceId>
    <c1ExternalTransactionId>ETI33</c1ExternalTransactionId>
    <getHoldReqStartDt>2021-12-01</getHoldReqStartDt>
    <getHoldReqEndDt></getHoldReqEndDt>
    <getHoldReqEntity>PERS</getHoldReqEntity>
    <getHoldReqReason>FLOODS_IN_TX</getHoldReqReason>
    <getHoldReqEntIdentType>SSN_NO</getHoldReqEntIdentType>
    <getHoldReqEntIdentValue>987-65-4323</getHoldReqEntIdentValue>
    <getHoldReqEntityId>004556623427</getHoldReqEntityId>
    <getHoldReqProcess>ATPY</getHoldReqProcess>
  </getHoldReqHistRequest>
  <holdReqHistResponse>
    <statusCd>FAILURE</statusCd>
    <messageText>The system could not retrieve hold request ID based on
the search parameters.
    </messageText>
    <holdReqHistList>
      <holdReqId></holdReqId>
      <holdReqStartDt></holdReqStartDt>
      <holdReqEndDt></holdReqEndDt>
      <holdReqStatus></holdReqStatus>
      <holdReqType></holdReqType>
      <holdReqReason></holdReqReason>
      <holdReqEntity></holdReqEntity>
      <holdReqProcesses></holdReqProcesses>
    </holdReqHistList>
  </holdReqHistResponse>
</C1-GetHoldRequestHistory>
```

```

    </holdReqHistList>
  </holdReqHistResponse>
</C1-GetHoldRequestHistory>

```

Note: We have given the above request and response samples to illustrate how the tags should be nested while sending a hold view request from the external system. However, you should not seamlessly use this request sample in your environment because the required pre-requisite data may not be available in your environment. In such case, the system will give erroneous results.

Related Topics

For more information on...	See...
Hold Request View Request and Response - Tags in XML Format	Hold Request View Request and Response - Tags in XML Format on page 3121

Sample Hold Request View Request and Response in the JSON Format

Using the below example, you can view a hold request for the **ACCT** account entity where **ATPY** auto pay process is on hold.

Sample Hold Request View Request in the JSON Format

```

{
  "C1-GetHoldRequestHistory":
  {
    "getHoldReqHistRequest": ""
    {
      "sourceSystem": "SIMPLE_PRIME_HOLD"
      "externalSourceId": "ESI1"
      "clExternalTransactionId": "ETI1"
      "getHoldReqStartDt": "2022-01-01"
      "getHoldReqEndDt": ""
      "getHoldReqEntity": "ACCT"
      "getHoldReqReason": "TORNADO_IN_TX"
      "getHoldReqEntIdentType": "SSN_NO"
      "getHoldReqEntIdentValue": "987-65-4321"
      "getHoldReqEntityId": "003526636627"
      "getHoldReqProcess": "ATPY"
    }
  }
}

```

Sample Hold Request View Response in the JSON Format

```

{
  "C1-GetHoldRequestHistory":
  {
    "getHoldReqHistRequest": ""
    {
      "sourceSystem": "SIMPLE_PRIME_HOLD"
      "externalSourceId": "ESI1"
      "clExternalTransactionId": "ETI1"
      "getHoldReqStartDt": "2022-01-01"
      "getHoldReqEndDt": ""
      "getHoldReqEntity": "ACCT"
      "getHoldReqReason": "TORNADO_IN_TX"
      "getHoldReqEntIdentType": "SSN_NO"
      "getHoldReqEntIdentValue": "987-65-4321"
      "getHoldReqEntityId": "003526636627"
      "getHoldReqProcess": "ATPY"
    }
  }
  "holdReqHistResponse":

```

```

    {
      "statusCd": "SUCCESS",
      "messageText": ""
      "holdReqHistList":
      {
        "holdReqId": "006046575162",
        "holdReqStartDt": "2022-01-01",
        "holdReqEndDt": "",
        "holdReqStatus": "ACTIVE",
        "holdReqType": "HOLD_WITHOUT_APPROVAL",
        "holdReqReason": "TORNADO_IN_TX",
        "holdReqEntity": "003526636627",
        "holdReqProcesses": "ATPY"
      }
    }
  }
}

```

The following information is received from the hold request when the requested search parameters fail to return any search results.

```

{
  "Cl-GetHoldRequestHistory":
  {
    "getHoldReqHistRequest": ""
    {
      "sourceSystem": "SIMPLE_PRIME_HOLD"
      "externalSourceId": "ESI1"
      "clExternalTransactionId": "ETI1"
      "getHoldReqStartDt": "2022-01-01"
      "getHoldReqEndDt": ""
      "getHoldReqEntity": "ACCT"
      "getHoldReqReason": "TORNADO_IN_TX"
      "getHoldReqEntIdentType": "SSN_NO"
      "getHoldReqEntIdentValue": "987-65-4321"
      "getHoldReqEntityId": "003526636627"
      "getHoldReqProcess": "ATPY"
    }
    "holdReqHistResponse":
    {
      "statusCd": "FAILURE",
      "messageText": "The system could not retrieve hold request ID
based on the search parameters."
      "holdReqHistList":
      {
        "holdReqId": "",
        "holdReqStartDt": "",
        "holdReqEndDt": "",
        "holdReqStatus": "",
        "holdReqType": "",
        "holdReqReason": "",
        "holdReqEntity": "",
        "holdReqProcesses": ""
      }
    }
  }
}

```

Note: We have given the above request and response samples to illustrate how the attribute value pairs should be structured while sending a hold view request from the external system. However, you should not seamlessly use this request sample in your environment because the required pre-requisite data may not be available in your environment. In such case, the system will give erroneous results.

Related Topics

For more information on...	See...
Hold Request View Request and Response - Attribute/Value Pairs in JSON Format	Hold Request View Request and Response - Attribute/Value Pairs in JSON Format on page 3125

C1-ReleaseHoldRequest Business Service

The **Release Hold Request (C1-ReleaseHoldRequest)** business service enables you to release an active hold request for a single entity (i.e. person, account, or bill). You can call this business service from an external system through an inbound web service. If you want to send the hold request release request in the XML and/or JSON format, you need to ensure that you create a REST based inbound web service in Oracle Revenue Management and Billing. However, if you want to send the hold request release request in the XML format, you can create a SOAP or REST based inbound web service in Oracle Revenue Management and Billing.

While sending the hold request release request, you need to specify the following details:

- Hold request ID
- Hold release reason and comments

Once the hold request is released through this business service, the hold request ID is sent in the response along with its status and end date. Note that the hold request end date is set to the system date. The system enables you to track the hold request release response sent to the external system using the Inbound Web Service History feature. For more information, see [Inbound Web Service History](#)

Related Topics

For more information on...	See...
Hold Request Release Request in the XML Format	Hold Request Release Request in the XML Format on page 3132
Hold Request Release Response in the XML Format	Hold Request Release Response in the XML Format on page 3132
Hold Request Release Request in the JSON Format	Hold Request Release Request in the JSON Format on page 3134
Hold Request Release Response in the JSON Format	Hold Request Release Response in the JSON Format on page 3135
Hold Request Release Request and Response - Tags in XML Format	Hold Request Release Request and Response - Tags in XML Format on page 3133
Hold Request Release Request and Response - Attribute/Value Pairs in JSON Format	Hold Request Release Request and Response - Tags in JSON Format on page 3135
Sample Hold Request Release Request and Response in the XML Format	Sample Hold Request Release Request and Response in the XML Format on page 3137
Sample Hold Request Release Request and Response in the JSON Format	Sample Hold Request Release Request and Response in the JSON Format on page 3138

Hold Request Release Request in the XML Format

The following code snippet illustrates how the tags should be nested while receiving the hold request view request in the XML format:

```
<C1-ReleaseHoldRequest>
  <sourceSystem></sourceSystem>
  <externalTransactionId></externalTransactionId>
  <externalSourceId></externalSourceId>
  <holdRequestId></holdRequestId>
  <holdReleaseReason></holdReleaseReason>
  <holdComments></holdComments>
</C1-ReleaseHoldRequest>
```

Related Topics

For more information on...	See...
Hold Request Release Response in the XML Format	Hold Request Release Response in the XML Format on page 3132
Hold Request Release Request and Response - Tags in XML Format	Hold Request Release Request and Response - Tags in XML Format on page 3133
Sample Hold Request Release Request and Response in the XML Format	Sample Hold Request Release Request and Response in the XML Format on page 3137

Hold Request Release Response in the XML Format

The following code snippet illustrates how the tags should be nested while receiving the hold request view request in the XML format:

```
<C1-ReleaseHoldRequest>
  <requestProcessStatus></requestProcessStatus>
  <sourceSystem></sourceSystem>
  <externalTransactionId></externalTransactionId>
  <externalSourceId></externalSourceId>
  <holdRequestId></holdRequestId>
  <holdReleaseReason></holdReleaseReason>
  <holdComments></holdComments>
  <holdEndDate></holdEndDate>
  <holdRequestStatus></holdRequestStatus>
  <errorMsg></errorMsg>
</C1-ReleaseHoldRequest>
```

Related Topics

For more information on...	See...
Hold Request Release Request in the XML Format	Hold Request Release Request in the XML Format on page 3132
Hold Request Release Request and Response - Tags in XML Format	Hold Request Release Request and Response - Tags in XML Format on page 3133
Sample Hold Request Release Request and Response in the XML Format	Sample Hold Request Release Request and Response in the XML Format on page 3137

Hold Request Release Request and Response - Tags in XML Format

Note: We recommend you to refer the [Hold Request Release Request in the XML Format](#) on page 3132 and [Hold Request Release Response in the XML Format](#) on page 3132 topics in parallel while understanding the below mentioned tags. This will help you to understand how the tags are nested in the XML format.

Before calling the **C1-ReleaseHoldRequest** business service through an inbound web service, you need to ensure that the hold request view request contains the following tags:

Tag Name	Tag Description	Mandatory (Yes or No)
C1-ReleaseHoldRequest	Used to indicate that you want to invoke the C1-ReleaseHoldRequest business service.	Yes
sourceSystem	Used to indicate the external system from which the hold release request is received. Note: You must specify an external system which is already defined in the system. The external system is used when the Inbound Web Service History feature is enabled. The specified external system should match the external system which is associated with the outbound message type specified in the C1-IWSHIST algorithm. If the external system is not specified in the hold request view request, the system, by default, stamps the external system associated with the outbound message type (specified in the C1-IWSHIST algorithm) corresponding to the record in the C1_IWS_HIST table. For more information, see Inbound Web Service History .	No
externalTransactionId	Used to indicate the transaction in the external system through which the hold request release request is sent. Note: The external transaction ID is used when the Inbound Web Service History feature is enabled.	No
externalSourceId	Used to specify the external source system ID. Note: The external source system ID is used when the Inbound Web Service History feature is enabled.	No
holdRequestId	Used to specify the hold request ID of the hold request for which the hold request release request is sent. Note: You must specify the hold request ID which is already defined in the system.	Yes
holdReleaseReason	Used to specify the reason for releasing the hold request. Note: You must specify a value which is already defined in the HOLD_REASON_FLG lookup field. It must be in the Active status.	Yes

Tag Name	Tag Description	Mandatory (Yes or No)
holdComments	Used to specify additional information about the hold request.	No

The following table lists and describes the tags which appear in the hold request view response in the XML format:

Tag Name	Tag Description
requestProcessStatus	Indicates whether the hold request view request is successfully processed or not. The valid values are: <ul style="list-style-type: none"> • Success • Failure
holdRequestId	Displays the hold request ID.
holdReleaseReason	Indicates the reason which was specified when the hold request was released.
holdComments	Displays additional information about the hold request.
errormsg	Indicates the error that occurred while creating the hold request. Note: This tag appears when the value in the requestProcessStatus tag is set to Failure .
holdEndDate	Displays the date till when the hold request was effective.
holdStatus	Indicates the current status of the hold request.

Related Topics

For more information on...	See...
Sample Hold Request Release Request and Response in the XML Format	Sample Hold Request Release Request and Response in the XML Format on page 3137

Hold Request Release Request in the JSON Format

The following code snippet illustrates how the tags should be nested while receiving the hold request view request in the XML format:

```
{
  "C1-ReleaseHoldRequest" :
  {
    "sourceSystem": ""
    "externalTransactionId": ""
    "externalSourceId": ""
    "holdRequestId": ""
    "holdReleaseReason": ""
    "holdComments": ""
  }
}
```

Related Topics

For more information on...	See...
Hold Request Release Response in the JSON Format	Hold Request Release Response in the JSON Format on page 3135
Hold Request Release Request and Response - Tags in JSON Format	Hold Request Release Request and Response - Tags in JSON Format on page 3135
Sample Hold Request Release Request and Response in the JSON Format	Sample Hold Request Release Request and Response in the JSON Format on page 3138

Hold Request Release Response in the JSON Format

The following code snippet illustrates how the tags should be nested while receiving the hold request view request in the XML format:

```
{
  "C1-ReleaseHoldRequest" :
  {
    "requestProcessStatus": ""
    "sourceSystem": ""
    "externalTransactionId": ""
    "externalSourceId": ""
    "holdRequestId": ""
    "holdReleaseReason": ""
    "holdComments": ""
    "holdEndDate": ""
    "holdRequestStatus": ""
    "errmsg": ""
  }
}
```

Related Topics

For more information on...	See...
Hold Request Release Request in the JSON Format	Hold Request Release Request in the JSON Format on page 3134
Hold Request Release Request and Response - Tags in JSON Format	Hold Request Release Request and Response - Tags in JSON Format on page 3135
Sample Hold Request Release Request and Response in the JSON Format	Sample Hold Request Release Request and Response in the JSON Format on page 3138

Hold Request Release Request and Response - Tags in JSON Format

Note: We recommend you to refer the [Hold Request Release Request in the JSON Format](#) on page 3134 and [Hold Request Release Response in the JSON Format](#) on page 3135 topics in parallel while understanding the below mentioned tags. This will help you to understand how the tags are nested in the XML format.

Before calling the **C1-ReleaseHoldRequest** business service through an inbound web service, you need to ensure that the hold request view request contains the following tags:

Tag Name	Tag Description	Mandatory (Yes or No)
C1-ReleaseHoldRequest	Used to indicate that you want to invoke the C1-ReleaseHoldRequest business service.	Yes
sourceSystem	Used to indicate the external system from which the hold release request is received. Note: You must specify an external system which is already defined in the system. The external system is used when the Inbound Web Service History feature is enabled. The specified external system should match the external system which is associated with the outbound message type specified in the C1-IWSHIST algorithm. If the external system is not specified in the hold request view request, the system, by default, stamps the external system associated with the outbound message type (specified in the C1-IWSHIST algorithm) corresponding to the record in the C1_IWS_HIST table. For more information, see Inbound Web Service History .	No
externalTransactionId	Used to indicate the transaction in the external system through which the hold request release request is sent. Note: The external transaction ID is used when the Inbound Web Service History feature is enabled.	No
externalSourceId	Used to specify the external source system ID. Note: The external source system ID is used when the Inbound Web Service History feature is enabled.	No
holdRequestId	Used to specify the hold request ID of the hold request for which the hold request release request is sent. Note: You must specify the hold request ID which is already defined in the system.	Yes
holdReleaseReason	Used to specify the reason for releasing the hold request. Note: You must specify a value which is already defined in the HOLD_REASON_FLG lookup field. It must be in the Active status.	Yes
holdComments	Used to specify additional information about the hold request.	No

The following table lists and describes the tags which appear in the hold request view response in the XML format:

Tag Name	Tag Description
requestProcessStatus	Indicates whether the hold request view request is successfully processed or not. The valid values are: <ul style="list-style-type: none"> • Success

Tag Name	Tag Description
	<ul style="list-style-type: none"> Failure
holdRequestId	Displays the hold request ID.
holdReleaseReason	Indicates the reason which was specified when the hold request was released.
holdComments	Displays additional information about the hold request.
errormsg	Indicates the error that occurred while creating the hold request.
	Note: This tag appears when the value in the requestProcessStatus tag is set to Failure .
holdEndDate	Displays the date till when the hold request was effective.
holdStatus	Indicates the current status of the hold request.

Related Topics

For more information on...	See...
Sample Hold Request Release Request and Response in the JSON Format	Sample Hold Request View Request and Response in the JSON Format on page 3129

Sample Hold Request Release Request and Response in the XML Format

Using the below example, you can release a hold request with an **Active** status for the **22559977334488** hold request ID.

Sample Hold Request Release Request in the XML Format

```
<C1-ReleaseHoldRequest>
  <sourceSystem>SRC_AMER_PRIME</sourceSystem>
  <externalTransactionId>ETI44</externalTransactionId>
  <externalSourceId>ESI77</externalSourceId>
  <holdRequestId>22559977334488</holdRequestId>
  <holdReleaseReason>TROPICAL_CYCLONE</holdReleaseReason>
  <holdComments>CYCLONE PHENOMENON WAS SEEN</holdComments>
</C1-ReleaseHoldRequest>
```

Sample Hold Request Release Response in the XML Format

The following information is received as response when the hold request is processed successfully.

```
<C1-ReleaseHoldRequest>
  <requestProcessStatus>SUCCESS</requestProcessStatus>
  <sourceSystem>SRC_AMER_PRIME</sourceSystem>
  <externalTransactionId>ETI44</externalTransactionId>
  <externalSourceId>ESI77</externalSourceId>
  <holdRequestId>22559977334488</holdRequestId>
  <holdReleaseReason>TROPICAL_CYCLONE</holdReleaseReason>
  <holdComments>CYCLONE PHENOMENON WAS SEEN</holdComments>
  <holdEndDate>2022-31-01</holdEndDate>
  <holdRequestStatus>RELEASE</holdRequestStatus>
  <errormsg></errormsg>
</C1-ReleaseHoldRequest>
```

The following information is received from the hold request when the hold request ID passed in the release request is invalid.

```
<C1-ReleaseHoldRequest>
  <requestProcessStatus>FAILURE</requestProcessStatus>
```

```

<sourceSystem>SRC_AMER_PRIME</sourceSystem>
<externalTransactionId>ETI44</externalTransactionId>
<externalSourceId>ESI77</externalSourceId>
<holdRequestId>790420762397</holdRequestId>
<holdReleaseReason>TROPICAL_CYCLONE</holdReleaseReason>
<holdComments>CYCLONE PHENOMENON WAS SEEN</holdComments>
<holdEndDate></holdEndDate>
<holdRequestStatus></holdRequestStatus>
<errmsg>The hold request ID 790420762397 is invalid</errmsg>
</Cl-ReleaseHoldRequest>

```

Note: We have given the above request and response samples to illustrate how the tags should be nested while sending a hold release request from the external system. However, you should not seamlessly use this request sample in your environment because the required pre-requisite data may not be available in your environment. In such case, the system will give erroneous results.

Related Topics

For more information on...	See...
Hold Request Release Request and Response - Tags in XML Format	Hold Request Release Request and Response - Tags in XML Format on page 3133

Sample Hold Request Release Request and Response in the JSON Format

Using the below example, you can release a hold request with an **Active** status for the **44776611339988** hold request ID.

Sample Hold Request View Request in the JSON Format

```

{
  "Cl-ReleaseHoldRequest": {
    "sourceSystem": "SRC_PANAMER_PRIME"
    "externalTransactionId": "ETI01"
    "externalSourceId": "ESI05"
    "holdRequestId": "44776611339988"
    "holdReleaseReason": "FLOODS"
    "holdComments": "HEAVY FLOODS IN DOWNTOWN"
  }
}

```

Sample Hold Request Release Response in the JSON Format

```

{
  "Cl-ReleaseHoldRequest": {
    "requestProcessStatus": "SUCCESS"
    "sourceSystem": "SRC_PANAMER_PRIME"
    "externalTransactionId": "ETI01"
    "externalSourceId": "ESI05"
    "holdRequestId": "44776611339988"
    "holdReleaseReason": "FLOODS"
    "holdComments": "HEAVY FLOODS IN DOWNTOWN"
    "holdEndDate": "2022-02-28"
    "holdRequestStatus": "RELEASE"
    "errmsg": ""
  }
}

```

The following information is received from the hold request when the hold request ID passed in the release request is invalid.

```
{
```

```

"C1-ReleaseHoldRequest" :
{
  "requestProcessStatus": "FAILURE"
  "sourceSystem": "SRC_PANAMER_PRIME"
  "externalTransactionId": "ETI01"
  "externalSourceId": "ESI05"
  "holdRequestId": "55772211339988"
  "holdReleaseReason": "FLOODS"
  "holdComments": "HEAVY FLOODS IN DOWNTOWN"
  "holdEndDate": ""
  "holdRequestStatus": ""
  "errorMsg": "The hold request ID 55772211339988 is invalid"
}
}

```

Note: We have given the above request and response samples to illustrate how the attribute value pairs should be structured while sending a hold release request from the external system. However, you should not seamlessly use this request sample in your environment because the required pre-requisite data may not be available in your environment. In such case, the system will give erroneous results.

Related Topics

For more information on...	See...
Hold Request Release Request and Response - Attribute/Value Pairs in JSON Format	Hold Request Release Request and Response - Tags in JSON Format on page 3135

C1-UpdateHoldRequest Business Service

The **Update Hold Request (C1-UpdateHoldRequest)** business service enables you to edit an active hold request. You can call this business service from an external system through an inbound web service. If you want to send the hold request update request in the XML and/or JSON format, you need to ensure that you create a REST based inbound web service in Oracle Revenue Management and Billing. However, if you want to send the hold request update request in the XML format, you can create a SOAP or REST based inbound web service in Oracle Revenue Management and Billing.

While sending the hold request update request, you need to specify the following details:

- Hold request ID
- Hold entity ID (i.e. person ID, account ID, or bill ID)

Through this service, you can edit the following details of an active hold request:

- End date, comments, and characteristics of a hold request
- End date of a single hold entity in a hold request
- End date of multiple hold processes in a hold request

Once the hold request is edited through the service, the hold request ID is sent in the response. The system enables you to track the hold request release response sent to the external system using the Inbound Web Service History feature. For more information, see [Inbound Web Service History](#)

Related Topics

For more information on...	See...
Hold Request Update Request in the XML Format	Hold Request Update Request in the XML Format on page 3140

For more information on...	See...
Hold Request Update Response in the XML Format	Hold Request Update Response in the XML Format on page 3141
Hold Request Update Request in the JSON Format	Hold Request Update Request in the JSON Format on page 3145
Hold Request Update Response in the JSON Format	Hold Request Release Response in the JSON Format on page 3135
Hold Request Update Request and Response - Tags in XML Format	Hold Request Update Request and Response - Tags in XML Format on page 3141
Hold Request Update Request and Response - Attribute/Value Pairs in JSON Format	Hold Request Update Request and Response - Tags in JSON Format on page 3146
Sample Hold Update Release Request and Response in the XML Format	Sample Hold Request Update Request and Response in the XML Format on page 3149
Sample Hold Update Release Request and Response in the JSON Format	Sample Hold Request Update Request and Response in the JSON Format on page 3151

Hold Request Update Request in the XML Format

The following code snippet illustrates how the tags should be nested while receiving the hold request update request in the XML format:

```
<C1-UpdateHoldRequest>
  <sourceSystem></sourceSystem>
  <externalTransactionId></externalTransactionId>
  <externalSourceId></externalSourceId>
  <holdRequestId></holdRequestId>
  <holdComments></holdComments>
  <holdEndDate></holdEndDate>
  <entityId></entityId>
  <entityEndDate></entityEndDate>
  <holdProcessData>
    <holdProcess></holdProcess>
    <holdProcessEndDate></holdProcessEndDate>
  </holdProcessData>
  <characteristics>
    <action></action>
    <characteristicType></characteristicType>
    <characteristicValue></characteristicValue>
    <effectiveDate></effectiveDate>
  </characteristics>
</C1-UpdateHoldRequest>
```

Related Topics

For more information on...	See...
Hold Request Update Response in the XML Format	Hold Request Update Response in the XML Format on page 3141
Hold Request Update Request and Response - Tags in XML Format	Hold Request Update Request and Response - Tags in XML Format on page 3141

For more information on...	See...
Sample Hold Request Update Request and Response in the XML Format	Sample Hold Request Update Request and Response in the XML Format on page 3149

Hold Request Update Response in the XML Format

The following code snippet illustrates how the tags should be nested while sending the hold request update request in the XML format:

```
<C1-UpdateHoldRequest>
  <requestProcessStatus></requestProcessStatus>
  <sourceSystem></sourceSystem>
  <externalTransactionId></externalTransactionId>
  <externalSourceId></externalSourceId>
  <holdRequestId></holdRequestId>
  <holdComments></holdComments>
  <holdEndDate></holdEndDate>
  <entityId></entityId>
  <entityEndDate></entityEndDate>
  <holdProcessData>
    <holdProcess></holdProcess>
    <holdProcessEndDate></holdProcessEndDate>
  </holdProcessData>
  <characteristics>
    <action></action>
    <characteristicType></characteristicType>
    <characteristicValue></characteristicValue>
    <effectiveDate></effectiveDate>
  </characteristics>
  </errormsg><errormsg>
</C1-UpdateHoldRequest>
```

Related Topics

For more information on...	See...
Hold Request Update Request in the XML Format	Hold Request Update Request in the XML Format on page 3140
Hold Request Update Request and Response - Tags in XML Format	Hold Request Update Request and Response - Tags in XML Format on page 3141
Sample Hold Request Update Request and Response in the XML Format	Sample Hold Request Update Request and Response in the XML Format on page 3149

Hold Request Update Request and Response - Tags in XML Format

Note: We recommend you to refer the [Hold Request Update Request in the XML Format](#) on page 3140 and [Hold Request Update Response in the XML Format](#) on page 3141 topics in parallel while understanding the below mentioned tags. This will help you to understand how the tags are nested in the XML format.

Before calling the **C1-UpdateHoldRequest** business service through an inbound web service, you need to ensure that the hold request update request contains the following tags:

Tag Name	Tag Description	Mandatory (Yes or No)
C1-UpdateHoldRequest	Used to indicate that you want to invoke the C1-UpdateHoldRequest business service.	Yes
sourceSystem	Used to indicate the external system from which the hold update request is received. Note: You must specify an external system which is already defined in the system. The external system is used when the Inbound Web Service History feature is enabled. The specified external system should match the external system which is associated with the outbound message type specified in the C1-IWSHIST algorithm. If the external system is not specified in the hold request update request, the system, by default, stamps the external system associated with the outbound message type (specified in the C1-IWSHIST algorithm) corresponding to the record in the C1_IWS_HIST table. For more information, see Inbound Web Service History .	No
externalTransactionId	Used to indicate the transaction in the external system through which the hold request update request is sent. Note: The external transaction ID is used when the Inbound Web Service History feature is enabled.	No
externalSourceId	Used to specify the external source system ID. Note: The external source system ID is used when the Inbound Web Service History feature is enabled.	No
holdRequestId	Used to specify the hold request ID of the hold request for which the hold request update request is sent. Note: You must specify the hold request ID which is already defined in the system.	Yes
holdComments	Used to specify additional information about the hold request.	No
holdEndDate	Used to specify the date till when the hold request is effective. Note: The hold request end date must be either derived or provided by the upstream system before creating a hold request in an Active status. The hold request end date cannot be earlier than the hold process end date.	No
entityId	Used to specify a list of entities for which you want to create a hold request.	No

Tag Name	Tag Description	Mandatory (Yes or No)
	<p>Note: You need to specify the entity ID when the hold entity is BILL.</p>	
entityEndDate	<p>Used to specify the date till when the entity is effective for hold request.</p> <p>Note:</p> <p>The entity end date cannot be later than the hold end date and earlier than the hold process end date.</p> <p>The entity end date cannot be later than the system date.</p> <p>At present, you can only update the end date of a single entity specified in the hold request update request. If there are two or more entities on hold, you need to initiate a separate hold request update request for each entity in order to update its respective end date.</p>	No
holdProcessData	Used to specify the details of the hold process.	No
holdProcess	<p>Used to specify the process that you want to keep on hold in the hold request. The valid values are:</p> <ul style="list-style-type: none"> • ATPY - Used when you want to specify the auto pay process. • BILL - Used when you want to specify the bill generation process. • FNDG - Used when you want to specify the funding process. • OVDU - Used when you want to specify the overdue process. <p>Note: You must specify a value which is already defined in the HOLD_PROCESS_FLG lookup field. It must be in the Active status.</p>	<p>Yes (Conditional)</p> <p>Note: This data is required while updating the hold request information.</p>
holdProcessEndDate	<p>Used to specify the date till when the entity is effective for hold request.</p> <p>Note:</p> <p>The hold process end date cannot be later than the hold end date.</p> <p>At present, you can only update the end date of a single process specified in the hold request update request. If there are two or more processes on hold, you need to initiate a separate hold request update request for each process in order to update its respective end date.</p>	No
characteristics	Used to specify a characteristic for the hold request.	Yes (Conditional)

Tag Name	Tag Description	Mandatory (Yes or No)
		Note: This data is required while updating the hold request information.
action	Used to specify the action to be performed on the characteristic. The valid values are: <ul style="list-style-type: none"> • Update • Delete 	Yes (Conditional) Note: This data is required while updating the hold request information.
characteristicType	Used to indicate the characteristic type. Note: You must specify a characteristic type where the characteristic entity is set to Hold Request and which is associated with the hold request type.	Yes (Conditional) Note: This data is required while updating the hold request information.
characteristicValue	Used to specify the value for the characteristic type. Note: You must specify a characteristic value which is associated with the characteristic type and is present in the system.	Yes (Conditional) Note: This data is required while updating the hold request information.
effectiveDate	Used to specify the date from when the characteristic is effective.	Yes (Conditional) Note: This data is required while updating the hold request information.

The following table lists and describes the tags which appear in the hold request view response in the XML format:

Tag Name	Tag Description
requestProcessStatus	Indicates whether the hold request update request is successfully processed or not. The valid values are: <ul style="list-style-type: none"> • Success • Failure
holdRequestId	Displays the hold request ID.
errormsg	Indicates the error that occurred while updating the hold request. Note: This tag appears when the value in the requestProcessStatus tag is set to Failure .

Related Topics

For more information on...	See...
Sample Hold Request Update Response in the XML Format	Sample Hold Request Update Request and Response in the XML Format on page 3149

Hold Request Update Request in the JSON Format

The following code snippet illustrates how the tags should be nested while receiving the hold request update request in the JSON format:

```
{
  "C1-UpdateHoldRequest": {
    "sourceSystem": ""
    "externalTransactionId": ""
    "externalSourceId": ""
    "holdRequestId": ""
    "holdComments": ""
    "holdEndDate": ""
    "entityId": ""
    "entityEndDate": ""
    "holdProcessData": {
      "holdProcess": ""
      "holdProcessEndDate": ""
    }
    "characteristics": {
      "action": ""
      "characteristicType": ""
      "characteristicValue": ""
      "effectiveDate": ""
    }
  }
}
```

Related Topics

For more information on...	See...
Hold Request Update Response in the JSON Format	Hold Request Update Response in the JSON Format on page 3145
Hold Request Update Request and Response - Tags in JSON Format	Hold Request Update Request and Response - Tags in JSON Format on page 3146
Sample Hold Request Update Request and Response in the JSON Format	Sample Hold Request Update Request and Response in the JSON Format on page 3151

Hold Request Update Response in the JSON Format

The following code snippet illustrates how the tags should be nested while sending the hold request update request in the XML format:

```
{
  "C1-UpdateHoldRequest": {
    "requestProcessStatus": ""
  }
}
```

```

    "sourceSystem": ""
    "externalTransactionId": ""
    "externalSourceId": ""
    "holdRequestId": ""
    "holdComments": ""
    "holdEndDate": ""
    "entityId": ""
    "entityEndDate": ""
    "holdProcessData":
    {
        "holdProcess": ""
        "holdProcessEndDate": ""
    }
    "characteristics":
    {
        "action": ""
        "characteristicType": ""
        "characteristicValue": ""
        "effectiveDate": ""
    }
    "errmsg": ""
}

```

Related Topics

For more information on...	See...
Hold Request Update Request in the JSON Format	Hold Request Update Request in the JSON Format on page 3145
Hold Request Update Request and Response - Tags in JSON Format	Hold Request Update Request and Response - Tags in JSON Format on page 3146
Sample Hold Request Update Request and Response in the JSON Format	Sample Hold Request View Request and Response in the JSON Format on page 3129

Hold Request Update Request and Response - Tags in JSON Format

Note: We recommend you to refer the [Hold Request Update Request in the JSON Format](#) on page 3145 and [Hold Request Update Response in the JSON Format](#) on page 3145 topics in parallel while understanding the below mentioned tags. This will help you to understand how the tags are nested in the XML format.

Before calling the **C1-ReleaseHoldRequest** business service through an inbound web service, you need to ensure that the hold request update request contains the following tags:

Tag Name	Tag Description	Mandatory (Yes or No)
C1-UpdateHoldRequest	Used to indicate that you want to invoke the C1-UpdateHoldRequest business service.	Yes
sourceSystem	Used to indicate the external system from which the hold update request is received.	No

Tag Name	Tag Description	Mandatory (Yes or No)
	<p>Note:</p> <p>You must specify an external system which is already defined in the system.</p> <p>The external system is used when the Inbound Web Service History feature is enabled. The specified external system should match the external system which is associated with the outbound message type specified in the C1-IWSHIST algorithm. If the external system is not specified in the hold request update request, the system, by default, stamps the external system associated with the outbound message type (specified in the C1-IWSHIST algorithm) corresponding to the record in the C1_IWS_HIST table. For more information, see <i>Inbound Web Service History</i>.</p>	
externalTransactionId	<p>Used to indicate the transaction in the external system through which the hold request update request is sent.</p> <p>Note: The external transaction ID is used when the Inbound Web Service History feature is enabled.</p>	No
externalSourceId	<p>Used to specify the external source system ID.</p> <p>Note: The external source system ID is used when the Inbound Web Service History feature is enabled.</p>	No
holdRequestId	<p>Used to specify the hold request ID of the hold request for which the hold request update request is sent.</p> <p>Note: You must specify the hold request ID which is already defined in the system.</p>	Yes
holdComments	Used to specify additional information about the hold request.	No
holdEndDate	<p>Used to specify the date till when the hold request is effective.</p> <p>Note:</p> <p>The hold request end date must be either derived or provided by the upstream system before creating a hold request in an Active status.</p> <p>The hold request end date cannot be earlier than the hold process end date.</p>	No
entityId	<p>Used to specify a list of entities for which you want to create a hold request.</p> <p>Note: You need to specify the entity ID when the hold entity is BILL.</p>	No
entityEndDate	Used to specify the date till when the entity is effective for hold request.	No

Tag Name	Tag Description	Mandatory (Yes or No)
	<p>Note:</p> <p>The entity end date cannot be later than the hold end date and earlier than the hold process end date.</p> <p>The entity end date cannot be later than the system date.</p> <p>At present, you can only update the end date of a single entity specified in the hold request update request. If there are two or more entities on hold, you need to initiate a separate hold request update request for each entity in order to update its respective end date.</p>	
holdProcessData	Used to specify the details of the hold process.	No
holdProcess	<p>Used to specify the process that you want to keep on hold in the hold request. The valid values are:</p> <ul style="list-style-type: none"> • ATPY - Used when you want to specify the auto pay process. • BILL - Used when you want to specify the bill generation process. • FNDG - Used when you want to specify the funding process. • OVDU - Used when you want to specify the overdue process. <p>Note: You must specify a value which is already defined in the HOLD_PROCESS_FLG lookup field. It must be in the Active status.</p>	<p>Yes (Conditional)</p> <p>Note: This data is required while updating the hold request information.</p>
holdProcessEndDate	<p>Used to specify the date till when the entity is effective for hold request.</p> <p>Note:</p> <p>The hold process end date cannot be later than the hold end date.</p> <p>At present, you can only update the end date of a single process specified in the hold request update request. If there are two or more processes on hold, you need to initiate a separate hold request update request for each process in order to update its respective end date.</p>	<p>Yes (Conditional)</p> <p>Note: This data is required while updating the hold request information.</p>
characteristics	Used to specify a characteristic for the hold request.	<p>Yes (Conditional)</p> <p>Note: This data is required while updating the hold request information.</p>
action	<p>Used to specify the action to be performed on the characteristic. The valid values are:</p> <ul style="list-style-type: none"> • Update 	Yes (Conditional)

Tag Name	Tag Description	Mandatory (Yes or No)
	<ul style="list-style-type: none"> Delete 	Note: This data is required while updating the hold request information.
characteristicType	Used to indicate the characteristic type.	Yes (Conditional)
	Note: You must specify a characteristic type where the characteristic entity is set to Hold Request and which is associated with the hold request type.	Note: This data is required while updating the hold request information.
characteristicValue	Used to specify the value for the characteristic type.	Yes (Conditional)
	Note: You must specify a characteristic value which is associated with the characteristic type and is present in the system.	Note: This data is required while updating the hold request information.
effectiveDate	Used to specify the date from when the characteristic is effective.	Yes (Conditional)
		Note: This data is required while updating the hold request information.

The following table lists and describes the tags which appear in the hold request view response in the XML format:

Tag Name	Tag Description
requestProcessStatus	Indicates whether the hold request update request is successfully processed or not. The valid values are: <ul style="list-style-type: none"> Success Failure
holdRequestId	Displays the hold request ID.
errorMsg	Indicates the error that occurred while updating the hold request.
	Note: This tag appears when the value in the requestProcessStatus tag is set to Failure .

Related Topics

For more information on...	See...
Sample Hold Request Update Request and Response in the JSON Format	Sample Hold Request Update Request and Response in the JSON Format on page 3151

Sample Hold Request Update Request and Response in the XML Format

Using the below example, you can update all the fields in an active hold request where the hold request ID is **10000252262623**

Sample Hold Request Update Request in the XML Format

```

<C1-UpdateHoldRequest>
  <sourceSystem>SMALL_NSC_PRIME</sourceSystem>
  <externalTransactionId>ETI22</externalTransactionId>
  <externalSourceId>ESI99</externalSourceId>
  <holdRequestId>10000252262623</holdRequestId>
  <holdComments>Update the fields based on the request ID</holdComments>
  <holdEndDate>2022-01-31</holdEndDate>
  <entityId>0122334455</entityId>
  <entityEndDate>2022-01-25</entityEndDate>
  <holdProcessData>
    <holdProcess>BILL</holdProcess>
    <holdProcessEndDate>2022-01-23</holdProcessEndDate>
  </holdProcessData>
  <holdProcessData>
    <holdProcess>FNDG</holdProcess>
    <holdProcessEndDate>2022-01-23</holdProcessEndDate>
  </holdProcessData>
  <characteristics>
    <action>Update</action>
    <characteristicType>INVOICE_TYPE</characteristicType>
    <characteristicValue>CMR</characteristicValue>
    <effectiveDate>2022-01-01</effectiveDate>
  </characteristics>
  <characteristics>
    <action>DELETE</action>
    <characteristicType>INVOICE_HOLD_REASON</characteristicType>
    <characteristicValue>CMDP</characteristicValue>
    <effectiveDate>2022-01-01</effectiveDate>
  </characteristics>
</C1-ReleaseHoldRequest>

```

Sample Hold Request Update Response in the XML Format

The following information is received as response when the hold request update request is processed successfully.

```

<C1-UpdateHoldRequest>
  <requestProcessStatus>Success</requestProcessStatus>
  <sourceSystem>SMALL_NSC_PRIME</sourceSystem>
  <externalTransactionId>ETI22</externalTransactionId>
  <externalSourceId>ESI99</externalSourceId>
  <holdRequestId>10000252262623</holdRequestId>
  <holdComments>Update the fields based on the request ID</holdComments>
  <holdEndDate>2022-01-31</holdEndDate>
  <entityId>0122334455</entityId>
  <entityEndDate>2022-01-25</entityEndDate>
  <holdProcessData>
    <holdProcess>BILL</holdProcess>
    <holdProcessEndDate>2022-01-23</holdProcessEndDate>
  </holdProcessData>
  <holdProcessData>
    <holdProcess>FNDG</holdProcess>
    <holdProcessEndDate>2022-01-23</holdProcessEndDate>
  </holdProcessData>
  <characteristics>
    <action>UPDATE</action>
    <characteristicType>INVOICE_TYPE</characteristicType>
    <characteristicValue>CMR</characteristicValue>
    <effectiveDate>2022-01-01</effectiveDate>
  </characteristics>
</C1-UpdateHoldRequest>

```

The following information is received from the hold request when the hold request is not longer present in the **Active** status.

```
<C1-UpdateHoldRequest>
  <requestProcessStatus>Failure</requestProcessStatus>
  <sourceSystem>SMALL_NSC_PRIME</sourceSystem>
  <externalTransactionId>ETI22</externalTransactionId>
  <externalSourceId>ESI99</externalSourceId>
  <holdRequestId>10101252262623</holdRequestId>
  <holdComments>Update the fields based on the request ID</holdComments>
  <holdEndDate>2022-01-31</holdEndDate>
  <entityId>1133224455</entityId>
  <entityEndDate>2022-01-25</entityEndDate>
  <holdProcessData>
    <holdProcess>BILL</holdProcess>
    <holdProcessEndDate>2022-01-23</holdProcessEndDate>
  </holdProcessData>
  <holdProcessData>
    <holdProcess>FNDG</holdProcess>
    <holdProcessEndDate>2022-01-23</holdProcessEndDate>
  </holdProcessData>
  <characteristics>
    <action>UPDATE</action>
    <characteristicType>STATE_OF_ISSUE</characteristicType>
    <characteristicValue>TX</characteristicValue>
    <effectiveDate>2022-01-01</effectiveDate>
  </characteristics>
  <errmsg>The hold request is not in the active status.</errmsg>
</C1-UpdateHoldRequest>
```

Note: We have given the above request and response samples to illustrate how the tags should be nested while sending a hold update request from the external system. However, you should not seamlessly use this request sample in your environment because the required pre-requisite data may not be available in your environment. In such case, the system will give erroneous results.

Related Topics

For more information on...	See...
Hold Request Update Request and Response - Tags in XML Format	Hold Request Update Request and Response - Tags in XML Format on page 3141

Sample Hold Request Update Request and Response in the JSON Format

Using the below example, you can update all the fields in an active hold request where the hold request ID is **10000252262623**

Sample Hold Request View Request in the JSON Format

```
{
  "UpdateHoldRequest": {
    "sourceSystem": "SMALL_NSC_PRIME",
    "externalTransactionId": "ETI22",
    "externalSourceId": "ESI99",
    "holdRequestId": "10000252262623",
    "holdComments": "Update the fields based on the request ID",
    "holdEndDate": "2022-01-31",
    "entityId": "0122334455",
    "entityEndDate": "2022-01-25",
    "holdProcessData": {

```

```

        "holdProcess": "BILL",
        "holdProcessEndDate": "2022-01-23"
    }
    "holdProcessData":
    {
        "holdProcess": "FNDG",
        "holdProcessEndDate": "2022-01-23"
    },
    "characteristics":
    {
        "action": "Update",
        "characteristicType": "INVOICE_TYPE",
        "characteristicValue": "CMR",
        "effectiveDate": "2022-01-01"
    },
    "characteristics":
    {
        "action": "Delete",
        "characteristicType": "INVOICE_HOLD_REASON",
        "characteristicValue": "CMDP",
        "effectiveDate": "2022-01-01"
    },
    },
}

```

Sample Hold Request Update Response in the XML Format

The following information is received as response when the hold request update request is processed successfully.

```

{
  "UpdateHoldRequest":
  {
    "requestProcessStatus": "Success",
    "sourceSystem": "SMALL_NSC_PRIME",
    "externalTransactionId": "ETI22",
    "externalSourceId": "ESI99",
    "holdRequestId": "10000252262623",
    "holdComments": "Update the fields based on the request ID",
    "holdEndDate": "2022-01-31",
    "entityId": "0122334455",
    "entityEndDate": "2022-01-25",
    "holdProcessData":
    {
      "holdProcess": "BILL",
      "holdProcessEndDate": "2022-01-23"
    }
    "holdProcessData":
    {
      "holdProcess": "FNDG",
      "holdProcessEndDate": "2022-01-23"
    },
    "characteristics":
    {
      "action": "Update",
      "characteristicType": "INVOICE_TYPE",
      "characteristicValue": "CMR",
      "effectiveDate": "2022-01-01"
    },
  },
}

```

The following information is received from the hold request when the hold request is not longer present in the **Active** status.

```

{

```

```

"UpdateHoldRequest" :
{
  "requestProcessStatus": "Failure"
  "sourceSystem": "SMALL_NSC_PRIME",
  "externalTransactionId": "ETI22",
  "externalSourceId": "ESI99",
  "holdRequestId": "10101252262623",
  "holdComments": "Update the fields based on the request ID",
  "holdEndDate": "2022-01-31",
  "entityId": "1133224455",
  "entityEndDate": "2022-01-25",
  "holdProcessData":
  {
    "holdProcess": "ATPY",
    "holdProcessEndDate": "2022-01-25"
  }
  "characteristics":
  {
    "action": "Update",
    "characteristicType": "STATE_OF_ISSUE",
    "characteristicValue": "TX",
    "effectiveDate": "2022-01-01"
  },
  "errmsg": "The hold request is not in the active status."
}
}

```

Note: We have given the above request and response samples to illustrate how the attribute value pairs should be structured while sending a hold update request from the external system. However, you should not seamlessly use this request sample in your environment because the required pre-requisite data may not be available in your environment. In such case, the system will give erroneous results.

Related Topics

For more information on...	See...
Hold Request Update Request and Response - Attribute/Value Pairs in JSON Format	Hold Request Update Request and Response - Tags in JSON Format on page 3146

Chapter 45

Hold Direct Debit Instruction

Topics:

- [Prerequisites](#)
- [Algorithms Used in C1-AutoPayRequest](#)
- [Auto Pay Request Status Transition without Approval](#)
- [Auto Pay Request Status Transition with Approval](#)
- [Auto Pay Request Type](#)
- [Auto Pay Request \(Used for Searching\)](#)
- [Auto Pay Request \(Used for Viewing\)](#)

In the financial services and health insurance domains, there might be scenarios wherein the customers would like to review their invoices before the charges are directly debited from their accounts. In such scenarios, there is a need to hold a direct debit (i.e. automatic payment) for a bill until the confirmation is received from the customer.

Oracle Revenue Management and Billing provides the ability to hold a direct debit (i.e. automatic payment) for a bill until the confirmation is received from the customer. A new field named **Auto Pay Review Required** is added in the **Auto Pay** tab of the **Account** screen. On completing a bill for an account, the system creates the automatic payment records in the **CI_BILL_ACH** table as per the auto pay instructions defined for the account. If the **Auto Pay Review Required** option is selected, the system sets the **EXTRACT_ELIG_SW** column corresponding to the automatic payment records in the **CI_BILL_ACH** table to **N**. However, if the **Auto Pay Review Required** option is not selected, the system sets the **EXTRACT_ELIG_SW** column corresponding to the automatic payment records in the **CI_BILL_ACH** table to **Y**. The **EXTRACT_ELIG_SW** column indicates whether the automatic payment record is eligible for the extraction. If the **EXTRACT_ELIG_SW** column is set to **N**, the **APAYCRET** batch does not consider the automatic payment record in the **CI_BILL_ACH** table for automatic payment creation.

Once the confirmation is received for one or more bills, the system enables you to create an automatic payment request for the bills. While creating an automatic payment request, you need to specify an automatic payment request type using which you want to create the automatic payment request. It is the automatic payment request type which helps the system to determine:

- The business object using which the automatic payment request should be created in the system
- Whether the approval is required for the automatic payment request

Once you specify the automatic payment request type, the system creates the automatic payment request in the **Draft** status. You can then include the bills for which invoice confirmation is received from the customers in the automatic payment request. At least one bill should be included in the automatic payment request. Before submitting an automatic payment request, you need to do the following:

- Edit the Schedule Extract Date (if required) of each bill
- Set the **Eligible for Extraction** field of each bill to **Y**

You can also delete a bill from an automatic payment request when it is in the **Draft** status. Once you edit the required details of the bills in an automatic payment request, you can submit the automatic payment request. If the approval

process is not configured in the respective automatic payment request type, the system does the following:

- Updates the **ELIG_EXTRACT_SW** and **APAY_CRE_DT** columns corresponding to the automatic payment records in the **CI_BILL_ACH** table
- Changes the status of the automatic payment request to **Processed**

If the approval process is configured in the respective automatic payment request type, the system changes the status of the automatic payment request to **Approval In Progress**. A To Do notification is created for the approver using the approval To Do type (specified in the respective automatic payment request type) and assigned to the users with the approval To Do role (specified in the respective automatic payment request type). Once the approver reviews an automatic payment request, the approver can approve, reject, or resubmit the automatic payment request based on the observations. If the approver approves the automatic payment request, the system does the following:

- Updates the **ELIG_EXTRACT_SW** and **APAY_CRE_DT** columns corresponding to the automatic payment records in the **CI_BILL_ACH** table
- Changes the status of the automatic payment request to **Processed**

If the approver rejects an automatic payment request, the status of the automatic payment request is changed to **Rejected**. However, if the approver requests the submitter to resubmit an automatic payment request, the status of the automatic payment request is changed to **Draft**. A To Do notification is created for the submitter using the submitter To Do type (specified in the respective automatic payment request type) and assigned to the users with the submitter To Do role (specified in the respective automatic payment request type). While rejecting or resubmitting an automatic payment request, the approver needs to specify the reason for rejection or resubmission.

To implement the hold direct debit feature, the following new screens are introduced in this release:

- **Auto Pay Request Type** - Enables you to create, edit, delete, and copy an automatic payment request type.
- **Auto Pay Request (Used for Searching)** - Enables you to search for an automatic payment request. It also enables you to create an automatic payment request.
- **Auto Pay Request (Used for Viewing)** - Enables you to edit, delete, submit, approve, reject, and resubmit the automatic payment request. It also enables you to add, edit, and delete bills from the automatic payment request.

In addition, the following changes are made to the system:

- **Auto Pay Review Required** - This field is added in the **Auto Pay** tab of the **Account** screen. It indicates whether you want to hold direct debit (i.e. automatic payment) for the bills of the account until the confirmation is received from the customer.
- **Eligible for Extraction** - This column is added in the **Auto Pay** tab of the **Bill** screen. It indicates whether the automatic payment record for the bill is eligible for extraction.

Prerequisites

To setup the auto pay request feature, you need to do the following:

- Auto pay request type business object defined in the application
- Auto pay request types defined in the system.
- Approval To Do types and To Do roles defined in the application
- Submitter To Do types and To Do roles defined in the application
- Characteristic types defined in the application

Algorithms Used in C1-AutoPayRequest

The following table lists the algorithm which is attached to the **C1-AutoPayRequest** business object:

System Event	Algorithm	Algorithm Type	Description
Information	C1-APAYRQINF	C1-APAYRQINF	Refer to C1-APAYRQINF on page 3157

The following table lists the algorithms which are used in the lifecycle of the **C1-AutoPayRequest** business object:

Status	System Event	Algorithm	Algorithm Type	Description
Draft	Exit	F1-TODOCOMPL	F1-TODOCOMPL	Refer to F1-TODOCOMPL on page 1453
Submitted	Enter	C1-APAYSUB	C1-APAYSUB	Refer to C1-APAYSUB on page 3158
Approval In Progress	Enter	C1-APAYAPP	C1-APAYAPP	Refer to C1-APAYAPP on page 3158
	Exit	F1-TODOCOMPL	F1-TODOCOMPL	Refer to F1-TODOCOMPL on page 1453
Update Auto Pay Record	Enter	C1-UPDAPAY	C1-UPDAPAY	Refer to C1-UPDAPAY on page 3158
Approved	Enter	C1-APAYAPRVD	C1-APAYAPRVD	Refer to C1-APAYAPRVD on page 3158
Return to Submitter	Enter	C1-APAYRESUB	C1-APAYRESUB	Refer to C1-APAYRESUB on page 3159
Processed	-	-	-	-
Rejected	-	-	-	-

C1-APAYRQINF

The **C1-APAYRQINF** algorithm generates the auto pay request information string and is plugged in at **System Event**:

Information of business object: **C1-AutoPayRequest**.

It concatenates the following fields:

- Auto Pay Request Type Description
- Auto Pay Request Status Description
- Auto Pay Request ID

F1-TODOCOMPL

This algorithm type completes the To Do entries that are linked to an object when the object exits the given status.

It finds and completes all open To Do entries where the business object's primary key is defined as a drill key. However, if the **Exclude To Do Entries From Auto Completion** characteristic is set to **Y** for the business object, the system does not automatically complete the respective To Do entry.

C1-APAYSUB

The **C1-APAYSUB** algorithm will be plugged at the **“Enter” System event** of the business object (**C1-AutoPayRequest**) life cycle status: **SUBMITTED**.

This algorithm checks the following:

1. Whether the approval is required for the auto pay request based on the configuration in auto pay request type (**IS_APPR_REQ = Y**).
 - a. If the approval is required for the auto pay request, the status of the auto pay request is changed to **Approval In Progress**.
 - b. If the approval is not required for the auto pay request, the status of the auto pay request is changed to **UPDATEAPAY**.
2. At least one auto pay record is selected in the auto pay request.
3. Updated scheduled extraction date cannot be less than system date.
4. **Auto Pay Request** cannot be created for any auto pay record if the same auto pay record is selected in another request which is in the **Approval In Progress** status.

C1-APAYAPP

The **C1-APAYAPP** algorithm creates the following:

1. A To Do using the To Do type specified in the approval profile which is attached to the **Auto Pay Request Type**. The To Do is sent to the appropriate users in the approval hierarchy depending on whether hierarchical approval is required or not.
2. A log entry is added when a To Do is created using the To Do type. It will create To Do Entry when **Auto Pay Request** enters in the **Approval in Progress** status from **Submit** status.

C1-UPDAPAY

The **C1-UPDAPAY** algorithm will be plugged in at **“Enter” System event** of the business object (**C1-AutoPayRequest**) life cycle status: **UPDATEAPAY**.

1. The **Extract Eligible Switch** and **Auto Pay Creation Date** are updated in the **CI_BILL_ACH** table with the latest values present in **Auto Pay Request Details** table. The auto pay request status is then changed to **PROCESSED**.
2. If the bill which is present in the **Auto Pay Request** is cancelled then the latest details of **Extract Eligible Switch** and **Auto Pay Creation Date** are not updated in the **CI_BILL_ACH** table and the auto pay request status is changed to **PROCESSED**.

C1-APAYAPRVD

The **C1-APAYAPRVD** algorithm is the **Enter** status algorithm. This algorithm is invoked when you approve an **Auto Pay Request**. It confirms whether the approval flag is true and the status of the **Auto Pay request** is **APPROVED** to transit it to the next level.

C1-APAYRESUB

The **C1-APAYRESUB** algorithm is invoked on the **Re-Submit** button. It moves the status of the **Auto Pay Request** to **Draft**.

A To Do is generated for the user as submitter whose To Do type and To Do role are fetched from the **Auto Pay Request Type**. This algorithm creates the To Do entry when the **Auto Pay Request** enters into the **Return to Submitter** status from the **Approval In Progress** status.

Auto Pay Request Status Transition without Approval

The following figure graphically indicates how an auto pay request moves from one status to another when the approval process is not configured in the auto pay request type:

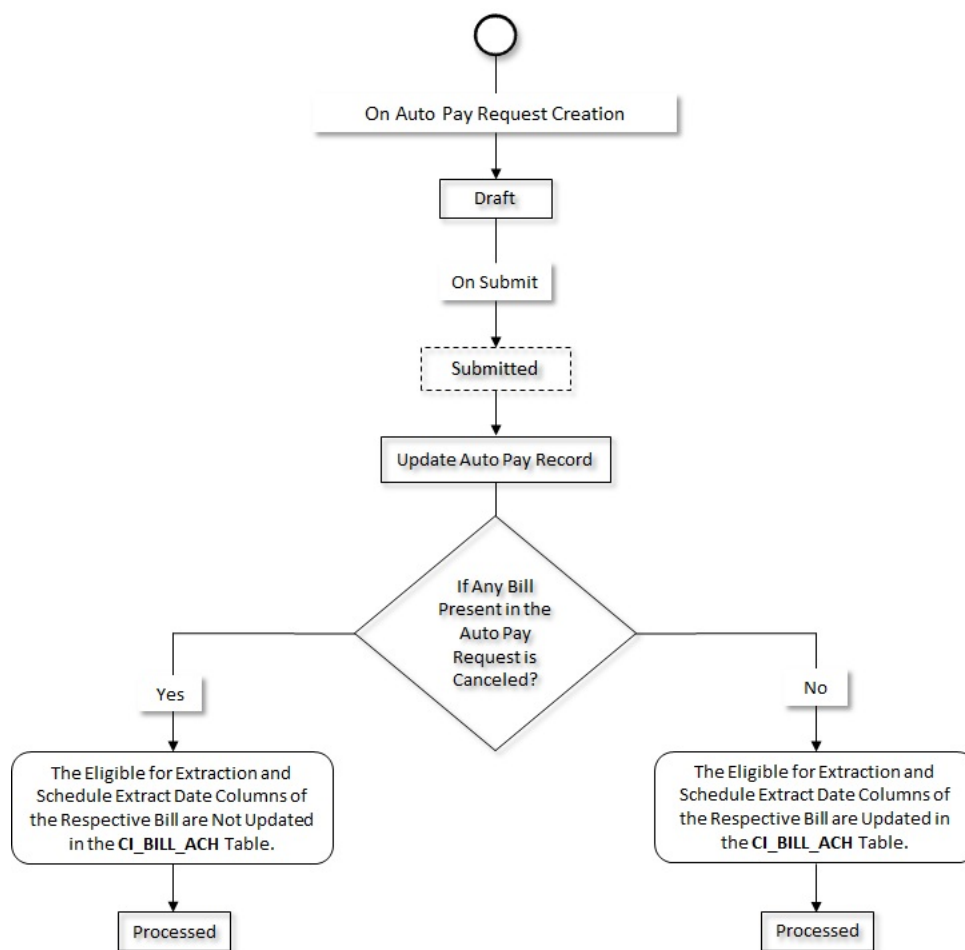

Auto Pay Request Status Transition with Approval

The following figure graphically indicates how an auto pay request moves from one status to another when the approval process is configured in the auto pay request type:

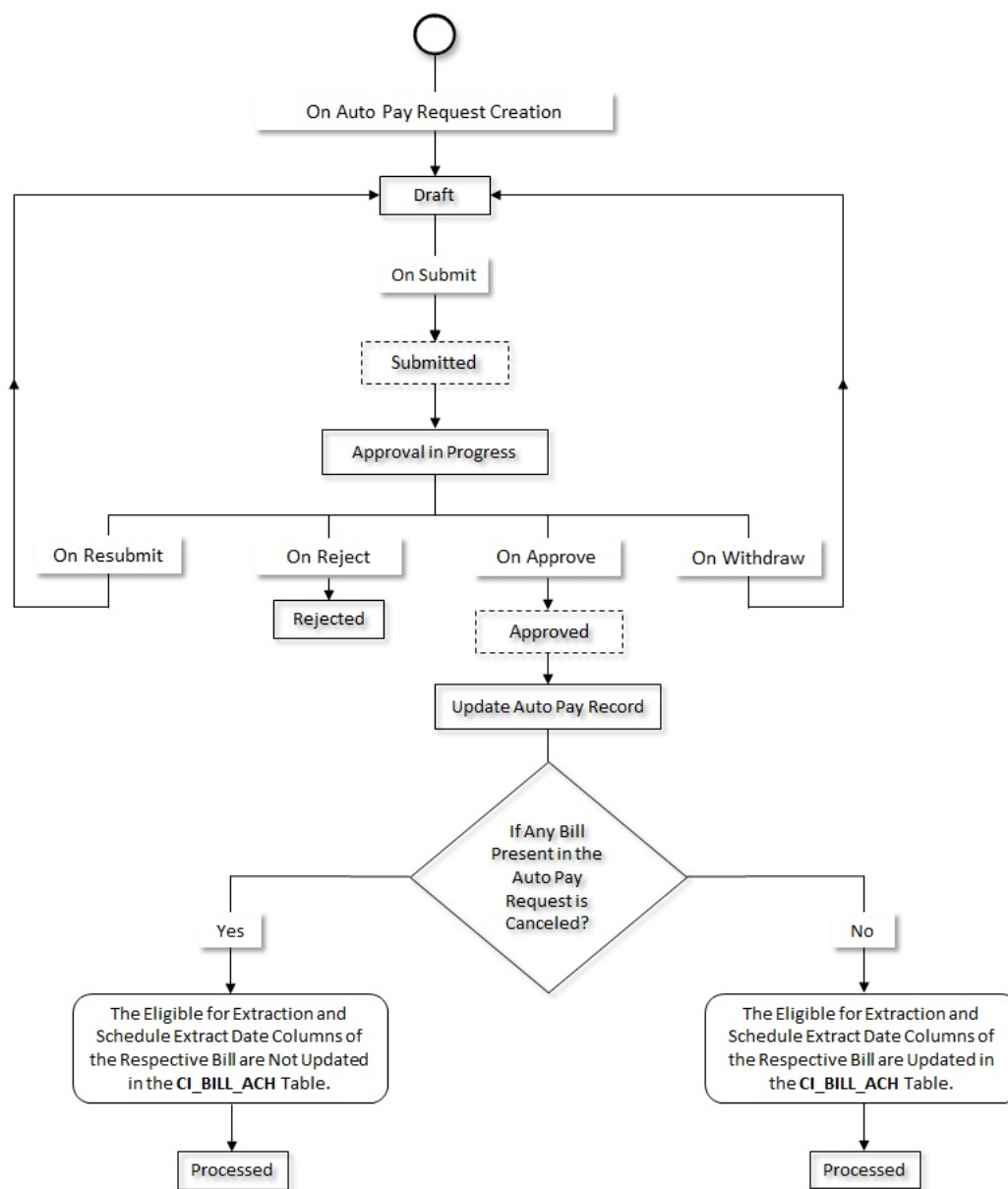

Auto Pay Request Type

The **Auto Pay Request Type** screen allows you to define, edit, copy, and delete an auto pay request type. It also allows you to view the details of an auto pay request type. It contains the following zones:

- [Auto Pay Request Type List](#) on page 3160
- [Auto Pay Request Type](#) on page 3161

Auto Pay Request Type List

The **Auto Pay Request Type List** zone lists the auto pay request types that are already defined in the system. It contains the following columns:

Column Name	Column Description
Auto Pay Request Type	Displays the auto pay request type.
Description	Displays the description of the auto pay request type.
Edit	On clicking the Edit (✎) icon, the Auto Pay Request Type screen appears where you can edit the details of the auto pay request type.
Duplicate	On clicking the Duplicate (📄) icon, the Auto Pay Request Type screen appears where you can define an auto pay request type using an existing auto pay request type.
Delete	On clicking the Delete (🗑) icon, you can delete the auto pay request type. Note: You can delete an auto pay request type only when an auto pay request is not yet created using the auto pay request type.

On clicking the **Broadcast** (📡) icon corresponding to an auto pay request type, the **Auto Pay Request Type** zone appears with the details of the respective auto pay request type.

Related Topics

For more information on...	See...
Auto Pay Request Type screen	Auto Pay Request Type on page 3160
How to edit an auto pay request type	Editing an Auto Pay Request Type on page 3167
How to copy an auto pay request type	Copying an Auto Pay Request Type on page 3169
How to delete an auto pay request type	Deleting an Auto Pay Request Type on page 3172
How to view the details of the auto pay request type	Viewing the Auto Pay Request Type Details on page 3172
Auto Pay Request Type zone	Auto Pay Request Type on page 3161

Auto Pay Request Type

The **Auto Pay Request Type** zone displays the details of the auto pay request type. It contains the following sections:

- **Main** - Displays basic information about the auto pay request type. It contains the following fields:

Field Name	Field Description
Auto Pay Request Type	Displays the auto pay request type.
Description	Displays the description of the auto pay request type.
Related Transaction BO	Indicates the business object using which the auto pay transaction is performed. In addition, a context menu appears corresponding to this field which helps in navigating to other screens in the application. Note: It has a link. On clicking the link, the Business Object screen appears where you can view the details of the respective business object.
Detailed Description	Displays additional information about the auto pay request type.
Auto Pay Request Action	Indicates the action which is performed on the auto pay request using the auto pay request type.

Field Name	Field Description
Status	Indicates the current status of the auto pay request type. The valid values are: <ul style="list-style-type: none"> Active Inactive
Approval Required	Indicates whether approval is required for the auto pay request which is created using the auto pay request type.
Approval To Do Type	Indicates that the To Do entry of the specified To Do Type is created when you submit the auto pay request for an approval. Note: It has a link. On clicking the link, the To Do Type screen appears where you can view the details of the respective To Do type. This field appears only when the Approval Required option is selected.
Approval To Do Role	Indicates that the users which belong to the specified To Do role can only approve the auto pay request when it is submitted for an approval. Note: It has a link. On clicking the link, the To Do Role screen appears where you can view the details of the respective To Do role. This field appears only when the Approval Required option is selected.
Submitter To Do Type	Indicates that the To Do entry of the specified To Do task is created when an auto pay request is resubmitted by an approver. Note: It has a link. On clicking the link, the To Do Type screen appears where you can view the details of the respective To Do type.
Submitter To Do Role	Indicates that the approvers which belong to the specified To Do role can only resubmit the auto pay request. Note: It has a link. On clicking the link, the To Do Role screen appears where you can view the details of the respective To Do role.

- **Characteristic** - Lists the characteristics defined for the auto pay request type. It contains the following columns:

Column Name	Column Description
Characteristic Type	Indicates the characteristic type.
Characteristic Value	Displays the value of the characteristic type.

- **Record Actions** - The **Record Actions** section contains the following buttons:

Button Name	Button Description
Edit	Used to edit the details of the auto pay request type.
Delete	Used to delete the auto pay request type.

Button Name	Button Description
	Note: You can delete an auto pay request type only when an auto pay request is not yet created using the auto pay request type.
Duplicate	Used to create a new auto pay request type using an existing auto pay request type.

- **Record Information** - The **Record Information** section contains the following fields:

Field Name	Field Description
Business Object	Indicates the business object using which the auto pay request type is created in the system. In addition, a context menu appears corresponding to this field which helps in navigating to other screens in the application. Note: It has a link. On clicking the link, the Business Object screen appears where you can view the details of the respective business object.

By default, the **Auto Pay Request Type** zone does not appear in the **Auto Pay Request Type** screen. It appears only when you click the **Broadcast** () icon corresponding to an auto pay request type in the **Auto Pay Request Type List** zone.

Related Topics

For more information on...	See...
How to define an auto pay request type	Defining an Auto Pay Request Type on page 3163
How to edit an auto pay request type	Editing an Auto Pay Request Type on page 3167
How to copy an auto pay request type	Copying an Auto Pay Request Type on page 3169
How to delete an auto pay request type	Deleting an Auto Pay Request Type on page 3172
How to view the details of an auto pay request type	Viewing the Auto Pay Request Type Details on page 3172
Auto Pay Request Type screen	Auto Pay Request Type on page 3160
Auto Pay Request Type List zone	Auto Pay Request Type List on page 3160

Defining an Auto Pay Request Type

Prerequisites

To define an auto pay request type, you should have:

- Auto pay request type business objects defined in the application
- Approval To Do Types and To Do roles defined in the application
- Submitter To Do Types and To Do roles defined in the application

Procedure

To define an auto pay request type:

1. Click the **Admin** link in the **Application** toolbar.
A list appears.
2. From the **Admin** menu, select **A** and then click **Auto Pay Request Type**.
A sub-menu appears.

- Click the **Add** option from the **Auto Pay Request Type** sub-menu.

Tip: Alternatively, you can access the **Auto Pay Request Type** screen by clicking the **Add** button in the **Page Title** area of the **Auto Pay Request Type** screen.

Note: The **Select Business Object** screen appears when there are multiple auto pay request type business objects defined in the application. If there is only one auto pay request type business object defined in the application, the **Auto Pay Request Type** screen appears.

- Select the required auto pay request type business object from the respective field.
- Click **OK**.

The **Auto Pay Request Type** screen appears. It contains the following sections:

- Main** - Used to specify basic details about the auto pay request type.
- Characteristics** - Used to define the characteristics for the auto pay request type.

The **Main** section contains the following fields:

Field Name	Field Description	Mandatory (Yes or No)
Auto Pay Request Type	Used to specify the auto pay request type.	Yes
Business Object	Indicates the business object using which the auto pay request type is defined in the system.	Not applicable
Description	Used to specify the description for the auto pay request type.	Yes
Related Transaction BO	Used to indicate the business object using which the auto pay transaction is performed. The valid value is: <ul style="list-style-type: none"> Auto Pay Request 	Yes
Detailed Description	Used to specify additional information about the auto pay request type.	No
Auto Pay Request Action	Indicates the action which is performed on the auto pay request using the auto pay request type. The valid value is: <ul style="list-style-type: none"> Update 	Not applicable
	Note: By default, the Update option is selected and cannot be edited.	
Status	Used to indicate the current status of the auto pay request type. The valid values are: <ul style="list-style-type: none"> Active Inactive 	Yes
	Note: You cannot change the status of an auto pay request type to Inactive when an auto pay request created using the auto pay request type is in the Draft or Rejected status.	

Field Name	Field Description	Mandatory (Yes or No)
Approval Required	Used to indicate whether approval is required for the auto pay request which is created using the auto pay request type.	No
Approval To Do Type	<p>Used to specify the To Do entry of the specified To Do Type that is created when you submit the auto pay request for an approval.</p> <p>Note:</p> <p>The Search (🔍) icon appears corresponding to the Approval To Do Type field. On clicking the Search icon, the To Do Type Search window appears.</p> <p>On specifying the To Do type, the description of the To Do type appears corresponding to the Approval To Do Type field.</p> <p>This field appears only when the Approval Required check box is selected.</p>	<p>Yes (Conditional)</p> <p>Note: This field is required while approving an auto pay request which is created using the auto pay request type.</p>
Approval To Do Role	<p>Used to indicate the users which belong to the specified To Do role who can approve the auto pay request when it is submitted for an approval.</p> <p>Note:</p> <p>The list includes only those To Do roles which are associated with the specified Approval To Do Type.</p> <p>This field appears only when the Approval Required check box is selected.</p>	<p>Yes (Conditional)</p> <p>Note: This field is required while approving an auto pay request which is created using the auto pay request type.</p>
Submitter To Do Type	<p>Used to indicate the To Do entry of the specified To Do Type that is created when an auto pay request is resubmitted by an approver.</p> <p>Note:</p> <p>The Search (🔍) icon appears corresponding to the Submitter To Do Type field. On clicking the Search icon, the To Do Type Search window appears.</p> <p>On specifying the To Do type, the description of the To Do type appears corresponding to the Submitter To Do Type field.</p> <p>This field appears only when the Approval Required check box is selected.</p>	<p>Yes (Conditional)</p> <p>Note: This field is required while resubmitting an auto pay request which is created using the auto pay request type.</p>
Submitter To Do Role	Used to indicate the users which belong to the specified To Do role who can resubmit the auto pay request when it is submitted for an approval.	Yes (Conditional)

Field Name	Field Description	Mandatory (Yes or No)
	<p>Note:</p> <p>The list includes only those To Do roles which are associated with the specified Submitter To Do Type.</p> <p>This field appears only when the Approval Required check box is selected.</p>	<p>Note: This field is required while resubmitting an auto pay request which is created using the auto pay request type.</p>

6. Enter the required details in the **Main** section.
7. Define a list of characteristics for the auto pay request type, if required.
8. Click **Save**.

The auto pay request type is defined.

Related Topics

For more information on...	See...
Auto Pay Request Type screen	Auto Pay Request Type on page 3160
How to define a characteristic for an auto pay request type	Defining a Characteristic for an Auto Pay Request Type on page 3166

Defining a Characteristic for an Auto Pay Request Type

Prerequisites

To define a characteristic for an auto pay request type, you should have:

- Characteristic types defined in the application (where the characteristic entity is set to **Auto Pay Request Type**)

Procedure

To define a characteristic for an auto pay request type:

1. Ensure that the **Characteristics** section is expanded when you are defining, editing, or copying an auto pay request type.

The **Characteristics** section contains the following fields in a grid:

Field Name	Field Description	Mandatory (Yes or No)
Characteristic Type	Used to indicate the characteristic type.	Yes (Conditional)
	<p>Note: The list includes only those characteristic types where the characteristic entity is set to Auto Pay Request Type.</p>	<p>Note: This field is required while defining a characteristic for the auto pay request type.</p>
Characteristic Value	Used to specify the value for the characteristic type.	Yes (Conditional)
		<p>Note: This field is required while defining a characteristic for the auto pay request type.</p>

Field Name	Field Description	Mandatory (Yes or No)
	<p>Note:</p> <p>If you select a predefined characteristic type, the Search (🔍) icon appears corresponding to the Characteristic Value field. On clicking the Search icon, you can search for the respective characteristic value.</p> <p>On specifying the value for a predefined characteristic type, the description of the characteristic value appears corresponding to the Characteristic Value field.</p>	

- Enter the required details in the **Characteristics** section.
- If you want to define more than one characteristic for the auto pay request type, click the **Add** (+) icon and then repeat step 2.

Note: However, if you want to remove a characteristic from the auto pay request type, click the **Delete** (🗑️) icon corresponding to the characteristic.

Related Topics

For more information on...	See...
How to define an auto pay request type	Defining an Auto Pay Request Type on page 3163
How to edit an auto pay request type	Editing an Auto Pay Request Type on page 3167
How to copy an auto pay request type	Copying an Auto Pay Request Type on page 3169

Editing an Auto Pay Request Type

Prerequisites

To edit an auto pay request type, you should have:

- Auto pay request type that you want to edit defined in the application

Procedure

To edit an auto pay request type:

- Click the **Admin** link in the **Application** toolbar.
A list appears.
- From the **Admin** menu, select **A** and then click **Auto Pay Request Type**.
A sub-menu appears.
- Click the **Search** option from the **Auto Pay Request Type** sub-menu.
The **Auto Pay Request Type** screen appears.
- In the **Auto Pay Request Type List** zone, click the **Edit** (✎) icon in the **Edit** column corresponding to the auto pay request type whose details you want to edit.

The **Auto Pay Request Type** screen appears. It contains the following sections:

- Main** - Used to specify basic details about the auto pay request type.

- **Characteristics** - Used to define the characteristics for the auto pay request type.

The **Main** section contains the following fields:

Field Name	Field Description	Mandatory (Yes or No)
Auto Pay Request Type	Displays the auto pay request type.	Not applicable
Business Object	Indicates the business object using which the auto pay request type is defined in the system.	Not applicable
Description	Used to specify the description for the auto pay request type.	Yes
Related Transaction BO	Used to indicate the business object using which the auto pay transaction is performed.	Yes
Detailed Description	Used to specify additional information about the auto pay request type.	No
Auto Pay Request Action	Displays the action which is performed on the auto pay request using the auto pay request type.	Not applicable
Status	Used to indicate the status of the auto pay request type. The valid values are: <ul style="list-style-type: none"> • Active • Inactive 	Yes
Approval Required	Used to indicate whether approval is required for the auto pay request which is created using the auto pay request type.	No
Approval To Do Type	Used to indicate the To Do task which is performed by the approver while approving the auto pay request. <div style="border: 1px solid black; padding: 5px; margin-top: 10px;"> <p>Note:</p> <p>The Search (🔍) icon appears corresponding to the Approval To Do Type field. On clicking the Search (🔍) icon, the To Do Type Search window appears.</p> <p>On specifying the To Do type, the description of the To Do type appears corresponding to the Approval To Do Type field.</p> <p>This field appears when the Approval Required option is selected.</p> </div>	Yes
Approval To Do Role	Used to indicate the users with the specified To Do role who can approve the auto pay request.	Yes

Field Name	Field Description	Mandatory (Yes or No)
	<p>Note:</p> <p>The list includes only those To Do roles which are associated with the approval To Do type.</p> <p>This field appears when the Approval Required option is selected.</p>	
Submitter To Do Type	<p>Used to indicate the To Do task created when an auto pay request is submitted by an approver.</p> <p>Note:</p> <p>The Search (🔍) icon appears corresponding to the Submitter To Do Type field. On clicking the Search icon, the To Do Type Search window appears.</p> <p>On specifying the To Do type, the description of the To Do type appears corresponding to the Submitter To Do Type field.</p>	Yes
Submitter To Do Role	<p>Used to indicate the users with the specified To Do role who can submit the auto pay request for approval.</p> <p>Note: The list includes only those To Do roles which are associated with the submitter To Do type.</p>	Yes

Tip: Alternatively, you can access this screen by clicking the **Edit** button in the **Auto Pay Request Type** zone.

5. Modify the required details in the **Main** section.
6. Define, edit, or remove characteristics of the auto pay request type, if required.
7. Click **Save**.

The changes made to the auto pay request type are saved.

Related Topics

For more information on...	See...
Auto Pay Request Type screen	Auto Pay Request Type on page 3160
Auto Pay Request Type List zone	Auto Pay Request Type List on page 3160
Auto Pay Request Type zone	Auto Pay Request Type on page 3161
How to define a characteristic for an auto pay request type	Defining a Characteristic for an Auto Pay Request Type on page 3166

Copying an Auto Pay Request Type

Instead of creating an auto pay request type from scratch, you can create a new auto pay request type using an existing auto pay request type. This is possible through copying an auto pay request type. On copying an auto pay request type, the details including the characteristics are copied to the new auto pay request type. You can then edit the details, if required.

Prerequisites

To copy an auto pay request type, you should have:

- Auto pay request type (whose copy you want to create) defined in the application
- Auto pay request business objects defined in the application

Procedure

To copy an auto pay request type:

1. Click the **Admin** link in the **Application** toolbar.

A list appears.

2. From the **Admin** menu, select **A** and then click **Auto Pay Request Type**.

A sub-menu appears.

3. Click the **Search** option from the **Auto Pay Request Type** sub-menu.

The **Auto Pay Request Type** screen appears.

4. In the **Auto Pay Request Type List** zone, click the **Duplicate** () icon in the **Duplicate** column corresponding to the auto pay request type whose copy you want to create.

The **Auto Pay Request Type** screen appears. It contains the following sections:

- **Main** - Used to specify basic details about the auto pay request type.
- **Characteristics** - Used to define the characteristics for the auto pay request type.

The **Main** section contains the following fields:

Field Name	Field Description	Mandatory (Yes or No)
Auto Pay Request Type	Used to specify the auto pay request type.	Yes
Business Object	Indicates the business object using which the auto pay request type is defined in the system.	Not applicable
Description	Used to specify the description for the auto pay request type.	Yes
Related Transaction BO	Used to indicate the business object using which the auto pay transaction is performed.	Yes
Detailed Description	Used to specify additional information about the auto pay request type.	No
Status	Used to indicate the status of the auto pay request type. The valid values are: <ul style="list-style-type: none"> • Active • Inactive 	Yes
Approval Required	Used to indicate whether approval is required for the auto pay request which is created using the auto pay request type.	No

Field Name	Field Description	Mandatory (Yes or No)
Approval To Do Type	<p>Used to indicate the To Do task which is performed by the approver while approving the auto pay request.</p> <p>Note:</p> <p>The Search (🔍) icon appears corresponding to the Approval To Do Type field. On clicking the Search icon, the To Do Type Search window appears.</p> <p>On specifying the To Do type, the description of the To Do type appears corresponding to the Approval To Do Type field.</p> <p>This field appears when the Approval Required option is selected.</p>	Yes
Approval To Do Role	<p>Used to indicate the users with the specified To Do role who can approve the auto pay request.</p> <p>Note:</p> <p>The list includes only those To Do roles which are associated with the approval To Do type.</p> <p>This field appears when the Approval Required option is selected.</p>	Yes
Submitter To Do Type	<p>Used to indicate the To Do task created when an auto pay request is submitted by an approver.</p> <p>Note:</p> <p>The Search (🔍) icon appears corresponding to the Submitter To Do Type field. On clicking the Search icon, the To Do Type Search window appears.</p> <p>On specifying the To Do type, the description of the To Do type appears corresponding to the Submitter To Do Type field.</p>	Yes
Submitter To Do Role	<p>Used to indicate the users with the specified To Do role who can submit the auto pay request for approval.</p> <p>Note: The list includes only those To Do roles which are associated with the submitter To Do type.</p>	Yes

Tip: Alternatively, you can copy an auto pay request type by clicking the **Duplicate** button in the **Auto Pay Request Type** zone.

5. Enter the required details in the **Main** section.
6. Define, edit, or remove characteristics of the auto pay request type, if required.
7. Click **Save**.

The new auto pay request type is defined.

Related Topics

For more information on...	See...
Auto Pay Request Type screen	Auto Pay Request Type on page 3160
Auto Pay Request Type List zone	Auto Pay Request Type List on page 3160
Auto Pay Request Type zone	Auto Pay Request Type on page 3161
How to define a characteristic for an auto pay request type	Defining a Characteristic for an Auto Pay Request Type on page 3166

Deleting an Auto Pay Request Type

Procedure

To delete an auto pay request type:

1. Click the **Admin** link in the **Application** toolbar.
A list appears.
2. From the **Admin** menu, select **A** and then click **Auto Pay Request Type**.
A sub-menu appears.
3. Click the **Search** option from the **Auto Pay Request Type** sub-menu.
The **Auto Pay Request Type** screen appears.
4. In the **Auto Pay Request Type List** zone, click the **Delete** (🗑) icon in the **Delete** column corresponding to the auto pay request type that you want to delete.
A message appears confirming whether you want to delete the auto pay request type.

Tip: Alternatively, you can delete an auto pay request type by clicking the **Delete** button in the **Auto Pay Request Type** zone.

5. Click **OK**.

The auto pay request type is deleted.

Related Topics

For more information on...	See...
Auto Pay Request Type screen	Auto Pay Request Type on page 3160
Auto Pay Request Type List zone	Auto Pay Request Type List on page 3160
Auto Pay Request Type zone	Auto Pay Request Type on page 3161

Viewing the Auto Pay Request Type Details

Procedure

To view the details of an auto pay request type:

1. Click the **Admin** link in the **Application** toolbar.
A list appears.
2. From the **Admin** menu, select **A** and then click **Auto Type Request Type**.
A sub-menu appears.
3. Click the **Search** option from the **Auto Type Request Type** sub-menu.
The **Auto Pay Request Type** screen appears.
4. In the **Auto Pay Request Type List** zone, click the **Broadcast** () icon corresponding to the auto pay request type whose details you want to view.
The **Auto Pay Request Type** zone appears.
5. View the details of the auto pay request type in the **Auto Pay Request Type** zone.

Related Topics

For more information on...	See...
Auto Pay Request Type screen	Auto Pay Request Type on page 3160
Auto Pay Request Type List zone	Auto Pay Request Type List on page 3160
Auto Pay Request Type zone	Auto Pay Request Type on page 3161

Auto Pay Request (Used for Searching)

The **Auto Pay Request** screen allows you to search for an auto pay request using various search criteria. It contains the following zone:

- [Search Auto Pay Request](#) on page 3173

Through this screen, you can navigate to the following screen:

- [Auto Pay Request \(Used for Viewing\)](#) on page 3178

Search Auto Pay Request

The **Search Auto Pay Request** zone allows you to search for an auto pay request using various search criteria. It contains the following two sections:

- **Search Criteria** - The **Search Criteria** section contains the following fields:

Field Name	Field Description	Mandatory (Yes or No)
Search By	Used to indicate whether you want to search for an auto pay request using the auto pay request or person, account or bill details. The valid values are: <ul style="list-style-type: none"> • Request Details • Person, Account or Bill Details <p>Note: By default, the Request Details option is selected.</p>	Yes
Auto Pay Request Type	Used to search auto pay requests which are created using a particular auto pay request type.	No

Field Name	Field Description	Mandatory (Yes or No)
	Note: This field appears when the Request Details option is selected from the Search By list.	
Status	Used to search auto pay requests with a particular status. The valid values are: <ul style="list-style-type: none"> • Approved • Approval in Progress • Draft • Processed • Rejected • Update Auto Pay Record Note: This field appears when the Request Details option is selected from the Search By list.	Yes
Created From	Used to search auto pay requests which are created from a particular date onwards. Note: This field appears when the Request Details option is selected from the Search By list.	No
User ID	Used to search auto pay requests which are created by a particular user. Note: This field appears when the Request Details option is selected from the Search By list.	No
Created Until	Used to search auto pay requests which are created till a particular date. Note: This field appears when the Request Details option is selected from the Search By list.	No
Auto Pay Request ID	Used to search a particular auto pay request. Note: This field appears when the Request Details option is selected from the Search By list.	No
Person ID	Used to search auto pay requests which include bills of a particular person.	No

Field Name	Field Description	Mandatory (Yes or No)
	<p>Note:</p> <p>The Search (🔍) icon appears corresponding to the Person ID field. On clicking the Search icon, the Person Search window appears.</p> <p>This field appears when the Person, Account or Bill Details option is selected from the Search By list.</p>	
Account ID	<p>Used to search auto pay requests which include bills of a particular account.</p> <p>Note:</p> <p>The Search (🔍) icon appears corresponding to the Account ID field. On clicking the Search icon, the Account Search window appears.</p> <p>This field appears when the Person, Account or Bill Details option is selected from the Search By list.</p>	No
Bill ID	<p>Used to search auto pay requests which include a particular bill.</p> <p>Note:</p> <p>The Search (🔍) icon appears corresponding to the Bill ID field. On clicking the Search icon, the Bill Search window appears.</p> <p>This field appears when the Person, Account or Bill Details option is selected from the Search By list.</p>	No
From Bill Date	<p>Used to search auto pay requests which include bills created from a particular date onwards.</p> <p>Note: This field appears when the Person, Account or Bill Details option is selected from the Search By list.</p>	No
Auto Pay ID	<p>Used to search auto pay requests which include bills of a particular auto pay ID.</p> <p>Note: This field appears when the Person, Account or Bill Details option is selected from the Search By list.</p>	No
To Bill Date	<p>Used to search auto pay requests which include bills created till a particular date.</p>	No

Field Name	Field Description	Mandatory (Yes or No)
	Note: This field appears when the Person, Account or Bill Details option is selected from the Search By list.	

Note: You must specify at least one search criterion while searching for an auto pay request.

- **Search Results** - On clicking the **Search** button, the search results appear based on the specified search criteria. The **Search Results** section contains the following columns:

Column Name	Column Description
Creation Date Time	Displays the date and time when the auto pay request is created.
Auto Pay Request Information	Displays the concatenated string of information about the auto pay request. Note: It has a link. On clicking the link, the Auto Pay Request screen appears where you can view the details of the respective auto pay request.
Status	Indicates the status of the auto pay request. The valid values are: <ul style="list-style-type: none"> • Approved • Approval in Progress • Draft • Processed • Rejected • Update Auto Pay Record
Auto Pay Request Type	Indicates the type of the auto pay request.
Created By	Indicates the concatenated string of the user information who has created the auto pay request.

Note: Pagination is used to display limited number of records in the **Search Results** section. You can use the navigation links, such as **Previous** and **Next** to navigate between pages.

Related Topics

For more information on...	See...
How to search for an auto pay request	Searching for an Auto Pay Request on page 3176
How to view the details of an auto pay request	Viewing the Auto Pay Request Details on page 3178
How to create an auto pay request	Creating an Auto Pay Request on page 3177

Searching for an Auto Pay Request

Prerequisites

To search for an auto pay request, you should have:

- Auto pay request types defined in the application

Procedure

To search for an auto pay request:

1. Click the **Menu** link in the **Application** toolbar.
A list appears.
2. From the **Main** menu, select **Accounting and Receivable** and then click **Auto Pay Request**.
A sub-menu appears.
3. Click the **Search** option from the **Auto Pay Request** sub-menu.
The **Auto Pay Request** screen appears.
4. Enter the search criteria in the **Search Auto Pay Request** zone.

Note: ORMB search engine supports wildcard search, where you can substitute the percentage (%) symbol as a stand in for any word or letter in a search criteria. You can use the ‘%’ wildcard character in all input fields except the date and ID fields. The ‘%’ wildcard character is suffixed automatically at the end of the partial search criteria. Therefore, you may or may not specify the wildcard character at the end of the partial search criteria. However, you have to prefix the wildcard character manually wherever required.

5. Click **Search**.

A list of auto pay requests that meet the search criteria appears in the **Search Results** section.

Related Topics

For more information on...	See...
Auto Pay Request screen	Auto Pay Request (Used for Searching) on page 3173
Search Auto Pay Request zone	Search Auto Pay Request on page 3173

Creating an Auto Pay Request

Prerequisites

To create an auto pay request, you should have:

- Auto pay request types defined in the application

Procedure

To create an auto pay request:

1. Click the **Menu** link in the **Application** toolbar.
A list appears.
2. From the **Main** menu, select **Accounting and Receivable** and then click **Auto Pay Request**.
A sub-menu appears.
3. Click the **Add** option from the **Auto Pay Request** sub-menu.

The **Add Auto Pay Request** screen appears. It contains the following field:

Field Name	Field Description	Mandatory (Yes or No)
Auto Pay Request Type	Used to indicate the auto pay request type using which you want to create the auto pay request for the bills.	Yes

Tip: Alternatively, you can access this screen by clicking the **Add** button in the **Page Title** area of the **Auto Pay Request** screen.

4. Select the required auto pay request type from the **Add Auto Pay Request** screen.
5. Click **OK**.

The **Auto Pay Request** screen appears with the auto pay request details in the **Draft** status.

6. Add the auto pay line items of the bills by searching for the bills in the **Search Bills** zone of the **Auto Pay Request - Bills** tab.
7. Define characteristics for the auto pay request by editing the auto pay request, if required.
8. Add logs for the auto pay request in the **Auto Pay Request Log** zone of the **Auto Pay Request - Log** tab, if required.

Related Topics

For more information on...	See...
Auto Pay Request screen	Auto Pay Request (Used for Searching) on page 3173
How to add an auto pay line item in an auto pay request	Adding an Auto Pay Line Item in an Auto Pay Request on page 3190
How to define a characteristic for an auto pay request	Defining a Characteristic for an Auto Pay Request on page 3184
How to add a log entry for an auto pay request	Adding a Log Entry for an Auto Pay Request on page 3193

Viewing the Auto Pay Request Details

Procedure

To view the details of an auto pay request:

1. Search for the auto pay request in the **Auto Pay Request** screen.
2. In the **Search Results** section, click the link in the **Auto Pay Request Information** column corresponding to the auto pay request whose details you want to view.
The **Auto Pay Request** screen appears.
3. Ensure that the **Main** tab is selected.
4. View the details of the auto pay request in the **Auto Pay Request** and **Auto Pay Details** zone.

Related Topics

For more information on...	See...
How to search for an auto pay request	Searching for an Auto Pay Request on page 3176
Auto Pay Request screen	Auto Pay Request (Used for Searching) on page 3173
Search Auto Pay Request zone	Search Auto Pay Request on page 3173

Auto Pay Request (Used for Viewing)

The **Auto Pay Request** screen allows you to do the following:

- View the details of the auto pay request
- View the debit and credit bills which are added to the auto pay request
- Edit the auto pay request details
- Delete the auto pay request

- Submit the auto pay request for an approval
- Search the bills
- Add bills in the auto pay request
- View the log of the auto pay request
- Add a log entry for the auto request

It consists of the following tabs:

- [Auto Pay Request - Main](#) on page 3179
- [Auto Pay Request - Bills](#) on page 3181
- [Auto Pay Request - Log](#) on page 3184

Auto Pay Request - Main

The **Main** tab displays information about the auto pay request. It contains the following zones:

- [Auto Pay Request](#) on page 3179
- [Auto Pay Details](#) on page 3181

Auto Pay Request

The **Auto Pay Request** zone displays the details of the auto pay request. It contains the following sections:

- **Main** - Displays basic information about the auto pay request. It contains the following fields:

Field Name	Field Description
Auto Pay Request Information	Displays information about the auto pay request.
Auto Pay Request Type	Indicates the auto pay request type using which the auto pay request is created. Note: It has a link. On clicking the link, the Auto Pay Request Type screen appears where you can view the details of the respective auto request type.
Status	Indicates the status of the auto pay request. The valid values are: <ul style="list-style-type: none"> • Approved • Approval in Progress • Draft • Processed • Rejected • Update Auto Pay Record
Status Reason	Indicates the reason why the auto pay request is rejected. Note: It has a link. On clicking the link, the Status Reason screen appears where you can view the details of the respective status reason. This field appears when the auto pay request is in the Rejected status.

- **Characteristics** - Lists the characteristics defined for the auto pay request. It contains the following columns:

Column Name	Column Description
Effective Date	Displays the date from when the characteristic is effective for the auto pay request.
Characteristic Type	Indicates the characteristic type.
Characteristic Value	Displays the value of the characteristic type.

- **Record Actions** - This section contains the following buttons:

Button Name	Button Description
Edit	Used to edit the details of the auto pay request.
	Note: The Edit button appears when the auto pay request is in the Draft status.
Delete	Used to delete the auto pay request.
	Note: The Delete button appears when the auto request is in the Draft status.
Submit	Used to submit the auto pay request.
	Note: The Submit button appears when the auto request is in the Draft status.
Approve	Used to approve the auto pay request.
	Note: The Approve button appears when: <ul style="list-style-type: none"> • The auto pay request is in the Approval In Progress status. • A user with the approval To Do role is reviewing the auto pay request.
Reject	Used to reject the auto pay request.
	Note: The Reject button appears when: <ul style="list-style-type: none"> • The auto pay request is in the Approval In Progress status. • A user with the approval To Do role is reviewing the auto pay request.

- **Record Information** - This section contains the following fields:

Field Name	Field Description
Business Object	Indicates the business object using which the auto pay request is created. In addition, a context menu appears corresponding to this field which helps in navigating to other screens in the application.
	Note: It has a link. On clicking the link, the Business Object screen appears where you can view the details of the respective business object.
Status Date/Time	Displays the date and time when the auto pay request status is updated
Create Date/Time	Displays the date and time when the auto pay request is created.

Related Topics

For more information on...	See...
How to delete an auto pay request	Deleting an Auto Pay Request on page 3186
How to submit an auto pay request	Submitting an Auto Pay Request on page 3187
How to approve an auto pay request	Approving an Auto Pay Request on page 3188
How to reject an auto pay request	Rejecting an Auto Pay Request on page 3188

Auto Pay Details

The **Auto Pay Details** zone displays the details of the auto pay request. It contains the following columns:

Column Name	Column Description
Auto Pay ID	Displays the automatic payment ID.
Account Number	Displays the account number for which the automatic payment is defined.
Account Information	Displays the concatenated string of information about the account separated by a comma (.). Note: It has a link. On clicking the link, the Account screen appears where you can view the details of the respective account.
Bill Information	Displays the concatenated string of information about the bill separated by a comma (.). Note: It has a link. On clicking the link, the Bill screen appears where you can view the bill details of the respective account.
Auto Pay Amount	Displays the automatic payment deduction amount.
Schedule Extract Date	Displays the scheduled date when the payment is debited from the account.
Eligible for Extraction	Displays the value of extraction.

In addition, the **Auto Pay Details** zone contains the following buttons:

Button Name	Button Description
Edit	Used to edit the schedule extract date of the auto pay request. Note: The Edit button appears when the auto pay request is in the Draft status.
Delete	Used to delete the auto pay request. Note: The Delete button appears when the auto request is in the Draft status.

Related Topics

For more information on...	See...
How to edit the auto pay request details	Editing the Auto Pay Request Details on page 3185

Auto Pay Request - Bills

The **Bills** tab allows you to search with auto pay line items, that you want to add in the auto pay request. It contains the following zones:

- [Search Bills](#) on page 3182
- [Auto Pay Line Items](#) on page 3183

Search Bills

The **Search Bills** zone allows you to filter the bills using various search criteria. It contains the following two sections:

- **Search Criteria** - The **Search Criteria** section contains the following fields:

Field Name	Field Description	Mandatory (Yes or No)
Person ID	Used to search bills of a particular person.	No
	Note: The Search (🔍) icon appears corresponding to the Person ID field. On clicking the Search icon, the Person Search window appears.	
Account ID	Used to search bills which created for a particular account.	No
	Note: The Search (🔍) icon appears corresponding to the Account ID field. On clicking the Search icon, the Account Search window appears.	
Bill ID	Used to search a particular bill.	No
	Note: The Search (🔍) icon appears corresponding to the Bill ID field. On clicking the Search icon, the Bill Search window appears.	
Division	Used to search for bills which belong to a particular division.	Yes
From Bill Date	Used to search for bills which are created from a particular date onwards.	No
From Bill Due Date	Used to search for bills which are created from a particular due date onwards.	No
To Bill Date	Used to search for bills which are created till a particular date.	No
To Bill Due Date	Used to search bills which are created till a particular due date.	No
Eligible For Extraction	Used to indicate whether you want to search bills by eligibility for extraction criteria. The valid values are: <ul style="list-style-type: none"> • No • Yes 	Yes

- **Search Results** - On clicking the **Search** button, the search results appear based on the specified search criteria. The **Search Results** section contains the following columns:

Column Name	Column Description
Bill ID	Displays the bill ID.
Bill Information	Display the concatenated string of information about the bill separated by a comma (.). Note: It has a link. On clicking the link, the Bill screen appears where you can view the details of the respective bill.
Bill Amount	Displays the bill amount (i.e. unpaid amount).
Account Information	Display the concatenated string of information about the account separated by a comma (.). Note: It has a link. On clicking the link, the Account screen appears where you can view the details of the respective account.

Note: Pagination is used to display limited number of records in the **Search Results** section. You can use the navigation links, such as **Previous** and **Next** to navigate between pages.

Related Topics

For more information on...	See...
How to search for a bill	Searching for a Bill on page 3190

Auto Pay Line Items

The **Auto Pay Line Items** zone displays the list of bills. It contains the following columns:

Column Name	Column Description
Auto Pay ID	Displays the automatic payment ID.
Account Number	Displays the account number for which the automatic payment is defined.
Account Information	Displays the concatenated string of information about the account separated by a comma (.). Note: It has a link. On clicking the link, the Account screen appears where you can view the details of the respective account.
Auto Pay Amount	Displays the automatic payment deduction amount.
Auto Pay Creation Date	Displays the date when the account is created.
Eligible for Extraction	Displays the value of extraction.

Related Topics

For more information on...	See...
How to search for a bill	Searching for a Bill on page 3190
How to add an auto pay line item in an auto pay request	Adding an Auto Pay Line Item in an Auto Pay Request on page 3190

Auto Pay Request - Log

The **Log** tab contains the following zone:

- [Auto Pay Request Log](#) on page 3184

Auto Pay Request Log

The **Auto Pay Request Log** zone lists the complete trail of actions performed on the auto pay request. It contains the following columns:

Column Name	Column Description
Creation Date Time	Displays the date and time when the action was performed on the auto pay request.
Details	Displays the details about the action performed on the auto pay request.
User	Indicates the user who has performed the action on the auto pay request.
Log Type	Indicates the type of log.
Related Object	Indicates the object or entity which is created when the action is performed on the auto pay request. Note: At present, no data appears in this column. The implementation team can build the custom logic to meet the business requirements.
Status Reason	Indicates the reason why the auto pay request is rejected.

Note: You can manually add a log entry for the auto pay request by clicking the **Add Log Entry** link in the upper right corner of the **Auto pay Request Log** zone.

Related Topics

For more information on...	See...
How to view the log of an auto pay request	Viewing the Log of an Auto Pay Request on page 3193
How to add a log entry for an auto pay request	Adding a Log Entry for an Auto Pay Request on page 3193

Defining a Characteristic for an Auto Pay Request

Prerequisites

To define a characteristic for an auto pay request, you should have:

- Characteristic types defined in the application (where the characteristic entity is set to **Auto Pay Request**)

Procedure

To define a characteristic for an auto pay request:

1. Click **Edit** button, on the **Auto Pay Request** zone in the Main tab of the **Auto Pay Request** screen.

The **Characteristics** section contains the following fields in a grid:

Field Name	Field Description	Mandatory (Yes or No)
Effective Date	Used to specify the date from when the characteristic is effective for the auto pay request.	Yes (Conditional)

Field Name	Field Description	Mandatory (Yes or No)
		Note: This field is required while defining a characteristic for the auto pay request.
Characteristic Type	Used to indicate the characteristic type.	Yes (Conditional)
	Note: The list includes only those characteristic types where the characteristic entity is set to Auto Pay Request .	Note: This field is required while defining a characteristic for the auto pay request.
Characteristic Value	Used to specify the value for the characteristic type.	Yes (Conditional)
	Note: If you select a predefined characteristic type, the Search (🔍) icon appears corresponding to the Characteristic Value field. On clicking the Search icon, the Predefined Characteristic Search window appears. On specifying the value for a predefined characteristic type, the description of the characteristic value appears corresponding to the Characteristic Value field.	Note: This field is required while defining a characteristic for the auto pay request.

- Enter the required details in the **Characteristics** section.
- If you want to define more than one characteristic for the auto pay request, click the **Add** (+) icon and then repeat step 2.

Note: However, if you want to remove a characteristic from the auto pay request, click the **Delete** (🗑️) icon corresponding to the characteristic.

- Click **Save**.

The characteristics are defined for the auto pay request.

Related Topics

For more information on...	See...
Auto Pay Request zone	Auto Pay Request on page 3179
How to edit an auto pay request details	Editing the Auto Pay Request Details on page 3185

Editing the Auto Pay Request Details

Prerequisites

To edit an auto pay request details, you should have:

- Auto pay requests defined in the application

Procedure

To edit an auto pay request details:

1. Search for the auto pay request in the **Search Auto Pay Request** zone of the **Auto Pay Request** screen.
2. In the **Search Results** section, click the link in the **Auto Pay Request Information** column corresponding to the auto pay request whose details you want to edit.

The **Auto Pay Request** screen appears.

3. Ensure that the **Main** tab is selected.
4. Click the **Edit** button in the **Auto Pay Request** zone.

The **Edit Auto Pay Request** screen appears. It contains the following sections:

- **Main** - Used to specify the basic details about the auto pay request.
- **Characteristics** - Used to define the characteristics for the auto pay request.

The **Main** section contains the following fields:

Field Name	Field Description	Mandatory (Yes or No)
Auto Pay Request Information	Displays the concatenated string of information about the auto pay request separated by a comma (,).	Not applicable
Comments	Used to specify additional information about the auto pay request.	No

5. Modify the required details in the **Main** section.
6. Define, edit, or remove characteristics from the auto pay request, if required.
7. Click **Save**.

The changes made to the auto pay request are saved.

Note: The **Edit** button appears only when the auto pay request is in the **Draft** status.

Related Topics

For more information on...	See...
How to search for an auto pay request	Searching for an Auto Pay Request on page 3176
Auto Pay Request screen	Auto Pay Request (Used for Searching) on page 3173
Auto Pay Request screen	Auto Pay Request (Used for Viewing) on page 3178
Auto Pay Request zone	Auto Pay Request Type on page 3161
How to define a characteristic for an auto pay request	Defining a Characteristic for an Auto Pay Request on page 3184

Deleting an Auto Pay Request

Procedure

To delete an auto pay request:

1. Search for the auto pay request in the **Search Auto Pay Request** zone of the **Auto Pay Request** screen.
2. In the **Search Results** section, click the link in the **Auto Pay Request Information** column corresponding to the auto pay request that you want to delete.

The **Auto Pay Request** screen appears.

3. Ensure that the **Main** tab is selected.

- Click the **Delete** button in the **Auto Pay Request** zone.

A message appears confirming whether you want to delete the auto pay request.

- Click **OK**.

The auto pay request is deleted.

Note: The **Delete** button appears only when the auto pay request is in the **Draft** status.

Related Topics

For more information on...	See...
How to search for an auto pay request	Searching for an Auto Pay Request on page 3176
Auto Pay Request screen	Auto Pay Request (Used for Searching) on page 3173
Auto Pay Request zone	Auto Pay Request on page 3179

Submitting an Auto Pay Request

Prerequisites

To submit an auto pay request, you should have:

- At least one bill added to the auto pay request
- Automatic payment amount of each bill not equal to zero

Procedure

To submit an auto pay request:

- Search for the auto pay request in the **Search Auto Pay Request** zone of the **Auto Pay Request** screen.
- In the **Search Results** section, click the link in the **Auto Pay Request Information** column corresponding to the auto pay request which you want to submit.

The **Auto Pay Request** screen appears.

- Ensure that the **Main** tab is selected.
- Click **Submit** button in the **Auto Pay Request** zone.

A message appears confirming whether you want to submit the auto pay request.

- Click **OK**.

The auto pay request is submitted.

Note:

At least one auto pay record is required for submitting the auto pay request.

The **Submit** button appears only when the auto pay request is in the **Draft** status.

Related Topics

For more information on...	See...
How to search for an auto pay request	Searching for an Auto Pay Request on page 3176
Auto Pay Request screen	Auto Pay Request (Used for Viewing) on page 3178
Auto Pay Request zone	Auto Pay Request on page 3179

Approving an Auto Pay Request

Prerequisites

To approve an auto pay request, you should have:

- At least one bill added to the auto pay request

Procedure

To approve an auto pay request:

1. Search for the auto pay request in the **Search Auto Pay Request** zone **Auto Pay Request** screen.
2. In the **Search Results** section, click the link in the **Auto Pay Request Information** column corresponding to the auto pay request which you want to approve.

The **Auto Pay Request** screen appears.

3. Ensure that the **Main** tab is selected.
4. Click the **Approve** button in the **Auto Pay Request** zone.

A message appears confirming whether you want to approve the auto pay request.

5. Click **OK**.

The auto pay request is approved.

Note:

You can approve the auto pay request only in the **Approval In Progress** status.

You can approve the auto pay request only when the auto pay request is assigned to you for an approval.

The **Approve** button appears only when the auto pay request is in the **Approval In Progress** status.

Related Topics

For more information on...	See...
How to search for an auto pay request	Searching for an Auto Pay Request on page 3176
Auto Pay Request screen	Auto Pay Request (Used for Viewing) on page 3178
Auto Pay Request zone	Auto Pay Request on page 3179

Rejecting an Auto Pay Request

Prerequisites

To reject an auto pay request, you should have:

- At least one bill added to the auto pay request

Procedure

To reject an auto pay request:

1. Search for the auto pay request in the **Search Auto Pay Request** zone of the **Auto Pay Request** screen.
2. In the **Search Results** section, click the link in the **Auto Pay Request Information** column corresponding to the auto pay request which you want to reject.

The **Auto Pay Request** screen appears.

3. Ensure that the **Main** tab is selected.
4. Click the **Reject** button in the **Auto Pay Request** zone.

A message appears confirming whether you want to reject the auto pay request.

5. Click **OK**.

The auto pay request is rejected.

Note:

You can reject the auto pay request only in the **Approval In Progress** status.

You can reject the auto pay request only when the auto pay request is assigned to you for an approval.

The **Reject** button appears only when the auto pay request is in the **Approval In Progress** status.

Related Topics

For more information on...	See...
How to search for an auto pay request	Searching for an Auto Pay Request on page 3176
Auto Pay Request screen	Auto Pay Request (Used for Viewing) on page 3178
Auto Pay Request zone	Auto Pay Request on page 3179

Resubmitting an Auto Pay Request for Approval

Prerequisites

To resubmit an auto pay request, you should have:

- At least one bill added to the auto pay request

Procedure

To resubmit an auto pay request:

1. Search for the auto pay request in the **Search Auto Pay Request** zone of the **Auto Pay Request** screen.
2. In the **Search Results** section, click the link in the **Auto Pay Request Information** column corresponding to the auto pay request which you want to resubmit.

The **Auto Pay Request** screen appears.

3. Ensure that the **Main** tab is selected.
4. Click the **Resubmit** button in the **Auto Pay Request** zone.

A message appears confirming whether you want to resubmit the auto pay request.

5. Click **OK**.

The auto pay request is resubmitted.

Note:

At least one auto pay record is required for resubmitting the auto pay request.

The **Resubmit** button appears only when the auto pay request is in the **Approval In Progress** status.

Related Topics

For more information on...	See...
How to search for an auto pay request	Searching for an Auto Pay Request on page 3176
Auto Pay Request screen	Auto Pay Request (Used for Viewing) on page 3178
Auto Pay Request zone	Auto Pay Request on page 3179

Searching for a Bill

Prerequisites

To search for a bill in the search bills zone, you should have:

- Persons, Accounts, and Bills defined in the application

Procedure

To search for a bill in the search bills zone:

1. Search for the auto pay request in the **Search Auto Pay Request** zone of the **Auto Pay Request** screen.

A list of auto pay requests that meet the search criteria appears in the **Search Results** section.

2. In the **Search Results** section, click the link in the **Auto Pay Request Information** column corresponding to the auto pay request whose details you want to view.

The **Auto Pay Request** screen appears.

3. Ensure that the **Bills** tab is selected.

4. Search for the bills in the **Search Bills** zone of the **Auto Pay Request** screen.

A list of bills that meet the search criteria appears in the **Search Results** section.

Related Topics

For more information on...	See...
How to search for an auto pay request	Searching for an Auto Pay Request on page 3176
Auto Pay Request screen	Auto Pay Request (Used for Viewing) on page 3178
Search Bill zone	Search Bills on page 3182

Adding an Auto Pay Line Item in an Auto Pay Request

Prerequisites

To add an auto pay line item in an auto pay request, you should have:

- Bills defined in the application

Procedure

To add an auto pay line item in an auto pay request:

1. Search for the auto pay request in the **Search Auto Pay Request** zone of the **Auto Pay Request** screen.

A list of auto pay requests that meet the search criteria appears in the **Search Results** section.

2. In the **Search Results** section, click the link in the **Auto Pay Request Information** column corresponding to the auto pay request whose details you want to view.

The **Auto Pay Request** screen appears.

3. Ensure that the **Bills** tab is selected.

4. Search for the bills in the **Search Bills** zone of the **Auto Pay Request** screen.

5. Click **Search**.

A list of bills that meet the search criteria appears in the **Search Results** section.

6. Click the **Broadcast** () icon corresponding to the bill that you want to add in an auto pay request.

The **Auto Pay Line Items** zone appears.

7. Select the check box corresponding to the bill that you want to add in an auto pay request.
8. Click the **Add** button in the **Auto Pay Line Items** zone, to add the auto pay line item in an auto pay request.

Note:

The **Add** button appears only when the auto pay request is in the **Draft** status.

Related Topics

For more information on...	See...
How to search for an auto pay request	Searching for an Auto Pay Request on page 3176
Auto Pay Request screen	Auto Pay Request (Used for Viewing) on page 3178
Search Bills zone	Search Bills on page 3182
Auto Pay Line Items Zone	Auto Pay Line Items on page 3183

Deleting an Auto Pay Line Item from an Auto Pay Request**Prerequisites**

To delete an auto pay line item from an auto pay request, you should have:

- Bills added in the auto pay request

Procedure

To delete an auto pay line item from an auto pay request:

1. Search for the auto pay request in the **Search Auto Pay Request** zone of the **Auto Pay Request** screen.
A list of auto pay requests that meet the search criteria appears in the **Search Results** section.
2. In the **Search Results** section, click the link in the **Auto Pay Request Information** column corresponding to the auto pay request whose auto pay line items you want to delete.
The **Auto Pay Request** screen appears.
3. Ensure that the **Auto Pay Details** zone in the **Main** tab of **Auto Pay Request** screen is expanded.
A list of auto pay line appears in the **Auto Pay Details** zone.
4. Select the check box corresponding to the auto pay line item which you want to delete from the auto pay request.
5. Click the **Delete** button in the **Auto Pay Details** zone, to delete the auto pay line item from an auto pay request.
A message appears confirming whether you want to delete the auto pay line items from an auto pay request.
6. Click **OK**.
The auto pay line items is deleted.

Note:

At least one auto pay record is required for deleting the auto pay request.

The **Delete** button appears only when the auto pay request is in the **Draft** status.

Related Topics

For more information on...	See...
How to search for an auto pay request	Searching for an Auto Pay Request on page 3176

For more information on...	See...
Auto Pay Request screen	Auto Pay Request (Used for Viewing) on page 3178
Auto Pay Request zone	Auto Pay Request on page 3179
Auto Pay Line Items Zone	Auto Pay Line Items on page 3183

Editing the Auto Pay Line Item Details in an Auto Pay Request

Prerequisites

To edit an auto pay line item in an auto pay request, you should have:

- Bills added in the auto pay request

Procedure

To edit an auto pay line item from an auto pay request:

1. Search for the auto pay request in the **Search Auto Pay Request** zone of the **Auto Pay Request** screen.
A list of auto pay requests that meet the search criteria appears in the **Search Results** section.
2. In the **Search Results** section, click the link in the **Auto Pay Request Information** column corresponding to the auto pay request whose auto pay line items you want to delete.

The **Auto Pay Request** screen appears.

3. Ensure that the **Auto Pay Details** zone in the **Main** tab of **Auto Pay Request** screen is expanded.
A list of auto pay line appears in the **Auto Pay Details** zone.
4. Select the Check box corresponding to the auto pay line item which you want to edit.
5. Click the **Edit** button in the **Auto Pay Delete** zone, to edit the auto pay line item from an auto pay request.

On clicking **Edit** button, the **Edit Auto Pay Request Details** screen appears. It contains the following columns:

Column Name	Column Description	Mandatory (Yes or No)
Auto Pay ID	Displays the auto pay ID.	Not applicable
Account Number	Displays the account number.	Not applicable
Account ID	Displays the account ID.	Not applicable
Bill ID	Displays the bill ID.	Not applicable
Auto Pay Amount	Displays the amount of the automatic payment.	Not applicable
Schedule Extract Date	Used to specify date when you want to schedule the auto pay request for the auto pay line item.	Yes
Eligible For Extraction	Used to indicate whether the auto pay amount is debited from the account on a specified and scheduled extract date. The valid values are: <ul style="list-style-type: none"> • Yes • No 	Yes

6. Enter the required details in the **Edit Auto Pay Request Details** screen.
7. Click **Save**.

The auto pay line item is modified.

Note:

At least one auto pay record is required for deleting the auto pay request.

The **Edit** button appears only when the auto pay request is in the **Draft** status.

Related Topics

For more information on...	See...
How to search for an auto pay request	Searching for an Auto Pay Request on page 3176
Auto Pay Request screen	Auto Pay Request (Used for Viewing) on page 3178
Auto Pay Request zone	Auto Pay Request on page 3179
Auto Pay Line Items Zone	Auto Pay Line Items on page 3183

Viewing the Log of an Auto Pay Request

Procedure

To view the log of an auto pay request:

1. Search for the auto pay request in the **Search Auto Pay Request** zone of the **Auto Pay Request** screen.
2. In the **Search Results** section, click the link in the **Auto Pay Request Information** column corresponding to the auto pay request whose details you want to view.
The **Auto Pay Request** screen appears.
3. Click the **Log** tab.
The **Log** tab appears.
4. View the complete trail of actions performed on the auto pay request in the **Auto Pay Request Log** zone.

Related Topics

For more information on...	See...
How to search for an auto pay request	Searching for an Auto Pay Request on page 3176
Auto Pay Request screen	Auto Pay Request (Used for Viewing) on page 3178
Auto Pay Request Log zone	Auto Pay Request Log on page 3184
How to add a log entry for an auto pay request	Adding a Log Entry for an Auto Pay Request on page 3193

Adding a Log Entry for an Auto Pay Request

Procedure

To add a log entry for an auto pay request:

1. Search for the auto pay request in the **Search Auto Pay Request** zone of the **Auto Pay Request** screen.
2. In the **Search Results** section, click the link in the **Auto Pay Request Information** column corresponding to the auto pay request for which you want to add a log entry.
The **Auto Pay Request** screen appears.

3. Click the **Log** tab.

The **Log** tab appears.

4. Click the **Add Log Entry** link in the upper right corner of the **Auto Pay Request Log** zone.

The **Add Request Log** window appears. It contains the following fields:

Field Name	Field Description	Mandatory (Yes or No)
Auto Pay Request ID	Displays the auto pay request ID.	Not applicable
Log Details	Used to specify additional comments for the auto pay request.	Yes

5. Enter the comments in the **Log Details** field.

6. Click **Save**.

The log entry is added in the **Auto Pay Request Log** zone.

Related Topics

For more information on...	See...
How to search for an auto pay request	Searching for an Auto Pay Request on page 3176
Auto Pay Request screen	Auto Pay Request (Used for Viewing) on page 3178
Auto Pay Request Log zone	Auto Pay Request Log on page 3184

Chapter 46

Garbling Customer Information

Oracle Revenue Management and Billing enables you to garble the personal information of a customer, such as the customer name, address, email ID, social security number or any other identifier, birth date, gender, and so on. On receiving the data erasure request from a customer, the data controller will garble the personal information of the customer by masking the data with random characters and then cease the access to the customer records.

To garble the information of one or more persons, you need to do the following:

1. Define the **Garble Data (C1-GRBL)** characteristic for each person whose data needs to be garbled and set its value to **Y**.
2. Execute the **Garble Person Information (C1-GRBPI)** batch. For more information about this batch, see *Oracle Revenue Management and Billing Batch Guide*.

On executing the **Garble Person Information (C1-GRBPI)** batch, the system identifies the persons where the **Garble Data (C1-GRBL)** characteristic is set to **Y** and the **Garbling Completed (C1-GBCM)** characteristic is either not defined or set to **N**. Note that the system considers the **Garble Data (C1-GRBL)** characteristic value which is effective on the batch business date.

Once the persons are identified, the data in the following fields is masked with random characters across all records in the system:

- ACCOUNT_NBR
- ACCT_NBR
- ADDRESS1
- ADDRESS1_UPR
- ADDRESS2
- ADDRESS3
- ADDRESS4
- BIRTH_DT
- BROKER_NAME
- CITY
- COUNTRY
- COUNTY
- CUSTOMER_NAME
- EMAILID

- ENTITY_NAME
- ENTITY_NAME1
- ENTITY_NAME2
- ENTITY_NAME3
- GEO_CODE
- HOUSE_TYPE
- IN_CITY_LIMIT
- NAME1
- OVRD_MAIL_NAME1
- OVRD_MAIL_NAME2
- OVRD_MAIL_NAME3
- PER_ID_NBR
- PHONE
- POSTAL
- POSTAL_UPR
- STATE

In other words, the personal and account related information of a customer is garbled across the system. In addition, this batch allows you to garble the required characteristics and identifiers of a person and account.

Note: An account may have one or more persons linked to it. The information of an account is garbled when the data erasure request is received for the main customer of the account.

Once the personal and account related information of a customer is garbled, the access group of the person is changed to **C1GB** (which does not have any data access role). This ensures that the data of the person and his or her accounts cannot be accessed from any screens in the system. If an approval transaction contains personal and account related information of a customer, you cannot even view the approval transaction in the system.

Note: The access is forbidden for performing any transaction for the person and account only from the user interface and web services and not through the background process.

You can also garble the data of a person using the **C1-GRBPI** inbound web service. However, you can garble the data of only one person at a time using this inbound web service.

Chapter 47

Deleting Inactive Customer or Closed Account Information

Oracle Revenue Management and Billing enables you to delete all records of a person or account from the system. A new batch named **C1-GDPR** is introduced in this release. It enables you to delete all records of a person or account from the system. You can either delete the records of a particular person or account using its ID or delete the records of a set of persons or accounts at once using its characteristic. A new characteristic type named **C1-GDPRE** is shipped with the product. While executing the batch, the system first checks whether the person or account ID is specified in the batch. If so, the batch deletes the records of the respective person or account from the system. You cannot specify both the person and account ID at the same time while executing the batch.

If the person or account ID is not specified while executing the batch, the system checks whether the **Delete Characteristic Type** parameter is defined in the **C1-GDPR** batch. You can define the **C1-GDPRE** characteristic for the persons or accounts whose records you want to delete from the system. If you set the **Delete Characteristic Type** parameter in the **C1-GDPR** batch to **C1-GDPRE**, the batch considers those person or accounts for deletion where the **C1-GDPRE** characteristic is set to **Y**.

The system deletes all records of a particular account only when the following conditions are met:

- Account's closing date is earlier than or equal to system date
- All contracts of the account should either be in the **Closed** or **Canceled** status

The system deletes all records of a particular person only when the following conditions are met:

- The closing date of all its accounts is earlier than or equal to system date
- All contracts of all its accounts should either be in the **Closed** or **Canceled** status

The **C1-GDPR** batch contains the following parameters:

- **Account ID** – Used to indicate the account whose records you want to delete from the system.
- **Person ID** – Used to indicate the person whose records you want to delete from the system.
- **Delete Characteristic Type** – Used to specify the characteristic type. Here, you must specify the **C1-GDPRE** characteristic type. The system then considers those person or accounts for deletion where the **C1-GDPRE** characteristic is set to **Y**.

- **Clear CLOB Data** – Used to indicate whether you want to delete the references of the persons or accounts considered for deletion from the CLOB data. The valid values are **Y** and **N**. Note that if you set the value for this parameter to **Y**, the performance of the batch would be impacted when there is voluminous data.
- **Thread Pool Name** – Used to specify the thread pool on which you want to execute the batch.

The **C1-GDPR** batch is a multi-threaded batch. The multi-threading is based on the person or account **ID** and chunks for multi-threading are created based on numerical distribution of person or account **ID**.

Chapter 48

Retail Banking Product Management

Topics:

- [Prerequisites](#)
- [Product Status Transition](#)
- [Market Product Status Transition](#)
- [Offer Status Transition](#)
- [Bundle Status Transition](#)
- [Algorithms Used in C1_PRODUCT](#)
- [Algorithms Used in C1_MARKET_PRODUCT](#)
- [Algorithms Used in C1_OFFER](#)
- [Algorithms Used in C1_BUNDLE](#)
- [C1-APPTXNBAS](#)
- [C1-PRDINFO](#)
- [C1-PRDPSPR](#)
- [C1-PRDCT-VAL](#)
- [C1-PRD-TRN](#)
- [C1-MPINFO](#)
- [C1-MP-VAL](#)
- [F1-AT-RQJ](#)
- [C1-OFFRINFO](#)
- [C1-OFFER-VAL](#)
- [C1-BNDLINFO](#)
- [C1-BUNDL-VAL](#)
- [Product \(Used for Searching\)](#)
- [Product \(Used for Adding\)](#)
- [Market Product \(Used for Searching\)](#)

Oracle Revenue Management and Billing facilitates you to maintain and bill a variety of products and services for the retail banking domain. You can define the following types of products in the system:

- Product
- Product Group

As the name indicates, a product group is a group of products. A product group are maintained in the system mainly for the reporting purposes. You can define a product and product group which may belong to different product categories, such as Checking, Loans, Savings, etc. A product or product group must be associated with at least one division. You can associate a product or product group with more than one division.

The system enables you to add one or more product services in a product. A product service may include one or more services which are defined as price items in the system. You can define, edit, delete, and copy a product service using an existing screen named **Product Service**. You can add multiple product services in a product. The system enables you to indicate whether the product service is a mandatory or optional service offered with the product. A product must have at least one mandatory product service.

A product consists of one or more market products. For example, the Loan product can include different market products, such as Personal Loan, Auto Loan, Home Equity Loan, Education Loan, etc. An account can enroll for a market product. While creating a market product for a product, the system inherits the list of divisions and product services from the product. You can associate a market product with only those divisions to which the product belongs. By default, the market product includes the mandatory services of the product. You may or may not include the optional services of the product in the market product. You can define eligibility rules for a market product. The system executes the eligibility rule which is effective while enrolling an account for a market product. If the eligibility rule is met, the system enrolls the account for the market product. However, if the eligibility rule is not met, the system does not enroll the account for the market product. A market product must be associated with at least one price list. You can associate multiple price lists with a market product.

The system enables you to define an offer which can be included in more than one market product. For example, the Car Loan and Two-Wheeler Loan market products may provide same offers, such as No Processing Cost, No Collateral, etc. An account can enroll for an offer. While creating an offer, the system inherits the list of divisions and product services from all market products in which it is included. By default, the offer includes the mandatory services of the product. You may or may not include the optional services of the market product in the offer. You can define eligibility rules for an offer.

- [Market Product \(Used for Adding\)](#)
- [Offer \(Used for Searching\)](#)
- [Offer \(Used for Adding\)](#)
- [Bundle \(Used for Searching\)](#)
- [Bundle \(Used for Adding\)](#)

The system executes the eligibility rule which is effective while enrolling an account for an offer. If the eligibility rule is met, the system enrolls the account for the offer. However, if the eligibility rule is not met, the system does not enroll the account for the offer. An offer must be associated with at least one price list. You can associate multiple price lists with an offer.

The system enables you to define a bundle which can be included in more than one market product. For example, you can define a bundle of services, such as Car Loan, Loan Insurance, etc. in the Car Loan market product. An account can enroll for a bundle. While creating a bundle, the system derives the divisions which are common in all market products in which it is included. It also inherits the list of product services from all market products. By default, the bundle includes the mandatory services of the product. You may or may not include the optional services of the market product in the bundle. Here, you can include additional services which are not included in the product or market product. You can define eligibility rules for a bundle. The system executes the eligibility rule which is effective while enrolling an account for a bundle. If the eligibility rule is met, the system enrolls the account for the bundle. However, if the eligibility rule is not met, the system does not enroll the account for the bundle. A bundle must be associated with at least one price list. You can associate multiple price lists with a bundle.

A product, market product, offer, and bundle goes through a lifecycle in the system. On creating a product, market product, offer, and bundle, their status is set to **Draft**. On submitting a product, market product, offer, and bundle, their status is set to **Active**. A new batch named **C1-PDTRN** is introduced in this release. It transitions the status of a product, market product, offer, and bundle to **Retired** when its end date is earlier than the batch business date.

To implement this new feature, the following new screens are introduced in this release:

- Product
- Product Information
- Market Product
- Market Product Information
- Offer
- Offer Information
- Bundle
- Bundle Information

You can access these screens from the **Retail Banking** menu.

Prerequisites

To setup the retail banking feature, you need to do the following:

- Product Categories and Product Types define in the application.
- Define the Terms and Conditions in the application.
- Product Manager's To Do Roles define in the application.
- Divisions associated with the access group to which the user belongs.
- Characteristics Types defined in the application (where the characteristic entity is set to the product, market product, offer or bundle).
- Parent Groups define in the application.
- Product Services define in the application.
- Parameters and Parameter Value Types (based on which you want to define eligibility criteria of the market product) define in the application.
- Price Lists define in the application.

Product Status Transition

The following figure graphically indicates how the product moves from one status to another when the approval process is configured in the product:

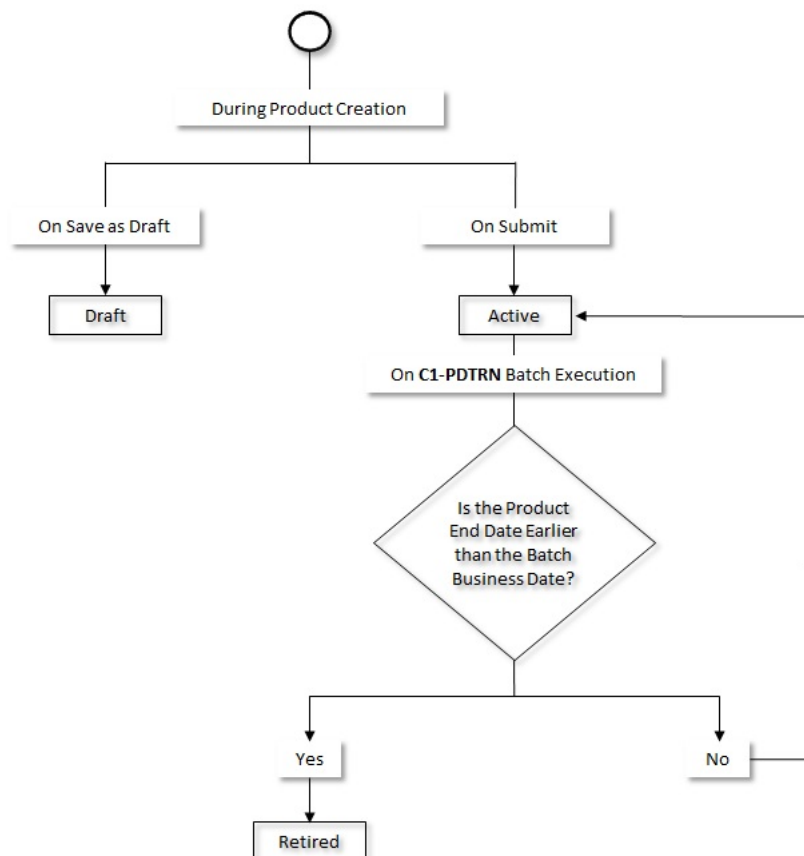

Market Product Status Transition

The following figure graphically indicates how the market product moves from one status to another when the approval process is configured in the market product:

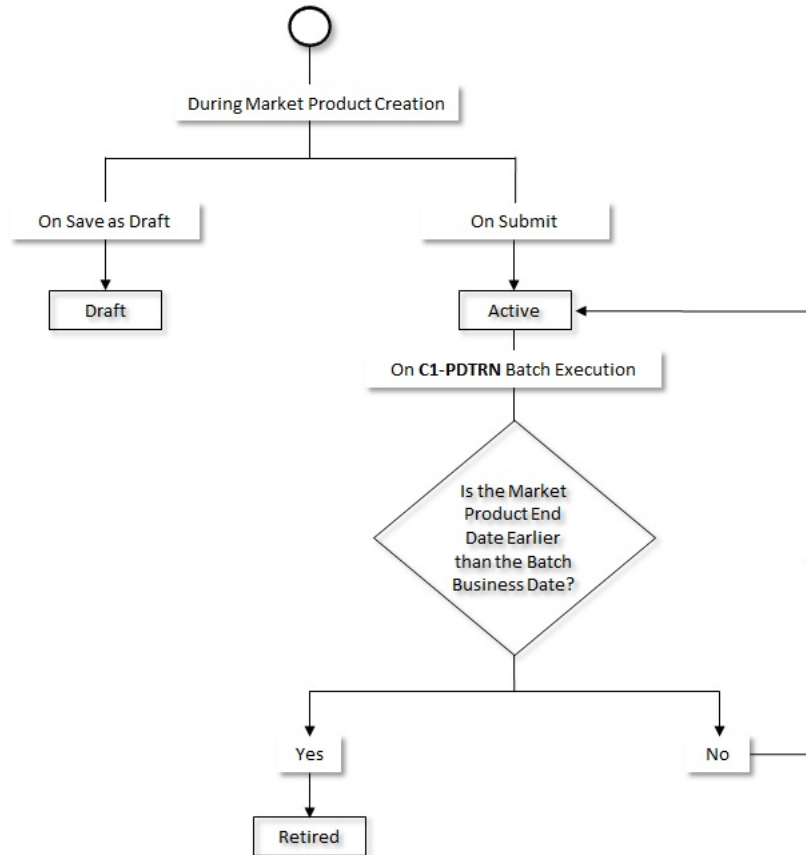

Offer Status Transition

The following figure graphically indicates how the offer moves from one status to another when the approval process is configured in the offer:

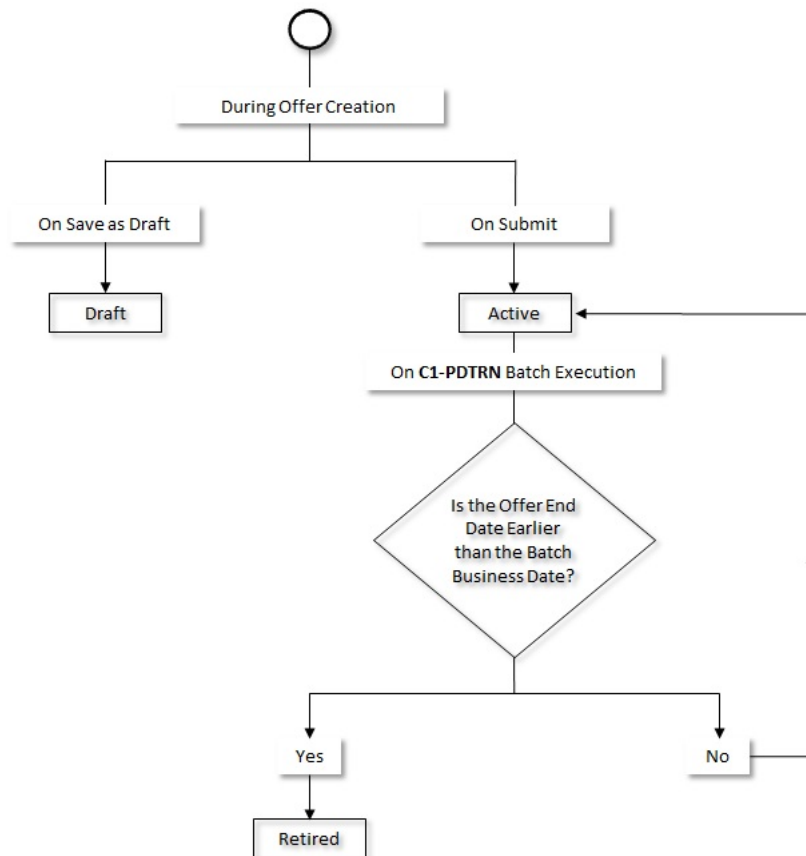

Bundle Status Transition

The following figure graphically indicates how the bundle moves from one status to another when the approval process is configured in the bundle:

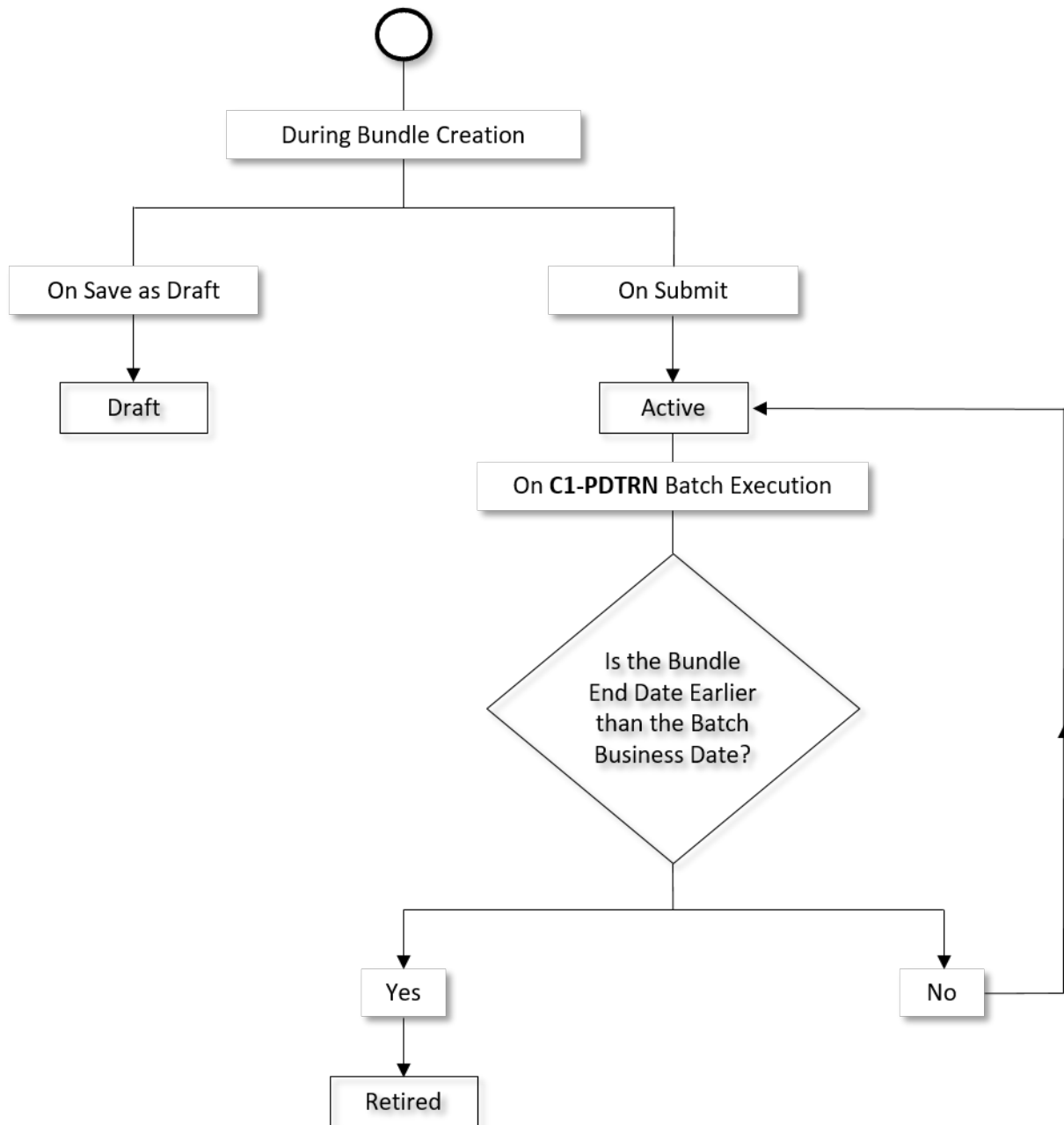

Algorithms Used in C1_PRODUCT

The following table lists the algorithms which are attached to the **C1_PRODUCT** business object:

System Event	Algorithm	Algorithm Type	Description
Audit	C1-APPTXNBAS	C1-APPTXNBAS	Refer to C1-APPTXNBAS on page 3206
Information	C1-PRDINFO	C1-PRDINFO	Refer to C1-PRDINFO on page 3206
Post-Processing	C1-PRDPSPR	C1-PRDPSPR	Refer to C1-PRDPSPR on page 3207

System Event	Algorithm	Algorithm Type	Description
Validation	C1-PRDCT-VAL	C1-PRDCT-VAL	Refer to C1-PRDCT-VAL on page 3207

The following table lists the algorithms which are used in the lifecycle of the **C1_PRODUCT** business object:

Status	System Event	Algorithm	Algorithm Type	Description
Draft	-	-	-	-
Active	Monitor	C1-PRD-TRN	C1-PRD-TRN	C1-PRD-TRN on page 3207
Retired	-	-	-	-

Algorithms Used in C1_MARKET_PRODUCT

The following table lists the algorithms which are attached to the **C1_MARKET_PRODUCT** business object:

System Event	Algorithm	Algorithm Type	Description
Information	C1-MPINFO	C1-PDINFO	Refer to C1-MPINFO on page 3207
Validation	C1-MP-VAL	C1-MP-VAL	Refer to C1-MP-VAL on page 3207

The following table lists the algorithms which are used in the lifecycle of the **C1_MARKET_PRODUCT** business object:

Status	System Event	Algorithm	Algorithm Type	Description
Draft	-	-	-	-
Active	Monitor	F1-AT-RQJ	F1-AT-RQJ	Refer to F1-AT-RQJ on page 3207
Retired	-	-	-	-

Algorithms Used in C1_OFFER

The following table lists the algorithm which is attached to the **C1_OFFER** business object:

System Event	Algorithm	Algorithm Type	Description
Information	C1-OFFRINFO	C1-PDINFO	Refer to C1-OFFRINFO on page 3208
Validation	C1-OFFER-VAL	C1-OFFER-VAL	Refer to C1-OFFER-VAL on page 3208

The following table lists the algorithms which are used in the lifecycle of the **C1_OFFER** business object:

Status	System Event	Algorithm	Algorithm Type	Description
Draft	-	-	-	-
Active	Monitor	F1-AT-RQJ	F1-GEN-BOMNJ	Refer to F1-AT-RQJ on page 3207
Retired	-	-	-	-

Algorithms Used in C1_BUNDLE

The following table lists the algorithms which are attached to the **C1_BUNDLE** business object:

System Event	Algorithm	Algorithm Type	Description
Information	C1-BNDLINFO	C1-PDINFO	Refer to C1-BNDLINFO on page 3208
Validation	C1-BUNDL-VAL	C1-BUNDL-VAL	Refer to C1-BUNDL-VAL on page 3208

The following table lists the algorithms which are used in the lifecycle of the **C1_BUNDLE** business object:

Status	System Event	Algorithm	Algorithm Type	Description
Draft	-	-	-	-
Active	Monitor	F1-AT-RQJ	F1-GEN-BOMNJ	Refer to F1-AT-RQJ on page 3207
Retired	-	-	-	-

C1-APPTXNBAS

The **C1-APPTXNBAS** is the standard audit algorithm used by approval workflow responsible for creating approval transactions. This algorithm is to be specified on the business object audit algorithm spot, for the business objects that are part of approval workflow groups.

Parameters: Approval Request Generation (Y/N) - Used to indicate whether the approval workflow request must be created when no changes are made while editing the object. If you set the value to **N**, the approval workflow request is not created when no changes are made while editing the object. However, if you leave this field blank or set the value to **Y**, the approval workflow request is created irrespective of whether any changes are made or not in the object.

C1-PRDINFO

The **C1-PRDINFO** algorithm generates the product information string. It concatenates the provided fields in the parameters, separated by the provided separator in the specified order. The eligible field parameters are listed below:

- PRODUCT_CD
- DESCR
- PROD_TYP_FLG
- PRODUCT_CAT_FLG

- BO_STATUS_CD
- START_DT
- END_DT
- PROD_MNGR
- PROD_MNGR_TD_ROLE
- TC_TYPE_CD

C1-PRDPSPR

Product Post Processing Algorithm.

C1-PRDCT-VAL

The **C1-PRDCT-VAL** algorithm validates the product before saving it to the database.

C1-PRD-TRN

The **C1-PRD-TRN** algorithm is responsible for monitoring the product end date. It transitions the status of a product, market product, offer, and bundle to **Retired** when its end date is earlier than the batch business date.

C1-MPINFO

The **C1-MPINFO** algorithm generates the market product, offer, and bundle information string. It concatenates the provided fields in the parameters, separated by the provided separator in the specified order: The eligible field parameters are listed below:

- ENTITY_CODE
- ENTITY_TYPE
- DESCR
- DESCRLONG
- START_DT
- END_DT
- TC_TYPE_CD
- BO_STATUS_CD
- PRODUCT_CD

C1-MP-VAL

The **C1-MP-VAL** algorithm validates the market product before saving it to the database.

F1-AT-RQJ

The **F1-AT-RQJ** algorithm type transitions the business object current state to the input **Next Status** or to the status related to the input **Next Transition Condition**. Either one but not both soft parameters may be specified. If both soft

parameters are not specified, the business object will be transitioned to the default next status specified in the lifecycle. Algorithms of this algorithm type may be defined for any business object status as its monitor algorithm.

C1-OFFRINFO

The **C1-OFFRINFO** algorithm generates the market product, offer, and bundle information string. It concatenates the provided fields in the parameters, separated by the provided separator in the specified order: The eligible field parameters are listed below:

- ENTITY_CODE
- ENTITY_TYPE
- DESCR
- DESCRLONG
- START_DT
- END_DT
- TC_TYPE_CD
- BO_STATUS_CD PRODUCT_CD

C1-OFFER-VAL

The **C1-OFFER-VAL** algorithm validates the offer before saving it to the database.

C1-BNDLINFO

The **C1-BNDLINFO** algorithm generates the market product, offer, and bundle information string. It concatenates the provided fields in the parameters, separated by the provided separator in the specified order: The eligible field parameters are listed below:

- ENTITY_CODE
- ENTITY_TYPE
- DESCR
- DESCRLONG
- START_DT
- END_DT
- TC_TYPE_CD
- BO_STATUS_CD PRODUCT_CD

C1-BUNDL-VAL

The **C1-BUNDL-VAL** algorithm validates the bundle before saving it to the database.

Product (Used for Searching)

The **Product** screen allows you to search for a product using various search criteria. It also allows you to add, edit, or copy an existing product. It contains the following zone:

- [Search Product](#) on page 3209

Related Topics

For more information on...	See...
How to search for a product	Searching for a Product on page 3210
How to add a product	Adding a Product on page 3217
How to edit the details of a product	Editing a Product on page 3211
How to copy a product	Copying a Product on page 3213

Search Product





The **Search Product** zone allows you to search for a product using various search criteria. It contains the two following sections:

- **Search Criteria** - The **Search Criteria** section contains the following fields:

Field Name	Field Description	Mandatory (Yes or No)
Search By	Used to indicate whether you want to search products which are added by you or search all the products available in the system. The valid values are: <ul style="list-style-type: none"> • My Products • All Products 	No
	Note: By default, the My Products option is selected.	
Product Code	Used to search for a particular product.	No
Product Type	Used to search products of a particular type.	No
Product Category	Used to search products which belong to a particular category.	No
Status	Used to search products having a particular status. The valid values are: <ul style="list-style-type: none"> • Active • Draft • Retired 	No
Start Date	Used to search products which are effective from a particular date onwards.	No
End Date	Used to search products which are effective till a particular date.	No

- **Search Results** - On clicking the **Search** button, the search results appear based on the specified search criteria. The **Search Results** section contains the following columns:

Column Name	Column Description
Product Information	Displays the concatenated string of information about the product separated by a comma (,).

Column Name	Column Description
Status	<p>Indicates the current status of the product. The valid values are:</p> <ul style="list-style-type: none"> Active Draft Retired <p>Note:</p> <p>If the product is in the active status, it is indicated by the Active ( Active) icon.</p> <p>If the product is in the draft status, it is indicated by the Draft ( Draft) icon.</p> <p>If the product is in the retired status, it is indicated by the Retired ( Retire) icon.</p>
Product Type	Indicates the type of the product.
Product Category	Indicates the category to which the product belongs.
Start Date	Displays the date from when the product is effective in the system.
End Date	Displays the date till when the product is effective in the system.
Copy	On clicking the Copy () icon, the Product Information screen appears where you can add a new product using an existing product.
Edit	On clicking the Edit () icon, the Product Information screen appears where you can edit the details of the existing product.

<p>Note:</p> <p>Pagination is used to display limited number of records in this zone. You can use the navigation links, such as Previous and Next to navigate between pages.</p> <p>By default, Search Results section lists all the products added by the user.</p>
--

Related Topics

For more information on...	See...
How to search for a product	Searching for a Product on page 3210
How to edit the details of a product	Editing a Product on page 3211
How to copy a product	Copying a Product on page 3213

Searching for a Product

Prerequisites

To search a product, you should have:

- Product defined in the application.

Procedure

To search a product:

1. Click the **Menu** link in the **Application** toolbar.

A list appears.

- From the **Main** menu, select **Retail Banking** and then click the **Product** sub-menu.

A sub-menu appears.

- Click the **Search** option from the **Product** sub-menu.

The **Product** screen appears.

- Enter the search criteria in the **Search Product** zone.

Note: ORMB search engine supports wildcard search, where you can substitute the percentage (%) symbol as a stand in for any word or letter in a search criteria. You can use the ‘%’ wildcard character in all input fields except the date and ID fields. The ‘%’ wildcard character is suffixed automatically at the end of the partial search criteria. Therefore, you may or may not specify the wildcard character at the end of the partial search criteria. However, you have to prefix the wildcard character manually wherever required.

- Click **Search** button.

A list of product that meet the search criteria appears in the **Search Results** section.

Note: Pagination is used to display limited number of records in the **Search Results** section. You can use the navigation links, such as **Previous** and **Next** to navigate between pages.

Related Topics

For more information on...	See...
Product Search Screen	Search Product on page 3209
How to add the product	Adding a Product on page 3217
How to copy the product	Copying a Product on page 3213
How to edit the product	Editing a Product on page 3211

Editing a Product

Procedure

To edit a product:

- Search for the product in the **Product** screen whose details you want to edit.
- In the **Search Results** section, click the **Edit** (✎) icon in the **Edit** column corresponding to the product whose details you want to edit.

The **Product Information** screen appears. It contains the following pages:

- [Product Information - Basic Details](#) on page 3215
- [Product Information - Other Details](#) on page 3216
- [Product Information - Services](#) on page 3217

The **Basic Details** page contains the following zone:

- [Basic Details](#)

The **Basic Details** zone contains the following fields:

Field Name	Field Description	Mandatory (Yes or No)
Product Category	Displays the category of the product.	Not applicable

Field Name	Field Description	Mandatory (Yes or No)
Product Code	Displays the product code.	Not applicable
Product Name	Used to specify the product.	Not applicable
Description	Used to specify the description of the product.	Yes
Product Type	Displays the product type.	Not applicable
Start Date	Displays the date from when the product is effective in the system.	Not applicable
End Date	Used to specify the date till when the product is effective in the system.	No
Terms and Conditions	Used to associate terms and conditions with the product.	No
	Note: The Search (🔍) appears corresponding to the Terms and Conditions field. On clicking the Search icon, the Terms and Conditions Search for Product window appears where you can associate the terms and conditions with the product.	
Product Manager	Used to assign the product to the product manager for the approval process.	No
	Note: The Search (🔍) icon appears corresponding to the Product Manager field. On clicking the Search icon, the User Search window appears where you can search for the user.	
Product Manager To Do Role	Used to specify the To Do role for the To Do task which is performed by the product manager.	No
	Note: The Search (🔍) icon appears corresponding to the Product Manager To Do Role field. On clicking the Search icon, the To Do Role Search window appears where you can search for the To Do role.	

3. Modify the required details in the **Basic Details** page.
4. Associate or disassociate the product from a division in the **Other Details** page, if required.
5. Add, edit, or remove the characteristics from the product in the **Other Details** page, if required.
6. Associate or disassociate the product from the parent group in the **Other Details** page, if required.
7. Add, edit, or remove services from the product in the **Services** page, if required.
8. Click **Submit**.

A window appears confirming the product is submitted in the system.

9. Click the **Close** button in the confirmation window.

The product is modified.

Related Topics

For more information on...	See...
How to search for a product	Searching for a Product on page 3210
Product screen	Search Product on page 3209
How to associate the product with a division	Associating the Product with a Division on page 3219
How to define a characteristic for the product	Defining a Characteristic for the Product on page 3220
How to associate the product to a parent group	Associating the Product to a Parent Group on page 3221
How to add a service for the product	Adding a Service for the Product on page 3221

Copying a Product

Instead of creating a product from scratch, you can create a new product using an existing product. This is possible through copying a product. On copying a product, the details including the associated divisions, characteristics, associated parent groups, and the services are copied to the new product. You can then edit the details, if required.

Prerequisites

To copy a product, you should have:

- Product (whose copy you want to create) defined in the application

Procedure

To copy a product:

1. Search for the product in the **Product** screen whose copy you want to create.
2. In the **Search Results** section, click the **Copy** (📄) icon in the **Copy** column corresponding to the product whose copy you want to create.

The **Product Information** screen appears. It contains the following pages:

- [Product Information - Basic Details](#) on page 3215
- [Product Information - Other Details](#) on page 3216
- [Product Information - Services](#) on page 3217

The **Basic Details** page contains the following zone:

- [Basic Details](#) on page 3215

The **Basic Details** zone contains the following fields:

Field Name	Field Description	Mandatory (Yes or No)
Product Category	Used to indicate the category of the product.	Yes
Product Code	Used to specify the product code.	Yes
Product Name	Used to specify the product.	Yes
Description	Used to specify the description for the product.	Yes
Product Type	Used to indicate the type of the product.	Yes
Start Date	Used to specify the date from when the product is effective.	Yes
End Date	Used to specify the date till when the product is effective.	No

Field Name	Field Description	Mandatory (Yes or No)
Terms and Conditions	Used to associate terms and conditions with the product.	No
	Note: The Search (🔍) appears corresponding to the Terms and Conditions field. On clicking the Search icon, the Terms and Conditions Search for Product window appears where you can associate the terms and conditions with the product.	
Product Manager	Used to assign the product to the product manager for the approval process.	No
	Note: The Search (🔍) icon appears corresponding to the Product Manager field. On clicking the Search icon, the User Search window appears where you can search for the user.	
Product Manager To Do Role	Used to specify the To Do role for the To Do task which is performed by the product manager.	No
	Note: The Search (🔍) icon appears corresponding to the Product Manager To Do Role field. On clicking the Search icon, the To Do Role Search window appears where you can search for the To Do role.	

3. Enter the required details in the **Basic Details** page.
4. Associate or disassociate the product from a division in the **Other Details** page, if required.
5. Add, edit, or remove the characteristics from the product in the **Other Details** page, if required.
6. Associate or disassociate the product from the parent group in the **Other Details** page, if required.
7. Add, edit, or remove services from the product in the **Services** page, if required.
8. Click **Submit**.

A window appears confirming the product is submitted in the system.

9. Click the **Close** button in the confirmation window.

The new product is added.

Related Topics

For more information on...	See...
How to search for a product	Searching for a Product on page 3210
Product screen	Search Product on page 3209
How to associate the product with a division	Associating the Product with a Division on page 3219
How to define a characteristic for the product	Defining a Characteristic for the Product on page 3220

For more information on...	See...
How to associate the product to a parent group	Associating the Product to a Parent Group on page 3221
How to add a service for the product	Adding a Service for the Product on page 3221

Product (Used for Adding)

The **Product Information** screen allows you to add a product using various search criteria. It also allows you to add and edit a product. It contains the following zone:

- [Basic Details](#) on page 3215

Related Topics

For more information on...	See...
How to add a product	Adding a Product on page 3217
How to associate the product with a division	Associating the Product with a Division on page 3219
How to define a characteristic for the product	Defining a Characteristic for the Product on page 3220
How to associate the product with a parent group	Associating the Product to a Parent Group on page 3221
How to add a service for the product	Adding a Service for the Product on page 3221

Product Information - Basic Details

The **Basic Details** page allows you view, add, and edit the basic details of the product. It contains the following zone:

- [Basic Details](#) on page 3215

Related Topics

For more information on...	See...
How to edit a product	Editing a Product on page 3211

Basic Details

The **Basic Details** zone allows you to view, add, and edit the basic information about the product. It contains the following fields:

Field Name	Field Description	Mandatory (Yes or No)
Product Category	Indicates the category of the product.	Yes
Product Code	Displays the product code.	Yes
Product Name	Displays the product.	Yes
Description	Displays the description of the product.	Yes
Product Type	Indicates the type of the product.	Yes
Start Date	Displays the date from when the product is effective in the system.	Yes
End Date	Displays the date till when the product is effective in the system.	No

Field Name	Field Description	Mandatory (Yes or No)
Terms and Conditions	Indicates the terms and conditions associated with the product.	No
Product Manager	Indicates the product manager to whom the product is assigned for the approval process.	No
Product Manager To Do Role	Indicates the To Do role for the To Do task which is performed by the product manager.	No

Related Topics

For more information on...	See...
How to edit a product	Editing a Product on page 3211

Product Information - Other Details

The **Other Details** page allows you to do the following:

- Associate the product with multiple divisions
- Define characteristics for the product
- Associate the product to a parent group

The **Other Details** page contains the following zone:

- [Other Details](#) on page 3216

Related Topics

For more information on...	See...
How to associate the product with a division	Associating the Product with a Division on page 3219
How to define a characteristic for the product	Defining a Characteristic for the Product on page 3220
How to associate the product to a parent group	Associating the Product to a Parent Group on page 3221

Other Details

The **Other Details** zone allows you to do the following:

- Associate or disassociate the product from a division
- Define, edit, or remove characteristics from the product
- Associate or disassociate the product from a parent group

The **Other Details** zone contains the following sections:

- **Divisions** - Used to associate or disassociate the product from a division.
- **Additional Attributes** - Used to define, edit, or remove characteristics from the product.
- **Parent Relationship** - Used to associate or disassociate the product from a parent group.

Related Topics

For more information on...	See...
How to associate the product with a division	Associating the Product with a Division on page 3219
How to define a characteristic for the product	Defining a Characteristic for the Product on page 3220

For more information on...	See...
How to associate the product to a parent group	Associating the Product to a Parent Group on page 3221

Product Information - Services

The **Services** page allows you to add services for the product. It contains the following zone:

- [Services](#) on page 3217

Related Topics

For more information on...	See...
How to add a service for the product	Adding a Service for the Product on page 3221

Services

The **Services** zone allows you to add, edit, or remove services from the product. It contains the following section:

- **Services** - Used to add, edit, or remove services from the product.

The **Services** contains the following fields in a grid:

Field Name	Field Description	Mandatory (Yes or No)
Product Service	Used to specify the service which you want to associate with the product. Note: The Search (🔍) appears corresponding to the Product Service field. On clicking the Search icon, the Product Service Search screen appears where you can search for the required service.	Yes
Description	Displays description of the product service.	Not applicable
Start Date	Displays the date from when the service is effective for the product.	Yes
End Date	Displays the date till when the service is effective for the product.	No
Mandatory	Indicates whether the service is mandatory or not.	No

Related Topics

For more information on...	See...
How to add a service for the product	Adding a Service for the Product on page 3221

Adding a Product

Prerequisites

To add a product, you should have:

- Product categories defined in the application.
- Product types defined in the application.

- Terms and conditions defined in the application.
- Product manager's To Do roles defined in the application.

Procedure

To add a product:

1. Click the **Menu** link in the **Application** toolbar.
A list appears.
2. From the **Main** menu, select **Retail Banking** and then click the **Product** sub-menu.
A sub-menu appears.
3. Click the **Add** option from the **Product** sub-menu.

The **Product Information** screen appears. It contains the following pages:

- [Product Information - Basic Details](#) on page 3215
- [Product Information - Other Details](#) on page 3216
- [Product Information - Services](#) on page 3217

The **Basic Details** page contains the following zone:

- [Basic Details](#) on page 3215

The **Basic Details** zone contains the following fields:

Field Name	Field Description	Mandatory (Yes or No)
Product Category	Used to indicate the category of the product.	Yes
Product Code	Used to specify the product code.	Yes
Product Name	Used to specify the product.	Yes
Description	Used to specify the description for the product.	Yes
Product Type	Used to indicate the type of the product.	Yes
Start Date	Used to specify the date from when the product is effective.	Yes
End Date	Used to specify the date till when the product is effective.	No
Terms and Conditions	Used to associate terms and conditions with the product. Note: The Search  appears corresponding to the Terms and Conditions field. On clicking the Search icon, the Terms and Conditions Search for Product window appears where you can associate the terms and conditions with the product.	No
Product Manager	Used to assign the product to the product manager for the approval process.	No

Field Name	Field Description	Mandatory (Yes or No)
	Note: The Search (🔍) icon appears corresponding to the Product Manager field. On clicking the Search icon, the User Search window appears where you can search for the user.	
Product Manager To Do Role	Used to specify the To Do role for the To Do task which is performed by the product manager. Note: The Search (🔍) icon appears corresponding to the Product Manager To Do Role field. On clicking the Search icon, the To Do Role Search window appears where you can search for the To Do role.	No

4. Enter the required details in the **Basic Details** page.
5. Associate the product with divisions in the **Other Details** page, if required.
6. Define characteristics for the product in the **Other Details** page, if required.
7. Associate the product to a parent group in the **Other Details** page, if required.
8. Add a service for the product in the **Services** page, if required.
9. Click **Submit**.

A window appears confirming the product is submitted in the system.

10. Click the **Close** button in the confirmation window.

The product is added.

Tip: Alternatively, you can access the **Product Information** screen by clicking the **Add Product** button in the **Page Title** area of the **Product** screen.

Related Topics

For more information on...	See...
Product Information screen	Product (Used for Adding) on page 3215
How to associate the product with a division	Associating the Product with a Division on page 3219
How to define a characteristic for the product	Defining a Characteristic for the Product on page 3220
How to associate the product to a parent group	Associating the Product to a Parent Group on page 3221
How to add a service for the product	Adding a Service for the Product on page 3221

Associating the Product with a Division

Prerequisites

To associate the product with a division, you should have:

- Product defined in the application.
- Divisions defined in the application.

Procedure

To associate the product with a division:

1. Ensure that the **Division** section is expanded in the **Other Details** zone of **Other Details** page when you are associating the product with a division.

The **Division** section contains various divisions.

2. Select the required divisions in the **Division** section, to associate with the product.
3. Click **Back** button, to go back to **Basic Details** page
4. Click **Save as Draft**, to save the product in the draft.
5. Click **Next**, to go to **Services** page.

The product is saved as draft in the application.

Related Topics

For more information on...	See...
Other Details Page	Product Information - Other Details on page 3216
Other Details Zone	Other Details on page 3216

Defining a Characteristic for the Product**Prerequisites**

To define a characteristic to the product, you should have:

- Product defined in the application.
- Characteristic type defined in the application.

Procedure

To define a characteristic type to the product:

1. Ensure that the **Additional Attributes** section is expanded in the **Other Details** zone of **Basic Details** page when you are defining the characteristic type to the product.

The **Additional Attributes** zone contains the following fields:

Field Name	Field Description	Mandatory (Yes or No)
Effective Date	Used to specify the date from when a characteristics type and characteristics value is effective.	Yes
Characteristics Type	Used to indicate the characteristic type.	Yes
Characteristics Value	Used to specify the value for the characteristic type.	Yes

2. Enter the required details in the **Additional Attributes** section.
3. Click **Save as Draft**, to save the product in the draft.
4. Click **Next**, to go to **Other Details** page.

The product is saved as draft in the application.

Related Topics

For more information on...	See...
Other Details Page	Product Information - Other Details on page 3216
Other Details Zone	Other Details on page 3216

Associating the Product to a Parent Group

Prerequisites

To associate the product with a parent group, you should have:

- Product group defined in the application.

Procedure

To associate the product with a parent group:

1. Ensure that the **Parent Relationship** section is expanded in the **Other Details** zone of **Other Details** page when you are associating the product with a parent group.

The **Parent Relationship** section contains following fields:

Field Name	Field Description	Mandatory (Yes or No)
Product Group	Used to associate a product group to the product.	No
Start Date	Used to specify the date from when the product is associated with product group.	No
End Date	Used to specify the date till when the product is associated with product group.	No

2. Select the required field in the **Parent Relationship** section, to associate the product with a parent group.
3. Click **Back** button, to go back to **Basic Details** page
4. Click **Save as Draft**, to save the product in the draft.
5. Click **Next**, to go to **Services** page.

The product is saved as draft in the application.

Related Topics

For more information on...	See...
Other Details Page	Product Information - Other Details on page 3216
Other Details Zone	Other Details on page 3216

Adding a Service for the Product

Prerequisites

To add a service to the product, you should have:

- Product service defined in the application.

Procedure

To add a service to the product:

1. Ensure that the **Services** section is expanded in the **Services** zone of **Services** page when you are add service to the product.

The **Services** zone contains the following fields:

Field Name	Field Description	Mandatory (Yes or No)
Product Service	Used to specify the date from when the service is effective.	No
Description	Used to describe service of the product.	Not applicable
Start Date	Used to specify the date from when the service define to the product.	No
End Date	Used to specify the date till when the service define to the product.	No
Mandatory	Used to specify the service is mandatory to the product or not.	No

2. Enter the required details in the **Services** section.
3. Click **Save as Draft**, to save the product in the draft.
4. Click **Submit**, to save the product.

Related Topics

For more information on...	See...
Services screen	Services on page 3217
How to add a product	Adding a Product on page 3217

Market Product (Used for Searching)

The **Market Product** screen allows you to search for a market product using various search criteria. It also allows you to add, edit, or copy an existing market product. It contains the following zone:

- [Search Market Product](#) on page 3222

Related Topics

For more information on...	See...
How to search for a market product	Searching for a Market Product on page 3224
How to add a market product	Adding a Market Product on page 3235
How to edit the details of a market product	Editing a Market Product on page 3225
How to copy a market product	Copying a Market Product on page 3227

Search Market Product

The **Search Market Product** zone allows you to search for a market product using various search criteria. It contains the two following sections:





- **Search Criteria** - The **Search Criteria** section contains the following fields:

Field Name	Field Description	Mandatory (Yes or No)
Search By	Used to indicate whether you want to search the market products which are added by you or	No

Field Name	Field Description	Mandatory (Yes or No)
	search all the market products available in the system. The valid value is: <ul style="list-style-type: none"> All Market Products 	
Market Product Code	Used to search for a particular market product.	No
Market Product Name	Used to search for market product having a particular name.	No
Product Code	Used to search market products which are associated to a particular product.	No
Product Name	Used to search market products which are associated to the products having a particular name.	No
Product Category	Used to search market products which belong to a particular product category. The valid values are: <ul style="list-style-type: none"> Checking Loans Others Savings 	No
Status	Used to search market products having a particular status. The valid values are: <ul style="list-style-type: none"> Active Draft Retired 	No
Product Group Code	Used to search market products which belong to a particular product group.	No
Product Group Name	Used to search market products which belong to product group having a particular name.	No
Start Date	Used to search market products which are effective from a particular date onwards.	No

- **Search Results** - On clicking the **Search** button, the search results appear based on the specified search criteria. The **Search Results** section contains the following fields:

Field Name	Field Description	Mandatory (Yes or No)
Market Product Information	Displays the concatenated string of information about the market product separated by a comma (,).	Not applicable
Start Date	Displays the date from when the market product is effective for the product in the system.	Not applicable
End Date	Displays the date till when the market product is effective for the product in the system.	Not applicable

Field Name	Field Description	Mandatory (Yes or No)
Product Category	Indicates the product category to which the market product belongs.	Not applicable
Product Information	Displays the concatenated string of information about the product separated by a comma (,).	Not applicable
Status	<p>Indicates the current status of the product. The valid values are:</p> <ul style="list-style-type: none"> Active Draft Retired <p>Note: If the market product is in the active status, it is indicated by the Active ( Active) icon. If the market product is in the draft status, it is indicated by the Draft ( Draft) icon. If the market product is in the retired status, it is indicated by the Retried ( Retire) icon.</p>	Not applicable
Copy	On clicking the Copy () icon, the Market Product screen appears where you can add a new market product using an existing market product.	No
Edit	On clicking the Edit () icon, the Market Product screen appears where you can edit the details of the existing market product.	No

Note: Pagination is used to display limited number of records in this zone. You can use the navigation links, such as **Previous** and **Next** to navigate between pages.

Related Topics

For more information on...	See...
How to search for a market product	Searching for a Market Product on page 3224
How to edit the details of a market product	Editing a Market Product on page 3225
How to copy a market product	Copying a Market Product on page 3227

Searching for a Market Product

Prerequisites

To search a market product, you should have:

- Market Product defined in the application.
- Product defined in the application.

- Product Group defined in the application.

Procedure

To search a market product:

1. Click the **Menu** link in the **Application** toolbar.
A list appears.
2. From the **Main** menu, select **Retail Banking** and then click the **Market Product** sub-menu.
A sub-menu appears.
3. Click the **Search** option from the **Market Product** sub-menu.
The **Market Product** screen appears.
4. Enter the search criteria in the **Search Market Product** zone.

Note: ORMB search engine supports wildcard search, where you can substitute the percentage (%) symbol as a stand in for any word or letter in a search criteria. You can use the ‘%’ wildcard character in all input fields except the date and ID fields. The ‘%’ wildcard character is suffixed automatically at the end of the partial search criteria. Therefore, you may or may not specify the wildcard character at the end of the partial search criteria. However, you have to prefix the wildcard character manually wherever required.

5. Click **Search** button.

A list of market product that meet the search criteria appears in the **Search Results** section.

Note: Pagination is used to display limited number of records in the **Search Results** section. You can use the navigation links, such as **Previous** and **Next** to navigate between pages.

Related Topics

For more information on...	See...
Market Product Search Screen	Search Market Product on page 3222
How to add a market product	Adding a Market Product on page 3235
How to copy a market product	Copying a Market Product on page 3227
How to edit a market product	Editing a Market Product on page 3225

Editing a Market Product

Procedure

To edit a market product:

1. Search for the market product in the **Market Product** screen whose details you want to edit.
2. In the **Search Results** section, click the **Edit** (✎) icon in the **Edit** column corresponding to the market product whose details you want to edit.

The **Market Product** screen appears. It contains the following pages:

- [Market Product Information - Basic Details](#) on page 3229
- [Market Product Information - Other Details](#) on page 3230
- [Market Product Information - Eligibility](#) on page 3231
- [Market Product Information - Services](#) on page 3233
- [Market Product Information - Price List](#) on page 3234

The **Basic Details** page contains the following zone:

- [Basic Details](#)

The **Basic Details** zone contains the following fields:

Field Name	Field Description	Mandatory (Yes or No)
Market Product Code	Displays the market product code.	Not applicable
Market Product Name	Displays the market product.	Not applicable
Description	Used to specify the description of the market product.	No
Start Date	Displays the date from when the market product is effective in the system.	Not applicable
End Date	Used to specify the date till when the market product is effective in the system.	No
Terms and Conditions	Used to associate terms and conditions with the market product.	No
	Note: The Search (🔍) appears corresponding to the Terms and Conditions field. On clicking the Search icon, the Terms and Conditions Search for Product window appears where you can associate the terms and conditions with the market product.	

3. Modify the required details in the **Basic Details** page.
4. Associate or disassociate the market product from a division in the **Other Details** page, if required.
5. Add, edit, or remove the characteristics from the market product in the **Other Details** page, if required.
6. Add, edit, or remove the eligibility rule from the market product in the **Eligibility** page, if required.
7. Add, edit, or remove the price list from the market product in the **Price List** page, if required.
8. Click **Submit**.

A window appears confirming the market product is submitted in the system.

9. Click the **Close** button in the confirmation window.

Note: You cannot edit fields from the **Services** page when a service is already associated to the product.

The market product is modified.

Related Topics

For more information on...	See...
How to search for a market product	Searching for a Market Product on page 3224
Market Product screen	Search Market Product on page 3222
How to associate the market product with a division	Associating the Market Product with a Division on page 3237
How to define a characteristic for the market product	Defining a Characteristic for the Market Product on page 3238

For more information on...	See...
How to define eligibility Criteria for the Market Product	Defining Eligibility Criteria for the Market Product on page 3239
How to add a service for the market product	Adding a Service for the Market Product on page 3241
How to associate a price list with the market product	Associating a Price List with the Market Product on page 3242

Copying a Market Product

Instead of creating a market product from scratch, you can create a new market product using an existing market product. This is possible through copying a market product. On copying a market product, the details including the associated divisions, characteristics, services, and the price list are copied to the new market product. You can then edit the details, if required.

Prerequisites

To copy a market product, you should have:

- Market Product (whose copy you want to create) defined in the application

Procedure

To copy a market product:

- Search for the market product in the **Market Product** screen whose copy you want to create.
- In the **Search Results** section, click the **Copy**  icon in the **Copy** column corresponding to the market product whose copy you want to create.

The **Market Product** screen appears. It contains the following pages:

- [Market Product Information - Basic Details](#) on page 3229
- [Market Product Information - Other Details](#) on page 3230
- [Market Product Information - Eligibility](#) on page 3231
- [Market Product Information - Services](#) on page 3233
- [Market Product Information - Price List](#) on page 3234

The **Basic Details** page contains the following zone:

- [Basic Details](#)

The **Basic Details** zone contains the following fields:

Field Name	Field Description	Mandatory (Yes or No)
Market Product Code	Used to specify the market product code.	Yes
Market Product Name	Used to specify the market product.	Yes
Description	Used to specify the description for the market product.	No
Start Date	Used to specify the date from when the market product is effective.	Yes
End Date	Used to specify the date till when the market product is effective.	No
Terms and Conditions	Used to associate terms and conditions with the market product.	No

Field Name	Field Description	Mandatory (Yes or No)
	Note: The Search  appears corresponding to the Terms and Conditions field. On clicking the Search icon, the Terms and Conditions Search for Product window appears where you can associate the terms and conditions with the market product.	

3. Enter the required details in the **Basic Details** page.
4. Associate or disassociate the market product from a division in the **Other Details** page, if required.
5. Add, edit, or remove the characteristics from the market product in the **Other Details** page, if required.
6. Add, edit, or remove the eligibility rule from the market product in the **Eligibility** page, if required
7. Add, edit, or remove the price list from the market product in the **Price List** page, if required
8. Click **Submit**.

A window appears confirming the market product is submitted in the system.

9. Click the **Close** button in the confirmation window.

Note: You cannot edit fields from the **Services** page when a service is already associated to the product.

The new market product is added.

Related Topics

For more information on...	See...
How to search for a market product	Searching for a Market Product on page 3224
Market Product screen	Search Market Product on page 3222
How to associate the market product with a division	Associating the Market Product with a Division on page 3237
How to define a characteristic for a market product	Defining a Characteristic for the Market Product on page 3238
How to define eligibility Criteria for the Market Product	Defining Eligibility Criteria for the Market Product on page 3239
How to add a service for the market product	Adding a Service for the Market Product on page 3241
How to associate a price list with the market product	Associating a Price List with the Market Product on page 3242

Market Product (Used for Adding)

The **Market Product Information** screen allows you to add a market product using various search criteria. It also allows you to add and edit a market product. It contains the following zone:

- [Basic Details](#) on page 3215

Related Topics

For more information on...	See...
How to add a market product	Adding a Market Product on page 3235
How to associate the market product with a division	Associating the Market Product with a Division on page 3237
How to define a characteristic for the market product	Defining a Characteristic for the Market Product on page 3238
How to define eligibility criteria for the market product	Defining Eligibility Criteria for the Market Product on page 3239
How to add a service for the market product	Adding a Service for the Market Product on page 3241
How to associate a price list with the market product	Associating a Price List with the Market Product on page 3242

Market Product Information - Basic Details

The **Basic Details** page allows you add, edit, and view the basic details of the market product. It contains the following zones:

- [Basic Details](#) on page 3230
- [Search Product](#) on page 3229

Related Topics

For more information on...	See...
How to edit a market product	Editing a Market Product on page 3225

Search Product

The **Search Product** zone allows you to search and add the product. It contains the following fields:

Field Name	Field Description	Mandatory (Yes or No)
Search By	Used to indicate the search value of the product.	Not applicable
	Note: The default value is Product Search .	
Product Name	Displays the product.	No
Description	Displays the description of the product.	No
Product Category	Displays the category of the product.	No
Product Type	Displays the type of the product.	Not applicable

Related Topics

For more information on...	See...
Market Product screen	Search Market Product on page 3222
How to associate the market product with a division	Associating the Market Product with a Division on page 3237
How to define a characteristic for the market product	Defining a Characteristic for the Market Product on page 3238

For more information on...	See...
How to define eligibility Criteria for the Market Product	Defining Eligibility Criteria for the Market Product on page 3239
How to add a service for the market product	Adding a Service for the Market Product on page 3241
How to associate a price list with the market product	Associating a Price List with the Market Product on page 3242

Basic Details

The **Basic Details** zone allows you to view, add, and edit the basic information about the market product. It contains the following fields:

Field Name	Field Description	Mandatory (Yes or No)
Market Product Code	Displays the market product code.	Yes
Market Product Name	Displays the market product.	Yes
Description	Displays the description of the market product.	No
Start Date	Displays the date from when the market product is effective.	Yes
End Date	Displays the date till when the market product is effective.	No
Terms and Conditions	Indicates the terms and conditions associated with the market product.	No

Related Topics

For more information on...	See...
How to edit a market product	Editing a Market Product on page 3225

Market Product Information - Other Details

The **Other Details** page allows you to do the following:

- Associate the market product with multiple divisions
- Define characteristics for the market product
- Associate the market product to a parent group

The **Other Details** page contains the following zone:

- [Market Product Information - Other Details](#) on page 3230

For more information on...	See...
How to associate the market product with a division	Associating the Market Product with a Division on page 3237
How to define a characteristic for the market product	Defining a Characteristic for the Market Product on page 3238

Other Details

The **Other Details** zone allows you to do the following:

- Associate or disassociate the market product from a division
- Define, edit, or remove characteristics from the market product

The **Other Details** zone contains the following sections:

- **Divisions** - Used to associate or disassociate the market product from a division.
- **Additional Attributes** - Used to define, edit, or remove characteristics from the market product.
- **Parent Relationship** - Used to associate or disassociate the market product from a parent group.

Related Topics

For more information on...	See...
How to associate the market product with a division	Associating the Market Product with a Division on page 3237
How to define a characteristic for the market product	Defining a Characteristic for the Market Product on page 3238

Market Product Information - Eligibility

The **Eligibility** page allows you to add, view, and edit eligibility rule for the market product. It contains the following zone:

- [Eligibility](#) on page 3231

Related Topics

For more information on...	See...
How to define eligibility criteria for the market product	Defining Eligibility Criteria for the Market Product on page 3239

Eligibility

The **Eligibility** zone allows you to define, add, view, or edit the eligibility criteria from the market product. It contains the following section:

- **Eligibility** - Used to add, view, or edit the eligibility criteria from the market product.

The **Eligibility** zone contains the following fields in a grid:

Field Name	Field Description	Mandatory (Yes or No)
Eligibility Rule	Displays the eligibility rule of the market product.	Yes
Start Date	Displays the date from when the eligibility rule is effective for the market product.	Yes
End Date	Displays the date till when the eligibility rule is effective for the market product.	No
Parameter	Used to search the parameter which you want to associate with the eligibility rule. Note: The Search (🔍) appears corresponding to the fields. On clicking the Search icon, the Parameter Search window appears where you can search for the required parameter.	Yes

Field Name	Field Description	Mandatory (Yes or No)
Operator	Displays the relational operator to define the relation between the parameter name and value.	Yes
Parameter Value Type	Indicates the parameter value against which you want to compare the parameter. The valid values are: <ul style="list-style-type: none"> • Parameter • Value 	Yes
Parameter	Used to search the parameter (on the right hand side) against which you want to compare the parameter (on the left hand side). <p>Note: The Search (🔍) appears corresponding to the fields. On clicking the Search icon, the Parameter Search window appears where you can search for the required parameter.</p>	Yes
Is True	Indicates what happens when the condition is true (satisfied). The valid values are: <ul style="list-style-type: none"> • Check Next Condition - Indicates that the condition with consecutive sequence number should be executed. • Rule Is False- Indicates that the action specified in the Rule False Action field should be executed. • Rule Is True - Indicates that the action specified in the Rule True Action field should be executed. 	Yes
Is False	Indicates what happens when the condition is false (not satisfied). The valid values are: <ul style="list-style-type: none"> • Check Next Condition - Indicates that the condition with consecutive sequence number should be executed. • Rule Is False - Indicates that the action specified in the Rule False Action field should be executed. • Rule Is True - Indicates that the action specified in the Rule True Action field should be executed. 	Yes
Is Sufficient	Indicates what happens when the data is insufficient. The valid values are: <ul style="list-style-type: none"> • Check Next Condition - Indicates that the condition with consecutive sequence number should be executed. • Rule Is False - Indicates that the action specified in the Rule False Action field should be executed. 	Yes

Field Name	Field Description	Mandatory (Yes or No)
	<ul style="list-style-type: none"> Rule Is True - Indicates that the action specified in the Rule True Action field should be executed. 	

The **Eligibility** zone contains the **Eligibility Rules** table which contain following columns:

Field Name	Field Description	Mandatory (Yes or No)
Eligibility Rule	Displays eligibility rule of the market product.	Not applicable
Start Date	Displays the date from when the eligibility rule is effective for the market product.	Not applicable
End Date	Displays the date till when the eligibility rule is effective for the market product.	Not applicable

Related Topics

For more information on...	See...
How to define eligibility criteria for the market product	Defining Eligibility Criteria for the Market Product on page 3239

Market Product Information - Services

The **Services** page allows you to add services for the market product. It contains the following zone:

- [Market Product Information - Services](#) on page 3233

Related Topics

For more information on...	See...
How to add service for the market product	Adding a Service for the Market Product on page 3241

Services

The **Services** zone allows you to add, edit, or remove services from the market product. It contain the following section:

- Services** - Used to add, edit, or remove services from the market product.

The **Services** contains the following fields in a grid:

Field Name	Field Description	Mandatory (Yes or No)
Product Service	Displays the market product service.	Not applicable
Description	Displays description of the product service.	Not applicable
Start Date	Displays the date from when the service is effective for the market product.	Not applicable
End Date	Displays the date till when the service is effective for the market product.	Not applicable
Mandatory	Indicates whether the service is mandatory or not.	Not applicable
Mandatory Services	Displays the services associated with the selected product.	Not applicable

Field Name	Field Description	Mandatory (Yes or No)
Optional Services	Displays optional services to add for the market product.	No

Related Topics

For more information on...	See...
How to add a service for the market product	Adding a Service for the Market Product on page 3241

Market Product Information - Price List

The **Price List** page allows you to add, view, edit, and associate price list for the market product. It contains the following zone:

- [Price List](#) on page 3234

Related Topics

For more information on...	See...
How to associate a price list with the market product	Associating a Price List with the Market Product on page 3242

Price List

The **Price List** page allows you to search, add, view, edit, and associate a price list for the market product. It contains the following zone:

- **Price List** - Used to search, add, view, edit, and associate the price list to the market product.

The **Price List** zone contains the following fields in a grid:

Field Name	Field Description	Mandatory (Yes or No)
Price List ID and Name	Used to search the price list ID and name for the market product.	No
Start Date	Used to search the price list ID and name by date from when the price list is effective.	No
End Date	Used to search the price list ID and name by date till when the price list is effective.	No
Selected	Used to indicate whether the product price list is selected.	Yes
Price List ID and Name	Displays the list of price list ID and name of the product.	Not applicable
Start Date	Displays the list of date from when the price list is effective for the product.	Not applicable
End Date	Displays the list of date till when the price list is effective for the product.	Not applicable

The **Price List** zone contains the **Price List Added** table which contain following columns:

Column	Column Description
Priority	Used to define the priority of the price list.

Column	Column Description
Price List ID and Name	Displays the list of price list ID and name of the selected product.
Validity Period	Displays the period in date range or by number of days for which the price list is valid. It is used to calculate price list assignment validity end date while assigning the price list to the product. The valid values are: <ul style="list-style-type: none"> • Date Range • Number of Days

Related Topics

For more information on...	See...
How to associate a price list with the market product	Associating a Price List with the Market Product on page 3242

Adding a Market Product

Prerequisites

To add a market product, you should have:

- Product defined in the application.

Procedure

To add a market product:

1. Click the **Menu** link in the **Application** toolbar.
A list appears.
2. From the **Main** menu, select **Retail Banking** and then click the **Market Product** sub-menu.
A sub-menu appears.
3. Click the **Add** option from the **Market Product** sub-menu.

The **Market Product Information** screen appears. It contains the following pages:

- [Market Product Information - Basic Details](#) on page 3229
- [Market Product Information - Other Details](#) on page 3230
- [Market Product Information - Eligibility](#) on page 3231
- [Market Product Information - Services](#) on page 3233
- [Market Product Information - Price List](#) on page 3234

The **Basic Details** page contains the following zone:

- [Search Product](#)
- [Basic Details](#)

The **Search Product** zone contains the following fields:

Field Name	Field Description	Mandatory (Yes or No)
Search By	Used to indicate whether you want to search for product using product details. The valid value is:	Yes

Field Name	Field Description	Mandatory (Yes or No)
	Note: The default value is Product Details .	
Product Name	Used to specify the product.	No
Description	Used to specify the description for the product.	No
Product Category	Used to indicate the category of the product.	No
Product Type	Used to indicate the type of the product.	No

On clicking **Search** button, the search results appear based on the specified search criteria. The search results include product code, description, product category, product type, effective start date and effective end date that are associated with the product.

The **Search Results** section contains the following columns:

Column Name	Column Description
Product Code	Used to specify the product code.
Description	Used to specify the description for the product.
Product Category	Used to indicate the category of the product.
Product Type	Used to indicate the type of the product.
Start Date	Used to specify the date from when the product is effective.
End Date	Used to specify the date till when the product is effective.

Note: Pagination is used to display limited number of records in the **Search Results** section. You can use the navigation links, such as **Previous** and **Next** to navigate between pages.

- Select the required product from the search result.

Note: You cannot add more than one product to the market product.

- On clicking **Select and Proceed** button, the **Basic Details** page of **Market Product Information** screen appears.

The **Basic Details** zone contains the following fields:

Field Name	Field Description	Mandatory (Yes or No)
Market Product Code	Used to specify the market product code.	Yes
Market Product Name	Used to specify the market product.	Yes
Description	Used to specify the description for the market product.	No
Start Date	Used to specify the date from when the product is effective.	Yes
End Date	Used to specify the date till when the product is effective.	No
Terms and Conditions	Used to associate terms and conditions with the product.	No

Field Name	Field Description	Mandatory (Yes or No)
	Note: The Search  appears corresponding to the Terms and Conditions field. On clicking the Search icon, the Terms and Conditions Search for Product window appears where you can associate the terms and conditions with the product.	

6. Enter the required details in the **Basic Details** page.
7. Associate the market product with divisions in the **Other Details** page, if required.
8. Define characteristics for the market product in the **Other Details** page, if required.
9. Define and add eligibility rule and parameter for the market product in the **Eligibility** page, if required.
10. Add a service for the market product in the **Services** page, if required.
11. Search and select the price list for the market product in the **Price List** page, if required..
12. Click **Submit**.

A window appears confirming the market product is submitted in the system.

13. Click the **Close** button in the confirmation window.

The market product is added.

Tip: Alternatively, you can access the **Market Product Information** screen by clicking the **Add Market Product** button in the **Page Title** area of the **Market Product** screen.

Related Topics

For more information on...	See...
Market Product screen	Search Product on page 3229
How to associate the market product with a division	Associating the Market Product with a Division on page 3237
How to define a characteristic for the market product	Defining a Characteristic for the Market Product on page 3238
How to define eligibility Criteria for the Market Product	Defining Eligibility Criteria for the Market Product on page 3239
How to add a service for the market product	Adding a Service for the Market Product on page 3241
How to associate a price list with the market product	Associating a Price List with the Market Product on page 3242

Associating the Market Product with a Division

Prerequisites

To associate the market product with a division, you should have:

- Market product defined in the application.
- Division defined in the application.

Procedure

To associate the market product with a division:

1. Ensure that the **Division** section is expanded in the **Other Details** zone of **Other Details** page when you are associating the product or market product with a division.

The **Division** section contains divisions associated with the selected product or market product.

2. Select the required divisions in the **Division** section, to associate with the market product.
3. Click **Back** button, to go back to **Basic Details** page.
4. Click **Save as Draft**, to save the market product in the draft.
5. Click **Next**, to go to **Services** page.

The market product is saved as draft in the application.

Related Topics

For more information on...	See...
How to add a market product	Adding a Market Product on page 3235
Services zone	Services on page 3233

Defining a Characteristic for the Market Product

Prerequisites

To define a characteristic to a market product, you should have:

- Product defined in the application.
- Characteristic type defined in the application.

Procedure

To define characteristic type to the product:

1. Ensure that the **Additional Attributes** section is expanded in the **Other Details** zone of **Basic Details** page when you are defining characteristic type to the product.

The **Additional Attributes** zone contains the following fields:

Field Name	Field Description	Mandatory (Yes or No)
Effective Date	Used to specify the date from when the characteristics type and characteristics value is effective.	No
Characteristics Type	Used to associate a characteristics type to the product.	No
Characteristics Value	Used to assign a characteristics value to the product.	No

2. Enter the required details in the **Additional Attribute** section.
3. Click **Save as Draft**, to save the product in the draft.
4. Click **Next**, to go to **Other Details** page.

The product is saved as draft in the application.

Related Topics

For more information on...	See...
Other Details page	Market Product Information - Other Details on page 3230

For more information on...	See...
Other Details zone	<i>Other Details</i> on page 3230

Defining Eligibility Criteria for the Market Product

Prerequisites

To define eligibility criteria for the market product, you should have:

- Parameter defined in the application.

Procedure

To define eligibility criteria for the market product:

1. Ensure that the **Eligibility** zone is expanded in the **Eligibility** page when you are defining eligibility criteria for the market product.

The **Eligibility** zone contains the following fields:

Field Name	Field Description	Mandatory (Yes or No)
Eligibility Rule	Used to specify a eligibility rule for the market product.	Yes
Start Date	Used to specify the date from when the eligibility rule will be effective.	Yes
End Date	Used to specify the date till when the eligibility rule will be effective.	No
Parameter	Used to search the parameter which you want to associate with the eligibility rule. Note: The Search  appears corresponding to the fields. On clicking the Search icon, the Parameter Search window appears where you can search for the required parameter.	Yes
Operator	Used to specify the relational operator to define the relation between the parameter name and value.	Yes
Parameter Value Type	Used to indicate the parameter value against which you want to compare the parameter. The valid values are: <ul style="list-style-type: none"> • Parameter • Value 	Yes
Parameter	Used to search the parameter (on the right hand side) against which you want to compare the parameter (on the left hand side).	Yes

Field Name	Field Description	Mandatory (Yes or No)
	<p>Note: The Search (🔍) appears corresponding to the fields. On clicking the Search icon, the Parameter Search window appears where you can search for the required parameter.</p>	
Is True	<p>Used to indicate what happens when the condition is true (satisfied). The valid values are:</p> <ul style="list-style-type: none"> • Check Next Condition - Indicates that the condition with consecutive sequence number should be executed. • Rule Is False - Indicates that the action specified in the Rule False Action field should be executed. • Rule Is True - Indicates that the action specified in the Rule True Action field should be executed. 	Yes
Is False	<p>Used to indicate what happens when the condition is false (not satisfied). The valid values are:</p> <ul style="list-style-type: none"> • Check Next Condition - Indicates that the condition with consecutive sequence number should be executed. • Rule Is False - Indicates that the action specified in the Rule False Action field should be executed. • Rule Is True - Indicates that the action specified in the Rule True Action field should be executed. 	Yes
Is Sufficient	<p>Used to indicate what happens when the data is insufficient. The valid values are:</p> <ul style="list-style-type: none"> • Check Next Condition - Indicates that the condition with consecutive sequence number should be executed. • Rule Is False - Indicates that the action specified in the Rule False Action field should be executed. • Rule Is True - Indicates that the action specified in the Rule True Action field should be executed. 	Yes

The **Eligibility** zone contains the **Eligibility Rules** table which contain following columns:

Column	Column Description
Eligibility Rule	Displays eligibility rule of the market product.

Column	Column Description
Start Date	Displays the date from when the eligibility rule is effective.
End Date	Displays the date till when the eligibility rule is effective.

2. Enter the required details in the **Eligibility** zone.
3. Click **Save as Draft**, to save the market product in the draft.
4. Click **Next**, to go to **Services** page.

The market product is saved as draft in the application.

Related Topics

For more information on...	See...
Eligibility zone	Eligibility on page 3231
How to define eligibility criteria for the market product	Defining Eligibility Criteria for the Market Product on page 3239

Adding a Service for the Market Product

Prerequisites

To add a service to the market product, you should have:

- Product defined in the application.
- Service defined in the application.

Procedure

To add a service to the market product:

1. Ensure that the **Services** section is expanded in the **Services** zone of **Services** page when you are add service to the product.

The **Services** zone contains the following fields:

Field Name	Field Description	Mandatory (Yes or No)
Product Service	Used to specify the product service.	Not applicable
Description	Used to specify the description of the product service.	Not applicable
Start Date	Used to specify the date from when the product service is effective.	Not applicable
	Note: The product service end date cannot be earlier than the product service start date.	
End Date	Used to specify the date till when the product service is effective.	Not applicable
	Note: The product service end date cannot be earlier than the product service start date.	

Field Name	Field Description	Mandatory (Yes or No)
Mandatory Services	Displays the services associated with the selected product.	Not applicable
Optional Services	Used to add the service for the market product.	No

2. Enter the required details in the **Services** section.
3. Click **Save as Draft**, to save the product in the draft.
4. Click **Submit**, to save the product.

Related Topics

For more information on...	See...
Services screen	Services on page 3233
How to add a market product	Adding a Market Product on page 3235

Associating a Price List with the Market Product

Prerequisites

To associate the market product with a price list, you should have:

- Price list defined in the application.

Procedure

To associate the market product a with price list:

1. Ensure that the is **Price List** zone expanded in the of **Price List** page when you are associating the market product with the Price List.

The **Price List** zone contains **Search Price List** section.

The **Search Price List** section contains the following fields:

Field Name	Field Description	Mandatory (Yes or No)
Price List ID or Description	Used to indicate whether you want to search for a price list using the price list details.	Yes
Start Date	Used to specify the date from when the price list of the product is effective.	Yes
End Date	Used to specify the date till when the price list of the product is effective.	Yes

The **Search Results** section contains the following fields:

Field Name	Field Description	Mandatory (Yes or No)
Select	Used to indicate whether the price list is selected or not.	Yes
Price List ID and Description	Displays the price list id and name.	Not applicable
Start Date	Displays the date from when the price list of the product is effective.	Not applicable
End Date	Displays the date till when the price list of the product is effective.	Not applicable

2. Select the required price list in the grid, to associate with a market product.
3. Click **Back** button, to go back to **Services** page.
4. Click **Save as Draft**, to save the market product in the draft.
5. Click **Select and Proceed**, to go to **Price List Added** section. It contains the following fields in the grid:

Field Name	Field Description	Mandatory (Yes or No)
Priority	Indicates the order in which the assigned price list must be considered while determining the price item pricing for the market product.	Yes
Price List ID or Description	Used to indicate whether you want to search for a price list using the price list details.	Not applicable
Validity Period	Used to specify the period date range or number of days for which the price list is valid. It is used to calculate price list assignment validity end date while assigning the price list to the market product. The valid values are: <ul style="list-style-type: none"> • Date Range • Number of Days 	Yes

6. Add, edit or delete the required price list in the grid, to associate with a market product.
7. Click **Back** button, to go back to **Services** page.
8. Click **Save as Draft**, to save the market product in the draft.
The market product is saved as draft in the application.
9. Click **Submit**.
A window appears confirming the product is submitted in the system.
10. Click the **Close** button in the confirmation window.
The product is added.

Tip: Alternatively, you can access the **Market Product Information** screen by clicking the **Add Market Product** button in the **Page Title** area of the **Market Product** screen.

Related Topics

For more information on...	See...
How to add a market product	Adding a Market Product on page 3235
Price List zone	Price List on page 3234

Offer (Used for Searching)

The **Offer** screen allows you to search for an offer using various search criteria. It also allows you to add, edit, or copy an existing offer. It contains the following zone:

- [Search Offer](#) on page 3244

Related Topics

For more information on...	See...
How to search for an offer	Searching for an Offer on page 3245
How to add an offer	Adding an Offer on page 3256
How to edit an offer	Editing an Offer on page 3246
How to copy an offer	Copying an Offer on page 3248

Search Offer





The **Search Offer** zone allows you to search for an offer using various search criteria. It contains the two following sections:

- **Search Criteria** - The **Search Criteria** section contains the following fields:

Field Name	Field Description	Mandatory (Yes or No)
Search By	Used to indicate whether you want to search offers which are added by you or search all the offers available in the system. The valid value is: <ul style="list-style-type: none"> • All Offers <p>Note: By default, the All offers option is selected.</p>	Yes
Offer Code	Used to search for an offer of a particular code.	No
Offer Name	Used to search for a particular offer.	No
Market Product Code	Used to search for an offer of a particular market product code.	No
Market Product Name	Used to search for an offer of a particular market product.	No
Product Category	Used to search an offer which belong to a particular product category.	No
Status	Used to search an offer having a particular status. The valid values are: <ul style="list-style-type: none"> • Active • Draft • Retired 	No
Start Date	Used to search an offer which are effective from a particular date onwards.	No

- **Search Results** - On clicking the **Search** button, the search results appear based on the specified search criteria. The **Search Results** section contains the following columns:

Column Name	Column Description
Offer Information	Displays the concatenated string of information about an offer separated by a comma (,).
Start Date	Displays the date from when an offer is effective in the system.

Column Name	Column Description
End Date	Displays the date till when an offer is effective in the system.
Product Category	Indicates the category to which the product belongs.
Market Product Information	Displays the concatenated string of information about the market product separated by a comma (,).
Status	<p>Indicates the current status of an offer. The valid values are:</p> <ul style="list-style-type: none"> Active Draft Retired <p>Note:</p> <p>If an offer is in the active status, it is indicated by the Active ( Active) icon.</p> <p>If an offer is in the draft status, it is indicated by the Draft ( Draft) icon.</p> <p>If an offer is in the retired status, it is indicated by the Retired ( Retire) icon.</p>
Copy	On clicking the Copy () icon, the Offer Information screen appears where you can add a new offer using an existing offer.
Edit	On clicking the Edit () icon, the Offer Information screen appears where you can edit the details of the existing offer.

Note:

Pagination is used to display limited number of records in this zone. You can use the navigation links, such as **Previous** and **Next** to navigate between pages.

By default, **Search Results** section lists all the products added by the user.

Related Topics

For more information on...	See...
How to search for an Offer	Searching for an Offer on page 3245
How to edit the details of an offer	Editing an Offer on page 3246
How to copy an offer	Copying an Offer on page 3248

Searching for an Offer

Prerequisites

To search an offer, you should have:

- Offer defined in the application.

Procedure

To search an offer:

1. Click the **Menu** link in the **Application** toolbar.

A list appears.

- From the **Main** menu, select **Retail Banking** and then click the **Offer** sub-menu.
A sub-menu appears.
- Click the **Search** option from the **Offer** sub-menu.
The **Offer** screen appears.
- Enter the search criteria in the **Search Offer** zone.

Note: ORMB search engine supports wildcard search, where you can substitute the percentage (%) symbol as a stand in for any word or letter in a search criteria. You can use the ‘%’ wildcard character in all input fields except the date and ID fields. The ‘%’ wildcard character is suffixed automatically at the end of the partial search criteria. Therefore, you may or may not specify the wildcard character at the end of the partial search criteria. However, you have to prefix the wildcard character manually wherever required.

- Click **Search** button.
A list of offer that meet the search criteria appears in the **Search Results** section.

Note: Pagination is used to display limited number of records in the **Search Results** section. You can use the navigation links, such as **Previous** and **Next** to navigate between pages.

Related Topics

For more information on...	See...
Offer Screen	Search Offer on page 3244
How to add an offer	Adding an Offer on page 3256
How to copy an offer	Copying an Offer on page 3248
How to edit an offer	Editing an Offer on page 3246

Editing an Offer

Procedure

To edit an offer:

- Search for an offer in the **Offer** screen whose details you want to edit.
- In the **Search Results** section, click the **Edit** (✎) icon in the **Edit** column corresponding to an offer whose details you want to edit.

The **Offer Information** screen appears. It contains the following pages:

- [Offer Information - Basic Details](#) on page 3250
- [Offer Information - Other Details](#) on page 3251
- [Offer Information - Eligibility](#) on page 3252
- [Offer Information - Services](#) on page 3254
- [Offer Information - Price List](#) on page 3254

The **Basic Details** page contains the following zone:

- [Basic Details](#) on page 3250

The **Basic Details** zone contains the following fields:

Field Name	Field Description	Mandatory (Yes or No)
Offer Code	Displays the offer code.	Not applicable

Field Name	Field Description	Mandatory (Yes or No)
Offer Name	Used to specify the offer.	Not applicable
Description	Used to specify the description of the offer.	No
Start Date	Displays the date from when the market product is effective in the system.	Not applicable
End Date	Displays the date till when the market product is effective in the system.	Not applicable
Terms and Conditions	Used to associate terms and conditions with the offer.	No
	Note: The Search (🔍) appears corresponding to the Terms and Conditions field. On clicking the Search icon, the Terms and Conditions Search for Product window appears where you can associate the terms and conditions with the product.	
Market Product Name	Used to specify the market product.	No
	Note: The Search (🔍) appears corresponding to the Market Product Name field. On clicking the Search icon, the Search Market Product to Offer window appears where you can associate the market product with the offer.	
Product Category	Displays the product category.	Not applicable
Product Type	Displays the product type.	Not applicable
Product Name	Displays the concatenated string of information about the product separated by a comma (,).	Not applicable

3. Modify the required details in the **Basic Details** page.
4. Associate or disassociate the offer with a market product in the **Basic Details** page.
5. Associate or disassociate the offer from a division in the **Other Details** page, if required.
6. Add, edit, or remove the characteristics from the offer in the **Other Details** page, if required.
7. Add, edit, or remove the eligibility rule from the offer in the **Eligibility** page, if required.
8. Add, edit, or remove the services from the offer in the **Eligibility** page, if required.
9. Add, edit, or remove the price list from the offer in the **Price List** page, if required.
10. Click **Submit**.

A window appears confirming the offer is submitted in the system.

11. Click the **Close** button in the confirmation window.

Note: You cannot edit fields from the **Services** page when a service is already associated to an offer.

The offer is modified.

Related Topics

For more information on...	See...
How to search for an offer	Searching for an Offer on page 3245
Offer screen	Search Offer on page 3244
How to associate the offer with a market product	Associating the Offer with a Market Product on page 3257
How to associate the offer with a division	Associating the Offer with a Division on page 3258
How to define a characteristic for the offer	Defining a Characteristic for the Offer on page 3259
How to define eligibility Criteria for the offer	Defining Eligibility Criteria for the Offer on page 3259
How to add a service for an offer	Adding a Service for an Offer on page 3261
How to associate a price list with an offer	Associating a Price List with an Offer on page 3262

Copying an Offer

Instead of creating an offer from scratch, you can create a new offer using an existing offer. This is possible through copying an offer. On copying an offer, the details including the associated divisions, characteristics, services, and the price list are copied to the new offer. You can then edit the details, if required.

Prerequisites

To copy an offer, you should have:

- Offer(whose copy you want to create) defined in the application

Procedure

To copy an offer:

1. Search for an offer in the **Offer** screen whose copy you want to create.
2. In the **Search Results** section, click the **Copy** () icon in the **Copy** column corresponding to the offer whose copy you want to create.

The **Offer Information** screen appears. It contains the following pages:

- [Offer Information - Basic Details](#) on page 3250
- [Offer Information - Other Details](#) on page 3251
- [Offer Information - Eligibility](#) on page 3252
- [Offer Information - Services](#) on page 3254
- [Offer Information - Price List](#) on page 3254

The **Basic Details** page contains the following zone:

- [Basic Details](#) on page 3250

The **Basic Details** zone contains the following fields:

Field Name	Field Description	Mandatory (Yes or No)
Offer Code	Used to specify the offer code.	Yes
Offer Name	Used to specify the offer.	Yes
Description	Used to specify the description for the offer.	No
Start Date	Used to specify the date from when the offer is effective.	Yes

Field Name	Field Description	Mandatory (Yes or No)
End Date	Used to specify the date till when the offer is effective.	Yes
Terms and Conditions	Used to associate terms and conditions with the offer.	No
	Note: The Search (🔍) appears corresponding to the Terms and Conditions field. On clicking the Search icon, the Terms and Conditions Search for Product window appears where you can associate the terms and conditions with the offer.	

The **Basic Details** zone contains the **Add Market Products** section. This section contains following fields:

Field Name	Field Description	Mandatory (Yes or No)
Market Product Name	Used to indicate the search value of the market product name.	No
	Note: The Search (🔍) appears corresponding to the Market Product Name field. On clicking the Search icon, the window appears where you can associate the terms and conditions with the product.	
Product Category	Displays the product category associated with the selected market product.	Not applicable
Product Type	Displays the product type associated with the selected market product.	Not applicable
Product Name	Displays the product associated with the selected market product.	Not applicable

3. Enter the required details in the **Basic Details** page.
4. Associate or disassociate the offer with a market product in the **Basic Details** page.
5. Associate or disassociate the offer from a division in the **Other Details** page, if required.
6. Add, edit, or remove the characteristics from the offer in the **Other Details** page, if required.
7. Add, edit, or remove the eligibility rule from the offer in the **Eligibility** page, if required
8. Add, edit, or remove the services from the offer in the **Eligibility** page, if required
9. Add, edit, or remove the price list from the offer in the **Price List** page, if required
10. Click **Submit**.

A window appears confirming the offer is submitted in the system.

11. Click the **Close** button in the confirmation window.

Note: You cannot edit fields from the **Services** page when a service is already associated to the product.

The new offer is added.

Related Topics

For more information on...	See...
How to search for an offer	Searching for an Offer on page 3245
Offer screen	Search Offer on page 3244
How to associate the offer with a market product	Associating the Offer with a Market Product on page 3257
How to associate the offer with a division	Associating the Offer with a Division on page 3258
How to define a characteristic for the offer	Defining a Characteristic for the Offer on page 3259
How to define eligibility Criteria for the offer	Defining Eligibility Criteria for the Offer on page 3259
How to add a service for an offer	Adding a Service for an Offer on page 3261
How to associate a price list with an offer	Associating a Price List with an Offer on page 3262

Offer (Used for Adding)

The **Offer Information** screen allows you to add an offer using various search criteria. It also allows you to add and edit an offer. It contains the following zone:

- [Basic Details link](#)

Related Topics

For more information on...	See...
How to add an offer	Adding an Offer on page 3256
How to associate the offer with a market product	Associating the Offer with a Market Product on page 3257
How to associate the offer with a division	Associating the Offer with a Division on page 3258
How to define a characteristic for the offer	Defining a Characteristic for the Offer on page 3259
How to define eligibility Criteria for the offer	Defining Eligibility Criteria for the Offer on page 3259
How to add a service for an offer	Adding a Service for an Offer on page 3261
How to associate a price list with an offer	Associating a Price List with an Offer on page 3262

Offer Information - Basic Details

The **Basic Details** page allows you add, edit, and view the basic details of an offer. It contains the following zone:

- [Basic Details](#) on page 3250

Related Topics

For more information on...	See...
How to edit an offer	Editing an Offer on page 3246

Basic Details

The **Basic Details** zone allows you to view, add, and edit the basic information about the offer. It contains the following fields:

Field Name	Field Description	Mandatory (Yes or No)
Offer Code	Displays the offer code.	Yes

Field Name	Field Description	Mandatory (Yes or No)
Offer Name	Displays the offer.	Yes
Description	Displays the description of an offer.	No
Start Date	Displays the date from when an offer is effective.	Yes
End Date	Displays the date till when an offer is effective.	Yes
Terms and Conditions	Indicates the terms and conditions associated with an offer.	No

The **Basic Details** zone contain the **Add Market Products** section. It contains the following fields:

Field Name	Field Description	Mandatory (Yes or No)
Market Product Name	Used to specify the market product. Note: The Search (🔍) appears corresponding to the Market Product Name field. On clicking the Search icon, the Search Market Product to Offer window appears where you can associate the market product with the offer.	Yes
Product Category	Displays the product category to which the product belongs.	Not applicable
Product Type	Displays the product type to which the product belongs.	Not applicable
Product Name	Displays the concatenated string of information about the product separated by a comma (,).	Not applicable

Related Topics

For more information on...	See...
How to edit an offer	Editing an Offer on page 3246

Offer Information - Other Details

The **Other Details** page allows you to do the following:

- Associate the offer with multiple divisions
- Define characteristics for the offer

The **Other Details** page contains the following zone:

- [Other Details](#) on page 3251

For more information on...	See...
How to associate the offer with a division	Associating the Offer with a Division on page 3258
How to define a characteristic for the offer	Defining a Characteristic for the Offer on page 3259

Other Details

The **Other Details** zone allows you to do the following:

- Associate or disassociate the offer from a division

- Define, edit, or remove characteristics from the offer

The **Other Details** zone contains the following sections:

- **Divisions** - Used to associate or disassociate the offer from a division.
- **Additional Attributes** - Used to define, edit, or remove characteristics from the offer.

Related Topics

For more information on...	See...
How to associate the offer with a division	Associating the Offer with a Division on page 3258
How to define a characteristic for the offer	Defining a Characteristic for the Offer on page 3259

Offer Information - Eligibility

The **Eligibility** page allows you to add, view, and edit eligibility rule for the offer. It contains the following zone:

- [Eligibility](#) on page 3252

Related Topics

For more information on...	See...
How to define eligibility criteria for the offer	Defining Eligibility Criteria for the Offer on page 3259

Eligibility

The **Eligibility** zone allows you to define, add, view, or edit the eligibility criteria for the offer. It contain the following section:

- **Eligibility** - Used to add, view, or edit the eligibility criteria for the offer.

The **Eligibility** zone contains the following fields in a grid:

Field Name	Field Description	Mandatory (Yes or No)
Eligibility Rule	Displays the eligibility rule.	Yes
Start Date	Displays the date from when the eligibility rule is effective for the offer.	Yes
End Date	Displays the date till when the eligibility rule is effective for the offer.	No
Parameter	Used to search the parameter which you want to associate with the eligibility rule. Note: The Search (🔍) appears corresponding to the fields. On clicking the Search icon, the Parameter Search window appears where you can search for the required parameter.	Yes
Operator	Displays the relational operator to define the relation between the parameter name and value.	Yes
Parameter Value Type	Indicates the parameter value against which you want to compare the parameter. The valid values are: <ul style="list-style-type: none"> • Parameter 	Yes

Field Name	Field Description	Mandatory (Yes or No)
	<ul style="list-style-type: none"> Value 	
Parameter	<p>Used to search the parameter (on the right hand side) against which you want to compare the parameter (on the left hand side).</p> <p>Note: The Search (🔍) appears corresponding to the fields. On clicking the Search icon, the Parameter Search window appears where you can search for the required parameter.</p>	Yes
Is True	<p>Indicates what happens when the condition is true (satisfied). The valid values are:</p> <ul style="list-style-type: none"> Check Next Condition - Indicates that the condition with consecutive sequence number should be executed. Rule Is False - Indicates that the action specified in the Rule False Action field should be executed. Rule Is True - Indicates that the action specified in the Rule True Action field should be executed. 	Yes
Is False	<p>Indicates what happens when the condition is false (not satisfied). The valid values are:</p> <ul style="list-style-type: none"> Check Next Condition - Indicates that the condition with consecutive sequence number should be executed. Rule Is False - Indicates that the action specified in the Rule False Action field should be executed. Rule Is True - Indicates that the action specified in the Rule True Action field should be executed. 	Yes
Is Insufficient	<p>Indicates what happens when the data is insufficient. The valid values are:</p> <ul style="list-style-type: none"> Check Next Condition - Indicates that the condition with consecutive sequence number should be executed. Rule Is False - Indicates that the action specified in the Rule False Action field should be executed. Rule Is True - Indicates that the action specified in the Rule True Action field should be executed. 	Yes

The **Eligibility** zone contains the **Eligibility Rules** section which contain following fields:

Field Name	Field Description	Mandatory (Yes or No)
Eligibility Rule	Displays eligibility rule of the offer.	Not applicable
Start Date	Displays the date from when the eligibility rule is effective for the offer.	Not applicable
End Date	Displays the date till when the eligibility rule is effective for the offer.	Not applicable

Related Topics

For more information on...	See...
How to define eligibility criteria for the offer	Defining Eligibility Criteria for the Offer on page 3259

Offer Information - Services

The **Services** page allows you to add services for the offer. It contains the following zone:

- [Services](#) on page 3254

Related Topics

For more information on...	See...
How to add service for an offer	Adding a Service for an Offer on page 3261

Services

The **Services** zone allows you to add, edit, or remove services for the offer. It contains the following section:

- **Services** - Used to add, edit, or remove services for the offer.

The **Services** contains the following fields in a grid:

Field Name	Field Description	Mandatory (Yes or No)
Product Service	Displays the market product service.	Not applicable
Description	Displays description of the market product service.	Not applicable
Start Date	Displays the date from when the service is effective.	Not applicable
End Date	Displays the date till when the service is effective.	Not applicable
Mandatory Services	Displays the services associated with the selected market product.	Not applicable
Optional Services	Displays optional services to add for the offer.	No

Related Topics

For more information on...	See...
How to add a service for an offer	Adding a Service for an Offer on page 3261

Offer Information - Price List

The **Price List** page allows you to add, view, edit, and associate price list for the offer. It contains the following zone:

- [Price List](#) on page 3255

Related Topics

For more information on...	See...
How to associate a price list with an offer	Associating a Price List with an Offer on page 3262

Price List

The **Price List** page allows you to search, associate, add, view, and edit price list for the offer. It contains the following zone:

- **Price List** - Used to search, associate, add, view, or edit the price list to the offer.

The **Price List** zone contains the following fields in a grid:

Field Name	Field Description	Mandatory (Yes or No)
Price List ID or Description	Used to search the price list for the offer.	No
Start Date	Used to search the price list by date from when the price list is effective.	No
End Date	Used to search the price list by date till when the price list is effective.	No

The **Search Results** section contains the following fields:

Field Name	Field Description	Mandatory (Yes or No)
Select	Used to indicate whether the price list is selected or not.	Yes
Price List ID or Description	Displays the price list id and name.	Not applicable
Start Date	Displays the date from when the price list of the product is effective.	Not applicable
End Date	Displays the date till when the price list of the product is effective.	Not applicable

The **Price List** zone contains the **Price List(s) Added** table which contain following columns:

Column	Column Description
Priority	Used to specify the priority of the price list.
Price List ID and Description	Displays the list of selected price list of the product.
Validity Period	Displays the period in days or by number of days for which the price list is valid. It is used to calculate price list assignment validity end date while assigning the price list to the product. The valid values are: <ul style="list-style-type: none"> • Date Range • Number of Days

Related Topics

For more information on...	See...
How to associate a price list with an offer	Associating a Price List with an Offer on page 3262

Adding an Offer

Prerequisites

To add an offer, you should have:

- Market product defined in the application.

Procedure

To add an offer:

1. Click the **Menu** link in the **Application** toolbar.
A list appears.
2. From the **Main** menu, select **Retail Banking** and then click the **Offer** sub-menu.
A sub-menu appears.
3. Click the **Add** option from the **Offer** sub-menu.

The **Offer Information** screen appears. It contains the following pages:

- [Offer Information - Basic Details](#) on page 3250
- [Offer Information - Other Details](#) on page 3251
- [Offer Information - Eligibility](#) on page 3252
- [Offer Information - Services](#) on page 3254
- [Offer Information - Price List](#) on page 3254

The **Basic Details** page contains the following zone:

- [Basic Details](#) on page 3250

The **Basic Details** zone contains the following fields:

Field Name	Field Description	Mandatory (Yes or No)
Offer Code	Used to specify the offer code.	Yes
Offer Name	Used to specify the offer.	Yes
Description	Used to specify the description for the offer.	No
Start Date	Used to specify the date from when the offer is effective.	Yes
End Date	Used to specify the date till when the offer is effective.	Yes
Terms and Conditions	Used to associate terms and conditions with the offer. Note: The Search  appears corresponding to the Terms and Conditions field. On clicking the Search icon, the Terms and Conditions Search for Product window appears where you can associate the terms and conditions with the product.	No

The **Basic Details** zone contains the **Add Market Products** section. This section contains following fields:

Field Name	Field Description	Mandatory (Yes or No)
Market Product Name	Used to indicate the search value of the market product name.	Yes
	Note: The Search  appears corresponding to the Market Product Name field. On clicking the Search icon, the window appears where you can associate the terms and conditions with the product.	
Product Category	Displays the product category associated with the selected product.	Not applicable
Product Type	Displays the product type associated with the selected product.	Not applicable
Product Name	Displays the particular product.	Not applicable

4. Select and add the required market product from the search result.
5. Enter the required details in the **Basic Details** page.
6. Associate the offer with divisions in the **Other Details** page, if required.
7. Define characteristics for the offer in the **Other Details** page, if required.
8. Define and add eligibility rule and parameter for the offer in the **Eligibility** page, if required.
9. Add a service for the offer in the **Services** page, if required.
10. Search and select the price list for the offer in the **Price List** page, if required..
11. Click **Submit**.

A window appears confirming the offer is submitted in the system.

12. Click the **Close** button in the confirmation window.

The offer is added.

Tip: Alternatively, you can access the **Offer Information** screen by clicking the **Add Offer** button in the **Page Title** area of the **Offer** screen.

Related Topics

For more information on...	See...
Offer Information screen	Search Offer on page 3244
How to associate the offer with a market product	Associating the Offer with a Market Product on page 3257
How to associate the offer with a division	Associating the Offer with a Division on page 3258
How to define a characteristic for the offer	Defining a Characteristic for the Offer on page 3259
How to define eligibility Criteria for the offer	Defining Eligibility Criteria for the Offer on page 3259
How to add a service for an offer	Adding a Service for an Offer on page 3261
How to associate a price list with an offer	Associating a Price List with an Offer on page 3262

Associating the Offer with a Market Product

Prerequisites

To associate the offer with a market product, you should have:

- Market product defined in the application.

Procedure

To associate the offer with a market product:

1. Search the required market product in the **Market Product Name** field, to associate with the offer.

Note: The **Search** (🔍) appears corresponding to the **Market Product Name** field. On clicking the **Search** icon, the **Search Market Product to Offer** window appears where you can associate the offer with a market product.

2. Click **Save as Draft**, to save the offer in the draft.
3. Click **Next**, to go to **Other Details** page.

The offer is saved as draft in the application.

Related Topics

For more information on...	See...
How to add an offer	Adding an Offer on page 3256
Basic Details zone	Basic Details on page 3250

Associating the Offer with a Division**Prerequisites**

To associate the offer with a division, you should have:

- Offer defined in the application.
- Divisions defined in the application.

Procedure

To associate the offer with a division:

1. Ensure that the **Division** section is expanded in the **Other Details** zone of **Other Details** page when you are associating the offer with a division.

The **Division** section contains divisions associated with the selected product or market product.

2. Select the required divisions in the **Division** section, to associate with the offer.
3. Click **Back** button, to go back to **Basic Details** page.
4. Click **Save as Draft**, to save the offer in the draft.
5. Click **Next**, to go to **Eligibility** page.

The offer is saved as draft in the application.

Related Topics

For more information on...	See...
How to add an offer	Adding an Offer on page 3256
Other Details page	Offer Information - Other Details on page 3251
Other Details zone	Other Details on page 3251

Defining a Characteristic for the Offer

Prerequisites

To define a characteristic for the offer, you should have:

- Characteristic type defined in the application.

Procedure

To define characteristic type to the offer:

1. Ensure that the **Additional Attributes** section is expanded in the **Other Details** zone of **Other Details** page when you are defining characteristic type to the product.

The **Additional Attributes** zone contains the following fields:

Field Name	Field Description	Mandatory (Yes or No)
Effective Date	Used to specify the date from when the characteristics type and characteristics value is effective.	Yes
Characteristics Type	Used to indicate the characteristic type.	Yes
Characteristics Value	Used to specify the value for the characteristic type.	Yes

2. Enter the required details in the **Additional Attributes** section.
3. Click **Save as Draft**, to save the product in the draft.
4. Click **Next**, to go to **Eligibility** page.

The offer is saved as draft in the application.

Related Topics

For more information on...	See...
Other Details page	Offer Information - Other Details on page 3251
Other Details zone	Other Details on page 3251

Defining Eligibility Criteria for the Offer

Prerequisites

To define eligibility criteria for the offer, you should have:

- Parameter defined in the application.

Procedure

To define eligibility criteria for the offer:

1. Ensure that the **Eligibility** zone is expanded in the **Eligibility** page when you are defining eligibility criteria for the offer.

The **Eligibility** zone contains the following fields:

Field Name	Field Description	Mandatory (Yes or No)
Eligibility Rule	Used to specify a eligibility rule of the offer.	Yes

Field Name	Field Description	Mandatory (Yes or No)
Start Date	Used to specify the date from when the eligibility rule is effective for the offer.	Yes
End Date	Used to specify the date till when the eligibility rule is effective for the offer.	No
Parameter	Used to search the parameter which you want to associate with the eligibility rule.	Yes
	Note: The Search (🔍) appears corresponding to the fields. On clicking the Search icon, the Parameter Search window appears where you can search for the required parameter.	
Operator	Used to specify the relational operator to define the relation between the parameter name and value.	Yes
Parameter Value Type	Used to indicate the parameter value against which you want to compare the parameter. The valid values are: <ul style="list-style-type: none"> Parameter Value 	Yes
Parameter	Used to search the parameter (on the right hand side) against which you want to compare the parameter (on the left hand side).	Yes
	Note: The Search (🔍) appears corresponding to the fields. On clicking the Search icon, the Parameter Search window appears where you can search for the required parameter.	
Is True	Used to indicate what happens when the condition is true (satisfied). The valid values are: <ul style="list-style-type: none"> Check Next Condition - Indicates that the condition with consecutive sequence number should be executed. Rule Is False - Indicates that the action specified in the Rule False Action field should be executed. Rule Is True - Indicates that the action specified in the Rule True Action field should be executed. 	Yes
Is False	Used to indicate what happens when the condition is false (not satisfied). The valid values are:	Yes

Field Name	Field Description	Mandatory (Yes or No)
	<ul style="list-style-type: none"> • Check Next Condition - Indicates that the condition with consecutive sequence number should be executed. • Rule Is False - Indicates that the action specified in the Rule False Action field should be executed. • Rule Is True - Indicates that the action specified in the Rule True Action field should be executed. 	
Is Sufficient	<p>Used to indicate what happens when the data is insufficient. The valid values are:</p> <ul style="list-style-type: none"> • Check Next Condition - Indicates that the condition with consecutive sequence number should be executed. • Rule Is False - Indicates that the action specified in the Rule False Action field should be executed. • Rule Is True - Indicates that the action specified in the Rule True Action field should be executed. 	Yes

The **Eligibility** zone contains the **Eligibility Rules** table which contain following columns:

Column	Column Description
Eligibility Rule	Displays eligibility rule of the offer.
Start Date	Displays the date from when the eligibility rule is effective for the offer.
End Date	Displays the date till when the eligibility rule is effective for the offer.

2. Enter the required details in the **Eligibility** zone.
3. Click **Save as Draft**, to save the offer in the draft.
4. Click **Next**, to go to **Services** page.

The offer is saved as draft in the application.

Related Topics

For more information on...	See...
Eligibility zone	Eligibility on page 3252

Adding a Service for an Offer

Prerequisites

To add a service to an offer, you should have:

- Service defined in the application.

Procedure

To add a service to an offer:

1. Ensure that the **Services** section is expanded in the **Services** zone of **Services** page when you are add service to an offer.

The **Services** zone contains the following fields:

Field Name	Field Description	Mandatory (Yes or No)
Product Service	Used to specify the product service.	Not applicable
Description	Used to specify the description of the product service.	Not applicable
Start Date	Used to specify the date from when the product service is effective.	Not applicable
	Note: The product service end date cannot be earlier than the product service start date.	
End Date	Used to specify the date till when the product service is effective.	Not applicable
	Note: The product service end date cannot be earlier than the product service start date.	
Mandatory	Indicates whether the service is mandatory or not.	Not applicable
Mandatory Services	Displays the services associated with the selected product.	Not applicable
Optional Services	Used to add the service for an offer.	No

2. Enter the required details in the **Services** section.
3. Click **Save as Draft**, to save the offer in the draft.
4. Click **Submit**, to save the offer.

Related Topics

For more information on...	See...
Services screen	Services on page 3254
How to add an offer	Adding an Offer on page 3256

Associating a Price List with an Offer

Prerequisites

To associate an offer with a price list, you should have:

- Price list defined in the application.

Procedure

To associate an offer with a price list:

1. Ensure that the is **Price List** zone expanded in the of **Price List** page when you are associating the offer with the Price List.

The **Price List** zone contains **Search Price List** section.

The **Search Price List** section contains the following fields:

Field Name	Field Description	Mandatory (Yes or No)
Price List ID or Description	Used to indicate whether you want to search for a price list using the price list details.	No
Start Date	Used to specify the date from when the price list of the product is effective.	No
End Date	Used to specify the date till when the price list of the product is effective.	No

The **Search Results** section contains the following fields:

Field Name	Field Description	Mandatory (Yes or No)
Select	Used to indicate whether the price list is selected or not.	Yes
Price List ID or Description	Displays the price list id and name.	Not applicable
Start Date	Displays the date from when the price list of the product is effective.	Not applicable
End Date	Displays the date till when the price list of the product is effective.	Not applicable

2. Select the required price list in the grid, to associate with the offer.
3. Click **Back** button, to go back to **Services** page.
4. Click **Save as Draft**, to save the offer in the draft.
5. Click **Select and Proceed**, to go to **Price List Added** section. It contains the following fields in the grid:

Field Name	Field Description	Mandatory (Yes or No)
Priority	Indicates the order in which the assigned price list must be considered while determining the price item pricing for the offer.	No
Price List ID or Description	Used to indicate whether you want to search for a price list using the price list details.	No
Validity Period	Used to specify the period date range or number of days for which the price list is valid. It is used to calculate price list assignment validity end date while assigning the price list to the offer. The valid values are: <ul style="list-style-type: none"> • Date Range • Number of Days 	No

6. Add, edit or delete the required price list in the grid, to associate with the offer.
7. Click **Add More** button, to go back to previous section to add and associate the price list with the offer.
8. Click **Back** button, to go back to **Services** page.

- Click **Save as Draft**, to save the offer in the draft.

The offer is saved as draft in the application.

- Click **Submit**.

A window appears confirming the offer is submitted in the system.

- Click the **Close** button in the confirmation window.

The offer is added.

Tip: Alternatively, you can access the **Offer Information** screen by clicking the **Add Market Product** button in the **Page Title** area of the **Offer** screen.

Related Topics

For more information on...	See...
How to add an offer	Adding an Offer on page 3256
Price List zone	Price List on page 3255

Bundle (Used for Searching)

The **Bundle** screen allows you to search for a bundle using various search criteria. It also allows you to add, edit, or copy an bundle. It contains the following zone:

- [Search Bundle](#) on page 3264

Related Topics

For more information on...	See...
How to search for a bundle	Searching for a Bundle on page 3266
How to add a bundle	Adding a Bundle on page 3276
How to edit the details of a bundle	Editing a Bundle on page 3267
How to copy a bundle	Copying a Bundle on page 3269

Search Bundle

The **Search Bundle** zone allows you to search for a bundle using various search criteria. It contains the two following sections:





- Search Criteria** - The **Search Criteria** section contains the following fields:

Field Name	Field Description	Mandatory (Yes or No)
Search By	Used to indicate whether you want to search bundles which are added by you or search all the bundles available in the system. The valid value is: <ul style="list-style-type: none"> All Bundles 	No
Bundle Code	Used to search for a particular bundle.	No
Bundle Name	Used to search for bundle having a particular name.	No

Field Name	Field Description	Mandatory (Yes or No)
Market Product Code	Used to search bundles which are associated to a particular market product.	No
Market Product Name	Used to search bundles which are associated to market products having a particular name.	No
Product Category	Used to search bundles which belong to a particular product category. The valid values are: <ul style="list-style-type: none"> • Checking • Loans • Others • Savings 	No
Status	Used to search bundles having a particular status. The valid values are: <ul style="list-style-type: none"> • Active • Draft • Retired 	No
Start Date	Used to search bundles which are effective from a particular date onwards.	No

- **Search Results** - On clicking the **Search** button, the search results appear based on the specified search criteria. The **Search Results** section contains the following columns:

Column Name	Column Description
Bundle Information	Displays the concatenated string of information about the bundle separated by a comma (,).
Start Date	Displays the date from when the bundle is effective in the system.
End Date	Displays the date till when the bundle is effective in the system.
Product Category	Indicates the category to which the product belongs.
Market Product Information	Displays the concatenated string of information about the market product separated by a comma (,).
Status	Indicates the current status of the bundle. The valid values are: <ul style="list-style-type: none"> • Active • Draft • Retired

Column Name	Column Description
	<p>Note:</p> <p>If the bundle is in the active status, it is indicated by the Active ( Active) icon.</p> <p>If the bundle is in the draft status, it is indicated by the Draft ( Draft) icon.</p> <p>If the bundle is in the retired status, it is indicated by the Retired ( Retire) icon.</p>
Copy	On clicking the Copy () icon, the Product Bundle screen appears where you can add a new bundle using an existing bundle.
Edit	On clicking the Edit () icon, the Product Bundle screen appears where you can edit the details of the existing bundle.

Note: Pagination is used to display limited number of records in this zone. You can use the navigation links, such as **Previous** and **Next** to navigate between pages.

Related Topics

For more information on...	See...
How to search for a bundle	Searching for a Bundle on page 3266
How to edit the details of a bundle	Editing a Bundle on page 3267
How to copy a bundle	Copying a Bundle on page 3269

Searching for a Bundle

Prerequisites

To search a bundle, you should have:

- Bundle defined in the application.
- Market Product defined in the application.
- Product defined in the application.

Procedure

To search a bundle:

1. Click the **Menu** link in the **Application** toolbar.
A list appears.
2. From the **Main** menu, select **Retail Banking** and then click the **Bundle** sub-menu.
A sub-menu appears.
3. Click the **Search** option from the **Bundle** sub-menu.
The **Bundle** screen appears.
4. Enter the search criteria in the **Search Bundle** zone.

Note: ORMB search engine supports wildcard search, where you can substitute the percentage (%) symbol as a stand in for any word or letter in a search criteria. You can use the ‘%’ wildcard character in all input fields except the date and ID fields. The ‘%’ wildcard character is suffixed automatically at the end of the partial search criteria. Therefore, you may or may not specify the wildcard character at the end of the partial search criteria. However, you have to prefix the wildcard character manually wherever required.

5. Click **Search** button.

A list of bundle that meet the search criteria appears in the **Search Results** section.

Note: Pagination is used to display limited number of records in the **Search Results** section. You can use the navigation links, such as **Previous** and **Next** to navigate between pages.

Related Topics

For more information on...	See...
Bundle Screen	Search Bundle on page 3264
How to add a bundle	Adding a Bundle on page 3276
How to edit the details of a bundle	Editing a Bundle on page 3267
How to copy a bundle	Copying a Bundle on page 3269

Editing a Bundle

Procedure

To edit a bundle:

1. Search for the bundle in the **Bundle** screen whose details you want to edit.
2. In the **Search Results** section, click the **Edit** (✎) icon in the **Edit** column corresponding to the bundle whose details you want to edit.

The **Bundle Information** screen appears. It contains the following pages:

- [Bundle Information - Basic Details](#) on page 3271
- [Bundle Information - Other Details](#) on page 3272
- [Bundle Information - Eligibility](#) on page 3273
- [Bundle Information - Services](#) on page 3275
- [Bundle Information - Price List](#) on page 3275

The **Basic Details** page contains the following zone:

- [Basic Details](#)

The **Basic Details** zone contains the following fields:

Field Name	Field Description	Mandatory (Yes or No)
Bundle Code	Displays the bundle code.	Not applicable
Bundle Name	Used to specify the bundle.	Yes
Description	Used to specify the description of the bundle.	No
Start Date	Displays the date from when the bundle is effective in the system.	Not applicable

Field Name	Field Description	Mandatory (Yes or No)
End Date	Used to specify the date till when the bundle is effective in the system.	No
Terms and Conditions	Used to associate terms and conditions with the bundle.	No
	Note: The Search (🔍) appears corresponding to the Terms and Conditions field. On clicking the Search icon, the Terms and Conditions Search for Product window appears where you can associate the terms and conditions with the bundle.	
Market Product Name	Used to specify the market product.	No
	Note: The Search (🔍) appears corresponding to the Market Product Name field. On clicking the Search icon, the Search Market Product to Offer window appears where you can associate the market product with the offer.	
Product Category	Displays the product category.	Not applicable
Product Type	Displays the product type.	Not applicable
Product Name	Displays the concatenated string of information about the product separated by a comma (,).	Not applicable

3. Modify the required details in the **Basic Details** page.
4. Associate or disassociate the bundle with a market product in the **Basic Details** page.
5. Associate or disassociate the bundle from a division in the **Other Details** page, if required.
6. Add, edit, or remove the characteristics from the bundle in the **Other Details** page, if required.
7. Add, edit, or remove the eligibility rule from the bundle in the **Eligibility** page, if required.
8. Add, edit, or remove the price list from the bundle in the **Price List** page, if required.
9. Click **Submit**.

A window appears confirming the bundle is submitted in the system.

10. Click the **Close** button in the confirmation window.

Note: You cannot edit fields from the **Services** page when a service is already associated to the product.

The bundle is modified.

Related Topics

For more information on...	See...
How to search for a bundle	Searching for a Bundle on page 3266
Bundle screen	Search Bundle on page 3264
How to associate the bundle with a market product	Associating the Bundle with a Market Product on page 3278

For more information on...	See...
How to associate the bundle with a division	Associating the Bundle with a Division on page 3279
How to define a characteristic for the bundle	Defining a Characteristic for the Bundle on page 3279
How to define eligibility Criteria for the bundle	Defining Eligibility Criteria for the Bundle on page 3280
How to add a service for a bundle	Adding a Service for a Bundle on page 3282
How to associate a price list with the bundle	Associating a Price List with the Bundle on page 3283

Copying a Bundle

Instead of creating a bundle from scratch, you can create a new bundle using an existing bundle. This is possible through copying a bundle. On copying a bundle, the details including the associated divisions, characteristics, services and the price list are copied to the new bundle. You can then edit the details, if required.

Prerequisites

To copy a bundle, you should have:

- Bundle(whose copy you want to create) defined in the application

Procedure

To copy a bundle:

1. Search for a bundle in the **Bundle** screen whose copy you want to create.
2. In the **Search Results** section, click the **Copy** (📄) icon in the **Copy** column corresponding to the bundle whose copy you want to create.

The **Bundle Information** screen appears. It contains the following pages:

- [Bundle Information - Basic Details](#) on page 3271
- [Bundle Information - Other Details](#) on page 3272
- [Bundle Information - Eligibility](#) on page 3273
- [Bundle Information - Services](#) on page 3275
- [Bundle Information - Price List](#) on page 3275

The **Basic Details** page contains the following zone:

- [Basic Details](#) on page 3271

The **Basic Details** zone contains the following fields:

Field Name	Field Description	Mandatory (Yes or No)
Bundle Code	Used to specify the bundle code.	Yes
Bundle Name	Used to specify the bundle.	Yes
Description	Used to specify the description for the bundle.	No
Start Date	Used to specify the date from when the bundle is effective.	Yes
End Date	Used to specify the date till when the bundle is effective.	No
Terms and Conditions	Used to associate terms and conditions with the bundle.	No

Field Name	Field Description	Mandatory (Yes or No)
	Note: The Search (🔍) appears corresponding to the Terms and Conditions field. On clicking the Search icon, the Terms and Conditions Search for Product window appears where you can associate the terms and conditions with the bundle.	
Market Product Name	Used to specify the market product. Note: The Search (🔍) appears corresponding to the Market Product Name field. On clicking the Search icon, the Search Market Product to Offer window appears where you can associate the market product with the offer.	Yes
Product Category	Displays the product category.	Not applicable
Product Type	Displays the product type.	Not applicable
Product Name	Displays the concatenated string of information about the product separated by a comma (,).	Not applicable

3. Modify the required details in the **Basic Details** page.
4. Associate or disassociate the bundle with a market product in the **Basic Details** page
5. Associate or disassociate the bundle from a division in the **Other Details** page, if required.
6. Add, edit, or remove the characteristics from the bundle in the **Other Details** page, if required.
7. Add, edit, or remove the eligibility rule from the bundle in the **Eligibility** page, if required.
8. Add, edit, or remove the price list from the bundle in the **Price List** page, if required.
9. Click **Submit**.

A window appears confirming the bundle is submitted in the system.

10. Click the **Close** button in the confirmation window.

Note: You cannot edit fields from the **Services** page when a service is already associated to the product.

The new bundle is added.

Related Topics

For more information on...	See...
How to search for a bundle	Searching for a Bundle on page 3266
Bundle screen	Search Bundle on page 3264
How to associate the bundle with a market product	Associating the Bundle with a Market Product on page 3278
How to associate the bundle with a division	Associating the Bundle with a Division on page 3279
How to define a characteristic for the bundle	Defining a Characteristic for the Bundle on page 3279
How to define eligibility Criteria for the bundle	Defining Eligibility Criteria for the Bundle on page 3280

For more information on...	See...
How to add a service for a bundle	Adding a Service for a Bundle on page 3282
How to associate a price list with the bundle	Associating a Price List with the Bundle on page 3283

Bundle (Used for Adding)

The **Bundle Information** screen allows you to add an offer using various search criteria. It also allows you to add and edit an offer. It contains the following zone:

- [Basic Details](#) on page 3271

Related Topics

For more information on...	See...
How to add a Bundle	Adding a Bundle on page 3276
How to associate the bundle with a market product	Associating the Bundle with a Market Product on page 3278
How to associate the bundle with a division	Associating the Bundle with a Division on page 3279
How to define a characteristic for the bundle	Defining a Characteristic for the Bundle on page 3279
How to define eligibility Criteria for the bundle	Defining Eligibility Criteria for the Bundle on page 3280
How to add a service for a bundle	Adding a Service for a Bundle on page 3282
How to associate a price list with the bundle	Associating a Price List with the Bundle on page 3283

Bundle Information - Basic Details

The **Basic Details** page allows you add, edit, and view the basic details of the bundle. It contains the following zone:

- [Basic Details](#) on page 3271

Related Topics

For more information on...	See...
How to edit a bundle	Editing a Bundle on page 3267

Basic Details

The **Basic Details** zone allows you to view, add, and edit the basic information about the bundle. It contains the following fields:

Field Name	Field Description	Mandatory (Yes or No)
Bundle Code	Displays the bundle code.	Yes
Bundle Name	Displays the bundle.	Yes
Description	Displays the description of the bundle.	No
Start Date	Displays the date from when the bundle is effective.	Yes
End Date	Displays the date till when the bundle is effective.	No

Field Name	Field Description	Mandatory (Yes or No)
Terms and Conditions	Indicates the terms and conditions associated with the bundle.	No

The **Basic Details** zone contain the **Add Market Products** section. It contains the following fields:

Field Name	Field Description	Mandatory (Yes or No)
Market Product Name	Used to specify the market product.	Yes
	Note: The Search (🔍) appears corresponding to the Market Product Name field. On clicking the Search icon, the Search Market Product to Offer window appears where you can associate the market product with the offer.	
Product Category	Displays the product category to which the product belongs.	Not applicable
Product Type	Displays the product type to which the product belongs.	Not applicable
Product Name	Displays the concatenated string of information about the product separated by a comma (,).	Not applicable

Related Topics

For more information on...	See...
How to edit a bundle	Editing a Bundle on page 3267

Bundle Information - Other Details

The **Other Details** page allows you to do the following:

- Associate the bundle with multiple divisions
- Define characteristics for the bundle

The **Other Details** page contains the following zone:

- [Other Details](#) on page 3272

For more information on...	See...
How to associate the bundle with a division	Associating the Bundle with a Division on page 3279
How to define a characteristic for the bundle	Defining a Characteristic for the Bundle on page 3279

Other Details

The **Other Details** zone allows you to do the following:

- Associate or disassociate the bundle from a division
- Define, edit, or remove characteristics from the bundle

The **Other Details** zone contains the following sections:

- **Divisions** - Used to associate or disassociate the bundle from a division.
- **Additional Attributes** - Used to define, edit, or remove characteristics from the bundle.

Related Topics

For more information on...	See...
How to associate the bundle with a division	Associating the Bundle with a Division on page 3279
How to define a characteristic for the bundle	Defining a Characteristic for the Bundle on page 3279

Bundle Information - Eligibility

The **Eligibility** page allows you to add, view, and edit eligibility rule for the bundle. It contains the following zone:

- [Eligibility](#) on page 3273

Related Topics

For more information on...	See...
How to define eligibility criteria for the bundle	Defining Eligibility Criteria for the Bundle on page 3280

Eligibility

The **Eligibility** zone allows you to define, add, view, or edit the eligibility criteria for the bundle. It contain the following section:

- **Eligibility** - Used to add, view, or edit the eligibility criteria for the bundle.

The **Eligibility** zone contains the following fields in a grid:

Field Name	Field Description	Mandatory (Yes or No)
Eligibility Rule	Displays the eligibility rule of the bundle.	Yes
Start Date	Displays the date from when the eligibility rule is effective for the bundle.	Yes
End Date	Displays the date till when the eligibility rule is effective for the bundle.	No
Parameter	Used to search the parameter which you want to associate with the eligibility rule. Note: The Search (🔍) appears corresponding to the fields. On clicking the Search icon, the Parameter Search window appears where you can search for the required parameter.	Yes
Operator	Displays the relational operator to define the relation between the parameter name and value.	Yes
Parameter Value Type	Indicates the parameter value against which you want to compare the parameter. The valid values are: <ul style="list-style-type: none"> • Parameter • Value 	Yes
Parameter	Used to search the parameter (on the right hand side) against which you want to compare the parameter (on the left hand side).	Yes

Field Name	Field Description	Mandatory (Yes or No)
	Note: The Search (🔍) appears corresponding to the fields. On clicking the Search icon, the Parameter Search window appears where you can search for the required parameter.	
Is True	Indicates what happens when the condition is true (satisfied). The valid values are: <ul style="list-style-type: none"> • Check Next Condition - Indicates that the condition with consecutive sequence number should be executed. • Rule Is False - Indicates that the action specified in the Rule False Action field should be executed. • Rule Is True - Indicates that the action specified in the Rule True Action field should be executed. 	Yes
Is False	Indicates what happens when the condition is false (not satisfied). The valid values are: <ul style="list-style-type: none"> • Check Next Condition - Indicates that the condition with consecutive sequence number should be executed. • Rule Is False - Indicates that the action specified in the Rule False Action field should be executed. • Rule Is True - Indicates that the action specified in the Rule True Action field should be executed. 	Yes
Is Insufficient	Indicates what happens when the data is insufficient. The valid values are: <ul style="list-style-type: none"> • Check Next Condition - Indicates that the condition with consecutive sequence number should be executed. • Rule Is False - Indicates that the action specified in the Rule False Action field should be executed. • Rule Is True - Indicates that the action specified in the Rule True Action field should be executed. 	Yes

The **Eligibility** zone contains the **Eligibility Rules** section which contain following fields:

Field Name	Field Description	Mandatory (Yes or No)
Eligibility Rule	Displays eligibility rule of the bundle.	Not applicable
Start Date	Displays the date from when the eligibility rule is effective for the bundle.	Not applicable

Field Name	Field Description	Mandatory (Yes or No)
End Date	Displays the date till when the eligibility rule is effective for the bundle.	Not applicable

Related Topics

For more information on...	See...
How to define eligibility criteria for the bundle	Defining Eligibility Criteria for the Bundle on page 3280

Bundle Information - Services

The **Services** page allows you to add services for the bundle. It contains the following zone:

- [Services](#) on page 3275

Related Topics

For more information on...	See...
How to add service for a bundle	Adding a Service for a Bundle on page 3282

Services

The **Services** zone allows you to add, edit, or remove services for the bundle. It contain the following section:

- **Services** - Used to add, edit, or remove services for the bundle.

The **Services** contains the following fields in a grid:

Field Name	Field Description	Mandatory (Yes or No)
Product Service	Displays the market product service.	Not applicable
Description	Displays description of the market product service.	Not applicable
Start Date	Displays the date from when the service is effective.	Not applicable
End Date	Displays the date till when the service is effective.	Not applicable
Mandatory Services	Displays the services associated with the selected product.	Not applicable
Optional Services	Displays optional services to add for the bundle.	No

Related Topics

For more information on...	See...
How to add a service for a bundle	Adding a Service for a Bundle on page 3282

Bundle Information - Price List

The **Price List** page allows you to add, view, edit, and associate price list for the bundle. It contains the following zone:

- [Price List](#) on page 3276

Related Topics

For more information on...	See...
How to associate a price list with the bundle	Associating a Price List with the Bundle on page 3283

Price List

The **Price List** page allows you to search, associate, add, view, and edit price list for the bundle. It contains the following zone:

- **Price List** - Used to search, associate, add, view, or edit the price list to the bundle.

The **Price List** zone contains the following fields in a grid:

Field Name	Field Description	Mandatory (Yes or No)
Price List ID or Description	Used to search the price list the bundle.	No
Start Date	Used to search the price list by date from when the price list is effective.	No
End Date	Used to search the price list by date till when the price list is effective.	No

The **Search Results** section contains the following fields:

Field Name	Field Description	Mandatory (Yes or No)
Select	Used to indicate whether the price list is selected or not.	Yes
Price List ID or Description	Displays the price list id and name.	Not applicable
Start Date	Displays the date from when the price list of the product is effective.	Not applicable
End Date	Displays the date till when the price list of the product is effective.	Not applicable

The **Price List** zone contains the **Price List(s) Added** table which contain following columns:

Column	Column Description
Priority	Used to define the priority of the price list.
Price List ID or Description	Displays the list of price list ID and product name of the selected market product.
Validity Period	Displays the period in days or by number of days for which the price list is valid. It is used to calculate price list assignment validity end date while assigning the price list to the product. The valid values are: <ul style="list-style-type: none"> • Date Range • Number of Days

Related Topics

For more information on...	See...
How to associate a price list with the bundle	Associating a Price List with the Bundle on page 3283

Adding a Bundle

Prerequisites

To add a bundle, you should have:

- Market product defined in the application.

Procedure

To add a bundle:

1. Click the **Menu** link in the **Application** toolbar.
A list appears.
2. From the **Main** menu, select **Retail Banking** and then click the **Bundle** sub-menu.
A sub-menu appears.
3. Click the **Add** option from the **Bundle** sub-menu.

The **Bundle Information** screen appears. It contains the following pages:

- [Bundle Information - Basic Details](#) on page 3271
- [Bundle Information - Other Details](#) on page 3272
- [Bundle Information - Eligibility](#) on page 3273
- [Bundle Information - Services](#) on page 3275
- [Bundle Information - Price List](#) on page 3275

The **Basic Details** page contains the following zone:

- [Basic Details](#) on page 3271

The **Basic Details** zone contains the following fields:

Field Name	Field Description	Mandatory (Yes or No)
Bundle Code	Used to specify the bundle code.	Yes
Bundle Name	Used to specify the bundle.	Yes
Description	Used to specify the description for the bundle.	No
Start Date	Used to specify the date from when the bundle is effective.	Yes
End Date	Used to specify the date till when the bundle is effective.	No
Terms and Conditions	Used to associate terms and conditions with the bundle. Note: The Search (🔍) appears corresponding to the Terms and Conditions field. On clicking the Search icon, the Terms and Conditions Search for Product window appears where you can associate the terms and conditions with the product.	No

The **Basic Details** zone contains the **Add Markets Product** section. This section contains following fields:

Field Name	Field Description	Mandatory (Yes or No)
Market Product Name	Used to indicate the search value of the market product name.	Yes
	Note: The Search (🔍) appears corresponding to the Market Product Name field. On clicking the Search icon, the window appears where you can associate the terms and conditions with the product.	
Product Category	Displays the product category associated with the selected market product.	Not applicable
Product Type	Displays the product type associated with the selected market product.	Not applicable
Product Name	Displays the product associated with the selected market product.	Not applicable

4. Select the required market product from the search result.
5. Enter the required details in the **Basic Details** page.
6. Associate the bundle with divisions in the **Other Details** page, if required.
7. Define characteristics for the bundle in the **Other Details** page, if required.
8. Define and add eligibility rule and parameter for the bundle in the **Eligibility** page, if required.
9. Add a service for the bundle in the **Services** page, if required.
10. Search and select the price list for the bundle in the **Price List** page, if required..
11. Click **Submit**.

A window appears confirming the bundle is submitted in the system.

12. Click the **Close** button in the confirmation window.

The bundle is added.

Tip: Alternatively, you can access the **Bundle Information** screen by clicking the **Add Bundle** button in the **Page Title** area of the **Bundle** screen.

Related Topics

For more information on...	See...
Bundle Information screen	Search Bundle on page 3264
How to associate the bundle with a market product	Associating the Bundle with a Market Product on page 3278
How to associate the bundle with a division	Associating the Bundle with a Division on page 3279
How to define a characteristic for the bundle	Defining a Characteristic for the Bundle on page 3279
How to define eligibility Criteria for the bundle	Defining Eligibility Criteria for the Bundle on page 3280
How to add a service for a bundle	Adding a Service for a Bundle on page 3282
How to associate a price list with the bundle	Associating a Price List with the Bundle on page 3283

Associating the Bundle with a Market Product

Prerequisites

To associate the bundle with a market product, you should have:

- Market product defined in the application.

Procedure

To associate the bundle with a market product:

1. Search the required market product in the **Market Product Name** field, to associate with the bundle.

Note: The **Search** (🔍) appears corresponding to the **Market Product Name** field. On clicking the **Search** icon, the **Search Market Product to Offer** window appears where you can associate the offer with a market product.

2. Click **Save as Draft**, to save the bundle in the draft.
3. Click **Next**, to go to **Other Details** page.

The bundle is saved as draft in the application.

Related Topics

For more information on...	See...
How to add a bundle	Adding a Bundle on page 3276
Basic Details zone	Basic Details on page 3271

Associating the Bundle with a Division

Prerequisites

To associate the bundle with a division, you should have:

- Bundle defined in the application.
- Divisions defined in the application.

Procedure

To associate the bundle with a division:

1. Ensure that the **Division** section is expanded in the **Other Details** zone of **Other Details** page when you are associating the bundle with a division.

The **Division** section contains divisions associated with the selected product or market product.

2. Select the required divisions in the **Division** section, to associate with the bundle.
3. Click **Back** button, to go back to **Basic Details** page.
4. Click **Save as Draft**, to save the market product in the draft.
5. Click **Next**, to go to **Services** page.

The bundle is saved as draft in the application.

Related Topics

For more information on...	See...
How to add a bundle	Adding a Bundle on page 3276
Services zone	Services on page 3275

Defining a Characteristic for the Bundle

Prerequisites

To define a characteristic to the bundle, you should have:

- Characteristic type defined in the application.

Procedure

To define characteristic type to the bundle:

1. Ensure that the **Additional Attributes** section is expanded in the **Other Details** zone of **Other Details** page when you are defining characteristic type to the bundle.

The **Additional Attributes** zone contains the following fields:

Field Name	Field Description	Mandatory (Yes or No)
Effective Date	Used to specify the date from when the characteristics type and characteristics value is effective.	Yes
Characteristics Type	Used to indicate the characteristic type.	Yes
Characteristics Value	Used to specify the value for the characteristic type.	Yes

2. Enter the required details in the **Additional Attributes** section.
3. Click **Save as Draft**, to save the bundle in the draft.
4. Click **Next**, to go to **Eligibility** page.

The bundle is saved as draft in the application.

Related Topics

For more information on...	See...
Other Details page	Bundle Information - Other Details on page 3272
Other Details zone	Other Details on page 3272

Defining Eligibility Criteria for the Bundle**Prerequisites**

To define eligibility criteria for the bundle, you should have:

- Parameter defined in the application.

Procedure

To define eligibility criteria for the bundle:

1. Ensure that the **Eligibility** zone is expanded in the **Eligibility** page when you are defining eligibility criteria for the bundle.

The **Eligibility** zone contains the following fields:

Field Name	Field Description	Mandatory (Yes or No)
Eligibility Rule	Used to specify a eligibility rule for the bundle.	Yes
Start Date	Used to specify the date from when the eligibility rule will be effective.	Yes

Field Name	Field Description	Mandatory (Yes or No)
End Date	Used to specify the date till when the eligibility rule will be effective.	No
Parameter	Used to search the parameter which you want to associate with the eligibility rule. Note: The Search (🔍) appears corresponding to the fields. On clicking the Search icon, the Parameter Search window appears where you can search for the required parameter.	Yes
Operator	Used to specify the relational operator to define the relation between the parameter name and value.	Yes
Parameter Value Type	Used to indicate the parameter value against which you want to compare the parameter. The valid values are: <ul style="list-style-type: none"> Parameter Value 	Yes
Parameter	Used to search the parameter (on the right hand side) against which you want to compare the parameter (on the left hand side). Note: The Search (🔍) appears corresponding to the fields. On clicking the Search icon, the Parameter Search window appears where you can search for the required parameter.	Yes
Is True	Used to indicate what happens when the condition is true (satisfied). The valid values are: <ul style="list-style-type: none"> Check Next Condition - Indicates that the condition with consecutive sequence number should be executed. Rule Is False - Indicates that the action specified in the Rule False Action field should be executed. Rule Is True - Indicates that the action specified in the Rule True Action field should be executed. 	Yes
Is False	Used to indicate what happens when the condition is false (not satisfied). The valid values are: <ul style="list-style-type: none"> Check Next Condition - Indicates that the condition with consecutive sequence number should be executed. 	Yes

Field Name	Field Description	Mandatory (Yes or No)
	<ul style="list-style-type: none"> • Rule Is False - Indicates that the action specified in the Rule False Action field should be executed. • Rule Is True - Indicates that the action specified in the Rule True Action field should be executed. 	
Is Sufficient	<p>Used to indicate what happens when the data is insufficient. The valid values are:</p> <ul style="list-style-type: none"> • Check Next Condition - Indicates that the condition with consecutive sequence number should be executed. • Rule Is False - Indicates that the action specified in the Rule False Action field should be executed. • Rule Is True - Indicates that the action specified in the Rule True Action field should be executed. 	Yes

The **Eligibility** zone contains the **Eligibility Rules** table which contain following columns:

Column	Column Description
Eligibility Rule	Displays eligibility rule of the bundle.
Start Date	Displays the date from when the eligibility rule is effective.
End Date	Displays the date till when the eligibility rule is effective.

2. Enter the required details in the **Eligibility** zone.
3. Click **Save as Draft**, to save the bundle in the draft.
4. Click **Next**, to go to **Services** page.

The bundle is saved as draft in the application.

Related Topics

For more information on...	See...
Eligibility zone	Eligibility on page 3273

Adding a Service for a Bundle

Prerequisites

To add a service to a bundle, you should have:

- Market product defined in the application.
- Service defined in the application.

Procedure

To add a service to a bundle:

1. Ensure that the **Services** section is expanded in the **Services** zone of **Services** page when you are add service to a bundle.

The **Services** zone contains the following fields:

Field Name	Field Description	Mandatory (Yes or No)
Product Service	Used to specify the product service.	Not applicable
Description	Used to specify the description of the product service.	Not applicable
Start Date	Used to specify the date from when the product service will be effective.	Not applicable
	Note: The product service end date cannot be earlier than the product service start date.	
End Date	Used to specify the date till when the product service will be effective.	Not applicable
	Note: The product service end date cannot be earlier than the product service start date.	
Mandatory	Indicates whether the product service is mandatory or not.	Not applicable
Mandatory Services	Displays the services associated with the selected product.	Not applicable
Optional Services	Used to add the service for a bundle.	No

2. Enter the required details in the **Services** section.
3. Click **Save as Draft**, to save the bundle in the draft.
4. Click **Submit**, to save the bundle.

Related Topics

For more information on...	See...
Services screen	Services on page 3275
How to add a bundle	Adding a Bundle on page 3276

Associating a Price List with the Bundle

Prerequisites

To associate the bundle with a price list, you should have:

- Price list defined in the application.

Procedure

To associate the bundle with a price list:

1. Ensure that the **Price List** zone expanded in the of **Price List** page when you are associating the bundle with the price list.

The **Price List** zone contains **Search Price List** section.

The **Search Price List** section contains the following fields:

Field Name	Field Description	Mandatory (Yes or No)
Price List ID or Description	Used to indicate whether you want to search for a price list using the price list details.	Yes
Start Date	Used to specify the date from when the price list of the product is effective.	Yes
End Date	Used to specify the date till when the price list of the product is effective.	No

The **Search Results** section contains the following fields:

Field Name	Field Description	Mandatory (Yes or No)
Select	Used to indicate whether the price list is selected or not.	Yes
Price List ID and Description	Displays the price list id and name.	Not applicable
Start Date	Displays the date from when the price list of the product is effective.	Not applicable
End Date	Displays the date till when the price list of the product is effective.	Not applicable

2. Select the required price list in the grid, to associate with the bundle.
3. Click **Back** button, to go back to **Services** page.
4. Click **Save as Draft**, to save the bundle in the draft.
5. Click **Select and Proceed**, to go to **Price List Added** section. It contains the following fields in the grid:

Field Name	Field Description	Mandatory (Yes or No)
Priority	Indicates the order in which the assigned price list must be considered while determining the price item pricing for the bundle.	Yes
Price List ID or Description	Used to indicate whether you want to search for a price list using the price list details.	Not applicable
Validity Period	Used to specify the period date range or number of days for which the price list is valid. It is used to calculate price list assignment validity end date while assigning the price list to the bundle. The valid values are: <ul style="list-style-type: none"> • Date Range • Number of Days 	Not applicable

6. Add, edit or delete the required price list in the grid, to associate with the bundle.
7. Click **Add More** button, to go back to previous section to add and associate the price list with the bundle.
8. Click **Back** button, to go back to **Services** page.
9. Click **Save as Draft**, to save the bundle in the draft.

The bundle is saved as draft in the application.

10. Click Submit.

A window appears confirming the bundle is submitted in the system.

11. Click the Close button in the confirmation window.

The bundle is added.

Tip: Alternatively, you can access the **Bundle Information** screen by clicking the **Add Bundle** button in the **Page Title** area of the **Bundle** screen.

Related Topics

For more information on...	See...
How to add a bundle	Adding a Bundle on page 3276
Price List zone	Price List on page 3276

Chapter 49

Retail Banking Product Inbound Web Services

Topics:

- [Prerequisites](#)
- [C1_GETELIGIBLEPROD Business Service](#)
- [C1-GetProdDetail Business Service](#)
- [C1PRDCTENRL Business Service](#)

Oracle Revenue Management and Billing provides the ability to do the following through an inbound web service:

- View the details of a retail banking product, market product, offer, and bundle
- Derive the eligible market product, offer, and bundle for a person or an account

The following inbound web services are shipped with the product:

- **C1-GetEligibleProduct** - This is a SOAP based inbound web service. It supports the XML format. It enables you to derive eligible active market products, offers, and bundles for the person or account on the processing date. You can specify the eligibility parameters along with the person or account details when you want to simulate the response. It also enables you to view the details of an active product, market product, offer, and/or bundle which is effective on the processing date. You can extract the data in the following templates:
 - **Summary** - Used when you want to extract the details of the market product, offer, and/or bundle without pricing.
 - **Detail** - Used when you want to extract the details of the market product, offer, and/or bundle with pricing.
- **C1-GetEligibleProductRest** - This is a REST based inbound web service. It supports the JSON and XML formats. It enables you to derive eligible active market products, offers, and bundles for the person or account on the processing date. You can specify the eligibility parameters along with the person or account details when you want to simulate the response. It also enables you to view the details of an active product, market product, offer, and/or bundle which is effective on the processing date. You can extract the data in the following templates:
 - **Summary** - Used when you want to extract the details of the market product, offer, and/or bundle without pricing.
 - **Detail** - Used when you want to extract the details of the market product, offer, and/or bundle with pricing.
- **C1-GetProdDetail** - This is a SOAP based inbound web service. It supports the XML format. It enables you to view the details of an active market product, offer, or bundle which is effective on the processing date. You can extract the data in the following templates:
 - **Summary** - Used when you want to extract the details of the market product, offer, or bundle without pricing.

- **Detail** - Used when you want to extract the details of the market product, offer, or bundle with pricing.
- **C1-GetProdDetailRest** - This is a REST based inbound web service. It supports the JSON and XML formats. It enables you to view the details of an active market product, offer, or bundle which is effective on the processing date. You can extract the data in the following templates:
 - **Summary** - Used when you want to extract the details of the market product, offer, or bundle without pricing.
 - **Detail** - Used when you want to extract the details of the market product, offer, or bundle with pricing.

Prerequisites

The following table lists the prerequisites for eligible derivation of the active market products, offers, or bundles, to view the details of the active market products, offers, or bundles, and to enroll the account to market products, offers, or bundles through an inbound web service:

If you want to...	Then...
Drive eligible market products, offers, or bundles through an inbound web service	<p>You need to do the following:</p> <ul style="list-style-type: none"> • Retail banking product catalog definitions are created in the system. • Price item pricing defined for all the retail banking product catalog definition in the system • Define a REST or SOAP based inbound web service to call the C1_GETELIGIBLEPROD business service. • Active market products, offers, or bundles are required in the system. • Provide the required input parameters, such as, <ul style="list-style-type: none"> • Product Category • Product Code • Product Type • Entity Code • Entity Type • Person account • Process Date
View the details of the active market product, offer, or bundle through an inbound web service	<p>You need to do the following:</p> <ul style="list-style-type: none"> • Retail banking product catalog definitions are created in the system. • Price item pricing defined for all the retail banking product catalog definition in the system • Define a REST or SOAP based inbound web service to call the C1-GetProdDetail business service. • Active market products, offers, or bundles are required in the system. • Provide the required input parameters, such as, <ul style="list-style-type: none"> • Entity Code • Entity Type • Person account
Enroll the account to market products, offers, or bundles through an inbound web service	<p>You need to do the following:</p>

If you want to...	Then...
	<ul style="list-style-type: none"> • Division, Contract Type, Customer Class, and Customer details setup defined in the application to enroll the account to market products, offers, or bundles. • Definition of market products, offers, or bundles should be created in the system before sending enrollment request.

C1_GETELIGIBLEPROD Business Service

The **C1_GETELIGIBLEPROD** business service enables you to derive the eligible active market products, offers, or bundles for the person or an account on the processing date. It also enables you to view the details of an eligible active market products, offers, or bundles which are effective on the processing date. You can call this business service from an external system through an inbound web service. If you want to send the request in the XML and/or JSON format, you need to ensure that you create a REST based inbound web service in Oracle Revenue Management and Billing. However, if you want to send the request in the XML format, you can create a SOAP or REST based inbound web service in Oracle Revenue Management and Billing.

You can extract the data in the following template:

- **Summary:** Used to derive the details of the eligible active market products, offers, and/or bundles without pricing.
- **Detail:** Used to derive the details of the eligible active market products, offers, and/or bundles with pricing.

To drive for an eligible active market products, offers, or bundles for the person or account, provide the following input parameters:

- Product Category
- Product Code
- Product Type
- Entity Type
- Entity Code
- Person account
- Process Date

Note: Entity is referred to market product, offer or bundle.

Related Topics

For more information on...	See...
Eligible Market Products, Offers, or Bundles Derivation Request in the XML Format	Eligible Market Products, Offers, or Bundles Derivation Request in the XML Format on page 3291
Eligible Market Products, Offers, or Bundles Derivation Response in the XML Format	Eligible Market Products, Offers, or Bundles Derivation Response in the XML Format on page 3292
Eligible Market Products, Offers, or Bundles Derivation Request and Response - Tags in XML Format	Eligible Market Products, Offers, or Bundles Derivation Request and Response - Tags in XML Format on page 3294
Sample Eligible Market Product Derivation Request and Response in the XML Format	Sample Eligible Market Product Derivation Request and Response in the XML Format on page 3299

For more information on...	See...
Sample Eligible Offer Derivation Request and Response in the XML Format	Sample Eligible Offer Derivation Request and Response in the XML Format on page 3326
Sample Eligible Bundle Derivation Request and Response in the XML Format	Sample Eligible Bundle Derivation Request and Response in the XML Format on page 3352
Eligible Market Products, Offers, or Bundles Derivation Request in the JSON Format	Eligible Market Products, Offers, or Bundles Derivation Request in the JSON Format on page 3379
Eligible Market Products, Offers, or Bundles Derivation Response in the JSON Format	Eligible Market Products, Offers, or Bundles Derivation Response in the JSON Format on page 3379
Eligible Market Products, Offers, or Bundles Derivation Request - Attribute/Value Pairs in JSON Format	Eligible Market Products, Offers, or Bundles Derivation Request and Response - Attribute/Value Pairs in JSON Format on page 3382
Sample Eligible Market Product Derivation Request and Response in the JSON Format	Sample Eligible Market Product Derivation Request and Response in the JSON Format on page 3387
Sample Eligible Offer Derivation Request and Response in the JSON Format	Sample Eligible Offer Derivation Request and Response in the JSON Format on page 3416
Sample Eligible Bundle Derivation Request and Response in the JSON Format	Sample Eligible Bundle Derivation Request and Response in the JSON Format on page 3442

Eligible Market Products, Offers, or Bundles Derivation Request in the XML Format

The following code snippet illustrates how the tags should be nested while receiving the eligible market products, offers or bundles derivation request in the XML format:

```
<C1_GETELIGIBLEPROD>
  <productCode></productCode>
  <productCategoryFlg></productCategoryFlg>
  <division></division>
  <entityType></entityType>
  <entityCode></entityCode>
  <processDate></processDate>
  <accountId></accountId>
  <acctIdtype></acctIdtype>
  <acctIdentifierValue></acctIdentifierValue>
  <personId></personId>
  <custIdTypeCd></custIdTypeCd>
  <perIdentifireVal></perIdentifireVal>
  <productLinkedEntity>
    <linkedEntityCode></linkedEntityCode>
    <linkedEntityType></linkedEntityType>
  </productLinkedEntity>
  <eligibleParameter>
    <priceParmCode mapField="PRICE_PARM_CD" />
    <priceParmVal mapField="PRICE_PARM_VAL" />
  </eligibleParameter>
</C1_GETELIGIBLEPROD>
```

Related Topics

For more information on...	See...
Eligible Market Products, Offers, or Bundles Derivation Request and Response - Tags in XML Format	Eligible Market Products, Offers, or Bundles Derivation Request and Response - Tags in XML Format on page 3294

For more information on...	See...
Sample Eligible Market Product Derivation Request and Response in the XML Format	Sample Eligible Market Product Derivation Request and Response in the XML Format on page 3299
Sample Eligible Offer Derivation Request and Response in the XML Format	Sample Eligible Offer Derivation Request and Response in the XML Format on page 3326
Sample Eligible Bundle Derivation Request and Response in the XML Format	Sample Eligible Bundle Derivation Request and Response in the XML Format on page 3352

Eligible Market Products, Offers, or Bundles Derivation Response in the XML Format

The following code snippet illustrates how the tags should be nested while sending the eligible derivation market products, offers or bundles response in the XML format:

```
<C1_GETELIGIBLEPROD>
  <productCode></productCode>
  <productCategoryFlg></productCategoryFlg>
  <division></division>
  <entityType></entityType>
  <entityCode></entityCode>
  <processDate></processDate>
  <accountId></accountId>
  <acctIdtype></acctIdtype>
  <acctIdentifierValue></acctIdentifierValue>
  <personId></personId>
  <custIdTypeCd></custIdTypeCd>
  <perIdentifireVal></perIdentifireVal>
  <productLinkedEntity>
    <linkedEntityCode></linkedEntityCode>
    <linkedEntityType></linkedEntityType>
  </productLinkedEntity>
  <eligibleParameter>
    <priceParmCode mapField="PRICE_PARM_CD" />
    <priceParmVal mapField="PRICE_PARM_VAL" />
  </eligibleParameter>
  <entityList>
    <entityCode></entityCode>
    <entityType></entityType>
    <entityName></entityName>
    <entityStartDate></entityStartDate>
    <entityEndDate></entityEndDate>
    <entityCodeDescr></entityCodeDescr>
    <termsAndCondition></termsAndCondition>
    <termAndConditionDescr></termAndConditionDescr>
    <status></status>
  </entityList>
  <productList>
    <productCode></productCode>
    <productDescription></productDescription>
    <productTypFlgDesc></productTypFlgDesc>
    <productCategoryFlgDesc></productCategoryFlgDesc>
  </productList>
  <productLinkedEntity>
    <linkedEntityStartDate></linkedEntityStartDate>
    <linkedEntityEndDate></linkedEntityEndDate>
    <linkedEntityCode></linkedEntityCode>
    <linkedEntityType></linkedEntityType>
  </productLinkedEntity>
  <EntityDivision>
    <divisionCode></divisionCode>
  </EntityDivision>
  <eligibilityDetails>
```



```

<eligibilityStartDate></eligibilityStartDate>
<eligibilityEndDate></eligibilityEndDate>
<eligibilityDescription></eligibilityDescription>
<eligibilityRule>
  <sequenceNumber></sequenceNumber>
  <lhsPriceParmCd></lhsPriceParmCd>
  <operator></operator>
  <rhsPriceParmCd></rhsPriceParmCd>
  <rhsPriceParmVal></rhsPriceParmVal>
  <lhsPriceParmCd1></lhsPriceParmCd1>
  <rhsPriceParmTypeFlg></rhsPriceParmTypeFlg>
  <>trueFlag></trueFlag>
  <>falseFlag></falseFlag>
  <insufficientFlag></insufficientFlag>
</eligibilityRule>
</eligibilityDetails>
<services>
  <serviceName></serviceName>
  <mandatoryFlag></mandatoryFlag>
</services>
<pricing>
  <priority></priority>
  <priceListId></priceListId>
  <priceListDescription></priceListDescription>
  <priceListStartDate></priceListStartDate>
  <priceListEndDate></priceListEndDate>
  <noOfDays></noOfDays>
  <priceItemCode></priceItemCode>
  <priceitemDescr></priceitemDescr>
  <priceAsgnId></priceAsgnId>
  <validityFlag></validityFlag>
  <sourceEntityType></sourceEntityType>
  <sourceEntityCode></sourceEntityCode>
  <priceListInfo></priceListInfo>
  <priceComponent>
    <priceCompId></priceCompId>
    <pricecomptier>
      <priceCompSequenceNo></priceCompSequenceNo>
      <businessObjectDataArea></businessObjectDataArea>
      <priceItemParmGroupId></priceItemParmGroupId>
      <toVal></toVal>
      <fromVal></fromVal>
      <timeOfUse></timeOfUse>
      <priceItemCode></priceItemCode>
      <priceCriteria></priceCriteria>
      <priceCompId></priceCompId>
      <tieSeqNum></tieSeqNum>
      <version></version>
    </pricecomptier>
    <priceComponentDescription></priceComponentDescription>
    <valueAmt></valueAmt>
    <priceComponentDisplay></priceComponentDisplay>
    <rcMapId></rcMapId>
    <tieredFlag></tieredFlag>
    <priceCompSequenceNo2></priceCompSequenceNo2>
  </priceComponent>
</pricing>
</entityList>
<messageCategory></messageCategory>
<messageNumber></messageNumber>
<messageText></messageText>
<longDescription></longDescription>
<inquiryTypeFlag></inquiryTypeFlag>
</C1_GETELIGIBLEPROD>

```

Related Topics

For more information on...	See...
Eligible Market Products, Offers, or Bundles Derivation Request and Response - Tags in XML Format	Eligible Market Products, Offers, or Bundles Derivation Request and Response - Tags in XML Format on page 3294
Sample Eligible Market Product Derivation Request and Response in the XML Format	Sample Eligible Market Product Derivation Request and Response in the XML Format on page 3299
Sample Eligible Offer Derivation Request and Response in the XML Format	Sample Eligible Offer Derivation Request and Response in the XML Format on page 3326
Sample Eligible Bundle Derivation Request and Response in the XML Format	Sample Eligible Bundle Derivation Request and Response in the XML Format on page 3352

Eligible Market Products, Offers, or Bundles Derivation Request and Response - Tags in XML Format

Note: We recommend you to refer the topics [Eligible Market Products, Offers, or Bundles Derivation Request in the XML Format](#) on page 3291 and [Eligible Market Products, Offers, or Bundles Derivation Response in the XML Format](#) on page 3292 in parallel while understanding the below mentioned tags. This will help you to understand how the tags are nested in the XML format.

Before calling the **C1_GETELIGIBLEPROD** business service through an inbound web service, you need to ensure that the eligible active market products, offers, or bundles derivation request contains the following tags:

Tag Name	Tag Description	Mandatory (Yes or No)
productCode	Used to specify the product code to derive the details of the eligible active entities.	Yes(Conditional)
	Note: Entity is referred to market product, offer or bundle.	Note: This field is required if the product category, entity type, or entity code are not entered.
productCategoryFlg	Used to specify the product category flag to derive the details of the eligible active entities.	No
	Note: Entity is referred to market product, offer or bundle.	
division	Used to specify the division to derive the details of the eligible active entities which are associated with a particular division.	Yes(Conditional)
		Note: This field is required with product code, product category, entity type or entity code to derive the entities of the specific division.
entityType	Used to indicate the entity type to derive the details of the eligible active entities.	Yes(Conditional)
		Note: This field is required if the entity code is entered.

Tag Name	Tag Description	Mandatory (Yes or No)
		Note: This field is required if the product code, or product category are not entered.
entityCode	Used to specify the entity code to derive the details of the eligible active entities.	Yes(Conditional) Note: This field is required if the product code or product category are not entered.
processDate	Used to specify the date to derive the details of effective market products, offers, or bundles for that date.	Yes(Conditional) Note: If the date is not entered then it will display the default date from the system on which the enquiry is made.
accountId	Used to indicate the account for which you want to derive the details of the active entities.	Yes(Conditional) Note: If this field is not entered then all active entities will be extract. Note: This field is required if you want to derive the details of eligible active entities for specific person or account.
acctIdtype	Used to indicate the type of account identifier type for which you to derive the details of the eligible active entity.	No
acctIdentifierValue	Used to specify the value for the account identifier type for which you to derive the details of the eligible active entities.	Yes(Conditional) Note: This field is required if you want to derive the details of eligible active entities for specific person or account.
personId	Used to specify the person account for which you want to derive the details of eligible active market products, offers, or bundles.	Yes(Conditional) Note: This field is required if you want to derive the details of eligible active entities for specific person or account.
custIdTypeCd	Used to indicate the customer ID type for which you want to derive the details of eligible active market products, offers, or bundles.	No
perIdentifireVal	Used to specify the value of person identifier for which you want to derive the details of eligible active market products, offers, or bundles.	No

Tag Name	Tag Description	Mandatory (Yes or No)
productLinkedEntity	Used to specify product linked entity(market product code) for which you want to derive the details of eligible active offers or bundles linked with that particular code.	No
linkedEntityCode	Used to specify code of the linked entity(market product code) for which you want to derive the details of eligible active offers or bundles linked with that particular code.	Yes(Conditional) Note: This field is required when you want to derive offer or bundle linked with the particular market product.
linkedEntityType	Used to indicate type of the linked entity(market product code) for which you want to derive the details of eligible active offer or bundle linked with that particular code.	Yes(Conditional) Note: This field is required when you want to derive offer or bundle linked with the particular market product.
eligibleParameter	Used to specify the eligibility parameter based on which you want to derive the details of eligible active market products, offers, or bundles.	Yes(Conditional) Note: If this field is not entered then system will take the eligibility details from the person or account.
priceParmCode	Used to specify the eligibility parameter code based on which you want to derive the details of eligible active market products, offers, or bundles.	Yes(Conditional) Note: If this field is not entered then system will take the eligibility details from the person or account.
priceParmVal	Used to specify the eligibility parameter value based on which you want to derive the details of eligible active market products, offers, or bundles.	Yes(Conditional) Note: If this field is not entered then system will take the eligibility details from the person or account.

The following table lists and describes the tags which appear in the eligible active market products, offers, or bundles derivation response XML format:

Tag Name	Tag Description
entityList	Displays the list of eligible market products, offers, or bundles.
entityCode	Displays the entity code.
entityType	Displays the entity type.
entityName	Displays the entity name.
entityStartDate	Displays the date from when the entity is effective.
entityEndDate	Displays the date till when the entity is effective.

Tag Name	Tag Description
entityCodeDescr	Displays the description of the entity code.
termsAndCondition	Displays the terms and condition of the entity.
termAndConditionDesc	Displays the description of the terms and conditions of the entity.
status	Displays the status of the entity.
productList	Displays the list of the eligible products to which the requested entity belongs.
productCode	Displays the code of the eligible product to which the requested entity belongs.
productDescription	Displays the description of the eligible product to which the requested entity belongs.
productTypFlgDesc	Displays the description of the eligible product type flag to which the requested entity belongs.
productCategoryFlgDesc	Displays the description of the eligible product category flag to which the requested entity belongs.
productLinkedEntity	Displays the list of eligible market products, offers, and bundles.
linkedEntityStartDate	Displays the date from when the linked entity is effective.
linkedEntityEndDate	Displays the date till when the linked entity is effective.
linkedEntityCode	Displays the linked entity code for the requested entity code.
linkedEntityType	Displays the linked entity type for the requested entity code. Note: It is applicable in case of offer and bundle.
EntityDivision	Displays the division to which the requested entity belongs.
divisionCode	Displays the division code to which the requested entity belongs.
eligibilityDetails	Indicates the name of group tag.
eligibilityStartDate	Displays the date from when the eligibility of the entity is effective.
eligibilityEndDate	Displays the date till when the eligibility of the entity is effective.
eligibilityDescription	Displays the description of the eligibility to which the requested entity belongs.
eligibilityRule	Indicates the name of group tag.
sequenceNumber	Indicates the sequence number of eligibility condition.
lhsPriceParmCd	Indicates the left side parameter code of the eligibility condition.
operator	Indicates the operator to evaluate the condition.
rhsPriceParmCd	Indicates the right side parameter code of the eligibility condition.
rhsPriceParmVal	Indicates the right side parameter value of the eligibility condition.
lhsPriceParmCd1	Indicates the left side parameter code of the eligibility condition.
rhsPriceParmTypeFlg	Indicates the value of the right side flag.
trueFlag	Indicates the true eligibility condition.
falseFlag	Indicates the false eligibility condition.
insufficientFlag	Indicates the insufficient eligibility condition.
services	Indicates the name of group tag.

Tag Name	Tag Description
serviceName	Displays the service configured to the requested entity code.
mandatoryFlag	Indicates the mandatory or optional type of the services.
pricing	Indicates the name of group tag.
priority	Displays the priority in sequence of the price list of the entities.
priceListId	Displays the Price List ID.
priceListDescription	Displays the description of the price list.
priceListStartDate	Displays the date from when the price list of the entity is effective.
priceListEndDate	Displays the date till when the price list of the entity is effective.
noOfDays	Displays the validity of price list in number of days.
priceItemCode	Displays the price item code.
priceitemDescr	Displays the description of the price item.
priceAsgnId	Displays the price assignment ID.
validityFlag	Indicates the validity of the price item.
sourceEntityType	Displays the source entity type.
sourceEntityCode	Displays the source entity code.
priceListInfo	Displays the information of the price list.
priceComponent	Indicates the name of group tag.
priceCompId	Displays the price component ID.
pricecomptier	Indicates the name of group tag.
priceCompSequenceNo	Displays the sequence number of the price component.
priceItemParmGroupID	Displays the parameter group ID of the price item.
toVal	Indicates the tiering to value of the price item.
fromVal	Indicates the tiering from value of the price item.
timeOfUse	Indicates the tiering time of use.
priceItemCode	Displays the price item code.
priceCriteria	Displays the price criteria of the price item.
priceCompId	Displays the price component ID.
tieSeqNum	Indicates the tiering sequence number.
version	Displays the version number.
priceComponentDescription	Displays the description of the price component.
valueAmt	Displays the value amount of the price component.
priceComponentDisplay	Displays the price component.
rcMapId	Displays the rate component map ID.
tieredFlag	Indicates the tire flag.

Tag Name	Tag Description
priceCompSequenceNo	Displays the sequence of the price component.
messageCategory	Indicates the category of the message.
messageNumber	Indicates the number of the message.
messageText	Displays the message.
longDescription	Displays the long description.
inquiryTypeFlag	Displays the inquiry type flag. Note: If the inquiry type flag value is SMRY then service will provide details of eligible entities without price component and if the inquiry type flag value is DETL then service will provide details of eligible entities with price component

Related Topics

For more information on...	See...
Sample Eligible Market Product Derivation Request and Response in the XML Format	Sample Eligible Market Product Derivation Request and Response in the JSON Format on page 3387
Sample Eligible Offer Derivation Request and Response in the XML Format	Sample Eligible Offer Derivation Request and Response in the XML Format on page 3326
Sample Eligible Bundle Derivation Request and Response in the XML Format	Sample Eligible Bundle Derivation Request and Response in the XML Format on page 3352

Sample Eligible Market Product Derivation Request and Response in the XML Format

Using the below example, you can derive eligible market products for the **2406432705** account which are processed on **2022-01-11**.

Sample Eligible Market Product Request in the XML Format

```
<C1_GETELIGIBLEPROD>
  <productCode>LOAN_001</productCode>
  <productCategoryFlg></productCategoryFlg>
  <division>IND</division>
  <entityType>MP</entityType>
  <entityCode>CHECKMP_001</entityCode>
  <processDate>2022-01-11</processDate>
  <accountId>2406432705</accountId>
  <acctIdtype></acctIdtype>
  <acctIdentifierValue></acctIdentifierValue>
  <personId></personId>
  <custIdTypeCd></custIdTypeCd>
  <perIdentifireVal></perIdentifireVal>
  <productLinkedEntity>
    <linkedEntityCode>CHECKMP_001</linkedEntityCode>
    <linkedEntityType>MP</linkedEntityType>
  </productLinkedEntity>
  <productLinkedEntity>
    <linkedEntityCode>CHECKMP_002</linkedEntityCode>
    <linkedEntityType>MP</linkedEntityType>
  </productLinkedEntity>
  <eligibleParameter>
    <priceParmCode>ACC_DIVISION</priceParmCode>
    <priceParmVal>IND</priceParmVal>
  </eligibleParameter>
</C1_GETELIGIBLEPROD>
```

```

    <eligibleParameter>
      <priceParmCode>PERSON_STATE</priceParmCode>
      <priceParmVal>MH</priceParmVal>
    </eligibleParameter>
  </C1_GETELIGIBLEPROD>

```

Sample Eligible Market Product Response in the XML Format

```

<C1_GETELIGIBLEPROD>
  <productCode>LOAN_001</productCode>
  <productCategoryFlg></productCategoryFlg>
  <division>IND</division>
  <entityType>MP</entityType>
  <entityCode>CHECKMP_001</entityCode>
  <processDate>2022-01-11</processDate>
  <accountId>2406432705</accountId>
  <acctIdtype></acctIdtype>
  <acctIdentifierValue></acctIdentifierValue>
  <personId></personId>
  <custIdTypeCd></custIdTypeCd>
  <perIdentifireVal></perIdentifireVal>
  <productLinkedEntity>
    <linkedEntityCode>CHECKMP_001</linkedEntityCode>
    <linkedEntityType>MP</linkedEntityType>
  </productLinkedEntity>
  <productLinkedEntity>
    <linkedEntityCode>CHECKMP_002</linkedEntityCode>
    <linkedEntityType>MP</linkedEntityType>
  </productLinkedEntity>
  <eligibleParameter>
    <priceParmCode>ACC_DIVISION</priceParmCode>
    <priceParmVal>IND</priceParmVal>
  </eligibleParameter>
  <eligibleParameter>
    <priceParmCode>PERSON_STATE</priceParmCode>
    <priceParmVal>MH</priceParmVal>
  </eligibleParameter>
  <entityList>
    <entityCode>CHECKMP_001</entityCode>
    <entityType>MP</entityType>
    <entityName>CHECKMP_001</entityName>
    <entityStartDate>2022-01-11</entityStartDate>
    <entityEndDate></entityEndDate>
    <entityCodeDescr></entityCodeDescr>
    <termsAndCondition>TERMSPRAAS</termsAndCondition>
    <termAndConditionDescr>TERMSPRAAS</termAndConditionDescr>
    <status>ACTIVE</status>
    <productList>
      <productCode>LOAN_001</productCode>
      <productDescription>LOAN_001</productDescription>
      <productTypFlgDesc>Product</productTypFlgDesc>
      <productCategoryFlgDesc>Loans</productCategoryFlgDesc>
    </productList>
    <productLinkedEntity>
      <linkedEntityStartDate></linkedEntityStartDate>
      <linkedEntityEndDate></linkedEntityEndDate>
      <linkedEntityCode></linkedEntityCode>
      <linkedEntityType></linkedEntityType>
    </productLinkedEntity>
    <EntityDivision>
      <divisionCode>IND</divisionCode>
    </EntityDivision>
    <eligibilityDetails>
      <eligibilityStartDate>2022-01-11</eligibilityStartDate>

```



```

<eligibilityEndDate></eligibilityEndDate>
<eligibilityDescription>ELG_001</eligibilityDescription>
<eligibilityRule>
  <sequenceNumber>10</sequenceNumber>
  <lhsPriceParmCd>ACC_DIVISION</lhsPriceParmCd>
  <operator>=</operator>
  <rhsPriceParmCd></rhsPriceParmCd>
  <rhsPriceParmVal>IND</rhsPriceParmVal>
  <lhsPriceParmCd1></lhsPriceParmCd1>
  <rhsPriceParmTypeFlg>VAL</rhsPriceParmTypeFlg>
  <trueFlag>RLTR</trueFlag>
  <falseFlag>RLFS</falseFlag>
  <insufficientFlag>RLFS</insufficientFlag>
</eligibilityRule>
</eligibilityDetails>
<eligibilityDetails>
  <eligibilityStartDate></eligibilityStartDate>
  <eligibilityEndDate></eligibilityEndDate>
  <eligibilityDescription></eligibilityDescription>
  <eligibilityRule>
    <sequenceNumber>20</sequenceNumber>
    <lhsPriceParmCd>PERSON_STATE</lhsPriceParmCd>
    <operator>=</operator>
    <rhsPriceParmCd></rhsPriceParmCd>
    <rhsPriceParmVal>CA</rhsPriceParmVal>
    <lhsPriceParmCd1></lhsPriceParmCd1>
    <rhsPriceParmTypeFlg>VAL</rhsPriceParmTypeFlg>
    <trueFlag>RLTR</trueFlag>
    <falseFlag>RLTR</falseFlag>
    <insufficientFlag>RLFS</insufficientFlag>
  </eligibilityRule>
</eligibilityDetails>
<eligibilityDetails>
  <eligibilityStartDate></eligibilityStartDate>
  <eligibilityEndDate></eligibilityEndDate>
  <eligibilityDescription></eligibilityDescription>
  <eligibilityRule>
    <sequenceNumber>30</sequenceNumber>
    <lhsPriceParmCd>ACCOUNT_CURRENCY</lhsPriceParmCd>
    <operator></operator>
    <rhsPriceParmCd></rhsPriceParmCd>
    <rhsPriceParmVal>USD</rhsPriceParmVal>
    <lhsPriceParmCd1></lhsPriceParmCd1>
    <rhsPriceParmTypeFlg>VAL</rhsPriceParmTypeFlg>
    <trueFlag>RLTR</trueFlag>
    <falseFlag>RLTR</falseFlag>
    <insufficientFlag>RLFS</insufficientFlag>
  </eligibilityRule>
</eligibilityDetails>
<services>
  <serviceName>Product Service PRASS2</serviceName>
  <mandatoryFlag>true</mandatoryFlag>
</services>
<services>
  <serviceName>MH division product service</serviceName>
  <mandatoryFlag>true</mandatoryFlag>
</services>
<services>
  <serviceName>Product Service PRASS1</serviceName>
  <mandatoryFlag>true</mandatoryFlag>
</services>
<pricing>
  <priority>2</priority>
  <priceListId>4368251923</priceListId>

```

```

<priceListDescription>Currency_Con_PriceList -1</priceListDescription>
  <priceListStartDate>2022-01-11</priceListStartDate>
  <priceListEndDate>2022-02-10</priceListEndDate>
  <noOfDays>30</noOfDays>
  <priceItemCode>CC_021</priceItemCode>
  <priceitemDescr>CC_21-Account Opening Fee</priceitemDescr>
  <priceAsgnId>4360009281</priceAsgnId>
  <validityFlag></validityFlag>
  <sourceEntityType></sourceEntityType>
  <sourceEntityCode></sourceEntityCode>
  <priceListInfo></priceListInfo>
  <priceComponent>
    <priceCompId>4367475002</priceCompId>
    <pricecomptier>
      <priceCompSequenceNo></priceCompSequenceNo>
      <businessObjectDataArea></businessObjectDataArea>
      <priceItemParmGroupId></priceItemParmGroupId>
      <toVal></toVal>
      <fromVal></fromVal>
      <timeOfUse></timeOfUse>
      <priceItemCode></priceItemCode>
      <priceCriteria></priceCriteria>
      <priceCompId></priceCompId>
      <tieSeqNum></tieSeqNum>
      <version></version>
    </pricecomptier>
    <priceComponentDescription>FLAT</priceComponentDescription>
    <valueAmt>0.400000000000000000</valueAmt>
    <priceComponentDisplay>false</priceComponentDisplay>
    <rcMapId></rcMapId>
    <tieredFlag></tieredFlag>
    <priceCompSequenceNo2>0</priceCompSequenceNo2>
  </priceComponent>
</pricing>
<pricing>
  <priority>2</priority>
  <priceListId>4368251923</priceListId>
  <priceListDescription>Currency_Con_PriceList -1</priceListDescription>
  <priceListStartDate>2022-01-11</priceListStartDate>
  <priceListEndDate>2022-02-10</priceListEndDate>
  <noOfDays>30</noOfDays>
  <priceItemCode>CC_022</priceItemCode>
  <priceitemDescr>CC2-Monthly Acct Serv Fee</priceitemDescr>
  <priceAsgnId>4360009282</priceAsgnId>
  <validityFlag></validityFlag>
  <sourceEntityType></sourceEntityType>
  <sourceEntityCode></sourceEntityCode>
  <priceListInfo></priceListInfo>
  <priceComponent>
    <priceCompId>4367475004</priceCompId>
    <pricecomptier>
      <priceCompSequenceNo></priceCompSequenceNo>
      <businessObjectDataArea></businessObjectDataArea>
      <priceItemParmGroupId></priceItemParmGroupId>
      <toVal></toVal>
      <fromVal></fromVal>
      <timeOfUse></timeOfUse>
      <priceItemCode></priceItemCode>
      <priceCriteria></priceCriteria>
      <priceCompId></priceCompId>
      <tieSeqNum></tieSeqNum>
      <version></version>
    </pricecomptier>
    <priceComponentDescription>FLAT</priceComponentDescription>

```

```

        <valueAmt>0.600000000000000000</valueAmt>
        <priceComponentDisplay>>false</priceComponentDisplay>
        <rcMapId></rcMapId>
        <tieredFlag></tieredFlag>
        <priceCompSequenceNo2>0</priceCompSequenceNo2>
    </priceComponent>
</pricing>
<pricing>
    <priority>2</priority>
    <priceListId>4368251923</priceListId>
    <priceListDescription>Currency_Con_PriceList -1</priceListDescription>
    <priceListStartDate>2022-01-11</priceListStartDate>
    <priceListEndDate>2022-02-10</priceListEndDate>
    <noOfDays>30</noOfDays>
    <priceItemCode>CC_024</priceItemCode>
    <priceitemDescr>CC3-SEPA Transfers</priceitemDescr>
    <priceAsgnId>4360009283</priceAsgnId>
    <validityFlag></validityFlag>
    <sourceEntityType></sourceEntityType>
    <sourceEntityCode></sourceEntityCode>
    <priceListInfo></priceListInfo>
    <priceComponent>
        <priceCompId>4367475006</priceCompId>
        <pricecomptier>
            <priceCompSequenceNo></priceCompSequenceNo>
            <businessObjectDataArea></businessObjectDataArea>
            <priceItemParmGroupId></priceItemParmGroupId>
            <toVal></toVal>
            <fromVal></fromVal>
            <timeOfUse></timeOfUse>
            <priceItemCode></priceItemCode>
            <priceCriteria></priceCriteria>
            <priceCompId></priceCompId>
            <tieSeqNum></tieSeqNum>
            <version></version>
        </pricecomptier>
        <priceComponentDescription>FLAT</priceComponentDescription>
        <valueAmt>0.250000000000000000</valueAmt>
        <priceComponentDisplay>>false</priceComponentDisplay>
        <rcMapId></rcMapId>
        <tieredFlag></tieredFlag>
        <priceCompSequenceNo2>0</priceCompSequenceNo2>
    </priceComponent>
</pricing>
<pricing>
    <priority>2</priority>
    <priceListId>4368251923</priceListId>
    <priceListDescription>Currency_Con_PriceList -1</priceListDescription>
    <priceListStartDate>2022-01-11</priceListStartDate>
    <priceListEndDate>2022-02-10</priceListEndDate>
    <noOfDays>30</noOfDays>
    <priceItemCode>CC_025</priceItemCode>
    <priceitemDescr>CC4-Domestic Funds Transfer Fee</priceitemDescr>
    <priceAsgnId>4360009284</priceAsgnId>
    <validityFlag></validityFlag>
    <sourceEntityType></sourceEntityType>
    <sourceEntityCode></sourceEntityCode>
    <priceListInfo></priceListInfo>
    <priceComponent>
        <priceCompId>4367475008</priceCompId>
        <pricecomptier>
            <priceCompSequenceNo></priceCompSequenceNo>
            <businessObjectDataArea></businessObjectDataArea>
            <priceItemParmGroupId></priceItemParmGroupId>

```

```

        <toVal></toVal>
        <fromVal></fromVal>
        <timeOfUse></timeOfUse>
        <priceItemCode></priceItemCode>
        <priceCriteria></priceCriteria>
        <priceCompId></priceCompId>
        <tieSeqNum></tieSeqNum>
        <version></version>
    </pricecomptier>
    <priceComponentDescription>FLAT</priceComponentDescription>
    <valueAmt>112.040000000000000000</valueAmt>
    <priceComponentDisplay>>false</priceComponentDisplay>
    <rcMapId></rcMapId>
    <tieredFlag></tieredFlag>
    <priceCompSequenceNo2>0</priceCompSequenceNo2>
</priceComponent>
</pricing>
<pricing>
    <priority>1</priority>
    <priceListId>5417730766</priceListId>
    <priceListDescription>PriceList -1</priceListDescription>
    <priceListStartDate>2022-01-11</priceListStartDate>
    <priceListEndDate>2022-02-28</priceListEndDate>
    <noOfDays></noOfDays>
    <priceItemCode>PI_021</priceItemCode>
    <priceitemDescr>V1-Account Opening Fee</priceitemDescr>
    <priceAsgnId>5410009202</priceAsgnId>
    <validityFlag></validityFlag>
    <sourceEntityType></sourceEntityType>
    <sourceEntityCode></sourceEntityCode>
    <priceListInfo></priceListInfo>
    <priceComponent>
        <priceCompId>5417300004</priceCompId>
        <pricecomptier>
            <priceCompSequenceNo></priceCompSequenceNo>
            <businessObjectDataArea></businessObjectDataArea>
            <priceItemParmGroupId></priceItemParmGroupId>
            <toVal></toVal>
            <fromVal></fromVal>
            <timeOfUse></timeOfUse>
            <priceItemCode></priceItemCode>
            <priceCriteria></priceCriteria>
            <priceCompId></priceCompId>
            <tieSeqNum></tieSeqNum>
            <version></version>
        </pricecomptier>
        <priceComponentDescription>FLAT</priceComponentDescription>
        <valueAmt>0.250000000000000000</valueAmt>
        <priceComponentDisplay>>false</priceComponentDisplay>
        <rcMapId></rcMapId>
        <tieredFlag></tieredFlag>
        <priceCompSequenceNo2>0</priceCompSequenceNo2>
    </priceComponent>
</pricing>
<pricing>
    <priority>1</priority>
    <priceListId>5417730766</priceListId>
    <priceListDescription>PriceList -1</priceListDescription>
    <priceListStartDate>2022-01-11</priceListStartDate>
    <priceListEndDate>2022-02-28</priceListEndDate>
    <noOfDays></noOfDays>
    <priceItemCode>PI_022</priceItemCode>
    <priceitemDescr>V2-Monthly Acct Serv Fee</priceitemDescr>
    <priceAsgnId>5410009203</priceAsgnId>

```

```

<validiyFlag></validiyFlag>
<sourceEntityType></sourceEntityType>
<sourceEntityCode></sourceEntityCode>
<priceListInfo></priceListInfo>
<priceComponent>
  <priceCompId>5417300006</priceCompId>
  <pricecomptier>
    <priceCompSequenceNo></priceCompSequenceNo>
    <businessObjectDataArea></businessObjectDataArea>
    <priceItemParmGroupId></priceItemParmGroupId>
    <toVal></toVal>
    <fromVal></fromVal>
    <timeOfUse></timeOfUse>
    <priceItemCode></priceItemCode>
    <priceCriteria></priceCriteria>
    <priceCompId></priceCompId>
    <tieSeqNum></tieSeqNum>
    <version></version>
  </pricecomptier>
  <priceComponentDescription>FLAT</priceComponentDescription>
  <valueAmt>112.040000000000000000</valueAmt>
  <priceComponentDisplay>>false</priceComponentDisplay>
  <rcMapId></rcMapId>
  <tieredFlag></tieredFlag>
  <priceCompSequenceNo2>0</priceCompSequenceNo2>
</priceComponent>
</pricing>
<pricing>
  <priority>1</priority>
  <priceListId>5417730766</priceListId>
  <priceListDescription>PriceList -1</priceListDescription>
  <priceListStartDate>2022-01-11</priceListStartDate>
  <priceListEndDate>2022-02-28</priceListEndDate>
  <noOfDays></noOfDays>
  <priceItemCode>PI_023</priceItemCode>
  <priceitemDescr>V3-Audit Reports</priceitemDescr>
  <priceAsgnId>5410009204</priceAsgnId>
  <validiyFlag></validiyFlag>
  <sourceEntityType></sourceEntityType>
  <sourceEntityCode></sourceEntityCode>
  <priceListInfo></priceListInfo>
  <priceComponent>
    <priceCompId>5417300008</priceCompId>
    <pricecomptier>
      <priceCompSequenceNo></priceCompSequenceNo>
      <businessObjectDataArea></businessObjectDataArea>
      <priceItemParmGroupId></priceItemParmGroupId>
      <toVal></toVal>
      <fromVal></fromVal>
      <timeOfUse></timeOfUse>
      <priceItemCode></priceItemCode>
      <priceCriteria></priceCriteria>
      <priceCompId></priceCompId>
      <tieSeqNum></tieSeqNum>
      <version></version>
    </pricecomptier>
    <priceComponentDescription>FLAT</priceComponentDescription>
    <valueAmt>276.250000000000000000</valueAmt>
    <priceComponentDisplay>>false</priceComponentDisplay>
    <rcMapId></rcMapId>
    <tieredFlag></tieredFlag>
    <priceCompSequenceNo2>0</priceCompSequenceNo2>
  </priceComponent>
</pricing>

```

```

<pricing>
  <priority>1</priority>
  <priceListId>5417730766</priceListId>
  <priceListDescription>PriceList -1</priceListDescription>
  <priceListStartDate>2022-01-11</priceListStartDate>
  <priceListEndDate>2022-02-28</priceListEndDate>
  <noOfDays></noOfDays>
  <priceItemCode>PI_024</priceItemCode>
  <priceitemDescr>V4-SEPA Transfers</priceitemDescr>
  <priceAsgnId>5410009241</priceAsgnId>
  <validityFlag></validityFlag>
  <sourceEntityType></sourceEntityType>
  <sourceEntityCode></sourceEntityCode>
  <priceListInfo></priceListInfo>
  <priceComponent>
    <priceCompId>5417400004</priceCompId>
    <pricecomptier>
      <priceCompSequenceNo>0</priceCompSequenceNo>
      <businessObjectDataArea></businessObjectDataArea>
      <priceItemParmGroupId>1</priceItemParmGroupId>
      <toVal>1000.00000000000000000000</toVal>
      <fromVal>0.00000000000000000000</fromVal>
      <timeOfUse></timeOfUse>
      <priceItemCode>PI_024</priceItemCode>
      <priceCriteria>NBRTRAN</priceCriteria>
      <priceCompId></priceCompId>
      <tieSeqNum>10</tieSeqNum>
      <version>0</version>
    </pricecomptier>
    <pricecomptier>
      <priceCompSequenceNo>0</priceCompSequenceNo>
      <businessObjectDataArea></businessObjectDataArea>
      <priceItemParmGroupId>1</priceItemParmGroupId>
      <toVal>5000.00000000000000000000</toVal>
      <fromVal>1000.00000000000000000000</fromVal>
      <timeOfUse></timeOfUse>
      <priceItemCode>PI_024</priceItemCode>
      <priceCriteria>NBRTRAN</priceCriteria>
      <priceCompId></priceCompId>
      <tieSeqNum>10</tieSeqNum>
      <version>0</version>
    </pricecomptier>
    <pricecomptier>
      <priceCompSequenceNo>0</priceCompSequenceNo>
      <businessObjectDataArea></businessObjectDataArea>
      <priceItemParmGroupId>1</priceItemParmGroupId>
      <toVal>999999999999.99000000000000000000</toVal>
      <fromVal>5000.00000000000000000000</fromVal>
      <timeOfUse></timeOfUse>
      <priceItemCode>PI_024</priceItemCode>
      <priceCriteria>NBRTRAN</priceCriteria>
      <priceCompId></priceCompId>
      <tieSeqNum>10</tieSeqNum>
      <version>0</version>
    </pricecomptier>
    <priceComponentDescription>Price per transaction - Step Tier
1</priceComponentDescription>
    <valueAmt>12.950000000000000000</valueAmt>
    <priceComponentDisplay>false</priceComponentDisplay>
    <rcMapId></rcMapId>
    <tieredFlag></tieredFlag>
    <priceCompSequenceNo2>0</priceCompSequenceNo2>
  </priceComponent>
</priceComponent>

```

```

<priceCompId>5417400005</priceCompId>
<pricecomptier>
  <priceCompSequenceNo>0</priceCompSequenceNo>
  <businessObjectDataArea></businessObjectDataArea>
  <priceItemParmGroupId>1</priceItemParmGroupId>
  <toVal>1000.00000000000000000000</toVal>
  <fromVal>0.00000000000000000000</fromVal>
  <timeOfUse></timeOfUse>
  <priceItemCode>PI_024</priceItemCode>
  <priceCriteria>NBRTRAN</priceCriteria>
  <priceCompId></priceCompId>
  <tieSeqNum>10</tieSeqNum>
  <version>0</version>
</pricecomptier>
<pricecomptier>
  <priceCompSequenceNo>0</priceCompSequenceNo>
  <businessObjectDataArea></businessObjectDataArea>
  <priceItemParmGroupId>1</priceItemParmGroupId>
  <toVal>5000.00000000000000000000</toVal>
  <fromVal>1000.00000000000000000000</fromVal>
  <timeOfUse></timeOfUse>
  <priceItemCode>PI_024</priceItemCode>
  <priceCriteria>NBRTRAN</priceCriteria>
  <priceCompId></priceCompId>
  <tieSeqNum>10</tieSeqNum>
  <version>0</version>
</pricecomptier>
<pricecomptier>
  <priceCompSequenceNo>0</priceCompSequenceNo>
  <businessObjectDataArea></businessObjectDataArea>
  <priceItemParmGroupId>1</priceItemParmGroupId>
  <toVal>99999999999.99000000000000000000</toVal>
  <fromVal>5000.00000000000000000000</fromVal>
  <timeOfUse></timeOfUse>
  <priceItemCode>PI_024</priceItemCode>
  <priceCriteria>NBRTRAN</priceCriteria>
  <priceCompId></priceCompId>
  <tieSeqNum>10</tieSeqNum>
  <version>0</version>
</pricecomptier>
  <priceComponentDescription>Price per transaction - Step Tier
2</priceComponentDescription>
  <valueAmt>12.15000000000000000000</valueAmt>
  <priceComponentDisplay>false</priceComponentDisplay>
  <rcMapId></rcMapId>
  <tieredFlag></tieredFlag>
  <priceCompSequenceNo2>0</priceCompSequenceNo2>
</priceComponent>
<priceComponent>
  <priceCompId>5417400006</priceCompId>
  <pricecomptier>
    <priceCompSequenceNo>0</priceCompSequenceNo>
    <businessObjectDataArea></businessObjectDataArea>
    <priceItemParmGroupId>1</priceItemParmGroupId>
    <toVal>1000.00000000000000000000</toVal>
    <fromVal>0.00000000000000000000</fromVal>
    <timeOfUse></timeOfUse>
    <priceItemCode>PI_024</priceItemCode>
    <priceCriteria>NBRTRAN</priceCriteria>
    <priceCompId></priceCompId>
    <tieSeqNum>10</tieSeqNum>
    <version>0</version>
  </pricecomptier>
</priceComponent>

```

```

        <priceCompSequenceNo>0</priceCompSequenceNo>
        <businessObjectDataArea></businessObjectDataArea>
        <priceItemParmGroupId>1</priceItemParmGroupId>
        <toVal>5000.00000000000000000000</toVal>
        <fromVal>1000.00000000000000000000</fromVal>
        <timeOfUse></timeOfUse>
        <priceItemCode>PI_024</priceItemCode>
        <priceCriteria>NBRTRAN</priceCriteria>
        <priceCompId></priceCompId>
        <tieSeqNum>10</tieSeqNum>
        <version>0</version>
    </pricecomptier>
    <pricecomptier>
        <priceCompSequenceNo>0</priceCompSequenceNo>
        <businessObjectDataArea></businessObjectDataArea>
        <priceItemParmGroupId>1</priceItemParmGroupId>
        <toVal>999999999999.99000000000000000000</toVal>
        <fromVal>5000.00000000000000000000</fromVal>
        <timeOfUse></timeOfUse>
        <priceItemCode>PI_024</priceItemCode>
        <priceCriteria>NBRTRAN</priceCriteria>
        <priceCompId></priceCompId>
        <tieSeqNum>10</tieSeqNum>
        <version>0</version>
    </pricecomptier>
    <priceComponentDescription>Price per transaction - Step Tier
3</priceComponentDescription>
    <valueAmt>11.95000000000000000000</valueAmt>
    <priceComponentDisplay>false</priceComponentDisplay>
    <rcMapId></rcMapId>
    <tieredFlag></tieredFlag>
    <priceCompSequenceNo2>0</priceCompSequenceNo2>
</priceComponent>
</pricing>
<pricing>
    <priority>1</priority>
    <priceListId>5417730766</priceListId>
    <priceListDescription>PriceList -1</priceListDescription>
    <priceListStartDate>2022-01-11</priceListStartDate>
    <priceListEndDate>2022-02-28</priceListEndDate>
    <noOfDays></noOfDays>
    <priceItemCode>PI_025</priceItemCode>
    <priceitemDescr>V5-Domestic Funds Transfer Fee</priceitemDescr>
    <priceAsgnId>5410009242</priceAsgnId>
    <validityFlag></validityFlag>
    <sourceEntityType></sourceEntityType>
    <sourceEntityCode></sourceEntityCode>
    <priceListInfo></priceListInfo>
    <priceComponent>
        <priceCompId>5417400010</priceCompId>
        <pricecomptier>
            <priceCompSequenceNo>0</priceCompSequenceNo>
            <businessObjectDataArea></businessObjectDataArea>
            <priceItemParmGroupId>1</priceItemParmGroupId>
            <toVal>1000.00000000000000000000</toVal>
            <fromVal>0.00000000000000000000</fromVal>
            <timeOfUse></timeOfUse>
            <priceItemCode>PI_025</priceItemCode>
            <priceCriteria>NBRTRAN</priceCriteria>
            <priceCompId></priceCompId>
            <tieSeqNum>10</tieSeqNum>
            <version>0</version>
        </pricecomptier>
    </priceComponent>

```



```

        <priceCompSequenceNo>0</priceCompSequenceNo>
        <businessObjectDataArea></businessObjectDataArea>
        <priceItemParmGroupId>1</priceItemParmGroupId>
        <toVal>5000.00000000000000000000</toVal>
        <fromVal>1000.00000000000000000000</fromVal>
        <timeOfUse></timeOfUse>
        <priceItemCode>PI_025</priceItemCode>
        <priceCriteria>NBRTRAN</priceCriteria>
        <priceCompId></priceCompId>
        <tieSeqNum>10</tieSeqNum>
        <version>0</version>
    </pricemcptier>
    <pricemcptier>
        <priceCompSequenceNo>0</priceCompSequenceNo>
        <businessObjectDataArea></businessObjectDataArea>
        <priceItemParmGroupId>1</priceItemParmGroupId>
        <toVal>999999999999.99000000000000000000</toVal>
        <fromVal>5000.00000000000000000000</fromVal>
        <timeOfUse></timeOfUse>
        <priceItemCode>PI_025</priceItemCode>
        <priceCriteria>NBRTRAN</priceCriteria>
        <priceCompId></priceCompId>
        <tieSeqNum>10</tieSeqNum>
        <version>0</version>
    </pricemcptier>
    <priceComponentDescription>Threshold price per transaction</
priceComponentDescription>
    <valueAmt>12.95000000000000000000</valueAmt>
    <priceComponentDisplay>>false</priceComponentDisplay>
    <rcMapId></rcMapId>
    <tieredFlag></tieredFlag>
    <priceCompSequenceNo2>0</priceCompSequenceNo2>
</priceComponent>
<priceComponent>
    <priceCompId>5417400011</priceCompId>
    <pricemcptier>
        <priceCompSequenceNo>0</priceCompSequenceNo>
        <businessObjectDataArea></businessObjectDataArea>
        <priceItemParmGroupId>1</priceItemParmGroupId>
        <toVal>1000.00000000000000000000</toVal>
        <fromVal>0.00000000000000000000</fromVal>
        <timeOfUse></timeOfUse>
        <priceItemCode>PI_025</priceItemCode>
        <priceCriteria>NBRTRAN</priceCriteria>
        <priceCompId></priceCompId>
        <tieSeqNum>10</tieSeqNum>
        <version>0</version>
    </pricemcptier>
    <pricemcptier>
        <priceCompSequenceNo>0</priceCompSequenceNo>
        <businessObjectDataArea></businessObjectDataArea>
        <priceItemParmGroupId>1</priceItemParmGroupId>
        <toVal>5000.00000000000000000000</toVal>
        <fromVal>1000.00000000000000000000</fromVal>
        <timeOfUse></timeOfUse>
        <priceItemCode>PI_025</priceItemCode>
        <priceCriteria>NBRTRAN</priceCriteria>
        <priceCompId></priceCompId>
        <tieSeqNum>10</tieSeqNum>
        <version>0</version>
    </pricemcptier>
    <pricemcptier>
        <priceCompSequenceNo>0</priceCompSequenceNo>
        <businessObjectDataArea></businessObjectDataArea>

```

```

        <priceItemParmGroupId>1</priceItemParmGroupId>
        <toVal>99999999999.99000000000000000000</toVal>
        <fromVal>5000.00000000000000000000</fromVal>
        <timeOfUse></timeOfUse>
        <priceItemCode>PI_025</priceItemCode>
        <priceCriteria>NBRTRAN</priceCriteria>
        <priceCompId></priceCompId>
        <tieSeqNum>10</tieSeqNum>
        <version>0</version>
    </pricecomptier>
    <priceComponentDescription>Threshold price per transaction</
priceComponentDescription>
    <valueAmt>12.15000000000000000000</valueAmt>
    <priceComponentDisplay>>false</priceComponentDisplay>
    <rcMapId></rcMapId>
    <tieredFlag></tieredFlag>
    <priceCompSequenceNo2>0</priceCompSequenceNo2>
</priceComponent>
<priceComponent>
    <priceCompId>5417400012</priceCompId>
    <pricecomptier>
        <priceCompSequenceNo>0</priceCompSequenceNo>
        <businessObjectDataArea></businessObjectDataArea>
        <priceItemParmGroupId>1</priceItemParmGroupId>
        <toVal>1000.00000000000000000000</toVal>
        <fromVal>0.00000000000000000000</fromVal>
        <timeOfUse></timeOfUse>
        <priceItemCode>PI_025</priceItemCode>
        <priceCriteria>NBRTRAN</priceCriteria>
        <priceCompId></priceCompId>
        <tieSeqNum>10</tieSeqNum>
        <version>0</version>
    </pricecomptier>
    <pricecomptier>
        <priceCompSequenceNo>0</priceCompSequenceNo>
        <businessObjectDataArea></businessObjectDataArea>
        <priceItemParmGroupId>1</priceItemParmGroupId>
        <toVal>5000.00000000000000000000</toVal>
        <fromVal>1000.00000000000000000000</fromVal>
        <timeOfUse></timeOfUse>
        <priceItemCode>PI_025</priceItemCode>
        <priceCriteria>NBRTRAN</priceCriteria>
        <priceCompId></priceCompId>
        <tieSeqNum>10</tieSeqNum>
        <version>0</version>
    </pricecomptier>
    <pricecomptier>
        <priceCompSequenceNo>0</priceCompSequenceNo>
        <businessObjectDataArea></businessObjectDataArea>
        <priceItemParmGroupId>1</priceItemParmGroupId>
        <toVal>99999999999.99000000000000000000</toVal>
        <fromVal>5000.00000000000000000000</fromVal>
        <timeOfUse></timeOfUse>
        <priceItemCode>PI_025</priceItemCode>
        <priceCriteria>NBRTRAN</priceCriteria>
        <priceCompId></priceCompId>
        <tieSeqNum>10</tieSeqNum>
        <version>0</version>
    </pricecomptier>
    <priceComponentDescription>Threshold price per transaction</
priceComponentDescription>
    <valueAmt>11.95000000000000000000</valueAmt>
    <priceComponentDisplay>>false</priceComponentDisplay>
    <rcMapId></rcMapId>

```

```

        <tieredFlag></tieredFlag>
        <priceCompSequenceNo2>0</priceCompSequenceNo2>
    </priceComponent>
</pricing>
<pricing>
    <priority>1</priority>
    <priceListId>5417730766</priceListId>
    <priceListDescription>PriceList -1</priceListDescription>
    <priceListStartDate>2022-01-11</priceListStartDate>
    <priceListEndDate>2022-02-28</priceListEndDate>
    <noOfDays></noOfDays>
    <priceItemCode>PI_026</priceItemCode>
    <priceitemDescr>V6-Electronic Credits</priceitemDescr>
    <priceAsgnId>5410009243</priceAsgnId>
    <validityFlag></validityFlag>
    <sourceEntityType></sourceEntityType>
    <sourceEntityCode></sourceEntityCode>
    <priceListInfo></priceListInfo>
    <priceComponent>
        <priceCompId>5417400020</priceCompId>
        <pricecomptier>
            <priceCompSequenceNo>0</priceCompSequenceNo>
            <businessObjectDataArea></businessObjectDataArea>
            <priceItemParmGroupId>1</priceItemParmGroupId>
            <toVal>1000.00000000000000000000</toVal>
            <fromVal>0.00000000000000000000</fromVal>
            <timeOfUse></timeOfUse>
            <priceItemCode>PI_026</priceItemCode>
            <priceCriteria>NBRTRAN</priceCriteria>
            <priceCompId></priceCompId>
            <tieSeqNum>10</tieSeqNum>
            <version>0</version>
        </pricecomptier>
        <pricecomptier>
            <priceCompSequenceNo>0</priceCompSequenceNo>
            <businessObjectDataArea></businessObjectDataArea>
            <priceItemParmGroupId>1</priceItemParmGroupId>
            <toVal>5000.00000000000000000000</toVal>
            <fromVal>1000.00000000000000000000</fromVal>
            <timeOfUse></timeOfUse>
            <priceItemCode>PI_026</priceItemCode>
            <priceCriteria>NBRTRAN</priceCriteria>
            <priceCompId></priceCompId>
            <tieSeqNum>10</tieSeqNum>
            <version>0</version>
        </pricecomptier>
        <pricecomptier>
            <priceCompSequenceNo>0</priceCompSequenceNo>
            <businessObjectDataArea></businessObjectDataArea>
            <priceItemParmGroupId>1</priceItemParmGroupId>
            <toVal>999999999999.99000000000000000000</toVal>
            <fromVal>5000.00000000000000000000</fromVal>
            <timeOfUse></timeOfUse>
            <priceItemCode>PI_026</priceItemCode>
            <priceCriteria>NBRTRAN</priceCriteria>
            <priceCompId></priceCompId>
            <tieSeqNum>10</tieSeqNum>
            <version>0</version>
        </pricecomptier>
        <pricecomptier>
            <priceCompSequenceNo>0</priceCompSequenceNo>
            <businessObjectDataArea></businessObjectDataArea>
            <priceItemParmGroupId>1</priceItemParmGroupId>
            <toVal>1000.00000000000000000000</toVal>

```

```

        <fromVal>0.000000000000000000</fromVal>
        <timeOfUse></timeOfUse>
        <priceItemCode>PI_026</priceItemCode>
        <priceCriteria>NBRTRAN</priceCriteria>
        <priceCompId></priceCompId>
        <tieSeqNum>10</tieSeqNum>
        <version>0</version>
    </pricecomptier>
    <pricecomptier>
        <priceCompSequenceNo>0</priceCompSequenceNo>
        <businessObjectDataArea></businessObjectDataArea>
        <priceItemParmGroupId>1</priceItemParmGroupId>
        <toVal>5000.000000000000000000</toVal>
        <fromVal>1000.000000000000000000</fromVal>
        <timeOfUse></timeOfUse>
        <priceItemCode>PI_026</priceItemCode>
        <priceCriteria>NBRTRAN</priceCriteria>
        <priceCompId></priceCompId>
        <tieSeqNum>10</tieSeqNum>
        <version>0</version>
    </pricecomptier>
    <pricecomptier>
        <priceCompSequenceNo>0</priceCompSequenceNo>
        <businessObjectDataArea></businessObjectDataArea>
        <priceItemParmGroupId>1</priceItemParmGroupId>
        <toVal>999999999999.990000000000000000</toVal>
        <fromVal>5000.000000000000000000</fromVal>
        <timeOfUse></timeOfUse>
        <priceItemCode>PI_026</priceItemCode>
        <priceCriteria>NBRTRAN</priceCriteria>
        <priceCompId></priceCompId>
        <tieSeqNum>10</tieSeqNum>
        <version>0</version>
    </pricecomptier>
    <priceComponentDescription>Basic charges</priceComponentDescription>
    <valueAmt>20.000000000000000000</valueAmt>
    <priceComponentDisplay>false</priceComponentDisplay>
    <rcMapId></rcMapId>
    <tieredFlag></tieredFlag>
    <priceCompSequenceNo2>0</priceCompSequenceNo2>
</priceComponent>
<priceComponent>
    <priceCompId>5417400021</priceCompId>
    <pricecomptier>
        <priceCompSequenceNo>0</priceCompSequenceNo>
        <businessObjectDataArea></businessObjectDataArea>
        <priceItemParmGroupId>1</priceItemParmGroupId>
        <toVal>1000.000000000000000000</toVal>
        <fromVal>0.000000000000000000</fromVal>
        <timeOfUse></timeOfUse>
        <priceItemCode>PI_026</priceItemCode>
        <priceCriteria>NBRTRAN</priceCriteria>
        <priceCompId></priceCompId>
        <tieSeqNum>10</tieSeqNum>
        <version>0</version>
    </pricecomptier>
    <pricecomptier>
        <priceCompSequenceNo>0</priceCompSequenceNo>
        <businessObjectDataArea></businessObjectDataArea>
        <priceItemParmGroupId>1</priceItemParmGroupId>
        <toVal>5000.000000000000000000</toVal>
        <fromVal>1000.000000000000000000</fromVal>
        <timeOfUse></timeOfUse>
        <priceItemCode>PI_026</priceItemCode>

```

```

        <priceCriteria>NBRTRAN</priceCriteria>
        <priceCompId></priceCompId>
        <tieSeqNum>10</tieSeqNum>
        <version>0</version>
    </pricemcptier>
    <pricemcptier>
        <priceCompSequenceNo>0</priceCompSequenceNo>
        <businessObjectDataArea></businessObjectDataArea>
        <priceItemParmGroupId>1</priceItemParmGroupId>
        <toVal>99999999999.9900000000000000000</toVal>
        <fromVal>5000.0000000000000000000</fromVal>
        <timeOfUse></timeOfUse>
        <priceItemCode>PI_026</priceItemCode>
        <priceCriteria>NBRTRAN</priceCriteria>
        <priceCompId></priceCompId>
        <tieSeqNum>10</tieSeqNum>
        <version>0</version>
    </pricemcptier>
    <pricemcptier>
        <priceCompSequenceNo>0</priceCompSequenceNo>
        <businessObjectDataArea></businessObjectDataArea>
        <priceItemParmGroupId>1</priceItemParmGroupId>
        <toVal>1000.0000000000000000000</toVal>
        <fromVal>0.0000000000000000000</fromVal>
        <timeOfUse></timeOfUse>
        <priceItemCode>PI_026</priceItemCode>
        <priceCriteria>NBRTRAN</priceCriteria>
        <priceCompId></priceCompId>
        <tieSeqNum>10</tieSeqNum>
        <version>0</version>
    </pricemcptier>
    <pricemcptier>
        <priceCompSequenceNo>0</priceCompSequenceNo>
        <businessObjectDataArea></businessObjectDataArea>
        <priceItemParmGroupId>1</priceItemParmGroupId>
        <toVal>5000.0000000000000000000</toVal>
        <fromVal>1000.0000000000000000000</fromVal>
        <timeOfUse></timeOfUse>
        <priceItemCode>PI_026</priceItemCode>
        <priceCriteria>NBRTRAN</priceCriteria>
        <priceCompId></priceCompId>
        <tieSeqNum>10</tieSeqNum>
        <version>0</version>
    </pricemcptier>
    <pricemcptier>
        <priceCompSequenceNo>0</priceCompSequenceNo>
        <businessObjectDataArea></businessObjectDataArea>
        <priceItemParmGroupId>1</priceItemParmGroupId>
        <toVal>99999999999.9900000000000000000</toVal>
        <fromVal>5000.0000000000000000000</fromVal>
        <timeOfUse></timeOfUse>
        <priceItemCode>PI_026</priceItemCode>
        <priceCriteria>NBRTRAN</priceCriteria>
        <priceCompId></priceCompId>
        <tieSeqNum>10</tieSeqNum>
        <version>0</version>
    </pricemcptier>
        <priceComponentDescription>Threshold price</
priceComponentDescription>
        <valueAmt>10.0000000000000000000</valueAmt>
        <priceComponentDisplay>false</priceComponentDisplay>
        <rcMapId></rcMapId>
        <tieredFlag></tieredFlag>
        <priceCompSequenceNo2>0</priceCompSequenceNo2>

```

```

</priceComponent>
<priceComponent>
  <priceCompId>5417400022</priceCompId>
  <pricecomptier>
    <priceCompSequenceNo>0</priceCompSequenceNo>
    <businessObjectDataArea></businessObjectDataArea>
    <priceItemParmGroupId>1</priceItemParmGroupId>
    <toVal>1000.00000000000000000000</toVal>
    <fromVal>0.00000000000000000000</fromVal>
    <timeOfUse></timeOfUse>
    <priceItemCode>PI_026</priceItemCode>
    <priceCriteria>NBRTRAN</priceCriteria>
    <priceCompId></priceCompId>
    <tieSeqNum>10</tieSeqNum>
    <version>0</version>
  </pricecomptier>
  <pricecomptier>
    <priceCompSequenceNo>0</priceCompSequenceNo>
    <businessObjectDataArea></businessObjectDataArea>
    <priceItemParmGroupId>1</priceItemParmGroupId>
    <toVal>5000.00000000000000000000</toVal>
    <fromVal>1000.00000000000000000000</fromVal>
    <timeOfUse></timeOfUse>
    <priceItemCode>PI_026</priceItemCode>
    <priceCriteria>NBRTRAN</priceCriteria>
    <priceCompId></priceCompId>
    <tieSeqNum>10</tieSeqNum>
    <version>0</version>
  </pricecomptier>
  <pricecomptier>
    <priceCompSequenceNo>0</priceCompSequenceNo>
    <businessObjectDataArea></businessObjectDataArea>
    <priceItemParmGroupId>1</priceItemParmGroupId>
    <toVal>999999999999.99000000000000000000</toVal>
    <fromVal>5000.00000000000000000000</fromVal>
    <timeOfUse></timeOfUse>
    <priceItemCode>PI_026</priceItemCode>
    <priceCriteria>NBRTRAN</priceCriteria>
    <priceCompId></priceCompId>
    <tieSeqNum>10</tieSeqNum>
    <version>0</version>
  </pricecomptier>
  <pricecomptier>
    <priceCompSequenceNo>0</priceCompSequenceNo>
    <businessObjectDataArea></businessObjectDataArea>
    <priceItemParmGroupId>1</priceItemParmGroupId>
    <toVal>1000.00000000000000000000</toVal>
    <fromVal>0.00000000000000000000</fromVal>
    <timeOfUse></timeOfUse>
    <priceItemCode>PI_026</priceItemCode>
    <priceCriteria>NBRTRAN</priceCriteria>
    <priceCompId></priceCompId>
    <tieSeqNum>10</tieSeqNum>
    <version>0</version>
  </pricecomptier>
  <pricecomptier>
    <priceCompSequenceNo>0</priceCompSequenceNo>
    <businessObjectDataArea></businessObjectDataArea>
    <priceItemParmGroupId>1</priceItemParmGroupId>
    <toVal>5000.00000000000000000000</toVal>
    <fromVal>1000.00000000000000000000</fromVal>
    <timeOfUse></timeOfUse>
    <priceItemCode>PI_026</priceItemCode>
    <priceCriteria>NBRTRAN</priceCriteria>

```

```

        <priceCompId></priceCompId>
        <tieSeqNum>10</tieSeqNum>
        <version>0</version>
    </pricecomptier>
</pricecomptier>
<pricecomptier>
    <priceCompSequenceNo>0</priceCompSequenceNo>
    <businessObjectDataArea></businessObjectDataArea>
    <priceItemParmGroupId>1</priceItemParmGroupId>
    <toVal>999999999999.9900000000000000000</toVal>
    <fromVal>5000.0000000000000000000</fromVal>
    <timeOfUse></timeOfUse>
    <priceItemCode>PI_026</priceItemCode>
    <priceCriteria>NBRTRAN</priceCriteria>
    <priceCompId></priceCompId>
    <tieSeqNum>10</tieSeqNum>
    <version>0</version>
</pricecomptier>
        <priceComponentDescription>Threshold price</
priceComponentDescription>
    <valueAmt>8.0000000000000000000</valueAmt>
    <priceComponentDisplay>false</priceComponentDisplay>
    <rcMapId></rcMapId>
    <tieredFlag></tieredFlag>
    <priceCompSequenceNo2>0</priceCompSequenceNo2>
</priceComponent>
<priceComponent>
    <priceCompId>5417400023</priceCompId>
    <pricecomptier>
        <priceCompSequenceNo>0</priceCompSequenceNo>
        <businessObjectDataArea></businessObjectDataArea>
        <priceItemParmGroupId>1</priceItemParmGroupId>
        <toVal>1000.0000000000000000000</toVal>
        <fromVal>0.0000000000000000000</fromVal>
        <timeOfUse></timeOfUse>
        <priceItemCode>PI_026</priceItemCode>
        <priceCriteria>NBRTRAN</priceCriteria>
        <priceCompId></priceCompId>
        <tieSeqNum>10</tieSeqNum>
        <version>0</version>
    </pricecomptier>
    <pricecomptier>
        <priceCompSequenceNo>0</priceCompSequenceNo>
        <businessObjectDataArea></businessObjectDataArea>
        <priceItemParmGroupId>1</priceItemParmGroupId>
        <toVal>5000.0000000000000000000</toVal>
        <fromVal>1000.0000000000000000000</fromVal>
        <timeOfUse></timeOfUse>
        <priceItemCode>PI_026</priceItemCode>
        <priceCriteria>NBRTRAN</priceCriteria>
        <priceCompId></priceCompId>
        <tieSeqNum>10</tieSeqNum>
        <version>0</version>
    </pricecomptier>
    <pricecomptier>
        <priceCompSequenceNo>0</priceCompSequenceNo>
        <businessObjectDataArea></businessObjectDataArea>
        <priceItemParmGroupId>1</priceItemParmGroupId>
        <toVal>999999999999.9900000000000000000</toVal>
        <fromVal>5000.0000000000000000000</fromVal>
        <timeOfUse></timeOfUse>
        <priceItemCode>PI_026</priceItemCode>
        <priceCriteria>NBRTRAN</priceCriteria>
        <priceCompId></priceCompId>
        <tieSeqNum>10</tieSeqNum>
    </pricecomptier>

```

```

        <version>0</version>
    </pricecomptier>
    <pricecomptier>
        <priceCompSequenceNo>0</priceCompSequenceNo>
        <businessObjectDataArea></businessObjectDataArea>
        <priceItemParmGroupId>1</priceItemParmGroupId>
        <toVal>1000.000000000000000000</toVal>
        <fromVal>0.000000000000000000</fromVal>
        <timeOfUse></timeOfUse>
        <priceItemCode>PI_026</priceItemCode>
        <priceCriteria>NBRTRAN</priceCriteria>
        <priceCompId></priceCompId>
        <tieSeqNum>10</tieSeqNum>
        <version>0</version>
    </pricecomptier>
    <pricecomptier>
        <priceCompSequenceNo>0</priceCompSequenceNo>
        <businessObjectDataArea></businessObjectDataArea>
        <priceItemParmGroupId>1</priceItemParmGroupId>
        <toVal>5000.000000000000000000</toVal>
        <fromVal>1000.000000000000000000</fromVal>
        <timeOfUse></timeOfUse>
        <priceItemCode>PI_026</priceItemCode>
        <priceCriteria>NBRTRAN</priceCriteria>
        <priceCompId></priceCompId>
        <tieSeqNum>10</tieSeqNum>
        <version>0</version>
    </pricecomptier>
    <pricecomptier>
        <priceCompSequenceNo>0</priceCompSequenceNo>
        <businessObjectDataArea></businessObjectDataArea>
        <priceItemParmGroupId>1</priceItemParmGroupId>
        <toVal>99999999999.990000000000000000</toVal>
        <fromVal>5000.000000000000000000</fromVal>
        <timeOfUse></timeOfUse>
        <priceItemCode>PI_026</priceItemCode>
        <priceCriteria>NBRTRAN</priceCriteria>
        <priceCompId></priceCompId>
        <tieSeqNum>10</tieSeqNum>
        <version>0</version>
    </pricecomptier>
        <priceComponentDescription>Threshold price</
priceComponentDescription>
        <valueAmt>6.000000000000000000</valueAmt>
        <priceComponentDisplay>false</priceComponentDisplay>
        <rcMapId></rcMapId>
        <tieredFlag></tieredFlag>
        <priceCompSequenceNo2>0</priceCompSequenceNo2>
    </priceComponent>
    <priceComponent>
        <priceCompId>5417400024</priceCompId>
        <pricecomptier>
            <priceCompSequenceNo>0</priceCompSequenceNo>
            <businessObjectDataArea></businessObjectDataArea>
            <priceItemParmGroupId>1</priceItemParmGroupId>
            <toVal>1000.000000000000000000</toVal>
            <fromVal>0.000000000000000000</fromVal>
            <timeOfUse></timeOfUse>
            <priceItemCode>PI_026</priceItemCode>
            <priceCriteria>NBRTRAN</priceCriteria>
            <priceCompId></priceCompId>
            <tieSeqNum>10</tieSeqNum>
            <version>0</version>
        </pricecomptier>
    </priceComponent>

```



```

<pricecomptier>
  <priceCompSequenceNo>0</priceCompSequenceNo>
  <businessObjectDataArea></businessObjectDataArea>
  <priceItemParmGroupId>1</priceItemParmGroupId>
  <toVal>5000.00000000000000000000</toVal>
  <fromVal>1000.00000000000000000000</fromVal>
  <timeOfUse></timeOfUse>
  <priceItemCode>PI_026</priceItemCode>
  <priceCriteria>NBRTRAN</priceCriteria>
  <priceCompId></priceCompId>
  <tieSeqNum>10</tieSeqNum>
  <version>0</version>
</pricecomptier>
<pricecomptier>
  <priceCompSequenceNo>0</priceCompSequenceNo>
  <businessObjectDataArea></businessObjectDataArea>
  <priceItemParmGroupId>1</priceItemParmGroupId>
  <toVal>999999999999.99000000000000000000</toVal>
  <fromVal>5000.00000000000000000000</fromVal>
  <timeOfUse></timeOfUse>
  <priceItemCode>PI_026</priceItemCode>
  <priceCriteria>NBRTRAN</priceCriteria>
  <priceCompId></priceCompId>
  <tieSeqNum>10</tieSeqNum>
  <version>0</version>
</pricecomptier>
<pricecomptier>
  <priceCompSequenceNo>0</priceCompSequenceNo>
  <businessObjectDataArea></businessObjectDataArea>
  <priceItemParmGroupId>1</priceItemParmGroupId>
  <toVal>1000.00000000000000000000</toVal>
  <fromVal>0.00000000000000000000</fromVal>
  <timeOfUse></timeOfUse>
  <priceItemCode>PI_026</priceItemCode>
  <priceCriteria>NBRTRAN</priceCriteria>
  <priceCompId></priceCompId>
  <tieSeqNum>10</tieSeqNum>
  <version>0</version>
</pricecomptier>
<pricecomptier>
  <priceCompSequenceNo>0</priceCompSequenceNo>
  <businessObjectDataArea></businessObjectDataArea>
  <priceItemParmGroupId>1</priceItemParmGroupId>
  <toVal>5000.00000000000000000000</toVal>
  <fromVal>1000.00000000000000000000</fromVal>
  <timeOfUse></timeOfUse>
  <priceItemCode>PI_026</priceItemCode>
  <priceCriteria>NBRTRAN</priceCriteria>
  <priceCompId></priceCompId>
  <tieSeqNum>10</tieSeqNum>
  <version>0</version>
</pricecomptier>
<pricecomptier>
  <priceCompSequenceNo>0</priceCompSequenceNo>
  <businessObjectDataArea></businessObjectDataArea>
  <priceItemParmGroupId>1</priceItemParmGroupId>
  <toVal>999999999999.99000000000000000000</toVal>
  <fromVal>5000.00000000000000000000</fromVal>
  <timeOfUse></timeOfUse>
  <priceItemCode>PI_026</priceItemCode>
  <priceCriteria>NBRTRAN</priceCriteria>
  <priceCompId></priceCompId>
  <tieSeqNum>10</tieSeqNum>
  <version>0</version>

```

```

</pricecomptier>
<priceComponentDescription>Step 1</priceComponentDescription>
<valueAmt>5.0000000000000000</valueAmt>
<priceComponentDisplay>false</priceComponentDisplay>
<rcMapId></rcMapId>
<tieredFlag></tieredFlag>
<priceCompSequenceNo2>0</priceCompSequenceNo2>
</priceComponent>
<priceComponent>
<priceCompId>5417400025</priceCompId>
<pricecomptier>
  <priceCompSequenceNo>0</priceCompSequenceNo>
  <businessObjectDataArea></businessObjectDataArea>
  <priceItemParmGroupId>1</priceItemParmGroupId>
  <toVal>1000.0000000000000000</toVal>
  <fromVal>0.0000000000000000</fromVal>
  <timeOfUse></timeOfUse>
  <priceItemCode>PI_026</priceItemCode>
  <priceCriteria>NBRTRAN</priceCriteria>
  <priceCompId></priceCompId>
  <tieSeqNum>10</tieSeqNum>
  <version>0</version>
</pricecomptier>
<pricecomptier>
  <priceCompSequenceNo>0</priceCompSequenceNo>
  <businessObjectDataArea></businessObjectDataArea>
  <priceItemParmGroupId>1</priceItemParmGroupId>
  <toVal>5000.0000000000000000</toVal>
  <fromVal>1000.0000000000000000</fromVal>
  <timeOfUse></timeOfUse>
  <priceItemCode>PI_026</priceItemCode>
  <priceCriteria>NBRTRAN</priceCriteria>
  <priceCompId></priceCompId>
  <tieSeqNum>10</tieSeqNum>
  <version>0</version>
</pricecomptier>
<pricecomptier>
  <priceCompSequenceNo>0</priceCompSequenceNo>
  <businessObjectDataArea></businessObjectDataArea>
  <priceItemParmGroupId>1</priceItemParmGroupId>
  <toVal>9999999999.9900000000000000</toVal>
  <fromVal>5000.0000000000000000</fromVal>
  <timeOfUse></timeOfUse>
  <priceItemCode>PI_026</priceItemCode>
  <priceCriteria>NBRTRAN</priceCriteria>
  <priceCompId></priceCompId>
  <tieSeqNum>10</tieSeqNum>
  <version>0</version>
</pricecomptier>
<pricecomptier>
  <priceCompSequenceNo>0</priceCompSequenceNo>
  <businessObjectDataArea></businessObjectDataArea>
  <priceItemParmGroupId>1</priceItemParmGroupId>
  <toVal>1000.0000000000000000</toVal>
  <fromVal>0.0000000000000000</fromVal>
  <timeOfUse></timeOfUse>
  <priceItemCode>PI_026</priceItemCode>
  <priceCriteria>NBRTRAN</priceCriteria>
  <priceCompId></priceCompId>
  <tieSeqNum>10</tieSeqNum>
  <version>0</version>
</pricecomptier>
<pricecomptier>
  <priceCompSequenceNo>0</priceCompSequenceNo>

```

```

    <businessObjectDataArea></businessObjectDataArea>
    <priceItemParmGroupId>1</priceItemParmGroupId>
    <toVal>5000.00000000000000000000</toVal>
    <fromVal>1000.00000000000000000000</fromVal>
    <timeOfUse></timeOfUse>
    <priceItemCode>PI_026</priceItemCode>
    <priceCriteria>NBRTRAN</priceCriteria>
    <priceCompId></priceCompId>
    <tieSeqNum>10</tieSeqNum>
    <version>0</version>
  </pricecomptier>
  <pricecomptier>
    <priceCompSequenceNo>0</priceCompSequenceNo>
    <businessObjectDataArea></businessObjectDataArea>
    <priceItemParmGroupId>1</priceItemParmGroupId>
    <toVal>999999999999.99000000000000000000</toVal>
    <fromVal>5000.00000000000000000000</fromVal>
    <timeOfUse></timeOfUse>
    <priceItemCode>PI_026</priceItemCode>
    <priceCriteria>NBRTRAN</priceCriteria>
    <priceCompId></priceCompId>
    <tieSeqNum>10</tieSeqNum>
    <version>0</version>
  </pricecomptier>
  <priceComponentDescription>Step 2</priceComponentDescription>
  <valueAmt>4.00000000000000000000</valueAmt>
  <priceComponentDisplay>false</priceComponentDisplay>
  <rcMapId></rcMapId>
  <tieredFlag></tieredFlag>
  <priceCompSequenceNo2>0</priceCompSequenceNo2>
</priceComponent>
<priceComponent>
  <priceCompId>5417400026</priceCompId>
  <pricecomptier>
    <priceCompSequenceNo>0</priceCompSequenceNo>
    <businessObjectDataArea></businessObjectDataArea>
    <priceItemParmGroupId>1</priceItemParmGroupId>
    <toVal>1000.00000000000000000000</toVal>
    <fromVal>0.00000000000000000000</fromVal>
    <timeOfUse></timeOfUse>
    <priceItemCode>PI_026</priceItemCode>
    <priceCriteria>NBRTRAN</priceCriteria>
    <priceCompId></priceCompId>
    <tieSeqNum>10</tieSeqNum>
    <version>0</version>
  </pricecomptier>
  <pricecomptier>
    <priceCompSequenceNo>0</priceCompSequenceNo>
    <businessObjectDataArea></businessObjectDataArea>
    <priceItemParmGroupId>1</priceItemParmGroupId>
    <toVal>5000.00000000000000000000</toVal>
    <fromVal>1000.00000000000000000000</fromVal>
    <timeOfUse></timeOfUse>
    <priceItemCode>PI_026</priceItemCode>
    <priceCriteria>NBRTRAN</priceCriteria>
    <priceCompId></priceCompId>
    <tieSeqNum>10</tieSeqNum>
    <version>0</version>
  </pricecomptier>
  <pricecomptier>
    <priceCompSequenceNo>0</priceCompSequenceNo>
    <businessObjectDataArea></businessObjectDataArea>
    <priceItemParmGroupId>1</priceItemParmGroupId>
    <toVal>999999999999.99000000000000000000</toVal>

```

```

        <fromVal>5000.00000000000000000000</fromVal>
        <timeOfUse></timeOfUse>
        <priceItemCode>PI_026</priceItemCode>
        <priceCriteria>NBRTRAN</priceCriteria>
        <priceCompId></priceCompId>
        <tieSeqNum>10</tieSeqNum>
        <version>0</version>
    </pricecomptier>
    <pricecomptier>
        <priceCompSequenceNo>0</priceCompSequenceNo>
        <businessObjectDataArea></businessObjectDataArea>
        <priceItemParmGroupId>1</priceItemParmGroupId>
        <toVal>1000.00000000000000000000</toVal>
        <fromVal>0.00000000000000000000</fromVal>
        <timeOfUse></timeOfUse>
        <priceItemCode>PI_026</priceItemCode>
        <priceCriteria>NBRTRAN</priceCriteria>
        <priceCompId></priceCompId>
        <tieSeqNum>10</tieSeqNum>
        <version>0</version>
    </pricecomptier>
    <pricecomptier>
        <priceCompSequenceNo>0</priceCompSequenceNo>
        <businessObjectDataArea></businessObjectDataArea>
        <priceItemParmGroupId>1</priceItemParmGroupId>
        <toVal>5000.00000000000000000000</toVal>
        <fromVal>1000.00000000000000000000</fromVal>
        <timeOfUse></timeOfUse>
        <priceItemCode>PI_026</priceItemCode>
        <priceCriteria>NBRTRAN</priceCriteria>
        <priceCompId></priceCompId>
        <tieSeqNum>10</tieSeqNum>
        <version>0</version>
    </pricecomptier>
    <pricecomptier>
        <priceCompSequenceNo>0</priceCompSequenceNo>
        <businessObjectDataArea></businessObjectDataArea>
        <priceItemParmGroupId>1</priceItemParmGroupId>
        <toVal>999999999999.99000000000000000000</toVal>
        <fromVal>5000.00000000000000000000</fromVal>
        <timeOfUse></timeOfUse>
        <priceItemCode>PI_026</priceItemCode>
        <priceCriteria>NBRTRAN</priceCriteria>
        <priceCompId></priceCompId>
        <tieSeqNum>10</tieSeqNum>
        <version>0</version>
    </pricecomptier>
    <priceComponentDescription>Step 3</priceComponentDescription>
    <valueAmt>3.00000000000000000000</valueAmt>
    <priceComponentDisplay>false</priceComponentDisplay>
    <rcMapId></rcMapId>
    <tieredFlag></tieredFlag>
    <priceCompSequenceNo2>0</priceCompSequenceNo2>
</priceComponent>
</pricing>
<pricing>
    <priority>1</priority>
    <priceListId>5417730766</priceListId>
    <priceListDescription>PriceList -1</priceListDescription>
    <priceListStartDate>2022-01-11</priceListStartDate>
    <priceListEndDate>2022-02-28</priceListEndDate>
    <noOfDays></noOfDays>
    <priceItemCode>PI_027</priceItemCode>
    <priceitemDescr>V7-Direct Debit</priceitemDescr>

```

```

<priceAsgnId>5410009209</priceAsgnId>
<validityFlag></validityFlag>
<sourceEntityType></sourceEntityType>
<sourceEntityCode></sourceEntityCode>
<priceListInfo></priceListInfo>
<priceComponent>
  <priceCompId>5417300038</priceCompId>
  <pricecomptier>
    <priceCompSequenceNo></priceCompSequenceNo>
    <businessObjectDataArea></businessObjectDataArea>
    <priceItemParmGroupId></priceItemParmGroupId>
    <toVal></toVal>
    <fromVal></fromVal>
    <timeOfUse></timeOfUse>
    <priceItemCode></priceItemCode>
    <priceCriteria></priceCriteria>
    <priceCompId></priceCompId>
    <tieSeqNum></tieSeqNum>
    <version>0</version>
  </pricecomptier>
  <priceComponentDescription>Basic BK-NBR</priceComponentDescription>
  <valueAmt>0.150000000000000000</valueAmt>
  <priceComponentDisplay>>false</priceComponentDisplay>
  <rcMapId></rcMapId>
  <tieredFlag></tieredFlag>
  <priceCompSequenceNo2>0</priceCompSequenceNo2>
</priceComponent>
</pricing>
<pricing>
  <priority>1</priority>
  <priceListId>5417730766</priceListId>
  <priceListDescription>PriceList -1</priceListDescription>
  <priceListStartDate>2022-01-11</priceListStartDate>
  <priceListEndDate>2022-02-28</priceListEndDate>
  <noOfDays></noOfDays>
  <priceItemCode>PI_028</priceItemCode>
  <priceitemDescr>V8-Cheque Collections</priceitemDescr>
  <priceAsgnId>5410009210</priceAsgnId>
  <validityFlag></validityFlag>
  <sourceEntityType></sourceEntityType>
  <sourceEntityCode></sourceEntityCode>
  <priceListInfo></priceListInfo>
  <priceComponent>
    <priceCompId>5417300040</priceCompId>
    <pricecomptier>
      <priceCompSequenceNo></priceCompSequenceNo>
      <businessObjectDataArea></businessObjectDataArea>
      <priceItemParmGroupId></priceItemParmGroupId>
      <toVal></toVal>
      <fromVal></fromVal>
      <timeOfUse></timeOfUse>
      <priceItemCode></priceItemCode>
      <priceCriteria></priceCriteria>
      <priceCompId></priceCompId>
      <tieSeqNum></tieSeqNum>
      <version>0</version>
    </pricecomptier>
    <priceComponentDescription>FLAT</priceComponentDescription>
    <valueAmt>0.750000000000000000</valueAmt>
    <priceComponentDisplay>>false</priceComponentDisplay>
    <rcMapId></rcMapId>
    <tieredFlag></tieredFlag>
    <priceCompSequenceNo2>0</priceCompSequenceNo2>
  </priceComponent>

```

```

</pricing>
<pricing>
  <priority>1</priority>
  <priceListId>5417730766</priceListId>
  <priceListDescription>PriceList -1</priceListDescription>
  <priceListStartDate>2022-01-11</priceListStartDate>
  <priceListEndDate>2022-02-28</priceListEndDate>
  <noOfDays></noOfDays>
  <priceItemCode>PI_028</priceItemCode>
  <priceitemDescr>V8-Cheque Collections</priceitemDescr>
  <priceAsgnId>5410009211</priceAsgnId>
  <validityFlag></validityFlag>
  <sourceEntityType></sourceEntityType>
  <sourceEntityCode></sourceEntityCode>
  <priceListInfo></priceListInfo>
  <priceComponent>
    <priceCompId>5417300042</priceCompId>
    <pricecomptier>
      <priceCompSequenceNo></priceCompSequenceNo>
      <businessObjectDataArea></businessObjectDataArea>
      <priceItemParmGroupId></priceItemParmGroupId>
      <toVal></toVal>
      <fromVal></fromVal>
      <timeOfUse></timeOfUse>
      <priceItemCode></priceItemCode>
      <priceCriteria></priceCriteria>
      <priceCompId></priceCompId>
      <tieSeqNum></tieSeqNum>
      <version>0</version>
    </pricecomptier>
    <priceComponentDescription>FLAT</priceComponentDescription>
    <valueAmt>6.670000000000000000</valueAmt>
    <priceComponentDisplay>false</priceComponentDisplay>
    <rcMapId></rcMapId>
    <tieredFlag></tieredFlag>
    <priceCompSequenceNo2>0</priceCompSequenceNo2>
  </priceComponent>
</pricing>
<pricing>
  <priority>1</priority>
  <priceListId>5417730766</priceListId>
  <priceListDescription>PriceList -1</priceListDescription>
  <priceListStartDate>2022-01-11</priceListStartDate>
  <priceListEndDate>2022-02-28</priceListEndDate>
  <noOfDays></noOfDays>
  <priceItemCode>PI_028</priceItemCode>
  <priceitemDescr>V8-Cheque Collections</priceitemDescr>
  <priceAsgnId>5410009212</priceAsgnId>
  <validityFlag></validityFlag>
  <sourceEntityType></sourceEntityType>
  <sourceEntityCode></sourceEntityCode>
  <priceListInfo></priceListInfo>
  <priceComponent>
    <priceCompId>5417300044</priceCompId>
    <pricecomptier>
      <priceCompSequenceNo></priceCompSequenceNo>
      <businessObjectDataArea></businessObjectDataArea>
      <priceItemParmGroupId></priceItemParmGroupId>
      <toVal></toVal>
      <fromVal></fromVal>
      <timeOfUse></timeOfUse>
      <priceItemCode></priceItemCode>
      <priceCriteria></priceCriteria>
      <priceCompId></priceCompId>
    </pricecomptier>
  </priceComponent>
</pricing>

```

```

        <tieSeqNum></tieSeqNum>
        <version>0</version>
    </pricecomptier>
    <priceComponentDescription>FLAT</priceComponentDescription>
    <valueAmt>0.300000000000000000</valueAmt>
    <priceComponentDisplay>>false</priceComponentDisplay>
    <rcMapId></rcMapId>
    <tieredFlag></tieredFlag>
    <priceCompSequenceNo2>0</priceCompSequenceNo2>
</priceComponent>
</pricing>
<pricing>
    <priority>1</priority>
    <priceListId>5417730766</priceListId>
    <priceListDescription>PriceList -1</priceListDescription>
    <priceListStartDate>2022-01-11</priceListStartDate>
    <priceListEndDate>2022-02-28</priceListEndDate>
    <noOfDays></noOfDays>
    <priceItemCode>PI_028</priceItemCode>
    <priceitemDescr>V8-Cheque Collections</priceitemDescr>
    <priceAsgnId>5410009213</priceAsgnId>
    <validityFlag></validityFlag>
    <sourceEntityType></sourceEntityType>
    <sourceEntityCode></sourceEntityCode>
    <priceListInfo></priceListInfo>
    <priceComponent>
        <priceCompId>5417300046</priceCompId>
        <pricecomptier>
            <priceCompSequenceNo></priceCompSequenceNo>
            <businessObjectDataArea></businessObjectDataArea>
            <priceItemParmGroupId></priceItemParmGroupId>
            <toVal></toVal>
            <fromVal></fromVal>
            <timeOfUse></timeOfUse>
            <priceItemCode></priceItemCode>
            <priceCriteria></priceCriteria>
            <priceCompId></priceCompId>
            <tieSeqNum></tieSeqNum>
            <version>0</version>
        </pricecomptier>
        <priceComponentDescription>FLAT</priceComponentDescription>
        <valueAmt>2.050000000000000000</valueAmt>
        <priceComponentDisplay>>false</priceComponentDisplay>
        <rcMapId></rcMapId>
        <tieredFlag></tieredFlag>
        <priceCompSequenceNo2>0</priceCompSequenceNo2>
    </priceComponent>
</pricing>
<pricing>
    <priority>1</priority>
    <priceListId>5417730766</priceListId>
    <priceListDescription>PriceList -1</priceListDescription>
    <priceListStartDate>2022-01-11</priceListStartDate>
    <priceListEndDate>2022-02-28</priceListEndDate>
    <noOfDays></noOfDays>
    <priceItemCode>PI_029</priceItemCode>
    <priceitemDescr>V9-Domestic Liquidity</priceitemDescr>
    <priceAsgnId>5410009214</priceAsgnId>
    <validityFlag></validityFlag>
    <sourceEntityType></sourceEntityType>
    <sourceEntityCode></sourceEntityCode>
    <priceListInfo></priceListInfo>
    <priceComponent>
        <priceCompId>5417300048</priceCompId>

```

```

    <pricecomptier>
      <priceCompSequenceNo></priceCompSequenceNo>
      <businessObjectDataArea></businessObjectDataArea>
      <priceItemParmGroupId></priceItemParmGroupId>
      <toVal></toVal>
      <fromVal></fromVal>
      <timeOfUse></timeOfUse>
      <priceItemCode></priceItemCode>
      <priceCriteria></priceCriteria>
      <priceCompId></priceCompId>
      <tieSeqNum></tieSeqNum>
      <version>0</version>
    </pricecomptier>
    <priceComponentDescription>FLAT</priceComponentDescription>
    <valueAmt>0.400000000000000000</valueAmt>
    <priceComponentDisplay>>false</priceComponentDisplay>
    <rcMapId></rcMapId>
    <tieredFlag></tieredFlag>
    <priceCompSequenceNo2>0</priceCompSequenceNo2>
  </priceComponent>
</pricing>
<pricing>
  <priority>1</priority>
  <priceListId>5417730766</priceListId>
  <priceListDescription>PriceList -1</priceListDescription>
  <priceListStartDate>2022-01-11</priceListStartDate>
  <priceListEndDate>2022-02-28</priceListEndDate>
  <noOfDays></noOfDays>
  <priceItemCode>PI_030</priceItemCode>
  <priceitemDescr>V10-Third Party Bank</priceitemDescr>
  <priceAsgnId>5410009215</priceAsgnId>
  <validityFlag></validityFlag>
  <sourceEntityType></sourceEntityType>
  <sourceEntityCode></sourceEntityCode>
  <priceListInfo></priceListInfo>
  <priceComponent>
    <priceCompId>5417300050</priceCompId>
    <pricecomptier>
      <priceCompSequenceNo></priceCompSequenceNo>
      <businessObjectDataArea></businessObjectDataArea>
      <priceItemParmGroupId></priceItemParmGroupId>
      <toVal></toVal>
      <fromVal></fromVal>
      <timeOfUse></timeOfUse>
      <priceItemCode></priceItemCode>
      <priceCriteria></priceCriteria>
      <priceCompId></priceCompId>
      <tieSeqNum></tieSeqNum>
      <version>0</version>
    </pricecomptier>
    <priceComponentDescription>FLAT</priceComponentDescription>
    <valueAmt>0.600000000000000000</valueAmt>
    <priceComponentDisplay>>false</priceComponentDisplay>
    <rcMapId></rcMapId>
    <tieredFlag></tieredFlag>
    <priceCompSequenceNo2>0</priceCompSequenceNo2>
  </priceComponent>
</pricing>
<pricing>
  <priority>1</priority>
  <priceListId>5417730766</priceListId>
  <priceListDescription>PriceList -1</priceListDescription>
  <priceListStartDate>2022-01-11</priceListStartDate>
  <priceListEndDate>2022-02-28</priceListEndDate>

```



```

<noOfDays></noOfDays>
<priceItemCode>PI_031</priceItemCode>
<priceitemDescr>MT943_SWIFT_01</priceitemDescr>
<priceAsgnId>5410009201</priceAsgnId>
<validityFlag></validityFlag>
<sourceEntityType></sourceEntityType>
<sourceEntityCode></sourceEntityCode>
<priceListInfo></priceListInfo>
<priceComponent>
  <priceCompId>5417300002</priceCompId>
  <pricecomptier>
    <priceCompSequenceNo></priceCompSequenceNo>
    <businessObjectDataArea></businessObjectDataArea>
    <priceItemParmGroupId></priceItemParmGroupId>
    <toVal></toVal>
    <fromVal></fromVal>
    <timeOfUse></timeOfUse>
    <priceItemCode></priceItemCode>
    <priceCriteria></priceCriteria>
    <priceCompId></priceCompId>
    <tieSeqNum></tieSeqNum>
    <version>0</version>
  </pricecomptier>
  <priceComponentDescription>FLAT</priceComponentDescription>
  <valueAmt>16.660000000000000000</valueAmt>
  <priceComponentDisplay>false</priceComponentDisplay>
  <rcMapId></rcMapId>
  <tieredFlag></tieredFlag>
  <priceCompSequenceNo2>0</priceCompSequenceNo2>
</priceComponent>
</pricing>
<pricing>
  <priority>1</priority>
  <priceListId>5417730766</priceListId>
  <priceListDescription>PriceList -1</priceListDescription>
  <priceListStartDate>2022-01-11</priceListStartDate>
  <priceListEndDate>2022-02-28</priceListEndDate>
  <noOfDays></noOfDays>
  <priceItemCode>PI_032</priceItemCode>
  <priceitemDescr>MT943_SWIFT_02</priceitemDescr>
  <priceAsgnId>5410009261</priceAsgnId>
  <validityFlag></validityFlag>
  <sourceEntityType></sourceEntityType>
  <sourceEntityCode></sourceEntityCode>
  <priceListInfo></priceListInfo>
  <priceComponent>
    <priceCompId>5417450002</priceCompId>
    <pricecomptier>
      <priceCompSequenceNo></priceCompSequenceNo>
      <businessObjectDataArea></businessObjectDataArea>
      <priceItemParmGroupId></priceItemParmGroupId>
      <toVal></toVal>
      <fromVal></fromVal>
      <timeOfUse></timeOfUse>
      <priceItemCode></priceItemCode>
      <priceCriteria></priceCriteria>
      <priceCompId></priceCompId>
      <tieSeqNum></tieSeqNum>
      <version>0</version>
    </pricecomptier>
    <priceComponentDescription>FLAT</priceComponentDescription>
    <valueAmt>15.000000000000000000</valueAmt>
    <priceComponentDisplay>false</priceComponentDisplay>
    <rcMapId></rcMapId>
  </priceComponent>
</pricing>

```

```

        <tieredFlag></tieredFlag>
        <priceCompSequenceNo2>0</priceCompSequenceNo2>
    </priceComponent>
</pricing>
</entityList>
<messageCategory>0</messageCategory>
<messageNumber>0</messageNumber>
<messageText></messageText>
<longDescription></longDescription>
<inquiryTypeFlag>DETL</inquiryTypeFlag>
</C1_GETELIGIBLEPROD>

```

Related Topics

For more information on...	See...
Eligible Market Products, Offers, or Bundles Derivation Request and Response - Tags in XML Format	Eligible Market Products, Offers, or Bundles Derivation Request and Response - Tags in XML Format on page 3294

Sample Eligible Offer Derivation Request and Response in the XML Format

Using the below example, you can derive eligible offers of the **2406432705** account which are processed on **2022-01-11**.

Sample Eligible Offer Request in the XML Format

```

<C1_GETELIGIBLEPROD>
  <productCode>LOAN_001</productCode>
  <productCategoryFlg></productCategoryFlg>
  <division>IND</division>
  <entityType>OFFR</entityType>
  <entityCode>CHECKOFF_01</entityCode>
  <processDate>2022-01-11</processDate>
  <accountId>2406432705</accountId>
  <acctIdtype></acctIdtype>
  <acctIdentifierValue></acctIdentifierValue>
  <personId></personId>
  <custIdTypeCd></custIdTypeCd>
  <perIdentifireVal></perIdentifireVal>
  <productLinkedEntity>
    <linkedEntityCode>CHECKMP_001</linkedEntityCode>
    <linkedEntityType>MP</linkedEntityType>
  </productLinkedEntity>
  <productLinkedEntity>
    <linkedEntityCode>CHECKMP_002</linkedEntityCode>
    <linkedEntityType>MP</linkedEntityType>
  </productLinkedEntity>
  <eligibleParameter>
    <priceParmCode>ACC_DIVISION</priceParmCode>
    <priceParmVal>IND</priceParmVal>
  </eligibleParameter>
  <eligibleParameter>
    <priceParmCode>PERSON_STATE</priceParmCode>
    <priceParmVal>MH</priceParmVal>
  </eligibleParameter>
</C1_GETELIGIBLEPROD>

```

Sample Eligible Offer Response in the XML Format

```

<C1_GETELIGIBLEPROD>
  <productCode>LOAN_001</productCode>
  <productCategoryFlg></productCategoryFlg>
  <division>IND</division>
  <entityType>OFFR</entityType>

```

```

<entityCode>CHECKOFF_01</entityCode>
<processDate>2022-01-11</processDate>
<accountId>2406432705</accountId>
<acctIdtype></acctIdtype>
<acctIdentifierValue></acctIdentifierValue>
<personId></personId>
<custIdTypeCd></custIdTypeCd>
<perIdentifireVal></perIdentifireVal>
<productLinkedEntity>
  <linkedEntityCode>CHECKMP_001</linkedEntityCode>
  <linkedEntityType>MP</linkedEntityType>
</productLinkedEntity>
<productLinkedEntity>
  <linkedEntityCode>CHECKMP_002</linkedEntityCode>
  <linkedEntityType>MP</linkedEntityType>
</productLinkedEntity>
<eligibleParameter>
  <priceParmCode>ACC_DIVISION</priceParmCode>
  <priceParmVal>IND</priceParmVal>
</eligibleParameter>
<eligibleParameter>
  <priceParmCode>PERSON_STATE</priceParmCode>
  <priceParmVal>MH</priceParmVal>
</eligibleParameter>
<entityList>
  <entityCode>CHECKOFF_01</entityCode>
  <entityType>OFFR</entityType>
  <entityName>CHECKOFF_01</entityName>
  <entityStartDate>2022-01-11</entityStartDate>
  <entityEndDate>2022-03-31</entityEndDate>
  <entityCodeDescr></entityCodeDescr>
  <termsAndCondition>TERMSPRAAS2</termsAndCondition>
  <termAndConditionDescr>TERMSPRAAS2</termAndConditionDescr>
  <status>ACTIVE</status>
  <productList>
    <productCode>LOAN_001</productCode>
    <productDescription>LOAN_001</productDescription>
    <productTypFlgDesc>Product</productTypFlgDesc>
    <productCategoryFlgDesc>Loans</productCategoryFlgDesc>
  </productList>
  <productLinkedEntity>
    <linkedEntityStartDate></linkedEntityStartDate>
    <linkedEntityEndDate></linkedEntityEndDate>
    <linkedEntityCode>CHECKMP_001</linkedEntityCode>
    <linkedEntityType>MP</linkedEntityType>
  </productLinkedEntity>
  <productLinkedEntity>
    <linkedEntityStartDate></linkedEntityStartDate>
    <linkedEntityEndDate></linkedEntityEndDate>
    <linkedEntityCode>CHEKCOMP_002</linkedEntityCode>
    <linkedEntityType>MP</linkedEntityType>
  </productLinkedEntity>
  <productLinkedEntity>
    <linkedEntityStartDate></linkedEntityStartDate>
    <linkedEntityEndDate></linkedEntityEndDate>
    <linkedEntityCode>LOANSMP_003</linkedEntityCode>
    <linkedEntityType>MP</linkedEntityType>
  </productLinkedEntity>
  <productLinkedEntity>
    <linkedEntityStartDate></linkedEntityStartDate>
    <linkedEntityEndDate></linkedEntityEndDate>
    <linkedEntityCode>LOANSMP_004</linkedEntityCode>
    <linkedEntityType>MP</linkedEntityType>
  </productLinkedEntity>
</entityList>

```

```

<EntityDivision>
  <divisionCode>IND</divisionCode>
</EntityDivision>
<eligibilityDetails>
  <eligibilityStartDate>2022-01-01</eligibilityStartDate>
  <eligibilityEndDate></eligibilityEndDate>
  <eligibilityDescription>ELG_OFFLOANS1</eligibilityDescription>
  <eligibilityRule>
    <sequenceNumber>10</sequenceNumber>
    <lhsPriceParmCd>ACC_DIVISION</lhsPriceParmCd>
    <operator>=</operator>
    <rhsPriceParmCd></rhsPriceParmCd>
    <rhsPriceParmVal>IND</rhsPriceParmVal>
    <lhsPriceParmCd1></lhsPriceParmCd1>
    <rhsPriceParmTypeFlg>VAL</rhsPriceParmTypeFlg>
    <trueFlag>RLTR</trueFlag>
    <falseFlag>RLFS</falseFlag>
    <insufficientFlag>RLFS</insufficientFlag>
  </eligibilityRule>
</eligibilityDetails>
<services>
  <serviceName>Product Service PRASS2</serviceName>
  <mandatoryFlag>true</mandatoryFlag>
</services>
<services>
  <serviceName>MH division product service</serviceName>
  <mandatoryFlag>true</mandatoryFlag>
</services>
<services>
  <serviceName>Product Service PRASS1</serviceName>
  <mandatoryFlag>true</mandatoryFlag>
</services>
<pricing>
  <priority>1</priority>
  <priceListId>4368251923</priceListId>
  <priceListDescription>Currency_Con_PriceList -1</priceListDescription>
  <priceListStartDate>2022-01-11</priceListStartDate>
  <priceListEndDate>2022-04-11</priceListEndDate>
  <noOfDays>90</noOfDays>
  <priceItemCode>CC_021</priceItemCode>
  <priceitemDescr>CC_21-Account Opening Fee</priceitemDescr>
  <priceAsgnId>4360009281</priceAsgnId>
  <validityFlag></validityFlag>
  <sourceEntityType></sourceEntityType>
  <sourceEntityCode></sourceEntityCode>
  <priceListInfo></priceListInfo>
  <priceComponent>
    <priceCompId>4367475002</priceCompId>
    <pricecomptier>
      <priceCompSequenceNo></priceCompSequenceNo>
      <businessObjectDataArea></businessObjectDataArea>
      <priceItemParmGroupId></priceItemParmGroupId>
      <toVal></toVal>
      <fromVal></fromVal>
      <timeOfUse></timeOfUse>
      <priceItemCode></priceItemCode>
      <priceCriteria></priceCriteria>
      <priceCompId></priceCompId>
      <tieSeqNum></tieSeqNum>
      <version></version>
    </pricecomptier>
    <priceComponentDescription>FLAT</priceComponentDescription>
    <valueAmt>0.400000000000000000</valueAmt>
    <priceComponentDisplay>>false</priceComponentDisplay>
  </priceComponent>
</pricing>

```

```

        <rcMapId></rcMapId>
        <tieredFlag></tieredFlag>
        <priceCompSequenceNo2>0</priceCompSequenceNo2>
    </priceComponent>
</pricing>
<pricing>
    <priority>1</priority>
    <priceListId>4368251923</priceListId>
    <priceListDescription>Currency_Con_PriceList -1</priceListDescription>
    <priceListStartDate>2022-01-11</priceListStartDate>
    <priceListEndDate>2022-04-11</priceListEndDate>
    <noOfDays>90</noOfDays>
    <priceItemCode>CC_022</priceItemCode>
    <priceitemDescr>CC2-Monthly Acct Serv Fee</priceitemDescr>
    <priceAsgnId>4360009282</priceAsgnId>
    <validityFlag></validityFlag>
    <sourceEntityType></sourceEntityType>
    <sourceEntityCode></sourceEntityCode>
    <priceListInfo></priceListInfo>
    <priceComponent>
        <priceCompId>4367475004</priceCompId>
        <pricecomptier>
            <priceCompSequenceNo></priceCompSequenceNo>
            <businessObjectDataArea></businessObjectDataArea>
            <priceItemParmGroupId></priceItemParmGroupId>
            <toVal></toVal>
            <fromVal></fromVal>
            <timeOfUse></timeOfUse>
            <priceItemCode></priceItemCode>
            <priceCriteria></priceCriteria>
            <priceCompId></priceCompId>
            <tieSeqNum></tieSeqNum>
            <version></version>
        </pricecomptier>
        <priceComponentDescription>FLAT</priceComponentDescription>
        <valueAmt>0.600000000000000000</valueAmt>
        <priceComponentDisplay>>false</priceComponentDisplay>
        <rcMapId></rcMapId>
        <tieredFlag></tieredFlag>
        <priceCompSequenceNo2>0</priceCompSequenceNo2>
    </priceComponent>
</pricing>
<pricing>
    <priority>1</priority>
    <priceListId>4368251923</priceListId>
    <priceListDescription>Currency_Con_PriceList -1</priceListDescription>
    <priceListStartDate>2022-01-11</priceListStartDate>
    <priceListEndDate>2022-04-11</priceListEndDate>
    <noOfDays>90</noOfDays>
    <priceItemCode>CC_024</priceItemCode>
    <priceitemDescr>CC3-SEPA Transfers</priceitemDescr>
    <priceAsgnId>4360009283</priceAsgnId>
    <validityFlag></validityFlag>
    <sourceEntityType></sourceEntityType>
    <sourceEntityCode></sourceEntityCode>
    <priceListInfo></priceListInfo>
    <priceComponent>
        <priceCompId>4367475006</priceCompId>
        <pricecomptier>
            <priceCompSequenceNo></priceCompSequenceNo>
            <businessObjectDataArea></businessObjectDataArea>
            <priceItemParmGroupId></priceItemParmGroupId>
            <toVal></toVal>
            <fromVal></fromVal>

```

```

        <timeOfUse></timeOfUse>
        <priceItemCode></priceItemCode>
        <priceCriteria></priceCriteria>
        <priceCompId></priceCompId>
        <tieSeqNum></tieSeqNum>
        <version></version>
    </pricecomptier>
    <priceComponentDescription>FLAT</priceComponentDescription>
    <valueAmt>0.250000000000000000</valueAmt>
    <priceComponentDisplay>>false</priceComponentDisplay>
    <rcMapId></rcMapId>
    <tieredFlag></tieredFlag>
    <priceCompSequenceNo2>0</priceCompSequenceNo2>
</priceComponent>
</pricing>
<pricing>
    <priority>1</priority>
    <priceListId>4368251923</priceListId>
    <priceListDescription>Currency_Con_PriceList -1</priceListDescription>
    <priceListStartDate>2022-01-11</priceListStartDate>
    <priceListEndDate>2022-04-11</priceListEndDate>
    <noOfDays>90</noOfDays>
    <priceItemCode>CC_025</priceItemCode>
    <priceitemDescr>CC4-Domestic Funds Transfer Fee</priceitemDescr>
    <priceAsgnId>4360009284</priceAsgnId>
    <validityFlag></validityFlag>
    <sourceEntityType></sourceEntityType>
    <sourceEntityCode></sourceEntityCode>
    <priceListInfo></priceListInfo>
    <priceComponent>
        <priceCompId>4367475008</priceCompId>
        <pricecomptier>
            <priceCompSequenceNo></priceCompSequenceNo>
            <businessObjectDataArea></businessObjectDataArea>
            <priceItemParmGroupId></priceItemParmGroupId>
            <toVal></toVal>
            <fromVal></fromVal>
            <timeOfUse></timeOfUse>
            <priceItemCode></priceItemCode>
            <priceCriteria></priceCriteria>
            <priceCompId></priceCompId>
            <tieSeqNum></tieSeqNum>
            <version></version>
        </pricecomptier>
        <priceComponentDescription>FLAT</priceComponentDescription>
        <valueAmt>112.040000000000000000</valueAmt>
        <priceComponentDisplay>>false</priceComponentDisplay>
        <rcMapId></rcMapId>
        <tieredFlag></tieredFlag>
        <priceCompSequenceNo2>0</priceCompSequenceNo2>
    </priceComponent>
</pricing>
<pricing>
    <priority>3</priority>
    <priceListId>5417730766</priceListId>
    <priceListDescription>PriceList -1</priceListDescription>
    <priceListStartDate>2022-01-11</priceListStartDate>
    <priceListEndDate>2022-03-12</priceListEndDate>
    <noOfDays>60</noOfDays>
    <priceItemCode>PI_021</priceItemCode>
    <priceitemDescr>V1-Account Opening Fee</priceitemDescr>
    <priceAsgnId>5410009202</priceAsgnId>
    <validityFlag></validityFlag>
    <sourceEntityType></sourceEntityType>

```

```

<sourceEntityCode></sourceEntityCode>
<priceListInfo></priceListInfo>
<priceComponent>
  <priceCompId>5417300004</priceCompId>
  <pricecomptier>
    <priceCompSequenceNo></priceCompSequenceNo>
    <businessObjectDataArea></businessObjectDataArea>
    <priceItemParmGroupId></priceItemParmGroupId>
    <toVal></toVal>
    <fromVal></fromVal>
    <timeOfUse></timeOfUse>
    <priceItemCode></priceItemCode>
    <priceCriteria></priceCriteria>
    <priceCompId></priceCompId>
    <tieSeqNum></tieSeqNum>
    <version></version>
  </pricecomptier>
  <priceComponentDescription>FLAT</priceComponentDescription>
  <valueAmt>0.250000000000000000</valueAmt>
  <priceComponentDisplay>>false</priceComponentDisplay>
  <rcMapId></rcMapId>
  <tieredFlag></tieredFlag>
  <priceCompSequenceNo2>0</priceCompSequenceNo2>
</priceComponent>
</pricing>
<pricing>
  <priority>3</priority>
  <priceListId>5417730766</priceListId>
  <priceListDescription>PriceList -1</priceListDescription>
  <priceListStartDate>2022-01-11</priceListStartDate>
  <priceListEndDate>2022-03-12</priceListEndDate>
  <noOfDays>60</noOfDays>
  <priceItemCode>PI_022</priceItemCode>
  <priceitemDescr>V2-Monthly Acct Serv Fee</priceitemDescr>
  <priceAsgnId>5410009203</priceAsgnId>
  <validityFlag></validityFlag>
  <sourceEntityType></sourceEntityType>
  <sourceEntityCode></sourceEntityCode>
  <priceListInfo></priceListInfo>
  <priceComponent>
    <priceCompId>5417300006</priceCompId>
    <pricecomptier>
      <priceCompSequenceNo></priceCompSequenceNo>
      <businessObjectDataArea></businessObjectDataArea>
      <priceItemParmGroupId></priceItemParmGroupId>
      <toVal></toVal>
      <fromVal></fromVal>
      <timeOfUse></timeOfUse>
      <priceItemCode></priceItemCode>
      <priceCriteria></priceCriteria>
      <priceCompId></priceCompId>
      <tieSeqNum></tieSeqNum>
      <version></version>
    </pricecomptier>
    <priceComponentDescription>FLAT</priceComponentDescription>
    <valueAmt>112.040000000000000000</valueAmt>
    <priceComponentDisplay>>false</priceComponentDisplay>
    <rcMapId></rcMapId>
    <tieredFlag></tieredFlag>
    <priceCompSequenceNo2>0</priceCompSequenceNo2>
  </priceComponent>
</pricing>
<pricing>
  <priority>3</priority>

```

```

<priceListId>5417730766</priceListId
<priceListDescription>PriceList -1</priceListDescription>
<priceListStartDate>2022-01-11</priceListStartDate>
<priceListEndDate>2022-03-12</priceListEndDate>
<noOfDays>60</noOfDays>
<priceItemCode>PI_023</priceItemCode>
<priceitemDescr>V3-Audit Reports</priceitemDescr>
<priceAsgnId>5410009204</priceAsgnId>
<validityFlag></validityFlag>
<sourceEntityType></sourceEntityType>
<sourceEntityCode></sourceEntityCode>
<priceListInfo></priceListInfo>
<priceComponent>
  <priceCompId>5417300008</priceCompId>
  <pricecomptier>
    <priceCompSequenceNo></priceCompSequenceNo>
    <businessObjectDataArea></businessObjectDataArea>
    <priceItemParmGroupId></priceItemParmGroupId>
    <toVal></toVal>
    <fromVal></fromVal>
    <timeOfUse></timeOfUse>
    <priceItemCode></priceItemCode>
    <priceCriteria></priceCriteria>
    <priceCompId></priceCompId>
    <tieSeqNum></tieSeqNum>
    <version></version>
  </pricecomptier>
  <priceComponentDescription>FLAT</priceComponentDescription>
  <valueAmt>276.250000000000000000</valueAmt>
  <priceComponentDisplay>false</priceComponentDisplay>
  <rcMapId></rcMapId>
  <tieredFlag></tieredFlag>
  <priceCompSequenceNo2>0</priceCompSequenceNo2>
</priceComponent>
<pricing>
  <priority>3</priority>
  <priceListId>5417730766</priceListId
  <priceListDescription>PriceList -1</priceListDescription>
  <priceListStartDate>2022-01-11</priceListStartDate>
  <priceListEndDate>2022-03-12</priceListEndDate>
  <noOfDays>60</noOfDays>
  <priceItemCode>PI_024</priceItemCode>
  <priceitemDescr>V4-SEPA Transfers</priceitemDescr>
  <priceAsgnId>5410009241</priceAsgnId>
  <validityFlag></validityFlag>
  <sourceEntityType></sourceEntityType>
  <sourceEntityCode></sourceEntityCode>
  <priceListInfo></priceListInfo>
  <priceComponent>
    <priceCompId>5417400004</priceCompId>
    <pricecomptier>
      <priceCompSequenceNo>0</priceCompSequenceNo>
      <businessObjectDataArea></businessObjectDataArea>
      <priceItemParmGroupId>1</priceItemParmGroupId>
      <toVal>1000.000000000000000000</toVal>
      <fromVal>0.000000000000000000</fromVal>
      <timeOfUse></timeOfUse>
      <priceItemCode>PI_024</priceItemCode>
      <priceCriteria>NBRTRAN</priceCriteria>
      <priceCompId></priceCompId>
      <tieSeqNum>10</tieSeqNum>
      <version>0</version>
    </pricecomptier>
  </priceComponent>

```



```

        <priceCompSequenceNo>0</priceCompSequenceNo>
        <businessObjectDataArea></businessObjectDataArea>
        <priceItemParmGroupId>1</priceItemParmGroupId>
        <toVal>5000.00000000000000000000</toVal>
        <fromVal>1000.00000000000000000000</fromVal>
        <timeOfUse></timeOfUse>
        <priceItemCode>PI_024</priceItemCode>
        <priceCriteria>NBRTRAN</priceCriteria>
        <priceCompId></priceCompId>
        <tieSeqNum>10</tieSeqNum>
        <version>0</version>
    </pricecomptier>
    <pricecomptier>
        <priceCompSequenceNo>0</priceCompSequenceNo>
        <businessObjectDataArea></businessObjectDataArea>
        <priceItemParmGroupId>1</priceItemParmGroupId>
        <toVal>999999999999.99000000000000000000</toVal>
        <fromVal>5000.00000000000000000000</fromVal>
        <timeOfUse></timeOfUse>
        <priceItemCode>PI_024</priceItemCode>
        <priceCriteria>NBRTRAN</priceCriteria>
        <priceCompId></priceCompId>
        <tieSeqNum>10</tieSeqNum>
        <version>0</version>
    </pricecomptier>
    <priceComponentDescription>Price per transaction - Step Tier
1</priceComponentDescription>
    <valueAmt>12.95000000000000000000</valueAmt>
    <priceComponentDisplay>false</priceComponentDisplay>
    <rcMapId></rcMapId>
    <tieredFlag></tieredFlag>
    <priceCompSequenceNo2>0</priceCompSequenceNo2>
</priceComponent>
<priceComponent>
    <priceCompId>5417400005</priceCompId>
    <pricecomptier>
        <priceCompSequenceNo>0</priceCompSequenceNo>
        <businessObjectDataArea></businessObjectDataArea>
        <priceItemParmGroupId>1</priceItemParmGroupId>
        <toVal>1000.00000000000000000000</toVal>
        <fromVal>0.00000000000000000000</fromVal>
        <timeOfUse></timeOfUse>
        <priceItemCode>PI_024</priceItemCode>
        <priceCriteria>NBRTRAN</priceCriteria>
        <priceCompId></priceCompId>
        <tieSeqNum>10</tieSeqNum>
        <version>0</version>
    </pricecomptier>
    <pricecomptier>
        <priceCompSequenceNo>0</priceCompSequenceNo>
        <businessObjectDataArea></businessObjectDataArea>
        <priceItemParmGroupId>1</priceItemParmGroupId>
        <toVal>5000.00000000000000000000</toVal>
        <fromVal>1000.00000000000000000000</fromVal>
        <timeOfUse></timeOfUse>
        <priceItemCode>PI_024</priceItemCode>
        <priceCriteria>NBRTRAN</priceCriteria>
        <priceCompId></priceCompId>
        <tieSeqNum>10</tieSeqNum>
        <version>0</version>
    </pricecomptier>
    <pricecomptier>
        <priceCompSequenceNo>0</priceCompSequenceNo>
        <businessObjectDataArea></businessObjectDataArea>

```

```

        <priceItemParmGroupId>1</priceItemParmGroupId>
        <toVal>99999999999.99000000000000000000</toVal>
        <fromVal>5000.00000000000000000000</fromVal>
        <timeOfUse></timeOfUse>
        <priceItemCode>PI_024</priceItemCode>
        <priceCriteria>NBRTRAN</priceCriteria>
        <priceCompId></priceCompId>
        <tieSeqNum>10</tieSeqNum>
        <version>0</version>
    </pricecomptier>
    <priceComponentDescription>Price per transaction - Step Tier
2</priceComponentDescription>
    <valueAmt>12.15000000000000000000</valueAmt>
    <priceComponentDisplay>false</priceComponentDisplay>
    <rcMapId></rcMapId>
    <tieredFlag></tieredFlag>
    <priceCompSequenceNo2>0</priceCompSequenceNo2>
</priceComponent>
<priceComponent>
    <priceCompId>5417400006</priceCompId>
    <pricecomptier>
        <priceCompSequenceNo>0</priceCompSequenceNo>
        <businessObjectDataArea></businessObjectDataArea>
        <priceItemParmGroupId>1</priceItemParmGroupId>
        <toVal>1000.00000000000000000000</toVal>
        <fromVal>0.00000000000000000000</fromVal>
        <timeOfUse></timeOfUse>
        <priceItemCode>PI_024</priceItemCode>
        <priceCriteria>NBRTRAN</priceCriteria>
        <priceCompId></priceCompId>
        <tieSeqNum>10</tieSeqNum>
        <version>0</version>
    </pricecomptier>
</pricecomptier>
    <priceCompSequenceNo>0</priceCompSequenceNo>
    <businessObjectDataArea></businessObjectDataArea>
    <priceItemParmGroupId>1</priceItemParmGroupId>
    <toVal>5000.00000000000000000000</toVal>
    <fromVal>1000.00000000000000000000</fromVal>
    <timeOfUse></timeOfUse>
    <priceItemCode>PI_024</priceItemCode>
    <priceCriteria>NBRTRAN</priceCriteria>
    <priceCompId></priceCompId>
    <tieSeqNum>10</tieSeqNum>
    <version>0</version>
</pricecomptier>
<pricecomptier>
    <priceCompSequenceNo>0</priceCompSequenceNo>
    <businessObjectDataArea></businessObjectDataArea>
    <priceItemParmGroupId>1</priceItemParmGroupId>
    <toVal>99999999999.99000000000000000000</toVal>
    <fromVal>5000.00000000000000000000</fromVal>
    <timeOfUse></timeOfUse>
    <priceItemCode>PI_024</priceItemCode>
    <priceCriteria>NBRTRAN</priceCriteria>
    <priceCompId></priceCompId>
    <tieSeqNum>10</tieSeqNum>
    <version>0</version>
</pricecomptier>
    <priceComponentDescription>Price per transaction - Step Tier
3</priceComponentDescription>
    <valueAmt>11.95000000000000000000</valueAmt>
    <priceComponentDisplay>false</priceComponentDisplay>
    <rcMapId></rcMapId>

```

```

        <tieredFlag></tieredFlag>
        <priceCompSequenceNo2>0</priceCompSequenceNo2>
    </priceComponent>
</pricing>
<pricing>
    <priority>3</priority>
    <priceListId>5417730766</priceListId>
    <priceListDescription>PriceList -1</priceListDescription>
    <priceListStartDate>2022-01-11</priceListStartDate>
    <priceListEndDate>2022-03-12</priceListEndDate>
    <noOfDays>60</noOfDays>
    <priceItemCode>PI_025</priceItemCode>
    <priceitemDescr>V5-Domestic Funds Transfer Fee</priceitemDescr>
    <priceAsgnId>5410009242</priceAsgnId>
    <validityFlag></validityFlag>
    <sourceEntityType></sourceEntityType>
    <sourceEntityCode></sourceEntityCode>
    <priceListInfo></priceListInfo>
    <priceComponent>
        <priceCompId>5417400010</priceCompId>
        <pricecomptier>
            <priceCompSequenceNo>0</priceCompSequenceNo>
            <businessObjectDataArea></businessObjectDataArea>
            <priceItemParmGroupId>1</priceItemParmGroupId>
            <toVal>1000.00000000000000000000</toVal>
            <fromVal>0.00000000000000000000</fromVal>
            <timeOfUse></timeOfUse>
            <priceItemCode>PI_025</priceItemCode>
            <priceCriteria>NBRTRAN</priceCriteria>
            <priceCompId></priceCompId>
            <tieSeqNum>10</tieSeqNum>
            <version>0</version>
        </pricecomptier>
        <pricecomptier>
            <priceCompSequenceNo>0</priceCompSequenceNo>
            <businessObjectDataArea></businessObjectDataArea>
            <priceItemParmGroupId>1</priceItemParmGroupId>
            <toVal>5000.00000000000000000000</toVal>
            <fromVal>1000.00000000000000000000</fromVal>
            <timeOfUse></timeOfUse>
            <priceItemCode>PI_025</priceItemCode>
            <priceCriteria>NBRTRAN</priceCriteria>
            <priceCompId></priceCompId>
            <tieSeqNum>10</tieSeqNum>
            <version>0</version>
        </pricecomptier>
        <pricecomptier>
            <priceCompSequenceNo>0</priceCompSequenceNo>
            <businessObjectDataArea></businessObjectDataArea>
            <priceItemParmGroupId>1</priceItemParmGroupId>
            <toVal>999999999999.99000000000000000000</toVal>
            <fromVal>5000.00000000000000000000</fromVal>
            <timeOfUse></timeOfUse>
            <priceItemCode>PI_025</priceItemCode>
            <priceCriteria>NBRTRAN</priceCriteria>
            <priceCompId></priceCompId>
            <tieSeqNum>10</tieSeqNum>
            <version>0</version>
        </pricecomptier>
        <priceComponentDescription>Threshold price per transaction</
priceComponentDescription>
        <valueAmt>12.95000000000000000000</valueAmt>
        <priceComponentDisplay>false</priceComponentDisplay>
        <rcMapId></rcMapId>

```

```

        <tieredFlag></tieredFlag>
        <priceCompSequenceNo2>0</priceCompSequenceNo2>
    </priceComponent>
    <priceComponent>
        <priceCompId>5417400011</priceCompId>
        <pricemcptier>
            <priceCompSequenceNo>0</priceCompSequenceNo>
            <businessObjectDataArea></businessObjectDataArea>
            <priceItemParmGroupId>1</priceItemParmGroupId>
            <toVal>1000.000000000000000000</toVal>
            <fromVal>0.000000000000000000</fromVal>
            <timeOfUse></timeOfUse>
            <priceItemCode>PI_025</priceItemCode>
            <priceCriteria>NBRTRAN</priceCriteria>
            <priceCompId></priceCompId>
            <tieSeqNum>10</tieSeqNum>
            <version>0</version>
        </pricemcptier>
        <pricemcptier>
            <priceCompSequenceNo>0</priceCompSequenceNo>
            <businessObjectDataArea></businessObjectDataArea>
            <priceItemParmGroupId>1</priceItemParmGroupId>
            <toVal>5000.000000000000000000</toVal>
            <fromVal>1000.000000000000000000</fromVal>
            <timeOfUse></timeOfUse>
            <priceItemCode>PI_025</priceItemCode>
            <priceCriteria>NBRTRAN</priceCriteria>
            <priceCompId></priceCompId>
            <tieSeqNum>10</tieSeqNum>
            <version>0</version>
        </pricemcptier>
        <pricemcptier>
            <priceCompSequenceNo>0</priceCompSequenceNo>
            <businessObjectDataArea></businessObjectDataArea>
            <priceItemParmGroupId>1</priceItemParmGroupId>
            <toVal>99999999999.990000000000000000</toVal>
            <fromVal>5000.000000000000000000</fromVal>
            <timeOfUse></timeOfUse>
            <priceItemCode>PI_025</priceItemCode>
            <priceCriteria>NBRTRAN</priceCriteria>
            <priceCompId></priceCompId>
            <tieSeqNum>10</tieSeqNum>
            <version>0</version>
        </pricemcptier>
        <priceComponentDescription>Threshold price per transaction</
priceComponentDescription>
        <valueAmt>12.150000000000000000</valueAmt>
        <priceComponentDisplay>false</priceComponentDisplay>
        <rcMapId></rcMapId>
        <tieredFlag></tieredFlag>
        <priceCompSequenceNo2>0</priceCompSequenceNo2>
    </priceComponent>
    <priceComponent>
        <priceCompId>5417400012</priceCompId>
        <pricemcptier>
            <priceCompSequenceNo>0</priceCompSequenceNo>
            <businessObjectDataArea></businessObjectDataArea>
            <priceItemParmGroupId>1</priceItemParmGroupId>
            <toVal>1000.000000000000000000</toVal>
            <fromVal>0.000000000000000000</fromVal>
            <timeOfUse></timeOfUse>
            <priceItemCode>PI_025</priceItemCode>
            <priceCriteria>NBRTRAN</priceCriteria>
            <priceCompId></priceCompId>

```

```

        <tieSeqNum>10</tieSeqNum>
        <version>0</version>
    </pricecomptier>
    <pricecomptier>
        <priceCompSequenceNo>0</priceCompSequenceNo>
        <businessObjectDataArea></businessObjectDataArea>
        <priceItemParmGroupId>1</priceItemParmGroupId>
        <toVal>5000.00000000000000000000</toVal>
        <fromVal>1000.00000000000000000000</fromVal>
        <timeOfUse></timeOfUse>
        <priceItemCode>PI_025</priceItemCode>
        <priceCriteria>NBRTRAN</priceCriteria>
        <priceCompId></priceCompId>
        <tieSeqNum>10</tieSeqNum>
        <version>0</version>
    </pricecomptier>
    <pricecomptier>
        <priceCompSequenceNo>0</priceCompSequenceNo>
        <businessObjectDataArea></businessObjectDataArea>
        <priceItemParmGroupId>1</priceItemParmGroupId>
        <toVal>9999999999999999.99000000000000000000</toVal>
        <fromVal>5000.00000000000000000000</fromVal>
        <timeOfUse></timeOfUse>
        <priceItemCode>PI_025</priceItemCode>
        <priceCriteria>NBRTRAN</priceCriteria>
        <priceCompId></priceCompId>
        <tieSeqNum>10</tieSeqNum>
        <version>0</version>
    </pricecomptier>
    <priceComponentDescription>Threshold price per transaction</
priceComponentDescription>
        <valueAmt>11.95000000000000000000</valueAmt>
        <priceComponentDisplay>false</priceComponentDisplay>
        <rcMapId></rcMapId>
        <tieredFlag></tieredFlag>
        <priceCompSequenceNo2>0</priceCompSequenceNo2>
    </priceComponent>
</pricing>
<pricing>
    <priority>3</priority>
    <priceListId>5417730766</priceListId>
    <priceListDescription>PriceList -1</priceListDescription>
    <priceListStartDate>2022-01-11</priceListStartDate>
    <priceListEndDate>2022-03-12</priceListEndDate>
    <noOfDays>60</noOfDays>
    <priceItemCode>PI_026</priceItemCode>
    <priceitemDescr>V6-Electronic Credits</priceitemDescr>
    <priceAsgnId>5410009243</priceAsgnId>
    <validityFlag></validityFlag>
    <sourceEntityType></sourceEntityType>
    <sourceEntityCode></sourceEntityCode>
    <priceListInfo></priceListInfo>
    <priceComponent>
        <priceCompId>5417400020</priceCompId>
        <pricecomptier>
            <priceCompSequenceNo>0</priceCompSequenceNo>
            <businessObjectDataArea></businessObjectDataArea>
            <priceItemParmGroupId>1</priceItemParmGroupId>
            <toVal>1000.00000000000000000000</toVal>
            <fromVal>0.00000000000000000000</fromVal>
            <timeOfUse></timeOfUse>
            <priceItemCode>PI_026</priceItemCode>
            <priceCriteria>NBRTRAN</priceCriteria>
            <priceCompId></priceCompId>

```

```

        <tieSeqNum>10</tieSeqNum>
        <version>0</version>
    </pricecomptier>
    <pricecomptier>
        <priceCompSequenceNo>0</priceCompSequenceNo>
        <businessObjectDataArea></businessObjectDataArea>
        <priceItemParmGroupId>1</priceItemParmGroupId>
        <toVal>5000.00000000000000000000</toVal>
        <fromVal>1000.00000000000000000000</fromVal>
        <timeOfUse></timeOfUse>
        <priceItemCode>PI_026</priceItemCode>
        <priceCriteria>NBRTRAN</priceCriteria>
        <priceCompId></priceCompId>
        <tieSeqNum>10</tieSeqNum>
        <version>0</version>
    </pricecomptier>
    <pricecomptier>
        <priceCompSequenceNo>0</priceCompSequenceNo>
        <businessObjectDataArea></businessObjectDataArea>
        <priceItemParmGroupId>1</priceItemParmGroupId>
        <toVal>9999999999999.99000000000000000000</toVal>
        <fromVal>5000.00000000000000000000</fromVal>
        <timeOfUse></timeOfUse>
        <priceItemCode>PI_026</priceItemCode>
        <priceCriteria>NBRTRAN</priceCriteria>
        <priceCompId></priceCompId>
        <tieSeqNum>10</tieSeqNum>
        <version>0</version>
    </pricecomptier>
    <pricecomptier>
        <priceCompSequenceNo>0</priceCompSequenceNo>
        <businessObjectDataArea></businessObjectDataArea>
        <priceItemParmGroupId>1</priceItemParmGroupId>
        <toVal>1000.00000000000000000000</toVal>
        <fromVal>0.00000000000000000000</fromVal>
        <timeOfUse></timeOfUse>
        <priceItemCode>PI_026</priceItemCode>
        <priceCriteria>NBRTRAN</priceCriteria>
        <priceCompId></priceCompId>
        <tieSeqNum>10</tieSeqNum>
        <version>0</version>
    </pricecomptier>
    <pricecomptier>
        <priceCompSequenceNo>0</priceCompSequenceNo>
        <businessObjectDataArea></businessObjectDataArea>
        <priceItemParmGroupId>1</priceItemParmGroupId>
        <toVal>5000.00000000000000000000</toVal>
        <fromVal>1000.00000000000000000000</fromVal>
        <timeOfUse></timeOfUse>
        <priceItemCode>PI_026</priceItemCode>
        <priceCriteria>NBRTRAN</priceCriteria>
        <priceCompId></priceCompId>
        <tieSeqNum>10</tieSeqNum>
        <version>0</version>
    </pricecomptier>
    <pricecomptier>
        <priceCompSequenceNo>0</priceCompSequenceNo>
        <businessObjectDataArea></businessObjectDataArea>
        <priceItemParmGroupId>1</priceItemParmGroupId>
        <toVal>9999999999999.99000000000000000000</toVal>
        <fromVal>5000.00000000000000000000</fromVal>
        <timeOfUse></timeOfUse>
        <priceItemCode>PI_026</priceItemCode>
        <priceCriteria>NBRTRAN</priceCriteria>

```

```

        <priceCompId></priceCompId>
        <tieSeqNum>10</tieSeqNum>
        <version>0</version>
    </pricecomptier>
<priceComponentDescription>Basic charges</priceComponentDescription>
    <valueAmt>20.000000000000000000</valueAmt>
    <priceComponentDisplay>false</priceComponentDisplay>
    <rcMapId></rcMapId>
    <tieredFlag></tieredFlag>
    <priceCompSequenceNo2>0</priceCompSequenceNo2>
</priceComponent>
<priceComponent>
    <priceCompId>5417400021</priceCompId>
    <pricecomptier>
        <priceCompSequenceNo>0</priceCompSequenceNo>
        <businessObjectDataArea></businessObjectDataArea>
        <priceItemParmGroupId>1</priceItemParmGroupId>
        <toVal>1000.000000000000000000</toVal>
        <fromVal>0.000000000000000000</fromVal>
        <timeOfUse></timeOfUse>
        <priceItemCode>PI_026</priceItemCode>
        <priceCriteria>NBRTRAN</priceCriteria>
        <priceCompId></priceCompId>
        <tieSeqNum>10</tieSeqNum>
        <version>0</version>
    </pricecomptier>
    <pricecomptier>
        <priceCompSequenceNo>0</priceCompSequenceNo>
        <businessObjectDataArea></businessObjectDataArea>
        <priceItemParmGroupId>1</priceItemParmGroupId>
        <toVal>5000.000000000000000000</toVal>
        <fromVal>1000.000000000000000000</fromVal>
        <timeOfUse></timeOfUse>
        <priceItemCode>PI_026</priceItemCode>
        <priceCriteria>NBRTRAN</priceCriteria>
        <priceCompId></priceCompId>
        <tieSeqNum>10</tieSeqNum>
        <version>0</version>
    </pricecomptier>
    <pricecomptier>
        <priceCompSequenceNo>0</priceCompSequenceNo>
        <businessObjectDataArea></businessObjectDataArea>
        <priceItemParmGroupId>1</priceItemParmGroupId>
        <toVal>99999999999.990000000000000000</toVal>
        <fromVal>5000.000000000000000000</fromVal>
        <timeOfUse></timeOfUse>
        <priceItemCode>PI_026</priceItemCode>
        <priceCriteria>NBRTRAN</priceCriteria>
        <priceCompId></priceCompId>
        <tieSeqNum>10</tieSeqNum>
        <version>0</version>
    </pricecomptier>
    <pricecomptier>
        <priceCompSequenceNo>0</priceCompSequenceNo>
        <businessObjectDataArea></businessObjectDataArea>
        <priceItemParmGroupId>1</priceItemParmGroupId>
        <toVal>1000.000000000000000000</toVal>
        <fromVal>0.000000000000000000</fromVal>
        <timeOfUse></timeOfUse>
        <priceItemCode>PI_026</priceItemCode>
        <priceCriteria>NBRTRAN</priceCriteria>
        <priceCompId></priceCompId>
        <tieSeqNum>10</tieSeqNum>
        <version>0</version>
    </pricecomptier>

```

```

    </pricecomptier>
    <pricecomptier>
      <priceCompSequenceNo>0</priceCompSequenceNo>
      <businessObjectDataArea></businessObjectDataArea>
      <priceItemParmGroupId>1</priceItemParmGroupId>
      <toVal>5000.00000000000000000000</toVal>
      <fromVal>1000.00000000000000000000</fromVal>
      <timeOfUse></timeOfUse>
      <priceItemCode>PI_026</priceItemCode>
      <priceCriteria>NBRTRAN</priceCriteria>
      <priceCompId></priceCompId>
      <tieSeqNum>10</tieSeqNum>
      <version>0</version>
    </pricecomptier>
  </pricecomptier>
  <pricecomptier>
    <priceCompSequenceNo>0</priceCompSequenceNo>
    <businessObjectDataArea></businessObjectDataArea>
    <priceItemParmGroupId>1</priceItemParmGroupId>
    <toVal>99999999999.99000000000000000000</toVal>
    <fromVal>5000.00000000000000000000</fromVal>
    <timeOfUse></timeOfUse>
    <priceItemCode>PI_026</priceItemCode>
    <priceCriteria>NBRTRAN</priceCriteria>
    <priceCompId></priceCompId>
    <tieSeqNum>10</tieSeqNum>
    <version>0</version>
  </pricecomptier>
  <priceComponentDescription>Threshold price</
priceComponentDescription>
  <valueAmt>10.00000000000000000000</valueAmt>
  <priceComponentDisplay>false</priceComponentDisplay>
  <rcMapId></rcMapId>
  <tieredFlag></tieredFlag>
  <priceCompSequenceNo2>0</priceCompSequenceNo2>
</priceComponent>
<priceComponent>
  <priceCompId>5417400022</priceCompId>
  <pricecomptier>
    <priceCompSequenceNo>0</priceCompSequenceNo>
    <businessObjectDataArea></businessObjectDataArea>
    <priceItemParmGroupId>1</priceItemParmGroupId>
    <toVal>1000.00000000000000000000</toVal>
    <fromVal>0.00000000000000000000</fromVal>
    <timeOfUse></timeOfUse>
    <priceItemCode>PI_026</priceItemCode>
    <priceCriteria>NBRTRAN</priceCriteria>
    <priceCompId></priceCompId>
    <tieSeqNum>10</tieSeqNum>
    <version>0</version>
  </pricecomptier>
  <pricecomptier>
    <priceCompSequenceNo>0</priceCompSequenceNo>
    <businessObjectDataArea></businessObjectDataArea>
    <priceItemParmGroupId>1</priceItemParmGroupId>
    <toVal>5000.00000000000000000000</toVal>
    <fromVal>1000.00000000000000000000</fromVal>
    <timeOfUse></timeOfUse>
    <priceItemCode>PI_026</priceItemCode>
    <priceCriteria>NBRTRAN</priceCriteria>
    <priceCompId></priceCompId>
    <tieSeqNum>10</tieSeqNum>
    <version>0</version>
  </pricecomptier>
</pricecomptier>

```



```

        <priceCompSequenceNo>0</priceCompSequenceNo>
        <businessObjectDataArea></businessObjectDataArea>
        <priceItemParmGroupId>1</priceItemParmGroupId>
        <toVal>9999999999999999.9900000000000000000</toVal>
        <fromVal>5000.0000000000000000000</fromVal>
        <timeOfUse></timeOfUse>
        <priceItemCode>PI_026</priceItemCode>
        <priceCriteria>NBRTRAN</priceCriteria>
        <priceCompId></priceCompId>
        <tieSeqNum>10</tieSeqNum>
        <version>0</version>
    </pricecomptier>
    <pricecomptier>
        <priceCompSequenceNo>0</priceCompSequenceNo>
        <businessObjectDataArea></businessObjectDataArea>
        <priceItemParmGroupId>1</priceItemParmGroupId>
        <toVal>1000.0000000000000000000</toVal>
        <fromVal>0.0000000000000000000</fromVal>
        <timeOfUse></timeOfUse>
        <priceItemCode>PI_026</priceItemCode>
        <priceCriteria>NBRTRAN</priceCriteria>
        <priceCompId></priceCompId>
        <tieSeqNum>10</tieSeqNum>
        <version>0</version>
    </pricecomptier>
    <pricecomptier>
        <priceCompSequenceNo>0</priceCompSequenceNo>
        <businessObjectDataArea></businessObjectDataArea>
        <priceItemParmGroupId>1</priceItemParmGroupId>
        <toVal>5000.0000000000000000000</toVal>
        <fromVal>1000.0000000000000000000</fromVal>
        <timeOfUse></timeOfUse>
        <priceItemCode>PI_026</priceItemCode>
        <priceCriteria>NBRTRAN</priceCriteria>
        <priceCompId></priceCompId>
        <tieSeqNum>10</tieSeqNum>
        <version>0</version>
    </pricecomptier>
    <pricecomptier>
        <priceCompSequenceNo>0</priceCompSequenceNo>
        <businessObjectDataArea></businessObjectDataArea>
        <priceItemParmGroupId>1</priceItemParmGroupId>
        <toVal>9999999999999999.9900000000000000000</toVal>
        <fromVal>5000.0000000000000000000</fromVal>
        <timeOfUse></timeOfUse>
        <priceItemCode>PI_026</priceItemCode>
        <priceCriteria>NBRTRAN</priceCriteria>
        <priceCompId></priceCompId>
        <tieSeqNum>10</tieSeqNum>
        <version>0</version>
    </pricecomptier>
        <priceComponentDescription>Threshold price</
priceComponentDescription>
        <valueAmt>8.0000000000000000000</valueAmt>
        <priceComponentDisplay>false</priceComponentDisplay>
        <rcMapId></rcMapId>
        <tieredFlag></tieredFlag>
        <priceCompSequenceNo2>0</priceCompSequenceNo2>
    </priceComponent>
    <priceComponent>
        <priceCompId>5417400023</priceCompId>
        <pricecomptier>
            <priceCompSequenceNo>0</priceCompSequenceNo>
            <businessObjectDataArea></businessObjectDataArea>

```

```

    <priceItemParmGroupId>1</priceItemParmGroupId>
    <toVal>1000.000000000000000000</toVal>
    <fromVal>0.000000000000000000</fromVal>
    <timeOfUse></timeOfUse>
    <priceItemCode>PI_026</priceItemCode>
    <priceCriteria>NBRTRAN</priceCriteria>
    <priceCompId></priceCompId>
    <tieSeqNum>10</tieSeqNum>
    <version>0</version>
  </pricecomptier>
</pricecomptier>
<pricecomptier>
  <priceCompSequenceNo>0</priceCompSequenceNo>
  <businessObjectDataArea></businessObjectDataArea>
  <priceItemParmGroupId>1</priceItemParmGroupId>
  <toVal>5000.000000000000000000</toVal>
  <fromVal>1000.000000000000000000</fromVal>
  <timeOfUse></timeOfUse>
  <priceItemCode>PI_026</priceItemCode>
  <priceCriteria>NBRTRAN</priceCriteria>
  <priceCompId></priceCompId>
  <tieSeqNum>10</tieSeqNum>
  <version>0</version>
</pricecomptier>
</pricecomptier>
<pricecomptier>
  <priceCompSequenceNo>0</priceCompSequenceNo>
  <businessObjectDataArea></businessObjectDataArea>
  <priceItemParmGroupId>1</priceItemParmGroupId>
  <toVal>999999999999.990000000000000000</toVal>
  <fromVal>5000.000000000000000000</fromVal>
  <timeOfUse></timeOfUse>
  <priceItemCode>PI_026</priceItemCode>
  <priceCriteria>NBRTRAN</priceCriteria>
  <priceCompId></priceCompId>
  <tieSeqNum>10</tieSeqNum>
  <version>0</version>
</pricecomptier>
</pricecomptier>
<pricecomptier>
  <priceCompSequenceNo>0</priceCompSequenceNo>
  <businessObjectDataArea></businessObjectDataArea>
  <priceItemParmGroupId>1</priceItemParmGroupId>
  <toVal>1000.000000000000000000</toVal>
  <fromVal>0.000000000000000000</fromVal>
  <timeOfUse></timeOfUse>
  <priceItemCode>PI_026</priceItemCode>
  <priceCriteria>NBRTRAN</priceCriteria>
  <priceCompId></priceCompId>
  <tieSeqNum>10</tieSeqNum>
  <version>0</version>
</pricecomptier>
</pricecomptier>
<pricecomptier>
  <priceCompSequenceNo>0</priceCompSequenceNo>
  <businessObjectDataArea></businessObjectDataArea>
  <priceItemParmGroupId>1</priceItemParmGroupId>
  <toVal>5000.000000000000000000</toVal>
  <fromVal>1000.000000000000000000</fromVal>
  <timeOfUse></timeOfUse>
  <priceItemCode>PI_026</priceItemCode>
  <priceCriteria>NBRTRAN</priceCriteria>
  <priceCompId></priceCompId>
  <tieSeqNum>10</tieSeqNum>
  <version>0</version>
</pricecomptier>
</pricecomptier>
<pricecomptier>
  <priceCompSequenceNo>0</priceCompSequenceNo>

```

```

        <businessObjectDataArea></businessObjectDataArea>
        <priceItemParmGroupId>1</priceItemParmGroupId>
        <toVal>999999999999.99000000000000000000</toVal>
        <fromVal>5000.00000000000000000000</fromVal>
        <timeOfUse></timeOfUse>
        <priceItemCode>PI_026</priceItemCode>
        <priceCriteria>NBRTRAN</priceCriteria>
        <priceCompId></priceCompId>
        <tieSeqNum>10</tieSeqNum>
        <version>0</version>
    </pricecomptier>
        <priceComponentDescription>Threshold price</
priceComponentDescription>
        <valueAmt>6.00000000000000000000</valueAmt>
        <priceComponentDisplay>false</priceComponentDisplay>
        <rcMapId></rcMapId>
        <tieredFlag></tieredFlag>
        <priceCompSequenceNo2>0</priceCompSequenceNo2>
    </priceComponent>
    <priceComponent>
        <priceCompId>5417400024</priceCompId>
        <pricecomptier>
            <priceCompSequenceNo>0</priceCompSequenceNo>
            <businessObjectDataArea></businessObjectDataArea>
            <priceItemParmGroupId>1</priceItemParmGroupId>
            <toVal>1000.00000000000000000000</toVal>
            <fromVal>0.00000000000000000000</fromVal>
            <timeOfUse></timeOfUse>
            <priceItemCode>PI_026</priceItemCode>
            <priceCriteria>NBRTRAN</priceCriteria>
            <priceCompId></priceCompId>
            <tieSeqNum>10</tieSeqNum>
            <version>0</version>
        </pricecomptier>
        <pricecomptier>
            <priceCompSequenceNo>0</priceCompSequenceNo>
            <businessObjectDataArea></businessObjectDataArea>
            <priceItemParmGroupId>1</priceItemParmGroupId>
            <toVal>5000.00000000000000000000</toVal>
            <fromVal>1000.00000000000000000000</fromVal>
            <timeOfUse></timeOfUse>
            <priceItemCode>PI_026</priceItemCode>
            <priceCriteria>NBRTRAN</priceCriteria>
            <priceCompId></priceCompId>
            <tieSeqNum>10</tieSeqNum>
            <version>0</version>
        </pricecomptier>
        <pricecomptier>
            <priceCompSequenceNo>0</priceCompSequenceNo>
            <businessObjectDataArea></businessObjectDataArea>
            <priceItemParmGroupId>1</priceItemParmGroupId>
            <toVal>999999999999.99000000000000000000</toVal>
            <fromVal>5000.00000000000000000000</fromVal>
            <timeOfUse></timeOfUse>
            <priceItemCode>PI_026</priceItemCode>
            <priceCriteria>NBRTRAN</priceCriteria>
            <priceCompId></priceCompId>
            <tieSeqNum>10</tieSeqNum>
            <version>0</version>
        </pricecomptier>
        <pricecomptier>
            <priceCompSequenceNo>0</priceCompSequenceNo>
            <businessObjectDataArea></businessObjectDataArea>
            <priceItemParmGroupId>1</priceItemParmGroupId>

```

```

        <toVal>1000.00000000000000000000</toVal>
        <fromVal>0.00000000000000000000</fromVal>
        <timeOfUse></timeOfUse>
        <priceItemCode>PI_026</priceItemCode>
        <priceCriteria>NBRTRAN</priceCriteria>
        <priceCompId></priceCompId>
        <tieSeqNum>10</tieSeqNum>
        <version>0</version>
    </pricecomptier>
    <pricecomptier>
        <priceCompSequenceNo>0</priceCompSequenceNo>
        <businessObjectDataArea></businessObjectDataArea>
        <priceItemParmGroupId>1</priceItemParmGroupId>
        <toVal>5000.00000000000000000000</toVal>
        <fromVal>1000.00000000000000000000</fromVal>
        <timeOfUse></timeOfUse>
        <priceItemCode>PI_026</priceItemCode>
        <priceCriteria>NBRTRAN</priceCriteria>
        <priceCompId></priceCompId>
        <tieSeqNum>10</tieSeqNum>
        <version>0</version>
    </pricecomptier>
    <pricecomptier>
        <priceCompSequenceNo>0</priceCompSequenceNo>
        <businessObjectDataArea></businessObjectDataArea>
        <priceItemParmGroupId>1</priceItemParmGroupId>
        <toVal>999999999999.99000000000000000000</toVal>
        <fromVal>5000.00000000000000000000</fromVal>
        <timeOfUse></timeOfUse>
        <priceItemCode>PI_026</priceItemCode>
        <priceCriteria>NBRTRAN</priceCriteria>
        <priceCompId></priceCompId>
        <tieSeqNum>10</tieSeqNum>
        <version>0</version>
    </pricecomptier>
    <priceComponentDescription>Step 1</priceComponentDescription>
    <valueAmt>5.00000000000000000000</valueAmt>
    <priceComponentDisplay>false</priceComponentDisplay>
    <rcMapId></rcMapId>
    <tieredFlag></tieredFlag>
    <priceCompSequenceNo2>0</priceCompSequenceNo2>
</priceComponent>
<priceComponent>
    <priceCompId>5417400025</priceCompId>
    <pricecomptier>
        <priceCompSequenceNo>0</priceCompSequenceNo>
        <businessObjectDataArea></businessObjectDataArea>
        <priceItemParmGroupId>1</priceItemParmGroupId>
        <toVal>1000.00000000000000000000</toVal>
        <fromVal>0.00000000000000000000</fromVal>
        <timeOfUse></timeOfUse>
        <priceItemCode>PI_026</priceItemCode>
        <priceCriteria>NBRTRAN</priceCriteria>
        <priceCompId></priceCompId>
        <tieSeqNum>10</tieSeqNum>
        <version>0</version>
    </pricecomptier>
    <pricecomptier>
        <priceCompSequenceNo>0</priceCompSequenceNo>
        <businessObjectDataArea></businessObjectDataArea>
        <priceItemParmGroupId>1</priceItemParmGroupId>
        <toVal>5000.00000000000000000000</toVal>
        <fromVal>1000.00000000000000000000</fromVal>
        <timeOfUse></timeOfUse>

```

```

    <priceItemCode>PI_026</priceItemCode>
    <priceCriteria>NBRTRAN</priceCriteria>
    <priceCompId></priceCompId>
    <tieSeqNum>10</tieSeqNum>
    <version>0</version>
  </pricecomptier>
</pricecomptier>
  <priceCompSequenceNo>0</priceCompSequenceNo>
  <businessObjectDataArea></businessObjectDataArea>
  <priceItemParmGroupId>1</priceItemParmGroupId>
  <toVal>999999999999.99000000000000000000</toVal>
  <fromVal>5000.00000000000000000000</fromVal>
  <timeOfUse></timeOfUse>
  <priceItemCode>PI_026</priceItemCode>
  <priceCriteria>NBRTRAN</priceCriteria>
  <priceCompId></priceCompId>
  <tieSeqNum>10</tieSeqNum>
  <version>0</version>
</pricecomptier>
</pricecomptier>
  <priceCompSequenceNo>0</priceCompSequenceNo>
  <businessObjectDataArea></businessObjectDataArea>
  <priceItemParmGroupId>1</priceItemParmGroupId>
  <toVal>1000.00000000000000000000</toVal>
  <fromVal>0.00000000000000000000</fromVal>
  <timeOfUse></timeOfUse>
  <priceItemCode>PI_026</priceItemCode>
  <priceCriteria>NBRTRAN</priceCriteria>
  <priceCompId></priceCompId>
  <tieSeqNum>10</tieSeqNum>
  <version>0</version>
</pricecomptier>
</pricecomptier>
  <priceCompSequenceNo>0</priceCompSequenceNo>
  <businessObjectDataArea></businessObjectDataArea>
  <priceItemParmGroupId>1</priceItemParmGroupId>
  <toVal>5000.00000000000000000000</toVal>
  <fromVal>1000.00000000000000000000</fromVal>
  <timeOfUse></timeOfUse>
  <priceItemCode>PI_026</priceItemCode>
  <priceCriteria>NBRTRAN</priceCriteria>
  <priceCompId></priceCompId>
  <tieSeqNum>10</tieSeqNum>
  <version>0</version>
</pricecomptier>
</pricecomptier>
  <priceCompSequenceNo>0</priceCompSequenceNo>
  <businessObjectDataArea></businessObjectDataArea>
  <priceItemParmGroupId>1</priceItemParmGroupId>
  <toVal>999999999999.99000000000000000000</toVal>
  <fromVal>5000.00000000000000000000</fromVal>
  <timeOfUse></timeOfUse>
  <priceItemCode>PI_026</priceItemCode>
  <priceCriteria>NBRTRAN</priceCriteria>
  <priceCompId></priceCompId>
  <tieSeqNum>10</tieSeqNum>
  <version>0</version>
</pricecomptier>
</pricecomptier>
  <priceComponentDescription>Step 2</priceComponentDescription>
  <valueAmt>4.00000000000000000000</valueAmt>
  <priceComponentDisplay>false</priceComponentDisplay>
  <rcMapId></rcMapId>
  <tieredFlag></tieredFlag>
  <priceCompSequenceNo2>0</priceCompSequenceNo2>

```

```

</priceComponent>
<priceComponent>
  <priceCompId>5417400026</priceCompId>
  <pricecomptier>
    <priceCompSequenceNo>0</priceCompSequenceNo>
    <businessObjectDataArea></businessObjectDataArea>
    <priceItemParmGroupId>1</priceItemParmGroupId>
    <toVal>1000.00000000000000000000</toVal>
    <fromVal>0.00000000000000000000</fromVal>
    <timeOfUse></timeOfUse>
    <priceItemCode>PI_026</priceItemCode>
    <priceCriteria>NBRTRAN</priceCriteria>
    <priceCompId></priceCompId>
    <tieSeqNum>10</tieSeqNum>
    <version>0</version>
  </pricecomptier>
  <pricecomptier>
    <priceCompSequenceNo>0</priceCompSequenceNo>
    <businessObjectDataArea></businessObjectDataArea>
    <priceItemParmGroupId>1</priceItemParmGroupId>
    <toVal>5000.00000000000000000000</toVal>
    <fromVal>1000.00000000000000000000</fromVal>
    <timeOfUse></timeOfUse>
    <priceItemCode>PI_026</priceItemCode>
    <priceCriteria>NBRTRAN</priceCriteria>
    <priceCompId></priceCompId>
    <tieSeqNum>10</tieSeqNum>
    <version>0</version>
  </pricecomptier>
  <pricecomptier>
    <priceCompSequenceNo>0</priceCompSequenceNo>
    <businessObjectDataArea></businessObjectDataArea>
    <priceItemParmGroupId>1</priceItemParmGroupId>
    <toVal>999999999999.99000000000000000000</toVal>
    <fromVal>5000.00000000000000000000</fromVal>
    <timeOfUse></timeOfUse>
    <priceItemCode>PI_026</priceItemCode>
    <priceCriteria>NBRTRAN</priceCriteria>
    <priceCompId></priceCompId>
    <tieSeqNum>10</tieSeqNum>
    <version>0</version>
  </pricecomptier>
  <pricecomptier>
    <priceCompSequenceNo>0</priceCompSequenceNo>
    <businessObjectDataArea></businessObjectDataArea>
    <priceItemParmGroupId>1</priceItemParmGroupId>
    <toVal>1000.00000000000000000000</toVal>
    <fromVal>0.00000000000000000000</fromVal>
    <timeOfUse></timeOfUse>
    <priceItemCode>PI_026</priceItemCode>
    <priceCriteria>NBRTRAN</priceCriteria>
    <priceCompId></priceCompId>
    <tieSeqNum>10</tieSeqNum>
    <version>0</version>
  </pricecomptier>
  <pricecomptier>
    <priceCompSequenceNo>0</priceCompSequenceNo>
    <businessObjectDataArea></businessObjectDataArea>
    <priceItemParmGroupId>1</priceItemParmGroupId>
    <toVal>5000.00000000000000000000</toVal>
    <fromVal>1000.00000000000000000000</fromVal>
    <timeOfUse></timeOfUse>
    <priceItemCode>PI_026</priceItemCode>
    <priceCriteria>NBRTRAN</priceCriteria>
  </pricecomptier>

```

```

        <priceCompId></priceCompId>
        <tieSeqNum>10</tieSeqNum>
        <version>0</version>
    </pricecomptier>
    <pricecomptier>
        <priceCompSequenceNo>0</priceCompSequenceNo>
        <businessObjectDataArea></businessObjectDataArea>
        <priceItemParmGroupId>1</priceItemParmGroupId>
        <toVal>999999999999.9900000000000000000</toVal>
        <fromVal>5000.0000000000000000000</fromVal>
        <timeOfUse></timeOfUse>
        <priceItemCode>PI_026</priceItemCode>
        <priceCriteria>NBRTRAN</priceCriteria>
        <priceCompId></priceCompId>
        <tieSeqNum>10</tieSeqNum>
        <version>0</version>
    </pricecomptier>
    <priceComponentDescription>Step 3</priceComponentDescription>
    <valueAmt>3.0000000000000000000</valueAmt>
    <priceComponentDisplay>>false</priceComponentDisplay>
    <rcMapId></rcMapId>
    <tieredFlag></tieredFlag>
    <priceCompSequenceNo2>0</priceCompSequenceNo2>
</priceComponent>
</pricing>
<pricing>
    <priority>3</priority>
    <priceListId>5417730766</priceListId>
    <priceListDescription>PriceList -1</priceListDescription>
    <priceListStartDate>2022-01-11</priceListStartDate>
    <priceListEndDate>2022-03-12</priceListEndDate>
    <noOfDays>60</noOfDays>
    <priceItemCode>PI_027</priceItemCode>
    <priceitemDescr>V7-Direct Debit</priceitemDescr>
    <priceAsgnId>5410009209</priceAsgnId>
    <validityFlag></validityFlag>
    <sourceEntityType></sourceEntityType>
    <sourceEntityCode></sourceEntityCode>
    <priceListInfo></priceListInfo>
    <priceComponent>
        <priceCompId>5417300038</priceCompId>
        <pricecomptier>
            <priceCompSequenceNo></priceCompSequenceNo>
            <businessObjectDataArea></businessObjectDataArea>
            <priceItemParmGroupId>1</priceItemParmGroupId>
            <toVal></toVal>
            <fromVal></fromVal>
            <timeOfUse></timeOfUse>
            <priceItemCode></priceItemCode>
            <priceCriteria>NBRTRAN</priceCriteria>
            <priceCompId></priceCompId>
            <tieSeqNum></tieSeqNum>
            <version></version>
        </pricecomptier>
        <priceComponentDescription>Basic BK-NBR</priceComponentDescription>
        <valueAmt>0.1500000000000000000</valueAmt>
        <priceComponentDisplay>>false</priceComponentDisplay>
        <rcMapId></rcMapId>
        <tieredFlag></tieredFlag>
        <priceCompSequenceNo2>0</priceCompSequenceNo2>
    </priceComponent>
</pricing>
<pricing>
    <priority>3</priority>

```

```

<priceListId>5417730766</priceListId
<priceListDescription>PriceList -1</priceListDescription>
<priceListStartDate>2022-01-11</priceListStartDate>
<priceListEndDate>2022-03-12</priceListEndDate>
<noOfDays>60</noOfDays>
<priceItemCode>PI_028</priceItemCode>
<priceitemDescr>V8-Cheque Collections</priceitemDescr>
<priceAsgnId>5410009210</priceAsgnId>
<validityFlag></validityFlag>
<sourceEntityType></sourceEntityType>
<sourceEntityCode></sourceEntityCode>
<priceListInfo></priceListInfo>
<priceComponent>
  <priceCompId>5417300040</priceCompId>
  <pricecomptier>
    <priceCompSequenceNo></priceCompSequenceNo>
    <businessObjectDataArea></businessObjectDataArea>
    <priceItemParmGroupId>1</priceItemParmGroupId>
    <toVal></toVal>
    <fromVal></fromVal>
    <timeOfUse></timeOfUse>
    <priceItemCode></priceItemCode>
    <priceCriteria>NBRTRAN</priceCriteria>
    <priceCompId></priceCompId>
    <tieSeqNum></tieSeqNum>
    <version></version>
  </pricecomptier>
  <priceComponentDescription>FLAT</priceComponentDescription>
  <valueAmt>0.750000000000000000</valueAmt>
  <priceComponentDisplay>false</priceComponentDisplay>
  <rcMapId></rcMapId>
  <tieredFlag></tieredFlag>
  <priceCompSequenceNo2>0</priceCompSequenceNo2>
</priceComponent>
</pricing>
<pricing>
  <priority>3</priority>
  <priceListId>5417730766</priceListId
  <priceListDescription>PriceList -1</priceListDescription>
  <priceListStartDate>2022-01-11</priceListStartDate>
  <priceListEndDate>2022-03-12</priceListEndDate>
  <noOfDays>60</noOfDays>
  <priceItemCode>PI_028</priceItemCode>
  <priceitemDescr>V8-Cheque Collections</priceitemDescr>
  <priceAsgnId>5410009211</priceAsgnId>
  <validityFlag></validityFlag>
  <sourceEntityType></sourceEntityType>
  <sourceEntityCode></sourceEntityCode>
  <priceListInfo></priceListInfo>
  <priceComponent>
    <priceCompId>5417300042</priceCompId>
    <pricecomptier>
      <priceCompSequenceNo></priceCompSequenceNo>
      <businessObjectDataArea></businessObjectDataArea>
      <priceItemParmGroupId>1</priceItemParmGroupId>
      <toVal></toVal>
      <fromVal></fromVal>
      <timeOfUse></timeOfUse>
      <priceItemCode></priceItemCode>
      <priceCriteria>NBRTRAN</priceCriteria>
      <priceCompId></priceCompId>
      <tieSeqNum></tieSeqNum>
      <version></version>
    </pricecomptier>

```



```

        <priceComponentDescription>FLAT</priceComponentDescription>
        <valueAmt>6.670000000000000000</valueAmt>
        <priceComponentDisplay>>false</priceComponentDisplay>
        <rcMapId></rcMapId>
        <tieredFlag></tieredFlag>
        <priceCompSequenceNo2>0</priceCompSequenceNo2>
    </priceComponent>
</pricing>
<pricing>
    <priority>3</priority>
    <priceListId>5417730766</priceListId>
    <priceListDescription>PriceList -1</priceListDescription>
    <priceListStartDate>2022-01-11</priceListStartDate>
    <priceListEndDate>2022-03-12</priceListEndDate>
    <noOfDays>60</noOfDays>
    <priceItemCode>PI_028</priceItemCode>
    <priceitemDescr>V8-Cheque Collections</priceitemDescr>
    <priceAsgnId>5410009212</priceAsgnId>
    <validityFlag></validityFlag>
    <sourceEntityType></sourceEntityType>
    <sourceEntityCode></sourceEntityCode>
    <priceListInfo></priceListInfo>
    <priceComponent>
        <priceCompId>5417300044</priceCompId>
        <pricecomptier>
            <priceCompSequenceNo></priceCompSequenceNo>
            <businessObjectDataArea></businessObjectDataArea>
            <priceItemParmGroupId>1</priceItemParmGroupId>
            <toVal></toVal>
            <fromVal></fromVal>
            <timeOfUse></timeOfUse>
            <priceItemCode></priceItemCode>
            <priceCriteria>NBRTRAN</priceCriteria>
            <priceCompId></priceCompId>
            <tieSeqNum></tieSeqNum>
            <version></version>
        </pricecomptier>
        <priceComponentDescription>FLAT</priceComponentDescription>
        <valueAmt>0.300000000000000000</valueAmt>
        <priceComponentDisplay>>false</priceComponentDisplay>
        <rcMapId></rcMapId>
        <tieredFlag></tieredFlag>
        <priceCompSequenceNo2>0</priceCompSequenceNo2>
    </priceComponent>
</pricing>
<pricing>
    <priority>3</priority>
    <priceListId>5417730766</priceListId>
    <priceListDescription>PriceList -1</priceListDescription>
    <priceListStartDate>2022-01-11</priceListStartDate>
    <priceListEndDate>2022-02-28</priceListEndDate>
    <noOfDays>60</noOfDays>
    <priceItemCode>PI_028</priceItemCode>
    <priceitemDescr>V8-Cheque Collections</priceitemDescr>
    <priceAsgnId>5410009213</priceAsgnId>
    <validityFlag></validityFlag>
    <sourceEntityType></sourceEntityType>
    <sourceEntityCode></sourceEntityCode>
    <priceListInfo></priceListInfo>
    <priceComponent>
        <priceCompId>5417300046</priceCompId>
        <pricecomptier>
            <priceCompSequenceNo></priceCompSequenceNo>
            <businessObjectDataArea></businessObjectDataArea>

```

```

        <priceItemParmGroupId>1</priceItemParmGroupId>
        <toVal></toVal>
        <fromVal></fromVal>
        <timeOfUse></timeOfUse>
        <priceItemCode></priceItemCode>
        <priceCriteria>NBRTRAN</priceCriteria>
        <priceCompId></priceCompId>
        <tieSeqNum></tieSeqNum>
        <version></version>
    </pricecomptier>
    <priceComponentDescription>FLAT</priceComponentDescription>
    <valueAmt>2.0500000000000000</valueAmt>
    <priceComponentDisplay>>false</priceComponentDisplay>
    <rcMapId></rcMapId>
    <tieredFlag></tieredFlag>
    <priceCompSequenceNo2>0</priceCompSequenceNo2>
</priceComponent>
</pricing>
<pricing>
    <priority>3</priority>
    <priceListId>5417730766</priceListId>
    <priceListDescription>PriceList -1</priceListDescription>
    <priceListStartDate>2022-01-11</priceListStartDate>
    <priceListEndDate>2022-03-12</priceListEndDate>
    <noOfDays>60</noOfDays>
    <priceItemCode>PI_029</priceItemCode>
    <priceitemDescr>V9-Domestic Liquidity</priceitemDescr>
    <priceAsgnId>5410009214</priceAsgnId>
    <validityFlag></validityFlag>
    <sourceEntityType></sourceEntityType>
    <sourceEntityCode></sourceEntityCode>
    <priceListInfo></priceListInfo>
    <priceComponent>
        <priceCompId>5417300048</priceCompId>
        <pricecomptier>
            <priceCompSequenceNo></priceCompSequenceNo>
            <businessObjectDataArea></businessObjectDataArea>
            <priceItemParmGroupId>1</priceItemParmGroupId>
            <toVal></toVal>
            <fromVal></fromVal>
            <timeOfUse></timeOfUse>
            <priceItemCode></priceItemCode>
            <priceCriteria>NBRTRAN</priceCriteria>
            <priceCompId></priceCompId>
            <tieSeqNum></tieSeqNum>
            <version></version>
        </pricecomptier>
        <priceComponentDescription>FLAT</priceComponentDescription>
        <valueAmt>0.4000000000000000</valueAmt>
        <priceComponentDisplay>>false</priceComponentDisplay>
        <rcMapId></rcMapId>
        <tieredFlag></tieredFlag>
        <priceCompSequenceNo2>0</priceCompSequenceNo2>
    </priceComponent>
</pricing>
<pricing>
    <priority>3</priority>
    <priceListId>5417730766</priceListId>
    <priceListDescription>PriceList -1</priceListDescription>
    <priceListStartDate>2022-01-11</priceListStartDate>
    <priceListEndDate>2022-03-12</priceListEndDate>
    <noOfDays>60</noOfDays>
    <priceItemCode>PI_030</priceItemCode>
    <priceitemDescr>V10-Third Party Bank</priceitemDescr>

```

```

<priceAsgnId>5410009215</priceAsgnId>
<validityFlag></validityFlag>
<sourceEntityType></sourceEntityType>
<sourceEntityCode></sourceEntityCode>
<priceListInfo></priceListInfo>
<priceComponent>
  <priceCompId>5417300050</priceCompId>
  <pricecomptier>
    <priceCompSequenceNo></priceCompSequenceNo>
    <businessObjectDataArea></businessObjectDataArea>
    <priceItemParmGroupId>1</priceItemParmGroupId>
    <toVal></toVal>
    <fromVal></fromVal>
    <timeOfUse></timeOfUse>
    <priceItemCode></priceItemCode>
    <priceCriteria>NBRTRAN</priceCriteria>
    <priceCompId></priceCompId>
    <tieSeqNum></tieSeqNum>
    <version></version>
  </pricecomptier>
  <priceComponentDescription>FLAT</priceComponentDescription>
  <valueAmt>0.600000000000000000</valueAmt>
  <priceComponentDisplay>>false</priceComponentDisplay>
  <rcMapId></rcMapId>
  <tieredFlag></tieredFlag>
  <priceCompSequenceNo2>0</priceCompSequenceNo2>
</priceComponent>
</pricing>
<pricing>
  <priority>3</priority>
  <priceListId>5417730766</priceListId>
  <priceListDescription>PriceList -1</priceListDescription>
  <priceListStartDate>2022-01-11</priceListStartDate>
  <priceListEndDate>2022-03-12</priceListEndDate>
  <noOfDays>60</noOfDays>
  <priceItemCode>PI_031</priceItemCode>
  <priceitemDescr>MT943_SWIFT_01</priceitemDescr>
  <priceAsgnId>5410009201</priceAsgnId>
  <validityFlag></validityFlag>
  <sourceEntityType></sourceEntityType>
  <sourceEntityCode></sourceEntityCode>
  <priceListInfo></priceListInfo>
  <priceComponent>
    <priceCompId>5417300002</priceCompId>
    <pricecomptier>
      <priceCompSequenceNo></priceCompSequenceNo>
      <businessObjectDataArea></businessObjectDataArea>
      <priceItemParmGroupId>1</priceItemParmGroupId>
      <toVal></toVal>
      <fromVal></fromVal>
      <timeOfUse></timeOfUse>
      <priceItemCode></priceItemCode>
      <priceCriteria>NBRTRAN</priceCriteria>
      <priceCompId></priceCompId>
      <tieSeqNum></tieSeqNum>
      <version></version>
    </pricecomptier>
    <priceComponentDescription>FLAT</priceComponentDescription>
    <valueAmt>16.660000000000000000</valueAmt>
    <priceComponentDisplay>>false</priceComponentDisplay>
    <rcMapId></rcMapId>
    <tieredFlag></tieredFlag>
    <priceCompSequenceNo2>0</priceCompSequenceNo2>
  </priceComponent>

```

```

</pricing>
<pricing>
  <priority>3</priority>
  <priceListId>5417730766</priceListId>
  <priceListDescription>PriceList -1</priceListDescription>
  <priceListStartDate>2022-01-11</priceListStartDate>
  <priceListEndDate>2022-03-12</priceListEndDate>
  <noOfDays>60</noOfDays>
  <priceItemCode>PI_032</priceItemCode>
  <priceitemDescr>MT943_SWIFT_02</priceitemDescr>
  <priceAsgnId>5410009261</priceAsgnId>
  <validityFlag></validityFlag>
  <sourceEntityType></sourceEntityType>
  <sourceEntityCode></sourceEntityCode>
  <priceListInfo></priceListInfo>
  <priceComponent>
    <priceCompId>5417450002</priceCompId>
    <pricecomptier>
      <priceCompSequenceNo></priceCompSequenceNo>
      <businessObjectDataArea></businessObjectDataArea>
      <priceItemParmGroupId>1</priceItemParmGroupId>
      <toVal></toVal>
      <fromVal></fromVal>
      <timeOfUse></timeOfUse>
      <priceItemCode></priceItemCode>
      <priceCriteria>NBRTRAN</priceCriteria>
      <priceCompId></priceCompId>
      <tieSeqNum></tieSeqNum>
      <version></version>
    </pricecomptier>
    <priceComponentDescription>FLAT</priceComponentDescription>
    <valueAmt>15.000000000000000000</valueAmt>
    <priceComponentDisplay>false</priceComponentDisplay>
    <rcMapId></rcMapId>
    <tieredFlag></tieredFlag>
    <priceCompSequenceNo2>0</priceCompSequenceNo2>
  </priceComponent>
</pricing>
</entityList>
<messageCategory>0</messageCategory>
<messageNumber>0</messageNumber>
<messageText></messageText>
<longDescription></longDescription>
<inquiryTypeFlag>DETL</inquiryTypeFlag>
</C1_GETELIGIBLEPROD>

```

Related Topics

For more information on...	See...
Eligible Market Products, Offers, or Bundles Derivation Request and Response - Tags in XML Format	Eligible Market Products, Offers, or Bundles Derivation Request and Response - Tags in XML Format on page 3294

Sample Eligible Bundle Derivation Request and Response in the XML Format

Using the below example, you can derive the eligible bundles which are processed on **2022-01-11**.

Sample Eligible Bundle Request in the XML Format

```

<C1_GETELIGIBLEPROD>
  <productCode>LOAN_001</productCode>
  <productCategoryFlg></productCategoryFlg>

```

```

<division>IND</division>
<entityType>BNDL</entityType>
<entityCode>CHECKBUND_003</entityCode>
<processDate>2022-01-11</processDate>
<accountId></accountId>
<acctIdtype></acctIdtype>
<acctIdentifierValue></acctIdentifierValue>
<personId></personId>
<custIdTypeCd></custIdTypeCd>
<perIdentifireVal></perIdentifireVal>
<productLinkedEntity>
  <linkedEntityCode>CHECKMP_001</linkedEntityCode>
  <linkedEntityType>MP</linkedEntityType>
</productLinkedEntity>
<eligibleParameter>
  <priceParmCode>ACC_DIVISION</priceParmCode>
  <priceParmVal>IND</priceParmVal>
</eligibleParameter>
<eligibleParameter>
  <priceParmCode>PERSON_STATE</priceParmCode>
  <priceParmVal>MH</priceParmVal>
</eligibleParameter>
</C1_GETELIGIBLEPROD>

```

Sample Eligible Bundle Response in the XML Format

```

<C1_GETELIGIBLEPROD>
  <productCode>LOAN_001</productCode>
  <productCategoryFlg></productCategoryFlg>
  <division>IND</division>
  <entityType>BNDL</entityType>
  <entityCode>CHECKBUND_003</entityCode>
  <processDate>2022-01-11</processDate>
  <accountId></accountId>
  <acctIdtype></acctIdtype>
  <acctIdentifierValue></acctIdentifierValue>
  <personId></personId>
  <custIdTypeCd></custIdTypeCd>
  <perIdentifireVal></perIdentifireVal>
  <productLinkedEntity>
    <linkedEntityCode>CHECKMP_001</linkedEntityCode>
    <linkedEntityType>MP</linkedEntityType>
  </productLinkedEntity>
  <eligibleParameter>
    <priceParmCode>ACC_DIVISION</priceParmCode>
    <priceParmVal>IND</priceParmVal>
  </eligibleParameter>
  <eligibleParameter>
    <priceParmCode>PERSON_STATE</priceParmCode>
    <priceParmVal>MH</priceParmVal>
  </eligibleParameter>
  <entityList>
    <entityCode>CHECKBUND_003</entityCode>
    <entityType>BNDL</entityType>
    <entityName>CHECKBUND_003</entityName>
    <entityStartDate>2022-01-11</entityStartDate>
    <entityEndDate></entityEndDate>
    <entityCodeDescr></entityCodeDescr>
    <termsAndCondition>TERMSPRAAS</termsAndCondition>
    <termAndConditionDescr>TERMSPRAAS</termAndConditionDescr>
    <status>ACTIVE</status>
  </entityList>
  <productList>
    <productCode>LOAN_001</productCode>
    <productDescription>LOAN_001</productDescription>
  </productList>
</C1_GETELIGIBLEPROD>

```

```

        <productTypFlgDesc>Product</productTypFlgDesc>
        <productCategoryFlgDesc>Loans</productCategoryFlgDesc>
    </productList>
    <productLinkedEntity>
        <linkedEntityStartDate></linkedEntityStartDate>
        <linkedEntityEndDate></linkedEntityEndDate>
        <linkedEntityCode>CHECKMP_001</linkedEntityCode>
        <linkedEntityType>MP</linkedEntityType>
    </productLinkedEntity>
    <productLinkedEntity>
        <linkedEntityStartDate></linkedEntityStartDate>
        <linkedEntityEndDate></linkedEntityEndDate>
        <linkedEntityCode>CHEKCM_002</linkedEntityCode>
        <linkedEntityType>MP</linkedEntityType>
    </productLinkedEntity>
    <EntityDivision>
        <divisionCode>IND</divisionCode>
    </EntityDivision>
    <EntityDivision>
        <divisionCode>MH</divisionCode>
    </EntityDivision>
    <eligibilityDetails>
        <eligibilityStartDate>2022-01-11</eligibilityStartDate>
        <eligibilityEndDate></eligibilityEndDate>
        <eligibilityDescription>LOANDBUND_001</eligibilityDescription>
        <eligibilityRule>
            <sequenceNumber>10</sequenceNumber>
            <lhsPriceParmCd>ACC_DIVISION</lhsPriceParmCd>
            <operator>=</operator>
            <rhsPriceParmCd></rhsPriceParmCd>
            <rhsPriceParmVal>MH</rhsPriceParmVal>
            <lhsPriceParmCd1></lhsPriceParmCd1>
            <rhsPriceParmTypeFlg>VAL</rhsPriceParmTypeFlg>
            <>trueFlag>RLTR</trueFlag>
            <>falseFlag>RLFS</falseFlag>
            <insufficientFlag>RLFS</insufficientFlag>
        </eligibilityRule>
    </eligibilityDetails>
    <services>
        <serviceName>Product Service PRASS1</serviceName>
        <mandatoryFlag>true</mandatoryFlag>
    </services>
    <services>
        <serviceName>Product Service PRASS2</serviceName>
        <mandatoryFlag>true</mandatoryFlag>
    </services>
    <services>
        <serviceName>MH division product service</serviceName>
        <mandatoryFlag>true</mandatoryFlag>
    </services>
    <pricing>
        <priority>1</priority>
        <priceListId>4368251923</priceListId>
        <priceListDescription>Currency_Con_PriceList -1</priceListDescription>
        <priceListStartDate>2022-01-11</priceListStartDate>
        <priceListEndDate>2022-02-10</priceListEndDate>
        <noOfDays>30</noOfDays>
        <priceItemCode>CC_021</priceItemCode>
        <priceitemDescr>CC_21-Account Opening Fee</priceitemDescr>
        <priceAsgnId>4360009281</priceAsgnId>
        <validityFlag></validityFlag>
        <sourceEntityType></sourceEntityType>
        <sourceEntityCode></sourceEntityCode>
        <priceListInfo></priceListInfo>
    </pricing>

```

```

    <priceComponent>
      <priceCompId>4367475002</priceCompId>
      <pricecomptier>
        <priceCompSequenceNo></priceCompSequenceNo>
        <businessObjectDataArea></businessObjectDataArea>
        <priceItemParmGroupId></priceItemParmGroupId>
        <toVal></toVal>
        <fromVal></fromVal>
        <timeOfUse></timeOfUse>
        <priceItemCode></priceItemCode>
        <priceCriteria></priceCriteria>
        <priceCompId></priceCompId>
        <tieSeqNum></tieSeqNum>
        <version></version>
      </pricecomptier>
      <priceComponentDescription>FLAT</priceComponentDescription>
      <valueAmt>0.400000000000000000</valueAmt>
      <priceComponentDisplay>false</priceComponentDisplay>
      <rcMapId></rcMapId>
      <tieredFlag></tieredFlag>
      <priceCompSequenceNo2>0</priceCompSequenceNo2>
    </priceComponent>
  </pricing>
</pricing>
<pricing>
  <priority>1</priority>
  <priceListId>4368251923</priceListId>
  <priceListDescription>Currency_Con_PriceList -1</priceListDescription>
  <priceListStartDate>2022-01-11</priceListStartDate>
  <priceListEndDate>2022-02-10</priceListEndDate>
  <noOfDays>30</noOfDays>
  <priceItemCode>CC_022</priceItemCode>
  <priceitemDescr>CC2-Monthly Acct Serv Fee</priceitemDescr>
  <priceAsgnId>4360009282</priceAsgnId>
  <validityFlag></validityFlag>
  <sourceEntityType></sourceEntityType>
  <sourceEntityCode></sourceEntityCode>
  <priceListInfo></priceListInfo>
  <priceComponent>
    <priceCompId>4367475004</priceCompId>
    <pricecomptier>
      <priceCompSequenceNo></priceCompSequenceNo>
      <businessObjectDataArea></businessObjectDataArea>
      <priceItemParmGroupId></priceItemParmGroupId>
      <toVal></toVal>
      <fromVal></fromVal>
      <timeOfUse></timeOfUse>
      <priceItemCode></priceItemCode>
      <priceCriteria></priceCriteria>
      <priceCompId></priceCompId>
      <tieSeqNum></tieSeqNum>
      <version></version>
    </pricecomptier>
    <priceComponentDescription>FLAT</priceComponentDescription>
    <valueAmt>0.600000000000000000</valueAmt>
    <priceComponentDisplay>false</priceComponentDisplay>
    <rcMapId></rcMapId>
    <tieredFlag></tieredFlag>
    <priceCompSequenceNo2>0</priceCompSequenceNo2>
  </priceComponent>
</pricing>
</pricing>
  <priority>1</priority>
  <priceListId>4368251923</priceListId>
  <priceListDescription>Currency_Con_PriceList -1</priceListDescription>

```

```

<priceListStartDate>2022-01-11</priceListStartDate>
<priceListEndDate>2022-02-10</priceListEndDate>
<noOfDays>30</noOfDays>
<priceItemCode>CC_024</priceItemCode>
<priceitemDescr>CC3-SEPA Transfers</priceitemDescr>
<priceAsgnId>4360009283</priceAsgnId>
<validityFlag></validityFlag>
<sourceEntityType></sourceEntityType>
<sourceEntityCode></sourceEntityCode>
<priceListInfo></priceListInfo>
<priceComponent>
  <priceCompId>4367475006</priceCompId>
  <pricecomptier>
    <priceCompSequenceNo></priceCompSequenceNo>
    <businessObjectDataArea></businessObjectDataArea>
    <priceItemParmGroupId></priceItemParmGroupId>
    <toVal></toVal>
    <fromVal></fromVal>
    <timeOfUse></timeOfUse>
    <priceItemCode></priceItemCode>
    <priceCriteria></priceCriteria>
    <priceCompId></priceCompId>
    <tieSeqNum></tieSeqNum>
    <version></version>
  </pricecomptier>
  <priceComponentDescription>FLAT</priceComponentDescription>
  <valueAmt>0.250000000000000000</valueAmt>
  <priceComponentDisplay>>false</priceComponentDisplay>
  <rcMapId></rcMapId>
  <tieredFlag></tieredFlag>
  <priceCompSequenceNo2>0</priceCompSequenceNo2>
</priceComponent>
</pricing>
<pricing>
  <priority>1</priority>
  <priceListId>4368251923</priceListId>
  <priceListDescription>Currency_Con_PriceList -1</priceListDescription>
  <priceListStartDate>2022-01-11</priceListStartDate>
  <priceListEndDate>2022-02-10</priceListEndDate>
  <noOfDays>30</noOfDays>
  <priceItemCode>CC_025</priceItemCode>
  <priceitemDescr>CC4-Domestic Funds Transfer Fee</priceitemDescr>
  <priceAsgnId>4360009284</priceAsgnId>
  <validityFlag></validityFlag>
  <sourceEntityType></sourceEntityType>
  <sourceEntityCode></sourceEntityCode>
  <priceListInfo></priceListInfo>
  <priceComponent>
    <priceCompId>4367475008</priceCompId>
    <pricecomptier>
      <priceCompSequenceNo></priceCompSequenceNo>
      <businessObjectDataArea></businessObjectDataArea>
      <priceItemParmGroupId></priceItemParmGroupId>
      <toVal></toVal>
      <fromVal></fromVal>
      <timeOfUse></timeOfUse>
      <priceItemCode></priceItemCode>
      <priceCriteria></priceCriteria>
      <priceCompId></priceCompId>
      <tieSeqNum></tieSeqNum>
      <version></version>
    </pricecomptier>
    <priceComponentDescription>FLAT</priceComponentDescription>
    <valueAmt>112.040000000000000000</valueAmt>
  </priceComponent>
</pricing>

```



```

        <priceComponentDisplay>false</priceComponentDisplay>
        <rcMapId></rcMapId>
        <tieredFlag></tieredFlag>
        <priceCompSequenceNo2>0</priceCompSequenceNo2>
    </priceComponent>
</pricing>
<pricing>
    <priority>2</priority>
    <priceListId>5417730766</priceListId>
    <priceListDescription>PriceList -1</priceListDescription>
    <priceListStartDate>2022-01-11</priceListStartDate>
    <priceListEndDate>2022-01-21</priceListEndDate>
    <noOfDays>10</noOfDays>
    <priceItemCode>PI_021</priceItemCode>
    <priceitemDescr>V1-Account Opening Fee</priceitemDescr>
    <priceAsgnId>5410009202</priceAsgnId>
    <validityFlag></validityFlag>
    <sourceEntityType></sourceEntityType>
    <sourceEntityCode></sourceEntityCode>
    <priceListInfo></priceListInfo>
    <priceComponent>
        <priceCompId>5417300004</priceCompId>
        <pricecomptier>
            <priceCompSequenceNo></priceCompSequenceNo>
            <businessObjectDataArea></businessObjectDataArea>
            <priceItemParmGroupId></priceItemParmGroupId>
            <toVal></toVal>
            <fromVal></fromVal>
            <timeOfUse></timeOfUse>
            <priceItemCode></priceItemCode>
            <priceCriteria></priceCriteria>
            <priceCompId></priceCompId>
            <tieSeqNum></tieSeqNum>
            <version></version>
        </pricecomptier>
        <priceComponentDescription>FLAT</priceComponentDescription>
        <valueAmt>0.250000000000000000</valueAmt>
        <priceComponentDisplay>false</priceComponentDisplay>
        <rcMapId></rcMapId>
        <tieredFlag></tieredFlag>
        <priceCompSequenceNo2>0</priceCompSequenceNo2>
    </priceComponent>
</pricing>
<pricing>
    <priority>2</priority>
    <priceListId>5417730766</priceListId>
    <priceListDescription>PriceList -1</priceListDescription>
    <priceListStartDate>2022-01-11</priceListStartDate>
    <priceListEndDate>2022-01-21</priceListEndDate>
    <noOfDays>10</noOfDays>
    <priceItemCode>PI_022</priceItemCode>
    <priceitemDescr>V2-Monthly Acct Serv Fee</priceitemDescr>
    <priceAsgnId>5410009203</priceAsgnId>
    <validityFlag></validityFlag>
    <sourceEntityType></sourceEntityType>
    <sourceEntityCode></sourceEntityCode>
    <priceListInfo></priceListInfo>
    <priceComponent>
        <priceCompId>5417300006</priceCompId>
        <pricecomptier>
            <priceCompSequenceNo></priceCompSequenceNo>
            <businessObjectDataArea></businessObjectDataArea>
            <priceItemParmGroupId></priceItemParmGroupId>
            <toVal></toVal>

```

```

        <fromVal></fromVal>
        <timeOfUse></timeOfUse>
        <priceItemCode></priceItemCode>
        <priceCriteria></priceCriteria>
        <priceCompId></priceCompId>
        <tieSeqNum></tieSeqNum>
        <version></version>
    </pricecomptier>
    <priceComponentDescription>FLAT</priceComponentDescription>
    <valueAmt>112.040000000000000000</valueAmt>
    <priceComponentDisplay>>false</priceComponentDisplay>
    <rcMapId></rcMapId>
    <tieredFlag></tieredFlag>
    <priceCompSequenceNo2>0</priceCompSequenceNo2>
</priceComponent>
</pricing>
<pricing>
    <priority>2</priority>
    <priceListId>5417730766</priceListId>
    <priceListDescription>PriceList -1</priceListDescription>
    <priceListStartDate>2022-01-11</priceListStartDate>
    <priceListEndDate>2022-01-21</priceListEndDate>
    <noOfDays>10</noOfDays>
    <priceItemCode>PI_023</priceItemCode>
    <priceitemDescr>V3-Audit Reports</priceitemDescr>
    <priceAsgnId>5410009204</priceAsgnId>
    <validityFlag></validityFlag>
    <sourceEntityType></sourceEntityType>
    <sourceEntityCode></sourceEntityCode>
    <priceListInfo></priceListInfo>
    <priceComponent>
        <priceCompId>5417300008</priceCompId>
        <pricecomptier>
            <priceCompSequenceNo></priceCompSequenceNo>
            <businessObjectDataArea></businessObjectDataArea>
            <priceItemParmGroupId></priceItemParmGroupId>
            <toVal></toVal>
            <fromVal></fromVal>
            <timeOfUse></timeOfUse>
            <priceItemCode></priceItemCode>
            <priceCriteria></priceCriteria>
            <priceCompId></priceCompId>
            <tieSeqNum></tieSeqNum>
            <version></version>
        </pricecomptier>
        <priceComponentDescription>FLAT</priceComponentDescription>
        <valueAmt>276.250000000000000000</valueAmt>
        <priceComponentDisplay>>false</priceComponentDisplay>
        <rcMapId></rcMapId>
        <tieredFlag></tieredFlag>
        <priceCompSequenceNo2>0</priceCompSequenceNo2>
    </priceComponent>
</pricing>
<pricing>
    <priority>2</priority>
    <priceListId>5417730766</priceListId>
    <priceListDescription>PriceList -1</priceListDescription>
    <priceListStartDate>2022-01-11</priceListStartDate>
    <priceListEndDate>2022-01-21</priceListEndDate>
    <noOfDays>10</noOfDays>
    <priceItemCode>PI_024</priceItemCode>
    <priceitemDescr>V4-SEPA Transfers</priceitemDescr>
    <priceAsgnId>5410009241</priceAsgnId>
    <validityFlag></validityFlag>

```

```

<sourceEntityType></sourceEntityType>
<sourceEntityCode></sourceEntityCode>
<priceListInfo></priceListInfo>
<priceComponent>
  <priceCompId>5417400004</priceCompId>
  <pricecomptier>
    <priceCompSequenceNo>0</priceCompSequenceNo>
    <businessObjectDataArea></businessObjectDataArea>
    <priceItemParmGroupId>1</priceItemParmGroupId>
    <toVal>1000.000000000000000000</toVal>
    <fromVal>0.000000000000000000</fromVal>
    <timeOfUse></timeOfUse>
    <priceItemCode>PI_024</priceItemCode>
    <priceCriteria>NBRTRAN</priceCriteria>
    <priceCompId></priceCompId>
    <tieSeqNum>10</tieSeqNum>
    <version>0</version>
  </pricecomptier>
  <pricecomptier>
    <priceCompSequenceNo>0</priceCompSequenceNo>
    <businessObjectDataArea></businessObjectDataArea>
    <priceItemParmGroupId>1</priceItemParmGroupId>
    <toVal>5000.000000000000000000</toVal>
    <fromVal>1000.000000000000000000</fromVal>
    <timeOfUse></timeOfUse>
    <priceItemCode>PI_024</priceItemCode>
    <priceCriteria>NBRTRAN</priceCriteria>
    <priceCompId></priceCompId>
    <tieSeqNum>10</tieSeqNum>
    <version>0</version>
  </pricecomptier>
  <pricecomptier>
    <priceCompSequenceNo>0</priceCompSequenceNo>
    <businessObjectDataArea></businessObjectDataArea>
    <priceItemParmGroupId>1</priceItemParmGroupId>
    <toVal>99999999999.990000000000000000</toVal>
    <fromVal>5000.000000000000000000</fromVal>
    <timeOfUse></timeOfUse>
    <priceItemCode>PI_024</priceItemCode>
    <priceCriteria>NBRTRAN</priceCriteria>
    <priceCompId></priceCompId>
    <tieSeqNum>10</tieSeqNum>
    <version>0</version>
  </pricecomptier>
  <priceComponentDescription>Price per transaction - Step Tier
1</priceComponentDescription>
  <valueAmt>12.950000000000000000</valueAmt>
  <priceComponentDisplay>false</priceComponentDisplay>
  <rcMapId></rcMapId>
  <tieredFlag></tieredFlag>
  <priceCompSequenceNo2>0</priceCompSequenceNo2>
</priceComponent>
<priceComponent>
  <priceCompId>5417400005</priceCompId>
  <pricecomptier>
    <priceCompSequenceNo>0</priceCompSequenceNo>
    <businessObjectDataArea></businessObjectDataArea>
    <priceItemParmGroupId>1</priceItemParmGroupId>
    <toVal>1000.000000000000000000</toVal>
    <fromVal>0.000000000000000000</fromVal>
    <timeOfUse></timeOfUse>
    <priceItemCode>PI_024</priceItemCode>
    <priceCriteria>NBRTRAN</priceCriteria>
    <priceCompId></priceCompId>

```

```

        <tieSeqNum>10</tieSeqNum>
        <version>0</version>
    </pricecomptier>
    <pricecomptier>
        <priceCompSequenceNo>0</priceCompSequenceNo>
        <businessObjectDataArea></businessObjectDataArea>
        <priceItemParmGroupId>1</priceItemParmGroupId>
        <toVal>5000.00000000000000000000</toVal>
        <fromVal>1000.00000000000000000000</fromVal>
        <timeOfUse></timeOfUse>
        <priceItemCode>PI_024</priceItemCode>
        <priceCriteria>NBRTRAN</priceCriteria>
        <priceCompId></priceCompId>
        <tieSeqNum>10</tieSeqNum>
        <version>0</version>
    </pricecomptier>
    <pricecomptier>
        <priceCompSequenceNo>0</priceCompSequenceNo>
        <businessObjectDataArea></businessObjectDataArea>
        <priceItemParmGroupId>1</priceItemParmGroupId>
        <toVal>9999999999999999.99000000000000000000</toVal>
        <fromVal>5000.00000000000000000000</fromVal>
        <timeOfUse></timeOfUse>
        <priceItemCode>PI_024</priceItemCode>
        <priceCriteria>NBRTRAN</priceCriteria>
        <priceCompId></priceCompId>
        <tieSeqNum>10</tieSeqNum>
        <version>0</version>
    </pricecomptier>
    <priceComponentDescription>Price per transaction - Step Tier
2</priceComponentDescription>
    <valueAmt>12.15000000000000000000</valueAmt>
    <priceComponentDisplay>false</priceComponentDisplay>
    <rcMapId></rcMapId>
    <tieredFlag></tieredFlag>
    <priceCompSequenceNo2>0</priceCompSequenceNo2>
</priceComponent>
<priceComponent>
    <priceCompId>5417400006</priceCompId>
    <pricecomptier>
        <priceCompSequenceNo>0</priceCompSequenceNo>
        <businessObjectDataArea></businessObjectDataArea>
        <priceItemParmGroupId>1</priceItemParmGroupId>
        <toVal>1000.00000000000000000000</toVal>
        <fromVal>0.00000000000000000000</fromVal>
        <timeOfUse></timeOfUse>
        <priceItemCode>PI_024</priceItemCode>
        <priceCriteria>NBRTRAN</priceCriteria>
        <priceCompId></priceCompId>
        <tieSeqNum>10</tieSeqNum>
        <version>0</version>
    </pricecomptier>
    <pricecomptier>
        <priceCompSequenceNo>0</priceCompSequenceNo>
        <businessObjectDataArea></businessObjectDataArea>
        <priceItemParmGroupId>1</priceItemParmGroupId>
        <toVal>5000.00000000000000000000</toVal>
        <fromVal>1000.00000000000000000000</fromVal>
        <timeOfUse></timeOfUse>
        <priceItemCode>PI_024</priceItemCode>
        <priceCriteria>NBRTRAN</priceCriteria>
        <priceCompId></priceCompId>
        <tieSeqNum>10</tieSeqNum>
        <version>0</version>

```

```

    </pricecomptier>
    <pricecomptier>
      <priceCompSequenceNo>0</priceCompSequenceNo>
      <businessObjectDataArea></businessObjectDataArea>
      <priceItemParmGroupId>1</priceItemParmGroupId>
      <toVal>999999999999.9900000000000000000</toVal>
      <fromVal>5000.0000000000000000000</fromVal>
      <timeOfUse></timeOfUse>
      <priceItemCode>PI_024</priceItemCode>
      <priceCriteria>NBRTRAN</priceCriteria>
      <priceCompId></priceCompId>
      <tieSeqNum>10</tieSeqNum>
      <version>0</version>
    </pricecomptier>
    <priceComponentDescription>Price per transaction - Step Tier
3</priceComponentDescription>
    <valueAmt>11.9500000000000000000</valueAmt>
    <priceComponentDisplay>false</priceComponentDisplay>
    <rcMapId></rcMapId>
    <tieredFlag></tieredFlag>
    <priceCompSequenceNo2>0</priceCompSequenceNo2>
  </priceComponent>
</pricing>
<pricing>
  <priority>2</priority>
  <priceListId>5417730766</priceListId>
  <priceListDescription>PriceList -1</priceListDescription>
  <priceListStartDate>2022-01-11</priceListStartDate>
  <priceListEndDate>2022-01-21</priceListEndDate>
  <noOfDays>10</noOfDays>
  <priceItemCode>PI_025</priceItemCode>
  <priceitemDescr>V5-Domestic Funds Transfer Fee</priceitemDescr>
  <priceAsgnId>5410009242</priceAsgnId>
  <validityFlag></validityFlag>
  <sourceEntityType></sourceEntityType>
  <sourceEntityCode></sourceEntityCode>
  <priceListInfo></priceListInfo>
  <priceComponent>
    <priceCompId>5417400010</priceCompId>
    <pricecomptier>
      <priceCompSequenceNo>0</priceCompSequenceNo>
      <businessObjectDataArea></businessObjectDataArea>
      <priceItemParmGroupId>1</priceItemParmGroupId>
      <toVal>1000.0000000000000000000</toVal>
      <fromVal>0.0000000000000000000</fromVal>
      <timeOfUse></timeOfUse>
      <priceItemCode>PI_025</priceItemCode>
      <priceCriteria>NBRTRAN</priceCriteria>
      <priceCompId></priceCompId>
      <tieSeqNum>10</tieSeqNum>
      <version>0</version>
    </pricecomptier>
    <pricecomptier>
      <priceCompSequenceNo>0</priceCompSequenceNo>
      <businessObjectDataArea></businessObjectDataArea>
      <priceItemParmGroupId>1</priceItemParmGroupId>
      <toVal>5000.0000000000000000000</toVal>
      <fromVal>1000.0000000000000000000</fromVal>
      <timeOfUse></timeOfUse>
      <priceItemCode>PI_025</priceItemCode>
      <priceCriteria>NBRTRAN</priceCriteria>
      <priceCompId></priceCompId>
      <tieSeqNum>10</tieSeqNum>
      <version>0</version>
    </pricecomptier>
  </priceComponent>
</pricing>

```

```

    </pricecomptier>
    <pricecomptier>
      <priceCompSequenceNo>0</priceCompSequenceNo>
      <businessObjectDataArea></businessObjectDataArea>
      <priceItemParmGroupId>1</priceItemParmGroupId>
      <toVal>999999999999.9900000000000000000</toVal>
      <fromVal>5000.0000000000000000000</fromVal>
      <timeOfUse></timeOfUse>
      <priceItemCode>PI_025</priceItemCode>
      <priceCriteria>NBRTRAN</priceCriteria>
      <priceCompId></priceCompId>
      <tieSeqNum>10</tieSeqNum>
      <version>0</version>
    </pricecomptier>
    <priceComponentDescription>Threshold price per transaction</
priceComponentDescription>
    <valueAmt>12.9500000000000000000</valueAmt>
    <priceComponentDisplay>false</priceComponentDisplay>
    <rcMapId></rcMapId>
    <tieredFlag></tieredFlag>
    <priceCompSequenceNo2>0</priceCompSequenceNo2>
  </priceComponent>
  <priceComponent>
    <priceCompId>5417400011</priceCompId>
    <pricecomptier>
      <priceCompSequenceNo>0</priceCompSequenceNo>
      <businessObjectDataArea></businessObjectDataArea>
      <priceItemParmGroupId>1</priceItemParmGroupId>
      <toVal>1000.0000000000000000000</toVal>
      <fromVal>0.0000000000000000000</fromVal>
      <timeOfUse></timeOfUse>
      <priceItemCode>PI_025</priceItemCode>
      <priceCriteria>NBRTRAN</priceCriteria>
      <priceCompId></priceCompId>
      <tieSeqNum>10</tieSeqNum>
      <version>0</version>
    </pricecomptier>
    <pricecomptier>
      <priceCompSequenceNo>0</priceCompSequenceNo>
      <businessObjectDataArea></businessObjectDataArea>
      <priceItemParmGroupId>1</priceItemParmGroupId>
      <toVal>5000.0000000000000000000</toVal>
      <fromVal>1000.0000000000000000000</fromVal>
      <timeOfUse></timeOfUse>
      <priceItemCode>PI_025</priceItemCode>
      <priceCriteria>NBRTRAN</priceCriteria>
      <priceCompId></priceCompId>
      <tieSeqNum>10</tieSeqNum>
      <version>0</version>
    </pricecomptier>
    <pricecomptier>
      <priceCompSequenceNo>0</priceCompSequenceNo>
      <businessObjectDataArea></businessObjectDataArea>
      <priceItemParmGroupId>1</priceItemParmGroupId>
      <toVal>999999999999.9900000000000000000</toVal>
      <fromVal>5000.0000000000000000000</fromVal>
      <timeOfUse></timeOfUse>
      <priceItemCode>PI_025</priceItemCode>
      <priceCriteria>NBRTRAN</priceCriteria>
      <priceCompId></priceCompId>
      <tieSeqNum>10</tieSeqNum>
      <version>0</version>
    </pricecomptier>
  </priceComponent>

```

```

        <priceComponentDescription>Threshold price per transaction</
priceComponentDescription>
        <valueAmt>12.150000000000000000</valueAmt>
        <priceComponentDisplay>>false</priceComponentDisplay>
        <rcMapId></rcMapId>
        <tieredFlag></tieredFlag>
        <priceCompSequenceNo2>0</priceCompSequenceNo2>
    </priceComponent>
</priceComponent>
    <priceCompId>5417400012</priceCompId>
    <pricecomptier>
        <priceCompSequenceNo>0</priceCompSequenceNo>
        <businessObjectDataArea></businessObjectDataArea>
        <priceItemParmGroupId>1</priceItemParmGroupId>
        <toVal>1000.000000000000000000</toVal>
        <fromVal>0.000000000000000000</fromVal>
        <timeOfUse></timeOfUse>
        <priceItemCode>PI_025</priceItemCode>
        <priceCriteria>NBRTRAN</priceCriteria>
        <priceCompId></priceCompId>
        <tieSeqNum>10</tieSeqNum>
        <version>0</version>
    </pricecomptier>
</pricecomptier>
    <pricecomptier>
        <priceCompSequenceNo>0</priceCompSequenceNo>
        <businessObjectDataArea></businessObjectDataArea>
        <priceItemParmGroupId>1</priceItemParmGroupId>
        <toVal>5000.000000000000000000</toVal>
        <fromVal>1000.000000000000000000</fromVal>
        <timeOfUse></timeOfUse>
        <priceItemCode>PI_025</priceItemCode>
        <priceCriteria>NBRTRAN</priceCriteria>
        <priceCompId></priceCompId>
        <tieSeqNum>10</tieSeqNum>
        <version>0</version>
    </pricecomptier>
</pricecomptier>
    <pricecomptier>
        <priceCompSequenceNo>0</priceCompSequenceNo>
        <businessObjectDataArea></businessObjectDataArea>
        <priceItemParmGroupId>1</priceItemParmGroupId>
        <toVal>99999999999.990000000000000000</toVal>
        <fromVal>5000.000000000000000000</fromVal>
        <timeOfUse></timeOfUse>
        <priceItemCode>PI_025</priceItemCode>
        <priceCriteria>NBRTRAN</priceCriteria>
        <priceCompId></priceCompId>
        <tieSeqNum>10</tieSeqNum>
        <version>0</version>
    </pricecomptier>
        <priceComponentDescription>Threshold price per transaction</
priceComponentDescription>
        <valueAmt>11.950000000000000000</valueAmt>
        <priceComponentDisplay>>false</priceComponentDisplay>
        <rcMapId></rcMapId>
        <tieredFlag></tieredFlag>
        <priceCompSequenceNo2>0</priceCompSequenceNo2>
    </priceComponent>
</pricing>
<pricing>
    <priority>2</priority>
    <priceListId>5417730766</priceListId>
    <priceListDescription>PriceList -1</priceListDescription>
    <priceListStartDate>2022-01-11</priceListStartDate>
    <priceListEndDate>2022-01-21</priceListEndDate>

```

```

<noOfDays>10</noOfDays>
<priceItemCode>PI_026</priceItemCode>
<priceitemDescr>V6-Electronic Credits</priceitemDescr>
<priceAsgnId>5410009243</priceAsgnId>
<validityFlag></validityFlag>
<sourceEntityType></sourceEntityType>
<sourceEntityCode></sourceEntityCode>
<priceListInfo></priceListInfo>
<priceComponent>
  <priceCompId>5417400020</priceCompId>
  <pricecomptier>
    <priceCompSequenceNo>0</priceCompSequenceNo>
    <businessObjectDataArea></businessObjectDataArea>
    <priceItemParmGroupId>1</priceItemParmGroupId>
    <toVal>1000.000000000000000000</toVal>
    <fromVal>0.000000000000000000</fromVal>
    <timeOfUse></timeOfUse>
    <priceItemCode>PI_026</priceItemCode>
    <priceCriteria>NBRTRAN</priceCriteria>
    <priceCompId></priceCompId>
    <tieSeqNum>10</tieSeqNum>
    <version>0</version>
  </pricecomptier>
  <pricecomptier>
    <priceCompSequenceNo>0</priceCompSequenceNo>
    <businessObjectDataArea></businessObjectDataArea>
    <priceItemParmGroupId>1</priceItemParmGroupId>
    <toVal>5000.000000000000000000</toVal>
    <fromVal>1000.000000000000000000</fromVal>
    <timeOfUse></timeOfUse>
    <priceItemCode>PI_026</priceItemCode>
    <priceCriteria>NBRTRAN</priceCriteria>
    <priceCompId></priceCompId>
    <tieSeqNum>10</tieSeqNum>
    <version>0</version>
  </pricecomptier>
  <pricecomptier>
    <priceCompSequenceNo>0</priceCompSequenceNo>
    <businessObjectDataArea></businessObjectDataArea>
    <priceItemParmGroupId>1</priceItemParmGroupId>
    <toVal>99999999999.990000000000000000</toVal>
    <fromVal>5000.000000000000000000</fromVal>
    <timeOfUse></timeOfUse>
    <priceItemCode>PI_026</priceItemCode>
    <priceCriteria>NBRTRAN</priceCriteria>
    <priceCompId></priceCompId>
    <tieSeqNum>10</tieSeqNum>
    <version>0</version>
  </pricecomptier>
  <pricecomptier>
    <priceCompSequenceNo>0</priceCompSequenceNo>
    <businessObjectDataArea></businessObjectDataArea>
    <priceItemParmGroupId>1</priceItemParmGroupId>
    <toVal>1000.000000000000000000</toVal>
    <fromVal>0.000000000000000000</fromVal>
    <timeOfUse></timeOfUse>
    <priceItemCode>PI_026</priceItemCode>
    <priceCriteria>NBRTRAN</priceCriteria>
    <priceCompId></priceCompId>
    <tieSeqNum>10</tieSeqNum>
    <version>0</version>
  </pricecomptier>
  <pricecomptier>
    <priceCompSequenceNo>0</priceCompSequenceNo>

```



```

    <businessObjectDataArea></businessObjectDataArea>
    <priceItemParmGroupId>1</priceItemParmGroupId>
    <toVal>5000.00000000000000000000</toVal>
    <fromVal>1000.00000000000000000000</fromVal>
    <timeOfUse></timeOfUse>
    <priceItemCode>PI_026</priceItemCode>
    <priceCriteria>NBRTRAN</priceCriteria>
    <priceCompId></priceCompId>
    <tieSeqNum>10</tieSeqNum>
    <version>0</version>
  </pricecomptier>
  <pricecomptier>
    <priceCompSequenceNo>0</priceCompSequenceNo>
    <businessObjectDataArea></businessObjectDataArea>
    <priceItemParmGroupId>1</priceItemParmGroupId>
    <toVal>999999999999.99000000000000000000</toVal>
    <fromVal>5000.00000000000000000000</fromVal>
    <timeOfUse></timeOfUse>
    <priceItemCode>PI_026</priceItemCode>
    <priceCriteria>NBRTRAN</priceCriteria>
    <priceCompId></priceCompId>
    <tieSeqNum>10</tieSeqNum>
    <version>0</version>
  </pricecomptier>
<priceComponentDescription>Basic charges</priceComponentDescription>
  <valueAmt>20.00000000000000000000</valueAmt>
  <priceComponentDisplay>false</priceComponentDisplay>
  <rcMapId></rcMapId>
  <tieredFlag></tieredFlag>
  <priceCompSequenceNo2>0</priceCompSequenceNo2>
</priceComponent>
<priceComponent>
  <priceCompId>5417400021</priceCompId>
  <pricecomptier>
    <priceCompSequenceNo>0</priceCompSequenceNo>
    <businessObjectDataArea></businessObjectDataArea>
    <priceItemParmGroupId>1</priceItemParmGroupId>
    <toVal>1000.00000000000000000000</toVal>
    <fromVal>0.00000000000000000000</fromVal>
    <timeOfUse></timeOfUse>
    <priceItemCode>PI_026</priceItemCode>
    <priceCriteria>NBRTRAN</priceCriteria>
    <priceCompId></priceCompId>
    <tieSeqNum>10</tieSeqNum>
    <version>0</version>
  </pricecomptier>
  <pricecomptier>
    <priceCompSequenceNo>0</priceCompSequenceNo>
    <businessObjectDataArea></businessObjectDataArea>
    <priceItemParmGroupId>1</priceItemParmGroupId>
    <toVal>5000.00000000000000000000</toVal>
    <fromVal>1000.00000000000000000000</fromVal>
    <timeOfUse></timeOfUse>
    <priceItemCode>PI_026</priceItemCode>
    <priceCriteria>NBRTRAN</priceCriteria>
    <priceCompId></priceCompId>
    <tieSeqNum>10</tieSeqNum>
    <version>0</version>
  </pricecomptier>
  <pricecomptier>
    <priceCompSequenceNo>0</priceCompSequenceNo>
    <businessObjectDataArea></businessObjectDataArea>
    <priceItemParmGroupId>1</priceItemParmGroupId>
    <toVal>999999999999.99000000000000000000</toVal>

```

```

        <fromVal>5000.00000000000000000000</fromVal>
        <timeOfUse></timeOfUse>
        <priceItemCode>PI_026</priceItemCode>
        <priceCriteria>NBRTRAN</priceCriteria>
        <priceCompId></priceCompId>
        <tieSeqNum>10</tieSeqNum>
        <version>0</version>
    </pricecomptier>
    <pricecomptier>
        <priceCompSequenceNo>0</priceCompSequenceNo>
        <businessObjectDataArea></businessObjectDataArea>
        <priceItemParmGroupId>1</priceItemParmGroupId>
        <toVal>1000.00000000000000000000</toVal>
        <fromVal>0.00000000000000000000</fromVal>
        <timeOfUse></timeOfUse>
        <priceItemCode>PI_026</priceItemCode>
        <priceCriteria>NBRTRAN</priceCriteria>
        <priceCompId></priceCompId>
        <tieSeqNum>10</tieSeqNum>
        <version>0</version>
    </pricecomptier>
    <pricecomptier>
        <priceCompSequenceNo>0</priceCompSequenceNo>
        <businessObjectDataArea></businessObjectDataArea>
        <priceItemParmGroupId>1</priceItemParmGroupId>
        <toVal>5000.00000000000000000000</toVal>
        <fromVal>1000.00000000000000000000</fromVal>
        <timeOfUse></timeOfUse>
        <priceItemCode>PI_026</priceItemCode>
        <priceCriteria>NBRTRAN</priceCriteria>
        <priceCompId></priceCompId>
        <tieSeqNum>10</tieSeqNum>
        <version>0</version>
    </pricecomptier>
    <pricecomptier>
        <priceCompSequenceNo>0</priceCompSequenceNo>
        <businessObjectDataArea></businessObjectDataArea>
        <priceItemParmGroupId>1</priceItemParmGroupId>
        <toVal>999999999999.99000000000000000000</toVal>
        <fromVal>5000.00000000000000000000</fromVal>
        <timeOfUse></timeOfUse>
        <priceItemCode>PI_026</priceItemCode>
        <priceCriteria>NBRTRAN</priceCriteria>
        <priceCompId></priceCompId>
        <tieSeqNum>10</tieSeqNum>
        <version>0</version>
    </pricecomptier>
    <priceComponentDescription>Threshold price</
priceComponentDescription>
    <valueAmt>10.00000000000000000000</valueAmt>
    <priceComponentDisplay>false</priceComponentDisplay>
    <rcMapId></rcMapId>
    <tieredFlag></tieredFlag>
    <priceCompSequenceNo2>0</priceCompSequenceNo2>
</priceComponent>
<priceComponent>
    <priceCompId>5417400022</priceCompId>
    <pricecomptier>
        <priceCompSequenceNo>0</priceCompSequenceNo>
        <businessObjectDataArea></businessObjectDataArea>
        <priceItemParmGroupId>1</priceItemParmGroupId>
        <toVal>1000.00000000000000000000</toVal>
        <fromVal>0.00000000000000000000</fromVal>
        <timeOfUse></timeOfUse>

```

```

    <priceItemCode>PI_026</priceItemCode>
    <priceCriteria>NBRTRAN</priceCriteria>
    <priceCompId></priceCompId>
    <tieSeqNum>10</tieSeqNum>
    <version>0</version>
  </pricecomptier>
</pricecomptier>
  <priceCompSequenceNo>0</priceCompSequenceNo>
  <businessObjectDataArea></businessObjectDataArea>
  <priceItemParmGroupId>1</priceItemParmGroupId>
  <toVal>5000.00000000000000000000</toVal>
  <fromVal>1000.00000000000000000000</fromVal>
  <timeOfUse></timeOfUse>
  <priceItemCode>PI_026</priceItemCode>
  <priceCriteria>NBRTRAN</priceCriteria>
  <priceCompId></priceCompId>
  <tieSeqNum>10</tieSeqNum>
  <version>0</version>
</pricecomptier>
</pricecomptier>
  <priceCompSequenceNo>0</priceCompSequenceNo>
  <businessObjectDataArea></businessObjectDataArea>
  <priceItemParmGroupId>1</priceItemParmGroupId>
  <toVal>99999999999.99000000000000000000</toVal>
  <fromVal>5000.00000000000000000000</fromVal>
  <timeOfUse></timeOfUse>
  <priceItemCode>PI_026</priceItemCode>
  <priceCriteria>NBRTRAN</priceCriteria>
  <priceCompId></priceCompId>
  <tieSeqNum>10</tieSeqNum>
  <version>0</version>
</pricecomptier>
</pricecomptier>
  <priceCompSequenceNo>0</priceCompSequenceNo>
  <businessObjectDataArea></businessObjectDataArea>
  <priceItemParmGroupId>1</priceItemParmGroupId>
  <toVal>1000.00000000000000000000</toVal>
  <fromVal>0.00000000000000000000</fromVal>
  <timeOfUse></timeOfUse>
  <priceItemCode>PI_026</priceItemCode>
  <priceCriteria>NBRTRAN</priceCriteria>
  <priceCompId></priceCompId>
  <tieSeqNum>10</tieSeqNum>
  <version>0</version>
</pricecomptier>
</pricecomptier>
  <priceCompSequenceNo>0</priceCompSequenceNo>
  <businessObjectDataArea></businessObjectDataArea>
  <priceItemParmGroupId>1</priceItemParmGroupId>
  <toVal>5000.00000000000000000000</toVal>
  <fromVal>1000.00000000000000000000</fromVal>
  <timeOfUse></timeOfUse>
  <priceItemCode>PI_026</priceItemCode>
  <priceCriteria>NBRTRAN</priceCriteria>
  <priceCompId></priceCompId>
  <tieSeqNum>10</tieSeqNum>
  <version>0</version>
</pricecomptier>
</pricecomptier>
  <priceCompSequenceNo>0</priceCompSequenceNo>
  <businessObjectDataArea></businessObjectDataArea>
  <priceItemParmGroupId>1</priceItemParmGroupId>
  <toVal>99999999999.99000000000000000000</toVal>
  <fromVal>5000.00000000000000000000</fromVal>

```

```

        <timeOfUse></timeOfUse>
        <priceItemCode>PI_026</priceItemCode>
        <priceCriteria>NBRTRAN</priceCriteria>
        <priceCompId></priceCompId>
        <tieSeqNum>10</tieSeqNum>
        <version>0</version>
    </pricecomptier>
    <priceComponentDescription>Threshold price</
priceComponentDescription>
    <valueAmt>8.0000000000000000</valueAmt>
    <priceComponentDisplay>>false</priceComponentDisplay>
    <rcMapId></rcMapId>
    <tieredFlag></tieredFlag>
    <priceCompSequenceNo2>0</priceCompSequenceNo2>
</priceComponent>
<priceComponent>
    <priceCompId>5417400023</priceCompId>
    <pricecomptier>
        <priceCompSequenceNo>0</priceCompSequenceNo>
        <businessObjectDataArea></businessObjectDataArea>
        <priceItemParmGroupId>1</priceItemParmGroupId>
        <toVal>1000.0000000000000000</toVal>
        <fromVal>0.0000000000000000</fromVal>
        <timeOfUse></timeOfUse>
        <priceItemCode>PI_026</priceItemCode>
        <priceCriteria>NBRTRAN</priceCriteria>
        <priceCompId></priceCompId>
        <tieSeqNum>10</tieSeqNum>
        <version>0</version>
    </pricecomptier>
    <pricecomptier>
        <priceCompSequenceNo>0</priceCompSequenceNo>
        <businessObjectDataArea></businessObjectDataArea>
        <priceItemParmGroupId>1</priceItemParmGroupId>
        <toVal>5000.0000000000000000</toVal>
        <fromVal>1000.0000000000000000</fromVal>
        <timeOfUse></timeOfUse>
        <priceItemCode>PI_026</priceItemCode>
        <priceCriteria>NBRTRAN</priceCriteria>
        <priceCompId></priceCompId>
        <tieSeqNum>10</tieSeqNum>
        <version>0</version>
    </pricecomptier>
    <pricecomptier>
        <priceCompSequenceNo>0</priceCompSequenceNo>
        <businessObjectDataArea></businessObjectDataArea>
        <priceItemParmGroupId>1</priceItemParmGroupId>
        <toVal>999999999999.9900000000000000</toVal>
        <fromVal>5000.0000000000000000</fromVal>
        <timeOfUse></timeOfUse>
        <priceItemCode>PI_026</priceItemCode>
        <priceCriteria>NBRTRAN</priceCriteria>
        <priceCompId></priceCompId>
        <tieSeqNum>10</tieSeqNum>
        <version>0</version>
    </pricecomptier>
    <pricecomptier>
        <priceCompSequenceNo>0</priceCompSequenceNo>
        <businessObjectDataArea></businessObjectDataArea>
        <priceItemParmGroupId>1</priceItemParmGroupId>
        <toVal>1000.0000000000000000</toVal>
        <fromVal>0.0000000000000000</fromVal>
        <timeOfUse></timeOfUse>
        <priceItemCode>PI_026</priceItemCode>

```

```

        <priceCriteria>NBRTRAN</priceCriteria>
        <priceCompId></priceCompId>
        <tieSeqNum>10</tieSeqNum>
        <version>0</version>
    </pricecomptier>
    <pricecomptier>
        <priceCompSequenceNo>0</priceCompSequenceNo>
        <businessObjectDataArea></businessObjectDataArea>
        <priceItemParmGroupId>1</priceItemParmGroupId>
        <toVal>5000.000000000000000000</toVal>
        <fromVal>1000.000000000000000000</fromVal>
        <timeOfUse></timeOfUse>
        <priceItemCode>PI_026</priceItemCode>
        <priceCriteria>NBRTRAN</priceCriteria>
        <priceCompId></priceCompId>
        <tieSeqNum>10</tieSeqNum>
        <version>0</version>
    </pricecomptier>
    <pricecomptier>
        <priceCompSequenceNo>0</priceCompSequenceNo>
        <businessObjectDataArea></businessObjectDataArea>
        <priceItemParmGroupId>1</priceItemParmGroupId>
        <toVal>99999999999.990000000000000000</toVal>
        <fromVal>5000.000000000000000000</fromVal>
        <timeOfUse></timeOfUse>
        <priceItemCode>PI_026</priceItemCode>
        <priceCriteria>NBRTRAN</priceCriteria>
        <priceCompId></priceCompId>
        <tieSeqNum>10</tieSeqNum>
        <version>0</version>
    </pricecomptier>
    <priceComponentDescription>Threshold price</
priceComponentDescription>
    <valueAmt>6.000000000000000000</valueAmt>
    <priceComponentDisplay>false</priceComponentDisplay>
    <rcMapId></rcMapId>
    <tieredFlag></tieredFlag>
    <priceCompSequenceNo2>0</priceCompSequenceNo2>
</priceComponent>
<priceComponent>
    <priceCompId>5417400024</priceCompId>
    <pricecomptier>
        <priceCompSequenceNo>0</priceCompSequenceNo>
        <businessObjectDataArea></businessObjectDataArea>
        <priceItemParmGroupId>1</priceItemParmGroupId>
        <toVal>1000.000000000000000000</toVal>
        <fromVal>0.000000000000000000</fromVal>
        <timeOfUse></timeOfUse>
        <priceItemCode>PI_026</priceItemCode>
        <priceCriteria>NBRTRAN</priceCriteria>
        <priceCompId></priceCompId>
        <tieSeqNum>10</tieSeqNum>
        <version>0</version>
    </pricecomptier>
    <pricecomptier>
        <priceCompSequenceNo>0</priceCompSequenceNo>
        <businessObjectDataArea></businessObjectDataArea>
        <priceItemParmGroupId>1</priceItemParmGroupId>
        <toVal>5000.000000000000000000</toVal>
        <fromVal>1000.000000000000000000</fromVal>
        <timeOfUse></timeOfUse>
        <priceItemCode>PI_026</priceItemCode>
        <priceCriteria>NBRTRAN</priceCriteria>
        <priceCompId></priceCompId>

```

```

        <tieSeqNum>10</tieSeqNum>
        <version>0</version>
    </pricecomptier>
    <pricecomptier>
        <priceCompSequenceNo>0</priceCompSequenceNo>
        <businessObjectDataArea></businessObjectDataArea>
        <priceItemParmGroupId>1</priceItemParmGroupId>
        <toVal>999999999999.9900000000000000000</toVal>
        <fromVal>5000.0000000000000000000</fromVal>
        <timeOfUse></timeOfUse>
        <priceItemCode>PI_026</priceItemCode>
        <priceCriteria>NBRTRAN</priceCriteria>
        <priceCompId></priceCompId>
        <tieSeqNum>10</tieSeqNum>
        <version>0</version>
    </pricecomptier>
    <pricecomptier>
        <priceCompSequenceNo>0</priceCompSequenceNo>
        <businessObjectDataArea></businessObjectDataArea>
        <priceItemParmGroupId>1</priceItemParmGroupId>
        <toVal>1000.0000000000000000000</toVal>
        <fromVal>0.0000000000000000000</fromVal>
        <timeOfUse></timeOfUse>
        <priceItemCode>PI_026</priceItemCode>
        <priceCriteria>NBRTRAN</priceCriteria>
        <priceCompId></priceCompId>
        <tieSeqNum>10</tieSeqNum>
        <version>0</version>
    </pricecomptier>
    <pricecomptier>
        <priceCompSequenceNo>0</priceCompSequenceNo>
        <businessObjectDataArea></businessObjectDataArea>
        <priceItemParmGroupId>1</priceItemParmGroupId>
        <toVal>5000.0000000000000000000</toVal>
        <fromVal>1000.0000000000000000000</fromVal>
        <timeOfUse></timeOfUse>
        <priceItemCode>PI_026</priceItemCode>
        <priceCriteria>NBRTRAN</priceCriteria>
        <priceCompId></priceCompId>
        <tieSeqNum>10</tieSeqNum>
        <version>0</version>
    </pricecomptier>
    <pricecomptier>
        <priceCompSequenceNo>0</priceCompSequenceNo>
        <businessObjectDataArea></businessObjectDataArea>
        <priceItemParmGroupId>1</priceItemParmGroupId>
        <toVal>999999999999.9900000000000000000</toVal>
        <fromVal>5000.0000000000000000000</fromVal>
        <timeOfUse></timeOfUse>
        <priceItemCode>PI_026</priceItemCode>
        <priceCriteria>NBRTRAN</priceCriteria>
        <priceCompId></priceCompId>
        <tieSeqNum>10</tieSeqNum>
        <version>0</version>
    </pricecomptier>
    <priceComponentDescription>Step 1</priceComponentDescription>
    <valueAmt>5.0000000000000000000</valueAmt>
    <priceComponentDisplay>false</priceComponentDisplay>
    <rcMapId></rcMapId>
    <tieredFlag></tieredFlag>
    <priceCompSequenceNo2>0</priceCompSequenceNo2>
</priceComponent>
<priceComponent>
    <priceCompId>5417400025</priceCompId>

```

```

<pricecomptier>
  <priceCompSequenceNo>0</priceCompSequenceNo>
  <businessObjectDataArea></businessObjectDataArea>
  <priceItemParmGroupId>1</priceItemParmGroupId>
  <toVal>1000.00000000000000000000</toVal>
  <fromVal>0.00000000000000000000</fromVal>
  <timeOfUse></timeOfUse>
  <priceItemCode>PI_026</priceItemCode>
  <priceCriteria>NBRTRAN</priceCriteria>
  <priceCompId></priceCompId>
  <tieSeqNum>10</tieSeqNum>
  <version>0</version>
</pricecomptier>
<pricecomptier>
  <priceCompSequenceNo>0</priceCompSequenceNo>
  <businessObjectDataArea></businessObjectDataArea>
  <priceItemParmGroupId>1</priceItemParmGroupId>
  <toVal>5000.00000000000000000000</toVal>
  <fromVal>1000.00000000000000000000</fromVal>
  <timeOfUse></timeOfUse>
  <priceItemCode>PI_026</priceItemCode>
  <priceCriteria>NBRTRAN</priceCriteria>
  <priceCompId></priceCompId>
  <tieSeqNum>10</tieSeqNum>
  <version>0</version>
</pricecomptier>
<pricecomptier>
  <priceCompSequenceNo>0</priceCompSequenceNo>
  <businessObjectDataArea></businessObjectDataArea>
  <priceItemParmGroupId>1</priceItemParmGroupId>
  <toVal>999999999999.99000000000000000000</toVal>
  <fromVal>5000.00000000000000000000</fromVal>
  <timeOfUse></timeOfUse>
  <priceItemCode>PI_026</priceItemCode>
  <priceCriteria>NBRTRAN</priceCriteria>
  <priceCompId></priceCompId>
  <tieSeqNum>10</tieSeqNum>
  <version>0</version>
</pricecomptier>
<pricecomptier>
  <priceCompSequenceNo>0</priceCompSequenceNo>
  <businessObjectDataArea></businessObjectDataArea>
  <priceItemParmGroupId>1</priceItemParmGroupId>
  <toVal>1000.00000000000000000000</toVal>
  <fromVal>0.00000000000000000000</fromVal>
  <timeOfUse></timeOfUse>
  <priceItemCode>PI_026</priceItemCode>
  <priceCriteria>NBRTRAN</priceCriteria>
  <priceCompId></priceCompId>
  <tieSeqNum>10</tieSeqNum>
  <version>0</version>
</pricecomptier>
<pricecomptier>
  <priceCompSequenceNo>0</priceCompSequenceNo>
  <businessObjectDataArea></businessObjectDataArea>
  <priceItemParmGroupId>1</priceItemParmGroupId>
  <toVal>5000.00000000000000000000</toVal>
  <fromVal>1000.00000000000000000000</fromVal>
  <timeOfUse></timeOfUse>
  <priceItemCode>PI_026</priceItemCode>
  <priceCriteria>NBRTRAN</priceCriteria>
  <priceCompId></priceCompId>
  <tieSeqNum>10</tieSeqNum>
  <version>0</version>

```

```

</pricecomptier>
<pricecomptier>
  <priceCompSequenceNo>0</priceCompSequenceNo>
  <businessObjectDataArea></businessObjectDataArea>
  <priceItemParmGroupId>1</priceItemParmGroupId>
  <toVal>999999999999.9900000000000000000</toVal>
  <fromVal>5000.0000000000000000000</fromVal>
  <timeOfUse></timeOfUse>
  <priceItemCode>PI_026</priceItemCode>
  <priceCriteria>NBRTRAN</priceCriteria>
  <priceCompId></priceCompId>
  <tieSeqNum>10</tieSeqNum>
  <version>0</version>
</pricecomptier>
<priceComponentDescription>Step 2</priceComponentDescription>
<valueAmt>4.0000000000000000000</valueAmt>
<priceComponentDisplay>false</priceComponentDisplay>
<rcMapId></rcMapId>
<tieredFlag></tieredFlag>
<priceCompSequenceNo2>0</priceCompSequenceNo2>
</priceComponent>
<priceComponent>
  <priceCompId>5417400026</priceCompId>
  <pricecomptier>
    <priceCompSequenceNo>0</priceCompSequenceNo>
    <businessObjectDataArea></businessObjectDataArea>
    <priceItemParmGroupId>1</priceItemParmGroupId>
    <toVal>1000.0000000000000000000</toVal>
    <fromVal>0.0000000000000000000</fromVal>
    <timeOfUse></timeOfUse>
    <priceItemCode>PI_026</priceItemCode>
    <priceCriteria>NBRTRAN</priceCriteria>
    <priceCompId></priceCompId>
    <tieSeqNum>10</tieSeqNum>
    <version>0</version>
  </pricecomptier>
  <pricecomptier>
    <priceCompSequenceNo>0</priceCompSequenceNo>
    <businessObjectDataArea></businessObjectDataArea>
    <priceItemParmGroupId>1</priceItemParmGroupId>
    <toVal>5000.0000000000000000000</toVal>
    <fromVal>1000.0000000000000000000</fromVal>
    <timeOfUse></timeOfUse>
    <priceItemCode>PI_026</priceItemCode>
    <priceCriteria>NBRTRAN</priceCriteria>
    <priceCompId></priceCompId>
    <tieSeqNum>10</tieSeqNum>
    <version>0</version>
  </pricecomptier>
  <pricecomptier>
    <priceCompSequenceNo>0</priceCompSequenceNo>
    <businessObjectDataArea></businessObjectDataArea>
    <priceItemParmGroupId>1</priceItemParmGroupId>
    <toVal>999999999999.9900000000000000000</toVal>
    <fromVal>5000.0000000000000000000</fromVal>
    <timeOfUse></timeOfUse>
    <priceItemCode>PI_026</priceItemCode>
    <priceCriteria>NBRTRAN</priceCriteria>
    <priceCompId></priceCompId>
    <tieSeqNum>10</tieSeqNum>
    <version>0</version>
  </pricecomptier>
  <pricecomptier>
    <priceCompSequenceNo>0</priceCompSequenceNo>
  
```



```

        <businessObjectDataArea></businessObjectDataArea>
        <priceItemParmGroupId>1</priceItemParmGroupId>
        <toVal>1000.000000000000000000</toVal>
        <fromVal>0.000000000000000000</fromVal>
        <timeOfUse></timeOfUse>
        <priceItemCode>PI_026</priceItemCode>
        <priceCriteria>NBRTRAN</priceCriteria>
        <priceCompId></priceCompId>
        <tieSeqNum>10</tieSeqNum>
        <version>0</version>
    </pricecomptier>
    <pricecomptier>
        <priceCompSequenceNo>0</priceCompSequenceNo>
        <businessObjectDataArea></businessObjectDataArea>
        <priceItemParmGroupId>1</priceItemParmGroupId>
        <toVal>5000.000000000000000000</toVal>
        <fromVal>1000.000000000000000000</fromVal>
        <timeOfUse></timeOfUse>
        <priceItemCode>PI_026</priceItemCode>
        <priceCriteria>NBRTRAN</priceCriteria>
        <priceCompId></priceCompId>
        <tieSeqNum>10</tieSeqNum>
        <version>0</version>
    </pricecomptier>
    <pricecomptier>
        <priceCompSequenceNo>0</priceCompSequenceNo>
        <businessObjectDataArea></businessObjectDataArea>
        <priceItemParmGroupId>1</priceItemParmGroupId>
        <toVal>999999999999.990000000000000000</toVal>
        <fromVal>5000.000000000000000000</fromVal>
        <timeOfUse></timeOfUse>
        <priceItemCode>PI_026</priceItemCode>
        <priceCriteria>NBRTRAN</priceCriteria>
        <priceCompId></priceCompId>
        <tieSeqNum>10</tieSeqNum>
        <version>0</version>
    </pricecomptier>
    <priceComponentDescription>Step 3</priceComponentDescription>
    <valueAmt>3.000000000000000000</valueAmt>
    <priceComponentDisplay>false</priceComponentDisplay>
    <rcMapId></rcMapId>
    <tieredFlag></tieredFlag>
    <priceCompSequenceNo2>0</priceCompSequenceNo2>
</priceComponent>
</pricing>
<pricing>
    <priority>2</priority>
    <priceListId>5417730766</priceListId>
    <priceListDescription>PriceList -1</priceListDescription>
    <priceListStartDate>2022-01-11</priceListStartDate>
    <priceListEndDate>2022-01-21</priceListEndDate>
    <noOfDays>10</noOfDays>
    <priceItemCode>PI_027</priceItemCode>
    <priceitemDescr>V7-Direct Debit</priceitemDescr>
    <priceAsgnId>5410009209</priceAsgnId>
    <validityFlag></validityFlag>
    <sourceEntityType></sourceEntityType>
    <sourceEntityCode></sourceEntityCode>
    <priceListInfo></priceListInfo>
    <priceComponent>
        <priceCompId>5417300038</priceCompId>
        <pricecomptier>
            <priceCompSequenceNo></priceCompSequenceNo>
            <businessObjectDataArea></businessObjectDataArea>

```

```

        <priceItemParmGroupId></priceItemParmGroupId>
        <toVal></toVal>
        <fromVal></fromVal>
        <timeOfUse></timeOfUse>
        <priceItemCode></priceItemCode>
        <priceCriteria></priceCriteria>
        <priceCompId></priceCompId>
        <tieSeqNum></tieSeqNum>
        <version></version>
    <priceComponentDescription>Basic BK-NBR</priceComponentDescription>
    <valueAmt>0.150000000000000000</valueAmt>
    <priceComponentDisplay>false</priceComponentDisplay>
    <rcMapId></rcMapId>
    <tieredFlag></tieredFlag>
    <priceCompSequenceNo2>0</priceCompSequenceNo2>
</priceComponent>
</pricing>
<pricing>
    <priority>2</priority>
    <priceListId>5417730766</priceListId>
    <priceListDescription>PriceList -1</priceListDescription>
    <priceListStartDate>2022-01-11</priceListStartDate>
    <priceListEndDate>2022-01-21</priceListEndDate>
    <noOfDays>10</noOfDays>
    <priceItemCode>PI_028</priceItemCode>
    <priceitemDescr>V7-Direct Debit</priceitemDescr>
    <priceAsgnId>5410009210</priceAsgnId>
    <validityFlag></validityFlag>
    <sourceEntityType></sourceEntityType>
    <sourceEntityCode></sourceEntityCode>
    <priceListInfo></priceListInfo>
    <priceComponent>
        <priceCompId>5417300040</priceCompId>
        <pricecomptier>
            <priceCompSequenceNo></priceCompSequenceNo>
            <businessObjectDataArea></businessObjectDataArea>
            <priceItemParmGroupId></priceItemParmGroupId>
            <toVal></toVal>
            <fromVal></fromVal>
            <timeOfUse></timeOfUse>
            <priceItemCode></priceItemCode>
            <priceCriteria></priceCriteria>
            <priceCompId></priceCompId>
            <tieSeqNum></tieSeqNum>
            <version></version>
        <priceComponentDescription>FLAT</priceComponentDescription>
        <valueAmt>0.750000000000000000</valueAmt>
        <priceComponentDisplay>false</priceComponentDisplay>
        <rcMapId></rcMapId>
        <tieredFlag></tieredFlag>
        <priceCompSequenceNo2>0</priceCompSequenceNo2>
    </priceComponent>
</pricing>
<pricing>
    <priority>2</priority>
    <priceListId>5417730766</priceListId>
    <priceListDescription>PriceList -1</priceListDescription>
    <priceListStartDate>2022-01-11</priceListStartDate>
    <priceListEndDate>2022-01-21</priceListEndDate>
    <noOfDays>10</noOfDays>
    <priceItemCode>PI_028</priceItemCode>
    <priceitemDescr>V8-Cheque Collections</priceitemDescr>
    <priceAsgnId>5410009211</priceAsgnId>
    <validityFlag></validityFlag>

```

```

<sourceEntityType></sourceEntityType>
<sourceEntityCode></sourceEntityCode>
<priceListInfo></priceListInfo>
<priceComponent>
  <priceCompId>5417300042</priceCompId>
  <pricecomptier>
    <priceCompSequenceNo></priceCompSequenceNo>
    <businessObjectDataArea></businessObjectDataArea>
    <priceItemParmGroupId></priceItemParmGroupId>
    <toVal></toVal>
    <fromVal></fromVal>
    <timeOfUse></timeOfUse>
    <priceItemCode></priceItemCode>
    <priceCriteria></priceCriteria>
    <priceCompId></priceCompId>
    <tieSeqNum></tieSeqNum>
    <version></version>
    <priceComponentDescription>FLAT</priceComponentDescription>
    <valueAmt>6.670000000000000000</valueAmt>
    <priceComponentDisplay>>false</priceComponentDisplay>
    <rcMapId></rcMapId>
    <tieredFlag></tieredFlag>
    <priceCompSequenceNo2>0</priceCompSequenceNo2>
  </priceComponent>
</pricing>
<pricing>
  <priority>2</priority>
  <priceListId>5417730766</priceListId>
  <priceListDescription>PriceList -1</priceListDescription>
  <priceListStartDate>2022-01-11</priceListStartDate>
  <priceListEndDate>2022-01-21</priceListEndDate>
  <noOfDays>10</noOfDays>
  <priceItemCode>PI_028</priceItemCode>
  <priceitemDescr>V8-Cheque Collections</priceitemDescr>
  <priceAsgnId>5410009212</priceAsgnId>
  <validityFlag></validityFlag>
  <sourceEntityType></sourceEntityType>
  <sourceEntityCode></sourceEntityCode>
  <priceListInfo></priceListInfo>
  <priceComponent>
    <priceCompId>5417300044</priceCompId>
    <pricecomptier>
      <priceCompSequenceNo></priceCompSequenceNo>
      <businessObjectDataArea></businessObjectDataArea>
      <priceItemParmGroupId></priceItemParmGroupId>
      <toVal></toVal>
      <fromVal></fromVal>
      <timeOfUse></timeOfUse>
      <priceItemCode></priceItemCode>
      <priceCriteria></priceCriteria>
      <priceCompId></priceCompId>
      <tieSeqNum></tieSeqNum>
      <version></version>
      <priceComponentDescription>FLAT</priceComponentDescription>
      <valueAmt>0.300000000000000000</valueAmt>
      <priceComponentDisplay>>false</priceComponentDisplay>
      <rcMapId></rcMapId>
      <tieredFlag></tieredFlag>
      <priceCompSequenceNo2>0</priceCompSequenceNo2>
    </priceComponent>
  </pricing>
</pricing>
  <priority>2</priority>
  <priceListId>5417730766</priceListId>

```

```

<priceListDescription>PriceList -1</priceListDescription>
<priceListStartDate>2022-01-11</priceListStartDate>
<priceListEndDate>2022-01-21</priceListEndDate>
<noOfDays>10</noOfDays>
<priceItemCode>PI_028</priceItemCode>
<priceitemDescr>V8-Cheque Collections</priceitemDescr>
<priceAsgnId>5410009213</priceAsgnId>
<validityFlag></validityFlag>
<sourceEntityType></sourceEntityType>
<sourceEntityCode></sourceEntityCode>
<priceListInfo></priceListInfo>
<priceComponent>
  <priceCompId>5417300046</priceCompId>
  <pricecomptier>
    <priceCompSequenceNo></priceCompSequenceNo>
    <businessObjectDataArea></businessObjectDataArea>
    <priceItemParmGroupId></priceItemParmGroupId>
    <toVal></toVal>
    <fromVal></fromVal>
    <timeOfUse></timeOfUse>
    <priceItemCode></priceItemCode>
    <priceCriteria></priceCriteria>
    <priceCompId></priceCompId>
    <tieSeqNum></tieSeqNum>
    <version></version>
    <priceComponentDescription>FLAT</priceComponentDescription>
    <valueAmt>2.050000000000000000</valueAmt>
    <priceComponentDisplay>>false</priceComponentDisplay>
    <rcMapId></rcMapId>
    <tieredFlag></tieredFlag>
    <priceCompSequenceNo2>0</priceCompSequenceNo2>
  </priceComponent>
</pricing>
<pricing>
  <priority>2</priority>
  <priceListId>5417730766</priceListId>
  <priceListDescription>PriceList -1</priceListDescription>
  <priceListStartDate>2022-01-11</priceListStartDate>
  <priceListEndDate>2022-01-21</priceListEndDate>
  <noOfDays>10</noOfDays>
  <priceItemCode>PI_029</priceItemCode>
  <priceitemDescr>V9-Domestic Liquidity</priceitemDescr>
  <priceAsgnId>5410009214</priceAsgnId>
  <validityFlag></validityFlag>
  <sourceEntityType></sourceEntityType>
  <sourceEntityCode></sourceEntityCode>
  <priceListInfo></priceListInfo>
  <priceComponent>
    <priceCompId>5417300048</priceCompId>
    <pricecomptier>
      <priceCompSequenceNo></priceCompSequenceNo>
      <businessObjectDataArea></businessObjectDataArea>
      <priceItemParmGroupId></priceItemParmGroupId>
      <toVal></toVal>
      <fromVal></fromVal>
      <timeOfUse></timeOfUse>
      <priceItemCode></priceItemCode>
      <priceCriteria></priceCriteria>
      <priceCompId></priceCompId>
      <tieSeqNum></tieSeqNum>
      <version></version>
      <priceComponentDescription>FLAT</priceComponentDescription>
      <valueAmt>0.400000000000000000</valueAmt>
      <priceComponentDisplay>>false</priceComponentDisplay>

```

```

        <rcMapId></rcMapId>
        <tieredFlag></tieredFlag>
        <priceCompSequenceNo2>0</priceCompSequenceNo2>
    </priceComponent>
</pricing>
<pricing>
    <priority>2</priority>
    <priceListId>5417730766</priceListId>
    <priceListDescription>PriceList -1</priceListDescription>
    <priceListStartDate>2022-01-11</priceListStartDate>
    <priceListEndDate>2022-01-21</priceListEndDate>
    <noOfDays>10</noOfDays>
    <priceItemCode>PI_030</priceItemCode>
    <priceitemDescr>V10-Third Party Bank</priceitemDescr>
    <priceAsgnId>5410009215</priceAsgnId>
    <validityFlag></validityFlag>
    <sourceEntityType></sourceEntityType>
    <sourceEntityCode></sourceEntityCode>
    <priceListInfo></priceListInfo>
    <priceComponent>
        <priceCompId>5417300050</priceCompId>
        <pricecomptier>
            <priceCompSequenceNo></priceCompSequenceNo>
            <businessObjectDataArea></businessObjectDataArea>
            <priceItemParmGroupId></priceItemParmGroupId>
            <toVal></toVal>
            <fromVal></fromVal>
            <timeOfUse></timeOfUse>
            <priceItemCode></priceItemCode>
            <priceCriteria></priceCriteria>
            <priceCompId></priceCompId>
            <tieSeqNum></tieSeqNum>
            <version></version>
            <priceComponentDescription>FLAT</priceComponentDescription>
            <valueAmt>0.600000000000000000</valueAmt>
            <priceComponentDisplay>false</priceComponentDisplay>
            <rcMapId></rcMapId>
            <tieredFlag></tieredFlag>
            <priceCompSequenceNo2>0</priceCompSequenceNo2>
        </priceComponent>
    </pricing>
</pricing>
<pricing>
    <priority>2</priority>
    <priceListId>5417730766</priceListId>
    <priceListDescription>PriceList -1</priceListDescription>
    <priceListStartDate>2022-01-11</priceListStartDate>
    <priceListEndDate>2022-01-21</priceListEndDate>
    <noOfDays>10</noOfDays>
    <priceItemCode>PI_031</priceItemCode>
    <priceitemDescr>MT943_SWIFT_01</priceitemDescr>
    <priceAsgnId>5410009201</priceAsgnId>
    <validityFlag></validityFlag>
    <sourceEntityType></sourceEntityType>
    <sourceEntityCode></sourceEntityCode>
    <priceListInfo></priceListInfo>
    <priceComponent>
        <priceCompId>5417300002</priceCompId>
        <pricecomptier>
            <priceCompSequenceNo></priceCompSequenceNo>
            <businessObjectDataArea></businessObjectDataArea>
            <priceItemParmGroupId></priceItemParmGroupId>
            <toVal></toVal>
            <fromVal></fromVal>
            <timeOfUse></timeOfUse>

```

```

        <priceItemCode></priceItemCode>
        <priceCriteria></priceCriteria>
        <priceCompId></priceCompId>
        <tieSeqNum></tieSeqNum>
        <version></version>
        <priceComponentDescription>FLAT</priceComponentDescription>
        <valueAmt>16.660000000000000000</valueAmt>
        <priceComponentDisplay>false</priceComponentDisplay>
        <rcMapId></rcMapId>
        <tieredFlag></tieredFlag>
        <priceCompSequenceNo2>0</priceCompSequenceNo2>
    </priceComponent>
</pricing>
<pricing>
    <priority>2</priority>
    <priceListId>5417730766</priceListId>
    <priceListDescription>PriceList -1</priceListDescription>
    <priceListStartDate>2022-01-11</priceListStartDate>
    <priceListEndDate>2022-01-21</priceListEndDate>
    <noOfDays>10</noOfDays>
    <priceItemCode>PI_032</priceItemCode>
    <priceitemDescr>MT943_SWIFT_02</priceitemDescr>
    <priceAsgnId>5410009261</priceAsgnId>
    <validityFlag></validityFlag>
    <sourceEntityType></sourceEntityType>
    <sourceEntityCode></sourceEntityCode>
    <priceListInfo></priceListInfo>
    <priceComponent>
        <priceCompId>5417450002</priceCompId>
        <pricecomptier>
            <priceCompSequenceNo></priceCompSequenceNo>
            <businessObjectDataArea></businessObjectDataArea>
            <priceItemParmGroupId></priceItemParmGroupId>
            <toVal></toVal>
            <fromVal></fromVal>
            <timeOfUse></timeOfUse>
            <priceItemCode></priceItemCode>
            <priceCriteria></priceCriteria>
            <priceCompId></priceCompId>
            <tieSeqNum></tieSeqNum>
            <version></version>
            <priceComponentDescription>FLAT</priceComponentDescription>
            <valueAmt>15.000000000000000000</valueAmt>
            <priceComponentDisplay>false</priceComponentDisplay>
            <rcMapId></rcMapId>
            <tieredFlag></tieredFlag>
            <priceCompSequenceNo2>0</priceCompSequenceNo2>
        </priceComponent>
    </pricing>
</entityList>
<messageCategory>0</messageCategory>
<messageNumber>0</messageNumber>
<messageText></messageText>
<longDescription></longDescription>
<inquiryTypeFlag>DETL</inquiryTypeFlag>
</C1_GETELIGIBLEPROD>

```

Related Topics

For more information on...	See...
Eligible Market Products, Offers, or Bundles Derivation Request and Response - Tags in XML Format	Eligible Market Products, Offers, or Bundles Derivation Request and Response - Tags in XML Format on page 3294

Eligible Market Products, Offers, or Bundles Derivation Request in the JSON Format

The following code snippet illustrates how the attribute/value pairs should be structured while receiving the eligible market products, offers, or bundles derivation request in the JSON format:

```
{
  "C1_GETELIGIBLEPROD":
  {
    "productCode": "",
    "productCategoryFlg": "",
    "division": "",
    "entityType": "",
    "entityCode": "",
    "processDate": "",
    "accountId": "",
    "acctIdtype": "",
    "acctIdentifierValue": "",
    "personId": "",
    "custIdTypeCd": "",
    "perIdentifireVal": "",
    "productLinkedEntity":
    {
      "linkedEntityCode": "",
      "linkedEntityType": ""
    }
    "eligibleParameter":
    {
      "priceParmCode": "",
      "priceParmVal": ""
    }
  }
}
```

Related Topics

For more information on...	See...
Eligible Market Products, Offers, or Bundles Derivation Request and Response - Attribute/Value Pairs in JSON Format	Eligible Market Products, Offers, or Bundles Derivation Request and Response - Attribute/Value Pairs in JSON Format on page 3382
Sample Eligible Market Product Derivation Request and Response in the JSON Format	Sample Eligible Market Product Derivation Request and Response in the JSON Format on page 3387
Sample Eligible Offer Derivation Request and Response in the JSON Format	Sample Eligible Offer Derivation Request and Response in the JSON Format on page 3416
Sample Eligible Bundle Derivation Request and Response in the JSON Format	Sample Eligible Bundle Derivation Request and Response in the JSON Format on page 3442

Eligible Market Products, Offers, or Bundles Derivation Response in the JSON Format

The following code snippet illustrates how the attribute/value pairs should be structured while sending the eligible market products, offers, or bundles derivation response in the JSON format:

```
{
  "C1_GETELIGIBLEPROD":
  {
    "productCode": "",
    "productCategoryFlg": "",
    "division": "",
    "entityType": "",
    "entityCode": "",
    "processDate": "",
    "accountId": "",
    "acctIdtype": "",
    "acctIdentifierValue": "",
    "personId": "",
    "custIdTypeCd": "",
    "perIdentifireVal": "",
    "productLinkedEntity":
    {
      "linkedEntityCode": "",
      "linkedEntityType": ""
    }
    "eligibleParameter":
    {
      "priceParmCode": "",
      "priceParmVal": ""
    }
  }
  "entityList":
  {
    "entityCode": "",
    "entityType": "",
    "entityName": "",
    "entityStartDate": "",
    "entityEndDate": "",
    "entityCodeDescr": "",
    "termsAndCondition": "",
    "termAndConditionDescr": "",
    "status": "",
    "productList":
    {
      "productCode": "",
      "productDescription": "",
      "productTypFlgDesc": "",
      "productCategoryFlgDesc": ""
    }
    "productLinkedEntity":
    {
      "linkedEntityStartDate": "",
      "linkedEntityEndDate": "",
      "linkedEntityCode": "",
      "linkedEntityType": ""
    }
    "EntityDivision":
    {
      "divisionCode": ""
    }
    "eligibilityDetails":
    {
      "eligibilityStartDate": "",
      "eligibilityEndDate": "",
      "eligibilityDescription": "",
      "eligibilityRule":

```



```

    {
      "sequenceNumber": "",
      "lhsPriceParmCd": "",
      "operator": "",
      "rhsPriceParmCd": "",
      "rhsPriceParmVal": "",
      "lhsPriceParmCd1": "",
      "rhsPriceParmTypeFlg": "",
      "trueFlag": "",
      "falseFlag": "",
      "insufficientFlag": "",
    }
  }
  "services":
  {
    "serviceName": "",
    "mandatoryFlag": "",
  }
  "pricing"
  {
    "priority": "",
    "priceListId": "",
    "priceListDescription": "",
    "priceListStartDate": "",
    "priceListEndDate": "",
    "noOfDays": "",
    "priceItemCode": "",
    "priceitemDescr": "",
    "priceAsgnId": "",
    "validityFlag": "",
    "sourceEntityType": "",
    "sourceEntityCode": "",
    "priceListInfo": "",
    "priceComponent":
    {
      "priceCompId": "",
      "pricecomptier"
      {
        "priceCompSequenceNo": "",
        "businessObjectDataArea": "",
        "priceItemParmGroupId": "",
        "toVal": "",
        "fromVal": "",
        "timeOfUse": "",
        "priceItemCode": "",
        "priceCriteria": "",
        "priceCompId": "",
        "tieSeqNum": "",
        "version": "",
      }
      "priceComponentDescription": "",
      "valueAmt": "",
      "priceComponentDisplay": "",
      "rcMapId": "",
      "tieredFlag": "",
      "priceCompSequenceNo2": "",
    }
  }
}
"messageCategory": "",
"messageNumber dataType": "",
"messageText": "",
"longDescription": "",

```

```

    "inquiryTypeFlag": "",
  }
}

```

Related Topics

For more information on...	See...
Eligible Market Products, Offers, or Bundles Derivation Request and Response - Attribute/Value Pairs in JSON Format	Eligible Market Products, Offers, or Bundles Derivation Request and Response - Attribute/Value Pairs in JSON Format on page 3382
Sample Eligible Market Product Derivation Request and Response in the JSON Format	Sample Eligible Market Product Derivation Request and Response in the JSON Format on page 3387
Sample Eligible Offer Derivation Request and Response in the JSON Format	Sample Eligible Offer Derivation Request and Response in the JSON Format on page 3416
Sample Eligible Bundle Derivation Request and Response in the JSON Format	Sample Eligible Bundle Derivation Request and Response in the JSON Format on page 3442

Eligible Market Products, Offers, or Bundles Derivation Request and Response - Attribute/Value Pairs in JSON Format

Note: We recommend you to refer the topics [Eligible Market Products, Offers, or Bundles Derivation Request in the JSON Format](#) on page 3379 and [Eligible Market Products, Offers, or Bundles Derivation Response in the JSON Format](#) on page 3379 in parallel while understanding the below mentioned attributes. This will help you to understand how the attributes/values are structured in the JSON format.

Before calling the **C1_GETELIGIBLEPROD** business service through an inbound web service, you need to ensure that the eligible active market products, offers, or bundles derivation request contains the following attributes:

Attribute Name	Attribute Description	Mandatory (Yes or No)
productCode	Used to specify the product code to derive the details of the eligible active entities.	Yes(Conditional)
	Note: Entity is referred to market product, offer or bundle.	Note: This field is required if the product category, entity type, or entity code are not entered.
productCategoryFlg	Used to specify the product category flag to derive the details of the eligible active entities.	No
	Note: Entity is referred to market product, offer or bundle.	
division	Used to specify the division to derive the details of the eligible active entities which are associated with a particular division.	Yes(Conditional)
		Note: This field is required with product code, product category, entity type or entity code to extract the entities of the specific division.
entityType	Used to indicate the entity type to derive the details of the eligible active entities.	Yes(Conditional)
		Note: This field is required if the entity code is entered.

Attribute Name	Attribute Description	Mandatory (Yes or No)
		Note: This field is required if the product code, or product category are not entered.
entityCode	Used to specify the entity code to derive the details of the eligible active entities.	Yes(Conditional) Note: This field is required if the product code or product category are not entered.
processDate	Used to specify the date to derive the details of effective market products, offers, or bundles for that date.	Yes(Conditional) Note: If the date is not entered then it will display the default date from the system on which the enquiry is made.
accountId	Used to indicate the account for which you want to derive the details of the eligible active entities.	Yes(Conditional) Note: If this field is not entered then all active entity will be extract. Note: This field is required if you want to derive the details of eligible active entities for specific person or account.
acctIdtype	Used to indicate the type of account identifier type for which you to derive the details of the eligible active entities.	No
acctIdentifierValue	Used to specify the value for the account identifier type for which you to derive the details of the eligible active entity.	Yes(Conditional) Note: This field is required if you want to derive the details of eligible active entities for specific person or account.
personId	Used to specify the person account for which you want to derive the details of eligible active market products, offers, or bundles.	Yes(Conditional) Note: This field is required if you want to derive the details of eligible active entities for specific person or account.
custIdTypeCd	Used to indicate the customer ID type for which you want to derive the details of eligible active market products, offers, or bundles.	No
perIdentifireVal	Used to specify the value of person identifier for which you want to derive the details of eligible active market products, offers, or bundles.	No

Attribute Name	Attribute Description	Mandatory (Yes or No)
productLinkedEntity	Used to specify product linked entity(market product code) for which you want to derive the details of eligible active offers or bundles linked with that particular code.	No
linkedEntityCode	Used to specify code of the linked entity(market product code) for which you want to derive the details of eligible active offers or bundles linked with that particular code.	Yes(Conditional) Note: This field is required when you want to derive offer or bundle linked with the particular market product.
linkedEntityType	Used to indicate type of the linked entity(market product code) for which you want to derive the details of eligible active offer or bundle linked with that particular code.	Yes(Conditional) Note: This field is required when you want to derive offer or bundle linked with the particular market product.
eligibleParameter	Used to specify the eligibility parameter based on which you want to derive the details of eligible active market products, offers, or bundles.	Yes(Conditional) Note: If this field is not entered then system will take the eligibility details from the person or account.
priceParmCode	Used to specify the eligibility parameter code based on which you want to derive the details of eligible active market products, offers, or bundles.	Yes(Conditional) Note: If this field is not entered then system will take the eligibility details from the person or account.
priceParmVal	Used to specify the eligibility parameter value based on which you want to derive the details of eligible active market products, offers, or bundles.	Yes(Conditional) Note: If this field is not entered then system will take the eligibility details from the person or account.

The following table lists and describes the attributes which appear in the eligible active market products, offers, or bundles derivation response JSON format:

Attribute Name	Attribute Description
entityList	Displays the list of eligible market products, offers, or bundles.
entityCode	Displays the entity code.
entityType	Displays the entity type.
entityName	Displays the entity name.
entityStartDate	Displays the date from when the entity is effective.
entityEndDate	Displays the date till when the entity is effective.

Attribute Name	Attribute Description
entityCodeDescr	Displays the description of the entity.
termsAndCondition	Displays the terms and condition of the entity.
termAndConditionDesc	Displays the description of the terms and conditions of the entity.
status	Displays the status of the entity.
productList	Displays the list of the eligible products to which the requested entity belongs.
productCode	Displays the code of the eligible product to which the requested entity belongs.
productDescription	Displays the description of the eligible product to which the requested entity belongs.
productTypFlgDesc	Displays the description of the eligible product type flag to which the requested entity belongs.
productCategoryFlgDesc	Displays the description of the eligible product category flag to which the requested entity belongs.
productLinkedEntity	Displays the list of eligible market products, offers, and bundles.
linkedEntityStartDate	Displays the date from when the linked entity is effective.
linkedEntityEndDate	Displays the date till when the linked entity is effective.
linkedEntityCode	Displays the linked entity code for the requested entity code.
linkedEntityType	Displays the linked entity for the requested entity code.
	Note: It is applicable in case of offer and bundle.
EntityDivision	Displays the division to which the requested entity belongs.
divisionCode	Displays the division code to which the requested entity belongs.
eligibilityDetails	Indicates the name of group tag.
eligibilityStartDate	Displays the date from when the eligibility of the entity is effective.
eligibilityEndDate	Displays the date till when the eligibility of the entity is effective.
eligibilityDescription	Displays the description of the eligibility to which the requested entity belongs.
eligibilityRule	Indicates the name of group tag.
sequenceNumber	Indicates the sequence number of eligibility condition.
lhsPriceParmCd	Indicates the left side parameter code of the eligibility condition.
operator	Indicates the operator to evaluate the condition
rhsPriceParmCd	Indicates the right side parameter code of the eligibility condition.
rhsPriceParmVal	Indicates the right side parameter value of the eligibility condition.
lhsPriceParmCd1	Indicates the left side parameter code of the eligibility condition.
rhsPriceParmTypeFlg	Indicates the value of the right side flag.
trueFlag	Indicates the true condition.
falseFlag	Indicates the false condition.
insufficientFlag	Indicates the insufficient condition.
services	Indicates the name of group tag.

Attribute Name	Attribute Description
serviceName	Displays the service configured at the requested entity code.
mandatoryFlag	Indicates the mandatory or optional type of the services.
pricing	Indicates the name of group tag.
priority	Displays the priority in sequence of the price list of the entities.
priceListId	Displays the Price List ID.
priceListDescription	Displays the description of the price list.
priceListStartDate	Displays the date from when the price list of the entity is effective.
priceListEndDate	Displays the date till when the price list of the entity is effective.
noOfDays	Displays the validity of price list in number of days.
priceItemCode	Displays the price item code.
priceitemDescr	Displays the description of the price item.
priceAsgnId	Displays the price assignment ID.
validityFlag	Indicates the validity of the price item.
sourceEntityType	Displays the source entity type.
sourceEntityCode	Displays the source entity code.
priceListInfo	Displays the information of the price list.
priceComponent	Indicates the name of group tag.
priceCompId	Displays the price component ID.
pricecomptier	Indicates the name of group tag.
priceCompSequenceNo	Displays the sequence number of the price component.
priceItemParmGroupID	Displays the parameter group ID of the price item.
toVal	Indicates the tiering to value of the price item.
fromVal	Indicates the tiering from value of the price item.
timeOfUse	Indicates the tiering time of use.
priceItemCode	Displays the price item code.
priceCriteria	Displays the price criteria of the price item.
priceCompId	Displays the price component ID.
tieSeqNum	Indicates the tiering sequence number.
version	Displays the version number.
priceComponentDescription	Displays the description of the price component.
valueAmt	Displays the value amount of the price component.
priceComponentDisplay	Displays the price component.
rcMapId	Displays the rate component map ID.
tieredFlag	Indicates the tire flag.

Attribute Name	Attribute Description
priceCompSequenceNo	Displays the sequence of the price component.
messageCategory	Indicates the category of the message.
messageNumber	Indicates the number of the message.
messageText	Displays the message.
longDescription	Displays the long description.
inquiryTypeFlag	Displays the inquiry type flag. Note: If the inquiry type flag value is SMRY then service will provide details of eligible entities without price component and if the inquiry type flag value is DETL then service will provide details of eligible entities with price component

Related Topics

For more information on...	See...
Sample Eligible Market Product Derivation Request and Response in the JSON Format	Sample Eligible Market Product Derivation Request and Response in the JSON Format on page 3387
Sample Eligible Offer Derivation Request and Response in the JSON Format	Sample Eligible Offer Derivation Request and Response in the JSON Format on page 3416
Sample Eligible Bundle Derivation Request and Response in the JSON Format	Sample Eligible Bundle Derivation Request and Response in the JSON Format on page 3442

Sample Eligible Market Product Derivation Request and Response in the JSON Format

Using the below example, you can derive eligible market products for the **2406432705** account which are processed on **2022-01-11**.

Sample Eligible Market Product Request in the JSON Format

```
{
  "C1_GETELIGIBLEPROD":
  {
    "productCode": "LOAN_001",
    "productCategoryFlg": "LOAN",
    "division": "IND",
    "entityType": "MP",
    "entityCode": "LOANSMP_001",
    "processDate": "2022-01-11",
    "accountId": "2406432705",
    "acctIdtype": "",
    "acctIdentifierValue": "",
    "personId": "",
    "custIdTypeCd": "",
    "perIdentifireVal": "",
    "productLinkedEntity":
    {
      "linkedEntityCode": "CHECKMP_001",
      "linkedEntityType": "MP",
    }
    "eligibleParameter":
    {
      "priceParmCode": "ACC_DIVISION",
      "priceParmVal": "IND",
    }
  }
}
```

```

        "priceParmCode": "PERSON_STATE",
        "priceParmVal": "MH",
    }
}
}
}

```

Sample Eligible Market Product Response in the JSON Format

```

{
  "C1_GETELIGIBLEPROD":
  {
    "productCode": "LOAN_001",
    "productCategoryFlg": "LOAN",
    "division": "IND",
    "entityType": "MP",
    "entityCode": "LOANSMP_001",
    "processDate": "2022-01-11",
    "accountId": "2406432705",
    "acctIdtype": "",
    "acctIdentifierValue": "",
    "personId": "",
    "custIdTypeCd": "",
    "perIdentifireVal": "",
    "productLinkedEntity":
    {
      "linkedEntityCode": "CHECKMP_001",
      "linkedEntityType": "MP",
    }
    "eligibleParameter":
    {
      "priceParmCode": "ACC_DIVISION",
      "priceParmVal": "IND",
      {
        "priceParmCode": "PERSON_STATE",
        "priceParmVal": "MH",
      }
    }
    "entityList":
    {
      "entityCode": "LOANSMP_001",
      "entityType": "MP",
      "entityName": "LOANSMP_001",
      "entityStartDate": "2022-01-11",
      "entityEndDate": "",
      "entityCodeDescr": "",
      "termsAndCondition": "TERMSPRAAS",
      "termAndConditionDescr": "TERMSPRAAS",
      "status": "ACTIVE",
      "productList":
      {
        "productCode": "LOAN_001",
        "productDescription": "LOAN_001",
        "productTypFlgDesc": "Product",
        "productCategoryFlgDesc": "Loans",
      }
      "productLinkedEntity":
      {
        "linkedEntityStartDate": "",
        "linkedEntityEndDate": "",
        "linkedEntityCode": "",
        "linkedEntityType": "",
      }
    }
    "EntityDivision":
  }
}

```



```

{
  "divisionCode": "IND",
}
"eligibilityDetails":
{
  "eligibilityStartDate": "2022-01-11",
  "eligibilityEndDate": "",
  "eligibilityDescription": "ELG_001",
  "eligibilityRule":
  {
    "sequenceNumber": "10",
    "lhsPriceParmCd": "ACC_DIVISION",
    "operator": "=",
    "rhsPriceParmCd": "",
    "rhsPriceParmVal": "IND",
    "lhsPriceParmCd1": "",
    "rhsPriceParmTypeFlg": "VAL",
    "trueFlag": "RLTR",
    "falseFlag": "RLFS",
    "insufficientFlag": "RLFS",
  }
  "eligibilityRule":
  {
    "sequenceNumber": "20",
    "lhsPriceParmCd": "PERSON_STATE",
    "operator": "<=",
    "rhsPriceParmCd": "",
    "rhsPriceParmVal": "CA",
    "lhsPriceParmCd1": "",
    "rhsPriceParmTypeFlg": "VAL",
    "trueFlag": "RLTR",
    "falseFlag": "RLTR",
    "insufficientFlag": "RLFS",
  }
  "eligibilityRule":
  {
    "sequenceNumber": "30",
    "lhsPriceParmCd": "ACCOUNT_CURRENCY",
    "operator": "<>",
    "rhsPriceParmCd": "",
    "rhsPriceParmVal": "USD",
    "lhsPriceParmCd1": "",
    "rhsPriceParmTypeFlg": "VAL",
    "trueFlag": "RLTR",
    "falseFlag": "RLTR",
    "insufficientFlag": "RLFS",
  }
}
"services":
{
  {
    "serviceName": "Product Service PRASS2",
    "mandatoryFlag": "true",
  }
  {
    "serviceName": "MH division product service",
    "mandatoryFlag": "true",
  }
  {
    "serviceName": "Product Service PRASS1",
    "mandatoryFlag": "true",
  }
}
}

```

```

"pricing"
{
  {
    "priority": "2",
    "priceListId": "4368251923",
    "priceListDescription": "Currency_Con_PriceList -1",
    "priceListStartDate": "2022-01-11",
    "priceListEndDate": "2022-02-10",
    "noOfDays": "30",
    "priceItemCode": "CC_021",
    "priceitemDescr": "CC_21-Account Opening Fee",
    "priceAsgnId": "4360009281",
    "validityFlag": "",
    "sourceEntityType": "",
    "sourceEntityCode": "",
    "priceListInfo": "",
    "priceComponent":
    {
      "priceCompId": "4367475002",
      "pricecomptier"
      {
        "priceCompSequenceNo": "",
        "businessObjectDataArea": "",
        "priceItemParmGroupId": "",
        "toVal": "",
        "fromVal": "",
        "timeOfUse": "",
        "priceItemCode": "",
        "priceCriteria": "",
        "priceCompId": "",
        "tieSeqNum": "",
        "version": "",
      }
      "priceComponentDescription": "",
      "valueAmt": "",
      "priceComponentDisplay": "",
      "rcMapId": "",
      "tieredFlag": "",
      "priceCompSequenceNo2": "",
    }
  }
  {
    "priority": "2",
    "priceListId": "4368251923",
    "priceListDescription": "Currency_Con_PriceList -1",
    "priceListStartDate": "2022-01-11",
    "priceListEndDate": "2022-02-10",
    "noOfDays": "30",
    "priceItemCode": "CC_022",
    "priceitemDescr": "CC2-Monthly Acct Serv Fee",
    "priceAsgnId": "4360009282",
    "validityFlag": "",
    "sourceEntityType": "",
    "sourceEntityCode": "",
    "priceListInfo": "",
    "priceComponent":
    {
      "priceCompId": "4367475004",
      "pricecomptier"
      {
        "priceCompSequenceNo": "",
        "businessObjectDataArea": "",
        "priceItemParmGroupId": "",
        "toVal": "",

```

```

        "fromVal": "",
        "timeOfUse": "",
        "priceItemCode": "",
        "priceCriteria": "",
        "priceCompId": "",
        "tieSeqNum": "",
        "version": "",
    }
    "priceComponentDescription": "FLAT",
    "valueAmt": "0.60000000000000000000",
    "priceComponentDisplay": "false",
    "rcMapId": "",
    "tieredFlag": "",
    "priceCompSequenceNo2": "0",
}
}
}
"priority": "2",
"priceListId": "4368251923",
"priceListDescription": "Currency_Con_PriceList -1",
"priceListStartDate": "2022-01-11",
"priceListEndDate": "2022-02-10",
"noOfDays": "30",
"priceItemCode": "CC_024",
"priceitemDescr": "CC3-SEPA Transfers",
"priceAsgnId": "4360009283",
"validityFlag": "",
"sourceEntityType": "",
"sourceEntityCode": "",
"priceListInfo": "",
"priceComponent":
{
    "priceCompId": "4367475006",
    "pricecomptier"
    {
        "priceCompSequenceNo": "",
        "businessObjectDataArea": "",
        "priceItemParmGroupId": "",
        "toVal": "",
        "fromVal": "",
        "timeOfUse": "",
        "priceItemCode": "",
        "priceCriteria": "",
        "priceCompId": "",
        "tieSeqNum": "",
        "version": "",
    }
    "priceComponentDescription": "FLAT",
    "valueAmt": "0.25000000000000000000",
    "priceComponentDisplay": "false",
    "rcMapId": "",
    "tieredFlag": "",
    "priceCompSequenceNo2": "0",
}
}
}
"priority": "2",
"priceListId": "4368251923",
"priceListDescription": "Currency_Con_PriceList -1",
"priceListStartDate": "2022-01-11",
"priceListEndDate": "2022-02-10",
"noOfDays": "30",
"priceItemCode": "CC_025",
"priceitemDescr": "CC4-Domestic Funds Transfer Fee",

```

```

"priceAsgnId": "4360009284",
"validityFlag": "",
"sourceEntityType": "",
"sourceEntityCode": "",
"priceListInfo": "",
"priceComponent":
{
  "priceCompId": "4367475008",
  "pricecomptier"
  {
    "priceCompSequenceNo": "",
    "businessObjectDataArea": "",
    "priceItemParmGroupId": "",
    "toVal": "",
    "fromVal": "",
    "timeOfUse": "",
    "priceItemCode": "",
    "priceCriteria": "",
    "priceCompId": "",
    "tieSeqNum": "",
    "version": "",
  }
  "priceComponentDescription": "FLAT",
  "valueAmt": "112.040000000000000000",
  "priceComponentDisplay": "false",
  "rcMapId": "",
  "tieredFlag": "",
  "priceCompSequenceNo2": "0",
}
}
{
"priority": "1",
"priceListId": "5417730766",
"priceListDescription": "PriceList -1",
"priceListStartDate": "2022-01-11",
"priceListEndDate": "2022-02-28",
"noOfDays": "",
"priceItemCode": "PI_021",
"priceitemDescr": "V1-Account Opening Fee",
"priceAsgnId": "5410009202",
"validityFlag": "",
"sourceEntityType": "",
"sourceEntityCode": "",
"priceListInfo": "",
"priceComponent":
{
  "priceCompId": "5417300004",
  "pricecomptier"
  {
    "priceCompSequenceNo": "",
    "businessObjectDataArea": "",
    "priceItemParmGroupId": "",
    "toVal": "",
    "fromVal": "",
    "timeOfUse": "",
    "priceItemCode": "",
    "priceCriteria": "",
    "priceCompId": "",
    "tieSeqNum": "",
    "version": "",
  }
  "priceComponentDescription": "FLAT",
  "valueAmt": "0.250000000000000000",
  "priceComponentDisplay": "false",

```

```

        "rcMapId": "",
        "tieredFlag": "",
        "priceCompSequenceNo2": "0",
    }
}
{
    "priority": "1",
    "priceListId": "5417730766",
    "priceListDescription": "PriceList -1",
    "priceListStartDate": "2022-01-11",
    "priceListEndDate": "2022-02-28",
    "noOfDays": "",
    "priceItemCode": "PI_022",
    "priceitemDescr": "V2-Monthly Acct Serv Fee",
    "priceAsgnId": "5410009203",
    "validityFlag": "",
    "sourceEntityType": "",
    "sourceEntityCode": "",
    "priceListInfo": "",
    "priceComponent":
    {
        "priceCompId": "5417300006",
        "pricecomptier"
        {
            "priceCompSequenceNo": "",
            "businessObjectDataArea": "",
            "priceItemParmGroupId": "",
            "toVal": "",
            "fromVal": "",
            "timeOfUse": "",
            "priceItemCode": "",
            "priceCriteria": "",
            "priceCompId": "",
            "tieSeqNum": "",
            "version": "",
        }
        "priceComponentDescription": "FLAT",
        "valueAmt": "112.040000000000000000",
        "priceComponentDisplay": "false",
        "rcMapId": "",
        "tieredFlag": "",
        "priceCompSequenceNo2": "0",
    }
}
{
    "priority": "1",
    "priceListId": "5417730766",
    "priceListDescription": "PriceList -1",
    "priceListStartDate": "2022-01-11",
    "priceListEndDate": "2022-02-28",
    "noOfDays": "",
    "priceItemCode": "PI_021",
    "priceitemDescr": "V1-Account Opening Fee",
    "priceAsgnId": "5410009202",
    "validityFlag": "",
    "sourceEntityType": "",
    "sourceEntityCode": "",
    "priceListInfo": "",
    "priceComponent":
    {
        "priceCompId": "5417300004",
        "pricecomptier"
        {
            "priceCompSequenceNo": "",

```

```

        "businessObjectDataArea": "",
        "priceItemParmGroupId": "",
        "toVal": "",
        "fromVal": "",
        "timeOfUse": "",
        "priceItemCode": "",
        "priceCriteria": "",
        "priceCompId": "",
        "tieSeqNum": "",
        "version": "",
    }
    "priceComponentDescription": "FLAT",
    "valueAmt": "0.250000000000000000",
    "priceComponentDisplay": "false",
    "rcMapId": "",
    "tieredFlag": "",
    "priceCompSequenceNo2": "0",
}
}
{
    "priority": "1",
    "priceListId": "5417730766",
    "priceListDescription": "PriceList -1",
    "priceListStartDate": "2022-01-11",
    "priceListEndDate": "2022-02-28",
    "noOfDays": "",
    "priceItemCode": "PI_022",
    "priceitemDescr": "V2-Monthly Acct Serv Fee",
    "priceAsgnId": "5410009203",
    "validityFlag": "",
    "sourceEntityType": "",
    "sourceEntityCode": "",
    "priceListInfo": "",
    "priceComponent":
    {
        "priceCompId": "5417300006",
        "pricecomptier"
        {
            "priceCompSequenceNo": "",
            "businessObjectDataArea": "",
            "priceItemParmGroupId": "",
            "toVal": "",
            "fromVal": "",
            "timeOfUse": "",
            "priceItemCode": "",
            "priceCriteria": "",
            "priceCompId": "",
            "tieSeqNum": "",
            "version": "",
        }
    }
    "priceComponentDescription": "FLAT",
    "valueAmt": "112.040000000000000000",
    "priceComponentDisplay": "false",
    "rcMapId": "",
    "tieredFlag": "",
    "priceCompSequenceNo2": "0",
}
}
{
    "priority": "1",
    "priceListId": "5417730766",
    "priceListDescription": "PriceList -1",
    "priceListStartDate": "2022-01-11",
    "priceListEndDate": "2022-02-28",

```

```

    "noOfDays": "",
    "priceItemCode": "PI_023",
    "priceitemDescr": "V3-Audit Reports",
    "priceAsgnId": "5410009204",
    "validityFlag": "",
    "sourceEntityType": "",
    "sourceEntityCode": "",
    "priceListInfo": "",
    "priceComponent":
    {
      "priceCompId": "5417300008",
      "pricecomptier"
      {
        "priceCompSequenceNo": "",
        "businessObjectDataArea": "",
        "priceItemParmGroupId": "",
        "toVal": "",
        "fromVal": "",
        "timeOfUse": "",
        "priceItemCode": "",
        "priceCriteria": "",
        "priceCompId": "",
        "tieSeqNum": "",
        "version": "",
      }
      "priceComponentDescription": "FLAT",
      "valueAmt": "276.25000000000000000000",
      "priceComponentDisplay": "false",
      "rcMapId": "",
      "tieredFlag": "",
      "priceCompSequenceNo2": "0",
    }
  }
  {
    "priority": "1",
    "priceListId": "5417730766",
    "priceListDescription": "PriceList -1",
    "priceListStartDate": "2022-01-11",
    "priceListEndDate": "2022-02-28",
    "noOfDays": "",
    "priceItemCode": "PI_024",
    "priceitemDescr": "V4-SEPA Transfers",
    "priceAsgnId": "5410009241",
    "validityFlag": "",
    "sourceEntityType": "",
    "sourceEntityCode": "",
    "priceListInfo": "",
    "priceComponent":
    {
      "priceCompId": "5417400004",
      "pricecomptier"
      {
        "priceCompSequenceNo": "0",
        "businessObjectDataArea": "",
        "priceItemParmGroupId": "1",
        "toVal": "1000.00000000000000000000",
        "fromVal": "0.00000000000000000000",
        "timeOfUse": "",
        "priceItemCode": "PI_024",
        "priceCriteria": "NBRTRAN",
        "priceCompId": "",
        "tieSeqNum": "10",
        "version": "0",
      }
    }
  }

```

```

    {
      "priceCompSequenceNo": "0",
      "businessObjectDataArea": "",
      "priceItemParmGroupId": "1",
      "toVal": "5000.0000000000000000000000",
      "fromVal": "1000.0000000000000000000000",
      "timeOfUse": "",
      "priceItemCode": "PI_024",
      "priceCriteria": "NBRTRAN",
      "priceCompId": "",
      "tieSeqNum": "10",
      "version": "0",
    }
  }
  {
    "priceCompSequenceNo": "0",
    "businessObjectDataArea": "",
    "priceItemParmGroupId": "1",
    "toVal": "999999999999.9900000000000000000000",
    "fromVal": "5000.0000000000000000000000",
    "timeOfUse": "",
    "priceItemCode": "PI_024",
    "priceCriteria": "NBRTRAN",
    "priceCompId": "",
    "tieSeqNum": "10",
    "version": "0",
  }
}
"priceComponentDescription": "Price per transaction - Step Tier 1",
"valueAmt": "12.9500000000000000000000",
"priceComponentDisplay": "false",
"rcMapId": "",
"tieredFlag": "",
"priceCompSequenceNo2": "0",
}
{
  "priceCompId": "5417400005",
  "pricecomptier"
  {
    "priceCompSequenceNo": "0",
    "businessObjectDataArea": "",
    "priceItemParmGroupId": "1",
    "toVal": "1000.0000000000000000000000",
    "fromVal": "0.0000000000000000000000",
    "timeOfUse": "",
    "priceItemCode": "PI_024",
    "priceCriteria": "NBRTRAN",
    "priceCompId": "",
    "tieSeqNum": "10",
    "version": "0",
  }
}
  {
    "priceCompSequenceNo": "0",
    "businessObjectDataArea": "",
    "priceItemParmGroupId": "1",
    "toVal": "5000.0000000000000000000000",
    "fromVal": "1000.0000000000000000000000",
    "timeOfUse": "",
    "priceItemCode": "PI_024",
    "priceCriteria": "NBRTRAN",
    "priceCompId": "",
    "tieSeqNum": "10",
    "version": "0",
  }
}
}

```



```

        "priceCompSequenceNo": "0",
        "businessObjectDataArea": "",
        "priceItemParmGroupId": "1",
        "toVal": "999999999999.99000000000000000000",
        "fromVal": "5000.00000000000000000000",
        "timeOfUse": "",
        "priceItemCode": "PI_024",
        "priceCriteria": "NBRTRAN",
        "priceCompId": "",
        "tieSeqNum": "10",
        "version": "0",
    }
}
"priceComponentDescription": "Price per transaction - Step Tier 2",
"valueAmt": "12.150000000000000000",
"priceComponentDisplay": "false",
"rcMapId": "",
"tieredFlag": "",
"priceCompSequenceNo2": "0",
}
{
    "priceCompId": "5417400006",
    "pricecomptier"
    {
        "priceCompSequenceNo": "0",
        "businessObjectDataArea": "",
        "priceItemParmGroupId": "1",
        "toVal": "1000.00000000000000000000",
        "fromVal": "0.00000000000000000000",
        "timeOfUse": "",
        "priceItemCode": "PI_024",
        "priceCriteria": "NBRTRAN",
        "priceCompId": "",
        "tieSeqNum": "10",
        "version": "0",
    }
}
    "priceCompSequenceNo": "0",
    "businessObjectDataArea": "",
    "priceItemParmGroupId": "1",
    "toVal": "5000.00000000000000000000",
    "fromVal": "1000.00000000000000000000",
    "timeOfUse": "",
    "priceItemCode": "PI_024",
    "priceCriteria": "NBRTRAN",
    "priceCompId": "",
    "tieSeqNum": "10",
    "version": "0",
}
}
    "priceCompSequenceNo": "0",
    "businessObjectDataArea": "",
    "priceItemParmGroupId": "1",
    "toVal": "999999999999.99000000000000000000",
    "fromVal": "5000.00000000000000000000",
    "timeOfUse": "",
    "priceItemCode": "PI_024",
    "priceCriteria": "NBRTRAN",
    "priceCompId": "",
    "tieSeqNum": "10",
    "version": "0",
}
}
"priceComponentDescription": "Price per transaction - Step Tier 3",

```

```

"valueAmt": "11.950000000000000000",
"priceComponentDisplay": "false",
"rcMapId": "",
"tieredFlag": "",
"priceCompSequenceNo2": "0",
}
}
{
"priority": "1",
"priceListId": "5417730766",
"priceListDescription": "PriceList -1",
"priceListStartDate": "2022-01-11",
"priceListEndDate": "2022-02-28",
"noOfDays": "",
"priceItemCode": "PI_025",
"priceitemDescr": "V5-Domestic Funds Transfer Fee",
"priceAsgnId": "5410009242",
"validityFlag": "",
"sourceEntityType": "",
"sourceEntityCode": "",
"priceListInfo": "",
"priceComponent":
{
"priceCompId": "5417400010",
"pricecomptier"
{
"priceCompSequenceNo": "0",
"businessObjectDataArea": "",
"priceItemParmGroupId": "1",
"toVal": "1000.000000000000000000",
"fromVal": "0.000000000000000000",
"timeOfUse": "",
"priceItemCode": "PI_025",
"priceCriteria": "NBRTRAN",
"priceCompId": "",
"tieSeqNum": "10",
"version": "0",
}
}
{
"priceCompSequenceNo": "0",
"businessObjectDataArea": "",
"priceItemParmGroupId": "1",
"toVal": "5000.000000000000000000",
"fromVal": "1000.000000000000000000",
"timeOfUse": "",
"priceItemCode": "PI_025",
"priceCriteria": "NBRTRAN",
"priceCompId": "",
"tieSeqNum": "10",
"version": "0",
}
}
{
"priceCompSequenceNo": "0",
"businessObjectDataArea": "",
"priceItemParmGroupId": "1",
"toVal": "999999999999.990000000000000000",
"fromVal": "5000.000000000000000000",
"timeOfUse": "",
"priceItemCode": "PI_025",
"priceCriteria": "NBRTRAN",
"priceCompId": "",
"tieSeqNum": "10",
"version": "0",
}
}
}
}

```

```

    }
    "priceComponentDescription": "Threshold price per transaction",
    "valueAmt": "12.950000000000000000",
    "priceComponentDisplay": "false",
    "rcMapId": "",
    "tieredFlag": "",
    "priceCompSequenceNo2": "0",
  }
  {
    "priceCompId": "5417400011",
    "pricemcptier"
    {
      "priceCompSequenceNo": "0",
      "businessObjectDataArea": "",
      "priceItemParmGroupId": "1",
      "toVal": "1000.000000000000000000",
      "fromVal": "0.000000000000000000",
      "timeOfUse": "",
      "priceItemCode": "PI_025",
      "priceCriteria": "NBRTRAN",
      "priceCompId": "",
      "tieSeqNum": "10",
      "version": "0",
    }
  }
  {
    "priceCompSequenceNo": "0",
    "businessObjectDataArea": "",
    "priceItemParmGroupId": "1",
    "toVal": "5000.000000000000000000",
    "fromVal": "1000.000000000000000000",
    "timeOfUse": "",
    "priceItemCode": "PI_025",
    "priceCriteria": "NBRTRAN",
    "priceCompId": "",
    "tieSeqNum": "10",
    "version": "0",
  }
  {
    "priceCompSequenceNo": "0",
    "businessObjectDataArea": "",
    "priceItemParmGroupId": "1",
    "toVal": "999999999999.990000000000000000",
    "fromVal": "5000.000000000000000000",
    "timeOfUse": "",
    "priceItemCode": "PI_025",
    "priceCriteria": "NBRTRAN",
    "priceCompId": "",
    "tieSeqNum": "10",
    "version": "0",
  }
  }
  "priceComponentDescription": "Threshold price per transaction",
  "valueAmt": "12.150000000000000000",
  "priceComponentDisplay": "false",
  "rcMapId": "",
  "tieredFlag": "",
  "priceCompSequenceNo2": "0",
}
{
  "priceCompId": "5417400012",
  "pricemcptier"
  {
    "priceCompSequenceNo": "0",
    "businessObjectDataArea": "",

```



```

    "priceCompSequenceNo": "0",
    "businessObjectDataArea": "",
    "priceItemParmGroupId": "1",
    "toVal": "1000.00000000000000000000",
    "fromVal": "0.00000000000000000000",
    "timeOfUse": "",
    "priceItemCode": "PI_026",
    "priceCriteria": "NBRTRAN",
    "priceCompId": "",
    "tieSeqNum": "10",
    "version": "0",
  }
  {
    "priceCompSequenceNo": "0",
    "businessObjectDataArea": "",
    "priceItemParmGroupId": "1",
    "toVal": "5000.00000000000000000000",
    "fromVal": "1000.00000000000000000000",
    "timeOfUse": "",
    "priceItemCode": "PI_026",
    "priceCriteria": "NBRTRAN",
    "priceCompId": "",
    "tieSeqNum": "10",
    "version": "0",
  }
  {
    "priceCompSequenceNo": "0",
    "businessObjectDataArea": "",
    "priceItemParmGroupId": "1",
    "toVal": "999999999999.99000000000000000000",
    "fromVal": "5000.00000000000000000000",
    "timeOfUse": "",
    "priceItemCode": "PI_026",
    "priceCriteria": "NBRTRAN",
    "priceCompId": "",
    "tieSeqNum": "10",
    "version": "0",
  }
  {
    "priceCompSequenceNo": "0",
    "businessObjectDataArea": "",
    "priceItemParmGroupId": "1",
    "toVal": "1000.00000000000000000000",
    "fromVal": "0.00000000000000000000",
    "timeOfUse": "",
    "priceItemCode": "PI_026",
    "priceCriteria": "NBRTRAN",
    "priceCompId": "",
    "tieSeqNum": "10",
    "version": "0",
  }
  {
    "priceCompSequenceNo": "0",
    "businessObjectDataArea": "",
    "priceItemParmGroupId": "1",
    "toVal": "5000.00000000000000000000",
    "fromVal": "1000.00000000000000000000",
    "timeOfUse": "",
    "priceItemCode": "PI_026",
    "priceCriteria": "NBRTRAN",
    "priceCompId": "",
    "tieSeqNum": "10",
    "version": "0",
  }
}

```

```

    {
      "priceCompSequenceNo": "0",
      "businessObjectDataArea": "",
      "priceItemParmGroupId": "1",
      "toVal": "999999999999.99000000000000000000",
      "fromVal": "5000.00000000000000000000",
      "timeOfUse": "",
      "priceItemCode": "PI_026",
      "priceCriteria": "NBRTRAN",
      "priceCompId": "",
      "tieSeqNum": "10",
      "version": "0",
    }
    "priceComponentDescription": "Basic charges",
    "valueAmt": "20.00000000000000000000",
    "priceComponentDisplay": "false",
    "rcMapId": "",
    "tieredFlag": "",
    "priceCompSequenceNo2": "0",
  }
}
{
  "priceCompId": "5417400021",
  "pricecomptier"
  {
    "priceCompSequenceNo": "0",
    "businessObjectDataArea": "",
    "priceItemParmGroupId": "1",
    "toVal": "1000.00000000000000000000",
    "fromVal": "0.00000000000000000000",
    "timeOfUse": "",
    "priceItemCode": "PI_026",
    "priceCriteria": "NBRTRAN",
    "priceCompId": "",
    "tieSeqNum": "10",
    "version": "0",
  }
}
{
  "priceCompSequenceNo": "0",
  "businessObjectDataArea": "",
  "priceItemParmGroupId": "1",
  "toVal": "5000.00000000000000000000",
  "fromVal": "1000.00000000000000000000",
  "timeOfUse": "",
  "priceItemCode": "PI_026",
  "priceCriteria": "NBRTRAN",
  "priceCompId": "",
  "tieSeqNum": "10",
  "version": "0",
}
}
{
  "priceCompSequenceNo": "0",
  "businessObjectDataArea": "",
  "priceItemParmGroupId": "1",
  "toVal": "999999999999.99000000000000000000",
  "fromVal": "5000.00000000000000000000",
  "timeOfUse": "",
  "priceItemCode": "PI_026",
  "priceCriteria": "NBRTRAN",
  "priceCompId": "",
  "tieSeqNum": "10",
  "version": "0",
}
}
}

```

```

        "priceCompSequenceNo": "0",
        "businessObjectDataArea": "",
        "priceItemParmGroupId": "1",
        "toVal": "1000.00000000000000000000",
        "fromVal": "0.00000000000000000000",
        "timeOfUse": "",
        "priceItemCode": "PI_026",
        "priceCriteria": "NBRTRAN",
        "priceCompId": "",
        "tieSeqNum": "10",
        "version": "0",
    }
}
    "priceCompSequenceNo": "0",
    "businessObjectDataArea": "",
    "priceItemParmGroupId": "1",
    "toVal": "5000.00000000000000000000",
    "fromVal": "1000.00000000000000000000",
    "timeOfUse": "",
    "priceItemCode": "PI_026",
    "priceCriteria": "NBRTRAN",
    "priceCompId": "",
    "tieSeqNum": "10",
    "version": "0",
}
}
    "priceCompSequenceNo": "0",
    "businessObjectDataArea": "",
    "priceItemParmGroupId": "1",
    "toVal": "999999999999.99000000000000000000",
    "fromVal": "5000.00000000000000000000",
    "timeOfUse": "",
    "priceItemCode": "PI_026",
    "priceCriteria": "NBRTRAN",
    "priceCompId": "",
    "tieSeqNum": "10",
    "version": "0",
}
    "priceComponentDescription": "Threshold price",
    "valueAmt": "10.00000000000000000000",
    "priceComponentDisplay": "false",
    "rcMapId": "",
    "tieredFlag": "",
    "priceCompSequenceNo2": "0",
}
}
{
    "priceCompId": "5417400022",
    "priccomptier"
    {
        "priceCompSequenceNo": "0",
        "businessObjectDataArea": "",
        "priceItemParmGroupId": "1",
        "toVal": "1000.00000000000000000000",
        "fromVal": "0.00000000000000000000",
        "timeOfUse": "",
        "priceItemCode": "PI_026",
        "priceCriteria": "NBRTRAN",
        "priceCompId": "",
        "tieSeqNum": "10",
        "version": "0",
    }
}
    "priceCompSequenceNo": "0",

```

```

        "businessObjectDataArea": "",
        "priceItemParmGroupId": "1",
        "toVal": "5000.000000000000000000000000",
        "fromVal": "1000.000000000000000000000000",
        "timeOfUse": "",
        "priceItemCode": "PI_026",
        "priceCriteria": "NBRTRAN",
        "priceCompId": "",
        "tieSeqNum": "10",
        "version": "0",
    }
}
    "priceCompSequenceNo": "0",
    "businessObjectDataArea": "",
    "priceItemParmGroupId": "1",
    "toVal": "999999999999.990000000000000000000000",
    "fromVal": "5000.000000000000000000000000",
    "timeOfUse": "",
    "priceItemCode": "PI_026",
    "priceCriteria": "NBRTRAN",
    "priceCompId": "",
    "tieSeqNum": "10",
    "version": "0",
}
}
    "priceCompSequenceNo": "0",
    "businessObjectDataArea": "",
    "priceItemParmGroupId": "1",
    "toVal": "1000.000000000000000000000000",
    "fromVal": "0.000000000000000000000000",
    "timeOfUse": "",
    "priceItemCode": "PI_026",
    "priceCriteria": "NBRTRAN",
    "priceCompId": "",
    "tieSeqNum": "10",
    "version": "0",
}
}
    "priceCompSequenceNo": "0",
    "businessObjectDataArea": "",
    "priceItemParmGroupId": "1",
    "toVal": "5000.000000000000000000000000",
    "fromVal": "1000.000000000000000000000000",
    "timeOfUse": "",
    "priceItemCode": "PI_026",
    "priceCriteria": "NBRTRAN",
    "priceCompId": "",
    "tieSeqNum": "10",
    "version": "0",
}
}
    "priceCompSequenceNo": "0",
    "businessObjectDataArea": "",
    "priceItemParmGroupId": "1",
    "toVal": "999999999999.990000000000000000000000",
    "fromVal": "5000.000000000000000000000000",
    "timeOfUse": "",
    "priceItemCode": "PI_026",
    "priceCriteria": "NBRTRAN",
    "priceCompId": "",
    "tieSeqNum": "10",
    "version": "0",
}
}
    "priceComponentDescription": "Threshold price",

```



```

"valueAmt": "8.000000000000000000",
"priceComponentDisplay": "false",
"rcMapId": "",
"tieredFlag": "",
"priceCompSequenceNo2": "0",
}
{
  "priceCompId": "5417400023",
  "pricecomptier"
  {
    "priceCompSequenceNo": "0",
    "businessObjectDataArea": "",
    "priceItemParmGroupId": "1",
    "toVal": "1000.000000000000000000",
    "fromVal": "0.000000000000000000",
    "timeOfUse": "",
    "priceItemCode": "PI_026",
    "priceCriteria": "NBRTRAN",
    "priceCompId": "",
    "tieSeqNum": "10",
    "version": "0",
  }
  {
    "priceCompSequenceNo": "0",
    "businessObjectDataArea": "",
    "priceItemParmGroupId": "1",
    "toVal": "5000.000000000000000000",
    "fromVal": "1000.000000000000000000",
    "timeOfUse": "",
    "priceItemCode": "PI_026",
    "priceCriteria": "NBRTRAN",
    "priceCompId": "",
    "tieSeqNum": "10",
    "version": "0",
  }
  {
    "priceCompSequenceNo": "0",
    "businessObjectDataArea": "",
    "priceItemParmGroupId": "1",
    "toVal": "99999999999.990000000000000000",
    "fromVal": "5000.000000000000000000",
    "timeOfUse": "",
    "priceItemCode": "PI_026",
    "priceCriteria": "NBRTRAN",
    "priceCompId": "",
    "tieSeqNum": "10",
    "version": "0",
  }
  {
    "priceCompSequenceNo": "0",
    "businessObjectDataArea": "",
    "priceItemParmGroupId": "1",
    "toVal": "1000.000000000000000000",
    "fromVal": "0.000000000000000000",
    "timeOfUse": "",
    "priceItemCode": "PI_026",
    "priceCriteria": "NBRTRAN",
    "priceCompId": "",
    "tieSeqNum": "10",
    "version": "0",
  }
  {
    "priceCompSequenceNo": "0",
    "businessObjectDataArea": "",
  }

```

```

        "priceItemParmGroupId": "1",
        "toVal": "5000.00000000000000000000",
        "fromVal": "1000.00000000000000000000",
        "timeOfUse": "",
        "priceItemCode": "PI_026",
        "priceCriteria": "NBRTRAN",
        "priceCompId": "",
        "tieSeqNum": "10",
        "version": "0",
    }
    {
        "priceCompSequenceNo": "0",
        "businessObjectDataArea": "",
        "priceItemParmGroupId": "1",
        "toVal": "999999999999.99000000000000000000",
        "fromVal": "5000.00000000000000000000",
        "timeOfUse": "",
        "priceItemCode": "PI_026",
        "priceCriteria": "NBRTRAN",
        "priceCompId": "",
        "tieSeqNum": "10",
        "version": "0",
    }
    "priceComponentDescription": "Threshold price",
    "valueAmt": "6.00000000000000000000",
    "priceComponentDisplay": "false",
    "rcMapId": "",
    "tieredFlag": "",
    "priceCompSequenceNo2": "0",
    }
    {
        "priceCompId": "5417400024",
        "pricecomptier"
        {
            "priceCompSequenceNo": "0",
            "businessObjectDataArea": "",
            "priceItemParmGroupId": "1",
            "toVal": "1000.00000000000000000000",
            "fromVal": "0.00000000000000000000",
            "timeOfUse": "",
            "priceItemCode": "PI_026",
            "priceCriteria": "NBRTRAN",
            "priceCompId": "",
            "tieSeqNum": "10",
            "version": "0",
        }
        {
            "priceCompSequenceNo": "0",
            "businessObjectDataArea": "",
            "priceItemParmGroupId": "1",
            "toVal": "5000.00000000000000000000",
            "fromVal": "1000.00000000000000000000",
            "timeOfUse": "",
            "priceItemCode": "PI_026",
            "priceCriteria": "NBRTRAN",
            "priceCompId": "",
            "tieSeqNum": "10",
            "version": "0",
        }
        {
            "priceCompSequenceNo": "0",
            "businessObjectDataArea": "",
            "priceItemParmGroupId": "1",
            "toVal": "999999999999.99000000000000000000",

```

```

    "fromVal": "5000.00000000000000000000",
    "timeOfUse": "",
    "priceItemCode": "PI_026",
    "priceCriteria": "NBRTRAN",
    "priceCompId": "",
    "tieSeqNum": "10",
    "version": "0",
  }
  {
    "priceCompSequenceNo": "0",
    "businessObjectDataArea": "",
    "priceItemParmGroupId": "1",
    "toVal": "1000.00000000000000000000",
    "fromVal": "0.00000000000000000000",
    "timeOfUse": "",
    "priceItemCode": "PI_026",
    "priceCriteria": "NBRTRAN",
    "priceCompId": "",
    "tieSeqNum": "10",
    "version": "0",
  }
  {
    "priceCompSequenceNo": "0",
    "businessObjectDataArea": "",
    "priceItemParmGroupId": "1",
    "toVal": "5000.00000000000000000000",
    "fromVal": "1000.00000000000000000000",
    "timeOfUse": "",
    "priceItemCode": "PI_026",
    "priceCriteria": "NBRTRAN",
    "priceCompId": "",
    "tieSeqNum": "10",
    "version": "0",
  }
  {
    "priceCompSequenceNo": "0",
    "businessObjectDataArea": "",
    "priceItemParmGroupId": "1",
    "toVal": "999999999999.99000000000000000000",
    "fromVal": "5000.00000000000000000000",
    "timeOfUse": "",
    "priceItemCode": "PI_026",
    "priceCriteria": "NBRTRAN",
    "priceCompId": "",
    "tieSeqNum": "10",
    "version": "0",
  }
  "priceComponentDescription": "Step 1",
  "valueAmt": "5.00000000000000000000",
  "priceComponentDisplay": "false",
  "rcMapId": "",
  "tieredFlag": "",
  "priceCompSequenceNo2": "0",
}
{
  "priceCompId": "5417400025",
  "pricemcptier"
  {
    "priceCompSequenceNo": "0",
    "businessObjectDataArea": "",
    "priceItemParmGroupId": "1",
    "toVal": "1000.00000000000000000000",
    "fromVal": "0.00000000000000000000",
    "timeOfUse": "",

```

```

        "priceItemCode": "PI_026",
        "priceCriteria": "NBRTRAN",
        "priceCompId": "",
        "tieSeqNum": "10",
        "version": "0",
    }
}
{
    "priceCompSequenceNo": "0",
    "businessObjectDataArea": "",
    "priceItemParmGroupId": "1",
    "toVal": "5000.000000000000000000000000",
    "fromVal": "1000.0000000000000000000000",
    "timeOfUse": "",
    "priceItemCode": "PI_026",
    "priceCriteria": "NBRTRAN",
    "priceCompId": "",
    "tieSeqNum": "10",
    "version": "0",
}
{
    "priceCompSequenceNo": "0",
    "businessObjectDataArea": "",
    "priceItemParmGroupId": "1",
    "toVal": "999999999999.99000000000000000000",
    "fromVal": "5000.0000000000000000000000",
    "timeOfUse": "",
    "priceItemCode": "PI_026",
    "priceCriteria": "NBRTRAN",
    "priceCompId": "",
    "tieSeqNum": "10",
    "version": "0",
}
{
    "priceCompSequenceNo": "0",
    "businessObjectDataArea": "",
    "priceItemParmGroupId": "1",
    "toVal": "1000.0000000000000000000000",
    "fromVal": "0.000000000000000000000000",
    "timeOfUse": "",
    "priceItemCode": "PI_026",
    "priceCriteria": "NBRTRAN",
    "priceCompId": "",
    "tieSeqNum": "10",
    "version": "0",
}
{
    "priceCompSequenceNo": "0",
    "businessObjectDataArea": "",
    "priceItemParmGroupId": "1",
    "toVal": "5000.0000000000000000000000",
    "fromVal": "1000.0000000000000000000000",
    "timeOfUse": "",
    "priceItemCode": "PI_026",
    "priceCriteria": "NBRTRAN",
    "priceCompId": "",
    "tieSeqNum": "10",
    "version": "0",
}
{
    "priceCompSequenceNo": "0",
    "businessObjectDataArea": "",
    "priceItemParmGroupId": "1",
    "toVal": "999999999999.99000000000000000000",
    "fromVal": "5000.0000000000000000000000",
}

```

```

        "timeOfUse": "",
        "priceItemCode": "PI_026",
        "priceCriteria": "NBRTRAN",
        "priceCompId": "",
        "tieSeqNum": "10",
        "version": "0",
    }
    "priceComponentDescription": "Step 2",
    "valueAmt": "4.000000000000000000",
    "priceComponentDisplay": "false",
    "rcMapId": "",
    "tieredFlag": "",
    "priceCompSequenceNo2": "0",
}
{
    "priceCompId": "5417400026",
    "pricecomptier"
    {
        "priceCompSequenceNo": "0",
        "businessObjectDataArea": "",
        "priceItemParmGroupId": "1",
        "toVal": "1000.000000000000000000",
        "fromVal": "0.000000000000000000",
        "timeOfUse": "",
        "priceItemCode": "PI_026",
        "priceCriteria": "NBRTRAN",
        "priceCompId": "",
        "tieSeqNum": "10",
        "version": "0",
    }
}
{
    "priceCompSequenceNo": "0",
    "businessObjectDataArea": "",
    "priceItemParmGroupId": "1",
    "toVal": "5000.000000000000000000",
    "fromVal": "1000.000000000000000000",
    "timeOfUse": "",
    "priceItemCode": "PI_026",
    "priceCriteria": "NBRTRAN",
    "priceCompId": "",
    "tieSeqNum": "10",
    "version": "0",
}
}
{
    "priceCompSequenceNo": "0",
    "businessObjectDataArea": "",
    "priceItemParmGroupId": "1",
    "toVal": "999999999999.990000000000000000",
    "fromVal": "5000.000000000000000000",
    "timeOfUse": "",
    "priceItemCode": "PI_026",
    "priceCriteria": "NBRTRAN",
    "priceCompId": "",
    "tieSeqNum": "10",
    "version": "0",
}
}
{
    "priceCompSequenceNo": "0",
    "businessObjectDataArea": "",
    "priceItemParmGroupId": "1",
    "toVal": "1000.000000000000000000",
    "fromVal": "0.000000000000000000",
    "timeOfUse": "",
    "priceItemCode": "PI_026",

```

```

        "priceCriteria": "NBRTRAN",
        "priceCompId": "",
        "tieSeqNum": "10",
        "version": "0",
    }
}
{
    "priceCompSequenceNo": "0",
    "businessObjectDataArea": "",
    "priceItemParmGroupId": "1",
    "toVal": "5000.00000000000000000000",
    "fromVal": "1000.00000000000000000000",
    "timeOfUse": "",
    "priceItemCode": "PI_026",
    "priceCriteria": "NBRTRAN",
    "priceCompId": "",
    "tieSeqNum": "10",
    "version": "0",
}
}
{
    "priceCompSequenceNo": "0",
    "businessObjectDataArea": "",
    "priceItemParmGroupId": "1",
    "toVal": "99999999999.99000000000000000000",
    "fromVal": "5000.00000000000000000000",
    "timeOfUse": "",
    "priceItemCode": "PI_026",
    "priceCriteria": "NBRTRAN",
    "priceCompId": "",
    "tieSeqNum": "10",
    "version": "0",
}
}
"priceComponentDescription": "Step 3",
"valueAmt": "3.00000000000000000000",
"priceComponentDisplay": "false",
"rcMapId": "",
"tieredFlag": "",
"priceCompSequenceNo2": "0",
}
}
{
    "priority": "1",
    "priceListId": "5417730766",
    "priceListDescription": "PriceList -1",
    "priceListStartDate": "2022-01-11",
    "priceListEndDate": "2022-02-28",
    "noOfDays": "",
    "priceItemCode": "PI_027",
    "priceitemDescr": "V7-Direct Debit",
    "priceAsgnId": "5410009209",
    "validityFlag": "",
    "sourceEntityType": "",
    "sourceEntityCode": "",
    "priceListInfo": "",
    "priceComponent":
    {
        "priceCompId": "5417300038",
        "priccomptier"
        {
            "priceCompSequenceNo": "",
            "businessObjectDataArea": "",
            "priceItemParmGroupId": "",
            "toVal": "",
            "fromVal": "",
            "timeOfUse": "",

```

```

        "priceItemCode": "",
        "priceCriteria": "",
        "priceCompId": "",
        "tieSeqNum": "",
        "version": "",
    }
    "priceComponentDescription": "Basic BK-NBR",
    "valueAmt": "0.150000000000000000",
    "priceComponentDisplay": "false",
    "rcMapId": "",
    "tieredFlag": "",
    "priceCompSequenceNo2": "0",
}
}
{
    "priority": "1",
    "priceListId": "5417730766",
    "priceListDescription": "PriceList -1",
    "priceListStartDate": "2022-01-11",
    "priceListEndDate": "2022-02-28",
    "noOfDays": "",
    "priceItemCode": "PI_028",
    "priceitemDescr": "V8-Cheque Collections",
    "priceAsgnId": "5410009210",
    "validityFlag": "",
    "sourceEntityType": "",
    "sourceEntityCode": "",
    "priceListInfo": "",
    "priceComponent":
    {
        "priceCompId": "5417300040",
        "pricemcomptier"
        {
            "priceCompSequenceNo": "",
            "businessObjectDataArea": "",
            "priceItemParmGroupId": "",
            "toVal": "",
            "fromVal": "",
            "timeOfUse": "",
            "priceItemCode": "",
            "priceCriteria": "",
            "priceCompId": "",
            "tieSeqNum": "",
            "version": "",
        }
    }
    "priceComponentDescription": "FLAT",
    "valueAmt": "0.750000000000000000",
    "priceComponentDisplay": "false",
    "rcMapId": "",
    "tieredFlag": "",
    "priceCompSequenceNo2": "0",
}
}
{
    "priority": "1",
    "priceListId": "5417730766",
    "priceListDescription": "PriceList -1",
    "priceListStartDate": "2022-01-11",
    "priceListEndDate": "2022-02-28",
    "noOfDays": "",
    "priceItemCode": "PI_028",
    "priceitemDescr": "V8-Cheque Collections",
    "priceAsgnId": "5410009211",
    "validityFlag": "",

```

```

"sourceEntityType": "",
"sourceEntityCode": "",
"priceListInfo": "",
"priceComponent":
{
  "priceCompId": "5417300042",
  "pricecomptier"
  {
    "priceCompSequenceNo": "",
    "businessObjectDataArea": "",
    "priceItemParmGroupId": "",
    "toVal": "",
    "fromVal": "",
    "timeOfUse": "",
    "priceItemCode": "",
    "priceCriteria": "",
    "priceCompId": "",
    "tieSeqNum": "",
    "version": "",
  }
  "priceComponentDescription": "FLAT",
  "valueAmt": "6.67000000000000000000",
  "priceComponentDisplay": "false",
  "rcMapId": "",
  "tieredFlag": "",
  "priceCompSequenceNo2": "0",
}
}

"priority": "1",
"priceListId": "5417730766",
"priceListDescription": "PriceList -1",
"priceListStartDate": "2022-01-11",
"priceListEndDate": "2022-02-28",
"noOfDays": "",
"priceItemCode": "PI_028",
"priceitemDescr": "V8-Cheque Collections",
"priceAsgnId": "5410009212",
"validityFlag": "",
"sourceEntityType": "",
"sourceEntityCode": "",
"priceListInfo": "",
"priceComponent":
{
  "priceCompId": "5417300044",
  "pricecomptier"
  {
    "priceCompSequenceNo": "",
    "businessObjectDataArea": "",
    "priceItemParmGroupId": "",
    "toVal": "",
    "fromVal": "",
    "timeOfUse": "",
    "priceItemCode": "",
    "priceCriteria": "",
    "priceCompId": "",
    "tieSeqNum": "",
    "version": "",
  }
  "priceComponentDescription": "FLAT",
  "valueAmt": "0.30000000000000000000",
  "priceComponentDisplay": "false",
  "rcMapId": "",
  "tieredFlag": "",

```



```

    "priceCompSequenceNo2": "0",
  }
}
{
  "priority": "1",
  "priceListId": "5417730766",
  "priceListDescription": "PriceList -1",
  "priceListStartDate": "2022-01-11",
  "priceListEndDate": "2022-02-28",
  "noOfDays": "",
  "priceItemCode": "PI_028",
  "priceitemDescr": "V8-Cheque Collections",
  "priceAsgnId": "5410009213",
  "validityFlag": "",
  "sourceEntityType": "",
  "sourceEntityCode": "",
  "priceListInfo": "",
  "priceComponent":
  {
    "priceCompId": "5417300046",
    "pricecomptier"
    {
      "priceCompSequenceNo": "",
      "businessObjectDataArea": "",
      "priceItemParmGroupId": "",
      "toVal": "",
      "fromVal": "",
      "timeOfUse": "",
      "priceItemCode": "",
      "priceCriteria": "",
      "priceCompId": "",
      "tieSeqNum": "",
      "version": "",
    }
  }
  "priceComponentDescription": "FLAT",
  "valueAmt": "2.05000000000000000000",
  "priceComponentDisplay": "false",
  "rcMapId": "",
  "tieredFlag": "",
  "priceCompSequenceNo2": "0",
}
}
{
  "priority": "1",
  "priceListId": "5417730766",
  "priceListDescription": "PriceList -1",
  "priceListStartDate": "2022-01-11",
  "priceListEndDate": "2022-02-28",
  "noOfDays": "",
  "priceItemCode": "PI_029",
  "priceitemDescr": "V9-Domestic Liquidity",
  "priceAsgnId": "5410009214",
  "validityFlag": "",
  "sourceEntityType": "",
  "sourceEntityCode": "",
  "priceListInfo": "",
  "priceComponent":
  {
    "priceCompId": "5417300048",
    "pricecomptier"
    {
      "priceCompSequenceNo": "",
      "businessObjectDataArea": "",
      "priceItemParmGroupId": "",

```

```

        "toVal": "",
        "fromVal": "",
        "timeOfUse": "",
        "priceItemCode": "",
        "priceCriteria": "",
        "priceCompId": "",
        "tieSeqNum": "",
        "version": "",
    }
    "priceComponentDescription": "FLAT",
    "valueAmt": "0.400000000000000000",
    "priceComponentDisplay": "false",
    "rcMapId": "",
    "tieredFlag": "",
    "priceCompSequenceNo2": "0",
}
}
{
    "priority": "1",
    "priceListId": "5417730766",
    "priceListDescription": "PriceList -1",
    "priceListStartDate": "2022-01-11",
    "priceListEndDate": "2022-02-28",
    "noOfDays": "",
    "priceItemCode": "PI_030",
    "priceitemDescr": "V10-Third Party Bank",
    "priceAsgnId": "5410009215",
    "validityFlag": "",
    "sourceEntityType": "",
    "sourceEntityCode": "",
    "priceListInfo": "",
    "priceComponent":
    {
        "priceCompId": "5417300050",
        "pricecomptier"
        {
            "priceCompSequenceNo": "",
            "businessObjectDataArea": "",
            "priceItemParmGroupId": "",
            "toVal": "",
            "fromVal": "",
            "timeOfUse": "",
            "priceItemCode": "",
            "priceCriteria": "",
            "priceCompId": "",
            "tieSeqNum": "",
            "version": "",
        }
    }
    "priceComponentDescription": "FLAT",
    "valueAmt": "0.600000000000000000",
    "priceComponentDisplay": "false",
    "rcMapId": "",
    "tieredFlag": "",
    "priceCompSequenceNo2": "0",
}
}
{
    "priority": "1",
    "priceListId": "5417730766",
    "priceListDescription": "PriceList -1",
    "priceListStartDate": "2022-01-11",
    "priceListEndDate": "2022-02-28",
    "noOfDays": "",
    "priceItemCode": "PI_031",

```

```

"priceitemDescr": "MT943_SWIFT_01",
"priceAsgnId": "5410009201",
"validityFlag": "",
"sourceEntityType": "",
"sourceEntityCode": "",
"priceListInfo": "",
"priceComponent":
{
  "priceCompId": "5417300002",
  "pricecomptier"
  {
    "priceCompSequenceNo": "",
    "businessObjectDataArea": "",
    "priceItemParmGroupId": "",
    "toVal": "",
    "fromVal": "",
    "timeOfUse": "",
    "priceItemCode": "",
    "priceCriteria": "",
    "priceCompId": "",
    "tieSeqNum": "",
    "version": "",
  }
  "priceComponentDescription": "FLAT",
  "valueAmt": "16.660000000000000000",
  "priceComponentDisplay": "false",
  "rcMapId": "",
  "tieredFlag": "",
  "priceCompSequenceNo2": "0",
}
}

"priority": "1",
"priceListId": "5417730766",
"priceListDescription": "PriceList -1",
"priceListStartDate": "2022-01-11",
"priceListEndDate": "2022-02-28",
"noOfDays": "",
"priceItemCode": "PI_032",
"priceitemDescr": "MT943_SWIFT_02",
"priceAsgnId": "5410009261",
"validityFlag": "",
"sourceEntityType": "",
"sourceEntityCode": "",
"priceListInfo": "",
"priceComponent":
{
  "priceCompId": "5417450002",
  "pricecomptier"
  {
    "priceCompSequenceNo": "",
    "businessObjectDataArea": "",
    "priceItemParmGroupId": "",
    "toVal": "",
    "fromVal": "",
    "timeOfUse": "",
    "priceItemCode": "",
    "priceCriteria": "",
    "priceCompId": "",
    "tieSeqNum": "",
    "version": "",
  }
  "priceComponentDescription": "FLAT",
  "valueAmt": "15.000000000000000000",

```

```

        "priceComponentDisplay": "false",
        "rcMapId": "",
        "tieredFlag": "",
        "priceCompSequenceNo2": "0",
    }
}
}
"messageCategory": "0",
"messageNumber dataType": "0",
"messageText": "",
"longDescription": "",
"inquiryTypeFlag": "DETL",
}
}

```

Related Topics

For more information on...	See...
Eligible Market Products, Offers, or Bundles Derivation Request and Response - Attribute/Value Pairs in JSON Format	Eligible Market Products, Offers, or Bundles Derivation Request and Response - Attribute/Value Pairs in JSON Format on page 3382

Sample Eligible Offer Derivation Request and Response in the JSON Format

Using the below example, you can derive eligible offers for the **2406432705** account which are processed on **2022-01-11**.

Sample Eligible Offer Request in the JSON Format

```

{
  "C1_GETELIGIBLEPROD":
  {
    "productCode": "LOAN_001",
    "productCategoryFlg": "",
    "division": "IND",
    "entityType": "OFFR",
    "entityCode": "CHECKOFF_01",
    "processDate": "2022-01-11",
    "accountId": "2406432705",
    "acctIdtype": "",
    "acctIdentifierValue": "",
    "personId": "",
    "custIdTypeCd": "",
    "perIdentifireVal": "",
    "productLinkedEntity":
    {
      "linkedEntityCode": "CHECKMP_001",
      "linkedEntityType": "MP",
    }
    "eligibleParameter":
    {
      "priceParmCode": "ACC_DIVISION",
      "priceParmVal": "IND",
    }
    "eligibleParameter":
    {
      "priceParmCode": "PERSON_STATE",
      "priceParmVal": "MH",
    }
  }
}

```

Sample Eligible Offer Response in the JSON Format

```

{
  "C1_GETELIGIBLEPROD":
  {
    "productCode": "LOAN_001",
    "productCategoryFlg": "",
    "division": "IND",
    "entityType": "OFFR",
    "entityCode": "CHECKOFF_01",
    "processDate": "2022-01-11",
    "accountId": "2406432705",
    "acctIdtype": "",
    "acctIdentifierValue": "",
    "personId": "",
    "custIdTypeCd": "",
    "perIdentifireVal": "",
    "productLinkedEntity":
    {
      "linkedEntityCode": "CHECKMP_001",
      "linkedEntityType": "MP",
    }
    "eligibleParameter":
    {
      "priceParmCode": "ACC_DIVISION",
      "priceParmVal": "IND",
    }
    "eligibleParameter":
    {
      "priceParmCode": "PERSON_STATE",
      "priceParmVal": "MH",
    }
  }
  "entityList":
  {
    "entityCode": "CHECKOFF_01",
    "entityType": "OFFR",
    "entityName": "CHECKOFF_01",
    "entityStartDate": "2022-01-11",
    "entityEndDate": "2022-03-31",
    "entityCodeDescr": "",
    "termsAndCondition": "TERMSPRAAS2",
    "termAndConditionDescr": "TERMSPRAAS2",
    "status": "ACTIVE",
    "productList":
    {
      "productCode": "LOAN_001",
      "productDescription": "LOAN_001",
      "productTypFlgDesc": "Product",
      "productCategoryFlgDesc": "Loans",
    }
    "productLinkedEntity":
    {
      {
        "linkedEntityStartDate": "",
        "linkedEntityEndDate": "",
        "linkedEntityCode": "CHECKMP_001",
        "linkedEntityType": "MP",
      }
      {
        "linkedEntityStartDate": "",
        "linkedEntityEndDate": "",
        "linkedEntityCode": "CHEKCOMP_002",
        "linkedEntityType": "MP",
      }
    }
  }
}

```

```

    {
      "linkedEntityStartDate": "",
      "linkedEntityEndDate": "",
      "linkedEntityCode": "LOANSMP_003",
      "linkedEntityType": "MP",
    }
  }
  {
    "linkedEntityStartDate": "",
    "linkedEntityEndDate": "",
    "linkedEntityCode": "LOANSMP_004",
    "linkedEntityType": "MP",
  }
}
"EntityDivision":
{
  "divisionCode": "IND",
}
"eligibilityDetails":
{
  "eligibilityStartDate": "2022-01-01",
  "eligibilityEndDate": "",
  "eligibilityDescription": "ELG_OFFLOANS1",
  "eligibilityRule":
  {
    "sequenceNumber": "10",
    "lhsPriceParmCd": "ACC_DIVISION",
    "operator": "=",
    "rhsPriceParmCd": "",
    "rhsPriceParmVal": "IND",
    "lhsPriceParmCd1": "",
    "rhsPriceParmTypeFlg": "VAL",
    "trueFlag": "RLTR",
    "falseFlag": "RLFS",
    "insufficientFlag": "RLFS",
  }
}
"services":
{
  {
    "serviceName": "Product Service PRASS2",
    "mandatoryFlag": "true",
  }
  {
    "serviceName": "MH division product service",
    "mandatoryFlag": "true",
  }
  {
    "serviceName": "Product Service PRASS1",
    "mandatoryFlag": "true",
  }
  {
    "serviceName": "",
    "mandatoryFlag": "",
  }
}
"pricing"
{
  {
    "priority": "1",
    "priceListId": "4368251923",
    "priceListDescription": "Currency_Con_PriceList -1",
    "priceListStartDate": "2022-01-11",
    "priceListEndDate": "2022-04-11",
    "noOfDays": "90",
  }
}

```

```

"priceItemCode": "CC_021",
"priceitemDescr": "CC_21-Account Opening Fee",
"priceAsgnId": "4360009281",
"validityFlag": "",
"sourceEntityType": "",
"sourceEntityCode": "",
"priceListInfo": "",
"priceComponent":
{
  "priceCompId": "4367475002",
  "pricecomptier"
  {
    "priceCompSequenceNo": "",
    "businessObjectDataArea": "",
    "priceItemParmGroupId": "",
    "toVal": "",
    "fromVal": "",
    "timeOfUse": "",
    "priceItemCode": "",
    "priceCriteria": "",
    "priceCompId": "",
    "tieSeqNum": "",
    "version": "",
  }
  "priceComponentDescription": "FLAT",
  "valueAmt": "0.40000000000000000000",
  "priceComponentDisplay": "false",
  "rcMapId": "",
  "tieredFlag": "",
  "priceCompSequenceNo2": "0",
}
}
}
"priority": "1",
"priceListId": "4368251923",
"priceListDescription": "Currency_Con_PriceList -1",
"priceListStartDate": "2022-01-11",
"priceListEndDate": "2022-04-11",
"noOfDays": "90",
"priceItemCode": "CC_022",
"priceitemDescr": "CC2-Monthly Acct Serv Fee",
"priceAsgnId": "4360009282",
"validityFlag": "",
"sourceEntityType": "",
"sourceEntityCode": "",
"priceListInfo": "",
"priceComponent":
{
  "priceCompId": "4367475004",
  "pricecomptier"
  {
    "priceCompSequenceNo": "",
    "businessObjectDataArea": "",
    "priceItemParmGroupId": "",
    "toVal": "",
    "fromVal": "",
    "timeOfUse": "",
    "priceItemCode": "",
    "priceCriteria": "",
    "priceCompId": "",
    "tieSeqNum": "",
    "version": "",
  }
  "priceComponentDescription": "FLAT",

```

```

        "valueAmt": "0.600000000000000000",
        "priceComponentDisplay": "false",
        "rcMapId": "",
        "tieredFlag": "",
        "priceCompSequenceNo2": "0",
    }
}
{
    "priority": "1",
    "priceListId": "4368251923",
    "priceListDescription": "Currency_Con_PriceList -1",
    "priceListStartDate": "2022-01-11",
    "priceListEndDate": "2022-04-11",
    "noOfDays": "90",
    "priceItemCode": "CC_024",
    "priceitemDescr": "CC3-SEPA Transfers",
    "priceAsgnId": "4360009283",
    "validityFlag": "",
    "sourceEntityType": "",
    "sourceEntityCode": "",
    "priceListInfo": "",
    "priceComponent":
    {
        "priceCompId": "4367475006",
        "pricecomptier"
        {
            "priceCompSequenceNo": "",
            "businessObjectDataArea": "",
            "priceItemParmGroupId": "",
            "toVal": "",
            "fromVal": "",
            "timeOfUse": "",
            "priceItemCode": "",
            "priceCriteria": "",
            "priceCompId": "",
            "tieSeqNum": "",
            "version": "",
        }
        "priceComponentDescription": "FLAT",
        "valueAmt": "0.250000000000000000",
        "priceComponentDisplay": "false",
        "rcMapId": "",
        "tieredFlag": "",
        "priceCompSequenceNo2": "0",
    }
}
{
    "priority": "1",
    "priceListId": "4368251923",
    "priceListDescription": "Currency_Con_PriceList -1",
    "priceListStartDate": "2022-01-11",
    "priceListEndDate": "2022-04-11",
    "noOfDays": "90",
    "priceItemCode": "CC_025",
    "priceitemDescr": "CC4-Domestic Funds Transfer Fee",
    "priceAsgnId": "4360009284",
    "validityFlag": "",
    "sourceEntityType": "",
    "sourceEntityCode": "",
    "priceListInfo": "",
    "priceComponent":
    {
        "priceCompId": "4367475008",
        "pricecomptier"
    }
}

```



```

        {
            "priceCompSequenceNo": "",
            "businessObjectDataArea": "",
            "priceItemParmGroupId": "",
            "toVal": "",
            "fromVal": "",
            "timeOfUse": "",
            "priceItemCode": "",
            "priceCriteria": "",
            "priceCompId": "",
            "tieSeqNum": "",
            "version": "",
        }
        "priceComponentDescription": "FLAT",
        "valueAmt": "112.040000000000000000",
        "priceComponentDisplay": "false",
        "rcMapId": "",
        "tieredFlag": "",
        "priceCompSequenceNo2": "0",
    }
}
{
    "priority": "3",
    "priceListId": "5417730766",
    "priceListDescription": "PriceList -1",
    "priceListStartDate": "2022-01-11",
    "priceListEndDate": "2022-03-12",
    "noOfDays": "60",
    "priceItemCode": "PI_021",
    "priceitemDescr": "V1-Account Opening Fee",
    "priceAsgnId": "5410009202",
    "validityFlag": "",
    "sourceEntityType": "",
    "sourceEntityCode": "",
    "priceListInfo": "",
    "priceComponent":
    {
        "priceCompId": "5417300004",
        "pricecomptier"
        {
            "priceCompSequenceNo": "",
            "businessObjectDataArea": "",
            "priceItemParmGroupId": "",
            "toVal": "",
            "fromVal": "",
            "timeOfUse": "",
            "priceItemCode": "",
            "priceCriteria": "",
            "priceCompId": "",
            "tieSeqNum": "",
            "version": "",
        }
        "priceComponentDescription": "FLAT",
        "valueAmt": "0.250000000000000000",
        "priceComponentDisplay": "false",
        "rcMapId": "",
        "tieredFlag": "",
        "priceCompSequenceNo2": "0",
    }
}
{
    "priority": "3",
    "priceListId": "5417730766",
    "priceListDescription": "PriceList -1",

```

```

"priceListStartDate": "2022-01-11",
"priceListEndDate": "2022-03-12",
"noOfDays": "60",
"priceItemCode": "PI_022",
"priceitemDescr": "V2-Monthly Acct Serv Fee",
"priceAsgnId": "5410009203",
"validityFlag": "",
"sourceEntityType": "",
"sourceEntityCode": "",
"priceListInfo": "",
"priceComponent":
{
  "priceCompId": "5417300006",
  "pricecomptier"
  {
    "priceCompSequenceNo": "",
    "businessObjectDataArea": "",
    "priceItemParmGroupId": "",
    "toVal": "",
    "fromVal": "",
    "timeOfUse": "",
    "priceItemCode": "",
    "priceCriteria": "",
    "priceCompId": "",
    "tieSeqNum": "",
    "version": "",
  }
  "priceComponentDescription": "FLAT",
  "valueAmt": "112.040000000000000000",
  "priceComponentDisplay": "false",
  "rcMapId": "",
  "tieredFlag": "",
  "priceCompSequenceNo2": "0",
}
}
{
"priority": "3",
"priceListId": "5417730766",
"priceListDescription": "PriceList -1",
"priceListStartDate": "2022-01-11",
"priceListEndDate": "2022-03-12",
"noOfDays": "60",
"priceItemCode": "PI_023",
"priceitemDescr": "V3-Audit Reports",
"priceAsgnId": "5410009204",
"validityFlag": "",
"sourceEntityType": "",
"sourceEntityCode": "",
"priceListInfo": "",
"priceComponent":
{
  "priceCompId": "5417300008",
  "pricecomptier"
  {
    "priceCompSequenceNo": "",
    "businessObjectDataArea": "",
    "priceItemParmGroupId": "",
    "toVal": "",
    "fromVal": "",
    "timeOfUse": "",
    "priceItemCode": "",
    "priceCriteria": "",
    "priceCompId": "",
    "tieSeqNum": "",
  }
}
}

```

```

        "version": "",
    }
    "priceComponentDescription": "FLAT",
    "valueAmt": "276.25000000000000000000",
    "priceComponentDisplay": "false",
    "rcMapId": "",
    "tieredFlag": "",
    "priceCompSequenceNo2": "0",
}
}
{
    "priority": "3",
    "priceListId": "5417730766",
    "priceListDescription": "PriceList -1",
    "priceListStartDate": "2022-01-11",
    "priceListEndDate": "2022-03-12",
    "noOfDays": "60",
    "priceItemCode": "PI_024",
    "priceitemDescr": "V4-SEPA Transfers",
    "priceAsgnId": "5410009241",
    "validityFlag": "",
    "sourceEntityType": "",
    "sourceEntityCode": "",
    "priceListInfo": "",
    "priceComponent":
    {
        {
            "priceCompId": "5417400004",
            "pricecomptier"
            {
                "priceCompSequenceNo": "0",
                "businessObjectDataArea": "",
                "priceItemParmGroupId": "1",
                "toVal": "1000.00000000000000000000",
                "fromVal": "0.00000000000000000000",
                "timeOfUse": "",
                "priceItemCode": "PI_024",
                "priceCriteria": "NBRTRAN",
                "priceCompId": "",
                "tieSeqNum": "10",
                "version": "0",
            }
        }
        {
            "priceCompSequenceNo": "0",
            "businessObjectDataArea": "",
            "priceItemParmGroupId": "1",
            "toVal": "5000.00000000000000000000",
            "fromVal": "1000.00000000000000000000",
            "timeOfUse": "",
            "priceItemCode": "PI_024",
            "priceCriteria": "NBRTRAN",
            "priceCompId": "",
            "tieSeqNum": "10",
            "version": "0",
        }
    }
}
{
    "priceCompSequenceNo": "0",
    "businessObjectDataArea": "",
    "priceItemParmGroupId": "1",
    "toVal": "999999999999.99000000000000000000",
    "fromVal": "5000.00000000000000000000",
    "priceItemCode": "PI_024",
    "priceCriteria": "NBRTRAN",
    "priceCriteria": "",
}

```

```

        "priceCompId": "",
        "tieSeqNum": "10",
        "version": "0",
    }
    "priceComponentDescription": "Price per transaction
- Step Tier 1",
    "valueAmt": "12.950000000000000000",
    "priceComponentDisplay": "false",
    "rcMapId": "",
    "tieredFlag": "",
    "priceCompSequenceNo2": "0",
}
{
    "priceCompId": "5417400005",
    "pricecomptier"
    {
        "priceCompSequenceNo": "0",
        "businessObjectDataArea": "",
        "priceItemParmGroupId": "1",
        "toVal": "1000.000000000000000000",
        "fromVal": "0.000000000000000000",
        "timeOfUse": "",
        "priceItemCode": "PI_024",
        "priceCriteria": "NBRTRAN",
        "priceCompId": "",
        "tieSeqNum": "10",
        "version": "0",
    }
    {
        "priceCompSequenceNo": "0",
        "businessObjectDataArea": "",
        "priceItemParmGroupId": "1",
        "toVal": "5000.000000000000000000",
        "fromVal": "1000.000000000000000000",
        "timeOfUse": "",
        "priceItemCode": "PI_024",
        "priceCriteria": "NBRTRAN",
        "priceCompId": "",
        "tieSeqNum": "10",
        "version": "0",
    }
    {
        "priceCompSequenceNo": "0",
        "businessObjectDataArea": "",
        "priceItemParmGroupId": "1",
        "toVal": "999999999999.990000000000000000",
        "fromVal": "5000.000000000000000000",
        "priceItemCode": "PI_024",
        "priceCriteria": "NBRTRAN",
        "priceCriteria": "",
        "priceCompId": "",
        "tieSeqNum": "10",
        "version": "0",
    }
}
    "priceComponentDescription": "Price per transaction
- Step Tier 2",
    "valueAmt": "12.150000000000000000",
    "priceComponentDisplay": "false",
    "rcMapId": "",
    "tieredFlag": "",
    "priceCompSequenceNo2": "0",
}
{
    "priceCompId": "5417400006",

```

```

        "pricecomptier"
        {
            "priceCompSequenceNo": "0",
            "businessObjectDataArea": "",
            "priceItemParmGroupId": "1",
            "toVal": "1000.00000000000000000000",
            "fromVal": "0.00000000000000000000",
            "timeOfUse": "",
            "priceItemCode": "PI_024",
            "priceCriteria": "NBRTRAN",
            "priceCompId": "",
            "tieSeqNum": "10",
            "version": "0",
        }
    }
    {
        "priceCompSequenceNo": "0",
        "businessObjectDataArea": "",
        "priceItemParmGroupId": "1",
        "toVal": "5000.00000000000000000000",
        "fromVal": "1000.00000000000000000000",
        "timeOfUse": "",
        "priceItemCode": "PI_024",
        "priceCriteria": "NBRTRAN",
        "priceCompId": "",
        "tieSeqNum": "10",
        "version": "0",
    }
}
    {
        "priceCompSequenceNo": "0",
        "businessObjectDataArea": "",
        "priceItemParmGroupId": "1",
        "toVal": "99999999999.99000000000000000000",
        "fromVal": "5000.00000000000000000000",
        "priceItemCode": "PI_024",
        "priceCriteria": "NBRTRAN",
        "priceCriteria": "",
        "priceCompId": "",
        "tieSeqNum": "10",
        "version": "0",
    }
}
    "priceComponentDescription": "Price per transaction
- Step Tier 3",
    "valueAmt": "11.95000000000000000000",
    "priceComponentDisplay": "false",
    "rcMapId": "",
    "tieredFlag": "",
    "priceCompSequenceNo2": "0",
}
}
}
    "priority": "3",
    "priceListId": "5417730766",
    "priceListDescription": "PriceList -1",
    "priceListStartDate": "2022-01-11",
    "priceListEndDate": "2022-03-12",
    "noOfDays": "60",
    "priceItemCode": "PI_025",
    "priceitemDescr": "V5-Domestic Funds Transfer Fee",
    "priceAsgnId": "5410009242",
    "validityFlag": "",
    "sourceEntityType": "",
    "sourceEntityCode": "",
    "priceListInfo": "",

```

```

"priceComponent":
{
  {
    "priceCompId": "5417400010",
    "pricecomptier"
    {
      "priceCompSequenceNo": "0",
      "businessObjectDataArea": "",
      "priceItemParmGroupId": "1",
      "toVal": "1000.00000000000000000000",
      "fromVal": "0.00000000000000000000",
      "timeOfUse": "",
      "priceItemCode": "PI_025",
      "priceCriteria": "NBRTRAN",
      "priceCompId": "",
      "tieSeqNum": "10",
      "version": "0",
    }
  }
  {
    "priceCompSequenceNo": "0",
    "businessObjectDataArea": "",
    "priceItemParmGroupId": "1",
    "toVal": "5000.00000000000000000000",
    "fromVal": "1000.00000000000000000000",
    "timeOfUse": "",
    "priceItemCode": "PI_025",
    "priceCriteria": "NBRTRAN",
    "priceCompId": "",
    "tieSeqNum": "10",
    "version": "0",
  }
}
  {
    "priceCompSequenceNo": "0",
    "businessObjectDataArea": "",
    "priceItemParmGroupId": "1",
    "toVal": "99999999999.99000000000000000000",
    "fromVal": "5000.00000000000000000000",
    "timeOfUse": "",
    "priceItemCode": "PI_025",
    "priceCriteria": "NBRTRAN",
    "priceCompId": "",
    "tieSeqNum": "10",
    "version": "0",
  }
}
    "priceComponentDescription": "Threshold price
per transaction",
    "valueAmt": "12.95000000000000000000",
    "priceComponentDisplay": "false",
    "rcMapId": "",
    "tieredFlag": "",
    "priceCompSequenceNo2": "0",
  }
}
  "priceCompId": "5417400011",
  "pricecomptier"
  {
    "priceCompSequenceNo": "0",
    "businessObjectDataArea": "",
    "priceItemParmGroupId": "1",
    "toVal": "1000.00000000000000000000",
    "fromVal": "0.00000000000000000000",
    "timeOfUse": "",
    "priceItemCode": "PI_025",
    "priceCriteria": "NBRTRAN",
  }
}

```

```

        "priceCompId": "",
        "tieSeqNum": "10",
        "version": "0",
    }
    {
        "priceCompSequenceNo": "0",
        "businessObjectDataArea": "",
        "priceItemParmGroupId": "1",
        "toVal": "5000.0000000000000000000000",
        "fromVal": "1000.0000000000000000000000",
        "timeOfUse": "",
        "priceItemCode": "PI_025",
        "priceCriteria": "NBRTRAN",
        "priceCompId": "",
        "tieSeqNum": "10",
        "version": "0",
    }
    {
        "priceCompSequenceNo": "0",
        "businessObjectDataArea": "",
        "priceItemParmGroupId": "1",
        "toVal": "999999999999.9900000000000000000000",
        "fromVal": "5000.0000000000000000000000",
        "timeOfUse": "",
        "priceItemCode": "PI_025",
        "priceCriteria": "NBRTRAN",
        "priceCompId": "",
        "tieSeqNum": "10",
        "version": "0",
    }
    }
    "priceComponentDescription": "Threshold price
per transaction",
    "valueAmt": "12.1500000000000000000000",
    "priceComponentDisplay": "false",
    "rcMapId": "",
    "tieredFlag": "",
    "priceCompSequenceNo2": "0",
}
{
    "priceCompId": "5417400012",
    "priccomptier"
    {
        "priceCompSequenceNo": "0",
        "businessObjectDataArea": "",
        "priceItemParmGroupId": "1",
        "toVal": "1000.0000000000000000000000",
        "fromVal": "0.0000000000000000000000",
        "timeOfUse": "",
        "priceItemCode": "PI_025",
        "priceCriteria": "NBRTRAN",
        "priceCompId": "",
        "tieSeqNum": "10",
        "version": "0",
    }
    {
        "priceCompSequenceNo": "0",
        "businessObjectDataArea": "",
        "priceItemParmGroupId": "1",
        "toVal": "5000.0000000000000000000000",
        "fromVal": "1000.0000000000000000000000",
        "timeOfUse": "",
        "priceItemCode": "PI_025",
        "priceCriteria": "NBRTRAN",
        "priceCompId": "",
    }
}

```

```

        "tieSeqNum": "10",
        "version": "0",
    }
}
    "priceCompSequenceNo": "0",
    "businessObjectDataArea": "",
    "priceItemParmGroupId": "1",
    "toVal": "999999999999.99000000000000000000",
    "fromVal": "5000.00000000000000000000",
    "timeOfUse": "",
    "priceItemCode": "PI_025",
    "priceCriteria": "NBRTRAN",
    "priceCompId": "",
    "tieSeqNum": "10",
    "version": "0",
}
    "priceComponentDescription": "Threshold price
per transaction",
    "valueAmt": "11.950000000000000000",
    "priceComponentDisplay": "false",
    "rcMapId": "",
    "tieredFlag": "",
    "priceCompSequenceNo2": "0",
}
}
}
    "priority": "3",
    "priceListId": "5417730766",
    "priceListDescription": "PriceList -1",
    "priceListStartDate": "2022-01-11",
    "priceListEndDate": "2022-03-12",
    "noOfDays": "60",
    "priceItemCode": "PI_026",
    "priceitemDescr": "V6-Electronic Credits",
    "priceAsgnId": "5410009243",
    "validityFlag": "",
    "sourceEntityType": "",
    "sourceEntityCode": "",
    "priceListInfo": "",
    "priceComponent":
    {
        {
            "priceCompId": "5417400020",
            "pricecomptier"
            {
                "priceCompSequenceNo": "0",
                "businessObjectDataArea": "",
                "priceItemParmGroupId": "1",
                "toVal": "1000.00000000000000000000",
                "fromVal": "0.00000000000000000000",
                "timeOfUse": "",
                "priceItemCode": "PI_026",
                "priceCriteria": "NBRTRAN",
                "priceCompId": "",
                "tieSeqNum": "10",
                "version": "0",
            }
        }
        {
            "priceCompSequenceNo": "0",
            "businessObjectDataArea": "",
            "priceItemParmGroupId": "1",
            "toVal": "5000.00000000000000000000",
            "fromVal": "1000.00000000000000000000",
        }
    }
}

```



```

        "timeOfUse": "",
        "priceItemCode": "PI_026",
        "priceCriteria": "NBRTRAN",
        "priceCompId": "",
        "tieSeqNum": "10",
        "version": "0",
    }
}
{
    "priceCompSequenceNo": "0",
    "businessObjectDataArea": "",
    "priceItemParmGroupId": "1",
    "toVal": "999999999999.99000000000000000000",
    "fromVal": "5000.00000000000000000000",
    "timeOfUse": "",
    "priceItemCode": "PI_026",
    "priceCriteria": "NBRTRAN",
    "priceCompId": "",
    "tieSeqNum": "10",
    "version": "0",
}
}
{
    "priceCompSequenceNo": "0",
    "businessObjectDataArea": "",
    "priceItemParmGroupId": "1",
    "toVal": "1000.00000000000000000000",
    "fromVal": "0.00000000000000000000",
    "timeOfUse": "",
    "priceItemCode": "PI_026",
    "priceCriteria": "NBRTRAN",
    "priceCompId": "",
    "tieSeqNum": "10",
    "version": "0",
}
}
{
    "priceCompSequenceNo": "0",
    "businessObjectDataArea": "",
    "priceItemParmGroupId": "1",
    "toVal": "5000.00000000000000000000",
    "fromVal": "5000.00000000000000000000",
    "timeOfUse": "",
    "priceItemCode": "PI_026",
    "priceCriteria": "NBRTRAN",
    "priceCompId": "",
    "tieSeqNum": "10",
    "version": "0",
}
}
{
    "priceCompSequenceNo": "0",
    "businessObjectDataArea": "",
    "priceItemParmGroupId": "1",
    "toVal": "999999999999.99000000000000000000",
    "fromVal": "5000.00000000000000000000",
    "timeOfUse": "",
    "priceItemCode": "PI_026",
    "priceCriteria": "NBRTRAN",
    "priceCompId": "",
    "tieSeqNum": "10",
    "version": "0",
}
}
"priceComponentDescription": "Basic chargesn",
"valueAmt": "20.00000000000000000000",
"priceComponentDisplay": "false",
"rcMapId": "",
"tieredFlag": "",

```

```

    "priceCompSequenceNo2": "0",
  }
}
"priceCompId": "5417400021",
"pricecomptier"
{
  "priceCompSequenceNo": "0",
  "businessObjectDataArea": "",
  "priceItemParmGroupId": "1",
  "toVal": "1000.000000000000000000000000",
  "fromVal": "0.000000000000000000000000",
  "timeOfUse": "",
  "priceItemCode": "PI_026",
  "priceCriteria": "NBRTRAN",
  "priceCompId": "",
  "tieSeqNum": "10",
  "version": "0",
}
}
"priceCompSequenceNo": "0",
"businessObjectDataArea": "",
"priceItemParmGroupId": "1",
"toVal": "5000.000000000000000000000000",
"fromVal": "1000.000000000000000000000000",
"timeOfUse": "",
"priceItemCode": "PI_026",
"priceCriteria": "NBRTRAN",
"priceCompId": "",
"tieSeqNum": "10",
"version": "0",
}
}
"priceCompSequenceNo": "0",
"businessObjectDataArea": "",
"priceItemParmGroupId": "1",
"toVal": "999999999999.990000000000000000000000",
"fromVal": "5000.000000000000000000000000",
"timeOfUse": "",
"priceItemCode": "PI_026",
"priceCriteria": "NBRTRAN",
"priceCompId": "",
"tieSeqNum": "10",
"version": "0",
}
}
"priceCompSequenceNo": "0",
"businessObjectDataArea": "",
"priceItemParmGroupId": "1",
"toVal": "1000.000000000000000000000000",
"fromVal": "0.000000000000000000000000",
"timeOfUse": "",
"priceItemCode": "PI_026",
"priceCriteria": "NBRTRAN",
"priceCompId": "",
"tieSeqNum": "10",
"version": "0",
}
}
"priceCompSequenceNo": "0",
"businessObjectDataArea": "",
"priceItemParmGroupId": "1",
"toVal": "5000.000000000000000000000000",
"fromVal": "5000.000000000000000000000000",
"timeOfUse": "",

```

```

        "priceItemCode": "PI_026",
        "priceCriteria": "NBRTRAN",
        "priceCompId": "",
        "tieSeqNum": "10",
        "version": "0",
    }
}
{
    "priceCompSequenceNo": "0",
    "businessObjectDataArea": "",
    "priceItemParmGroupId": "1",
    "toVal": "999999999999.99000000000000000000",
    "fromVal": "5000.00000000000000000000",
    "timeOfUse": "",
    "priceItemCode": "PI_026",
    "priceCriteria": "NBRTRAN",
    "priceCompId": "",
    "tieSeqNum": "10",
    "version": "0",
}
}
"priceComponentDescription": "Threshold price",
"valueAmt": "10.00000000000000000000",
"priceComponentDisplay": "false",
"rcMapId": "",
"tieredFlag": "",
"priceCompSequenceNo2": "0",
}
}
}
"priceCompId": "5417400022",
"pricecomptier"
{
    "priceCompSequenceNo": "0",
    "businessObjectDataArea": "",
    "priceItemParmGroupId": "1",
    "toVal": "1000.00000000000000000000",
    "fromVal": "0.00000000000000000000",
    "timeOfUse": "",
    "priceItemCode": "PI_026",
    "priceCriteria": "NBRTRAN",
    "priceCompId": "",
    "tieSeqNum": "10",
    "version": "0",
}
}
{
    "priceCompSequenceNo": "0",
    "businessObjectDataArea": "",
    "priceItemParmGroupId": "1",
    "toVal": "5000.00000000000000000000",
    "fromVal": "1000.00000000000000000000",
    "timeOfUse": "",
    "priceItemCode": "PI_026",
    "priceCriteria": "NBRTRAN",
    "priceCompId": "",
    "tieSeqNum": "10",
    "version": "0",
}
}
}
{
    "priceCompSequenceNo": "0",
    "businessObjectDataArea": "",
    "priceItemParmGroupId": "1",
    "toVal": "999999999999.99000000000000000000",
    "fromVal": "5000.00000000000000000000",
    "timeOfUse": "",
    "priceItemCode": "PI_026",
}

```

```

        "priceCriteria": "NBRTRAN",
        "priceCompId": "",
        "tieSeqNum": "10",
        "version": "0",
    }
}
{
    "priceCompSequenceNo": "0",
    "businessObjectDataArea": "",
    "priceItemParmGroupId": "1",
    "toVal": "1000.0000000000000000000000",
    "fromVal": "0.0000000000000000000000",
    "timeOfUse": "",
    "priceItemCode": "PI_026",
    "priceCriteria": "NBRTRAN",
    "priceCompId": "",
    "tieSeqNum": "10",
    "version": "0",
}
{
    "priceCompSequenceNo": "0",
    "businessObjectDataArea": "",
    "priceItemParmGroupId": "1",
    "toVal": "5000.0000000000000000000000",
    "fromVal": "5000.0000000000000000000000",
    "timeOfUse": "",
    "priceItemCode": "PI_026",
    "priceCriteria": "NBRTRAN",
    "priceCompId": "",
    "tieSeqNum": "10",
    "version": "0",
}
{
    "priceCompSequenceNo": "0",
    "businessObjectDataArea": "",
    "priceItemParmGroupId": "1",
    "toVal": "999999999999.9900000000000000000000",
    "fromVal": "5000.0000000000000000000000",
    "timeOfUse": "",
    "priceItemCode": "PI_026",
    "priceCriteria": "NBRTRAN",
    "priceCompId": "",
    "tieSeqNum": "10",
    "version": "0",
}
}
"priceComponentDescription": "Threshold price",
"valueAmt": "8.0000000000000000000000",
"priceComponentDisplay": "false",
"rcMapId": "",
"tieredFlag": "",
"priceCompSequenceNo2": "0",
}
}
{
    "priceCompId": "5417400023",
    "pricecomptier"
    {
        "priceCompSequenceNo": "0",
        "businessObjectDataArea": "",
        "priceItemParmGroupId": "1",
        "toVal": "1000.0000000000000000000000",
        "fromVal": "0.0000000000000000000000",
        "timeOfUse": "",
        "priceItemCode": "PI_026",
        "priceCriteria": "NBRTRAN",
    }
}

```

```

    "priceCompId": "",
    "tieSeqNum": "10",
    "version": "0",
  }
  {
    "priceCompSequenceNo": "0",
    "businessObjectDataArea": "",
    "priceItemParmGroupId": "1",
    "toVal": "5000.0000000000000000000000",
    "fromVal": "1000.0000000000000000000000",
    "timeOfUse": "",
    "priceItemCode": "PI_026",
    "priceCriteria": "NBRTRAN",
    "priceCompId": "",
    "tieSeqNum": "10",
    "version": "0",
  }
  {
    "priceCompSequenceNo": "0",
    "businessObjectDataArea": "",
    "priceItemParmGroupId": "1",
    "toVal": "999999999999.9900000000000000000000",
    "fromVal": "5000.0000000000000000000000",
    "timeOfUse": "",
    "priceItemCode": "PI_026",
    "priceCriteria": "NBRTRAN",
    "priceCompId": "",
    "tieSeqNum": "10",
    "version": "0",
  }
  {
    "priceCompSequenceNo": "0",
    "businessObjectDataArea": "",
    "priceItemParmGroupId": "1",
    "toVal": "1000.0000000000000000000000",
    "fromVal": "0.0000000000000000000000",
    "timeOfUse": "",
    "priceItemCode": "PI_026",
    "priceCriteria": "NBRTRAN",
    "priceCompId": "",
    "tieSeqNum": "10",
    "version": "0",
  }
  {
    "priceCompSequenceNo": "0",
    "businessObjectDataArea": "",
    "priceItemParmGroupId": "1",
    "toVal": "5000.0000000000000000000000",
    "fromVal": "5000.0000000000000000000000",
    "timeOfUse": "",
    "priceItemCode": "PI_026",
    "priceCriteria": "NBRTRAN",
    "priceCompId": "",
    "tieSeqNum": "10",
    "version": "0",
  }
  {
    "priceCompSequenceNo": "0",
    "businessObjectDataArea": "",
    "priceItemParmGroupId": "1",
    "toVal": "999999999999.9900000000000000000000",
    "fromVal": "5000.0000000000000000000000",
    "timeOfUse": "",
    "priceItemCode": "PI_026",
  }

```

```

        "priceCriteria": "NBRTRAN",
        "priceCompId": "",
        "tieSeqNum": "10",
        "version": "0",
    }
    "priceComponentDescription": "Threshold price",
    "valueAmt": "6.000000000000000000",
    "priceComponentDisplay": "false",
    "rcMapId": "",
    "tieredFlag": "",
    "priceCompSequenceNo2": "0",
}
}
{
"priceCompId": "541740024",
"pricecomptier"
{
    "priceCompSequenceNo": "0",
    "businessObjectDataArea": "",
    "priceItemParmGroupId": "1",
    "toVal": "1000.000000000000000000",
    "fromVal": "0.000000000000000000",
    "timeOfUse": "",
    "priceItemCode": "PI_026",
    "priceCriteria": "NBRTRAN",
    "priceCompId": "",
    "tieSeqNum": "10",
    "version": "0",
}
{
    "priceCompSequenceNo": "0",
    "businessObjectDataArea": "",
    "priceItemParmGroupId": "1",
    "toVal": "5000.000000000000000000",
    "fromVal": "1000.000000000000000000",
    "timeOfUse": "",
    "priceItemCode": "PI_026",
    "priceCriteria": "NBRTRAN",
    "priceCompId": "",
    "tieSeqNum": "10",
    "version": "0",
}
{
    "priceCompSequenceNo": "0",
    "businessObjectDataArea": "",
    "priceItemParmGroupId": "1",
    "toVal": "999999999999.990000000000000000",
    "fromVal": "5000.000000000000000000",
    "timeOfUse": "",
    "priceItemCode": "PI_026",
    "priceCriteria": "NBRTRAN",
    "priceCompId": "",
    "tieSeqNum": "10",
    "version": "0",
}
{
    "priceCompSequenceNo": "0",
    "businessObjectDataArea": "",
    "priceItemParmGroupId": "1",
    "toVal": "1000.000000000000000000",
    "fromVal": "0.000000000000000000",
    "timeOfUse": "",
    "priceItemCode": "PI_026",
    "priceCriteria": "NBRTRAN",
}

```

```

        "priceCompId": "",
        "tieSeqNum": "10",
        "version": "0",
    }
    {
        "priceCompSequenceNo": "0",
        "businessObjectDataArea": "",
        "priceItemParmGroupId": "1",
        "toVal": "5000.0000000000000000000000",
        "fromVal": "5000.0000000000000000000000",
        "timeOfUse": "",
        "priceItemCode": "PI_026",
        "priceCriteria": "NBRTRAN",
        "priceCompId": "",
        "tieSeqNum": "10",
        "version": "0",
    }
    {
        "priceCompSequenceNo": "0",
        "businessObjectDataArea": "",
        "priceItemParmGroupId": "1",
        "toVal": "999999999999.9900000000000000000000",
        "fromVal": "5000.0000000000000000000000",
        "timeOfUse": "",
        "priceItemCode": "PI_026",
        "priceCriteria": "NBRTRAN",
        "priceCompId": "",
        "tieSeqNum": "10",
        "version": "0",
    }
    "priceComponentDescription": "Step 1",
    "valueAmt": "5.0000000000000000000000",
    "priceComponentDisplay": "false",
    "rcMapId": "",
    "tieredFlag": "",
    "priceCompSequenceNo2": "0",
}
}
{
    "priceCompId": "5417400025",
    "pricecomptier"
    {
        "priceCompSequenceNo": "0",
        "businessObjectDataArea": "",
        "priceItemParmGroupId": "1",
        "toVal": "1000.0000000000000000000000",
        "fromVal": "0.0000000000000000000000",
        "timeOfUse": "",
        "priceItemCode": "PI_026",
        "priceCriteria": "NBRTRAN",
        "priceCompId": "",
        "tieSeqNum": "10",
        "version": "0",
    }
    {
        "priceCompSequenceNo": "0",
        "businessObjectDataArea": "",
        "priceItemParmGroupId": "1",
        "toVal": "5000.0000000000000000000000",
        "fromVal": "1000.0000000000000000000000",
        "timeOfUse": "",
        "priceItemCode": "PI_026",
        "priceCriteria": "NBRTRAN",
        "priceCompId": "",
    }
}

```

```

        "tieSeqNum": "10",
        "version": "0",
    }
}
    "priceCompSequenceNo": "0",
    "businessObjectDataArea": "",
    "priceItemParmGroupId": "1",
    "toVal": "999999999999.99000000000000000000",
    "fromVal": "5000.00000000000000000000",
    "timeOfUse": "",
    "priceItemCode": "PI_026",
    "priceCriteria": "NBRTRAN",
    "priceCompId": "",
    "tieSeqNum": "10",
    "version": "0",
}
}
    "priceCompSequenceNo": "0",
    "businessObjectDataArea": "",
    "priceItemParmGroupId": "1",
    "toVal": "1000.00000000000000000000",
    "fromVal": "0.00000000000000000000",
    "timeOfUse": "",
    "priceItemCode": "PI_026",
    "priceCriteria": "NBRTRAN",
    "priceCompId": "",
    "tieSeqNum": "10",
    "version": "0",
}
}
    "priceCompSequenceNo": "0",
    "businessObjectDataArea": "",
    "priceItemParmGroupId": "1",
    "toVal": "5000.00000000000000000000",
    "fromVal": "5000.00000000000000000000",
    "timeOfUse": "",
    "priceItemCode": "PI_026",
    "priceCriteria": "NBRTRAN",
    "priceCompId": "",
    "tieSeqNum": "10",
    "version": "0",
}
}
    "priceCompSequenceNo": "0",
    "businessObjectDataArea": "",
    "priceItemParmGroupId": "1",
    "toVal": "999999999999.99000000000000000000",
    "fromVal": "5000.00000000000000000000",
    "timeOfUse": "",
    "priceItemCode": "PI_026",
    "priceCriteria": "NBRTRAN",
    "priceCompId": "",
    "tieSeqNum": "10",
    "version": "0",
}
    "priceComponentDescription": "Step 2",
    "valueAmt": "4.00000000000000000000",
    "priceComponentDisplay": "false",
    "rcMapId": "",
    "tieredFlag": "",
    "priceCompSequenceNo2": "0",
}
}

```



```

"priceCompId": "5417400026",
"pricecomptier"
{
  "priceCompSequenceNo": "0",
  "businessObjectDataArea": "",
  "priceItemParmGroupId": "1",
  "toVal": "1000.00000000000000000000",
  "fromVal": "0.00000000000000000000",
  "timeOfUse": "",
  "priceItemCode": "PI_026",
  "priceCriteria": "NBRTRAN",
  "priceCompId": "",
  "tieSeqNum": "10",
  "version": "0",
}
{
  "priceCompSequenceNo": "0",
  "businessObjectDataArea": "",
  "priceItemParmGroupId": "1",
  "toVal": "5000.00000000000000000000",
  "fromVal": "1000.00000000000000000000",
  "timeOfUse": "",
  "priceItemCode": "PI_026",
  "priceCriteria": "NBRTRAN",
  "priceCompId": "",
  "tieSeqNum": "10",
  "version": "0",
}
{
  "priceCompSequenceNo": "0",
  "businessObjectDataArea": "",
  "priceItemParmGroupId": "1",
  "toVal": "999999999999.99000000000000000000",
  "fromVal": "5000.00000000000000000000",
  "timeOfUse": "",
  "priceItemCode": "PI_026",
  "priceCriteria": "NBRTRAN",
  "priceCompId": "",
  "tieSeqNum": "10",
  "version": "0",
}
{
  "priceCompSequenceNo": "0",
  "businessObjectDataArea": "",
  "priceItemParmGroupId": "1",
  "toVal": "1000.00000000000000000000",
  "fromVal": "0.00000000000000000000",
  "timeOfUse": "",
  "priceItemCode": "PI_026",
  "priceCriteria": "NBRTRAN",
  "priceCompId": "",
  "tieSeqNum": "10",
  "version": "0",
}
{
  "priceCompSequenceNo": "0",
  "businessObjectDataArea": "",
  "priceItemParmGroupId": "1",
  "toVal": "5000.00000000000000000000",
  "fromVal": "5000.00000000000000000000",
  "timeOfUse": "",
  "priceItemCode": "PI_026",
  "priceCriteria": "NBRTRAN",
  "priceCompId": "",
}

```

```

        "tieSeqNum": "10",
        "version": "0",
    }
}
    "priceCompSequenceNo": "0",
    "businessObjectDataArea": "",
    "priceItemParmGroupId": "1",
    "toVal": "999999999999.99000000000000000000",
    "fromVal": "5000.00000000000000000000",
    "timeOfUse": "",
    "priceItemCode": "PI_026",
    "priceCriteria": "NBRTRAN",
    "priceCompId": "",
    "tieSeqNum": "10",
    "version": "0",
}
    "priceComponentDescription": "Step 3",
    "valueAmt": "3.00000000000000000000",
    "priceComponentDisplay": "false",
    "rcMapId": "",
    "tieredFlag": "",
    "priceCompSequenceNo2": "0",
}
}
}
    "priority": "3",
    "priceListId": "5417730766",
    "priceListDescription": "PriceList -1",
    "priceListStartDate": "2022-01-11",
    "priceListEndDate": "2022-03-12",
    "noOfDays": "60",
    "priceItemCode": "PI_027",
    "priceitemDescr": "V7-Direct Debit",
    "priceAsgnId": "5410009209",
    "validityFlag": "",
    "sourceEntityType": "",
    "sourceEntityCode": "",
    "priceListInfo": "",
    "priceComponent":
    {
        {
            "priceCompId": "5417300038",
            "priccomptier"
            {
                "priceComponentDescription": "Basic BK-NBR",
                "valueAmt": "0.15000000000000000000",
                "priceComponentDisplay": "false",
                "rcMapId": "",
                "tieredFlag": "",
                "priceCompSequenceNo2": "0",
            }
        }
    }
}
}
    "priority": "3",
    "priceListId": "5417730766",
    "priceListDescription": "PriceList -1",
    "priceListStartDate": "2022-01-11",
    "priceListEndDate": "2022-03-12",
    "noOfDays": "60",
    "priceItemCode": "PI_028",
    "priceitemDescr": "V8-Cheque Collections",
    "priceAsgnId": "5410009210",

```

```

"validityFlag": "",
"sourceEntityType": "",
"sourceEntityCode": "",
"priceListInfo": "",
"priceComponent": {
  {
    "priceCompId": "5417300040",
    "pricecomptier"
    "priceComponentDescription": "FLAT",
    "valueAmt": "0.750000000000000000",
    "priceComponentDisplay": "false",
    "rcMapId": "",
    "tieredFlag": "",
    "priceCompSequenceNo2": "0",
  }
}
}
{
"priority": "3",
"priceListId": "5417730766",
"priceListDescription": "PriceList -1",
"priceListStartDate": "2022-01-11",
"priceListEndDate": "2022-03-12",
"noOfDays": "60",
"priceItemCode": "PI_028",
"priceitemDescr": "V8-Cheque Collections",
"priceAsgnId": "5410009211",
"validityFlag": "",
"sourceEntityType": "",
"sourceEntityCode": "",
"priceListInfo": "",
"priceComponent": {
  {
    "priceCompId": "5417300042",
    "pricecomptier"
    "priceComponentDescription": "FLAT",
    "valueAmt": "6.670000000000000000",
    "priceComponentDisplay": "false",
    "rcMapId": "",
    "tieredFlag": "",
    "priceCompSequenceNo2": "0",
  }
}
}
{
"priority": "3",
"priceListId": "5417730766",
"priceListDescription": "PriceList -1",
"priceListStartDate": "2022-01-11",
"priceListEndDate": "2022-03-12",
"noOfDays": "60",
"priceItemCode": "PI_028",
"priceitemDescr": "V8-Cheque Collections",
"priceAsgnId": "5410009212",
"validityFlag": "",
"sourceEntityType": "",
"sourceEntityCode": "",
"priceListInfo": "",
"priceComponent": {
  {
    "priceCompId": "5417300044",
    "pricecomptier"
    "priceComponentDescription": "FLAT",
    "valueAmt": "0.300000000000000000",
    "priceComponentDisplay": "false",

```

```

        "rcMapId": "",
        "tieredFlag": "",
        "priceCompSequenceNo2": "0",
    }
}
{
"priority": "3",
"priceListId": "5417730766",
"priceListDescription": "PriceList -1",
"priceListStartDate": "2022-01-11",
"priceListEndDate": "2022-03-12",
"noOfDays": "60",
"priceItemCode": "PI_028",
"priceitemDescr": "V8-Cheque Collections",
"priceAsgnId": "5410009213",
"validityFlag": "",
"sourceEntityType": "",
"sourceEntityCode": "",
"priceListInfo": "",
"priceComponent":
{
    "priceCompId": "5417300046",
    "pricecomptier"
    {
        "priceCompSequenceNo": "0",
        "businessObjectDataArea": "",
        "priceItemParmGroupId": "1",
        "toVal": "1000.0000000000000000000000",
        "fromVal": "0.0000000000000000000000",
        "timeOfUse": "",
        "priceItemCode": "PI_026",
        "priceCriteria": "NBRTRAN",
        "priceCompId": "",
        "tieSeqNum": "10",
        "version": "0",
    }
    "priceComponentDescription": "FLAT",
    "valueAmt": "2.05000000000000000000",
    "priceComponentDisplay": "false",
    "rcMapId": "",
    "tieredFlag": "",
    "priceCompSequenceNo2": "0",
    }
}
}
{
"priority": "3",
"priceListId": "5417730766",
"priceListDescription": "PriceList -1",
"priceListStartDate": "2022-01-11",
"priceListEndDate": "2022-03-12",
"noOfDays": "60",
"priceItemCode": "PI_029",
"priceitemDescr": "V9-Domestic Liquidity",
"priceAsgnId": "5410009214",
"validityFlag": "",
"sourceEntityType": "",
"sourceEntityCode": "",
"priceListInfo": "",
"priceComponent":
{
    "priceCompId": "5417300048",
    "pricecomptier"
    {

```

```

        "priceComponentDescription": "FLAT",
        "valueAmt": "0.400000000000000000",
        "priceComponentDisplay": "false",
        "rcMapId": "",
        "tieredFlag": "",
        "priceCompSequenceNo2": "0",
    }
}
}
{
    "priority": "3",
    "priceListId": "5417730766",
    "priceListDescription": "PriceList -1",
    "priceListStartDate": "2022-01-11",
    "priceListEndDate": "2022-03-12",
    "noOfDays": "60",
    "priceItemCode": "PI_030",
    "priceitemDescr": "V10-Third Party Bank",
    "priceAsgnId": "5410009215",
    "validityFlag": "",
    "sourceEntityType": "",
    "sourceEntityCode": "",
    "priceListInfo": "",
    "priceComponent":
    {
        "priceCompId": "5417300050",
        "pricecomptier"
        {
            "priceComponentDescription": "FLAT",
            "valueAmt": "0.600000000000000000",
            "priceComponentDisplay": "false",
            "rcMapId": "",
            "tieredFlag": "",
            "priceCompSequenceNo2": "0",
        }
    }
}
}
{
    "priority": "3",
    "priceListId": "5417730766",
    "priceListDescription": "PriceList -1",
    "priceListStartDate": "2022-01-11",
    "priceListEndDate": "2022-03-12",
    "noOfDays": "60",
    "priceItemCode": "PI_031",
    "priceitemDescr": "MT943_SWIFT_01",
    "priceAsgnId": "5410009201",
    "validityFlag": "",
    "sourceEntityType": "",
    "sourceEntityCode": "",
    "priceListInfo": "",
    "priceComponent":
    {
        "priceCompId": "5417300002",
        "pricecomptier"
        {
            "priceComponentDescription": "FLAT",
            "valueAmt": "16.660000000000000000",
            "priceComponentDisplay": "false",
            "rcMapId": "",
            "tieredFlag": "",
            "priceCompSequenceNo2": "0",
        }
    }
}
}

```

```

    }
    {
      "priority": "3",
      "priceListId": "5417730766",
      "priceListDescription": "PriceList -1",
      "priceListStartDate": "2022-01-11",
      "priceListEndDate": "2022-03-12",
      "noOfDays": "60",
      "priceItemCode": "PI_032",
      "priceitemDescr": "MT943_SWIFT_02",
      "priceAsgnId": "5410009261",
      "validityFlag": "",
      "sourceEntityType": "",
      "sourceEntityCode": "",
      "priceListInfo": "",
      "priceComponent":
      {
        "priceCompId": "5417450002",
        "pricecomptier":
        "priceComponentDescription": "FLAT",
        "valueAmt": "15.000000000000000000",
        "priceComponentDisplay": "false",
        "rcMapId": "",
        "tieredFlag": "",
        "priceCompSequenceNo2": "0",
      }
    }
  }
}
"messageCategory": "0",
"messageNumber dataType": "0",
"messageText": "",
"longDescription": "",
"inquiryTypeFlag": "DETL",
}
}

```

Related Topics

For more information on...	See...
Eligible Market Products, Offers, or Bundles Derivation Request and Response - Attribute/Value Pairs in JSON Format	Eligible Market Products, Offers, or Bundles Derivation Request and Response - Attribute/Value Pairs in JSON Format on page 3382

Sample Eligible Bundle Derivation Request and Response in the JSON Format

Using the below example, you can derive eligible bundles of the **2406432705** account which is processed on date 2022-01-11.

Sample Eligible Bundle Request in the JSON Format

```

{
  "C1_GETELIGIBLEPROD":
  {
    "productCode": "LOAN_001",
    "productCategoryFlg": "",
    "division": "IND",
    "entityType": "BNDL",
    "entityCode": "CHECKBUND_003",
    "processDate": "2022-01-11",
    "accountId": "",
    "acctIdtype": "",
  }
}

```

```

    "acctIdentifierValue": "",
    "personId": "",
    "custIdTypeCd": "",
    "perIdentifireVal": "",
    "productLinkedEntity":
    {
        "linkedEntityCode": "CHECKMP_001",
        "linkedEntityType": "MP",
    }
    "eligibleParameter":
    {
        "priceParmCode": "",
        "priceParmVal": "",
    }
}
}

```

Sample Eligible Bundle Response in the JSON Format

```

{
  "C1_GETELIGIBLEPROD":
  {
    "productCode": "LOAN_001",
    "productCategoryFlg": "",
    "division": "IND",
    "entityType": "BNDL",
    "entityCode": "CHECKBUND_003",
    "processDate": "2022-01-11",
    "accountId": "",
    "acctIdtype": "",
    "acctIdentifierValue": "",
    "personId": "",
    "custIdTypeCd": "",
    "perIdentifireVal": "",
    "productLinkedEntity":
    {
        "linkedEntityCode": "CHECKMP_001",
        "linkedEntityType": "MP",
    }
    "eligibleParameter":
    {
        "priceParmCode": "",
        "priceParmVal": "",
    }
    "entityList":
    {
        "entityCode": "CHECKBUND_003",
        "entityType": "BNDL",
        "entityName": "CHECKBUND_003",
        "entityStartDate": "2022-01-11",
        "entityEndDate": "",
        "entityCodeDescr": "",
        "termsAndCondition": "TERMSPRAAS",
        "termAndConditionDescr": "TERMSPRAAS",
        "status": "ACTIVE",
        "productList":
        {
            "productCode": "LOAN_001",
            "productDescription": "LOAN_001",
            "productTypFlgDesc": "Product",
            "productCategoryFlgDesc": "Loans",
        }
        "productLinkedEntity":
        {

```

```

    "linkedEntityStartDate": "",
    "linkedEntityEndDate": "",
    "linkedEntityCode": "CHECKMP_001",
    "linkedEntityType": "MP",
  }
  {
    "linkedEntityStartDate": "",
    "linkedEntityEndDate": "",
    "linkedEntityCode": "CHEKCOMP_002",
    "linkedEntityType": "MP",
  }
  "EntityDivision":
  {
    "divisionCode": "IND",
  }
  "eligibilityDetails":
  {
    "eligibilityStartDate": "2022-01-11",
    "eligibilityEndDate": "",
    "eligibilityDescription": "LOANDBUND_001",
    "eligibilityRule":
    {
      "sequenceNumber": "10",
      "lhsPriceParmCd": "ACC_DIVISION",
      "operator": "=",
      "rhsPriceParmCd": "MH",
      "rhsPriceParmVal": "",
      "lhsPriceParmCd1": "",
      "rhsPriceParmTypeFlg": "VAL",
      "trueFlag": "RLTR",
      "falseFlag": "RLFS",
      "insufficientFlag": "RLFS",
    }
  }
  "services":
  {
    {
      "serviceName": "Product Service PRASS2",
      "mandatoryFlag": "true",
    }
    {
      "serviceName": "MH division product service",
      "mandatoryFlag": "true",
    }
    {
      "serviceName": "Product Service PRASS1",
      "mandatoryFlag": "true",
    }
  }
  "pricing"
  {
    {
      "priority": "1",
      "priceListId": "4368251923",
      "priceListDescription": "Currency_Con_PriceList -1",
      "priceListStartDate": "2022-01-11",
      "priceListEndDate": "2022-02-10",
      "noOfDays": "30",
      "priceItemCode": "CC_021",
      "priceitemDescr": "CC_21-Account Opening Fee",
      "priceAsgnId": "4360009281",
      "validityFlag": "",
      "sourceEntityType": "",
      "sourceEntityCode": "",
    }
  }

```



```

"priceListInfo": "",
"priceComponent":
{
  "priceCompId": "4367475002",
  "pricecomptier"
  {
    "priceCompSequenceNo": "",
    "businessObjectDataArea": "",
    "priceItemParmGroupId": "",
    "toVal": "",
    "fromVal": "",
    "timeOfUse": "",
    "priceItemCode": "",
    "priceCriteria": "",
    "priceCompId": "",
    "tieSeqNum": "",
    "version": "",
  }
  "priceComponentDescription": "FLAT",
  "valueAmt": "0.400000000000000000",
  "priceComponentDisplay": "false",
  "rcMapId": "",
  "tieredFlag": "",
  "priceCompSequenceNo2": "0",
}
}
{
"priority": "1",
"priceListId": "4368251923",
"priceListDescription": "Currency_Con_PriceList -1",
"priceListStartDate": "2022-01-11",
"priceListEndDate": "2022-02-10",
"noOfDays": "30",
"priceItemCode": "CC_022",
"priceitemDescr": "CC2-Monthly Acct Serv Fee",
"priceAsgnId": "4360009282",
"validityFlag": "",
"sourceEntityType": "",
"sourceEntityCode": "",
"priceListInfo": "",
"priceComponent":
{
  "priceCompId": "4367475004",
  "pricecomptier"
  {
    "priceCompSequenceNo": "",
    "businessObjectDataArea": "",
    "priceItemParmGroupId": "",
    "toVal": "",
    "fromVal": "",
    "timeOfUse": "",
    "priceItemCode": "",
    "priceCriteria": "",
    "priceCompId": "",
    "tieSeqNum": "",
    "version": "",
  }
  "priceComponentDescription": "FLAT",
  "valueAmt": "0.600000000000000000",
  "priceComponentDisplay": "false",
  "rcMapId": "",
  "tieredFlag": "",
  "priceCompSequenceNo2": "0",
}
}

```

```

    }
    {
      "priority": "1",
      "priceListId": "4368251923",
      "priceListDescription": "Currency_Con_PriceList -1",
      "priceListStartDate": "2022-01-11",
      "priceListEndDate": "2022-02-10",
      "noOfDays": "30",
      "priceItemCode": "CC_024",
      "priceitemDescr": "CC3-SEPA Transfers",
      "priceAsgnId": "4360009283",
      "validityFlag": "",
      "sourceEntityType": "",
      "sourceEntityCode": "",
      "priceListInfo": "",
      "priceComponent":
      {
        "priceCompId": "4367475006",
        "pricecomptier"
        {
          "priceCompSequenceNo": "",
          "businessObjectDataArea": "",
          "priceItemParmGroupId": "",
          "toVal": "",
          "fromVal": "",
          "timeOfUse": "",
          "priceItemCode": "",
          "priceCriteria": "",
          "priceCompId": "",
          "tieSeqNum": "",
          "version": "",
        }
        "priceComponentDescription": "FLAT",
        "valueAmt": "0.25000000000000000000",
        "priceComponentDisplay": "false",
        "rcMapId": "",
        "tieredFlag": "",
        "priceCompSequenceNo2": "0",
      }
    }
    {
      "priority": "1",
      "priceListId": "4368251923",
      "priceListDescription": "Currency_Con_PriceList -1",
      "priceListStartDate": "2022-01-11",
      "priceListEndDate": "2022-02-10",
      "noOfDays": "30",
      "priceItemCode": "CC_025",
      "priceitemDescr": "CC4-Domestic Funds Transfer Fee",
      "priceAsgnId": "4360009284",
      "validityFlag": "",
      "sourceEntityType": "",
      "sourceEntityCode": "",
      "priceListInfo": "",
      "priceComponent":
      {
        "priceCompId": "4367475008",
        "pricecomptier"
        {
          "priceCompSequenceNo": "",
          "businessObjectDataArea": "",
          "priceItemParmGroupId": "",
          "toVal": "",
          "fromVal": "",
        }
      }
    }
  }

```

```

        "timeOfUse": "",
        "priceItemCode": "",
        "priceCriteria": "",
        "priceCompId": "",
        "tieSeqNum": "",
        "version": "",
    }
    "priceComponentDescription": "FLAT",
    "valueAmt": "112.040000000000000000",
    "priceComponentDisplay": "false",
    "rcMapId": "",
    "tieredFlag": "",
    "priceCompSequenceNo2": "0",
}
}
{
    "priority": "2",
    "priceListId": "5417730766",
    "priceListDescription": "PriceList -1",
    "priceListStartDate": "2022-01-11",
    "priceListEndDate": "2022-01-21",
    "noOfDays": "10",
    "priceItemCode": "PI_021",
    "priceitemDescr": "V1-Account Opening Fee",
    "priceAsgnId": "5410009202",
    "validityFlag": "",
    "sourceEntityType": "",
    "sourceEntityCode": "",
    "priceListInfo": "",
    "priceComponent":
    {
        "priceCompId": "5417300004",
        "pricecomptier"
        {
            "priceCompSequenceNo": "",
            "businessObjectDataArea": "",
            "priceItemParmGroupId": "",
            "toVal": "",
            "fromVal": "",
            "timeOfUse": "",
            "priceItemCode": "",
            "priceCriteria": "",
            "priceCompId": "",
            "tieSeqNum": "",
            "version": "",
        }
        "priceComponentDescription": "FLAT",
        "valueAmt": "0.250000000000000000",
        "priceComponentDisplay": "false",
        "rcMapId": "",
        "tieredFlag": "",
        "priceCompSequenceNo2": "0",
    }
}
}
{
    "priority": "2",
    "priceListId": "5417730766",
    "priceListDescription": "PriceList -1",
    "priceListStartDate": "2022-01-11",
    "priceListEndDate": "2022-01-21",
    "noOfDays": "10",
    "priceItemCode": "PI_022",
    "priceitemDescr": "V2-Monthly Acct Serv Fee",
    "priceAsgnId": "5410009203",

```

```

"validityFlag": "",
"sourceEntityType": "",
"sourceEntityCode": "",
"priceListInfo": "",
"priceComponent":
{
  "priceCompId": "5417300006",
  "pricecomptier"
  {
    "priceCompSequenceNo": "",
    "businessObjectDataArea": "",
    "priceItemParmGroupId": "",
    "toVal": "",
    "fromVal": "",
    "timeOfUse": "",
    "priceItemCode": "",
    "priceCriteria": "",
    "priceCompId": "",
    "tieSeqNum": "",
    "version": ""
  }
  "priceComponentDescription": "FLAT",
  "valueAmt": "112.040000000000000000",
  "priceComponentDisplay": "false",
  "rcMapId": "",
  "tieredFlag": "",
  "priceCompSequenceNo2": "0",
}
}
{
"priority": "2",
"priceListId": "5417730766",
"priceListDescription": "PriceList -1",
"priceListStartDate": "2022-01-11",
"priceListEndDate": "2022-01-21",
"noOfDays": "10",
"priceItemCode": "PI_023",
"priceitemDescr": "V3-Audit Reports",
"priceAsgnId": "5410009204",
"validityFlag": "",
"sourceEntityType": "",
"sourceEntityCode": "",
"priceListInfo": "",
"priceComponent":
{
  "priceCompId": "5417300008",
  "pricecomptier"
  {
    "priceCompSequenceNo": "",
    "businessObjectDataArea": "",
    "priceItemParmGroupId": "",
    "toVal": "",
    "fromVal": "",
    "timeOfUse": "",
    "priceItemCode": "",
    "priceCriteria": "",
    "priceCompId": "",
    "tieSeqNum": "",
    "version": ""
  }
  "priceComponentDescription": "FLAT",
  "valueAmt": "276.250000000000000000",
  "priceComponentDisplay": "false",
  "rcMapId": "",

```

```

        "tieredFlag": "",
        "priceCompSequenceNo2": "0",
    }
}
{
    "priority": "2",
    "priceListId": "5417730766",
    "priceListDescription": "PriceList -1",
    "priceListStartDate": "2022-01-11",
    "priceListEndDate": "2022-01-21",
    "noOfDays": "10",
    "priceItemCode": "PI_024",
    "priceitemDescr": "V4-SEPA Transfers",
    "priceAsgnId": "5410009241",
    "validityFlag": "",
    "sourceEntityType": "",
    "sourceEntityCode": "",
    "priceListInfo": "",
    "priceComponent":
    {
        {
            "priceCompId": "5417400004",
            "priccomptier"
            {
                {
                    "priceCompSequenceNo": "0",
                    "businessObjectDataArea": "",
                    "priceItemParmGroupId": "1",
                    "toVal": "1000.0000000000000000000000",
                    "fromVal": "0.0000000000000000000000",
                    "timeOfUse": "",
                    "priceItemCode": "PI_024",
                    "priceCriteria": "NBRTRAN",
                    "priceCompId": "",
                    "tieSeqNum": "10",
                    "version": "0",
                }
            }
            {
                "priceCompSequenceNo": "0",
                "businessObjectDataArea": "",
                "priceItemParmGroupId": "1",
                "toVal": "5000.0000000000000000000000",
                "fromVal": "1000.0000000000000000000000",
                "timeOfUse": "",
                "priceItemCode": "PI_024",
                "priceCriteria": "NBRTRAN",
                "priceCompId": "",
                "tieSeqNum": "10",
                "version": "0",
            }
        }
        {
            "priceCompSequenceNo": "0",
            "businessObjectDataArea": "",
            "priceItemParmGroupId": "1",
            "toVal": "999999999999.9900000000000000000000",
            "fromVal": "5000.0000000000000000000000",
            "timeOfUse": "",
            "priceItemCode": "PI_024",
            "priceCriteria": "NBRTRAN",
            "priceCompId": "",
            "tieSeqNum": "10",
            "version": "0",
        }
    }
}
}

```

```

- Step Tier 1",
    "priceComponentDescription": "Price per transaction",
    "valueAmt": "12.950000000000000000",
    "priceComponentDisplay": "false",
    "rcMapId": "",
    "tieredFlag": "",
    "priceCompSequenceNo2": "0",
  }
  {
    "priceCompId": "5417400005",
    "pricecomptier"
    {
      {
        "priceCompSequenceNo": "0",
        "businessObjectDataArea": "",
        "priceItemParmGroupId": "1",
        "toVal": "1000.000000000000000000",
        "fromVal": "0.000000000000000000",
        "timeOfUse": "",
        "priceItemCode": "PI_024",
        "priceCriteria": "NBRTRAN",
        "priceCompId": "",
        "tieSeqNum": "10",
        "version": "0",
      }
      {
        "priceCompSequenceNo": "0",
        "businessObjectDataArea": "",
        "priceItemParmGroupId": "1",
        "toVal": "5000.000000000000000000",
        "fromVal": "1000.000000000000000000",
        "timeOfUse": "",
        "priceItemCode": "PI_024",
        "priceCriteria": "NBRTRAN",
        "priceCompId": "",
        "tieSeqNum": "10",
        "version": "0",
      }
    }
  }
- Step Tier 2",
    "priceComponentDescription": "Price per transaction",
    "valueAmt": "12.150000000000000000",
    "priceComponentDisplay": "false",
    "rcMapId": "",
    "tieredFlag": "",
    "priceCompSequenceNo2": "0",
  }
  {
    "priceCompId": "5417400006",
    "pricecomptier"
    {

```

```

        {
            "priceCompSequenceNo": "0",
            "businessObjectDataArea": "",
            "priceItemParmGroupId": "1",
            "toVal": "1000.00000000000000000000",
            "fromVal": "0.00000000000000000000",
            "timeOfUse": "",
            "priceItemCode": "PI_024",
            "priceCriteria": "NBRTRAN",
            "priceCompId": "",
            "tieSeqNum": "10",
            "version": "0",
        }
    }
    {
        "priceCompSequenceNo": "0",
        "businessObjectDataArea": "",
        "priceItemParmGroupId": "1",
        "toVal": "5000.00000000000000000000",
        "fromVal": "1000.00000000000000000000",
        "timeOfUse": "",
        "priceItemCode": "PI_024",
        "priceCriteria": "NBRTRAN",
        "priceCompId": "",
        "tieSeqNum": "10",
        "version": "0",
    }
}
    {
        "priceCompSequenceNo": "0",
        "businessObjectDataArea": "",
        "priceItemParmGroupId": "1",
        "toVal": "999999999999.99000000000000000000",
        "fromVal": "5000.00000000000000000000",
        "timeOfUse": "",
        "priceItemCode": "PI_024",
        "priceCriteria": "NBRTRAN",
        "priceCompId": "",
        "tieSeqNum": "10",
        "version": "0",
    }
}
    }
    "priceComponentDescription": "Price per transaction
- Step Tier 3",
    "valueAmt": "11.95000000000000000000",
    "priceComponentDisplay": "false",
    "rcMapId": "",
    "tieredFlag": "",
    "priceCompSequenceNo2": "0",
}
}
{
    "priority": "2",
    "priceListId": "5417730766",
    "priceListDescription": "PriceList -1",
    "priceListStartDate": "2022-01-11",
    "priceListEndDate": "2022-01-21",
    "noOfDays": "10",
    "priceItemCode": "PI_025",
    "priceitemDescr": "V5-Domestic Funds Transfer Fee",
    "priceAsgnId": "5410009242",
    "validityFlag": "",
    "sourceEntityType": "",
    "sourceEntityCode": "",
    "priceListInfo": "",
    "priceComponent":

```

```

    {
      {
        "priceCompId": "5417400010",
        "pricecomptier"
        {
          {
            "priceCompSequenceNo": "0",
            "businessObjectDataArea": "",
            "priceItemParmGroupId": "1",
            "toVal": "1000.00000000000000000000",
            "fromVal": "0.00000000000000000000",
            "timeOfUse": "",
            "priceItemCode": "PI_025",
            "priceCriteria": "NBRTRAN",
            "priceCompId": "",
            "tieSeqNum": "10",
            "version": "0",
          }
          {
            "priceCompSequenceNo": "0",
            "businessObjectDataArea": "",
            "priceItemParmGroupId": "1",
            "toVal": "5000.00000000000000000000",
            "fromVal": "1000.00000000000000000000",
            "timeOfUse": "",
            "priceItemCode": "PI_025",
            "priceCriteria": "NBRTRAN",
            "priceCompId": "",
            "tieSeqNum": "10",
            "version": "0",
          }
          {
            "priceCompSequenceNo": "0",
            "businessObjectDataArea": "",
            "priceItemParmGroupId": "1",
            "toVal": "999999999999.99000000000000000000",
            "fromVal": "5000.00000000000000000000",
            "timeOfUse": "",
            "priceItemCode": "PI_025",
            "priceCriteria": "NBRTRAN",
            "priceCompId": "",
            "tieSeqNum": "10",
            "version": "0",
          }
        }
        "priceComponentDescription": "Threshold price
per transaction",
        "valueAmt": "12.95000000000000000000",
        "priceComponentDisplay": "false",
        "rcMapId": "",
        "tieredFlag": "",
        "priceCompSequenceNo2": "0",
      }
    }
    "priceCompId": "5417400011",
    "pricecomptier"
    {
      {
        "priceCompSequenceNo": "0",
        "businessObjectDataArea": "",
        "priceItemParmGroupId": "1",
        "toVal": "1000.00000000000000000000",
        "fromVal": "0.00000000000000000000",
        "timeOfUse": "",

```



```

        "priceItemCode": "PI_025",
        "priceCriteria": "NBRTRAN",
        "priceCompId": "",
        "tieSeqNum": "10",
        "version": "0",
    }
}
{
    "priceCompSequenceNo": "0",
    "businessObjectDataArea": "",
    "priceItemParmGroupId": "1",
    "toVal": "5000.00000000000000000000",
    "fromVal": "1000.00000000000000000000",
    "timeOfUse": "",
    "priceItemCode": "PI_025",
    "priceCriteria": "NBRTRAN",
    "priceCompId": "",
    "tieSeqNum": "10",
    "version": "0",
}
}
{
    "priceCompSequenceNo": "0",
    "businessObjectDataArea": "",
    "priceItemParmGroupId": "1",
    "toVal": "99999999999.99000000000000000000",
    "fromVal": "5000.00000000000000000000",
    "timeOfUse": "",
    "priceItemCode": "PI_025",
    "priceCriteria": "NBRTRAN",
    "priceCompId": "",
    "tieSeqNum": "10",
    "version": "0",
}
}
    "priceComponentDescription": "Threshold price
per transaction",
    "valueAmt": "12.15000000000000000000",
    "priceComponentDisplay": "false",
    "rcMapId": "",
    "tieredFlag": "",
    "priceCompSequenceNo2": "0",
}
}
    "priceCompId": "5417400012",
    "pricecomptier"
    {
        {
            "priceCompSequenceNo": "0",
            "businessObjectDataArea": "",
            "priceItemParmGroupId": "1",
            "toVal": "1000.00000000000000000000",
            "fromVal": "0.00000000000000000000",
            "timeOfUse": "",
            "priceItemCode": "PI_025",
            "priceCriteria": "NBRTRAN",
            "priceCompId": "",
            "tieSeqNum": "10",
            "version": "0",
        }
    }
    {
        "priceCompSequenceNo": "0",
        "businessObjectDataArea": "",
        "priceItemParmGroupId": "1",
        "toVal": "5000.00000000000000000000",
        "fromVal": "1000.00000000000000000000",
    }
}

```

```

        "timeOfUse": "",
        "priceItemCode": "PI_025",
        "priceCriteria": "NBRTRAN",
        "priceCompId": "",
        "tieSeqNum": "10",
        "version": "0",
    }
}
{
    "priceCompSequenceNo": "0",
    "businessObjectDataArea": "",
    "priceItemParmGroupId": "1",
    "toVal": "999999999999.99000000000000000000",
    "fromVal": "5000.00000000000000000000",
    "timeOfUse": "",
    "priceItemCode": "PI_025",
    "priceCriteria": "NBRTRAN",
    "priceCompId": "",
    "tieSeqNum": "10",
    "version": "0",
}
}
    "priceComponentDescription": "Threshold price
per transaction",
    "valueAmt": "11.950000000000000000",
    "priceComponentDisplay": "false",
    "rcMapId": "",
    "tieredFlag": "",
    "priceCompSequenceNo2": "0",
}
}
}
{
    "priority": "2",
    "priceListId": "5417730766",
    "priceListDescription": "PriceList -1",
    "priceListStartDate": "2022-01-11",
    "priceListEndDate": "2022-01-21",
    "noOfDays": "10",
    "priceItemCode": "PI_026",
    "priceitemDescr": "V6-Electronic Credits",
    "priceAsgnId": "5410009243",
    "validityFlag": "",
    "sourceEntityType": "",
    "sourceEntityCode": "",
    "priceListInfo": "",
    "priceComponent":
    {
        {
            "priceCompId": "5417400020",
            "priccomptier"
            {
                {
                    "priceCompSequenceNo": "0",
                    "businessObjectDataArea": "",
                    "priceItemParmGroupId": "1",
                    "toVal": "1000.00000000000000000000",
                    "fromVal": "0.00000000000000000000",
                    "timeOfUse": "",
                    "priceItemCode": "PI_026",
                    "priceCriteria": "NBRTRAN",
                    "priceCompId": "",
                    "tieSeqNum": "10",
                    "version": "0",
                }
            }
        }
    }
}

```

```

{
  "priceCompSequenceNo": "0",
  "businessObjectDataArea": "",
  "priceItemParmGroupId": "1",
  "toVal": "5000.00000000000000000000",
  "fromVal": "1000.00000000000000000000",
  "timeOfUse": "",
  "priceItemCode": "PI_026",
  "priceCriteria": "NBRTRAN",
  "priceCompId": "",
  "tieSeqNum": "10",
  "version": "0",
}
{
  "priceCompSequenceNo": "0",
  "businessObjectDataArea": "",
  "priceItemParmGroupId": "1",
  "toVal": "999999999999.99000000000000000000",
  "fromVal": "5000.00000000000000000000",
  "timeOfUse": "",
  "priceItemCode": "PI_026",
  "priceCriteria": "NBRTRAN",
  "priceCompId": "",
  "tieSeqNum": "10",
  "version": "0",
}
{
  "priceCompSequenceNo": "0",
  "businessObjectDataArea": "",
  "priceItemParmGroupId": "1",
  "toVal": "1000.00000000000000000000",
  "fromVal": "0.00000000000000000000",
  "timeOfUse": "",
  "priceItemCode": "PI_026",
  "priceCriteria": "NBRTRAN",
  "priceCompId": "",
  "tieSeqNum": "10",
  "version": "0",
}
{
  "priceCompSequenceNo": "0",
  "businessObjectDataArea": "",
  "priceItemParmGroupId": "1",
  "toVal": "5000.00000000000000000000",
  "fromVal": "1000.00000000000000000000",
  "timeOfUse": "",
  "priceItemCode": "PI_026",
  "priceCriteria": "NBRTRAN",
  "priceCompId": "",
  "tieSeqNum": "10",
  "version": "0",
}
{
  "priceCompSequenceNo": "0",
  "businessObjectDataArea": "",
  "priceItemParmGroupId": "1",
  "toVal": "999999999999.99000000000000000000",
  "fromVal": "5000.00000000000000000000",
  "timeOfUse": "",
  "priceItemCode": "PI_026",
  "priceCriteria": "NBRTRAN",
  "priceCompId": "",
  "tieSeqNum": "10",
  "version": "0",
}

```

```

    }
  }
  "priceComponentDescription": "Basic charges",
  "valueAmt": "20.000000000000000000",
  "priceComponentDisplay": "false",
  "rcMapId": "",
  "tieredFlag": "",
  "priceCompSequenceNo2": "0",
}
{
  "priceCompId": "5417400021",
  "pricecomptier"
  {
    {
      "priceCompSequenceNo": "0",
      "businessObjectDataArea": "",
      "priceItemParmGroupId": "1",
      "toVal": "1000.000000000000000000",
      "fromVal": "0.000000000000000000",
      "timeOfUse": "",
      "priceItemCode": "PI_026",
      "priceCriteria": "NBRTRAN",
      "priceCompId": "",
      "tieSeqNum": "10",
      "version": "0",
    }
    {
      "priceCompSequenceNo": "0",
      "businessObjectDataArea": "",
      "priceItemParmGroupId": "1",
      "toVal": "5000.000000000000000000",
      "fromVal": "1000.000000000000000000",
      "timeOfUse": "",
      "priceItemCode": "PI_026",
      "priceCriteria": "NBRTRAN",
      "priceCompId": "",
      "tieSeqNum": "10",
      "version": "0",
    }
    {
      "priceCompSequenceNo": "0",
      "businessObjectDataArea": "",
      "priceItemParmGroupId": "1",
      "toVal": "99999999999.990000000000000000",
      "fromVal": "5000.000000000000000000",
      "timeOfUse": "",
      "priceItemCode": "PI_026",
      "priceCriteria": "NBRTRAN",
      "priceCompId": "",
      "tieSeqNum": "10",
      "version": "0",
    }
    {
      "priceCompSequenceNo": "0",
      "businessObjectDataArea": "",
      "priceItemParmGroupId": "1",
      "toVal": "1000.000000000000000000",
      "fromVal": "0.000000000000000000",
      "timeOfUse": "",
      "priceItemCode": "PI_026",
      "priceCriteria": "NBRTRAN",
      "priceCompId": "",
      "tieSeqNum": "10",
      "version": "0",
    }
  }
}

```

```

    }
    {
      "priceCompSequenceNo": "0",
      "businessObjectDataArea": "",
      "priceItemParmGroupId": "1",
      "toVal": "5000.000000000000000000000000",
      "fromVal": "1000.000000000000000000000000",
      "timeOfUse": "",
      "priceItemCode": "PI_026",
      "priceCriteria": "NBRTRAN",
      "priceCompId": "",
      "tieSeqNum": "10",
      "version": "0",
    }
  }
  {
    "priceCompSequenceNo": "0",
    "businessObjectDataArea": "",
    "priceItemParmGroupId": "1",
    "toVal": "999999999999.990000000000000000000000",
    "fromVal": "5000.000000000000000000000000",
    "timeOfUse": "",
    "priceItemCode": "PI_026",
    "priceCriteria": "NBRTRAN",
    "priceCompId": "",
    "tieSeqNum": "10",
    "version": "0",
  }
}
"priceComponentDescription": "Threshold price",
"valueAmt": "10.000000000000000000000000",
"priceComponentDisplay": "false",
"rcMapId": "",
"tieredFlag": "",
"priceCompSequenceNo2": "0",
}
{
  "priceCompId": "5417400022",
  "pricecomptier"
  {
    {
      "priceCompSequenceNo": "0",
      "businessObjectDataArea": "",
      "priceItemParmGroupId": "1",
      "toVal": "1000.000000000000000000000000",
      "fromVal": "0.000000000000000000000000",
      "timeOfUse": "",
      "priceItemCode": "PI_026",
      "priceCriteria": "NBRTRAN",
      "priceCompId": "",
      "tieSeqNum": "10",
      "version": "0",
    }
  }
  {
    "priceCompSequenceNo": "0",
    "businessObjectDataArea": "",
    "priceItemParmGroupId": "1",
    "toVal": "5000.000000000000000000000000",
    "fromVal": "1000.000000000000000000000000",
    "timeOfUse": "",
    "priceItemCode": "PI_026",
    "priceCriteria": "NBRTRAN",
    "priceCompId": "",
    "tieSeqNum": "10",
    "version": "0",
  }
}

```

```

    }
    {
      "priceCompSequenceNo": "0",
      "businessObjectDataArea": "",
      "priceItemParmGroupId": "1",
      "toVal": "999999999999.99000000000000000000",
      "fromVal": "5000.00000000000000000000",
      "timeOfUse": "",
      "priceItemCode": "PI_026",
      "priceCriteria": "NBRTRAN",
      "priceCompId": "",
      "tieSeqNum": "10",
      "version": "0",
    }
  }
  {
    "priceCompSequenceNo": "0",
    "businessObjectDataArea": "",
    "priceItemParmGroupId": "1",
    "toVal": "1000.00000000000000000000",
    "fromVal": "0.00000000000000000000",
    "timeOfUse": "",
    "priceItemCode": "PI_026",
    "priceCriteria": "NBRTRAN",
    "priceCompId": "",
    "tieSeqNum": "10",
    "version": "0",
  }
}
{
  "priceCompSequenceNo": "0",
  "businessObjectDataArea": "",
  "priceItemParmGroupId": "1",
  "toVal": "5000.00000000000000000000",
  "fromVal": "1000.00000000000000000000",
  "timeOfUse": "",
  "priceItemCode": "PI_026",
  "priceCriteria": "NBRTRAN",
  "priceCompId": "",
  "tieSeqNum": "10",
  "version": "0",
}
}
{
  "priceCompSequenceNo": "0",
  "businessObjectDataArea": "",
  "priceItemParmGroupId": "1",
  "toVal": "999999999999.99000000000000000000",
  "fromVal": "5000.00000000000000000000",
  "timeOfUse": "",
  "priceItemCode": "PI_026",
  "priceCriteria": "NBRTRAN",
  "priceCompId": "",
  "tieSeqNum": "10",
  "version": "0",
}
}
}
"priceComponentDescription": "Threshold price",
"valueAmt": "8.00000000000000000000",
"priceComponentDisplay": "false",
"rcMapId": "",
"tieredFlag": "",
"priceCompSequenceNo2": "0",
}
}
"priceCompId": "5417400023",
"pricecomptier"

```

```

{
  {
    "priceCompSequenceNo": "0",
    "businessObjectDataArea": "",
    "priceItemParmGroupId": "1",
    "toVal": "1000.000000000000000000000000",
    "fromVal": "0.000000000000000000000000",
    "timeOfUse": "",
    "priceItemCode": "PI_026",
    "priceCriteria": "NBRTRAN",
    "priceCompId": "",
    "tieSeqNum": "10",
    "version": "0",
  }
  {
    "priceCompSequenceNo": "0",
    "businessObjectDataArea": "",
    "priceItemParmGroupId": "1",
    "toVal": "5000.000000000000000000000000",
    "fromVal": "1000.000000000000000000000000",
    "timeOfUse": "",
    "priceItemCode": "PI_026",
    "priceCriteria": "NBRTRAN",
    "priceCompId": "",
    "tieSeqNum": "10",
    "version": "0",
  }
  {
    "priceCompSequenceNo": "0",
    "businessObjectDataArea": "",
    "priceItemParmGroupId": "1",
    "toVal": "999999999999.990000000000000000000000",
    "fromVal": "5000.000000000000000000000000",
    "timeOfUse": "",
    "priceItemCode": "PI_026",
    "priceCriteria": "NBRTRAN",
    "priceCompId": "",
    "tieSeqNum": "10",
    "version": "0",
  }
  {
    "priceCompSequenceNo": "0",
    "businessObjectDataArea": "",
    "priceItemParmGroupId": "1",
    "toVal": "1000.000000000000000000000000",
    "fromVal": "0.000000000000000000000000",
    "timeOfUse": "",
    "priceItemCode": "PI_026",
    "priceCriteria": "NBRTRAN",
    "priceCompId": "",
    "tieSeqNum": "10",
    "version": "0",
  }
  {
    "priceCompSequenceNo": "0",
    "businessObjectDataArea": "",
    "priceItemParmGroupId": "1",
    "toVal": "5000.000000000000000000000000",
    "fromVal": "1000.000000000000000000000000",
    "timeOfUse": "",
    "priceItemCode": "PI_026",
    "priceCriteria": "NBRTRAN",
    "priceCompId": "",
    "tieSeqNum": "10",
  }
}

```

```

        "version": "0",
    }
}
    "priceCompSequenceNo": "0",
    "businessObjectDataArea": "",
    "priceItemParmGroupId": "1",
    "toVal": "99999999999.99000000000000000000",
    "fromVal": "5000.00000000000000000000",
    "timeOfUse": "",
    "priceItemCode": "PI_026",
    "priceCriteria": "NBRTRAN",
    "priceCompId": "",
    "tieSeqNum": "10",
    "version": "0",
}
}
    "priceComponentDescription": "Threshold price",
    "valueAmt": "6.00000000000000000000",
    "priceComponentDisplay": "false",
    "rcMapId": "",
    "tieredFlag": "",
    "priceCompSequenceNo2": "0",
}
}
    "priceCompId": "5417400024",
    "pricemcomptier"
    {
        {
            "priceCompSequenceNo": "0",
            "businessObjectDataArea": "",
            "priceItemParmGroupId": "1",
            "toVal": "1000.00000000000000000000",
            "fromVal": "0.00000000000000000000",
            "timeOfUse": "",
            "priceItemCode": "PI_026",
            "priceCriteria": "NBRTRAN",
            "priceCompId": "",
            "tieSeqNum": "10",
            "version": "0",
        }
        {
            "priceCompSequenceNo": "0",
            "businessObjectDataArea": "",
            "priceItemParmGroupId": "1",
            "toVal": "5000.00000000000000000000",
            "fromVal": "1000.00000000000000000000",
            "timeOfUse": "",
            "priceItemCode": "PI_026",
            "priceCriteria": "NBRTRAN",
            "priceCompId": "",
            "tieSeqNum": "10",
            "version": "0",
        }
        {
            "priceCompSequenceNo": "0",
            "businessObjectDataArea": "",
            "priceItemParmGroupId": "1",
            "toVal": "99999999999.99000000000000000000",
            "fromVal": "5000.00000000000000000000",
            "timeOfUse": "",
            "priceItemCode": "PI_026",
            "priceCriteria": "NBRTRAN",
            "priceCompId": "",
        }
    }
}

```



```

        "tieSeqNum": "10",
        "version": "0",
    }
}
    "priceCompSequenceNo": "0",
    "businessObjectDataArea": "",
    "priceItemParmGroupId": "1",
    "toVal": "1000.00000000000000000000",
    "fromVal": "0.00000000000000000000",
    "timeOfUse": "",
    "priceItemCode": "PI_026",
    "priceCriteria": "NBRTRAN",
    "priceCompId": "",
    "tieSeqNum": "10",
    "version": "0",
}
}
    "priceCompSequenceNo": "0",
    "businessObjectDataArea": "",
    "priceItemParmGroupId": "1",
    "toVal": "5000.00000000000000000000",
    "fromVal": "1000.00000000000000000000",
    "timeOfUse": "",
    "priceItemCode": "PI_026",
    "priceCriteria": "NBRTRAN",
    "priceCompId": "",
    "tieSeqNum": "10",
    "version": "0",
}
}
    "priceCompSequenceNo": "0",
    "businessObjectDataArea": "",
    "priceItemParmGroupId": "1",
    "toVal": "999999999999.99000000000000000000",
    "fromVal": "5000.00000000000000000000",
    "timeOfUse": "",
    "priceItemCode": "PI_026",
    "priceCriteria": "NBRTRAN",
    "priceCompId": "",
    "tieSeqNum": "10",
    "version": "0",
}
}
    "priceComponentDescription": "Step 1",
    "valueAmt": "5.00000000000000000000",
    "priceComponentDisplay": "false",
    "rcMapId": "",
    "tieredFlag": "",
    "priceCompSequenceNo2": "0",
}
}
    "priceCompId": "5417400025",
    "pricemcptier"
    {
        {
            "priceCompSequenceNo": "0",
            "businessObjectDataArea": "",
            "priceItemParmGroupId": "1",
            "toVal": "1000.00000000000000000000",
            "fromVal": "0.00000000000000000000",
            "timeOfUse": "",
            "priceItemCode": "PI_026",
            "priceCriteria": "NBRTRAN",
            "priceCompId": "",
        }
    }
}

```

```

        "tieSeqNum": "10",
        "version": "0",
    }
}

    "priceCompSequenceNo": "0",
    "businessObjectDataArea": "",
    "priceItemParmGroupId": "1",
    "toVal": "5000.00000000000000000000",
    "fromVal": "1000.00000000000000000000",
    "timeOfUse": "",
    "priceItemCode": "PI_026",
    "priceCriteria": "NBRTRAN",
    "priceCompId": "",
    "tieSeqNum": "10",
    "version": "0",
}

    "priceCompSequenceNo": "0",
    "businessObjectDataArea": "",
    "priceItemParmGroupId": "1",
    "toVal": "999999999999.99000000000000000000",
    "fromVal": "5000.00000000000000000000",
    "timeOfUse": "",
    "priceItemCode": "PI_026",
    "priceCriteria": "NBRTRAN",
    "priceCompId": "",
    "tieSeqNum": "10",
    "version": "0",
}

    "priceCompSequenceNo": "0",
    "businessObjectDataArea": "",
    "priceItemParmGroupId": "1",
    "toVal": "1000.00000000000000000000",
    "fromVal": "0.00000000000000000000",
    "timeOfUse": "",
    "priceItemCode": "PI_026",
    "priceCriteria": "NBRTRAN",
    "priceCompId": "",
    "tieSeqNum": "10",
    "version": "0",
}

    "priceCompSequenceNo": "0",
    "businessObjectDataArea": "",
    "priceItemParmGroupId": "1",
    "toVal": "5000.00000000000000000000",
    "fromVal": "1000.00000000000000000000",
    "timeOfUse": "",
    "priceItemCode": "PI_026",
    "priceCriteria": "NBRTRAN",
    "priceCompId": "",
    "tieSeqNum": "10",
    "version": "0",
}

    "priceCompSequenceNo": "0",
    "businessObjectDataArea": "",
    "priceItemParmGroupId": "1",
    "toVal": "999999999999.99000000000000000000",
    "fromVal": "5000.00000000000000000000",
    "timeOfUse": "",
    "priceItemCode": "PI_026",
    "priceCriteria": "NBRTRAN",

```

```

        "priceCompId": "",
        "tieSeqNum": "10",
        "version": "0",
    }
}
"priceComponentDescription": "Step 2",
"valueAmt": "4.000000000000000000",
"priceComponentDisplay": "false",
"rcMapId": "",
"tieredFlag": "",
"priceCompSequenceNo2": "0",
}
{
"priceCompId": "5417400026",
"pricemcptier"
{
    {
        "priceCompSequenceNo": "0",
        "businessObjectDataArea": "",
        "priceItemParmGroupId": "1",
        "toVal": "1000.000000000000000000",
        "fromVal": "0.000000000000000000",
        "timeOfUse": "",
        "priceItemCode": "PI_026",
        "priceCriteria": "NBRTRAN",
        "priceCompId": "",
        "tieSeqNum": "10",
        "version": "0",
    }
    {
        "priceCompSequenceNo": "0",
        "businessObjectDataArea": "",
        "priceItemParmGroupId": "1",
        "toVal": "5000.000000000000000000",
        "fromVal": "1000.000000000000000000",
        "timeOfUse": "",
        "priceItemCode": "PI_026",
        "priceCriteria": "NBRTRAN",
        "priceCompId": "",
        "tieSeqNum": "10",
        "version": "0",
    }
    {
        "priceCompSequenceNo": "0",
        "businessObjectDataArea": "",
        "priceItemParmGroupId": "1",
        "toVal": "999999999999.990000000000000000",
        "fromVal": "5000.000000000000000000",
        "timeOfUse": "",
        "priceItemCode": "PI_026",
        "priceCriteria": "NBRTRAN",
        "priceCompId": "",
        "tieSeqNum": "10",
        "version": "0",
    }
    {
        "priceCompSequenceNo": "0",
        "businessObjectDataArea": "",
        "priceItemParmGroupId": "1",
        "toVal": "1000.000000000000000000",
        "fromVal": "0.000000000000000000",
        "timeOfUse": "",
        "priceItemCode": "PI_026",
        "priceCriteria": "NBRTRAN",
    }
}

```

```

        "priceCompId": "",
        "tieSeqNum": "10",
        "version": "0",
    }
    {
        "priceCompSequenceNo": "0",
        "businessObjectDataArea": "",
        "priceItemParmGroupId": "1",
        "toVal": "5000.00000000000000000000",
        "fromVal": "1000.00000000000000000000",
        "timeOfUse": "",
        "priceItemCode": "PI_026",
        "priceCriteria": "NBRTRAN",
        "priceCompId": "",
        "tieSeqNum": "10",
        "version": "0",
    }
    {
        "priceCompSequenceNo": "0",
        "businessObjectDataArea": "",
        "priceItemParmGroupId": "1",
        "toVal": "999999999999.99000000000000000000",
        "fromVal": "5000.00000000000000000000",
        "timeOfUse": "",
        "priceItemCode": "PI_026",
        "priceCriteria": "NBRTRAN",
        "priceCompId": "",
        "tieSeqNum": "10",
        "version": "0",
    }
}
"priceComponentDescription": "Step 3",
"valueAmt": "3.00000000000000000000",
"priceComponentDisplay": "false",
"rcMapId": "",
"tieredFlag": "",
"priceCompSequenceNo2": "0",
}
}
}
{
    "priority": "2",
    "priceListId": "5417730766",
    "priceListDescription": "PriceList -1",
    "priceListStartDate": "2022-01-11",
    "priceListEndDate": "2022-01-21",
    "noOfDays": "10",
    "priceItemCode": "PI_027",
    "priceitemDescr": "V7-Direct Debit",
    "priceAsgnId": "5410009209",
    "validityFlag": "",
    "sourceEntityType": "",
    "sourceEntityCode": "",
    "priceListInfo": "",
    "priceComponent":
    {
        "priceCompId": "5417300038",
        "pricecomptier"
        {
            "priceCompSequenceNo": "",
            "businessObjectDataArea": "",
            "priceItemParmGroupId": "",
            "toVal": "",
            "fromVal": "",
        }
    }
}

```

```

        "timeOfUse": "",
        "priceItemCode": "",
        "priceCriteria": "",
        "priceCompId": "",
        "tieSeqNum": "",
        "version": "",
    }
    "priceComponentDescription": "Basic BK-NBR",
    "valueAmt": "0.150000000000000000",
    "priceComponentDisplay": "false",
    "rcMapId": "",
    "tieredFlag": "",
    "priceCompSequenceNo2": "0",
}
}
{
    "priority": "2",
    "priceListId": "5417730766",
    "priceListDescription": "PriceList -1",
    "priceListStartDate": "2022-01-11",
    "priceListEndDate": "2022-01-21",
    "noOfDays": "10",
    "priceItemCode": "PI_028",
    "priceitemDescr": "V8-Cheque Collections",
    "priceAsgnId": "5410009210",
    "validityFlag": "",
    "sourceEntityType": "",
    "sourceEntityCode": "",
    "priceListInfo": "",
    "priceComponent":
    {
        "priceCompId": "5417300040",
        "pricecomptier"
        {
            "priceCompSequenceNo": "",
            "businessObjectDataArea": "",
            "priceItemParmGroupId": "",
            "toVal": "",
            "fromVal": "",
            "timeOfUse": "",
            "priceItemCode": "",
            "priceCriteria": "",
            "priceCompId": "",
            "tieSeqNum": "",
            "version": "",
        }
        "priceComponentDescription": "FLAT",
        "valueAmt": "0.750000000000000000",
        "priceComponentDisplay": "false",
        "rcMapId": "",
        "tieredFlag": "",
        "priceCompSequenceNo2": "0",
    }
}
}
{
    "priority": "2",
    "priceListId": "5417730766",
    "priceListDescription": "PriceList -1",
    "priceListStartDate": "2022-01-11",
    "priceListEndDate": "2022-01-21",
    "noOfDays": "10",
    "priceItemCode": "PI_028",
    "priceitemDescr": "V8-Cheque Collections",
    "priceAsgnId": "5410009211",

```

```

"validityFlag": "",
"sourceEntityType": "",
"sourceEntityCode": "",
"priceListInfo": "",
"priceComponent":
{
  "priceCompId": "5417300042",
  "pricecomptier"
  {
    "priceCompSequenceNo": "",
    "businessObjectDataArea": "",
    "priceItemParmGroupId": "",
    "toVal": "",
    "fromVal": "",
    "timeOfUse": "",
    "priceItemCode": "",
    "priceCriteria": "",
    "priceCompId": "",
    "tieSeqNum": "",
    "version": "",
  }
  "priceComponentDescription": "FLAT",
  "valueAmt": "6.670000000000000000",
  "priceComponentDisplay": "false",
  "rcMapId": "",
  "tieredFlag": "",
  "priceCompSequenceNo2": "0",
}
}
{
"priority": "2",
"priceListId": "5417730766",
"priceListDescription": "PriceList -1",
"priceListStartDate": "2022-01-11",
"priceListEndDate": "2022-01-21",
"noOfDays": "10",
"priceItemCode": "PI_028",
"priceitemDescr": "V8-Cheque Collections",
"priceAsgnId": "5410009212",
"validityFlag": "",
"sourceEntityType": "",
"sourceEntityCode": "",
"priceListInfo": "",
"priceComponent":
{
  "priceCompId": "5417300044",
  "pricecomptier"
  {
    "priceCompSequenceNo": "",
    "businessObjectDataArea": "",
    "priceItemParmGroupId": "",
    "toVal": "",
    "fromVal": "",
    "timeOfUse": "",
    "priceItemCode": "",
    "priceCriteria": "",
    "priceCompId": "",
    "tieSeqNum": "",
    "version": "",
  }
  "priceComponentDescription": "FLAT",
  "valueAmt": "0.300000000000000000",
  "priceComponentDisplay": "false",
  "rcMapId": "",

```

```

        "tieredFlag": "",
        "priceCompSequenceNo2": "0",
    }
}
{
    "priority": "2",
    "priceListId": "5417730766",
    "priceListDescription": "PriceList -1",
    "priceListStartDate": "2022-01-11",
    "priceListEndDate": "2022-01-21",
    "noOfDays": "10",
    "priceItemCode": "PI_028",
    "priceitemDescr": "V8-Cheque Collections",
    "priceAsgnId": "5410009213",
    "validityFlag": "",
    "sourceEntityType": "",
    "sourceEntityCode": "",
    "priceListInfo": "",
    "priceComponent":
    {
        "priceCompId": "5417300046",
        "pricecomptier"
        {
            "priceCompSequenceNo": "",
            "businessObjectDataArea": "",
            "priceItemParmGroupId": "",
            "toVal": "",
            "fromVal": "",
            "timeOfUse": "",
            "priceItemCode": "",
            "priceCriteria": "",
            "priceCompId": "",
            "tieSeqNum": "",
            "version": "",
        }
        "priceComponentDescription": "FLAT",
        "valueAmt": "2.050000000000000000",
        "priceComponentDisplay": "false",
        "rcMapId": "",
        "tieredFlag": "",
        "priceCompSequenceNo2": "0",
    }
}
{
    "priority": "2",
    "priceListId": "5417730766",
    "priceListDescription": "PriceList -1",
    "priceListStartDate": "2022-01-11",
    "priceListEndDate": "2022-01-21",
    "noOfDays": "10",
    "priceItemCode": "PI_029",
    "priceitemDescr": "V9-Domestic Liquidity",
    "priceAsgnId": "5410009214",
    "validityFlag": "",
    "sourceEntityType": "",
    "sourceEntityCode": "",
    "priceListInfo": "",
    "priceComponent":
    {
        "priceCompId": "5417300048",
        "pricecomptier"
        {
            "priceCompSequenceNo": "",
            "businessObjectDataArea": "",

```

```

        "priceItemParmGroupId": "",
        "toVal": "",
        "fromVal": "",
        "timeOfUse": "",
        "priceItemCode": "",
        "priceCriteria": "",
        "priceCompId": "",
        "tieSeqNum": "",
        "version": "",
    }
    "priceComponentDescription": "FLAT",
    "valueAmt": "0.400000000000000000",
    "priceComponentDisplay": "false",
    "rcMapId": "",
    "tieredFlag": "",
    "priceCompSequenceNo2": "0",
}
}
"priority": "2",
"priceListId": "5417730766",
"priceListDescription": "PriceList -1",
"priceListStartDate": "2022-01-11",
"priceListEndDate": "2022-01-21",
"noOfDays": "10",
"priceItemCode": "PI_030",
"priceitemDescr": "V10-Third Party Bank",
"priceAsgnId": "5410009215",
"validityFlag": "",
"sourceEntityType": "",
"sourceEntityCode": "",
"priceListInfo": "",
"priceComponent":
{
    "priceCompId": "5417300050",
    "pricecomptier"
    {
        "priceCompSequenceNo": "",
        "businessObjectDataArea": "",
        "priceItemParmGroupId": "",
        "toVal": "",
        "fromVal": "",
        "timeOfUse": "",
        "priceItemCode": "",
        "priceCriteria": "",
        "priceCompId": "",
        "tieSeqNum": "",
        "version": "",
    }
    "priceComponentDescription": "FLAT",
    "valueAmt": "0.600000000000000000",
    "priceComponentDisplay": "false",
    "rcMapId": "",
    "tieredFlag": "",
    "priceCompSequenceNo2": "0",
}
}
"priority": "2",
"priceListId": "5417730766",
"priceListDescription": "PriceList -1",
"priceListStartDate": "2022-01-11",
"priceListEndDate": "2022-01-21",
"noOfDays": "10",

```



```

"priceItemCode": "PI_031",
"priceitemDescr": "MT943_SWIFT_01",
"priceAsgnId": "5410009201",
"validityFlag": "",
"sourceEntityType": "",
"sourceEntityCode": "",
"priceListInfo": "",
"priceComponent":
{
  "priceCompId": "5417300002",
  "pricecomptier"
  {
    "priceCompSequenceNo": "",
    "businessObjectDataArea": "",
    "priceItemParmGroupId": "",
    "toVal": "",
    "fromVal": "",
    "timeOfUse": "",
    "priceItemCode": "",
    "priceCriteria": "",
    "priceCompId": "",
    "tieSeqNum": "",
    "version": "",
  }
  "priceComponentDescription": "FLAT",
  "valueAmt": "16.660000000000000000",
  "priceComponentDisplay": "false",
  "rcMapId": "",
  "tieredFlag": "",
  "priceCompSequenceNo2": "0",
}
}
}
"priority": "2",
"priceListId": "5417730766",
"priceListDescription": "PriceList -1",
"priceListStartDate": "2022-01-11",
"priceListEndDate": "2022-01-21",
"noOfDays": "10",
"priceItemCode": "PI_032",
"priceitemDescr": "MT943_SWIFT_02",
"priceAsgnId": "5410009261",
"validityFlag": "",
"sourceEntityType": "",
"sourceEntityCode": "",
"priceListInfo": "",
"priceComponent":
{
  "priceCompId": "5417450002",
  "pricecomptier"
  {
    "priceCompSequenceNo": "",
    "businessObjectDataArea": "",
    "priceItemParmGroupId": "",
    "toVal": "",
    "fromVal": "",
    "timeOfUse": "",
    "priceItemCode": "",
    "priceCriteria": "",
    "priceCompId": "",
    "tieSeqNum": "",
    "version": "",
  }
  "priceComponentDescription": "FLAT",

```

For more information on...	See...
Market Product, Offer, or Bundle View Request - Tags in XML Format	Market Product, Offer, or Bundle View Request - Tags in XML Format on page 3474
Sample Market Product View Request and Response in the XML Format	Sample Market Product View Request and Response in the XML Format on page 3477
Sample Offer View Request and Response in the XML Format	Sample Offer View Request and Response in the XML Format on page 3499
Sample Bundle View Request and Response in the XML Format	Sample Bundle View Request and Response in the XML Format on page 3520
Sample Market Product View Summary Request and Response in the XML Format	Sample Market Product View Summary Request and Response in the XML Format on page 3541
Sample Market Product View Detail Request and Response in the XML Format	Sample Market Product View Detail Request and Response in the XML Format on page 3543
Market Product, Offer, or Bundle View Request in the JSON Format	Market Product, Offer, or Bundle View Request in the JSON Format on page 3565
Market Product, Offer, or Bundle View Response in the JSON Format	Market Product, Offer, or Bundle View Response in the JSON Format on page 3566
Market Product, Offer, or Bundle View Request - Attribute/Value Pairs in JSON Format	Market Product, Offer, or Bundle View Request and Response - Attribute/Value Pairs in JSON Format on page 3568
Sample Market Product View Request and Response in the JSON Format	Sample Market Product View Request and Response in the JSON Format on page 3571
Sample Offer View Request and Response in the JSON Format	Sample Offer View Request and Response in the JSON Format on page 3575
Sample Bundle View Request and Response in the JSON Format	Sample Bundle View Request and Response in the JSON Format on page 3598
Sample Bundle View Summary Request and Response in the JSON Format	Sample Bundle View Summary Request and Response in the JSON Format on page 3620
Sample Bundle View Detail Request and Response in the JSON Format	Sample Bundle View Detail Request and Response in the JSON Format on page 3622

Market Product, Offer, or Bundle View Request in the XML Format

The following code snippet illustrates how the tags should be nested while receiving the market product, offer, or bundle view request in the XML format:

```
<C1-GetProdDetail>
  <entityCode></entityCode>
  <entityType></entityType>
  <processDate></processDate>
  <inquiryTypeFlag></inquiryTypeFlag>
  <division></division>
</C1-GetProdDetail>
```

Related Topics

For more information on...	See...
Market product, offer, or bundle view Request and Response - Tags in XML format	Market Product, Offer, or Bundle View Request - Tags in XML Format on page 3474

For more information on...	See...
Sample Market Product View Request and Response in the XML Format	Sample Market Product View Request and Response in the XML Format on page 3477
Sample Offer View Request and Response in the XML Format	Sample Offer View Request and Response in the XML Format on page 3499
Sample Bundle View Request and Response in the XML Format	Sample Bundle View Request and Response in the XML Format on page 3520
Sample Market Product View Summary Request and Response in the XML Format	Sample Market Product View Summary Request and Response in the XML Format on page 3541
Sample Market Product View Detail Request and Response in the XML Format	Sample Market Product View Detail Request and Response in the XML Format on page 3543

Market Product, Offer, or Bundle View Response in the XML Format

The following code snippet illustrates how the tags should be nested while sending the market product, offer, or bundle view response in the XML format:

```
<C1-GetProdDetail>
  <entityCode></entityCode>
  <entityType></entityType>
  <processDate></processDate>
  <inquiryTypeFlag></inquiryTypeFlag>
  <division></division>
  <entityName></entityName>
  <entityStartDate></entityStartDate>
  <entityEndDate></entityEndDate>
  <termsAndCondition></termsAndCondition>
  <status></status>
  <termsAndCondndDescr></termsAndCondndDescr>
  <messageCategory></messageCategory>
  <messageNumber></messageNumber>
  <messageText></messageText>
  <longDescription></longDescription>
  <productlist>
    <productCode></productCode>
    <productName></productName>
    <prodTypFlg></prodTypFlg>
    <productCategoryFlgDesc></productCategoryFlgDesc>
  </productlist>
  <EntityDivision>
    <divisionCode></divisionCode>
  </EntityDivision>
  <productLinkedEntity>
    <linkedEntityCode></linkedEntityCode>
    <linkedEntityName></linkedEntityName>
    <linkedEntityType></linkedEntityType>
  </productLinkedEntity>
  <eligibilityDetails>
    <eligibilityDescription></eligibilityDescription>
    <eligibilityStartDate></eligibilityStartDate>
    <eligibilityEndDate></eligibilityEndDate>
    <eligibilityRule>
      <rhsPriceParmCd></rhsPriceParmCd>
      <rhsPriceParmVal></rhsPriceParmVal>
      <lhsPriceParmCd></lhsPriceParmCd>
      <rhsPriceParmTypeFlg></rhsPriceParmTypeFlg>
      <>trueFlag></trueFlag>
      <>trueFlagDescr></trueFlagDescr>
    </eligibilityRule>
  </eligibilityDetails>
</C1-GetProdDetail>
```

```

    <falseFlag></falseFlag>
    <falseFlagDescr></falseFlagDescr>
    <insufficientFlag></insufficientFlag>
    <insufficientFlagDescr></insufficientFlagDescr>
    <eligibilityRuleFlg></eligibilityRuleFlg>
    <eligibilityDescr></eligibilityDescr>
    <operator></operator>
    <priceParmCode></priceParmCode>
    <sequenceNumber></sequenceNumber>
  </eligibilityRule>
</eligibilityDetails>
<services>
  <serviceCd></serviceCd>
  <serviceName></serviceName>
  <mandatoryFlag></mandatoryFlag>
</services>
<pricing>
  <priceListId></priceListId>
  <priceListDescription></priceListDescription>
  <priority></priority>
  <validityFlag></validityFlag>
  <noOfDays></noOfDays>
  <priceItemCode></priceItemCode>
  <priceitemCodeDescr></priceitemCodeDescr>
  <priceAsgnId></priceAsgnId>
  <priceListStartDate></priceListStartDate>
  <priceListEndDate></priceListEndDate>
  <priceComponent>
    <priceCompId></priceCompId>
    <priceCompDescr></priceCompDescr>
    <valueAmt></valueAmt>
    <tieredFlag></tieredFlag>
    <pricecomptier>
      <priceItemParmGroupId></priceItemParmGroupId>
      <toVal></toVal>
      <fromVal></fromVal>
      <timeOfUse></timeOfUse>
      <priceCompPriceItem></priceCompPriceItem>
      <priceCriteria></priceCriteria>
      <priceCompTierId></priceCompTierId>
      <tieringSeqNum></tieringSeqNum>
      <parmString></parmString>
    </pricecomptier>
  </priceComponent>
</pricing>
</C1-GetProdDetail>

```

Related Topics

For more information on...	See...
Market Product, Offer, or Bundle View Request and Response - Tags in XML Format	Market Product, Offer, or Bundle View Request - Tags in XML Format on page 3474
Sample Market Product View Request and Response in the XML Format	Sample Market Product View Request and Response in the XML Format on page 3477
Sample Offer View Request and Response in the XML Format	Sample Offer View Request and Response in the XML Format on page 3499
Sample Bundle View Request and Response in the XML Format	Sample Bundle View Request and Response in the XML Format on page 3520

For more information on...	See...
Sample Market Product View Summary Request and Response in the XML Format	Sample Market Product View Summary Request and Response in the XML Format on page 3541
Sample Market Product View Detail Request and Response in the XML Format	Sample Market Product View Detail Request and Response in the XML Format on page 3543

Market Product, Offer, or Bundle View Request - Tags in XML Format

Note: We recommend you to refer the topics [Market Product, Offer, or Bundle View Request in the XML Format](#) on page 3471 and [Market Product, Offer, or Bundle View Response in the XML Format](#) on page 3472 in parallel while understanding the below mentioned tags. This will help you to understand how the tags are nested in the XML format.

Before calling the **C1-GetProdDetail** business service through an inbound web service, you need to ensure that the active market products, offers, or bundles view request contains the following tags:

Tag Name	Tag Description	Mandatory (Yes or No)
entityCode	Used to specify the entity code to get details of the active entity.	Yes
	Note: Entity is referred to market product, offer or bundle.	
entityType	Used to indicate the entity type to get details of the active entity.	Yes
	Note: Entity is referred to market product, offer or bundle.	
processDate	Used to specify the date to get the effective market product, offer, or bundle for that date.	Yes(Conditional)
		Note: If the date is not entered then it will display the default date from the system on which the enquiry is made.
inquiryTypeFlag	Used to indicate whether you want to view the basic details without price components or the complete details with price components of the entity. The valid values are: <ul style="list-style-type: none"> Detail (DETL) - Used to indicate whether you want to view the complete details with price components of the entity. Summary (SMRY) - Used to indicate whether you want to view the basic details without price components of the product. 	Yes(Conditional)
		Note: The default value is SMRY .
division	Used to indicate the division to which the entity belongs.	Yes(Conditional)

Tag Name	Tag Description	Mandatory (Yes or No)
		Note: This field is required with product code, product category, entity type or entity code to extract the entity of the specific division.

The following table lists and describes the tags which appear in the view active market products, offers, or bundles derivation response XML format:

Tag Name	Tag Description
entityName	Displays the entity name.
entityStartDate	Displays the date from when the entity is effective.
entityEndDate	Displays the date till when the entity is effective.
termsAndCondition	Displays the terms and condition of the entity.
status	Displays the status of the entity.
termsAndCondndescri	Displays the description of the terms and conditions of the entity.
messageCategory	Indicates the category of the message.
messageNumber	Indicates the number of the message.
messageText	Displays the message.
longDescription	Displays the long description.
productlist	Displays the list of the eligible product to which the requested entity belongs.
productCode	Used to display the code of the parent product.
productName	Used to display the parent product.
prodTypFlg	Displays the code of the eligible product to which the requested entity belongs.
productCategoryFlgDes	Displays the description of the eligible product category flag to which the requested entity belongs.
EntityDivision	Used to indicate the division of the requested entity.
divisionCode	Displays the division to which the requested entity belongs.
productLinkedEntity	Displays the list of eligible market product, offer, and bundle.
linkedEntityCode	Displays the linked entity code for the requested entity code.
linkedEntityName	Displays the linked entity for the requested entity code.
linkedEntityType	Displays the linked entity type for the requested entity code.
eligibilityDetails	Indicates the name of group tag.
eligibilityDescription	Displays the description of the eligibility to which the requested entity belongs.
eligibilityStartDate	Displays the date from when the eligibility of the entity is effective.
eligibilityEndDate	Displays the date till when the eligibility of the entity is effective.
eligibilityRule	This is group tag under the eligibility details.
rhsPriceParmCd	Indicates the right side parameter code of the eligibility condition.

Tag Name	Tag Description
rhsPriceParmVal	Indicates the right side parameter value of the eligibility condition.
lhsPriceParmCd	Indicates the left side parameter code of the eligibility condition.
rhsPriceParmTypeFlg	Indicates the value of the right side flag.
trueFlag	Indicates the true condition.
trueFlagDescr	Displays the description for the true flag condition.
falseFlag	Indicates the false condition.
falseFlagDescr	Displays the description for the false flag condition.
insufficientFlag	Indicates the insufficient condition.
insufficientFlagDescr	Displays the description for the insufficient flag condition.
eligibilityRuleFlg	Indicates the eligibility rule flag condition.
eligibilityDescr	Displays the description of the eligibility criteria for the input entity.
operator	Indicates the operator to evaluate the condition.
priceParmCode	Displays the price parameter code.
sequenceNumber	Displays the sequence number of the eligibility condition.
pricing	Displays the price of the requested entity.
priceListId	Displays the price list ID.
priceListDescription	Displays the description of the Price List.
priority	Displays the priority in sequence of the price list of the entity.
validityFlag	Indicates the validity of the price item.
noOfDays	Displays the validity of price list in number of days.
priceItemCode	Displays the price item code.
priceitemCodeDescr	Displays the description of the price item.
priceAsgnId	Displays the price assignment ID.
priceListStartDate	Displays the date from when the price list of the entity is effective.
priceListEndDate	Displays the date till when the price list of the entity is effective.
priceComponent	Indicates the name of group tag.
priceCompId	Displays the price component ID.
priceCompDescr	Displays the description of the price component.
valueAmt	Displays the value amount of the price component.
tieredFlag	Indicates the tire flag.
pricecomptier	Indicates the name of group tag.
priceItemParmGroupId	Displays the parameter group ID of the price item.
toVal	Indicates the tiering to value of the price item.
fromVal	Indicates the tiering from value of the price item.

Tag Name	Tag Description
timeOfUse	Indicates the tiering time of use.
priceCompPriceItem	Displays the price component of the price item.
priceCriteria	Displays the price criteria of the price item.
priceCompTierId	Displays the price component tier ID.
tieringSeqNum	Indicates the tiering sequence number.
parmString	Indicates the parameter string of the price item.

Related Topics

For more information on...	See...
Sample Market Product View Request and Response in the XML Format	Sample Market Product View Request and Response in the XML Format on page 3477
Sample Offer View Request and Response in the XML Format	Sample Offer View Request and Response in the XML Format on page 3499
Sample Bundle View Request and Response in the XML Format	Sample Bundle View Request and Response in the XML Format on page 3520
Sample Market Product View Summary Request and Response in the XML Format	Sample Market Product View Summary Request and Response in the XML Format on page 3541
Sample Market Product View Detail Request and Response in the XML Format	Sample Market Product View Detail Request and Response in the XML Format on page 3543

Sample Market Product View Request and Response in the XML Format

Using the below example, you can view market products which are processed on **2022-01-11**.

Sample Market Product View Request in the XML Format

```
<C1-GetProdDetail>
  <entityCode>CHECKMP_001</entityCode>
  <entityType>MP</entityType>
  <processDate>2022-01-11</processDate>
  <inquiryTypeFlag>DETL</inquiryTypeFlag>
  <division></division>
</C1-GetProdDetail>
```

Sample Market Product View Response in the XML Format

```
<C1-GetProdDetail>
  <entityCode>CHECKMP_001</entityCode>
  <entityType>MP</entityType>
  <processDate>2022-01-11</processDate>
  <inquiryTypeFlag>DETL</inquiryTypeFlag>
  <division></division>
  <entityName>CHECKMP_001</entityName>
  <entityStartDate>2022-01-11</entityStartDate>
  <entityEndDate></entityEndDate>
  <termsAndCondition>TERMSPRAAS</termsAndCondition>
  <status>ACTIVE</status>
  <termsAndCondnDescr>TERMSPRAAS</termsAndCondnDescr>
  <messageCategory>0</messageCategory>
  <messageNumber>0</messageNumber>
  <messageText></messageText>
  <longDescription></longDescription>
```

```

<productlist>
  <productCode>LOAN_001</productCode>
  <productName>LOAN_001</productName>
  <prodTypFlg>Product</prodTypFlg>
  <productCategoryFlgDesc>Loans</productCategoryFlgDesc>
</productlist>
<EntityDivision>
  <divisionCode>IND</divisionCode>
</EntityDivision>
<EntityDivision>
  <divisionCode>MH</divisionCode>
</EntityDivision>
<productLinkedEntity>
  <linkedEntityCode></linkedEntityCode>
  <linkedEntityName></linkedEntityName>
  <linkedEntityType mapField="LINKED_ENTITY_TYPE" />
</productLinkedEntity>
<eligibilityDetails>
  <eligibilityDescription>ELG_001</eligibilityDescription>
  <eligibilityStartDate>2022-01-11</eligibilityStartDate>
  <eligibilityEndDate></eligibilityEndDate>
  <eligibilityRule>
    <rhsPriceParmCd></rhsPriceParmCd>
    <rhsPriceParmVal>IND</rhsPriceParmVal>
    <lhsPriceParmCd>ACC_DIVISION</lhsPriceParmCd>
    <rhsPriceParmTypeFlg>VAL</rhsPriceParmTypeFlg>
    <>trueFlag></trueFlag>
    <>trueFlagDescr>RLTR</trueFlagDescr>
    <>falseFlag>RLFS</falseFlag>
    <>falseFlagDescr></falseFlagDescr>
    <insufficientFlag>RLFS</insufficientFlag>
    <insufficientFlagDescr></insufficientFlagDescr>
    <eligibilityRuleFlg></eligibilityRuleFlg>
    <eligibilityDescr></eligibilityDescr>
    <operator>=</operator>
    <priceParmCode></priceParmCode>
    <sequenceNumber>10</sequenceNumber>
  </eligibilityRule>
</eligibilityDetails>
<eligibilityDetails>
  <eligibilityDescription></eligibilityDescription>
  <eligibilityStartDate></eligibilityStartDate>
  <eligibilityEndDate></eligibilityEndDate>
  <eligibilityRule>
    <rhsPriceParmCd></rhsPriceParmCd>
    <rhsPriceParmVal>CA</rhsPriceParmVal>
    <lhsPriceParmCd>PERSON_STATE</lhsPriceParmCd>
    <rhsPriceParmTypeFlg>VAL</rhsPriceParmTypeFlg>
    <>trueFlag></trueFlag>
    <trueFlagDescr>RLTR</trueFlagDescr>
    <>falseFlag>RLTR</falseFlag>
    <>falseFlagDescr></falseFlagDescr>
    <insufficientFlag>RLFS</insufficientFlag>
    <insufficientFlagDescr></insufficientFlagDescr>
    <eligibilityRuleFlg></eligibilityRuleFlg>
    <eligibilityDescr></eligibilityDescr>
    <operator><=</operator>
    <priceParmCode></priceParmCode>
    <sequenceNumber>20</sequenceNumber>
  </eligibilityRule>
</eligibilityDetails>
<eligibilityDetails>
  <eligibilityDescription></eligibilityDescription>
  <eligibilityStartDate></eligibilityStartDate>

```

```

<eligibilityEndDate></eligibilityEndDate>
<eligibilityRule>
  <rhsPriceParmCd></rhsPriceParmCd>
  <rhsPriceParmVal>USD</rhsPriceParmVal>
  <lhsPriceParmCd>ACCOUNT_CURRENCY</lhsPriceParmCd>
  <rhsPriceParmTypeFlg>VAL</rhsPriceParmTypeFlg>
  <trueFlag></trueFlag>
  <trueFlagDescr>RLTR</trueFlagDescr>
  <falseFlag>RLTR</falseFlag>
  <falseFlagDescr></falseFlagDescr>
  <insufficientFlag>RLFS</insufficientFlag>
  <insufficientFlagDescr></insufficientFlagDescr>
  <eligibilityRuleFlg></eligibilityRuleFlg>
  <eligibilityDescr></eligibilityDescr>
  <operator><></operator>
  <priceParmCode></priceParmCode>
  <sequenceNumber>30</sequenceNumber>
</eligibilityRule>
</eligibilityDetails>
<services>
  <serviceCd></serviceCd>
  <serviceName>Product Service PRASS1</serviceName>
  <mandatoryFlag>true</mandatoryFlag>
</services>
<services>
  <serviceCd></serviceCd>
  <serviceName>Product Service PRASS2</serviceName>
  <mandatoryFlag>true</mandatoryFlag>
</services>
<services>
  <serviceCd></serviceCd>
  <serviceName>MH division product service</serviceName>
  <mandatoryFlag>true</mandatoryFlag>
</services>
<pricing>
  <priceListId>4368251923</priceListId>
  <priceListDescription>Currency_Con_PriceList -1</priceListDescription>
  <priority>2</priority>
  <validityFlag></validityFlag>
  <noOfDays>30</noOfDays>
  <priceItemCode>CC_021</priceItemCode>
  <priceitemCodeDescr>CC_21-Account Opening Fee</priceitemCodeDescr>
  <priceAsgnId>4360009281</priceAsgnId>
  <priceListStartDate>2022-01-11</priceListStartDate>
  <priceListEndDate>2022-02-10</priceListEndDate>
  <priceComponent>
    <priceCompId>4367475002</priceCompId>
    <priceCompDescr>FLAT</priceCompDescr>
    <valueAmt>0.400000000000000000</valueAmt>
    <tieredFlag></tieredFlag>
    <pricecomptier>
      <priceItemParmGroupId></priceItemParmGroupId>
      <toVal></toVal>
      <fromVal></fromVal>
      <timeOfUse></timeOfUse>
      <priceCompPriceItem></priceCompPriceItem>
      <priceCriteria></priceCriteria>
      <priceCompTierId></priceCompTierId>
      <tieringSeqNum></tieringSeqNum>
      <parmString></parmString>
    </pricecomptier>
  </priceComponent>
</pricing>
</pricing>

```

```

<priceListId>4368251923</priceListId>
<priceListDescription>Currency_Con_PriceList -1</priceListDescription>
<priority>2</priority>
<validityFlag></validityFlag>
<noOfDays>30</noOfDays>
<priceItemCode>CC_022</priceItemCode>
<priceitemCodeDescr>CC2-Monthly Acct Serv Fee</priceitemCodeDescr>
<priceAsgnId>4360009282</priceAsgnId>
<priceListStartDate>2022-01-11</priceListStartDate>
<priceListEndDate>2022-02-10</priceListEndDate>
<priceComponent>
  <priceCompId>4367475004</priceCompId>
  <priceCompDescr>FLAT</priceCompDescr>
  <valueAmt>0.600000000000000000</valueAmt>
  <tieredFlag></tieredFlag>
  <pricecomptier>
    <priceItemParmGroupId></priceItemParmGroupId>
    <toVal></toVal>
    <fromVal></fromVal>
    <timeOfUse></timeOfUse>
    <priceCompPriceItem></priceCompPriceItem>
    <priceCriteria></priceCriteria>
    <priceCompTierId></priceCompTierId>
    <tieringSeqNum></tieringSeqNum>
    <parmString></parmString>
  </pricecomptier>
</priceComponent>
</pricing>
<pricing>
  <priceListId>4368251923</priceListId>
  <priceListDescription>Currency_Con_PriceList -1</priceListDescription>
  <priority>2</priority>
  <validityFlag></validityFlag>
  <noOfDays>30</noOfDays>
  <priceItemCode>CC_024</priceItemCode>
  <priceitemCodeDescr>CC3-SEPA Transfers</priceitemCodeDescr>
  <priceAsgnId>4360009283</priceAsgnId>
  <priceListStartDate>2022-01-11</priceListStartDate>
  <priceListEndDate>2022-02-10</priceListEndDate>
  <priceComponent>
    <priceCompId>4367475006</priceCompId>
    <priceCompDescr>FLAT</priceCompDescr>
    <valueAmt>0.250000000000000000</valueAmt>
    <tieredFlag></tieredFlag>
    <pricecomptier>
      <priceItemParmGroupId></priceItemParmGroupId>
      <toVal></toVal>
      <fromVal></fromVal>
      <timeOfUse></timeOfUse>
      <priceCompPriceItem></priceCompPriceItem>
      <priceCriteria></priceCriteria>
      <priceCompTierId></priceCompTierId>
      <tieringSeqNum></tieringSeqNum>
      <parmString></parmString>
    </pricecomptier>
  </priceComponent>
</pricing>
<pricing>
  <priceListId>4368251923</priceListId>
  <priceListDescription>Currency_Con_PriceList -1</priceListDescription>
  <priority>2</priority>
  <validityFlag></validityFlag>
  <noOfDays>30</noOfDays>
  <priceItemCode>CC_025</priceItemCode>

```

```

<priceitemCodeDescr>CC4-Domestic Funds Transfer Fee</priceitemCodeDescr>
<priceAsgnId>4360009284</priceAsgnId>
<priceListStartDate>2022-01-11</priceListStartDate>
<priceListEndDate>2022-02-10</priceListEndDate>
<priceComponent>
  <priceCompId>4367475008</priceCompId>
  <priceCompDescr>FLAT</priceCompDescr>
  <valueAmt>112.040000000000000000</valueAmt>
  <tieredFlag></tieredFlag>
  <pricecomptier>
    <priceItemParmGroupId></priceItemParmGroupId>
    <toVal></toVal>
    <fromVal></fromVal>
    <timeOfUse></timeOfUse>
    <priceCompPriceItem></priceCompPriceItem>
    <priceCriteria></priceCriteria>
    <priceCompTierId></priceCompTierId>
    <tieringSeqNum></tieringSeqNum>
    <parmString></parmString>
  </pricecomptier>
</priceComponent>
</pricing>
<pricing>
  <priceListId>5417730766</priceListId>
  <priceListDescription>PriceList -1</priceListDescription>
  <priority>1</priority>
  <validityFlag></validityFlag>
  <noOfDays>30</noOfDays>
  <priceItemCode>PI_021</priceItemCode>
  <priceitemCodeDescr>V1-Account Opening Fee</priceitemCodeDescr>
  <priceAsgnId>5410009202</priceAsgnId>
  <priceListStartDate>2022-01-11</priceListStartDate>
  <priceListEndDate>2022-02-28</priceListEndDate>
  <priceComponent>
    <priceCompId>5417300004</priceCompId>
    <priceCompDescr>FLAT</priceCompDescr>
    <valueAmt>0.250000000000000000</valueAmt>
    <tieredFlag></tieredFlag>
    <pricecomptier>
      <priceItemParmGroupId></priceItemParmGroupId>
      <toVal></toVal>
      <fromVal></fromVal>
      <timeOfUse></timeOfUse>
      <priceCompPriceItem></priceCompPriceItem>
      <priceCriteria></priceCriteria>
      <priceCompTierId></priceCompTierId>
      <tieringSeqNum></tieringSeqNum>
      <parmString></parmString>
    </pricecomptier>
  </priceComponent>
</pricing>
<pricing>
  <priceListId>5417730766</priceListId>
  <priceListDescription>PriceList -1</priceListDescription>
  <priority>1</priority>
  <validityFlag></validityFlag>
  <noOfDays>30</noOfDays>
  <priceItemCode>PI_022</priceItemCode>
  <priceitemCodeDescr>V2-Monthly Acct Serv Fee</priceitemCodeDescr>
  <priceAsgnId>5410009203</priceAsgnId>
  <priceListStartDate>2022-01-11</priceListStartDate>
  <priceListEndDate>2022-02-28</priceListEndDate>
  <priceComponent>
    <priceCompId>5417300006</priceCompId>

```

```

    <priceCompDescr>FLAT</priceCompDescr>
    <valueAmt>112.040000000000000000</valueAmt>
    <tieredFlag></tieredFlag>
    <pricecomptier>
      <priceItemParmGroupId></priceItemParmGroupId>
      <toVal></toVal>
      <fromVal></fromVal>
      <timeOfUse></timeOfUse>
      <priceCompPriceItem></priceCompPriceItem>
      <priceCriteria></priceCriteria>
      <priceCompTierId></priceCompTierId>
      <tieringSeqNum></tieringSeqNum>
      <parmString></parmString>
    </pricecomptier>
  </priceComponent>
</pricing>
<pricing>
  <priceListId>5417730766</priceListId>
  <priceListDescription>PriceList -1</priceListDescription>
  <priority>1</priority>
  <validityFlag></validityFlag>
  <noOfDays>30</noOfDays>
  <priceItemCode>PI_023</priceItemCode>
  <priceitemCodeDescr>V3-Audit Reports</priceitemCodeDescr>
  <priceAsgnId>5410009204</priceAsgnId>
  <priceListStartDate>2022-01-11</priceListStartDate>
  <priceListEndDate>2022-02-28</priceListEndDate>
  <priceComponent>
    <priceCompId>5417300008</priceCompId>
    <priceCompDescr>FLAT</priceCompDescr>
    <valueAmt>276.250000000000000000</valueAmt>
    <tieredFlag></tieredFlag>
    <pricecomptier>
      <priceItemParmGroupId></priceItemParmGroupId>
      <toVal></toVal>
      <fromVal></fromVal>
      <timeOfUse></timeOfUse>
      <priceCompPriceItem></priceCompPriceItem>
      <priceCriteria></priceCriteria>
      <priceCompTierId></priceCompTierId>
      <tieringSeqNum></tieringSeqNum>
      <parmString></parmString>
    </pricecomptier>
  </priceComponent>
</pricing>
<pricing>
  <priceListId>5417730766</priceListId>
  <priceListDescription>PriceList -1</priceListDescription>
  <priority>1</priority>
  <validityFlag></validityFlag>
  <noOfDays></noOfDays>
  <priceItemCode>PI_024</priceItemCode>
  <priceitemCodeDescr>V4-SEPA Transfers</priceitemCodeDescr>
  <priceAsgnId>5410009241</priceAsgnId>
  <priceListStartDate>2022-01-11</priceListStartDate>
  <priceListEndDate>2022-02-28</priceListEndDate>
  <priceComponent>
    <priceCompId>5417400004</priceCompId>
    <priceCompDescr>Price per transaction - Step Tier 1</priceCompDescr>
    <valueAmt>12.950000000000000000</valueAmt>
    <tieredFlag></tieredFlag>
    <pricecomptier>
      <priceItemParmGroupId>1</priceItemParmGroupId>
      <toVal>1000.000000000000000000</toVal>

```

```

    <fromVal>0.000000000000000000</fromVal>
    <timeOfUse></timeOfUse>
    <priceCompPriceItem>PI_024</priceCompPriceItem>
    <priceCriteria>NBRTRAN</priceCriteria>
    <priceCompTierId></priceCompTierId>
    <tieringSeqNum>10</tieringSeqNum>
    <parmString></parmString>
  </pricecomptier>
</pricecomptier>
  <priceItemParmGroupId>1</priceItemParmGroupId>
  <toVal>5000.000000000000000000</toVal>
  <fromVal>1000.000000000000000000</fromVal>
  <timeOfUse></timeOfUse>
  <priceCompPriceItem>PI_024</priceCompPriceItem>
  <priceCriteria>NBRTRAN</priceCriteria>
  <priceCompTierId></priceCompTierId>
  <tieringSeqNum>10</tieringSeqNum>
  <parmString></parmString>
</pricecomptier>
</pricecomptier>
  <priceItemParmGroupId>1</priceItemParmGroupId>
  <toVal>999999999999.990000000000000000</toVal>
  <fromVal>5000.000000000000000000</fromVal>
  <timeOfUse></timeOfUse>
  <priceCompPriceItem>PI_024</priceCompPriceItem>
  <priceCriteria>NBRTRAN</priceCriteria>
  <priceCompTierId></priceCompTierId>
  <tieringSeqNum>10</tieringSeqNum>
  <parmString></parmString>
</pricecomptier>
</priceComponent>
<priceComponent>
  <priceCompId>5417400005</priceCompId>
  <priceCompDescr>Price per transaction - Step Tier 2</priceCompDescr>
  <valueAmt>12.150000000000000000</valueAmt>
  <tieredFlag></tieredFlag>
  <pricecomptier>
    <priceItemParmGroupId>1</priceItemParmGroupId>
    <toVal>1000.000000000000000000</toVal>
    <fromVal>0.000000000000000000</fromVal>
    <timeOfUse></timeOfUse>
    <priceCompPriceItem>PI_024</priceCompPriceItem>
    <priceCriteria>NBRTRAN</priceCriteria>
    <priceCompTierId></priceCompTierId>
    <tieringSeqNum>10</tieringSeqNum>
    <parmString></parmString>
  </pricecomptier>
  <pricecomptier>
    <priceItemParmGroupId>1</priceItemParmGroupId>
    <toVal>5000.000000000000000000</toVal>
    <fromVal>1000.000000000000000000</fromVal>
    <timeOfUse></timeOfUse>
    <priceCompPriceItem>PI_024</priceCompPriceItem>
    <priceCriteria>NBRTRAN</priceCriteria>
    <priceCompTierId></priceCompTierId>
    <tieringSeqNum>10</tieringSeqNum>
    <parmString></parmString>
  </pricecomptier>
  <pricecomptier>
    <priceItemParmGroupId>1</priceItemParmGroupId>
    <toVal>999999999999.990000000000000000</toVal>
    <fromVal>5000.000000000000000000</fromVal>
    <timeOfUse></timeOfUse>
    <priceCompPriceItem>PI_024</priceCompPriceItem>

```

```

        <priceCriteria>NBRTRAN</priceCriteria>
        <priceCompTierId></priceCompTierId>
        <tieringSeqNum>10</tieringSeqNum>
        <parmString></parmString>
    </pricecomptier>
</priceComponent>
<priceComponent>
    <priceCompId>5417400006</priceCompId>
    <priceCompDescr>Price per transaction - Step Tier 3</priceCompDescr>
    <valueAmt>11.950000000000000000</valueAmt>
    <tieredFlag></tieredFlag>
    <pricecomptier>
        <priceItemParmGroupId>1</priceItemParmGroupId>
        <toVal>1000.000000000000000000</toVal>
        <fromVal>0.000000000000000000</fromVal>
        <timeOfUse></timeOfUse>
        <priceCompPriceItem>PI_024</priceCompPriceItem>
        <priceCriteria>NBRTRAN</priceCriteria>
        <priceCompTierId></priceCompTierId>
        <tieringSeqNum>10</tieringSeqNum>
        <parmString></parmString>
    </pricecomptier>
    <pricecomptier>
        <priceItemParmGroupId>1</priceItemParmGroupId>
        <toVal>5000.000000000000000000</toVal>
        <fromVal>1000.000000000000000000</fromVal>
        <timeOfUse></timeOfUse>
        <priceCompPriceItem>PI_024</priceCompPriceItem>
        <priceCriteria>NBRTRAN</priceCriteria>
        <priceCompTierId></priceCompTierId>
        <tieringSeqNum>10</tieringSeqNum>
        <parmString></parmString>
    </pricecomptier>
    <pricecomptier>
        <priceItemParmGroupId>1</priceItemParmGroupId>
        <toVal>99999999999.990000000000000000</toVal>
        <fromVal>5000.000000000000000000</fromVal>
        <timeOfUse></timeOfUse>
        <priceCompPriceItem>PI_024</priceCompPriceItem>
        <priceCriteria>NBRTRAN</priceCriteria>
        <priceCompTierId></priceCompTierId>
        <tieringSeqNum>10</tieringSeqNum>
        <parmString></parmString>
    </pricecomptier>
</priceComponent>
</pricing>
<pricing>
    <priceListId>5417730766</priceListId>
    <priceListDescription>PriceList -1</priceListDescription>
    <priority>1</priority>
    <validityFlag></validityFlag>
    <noOfDays></noOfDays>
    <priceItemCode>PI_025</priceItemCode>
    <priceitemCodeDescr>V5-Domestic Funds Transfer Fee</priceitemCodeDescr>
    <priceAsgnId>5410009242</priceAsgnId>
    <priceListStartDate>2022-01-11</priceListStartDate>
    <priceListEndDate>2022-02-28</priceListEndDate>
    <priceComponent>
        <priceCompId>5417400010</priceCompId>
        <priceCompDescr>Threshold price per transaction</priceCompDescr>
        <valueAmt>12.950000000000000000</valueAmt>
        <tieredFlag></tieredFlag>
        <pricecomptier>
            <priceItemParmGroupId>1</priceItemParmGroupId>

```



```

    <toVal>1000.00000000000000000000</toVal>
    <fromVal>0.00000000000000000000</fromVal>
    <timeOfUse></timeOfUse>
    <priceCompPriceItem>PI_025</priceCompPriceItem>
    <priceCriteria>NBRTRAN</priceCriteria>
    <priceCompTierId></priceCompTierId>
    <tieringSeqNum>10</tieringSeqNum>
    <parmString></parmString>
  </pricecomptier>
</pricecomptier>
  <priceItemParmGroupId>1</priceItemParmGroupId>
  <toVal>5000.00000000000000000000</toVal>
  <fromVal>1000.00000000000000000000</fromVal>
  <timeOfUse></timeOfUse>
  <priceCompPriceItem>PI_025</priceCompPriceItem>
  <priceCriteria>NBRTRAN</priceCriteria>
  <priceCompTierId></priceCompTierId>
  <tieringSeqNum>10</tieringSeqNum>
  <parmString></parmString>
</pricecomptier>
</pricecomptier>
  <priceItemParmGroupId>1</priceItemParmGroupId>
  <toVal>99999999999.99000000000000000000</toVal>
  <fromVal>5000.00000000000000000000</fromVal>
  <timeOfUse></timeOfUse>
  <priceCompPriceItem>PI_025</priceCompPriceItem>
  <priceCriteria>NBRTRAN</priceCriteria>
  <priceCompTierId></priceCompTierId>
  <tieringSeqNum>10</tieringSeqNum>
  <parmString></parmString>
</pricecomptier>
</priceComponent>
<priceComponent>
  <priceCompId>5417400011</priceCompId>
  <priceCompDescr>Threshold price per transaction</priceCompDescr>
  <valueAmt>12.15000000000000000000</valueAmt>
  <tieredFlag></tieredFlag>
  <pricecomptier>
    <priceItemParmGroupId>1</priceItemParmGroupId>
    <toVal>1000.00000000000000000000</toVal>
    <fromVal>0.00000000000000000000</fromVal>
    <timeOfUse></timeOfUse>
    <priceCompPriceItem>PI_025</priceCompPriceItem>
    <priceCriteria>NBRTRAN</priceCriteria>
    <priceCompTierId></priceCompTierId>
    <tieringSeqNum>10</tieringSeqNum>
    <parmString></parmString>
  </pricecomptier>
  <pricecomptier>
    <priceItemParmGroupId>1</priceItemParmGroupId>
    <toVal>5000.00000000000000000000</toVal>
    <fromVal>1000.00000000000000000000</fromVal>
    <timeOfUse></timeOfUse>
    <priceCompPriceItem>PI_025</priceCompPriceItem>
    <priceCriteria>NBRTRAN</priceCriteria>
    <priceCompTierId></priceCompTierId>
    <tieringSeqNum>10</tieringSeqNum>
    <parmString></parmString>
  </pricecomptier>
  <pricecomptier>
    <priceItemParmGroupId>1</priceItemParmGroupId>
    <toVal>99999999999.99000000000000000000</toVal>
    <fromVal>5000.00000000000000000000</fromVal>
    <timeOfUse></timeOfUse>

```

```

        <priceCompPriceItem>PI_025</priceCompPriceItem>
        <priceCriteria>NBRTRAN</priceCriteria>
        <priceCompTierId></priceCompTierId>
        <tieringSeqNum>10</tieringSeqNum>
        <parmString></parmString>
    </pricecomptier>
</priceComponent>
<priceComponent>
    <priceCompId>5417400012</priceCompId>
    <priceCompDescr>Threshold price per transaction</priceCompDescr>
    <valueAmt>11.950000000000000000</valueAmt>
    <tieredFlag></tieredFlag>
    <pricecomptier>
        <priceItemParmGroupId>1</priceItemParmGroupId>
        <toVal>1000.000000000000000000</toVal>
        <fromVal>0.000000000000000000</fromVal>
        <timeOfUse></timeOfUse>
        <priceCompPriceItem>PI_025</priceCompPriceItem>
        <priceCriteria>NBRTRAN</priceCriteria>
        <priceCompTierId></priceCompTierId>
        <tieringSeqNum>10</tieringSeqNum>
        <parmString></parmString>
    </pricecomptier>
    <pricecomptier>
        <priceItemParmGroupId>1</priceItemParmGroupId>
        <toVal>5000.000000000000000000</toVal>
        <fromVal>1000.000000000000000000</fromVal>
        <timeOfUse></timeOfUse>
        <priceCompPriceItem>PI_025</priceCompPriceItem>
        <priceCriteria>NBRTRAN</priceCriteria>
        <priceCompTierId></priceCompTierId>
        <tieringSeqNum>10</tieringSeqNum>
        <parmString></parmString>
    </pricecomptier>
    <pricecomptier>
        <priceItemParmGroupId>1</priceItemParmGroupId>
        <toVal>999999999999.990000000000000000</toVal>
        <fromVal>5000.000000000000000000</fromVal>
        <timeOfUse></timeOfUse>
        <priceCompPriceItem>PI_025</priceCompPriceItem>
        <priceCriteria>NBRTRAN</priceCriteria>
        <priceCompTierId></priceCompTierId>
        <tieringSeqNum>10</tieringSeqNum>
        <parmString></parmString>
    </pricecomptier>
</priceComponent>
</pricing>
<pricing>
    <priceListId>5417730766</priceListId>
    <priceListDescription>PriceList -1</priceListDescription>
    <priority>1</priority>
    <validityFlag></validityFlag>
    <noOfDays></noOfDays>
    <priceItemCode>PI_026</priceItemCode>
    <priceitemCodeDescr>V6-Electronic Credits</priceitemCodeDescr>
    <priceAsgnId>5410009243</priceAsgnId>
    <priceListStartDate>2022-01-11</priceListStartDate>
    <priceListEndDate>2022-02-28</priceListEndDate>
    <priceComponent>
        <priceCompId>5417400020</priceCompId>
        <priceCompDescr>Basic charges</priceCompDescr>
        <valueAmt>20.000000000000000000</valueAmt>
        <tieredFlag></tieredFlag>
        <pricecomptier>

```

```

    <priceItemParmGroupId>1</priceItemParmGroupId>
    <toVal>1000.00000000000000000000</toVal>
    <fromVal>0.00000000000000000000</fromVal>
    <timeOfUse></timeOfUse>
    <priceCompPriceItem>PI_026</priceCompPriceItem>
    <priceCriteria>NBRTRAN</priceCriteria>
    <priceCompTierId></priceCompTierId>
    <tieringSeqNum>10</tieringSeqNum>
    <parmString></parmString>
  </pricecomptier>
</pricecomptier>
  <pricecomptier>
    <priceItemParmGroupId>1</priceItemParmGroupId>
    <toVal>5000.00000000000000000000</toVal>
    <fromVal>1000.00000000000000000000</fromVal>
    <timeOfUse></timeOfUse>
    <priceCompPriceItem>PI_026</priceCompPriceItem>
    <priceCriteria>NBRTRAN</priceCriteria>
    <priceCompTierId></priceCompTierId>
    <tieringSeqNum>10</tieringSeqNum>
    <parmString></parmString>
  </pricecomptier>
</pricecomptier>
  <pricecomptier>
    <priceItemParmGroupId>1</priceItemParmGroupId>
    <toVal>99999999999.99000000000000000000</toVal>
    <fromVal>5000.00000000000000000000</fromVal>
    <timeOfUse></timeOfUse>
    <priceCompPriceItem>PI_026</priceCompPriceItem>
    <priceCriteria>NBRTRAN</priceCriteria>
    <priceCompTierId></priceCompTierId>
    <tieringSeqNum>10</tieringSeqNum>
    <parmString></parmString>
  </pricecomptier>
</pricecomptier>
  <pricecomptier>
    <priceItemParmGroupId>1</priceItemParmGroupId>
    <toVal>1000.00000000000000000000</toVal>
    <fromVal>0.00000000000000000000</fromVal>
    <timeOfUse></timeOfUse>
    <priceCompPriceItem>PI_026</priceCompPriceItem>
    <priceCriteria>NBRTRAN</priceCriteria>
    <priceCompTierId></priceCompTierId>
    <tieringSeqNum>10</tieringSeqNum>
    <parmString></parmString>
  </pricecomptier>
</pricecomptier>
  <pricecomptier>
    <priceItemParmGroupId>1</priceItemParmGroupId>
    <toVal>5000.00000000000000000000</toVal>
    <fromVal>1000.00000000000000000000</fromVal>
    <timeOfUse></timeOfUse>
    <priceCompPriceItem>PI_026</priceCompPriceItem>
    <priceCriteria>NBRTRAN</priceCriteria>
    <priceCompTierId></priceCompTierId>
    <tieringSeqNum>10</tieringSeqNum>
    <parmString></parmString>
  </pricecomptier>
</pricecomptier>
  <pricecomptier>
    <priceItemParmGroupId>1</priceItemParmGroupId>
    <toVal>99999999999.99000000000000000000</toVal>
    <fromVal>5000.00000000000000000000</fromVal>
    <timeOfUse></timeOfUse>
    <priceCompPriceItem>PI_026</priceCompPriceItem>
    <priceCriteria>NBRTRAN</priceCriteria>
    <priceCompTierId></priceCompTierId>
    <tieringSeqNum>10</tieringSeqNum>
    <parmString></parmString>
  </pricecomptier>
</pricecomptier>

```

```

    </pricecomptier>
  </priceComponent>
  <priceComponent>
    <priceCompId>5417400021</priceCompId>
    <priceCompDescr>Threshold price</priceCompDescr>
    <valueAmt>10.000000000000000000</valueAmt>
    <tieredFlag></tieredFlag>
    <pricecomptier>
      <priceItemParmGroupId>1</priceItemParmGroupId>
      <toVal>1000.000000000000000000</toVal>
      <fromVal>0.000000000000000000</fromVal>
      <timeOfUse></timeOfUse>
      <priceCompPriceItem>PI_026</priceCompPriceItem>
      <priceCriteria>NBRTRAN</priceCriteria>
      <priceCompTierId></priceCompTierId>
      <tieringSeqNum>10</tieringSeqNum>
      <parmString></parmString>
    </pricecomptier>
  </pricecomptier>
  <pricecomptier>
    <priceItemParmGroupId>1</priceItemParmGroupId>
    <toVal>5000.000000000000000000</toVal>
    <fromVal>1000.000000000000000000</fromVal>
    <timeOfUse></timeOfUse>
    <priceCompPriceItem>PI_026</priceCompPriceItem>
    <priceCriteria>NBRTRAN</priceCriteria>
    <priceCompTierId></priceCompTierId>
    <tieringSeqNum>10</tieringSeqNum>
    <parmString></parmString>
  </pricecomptier>
  <pricecomptier>
    <priceItemParmGroupId>1</priceItemParmGroupId>
    <toVal>99999999999.990000000000000000</toVal>
    <fromVal>5000.000000000000000000</fromVal>
    <timeOfUse></timeOfUse>
    <priceCompPriceItem>PI_026</priceCompPriceItem>
    <priceCriteria>NBRTRAN</priceCriteria>
    <priceCompTierId></priceCompTierId>
    <tieringSeqNum>10</tieringSeqNum>
    <parmString></parmString>
  </pricecomptier>
  <pricecomptier>
    <priceItemParmGroupId>1</priceItemParmGroupId>
    <toVal>1000.000000000000000000</toVal>
    <fromVal>0.000000000000000000</fromVal>
    <timeOfUse></timeOfUse>
    <priceCompPriceItem>PI_026</priceCompPriceItem>
    <priceCriteria>NBRTRAN</priceCriteria>
    <priceCompTierId></priceCompTierId>
    <tieringSeqNum>10</tieringSeqNum>
    <parmString></parmString>
  </pricecomptier>
  <pricecomptier>
    <priceItemParmGroupId>1</priceItemParmGroupId>
    <toVal>5000.000000000000000000</toVal>
    <fromVal>1000.000000000000000000</fromVal>
    <timeOfUse></timeOfUse>
    <priceCompPriceItem>PI_026</priceCompPriceItem>
    <priceCriteria>NBRTRAN</priceCriteria>
    <priceCompTierId></priceCompTierId>
    <tieringSeqNum>10</tieringSeqNum>
    <parmString></parmString>
  </pricecomptier>
  <pricecomptier>
    <priceItemParmGroupId>1</priceItemParmGroupId>
    <toVal>1000.000000000000000000</toVal>
    <fromVal>0.000000000000000000</fromVal>
    <timeOfUse></timeOfUse>
    <priceCompPriceItem>PI_026</priceCompPriceItem>
    <priceCriteria>NBRTRAN</priceCriteria>
    <priceCompTierId></priceCompTierId>
    <tieringSeqNum>10</tieringSeqNum>
    <parmString></parmString>
  </pricecomptier>
  <pricecomptier>
    <priceItemParmGroupId>1</priceItemParmGroupId>
    <toVal>5000.000000000000000000</toVal>
    <fromVal>1000.000000000000000000</fromVal>
    <timeOfUse></timeOfUse>
    <priceCompPriceItem>PI_026</priceCompPriceItem>
    <priceCriteria>NBRTRAN</priceCriteria>
    <priceCompTierId></priceCompTierId>
    <tieringSeqNum>10</tieringSeqNum>
    <parmString></parmString>
  </pricecomptier>
  <pricecomptier>
    <priceItemParmGroupId>1</priceItemParmGroupId>

```

```

        <toVal>999999999999.99000000000000000000</toVal>
        <fromVal>5000.00000000000000000000</fromVal>
        <timeOfUse></timeOfUse>
        <priceCompPriceItem>PI_026</priceCompPriceItem>
        <priceCriteria>NBRTRAN</priceCriteria>
        <priceCompTierId></priceCompTierId>
        <tieringSeqNum>10</tieringSeqNum>
        <parmString></parmString>
    </pricecomptier>
</priceComponent>
<priceComponent>
    <priceCompId>5417400022</priceCompId>
    <priceCompDescr>Threshold price</priceCompDescr>
    <valueAmt>8.00000000000000000000</valueAmt>
    <tieredFlag></tieredFlag>
    <pricecomptier>
        <priceItemParmGroupId>1</priceItemParmGroupId>
        <toVal>1000.00000000000000000000</toVal>
        <fromVal>0.00000000000000000000</fromVal>
        <timeOfUse></timeOfUse>
        <priceCompPriceItem>PI_026</priceCompPriceItem>
        <priceCriteria>NBRTRAN</priceCriteria>
        <priceCompTierId></priceCompTierId>
        <tieringSeqNum>10</tieringSeqNum>
        <parmString></parmString>
    </pricecomptier>
    <pricecomptier>
        <priceItemParmGroupId>1</priceItemParmGroupId>
        <toVal>5000.00000000000000000000</toVal>
        <fromVal>1000.00000000000000000000</fromVal>
        <timeOfUse></timeOfUse>
        <priceCompPriceItem>PI_026</priceCompPriceItem>
        <priceCriteria>NBRTRAN</priceCriteria>
        <priceCompTierId></priceCompTierId>
        <tieringSeqNum>10</tieringSeqNum>
        <parmString></parmString>
    </pricecomptier>
    <pricecomptier>
        <priceItemParmGroupId>1</priceItemParmGroupId>
        <toVal>999999999999.99000000000000000000</toVal>
        <fromVal>5000.00000000000000000000</fromVal>
        <timeOfUse></timeOfUse>
        <priceCompPriceItem>PI_026</priceCompPriceItem>
        <priceCriteria>NBRTRAN</priceCriteria>
        <priceCompTierId></priceCompTierId>
        <tieringSeqNum>10</tieringSeqNum>
        <parmString></parmString>
    </pricecomptier>
    <pricecomptier>
        <priceItemParmGroupId>1</priceItemParmGroupId>
        <toVal>1000.00000000000000000000</toVal>
        <fromVal>0.00000000000000000000</fromVal>
        <timeOfUse></timeOfUse>
        <priceCompPriceItem>PI_026</priceCompPriceItem>
        <priceCriteria>NBRTRAN</priceCriteria>
        <priceCompTierId></priceCompTierId>
        <tieringSeqNum>10</tieringSeqNum>
        <parmString></parmString>
    </pricecomptier>
    <pricecomptier>
        <priceItemParmGroupId>1</priceItemParmGroupId>
        <toVal>5000.00000000000000000000</toVal>
        <fromVal>1000.00000000000000000000</fromVal>
        <timeOfUse></timeOfUse>

```

```

        <priceCompPriceItem>PI_026</priceCompPriceItem>
        <priceCriteria>NBRTRAN</priceCriteria>
        <priceCompTierId></priceCompTierId>
        <tieringSeqNum>10</tieringSeqNum>
        <parmString></parmString>
    </pricecomptier>
</pricecomptier>
    <priceItemParmGroupId>1</priceItemParmGroupId>
    <toVal>999999999999.99000000000000000000</toVal>
    <fromVal>5000.00000000000000000000</fromVal>
    <timeOfUse></timeOfUse>
    <priceCompPriceItem>PI_026</priceCompPriceItem>
    <priceCriteria>NBRTRAN</priceCriteria>
    <priceCompTierId></priceCompTierId>
    <tieringSeqNum>10</tieringSeqNum>
    <parmString></parmString>
</pricecomptier>
</pricecomponent>
<pricecomponent>
    <priceCompId>5417400023</priceCompId>
    <priceCompDescr>Threshold price</priceCompDescr>
    <valueAmt>6.00000000000000000000</valueAmt>
    <tieredFlag></tieredFlag>
    <pricecomptier>
        <priceItemParmGroupId>1</priceItemParmGroupId>
        <toVal>1000.00000000000000000000</toVal>
        <fromVal>0.00000000000000000000</fromVal>
        <timeOfUse></timeOfUse>
        <priceCompPriceItem>PI_026</priceCompPriceItem>
        <priceCriteria>NBRTRAN</priceCriteria>
        <priceCompTierId></priceCompTierId>
        <tieringSeqNum>10</tieringSeqNum>
        <parmString></parmString>
    </pricecomptier>
    <pricecomptier>
        <priceItemParmGroupId>1</priceItemParmGroupId>
        <toVal>5000.00000000000000000000</toVal>
        <fromVal>1000.00000000000000000000</fromVal>
        <timeOfUse></timeOfUse>
        <priceCompPriceItem>PI_026</priceCompPriceItem>
        <priceCriteria>NBRTRAN</priceCriteria>
        <priceCompTierId></priceCompTierId>
        <tieringSeqNum>10</tieringSeqNum>
        <parmString></parmString>
    </pricecomptier>
    <pricecomptier>
        <priceItemParmGroupId>1</priceItemParmGroupId>
        <toVal>999999999999.99000000000000000000</toVal>
        <fromVal>5000.00000000000000000000</fromVal>
        <timeOfUse></timeOfUse>
        <priceCompPriceItem>PI_026</priceCompPriceItem>
        <priceCriteria>NBRTRAN</priceCriteria>
        <priceCompTierId></priceCompTierId>
        <tieringSeqNum>10</tieringSeqNum>
        <parmString></parmString>
    </pricecomptier>
    <pricecomptier>
        <priceItemParmGroupId>1</priceItemParmGroupId>
        <toVal>1000.00000000000000000000</toVal>
        <fromVal>0.00000000000000000000</fromVal>
        <timeOfUse></timeOfUse>
        <priceCompPriceItem>PI_026</priceCompPriceItem>
        <priceCriteria>NBRTRAN</priceCriteria>
        <priceCompTierId></priceCompTierId>

```

```

        <tieringSeqNum>10</tieringSeqNum>
        <parmString></parmString>
    </pricecomptier>
</pricecomptier>
    <priceItemParmGroupId>1</priceItemParmGroupId>
    <toVal>5000.000000000000000000</toVal>
    <fromVal>1000.000000000000000000</fromVal>
    <timeOfUse></timeOfUse>
    <priceCompPriceItem>PI_026</priceCompPriceItem>
    <priceCriteria>NBRTRAN</priceCriteria>
    <priceCompTierId></priceCompTierId>
    <tieringSeqNum>10</tieringSeqNum>
    <parmString></parmString>
</pricecomptier>
</pricecomptier>
    <priceItemParmGroupId>1</priceItemParmGroupId>
    <toVal>999999999999.990000000000000000</toVal>
    <fromVal>5000.000000000000000000</fromVal>
    <timeOfUse></timeOfUse>
    <priceCompPriceItem>PI_026</priceCompPriceItem>
    <priceCriteria>NBRTRAN</priceCriteria>
    <priceCompTierId></priceCompTierId>
    <tieringSeqNum>10</tieringSeqNum>
    <parmString></parmString>
</pricecomptier>
</priceComponent>
<priceComponent>
    <priceCompId>5417400024</priceCompId>
    <priceCompDescr>Step 1</priceCompDescr>
    <valueAmt>5.000000000000000000</valueAmt>
    <tieredFlag></tieredFlag>
    <pricecomptier>
        <priceItemParmGroupId>1</priceItemParmGroupId>
        <toVal>1000.000000000000000000</toVal>
        <fromVal>0.000000000000000000</fromVal>
        <timeOfUse></timeOfUse>
        <priceCompPriceItem>PI_026</priceCompPriceItem>
        <priceCriteria>NBRTRAN</priceCriteria>
        <priceCompTierId></priceCompTierId>
        <tieringSeqNum>10</tieringSeqNum>
        <parmString></parmString>
    </pricecomptier>
    <pricecomptier>
        <priceItemParmGroupId>1</priceItemParmGroupId>
        <toVal>5000.000000000000000000</toVal>
        <fromVal>1000.000000000000000000</fromVal>
        <timeOfUse></timeOfUse>
        <priceCompPriceItem>PI_026</priceCompPriceItem>
        <priceCriteria>NBRTRAN</priceCriteria>
        <priceCompTierId></priceCompTierId>
        <tieringSeqNum>10</tieringSeqNum>
        <parmString></parmString>
    </pricecomptier>
    <pricecomptier>
        <priceItemParmGroupId>1</priceItemParmGroupId>
        <toVal>999999999999.990000000000000000</toVal>
        <fromVal>5000.000000000000000000</fromVal>
        <timeOfUse></timeOfUse>
        <priceCompPriceItem>PI_026</priceCompPriceItem>
        <priceCriteria>NBRTRAN</priceCriteria>
        <priceCompTierId></priceCompTierId>
        <tieringSeqNum>10</tieringSeqNum>
        <parmString></parmString>
    </pricecomptier>
</priceComponent>

```

```

<pricecomptier>
  <priceItemParmGroupId>1</priceItemParmGroupId>
  <toVal>1000.000000000000000000</toVal>
  <fromVal>0.000000000000000000</fromVal>
  <timeOfUse></timeOfUse>
  <priceCompPriceItem>PI_026</priceCompPriceItem>
  <priceCriteria>NBRTRAN</priceCriteria>
  <priceCompTierId></priceCompTierId>
  <tieringSeqNum>10</tieringSeqNum>
  <parmString></parmString>
</pricecomptier>
<pricecomptier>
  <priceItemParmGroupId>1</priceItemParmGroupId>
  <toVal>5000.000000000000000000</toVal>
  <fromVal>1000.000000000000000000</fromVal>
  <timeOfUse></timeOfUse>
  <priceCompPriceItem>PI_026</priceCompPriceItem>
  <priceCriteria>NBRTRAN</priceCriteria>
  <priceCompTierId></priceCompTierId>
  <tieringSeqNum>10</tieringSeqNum>
  <parmString></parmString>
</pricecomptier>
<pricecomptier>
  <priceItemParmGroupId>1</priceItemParmGroupId>
  <toVal>999999999999.990000000000000000</toVal>
  <fromVal>5000.000000000000000000</fromVal>
  <timeOfUse></timeOfUse>
  <priceCompPriceItem>PI_026</priceCompPriceItem>
  <priceCriteria>NBRTRAN</priceCriteria>
  <priceCompTierId></priceCompTierId>
  <tieringSeqNum>10</tieringSeqNum>
  <parmString></parmString>
</pricecomptier>
</priceComponent>
<priceComponent>
  <priceCompId>5417400025</priceCompId>
  <priceCompDescr>Step 2</priceCompDescr>
  <valueAmt>4.000000000000000000</valueAmt>
  <tieredFlag></tieredFlag>
  <pricecomptier>
    <priceItemParmGroupId>1</priceItemParmGroupId>
    <toVal>1000.000000000000000000</toVal>
    <fromVal>0.000000000000000000</fromVal>
    <timeOfUse></timeOfUse>
    <priceCompPriceItem>PI_026</priceCompPriceItem>
    <priceCriteria>NBRTRAN</priceCriteria>
    <priceCompTierId></priceCompTierId>
    <tieringSeqNum>10</tieringSeqNum>
    <parmString></parmString>
  </pricecomptier>
  <pricecomptier>
    <priceItemParmGroupId>1</priceItemParmGroupId>
    <toVal>5000.000000000000000000</toVal>
    <fromVal>1000.000000000000000000</fromVal>
    <timeOfUse></timeOfUse>
    <priceCompPriceItem>PI_026</priceCompPriceItem>
    <priceCriteria>NBRTRAN</priceCriteria>
    <priceCompTierId></priceCompTierId>
    <tieringSeqNum>10</tieringSeqNum>
    <parmString></parmString>
  </pricecomptier>
  <pricecomptier>
    <priceItemParmGroupId>1</priceItemParmGroupId>
    <toVal>999999999999.990000000000000000</toVal>

```



```

    <fromVal>5000.00000000000000000000</fromVal>
    <timeOfUse></timeOfUse>
    <priceCompPriceItem>PI_026</priceCompPriceItem>
    <priceCriteria>NBRTRAN</priceCriteria>
    <priceCompTierId></priceCompTierId>
    <tieringSeqNum>10</tieringSeqNum>
    <parmString></parmString>
  </pricecomptier>
  <pricecomptier>
    <priceItemParmGroupId>1</priceItemParmGroupId>
    <toVal>1000.00000000000000000000</toVal>
    <fromVal>0.00000000000000000000</fromVal>
    <timeOfUse></timeOfUse>
    <priceCompPriceItem>PI_026</priceCompPriceItem>
    <priceCriteria>NBRTRAN</priceCriteria>
    <priceCompTierId></priceCompTierId>
    <tieringSeqNum>10</tieringSeqNum>
    <parmString></parmString>
  </pricecomptier>
  <pricecomptier>
    <priceItemParmGroupId>1</priceItemParmGroupId>
    <toVal>5000.00000000000000000000</toVal>
    <fromVal>1000.00000000000000000000</fromVal>
    <timeOfUse></timeOfUse>
    <priceCompPriceItem>PI_026</priceCompPriceItem>
    <priceCriteria>NBRTRAN</priceCriteria>
    <priceCompTierId></priceCompTierId>
    <tieringSeqNum>10</tieringSeqNum>
    <parmString></parmString>
  </pricecomptier>
  <pricecomptier>
    <priceItemParmGroupId>1</priceItemParmGroupId>
    <toVal>99999999999.99000000000000000000</toVal>
    <fromVal>5000.00000000000000000000</fromVal>
    <timeOfUse></timeOfUse>
    <priceCompPriceItem>PI_026</priceCompPriceItem>
    <priceCriteria>NBRTRAN</priceCriteria>
    <priceCompTierId></priceCompTierId>
    <tieringSeqNum>10</tieringSeqNum>
    <parmString></parmString>
  </pricecomptier>
</priceComponent>
<priceComponent>
  <priceCompId>5417400026</priceCompId>
  <priceCompDescr>Step 3</priceCompDescr>
  <valueAmt>3.00000000000000000000</valueAmt>
  <tieredFlag></tieredFlag>
  <pricecomptier>
    <priceItemParmGroupId>1</priceItemParmGroupId>
    <toVal>1000.00000000000000000000</toVal>
    <fromVal>0.00000000000000000000</fromVal>
    <timeOfUse></timeOfUse>
    <priceCompPriceItem>PI_026</priceCompPriceItem>
    <priceCriteria>NBRTRAN</priceCriteria>
    <priceCompTierId></priceCompTierId>
    <tieringSeqNum>10</tieringSeqNum>
    <parmString></parmString>
  </pricecomptier>
  <pricecomptier>
    <priceItemParmGroupId>1</priceItemParmGroupId>
    <toVal>5000.00000000000000000000</toVal>
    <fromVal>1000.00000000000000000000</fromVal>
    <timeOfUse></timeOfUse>
    <priceCompPriceItem>PI_026</priceCompPriceItem>

```

```

        <priceCriteria>NBRTRAN</priceCriteria>
        <priceCompTierId></priceCompTierId>
        <tieringSeqNum>10</tieringSeqNum>
        <parmString></parmString>
    </pricecomptier>
    <pricecomptier>
        <priceItemParmGroupId>1</priceItemParmGroupId>
        <toVal>999999999999.99000000000000000000</toVal>
        <fromVal>5000.00000000000000000000</fromVal>
        <timeOfUse></timeOfUse>
        <priceCompPriceItem>PI_026</priceCompPriceItem>
        <priceCriteria>NBRTRAN</priceCriteria>
        <priceCompTierId></priceCompTierId>
        <tieringSeqNum>10</tieringSeqNum>
        <parmString></parmString>
    </pricecomptier>
    <pricecomptier>
        <priceItemParmGroupId>1</priceItemParmGroupId>
        <toVal>1000.00000000000000000000</toVal>
        <fromVal>0.00000000000000000000</fromVal>
        <timeOfUse></timeOfUse>
        <priceCompPriceItem>PI_026</priceCompPriceItem>
        <priceCriteria>NBRTRAN</priceCriteria>
        <priceCompTierId></priceCompTierId>
        <tieringSeqNum>10</tieringSeqNum>
        <parmString></parmString>
    </pricecomptier>
    <pricecomptier>
        <priceItemParmGroupId>1</priceItemParmGroupId>
        <toVal>5000.00000000000000000000</toVal>
        <fromVal>1000.00000000000000000000</fromVal>
        <timeOfUse></timeOfUse>
        <priceCompPriceItem>PI_026</priceCompPriceItem>
        <priceCriteria>NBRTRAN</priceCriteria>
        <priceCompTierId></priceCompTierId>
        <tieringSeqNum>10</tieringSeqNum>
        <parmString></parmString>
    </pricecomptier>
    <pricecomptier>
        <priceItemParmGroupId>1</priceItemParmGroupId>
        <toVal>999999999999.99000000000000000000</toVal>
        <fromVal>5000.00000000000000000000</fromVal>
        <timeOfUse></timeOfUse>
        <priceCompPriceItem>PI_026</priceCompPriceItem>
        <priceCriteria>NBRTRAN</priceCriteria>
        <priceCompTierId></priceCompTierId>
        <tieringSeqNum>10</tieringSeqNum>
        <parmString></parmString>
    </pricecomptier>
</priceComponent>
</pricing>
<pricing>
    <priceListId>5417730766</priceListId>
    <priceListDescription>PriceList -1</priceListDescription>
    <priority>1</priority>
    <validityFlag></validityFlag>
    <noOfDays></noOfDays>
    <priceItemCode>PI_027</priceItemCode>
    <priceitemCodeDescr>V7-Direct Debit</priceitemCodeDescr>
    <priceAsgnId>5410009209</priceAsgnId>
    <priceListStartDate>2022-01-11</priceListStartDate>
    <priceListEndDate>2022-02-28</priceListEndDate>
    <priceComponent>
        <priceCompId>5417300038</priceCompId>
    </priceComponent>

```

```

    <priceCompDescr>Basic BK-NBR</priceCompDescr>
    <valueAmt>0.150000000000000000</valueAmt>
    <tieredFlag></tieredFlag>
    <pricecomptier>
      <priceItemParmGroupId></priceItemParmGroupId>
      <toVal></toVal>
      <fromVal></fromVal>
      <timeOfUse></timeOfUse>
      <priceCompPriceItem></priceCompPriceItem>
      <priceCriteria></priceCriteria>
      <priceCompTierId></priceCompTierId>
      <tieringSeqNum></tieringSeqNum>
      <parmString></parmString>
    </pricecomptier>
  </priceComponent>
</pricing>
<pricing>
  <priceListId>5417730766</priceListId>
  <priceListDescription>PriceList -1</priceListDescription>
  <priority>1</priority>
  <validityFlag></validityFlag>
  <noOfDays></noOfDays>
  <priceItemCode>PI_028</priceItemCode>
  <priceitemCodeDescr>V8-Cheque Collections</priceitemCodeDescr>
  <priceAsgnId>5410009210</priceAsgnId>
  <priceListStartDate>2022-01-11</priceListStartDate>
  <priceListEndDate>2022-02-28</priceListEndDate>
  <priceComponent>
    <priceCompId>5417300040</priceCompId>
    <priceCompDescr>FLAT</priceCompDescr>
    <valueAmt>0.750000000000000000</valueAmt>
    <tieredFlag></tieredFlag>
    <pricecomptier>
      <priceItemParmGroupId></priceItemParmGroupId>
      <toVal></toVal>
      <fromVal></fromVal>
      <timeOfUse></timeOfUse>
      <priceCompPriceItem></priceCompPriceItem>
      <priceCriteria></priceCriteria>
      <priceCompTierId></priceCompTierId>
      <tieringSeqNum></tieringSeqNum>
      <parmString></parmString>
    </pricecomptier>
  </priceComponent>
</pricing>
<pricing>
  <priceListId>5417730766</priceListId>
  <priceListDescription>PriceList -1</priceListDescription>
  <priority>1</priority>
  <validityFlag></validityFlag>
  <noOfDays></noOfDays>
  <priceItemCode>PI_028</priceItemCode>
  <priceitemCodeDescr>V8-Cheque Collections</priceitemCodeDescr>
  <priceAsgnId>5410009211</priceAsgnId>
  <priceListStartDate>2022-01-11</priceListStartDate>
  <priceListEndDate>2022-02-28</priceListEndDate>
  <priceComponent>
    <priceCompId>5417300042</priceCompId>
    <priceCompDescr>FLAT</priceCompDescr>
    <valueAmt>6.670000000000000000</valueAmt>
    <tieredFlag></tieredFlag>
    <pricecomptier>
      <priceItemParmGroupId></priceItemParmGroupId>
      <toVal></toVal>

```

```

        <fromVal></fromVal>
        <timeOfUse></timeOfUse>
        <priceCompPriceItem></priceCompPriceItem>
        <priceCriteria></priceCriteria>
        <priceCompTierId></priceCompTierId>
        <tieringSeqNum></tieringSeqNum>
        <parmString></parmString>
    </pricecomptier>
</priceComponent>
</pricing>
<pricing>
    <priceListId>5417730766</priceListId>
    <priceListDescription>PriceList -1</priceListDescription>
    <priority>1</priority>
    <validityFlag></validityFlag>
    <noOfDays></noOfDays>
    <priceItemCode>PI_028</priceItemCode>
    <priceitemCodeDescr>V8-Cheque Collections</priceitemCodeDescr>
    <priceAsgnId>5410009212</priceAsgnId>
    <priceListStartDate>2022-01-11</priceListStartDate>
    <priceListEndDate>2022-02-28</priceListEndDate>
    <priceComponent>
        <priceCompId>5417300044</priceCompId>
        <priceCompDescr>FLAT</priceCompDescr>
        <valueAmt>0.300000000000000000</valueAmt>
        <tieredFlag></tieredFlag>
        <pricecomptier>
            <priceItemParmGroupId></priceItemParmGroupId>
            <toVal></toVal>
            <fromVal></fromVal>
            <timeOfUse></timeOfUse>
            <priceCompPriceItem></priceCompPriceItem>
            <priceCriteria></priceCriteria>
            <priceCompTierId></priceCompTierId>
            <tieringSeqNum></tieringSeqNum>
            <parmString></parmString>
        </pricecomptier>
    </priceComponent>
</pricing>
<pricing>
    <priceListId>5417730766</priceListId>
    <priceListDescription>PriceList -1</priceListDescription>
    <priority>1</priority>
    <validityFlag></validityFlag>
    <noOfDays></noOfDays>
    <priceItemCode>PI_028</priceItemCode>
    <priceitemCodeDescr>V8-Cheque Collections</priceitemCodeDescr>
    <priceAsgnId>5410009213</priceAsgnId>
    <priceListStartDate>2022-01-11</priceListStartDate>
    <priceListEndDate>2022-02-28</priceListEndDate>
    <priceComponent>
        <priceCompId>5417300046</priceCompId>
        <priceCompDescr>FLAT</priceCompDescr>
        <valueAmt>2.050000000000000000</valueAmt>
        <tieredFlag></tieredFlag>
        <pricecomptier>
            <priceItemParmGroupId></priceItemParmGroupId>
            <toVal></toVal>
            <fromVal></fromVal>
            <timeOfUse></timeOfUse>
            <priceCompPriceItem></priceCompPriceItem>
            <priceCriteria></priceCriteria>
            <priceCompTierId></priceCompTierId>
            <tieringSeqNum></tieringSeqNum>
        </pricecomptier>
    </priceComponent>
</pricing>

```

```

        <parmString></parmString>
      </pricecomptier>
    </priceComponent>
  </pricing>
</pricing>
<pricing>
  <priceListId>5417730766</priceListId>
  <priceListDescription>PriceList -1</priceListDescription>
  <priority>1</priority>
  <validityFlag></validityFlag>
  <noOfDays></noOfDays>
  <priceItemCode>PI_029</priceItemCode>
  <priceitemCodeDescr>V9-Domestic Liquidity</priceitemCodeDescr>
  <priceAsgnId>5410009214</priceAsgnId>
  <priceListStartDate>2022-01-11</priceListStartDate>
  <priceListEndDate>2022-02-28</priceListEndDate>
  <priceComponent>
    <priceCompId>5417300048</priceCompId>
    <priceCompDescr>FLAT</priceCompDescr>
    <valueAmt>0.400000000000000000</valueAmt>
    <tieredFlag></tieredFlag>
    <pricecomptier>
      <priceItemParmGroupId></priceItemParmGroupId>
      <toVal></toVal>
      <fromVal></fromVal>
      <timeOfUse></timeOfUse>
      <priceCompPriceItem></priceCompPriceItem>
      <priceCriteria></priceCriteria>
      <priceCompTierId></priceCompTierId>
      <tieringSeqNum></tieringSeqNum>
      <parmString></parmString>
    </pricecomptier>
  </priceComponent>
</pricing>
</pricing>
<pricing>
  <priceListId>5417730766</priceListId>
  <priceListDescription>PriceList -1</priceListDescription>
  <priority>1</priority>
  <validityFlag></validityFlag>
  <noOfDays></noOfDays>
  <priceItemCode>PI_030</priceItemCode>
  <priceitemCodeDescr>V10-Third Party Bank</priceitemCodeDescr>
  <priceAsgnId>5410009215</priceAsgnId>
  <priceListStartDate>2022-01-11</priceListStartDate>
  <priceListEndDate>2022-02-28</priceListEndDate>
  <priceComponent>
    <priceCompId>5417300050</priceCompId>
    <priceCompDescr>FLAT</priceCompDescr>
    <valueAmt>0.600000000000000000</valueAmt>
    <tieredFlag></tieredFlag>
    <pricecomptier>
      <priceItemParmGroupId></priceItemParmGroupId>
      <toVal></toVal>
      <fromVal></fromVal>
      <timeOfUse></timeOfUse>
      <priceCompPriceItem></priceCompPriceItem>
      <priceCriteria></priceCriteria>
      <priceCompTierId></priceCompTierId>
      <tieringSeqNum></tieringSeqNum>
      <parmString></parmString>
    </pricecomptier>
  </priceComponent>
</pricing>
</pricing>
<pricing>
  <priceListId>5417730766</priceListId>

```

```

<priceListDescription>PriceList -1</priceListDescription>
<priority>1</priority>
<validityFlag></validityFlag>
<noOfDays></noOfDays>
<priceItemCode>PI_031</priceItemCode>
<priceitemCodeDescr>MT943_SWIFT_01</priceitemCodeDescr>
<priceAsgnId>5410009201</priceAsgnId>
<priceListStartDate>2022-01-11</priceListStartDate>
<priceListEndDate>2022-02-28</priceListEndDate>
<priceComponent>
  <priceCompId>5417300002</priceCompId>
  <priceCompDescr>FLAT</priceCompDescr>
  <valueAmt>16.660000000000000000</valueAmt>
  <tieredFlag></tieredFlag>
  <pricecomptier>
    <priceItemParmGroupId></priceItemParmGroupId>
    <toVal></toVal>
    <fromVal></fromVal>
    <timeOfUse></timeOfUse>
    <priceCompPriceItem></priceCompPriceItem>
    <priceCriteria></priceCriteria>
    <priceCompTierId></priceCompTierId>
    <tieringSeqNum></tieringSeqNum>
    <parmString></parmString>
  </pricecomptier>
</priceComponent>
</pricing>
<pricing>
  <priceListId>5417730766</priceListId>
  <priceListDescription>PriceList -1</priceListDescription>
  <priority>1</priority>
  <validityFlag></validityFlag>
  <noOfDays></noOfDays>
  <priceItemCode>PI_032</priceItemCode>
  <priceitemCodeDescr>MT943_SWIFT_02</priceitemCodeDescr>
  <priceAsgnId>5410009261</priceAsgnId>
  <priceListStartDate>2022-01-11</priceListStartDate>
  <priceListEndDate>2022-02-28</priceListEndDate>
  <priceComponent>
    <priceCompId>5417450002</priceCompId>
    <priceCompDescr>FLAT</priceCompDescr>
    <valueAmt>15.000000000000000000</valueAmt>
    <tieredFlag></tieredFlag>
    <pricecomptier>
      <priceItemParmGroupId></priceItemParmGroupId>
      <toVal></toVal>
      <fromVal></fromVal>
      <timeOfUse></timeOfUse>
      <priceCompPriceItem></priceCompPriceItem>
      <priceCriteria></priceCriteria>
      <priceCompTierId></priceCompTierId>
      <tieringSeqNum></tieringSeqNum>
      <parmString></parmString>
    </pricecomptier>
  </priceComponent>
</pricing>
</C1-GetProdDetail>

```

Related Topics

For more information on...	See...
Market Product, Offer, or Bundle View Request and Response - Tags in XML Format	Market Product, Offer, or Bundle View Request - Tags in XML Format on page 3474

Sample Offer View Request and Response in the XML Format

Using the below example, you can view offers which are processed on **2022-01-11**.

Sample Offer View Request in the XML Format

```
<C1-GetProdDetail>
  <entityCode>CHECKOFF_01</entityCode>
  <entityType>OFFR</entityType>
  <processDate>2022-01-11</processDate>
  <inquiryTypeFlag>DETL</inquiryTypeFlag>
  <division></division>
</C1-GetProdDetail>
```

Sample Offer View Response in the XML Format

```
<C1-GetProdDetail>
  <entityCode>CHECKOFF_01</entityCode>
  <entityType>OFFR</entityType>
  <processDate>2022-01-11</processDate>
  <inquiryTypeFlag>DETL</inquiryTypeFlag>
  <division></division>
  <entityName>CHECKOFF_01</entityName>
  <entityStartDate>2022-01-11</entityStartDate>
  <entityEndDate>2022-03-31</entityEndDate>
  <termsAndCondition>TERMSPRAAS2</termsAndCondition>
  <status>ACTIVE</status>
  <termsAndCondDescr>TERMSPRAAS2</termsAndCondDescr>
  <messageCategory>0</messageCategory>
  <messageNumber>0</messageNumber>
  <messageText></messageText>
  <longDescription></longDescription>
  <productlist>
    <productCode>LOAN_001</productCode>
    <productName>LOAN_001</productName>
    <prodTypFlg></prodTypFlg>
    <productCategoryFlgDesc>Loans</productCategoryFlgDesc>
  </productlist>
  <productLinkedEntity>
    <linkedEntityCode>CHECKMP_001</linkedEntityCode>
    <linkedEntityName></linkedEntityName>
    <linkedEntityType>MP</linkedEntityType>
  </productLinkedEntity>
  <productLinkedEntity>
    <linkedEntityCode>CHEKMP_002</linkedEntityCode>
    <linkedEntityName></linkedEntityName>
    <linkedEntityType>MP</linkedEntityType>
  </productLinkedEntity>
  <productLinkedEntity>
    <linkedEntityCode>LOANSMP_003</linkedEntityCode>
    <linkedEntityName></linkedEntityName>
    <linkedEntityType>MP</linkedEntityType>
  </productLinkedEntity>
  <productLinkedEntity>
    <linkedEntityCode>LOANSMP_004</linkedEntityCode>
    <linkedEntityName></linkedEntityName>
    <linkedEntityType>MP</linkedEntityType>
  </productLinkedEntity>
  <EntityDivision>
```

```

    <divisionCode>IND</divisionCode>
  </EntityDivision>
  <EntityDivision>
    <divisionCode>MH</divisionCode>
  </EntityDivision>
  <eligibilityDetails>
    <eligibilityDescription>ELG_OFFLOANS1</eligibilityDescription>
    <eligibilityStartDate>2022-01-01</eligibilityStartDate>
    <eligibilityEndDate></eligibilityEndDate>
    <eligibilityRule>
      <rhsPriceParmCd></rhsPriceParmCd>
      <rhsPriceParmVal>IND</rhsPriceParmVal>
      <lhsPriceParmCd>ACC_DIVISION</lhsPriceParmCd>
      <rhsPriceParmTypeFlg>VAL</rhsPriceParmTypeFlg>
      <trueFlag>RLTR</trueFlag>
      <trueFlagDescr></trueFlagDescr>
      <falseFlag>RLFS</falseFlag>
      <falseFlagDescr></falseFlagDescr>
      <insufficientFlag>RLFS</insufficientFlag>
      <insufficientFlagDescr></insufficientFlagDescr>
      <eligibilityRuleFlg></eligibilityRuleFlg>
      <eligibilityDescr></eligibilityDescr>
      <operator>=</operator>
      <priceParmCode></priceParmCode>
      <sequenceNumber>10</sequenceNumber>
    </eligibilityRule>
  </eligibilityDetails>
  <services>
    <serviceCd></serviceCd>
    <serviceName>Product Service PRASS1</serviceName>
    <mandatoryFlag>true</mandatoryFlag>
  </services>
  <services>
    <serviceCd></serviceCd>
    <serviceName>Product Service PRASS2</serviceName>
    <mandatoryFlag>true</mandatoryFlag>
  </services>
  <services>
    <serviceCd></serviceCd>
    <serviceName>MH division product service</serviceName>
    <mandatoryFlag>true</mandatoryFlag>
  </services>
  <pricing>
    <priceListId>4368251923</priceListId>
    <priceListDescription>Currency_Con_PriceList -1</priceListDescription>
    <priority>1</priority>
    <validityFlag></validityFlag>
    <noOfDays>90</noOfDays>
    <priceItemCode>CC_021</priceItemCode>
    <priceitemCodeDescr>CC_21-Account Opening Fee</priceitemCodeDescr>
    <priceAsgnId>4360009281</priceAsgnId>
    <priceListStartDate>2022-01-11</priceListStartDate>
    <priceListEndDate>2022-04-11</priceListEndDate>
    <priceComponent>
      <priceCompId>4367475002</priceCompId>
      <priceCompDescr>FLAT</priceCompDescr>
      <valueAmt>0.400000000000000000</valueAmt>
      <tieredFlag></tieredFlag>
      <pricecomptier>
        <priceItemParmGroupId></priceItemParmGroupId>
        <toVal></toVal>
        <fromVal></fromVal>
        <timeOfUse></timeOfUse>
        <priceCompPriceItem></priceCompPriceItem>
      </pricecomptier>
    </priceComponent>
  </pricing>

```



```

        <priceCriteria></priceCriteria>
        <priceCompTierId></priceCompTierId>
        <tieringSeqNum></tieringSeqNum>
        <parmString></parmString>
    </pricecomptier>
</priceComponent>
</pricing>
<pricing>
    <priceListId>4368251923</priceListId>
    <priceListDescription>Currency_Con_PriceList -1</priceListDescription>
    <priority>1</priority>
    <validityFlag></validityFlag>
    <noOfDays>90</noOfDays>
    <priceItemCode>CC_022</priceItemCode>
    <priceitemCodeDescr>CC2-Monthly Acct Serv Fee</priceitemCodeDescr>
    <priceAsgnId>4360009282</priceAsgnId>
    <priceListStartDate>2022-01-11</priceListStartDate>
    <priceListEndDate>2022-04-11</priceListEndDate>
    <priceComponent>
        <priceCompId>4367475004</priceCompId>
        <priceCompDescr>FLAT</priceCompDescr>
        <valueAmt>0.60000000000000000000</valueAmt>
        <tieredFlag></tieredFlag>
        <pricecomptier>
            <priceItemParmGroupId></priceItemParmGroupId>
            <toVal></toVal>
            <fromVal></fromVal>
            <timeOfUse></timeOfUse>
            <priceCompPriceItem></priceCompPriceItem>
            <priceCriteria></priceCriteria>
            <priceCompTierId></priceCompTierId>
            <tieringSeqNum></tieringSeqNum>
            <parmString></parmString>
        </pricecomptier>
    </priceComponent>
</pricing>
<pricing>
    <priceListId>4368251923</priceListId>
    <priceListDescription>Currency_Con_PriceList -1</priceListDescription>
    <priority>1</priority>
    <validityFlag></validityFlag>
    <noOfDays>90</noOfDays>
    <priceItemCode>CC_024</priceItemCode>
    <priceitemCodeDescr>CC3-SEPA Transfers</priceitemCodeDescr>
    <priceAsgnId>4360009283</priceAsgnId>
    <priceListStartDate>2022-01-11</priceListStartDate>
    <priceListEndDate>2022-04-11</priceListEndDate>
    <priceComponent>
        <priceCompId>4367475006</priceCompId>
        <priceCompDescr>FLAT</priceCompDescr>
        <valueAmt>0.25000000000000000000</valueAmt>
        <tieredFlag></tieredFlag>
        <pricecomptier>
            <priceItemParmGroupId></priceItemParmGroupId>
            <toVal></toVal>
            <fromVal></fromVal>
            <timeOfUse></timeOfUse>
            <priceCompPriceItem></priceCompPriceItem>
            <priceCriteria></priceCriteria>
            <priceCompTierId></priceCompTierId>
            <tieringSeqNum></tieringSeqNum>
            <parmString></parmString>
        </pricecomptier>
    </priceComponent>
</pricing>

```

```

</pricing>
<pricing>
  <priceListId>4368251923</priceListId>
  <priceListDescription>Currency_Con_PriceList -1</priceListDescription>
  <priority>1</priority>
  <validityFlag></validityFlag>
  <noOfDays>90</noOfDays>
  <priceItemCode>CC_025</priceItemCode>
  <priceitemCodeDescr></priceitemCodeDescr>
  <priceAsgnId>4360009284</priceAsgnId>
  <priceListStartDate>2022-01-11</priceListStartDate>
  <priceListEndDate>2022-04-11</priceListEndDate>
  <priceComponent>
    <priceCompId>4367475008</priceCompId>
    <priceCompDescr>FLAT</priceCompDescr>
    <valueAmt>112.040000000000000000</valueAmt>
    <tieredFlag></tieredFlag>
    <pricecomptier>
      <priceItemParmGroupId></priceItemParmGroupId>
      <toVal></toVal>
      <fromVal></fromVal>
      <timeOfUse></timeOfUse>
      <priceCompPriceItem></priceCompPriceItem>
      <priceCriteria></priceCriteria>
      <priceCompTierId></priceCompTierId>
      <tieringSeqNum></tieringSeqNum>
      <parmString></parmString>
    </pricecomptier>
  </priceComponent>
</pricing>
<pricing>
  <priceListId>5417730766</priceListId>
  <priceListDescription>PriceList -1</priceListDescription>
  <priority>3</priority>
  <validityFlag></validityFlag>
  <noOfDays>60</noOfDays>
  <priceItemCode>PI_021</priceItemCode>
  <priceitemCodeDescr>V1-Account Opening Fee</priceitemCodeDescr>
  <priceAsgnId>5410009202</priceAsgnId>
  <priceListStartDate>2022-01-11</priceListStartDate>
  <priceListEndDate>2022-03-12</priceListEndDate>
  <priceComponent>
    <priceCompId>5417300004</priceCompId>
    <priceCompDescr>FLAT</priceCompDescr>
    <valueAmt>0.250000000000000000</valueAmt>
    <tieredFlag></tieredFlag>
    <pricecomptier>
      <priceItemParmGroupId></priceItemParmGroupId>
      <toVal></toVal>
      <fromVal></fromVal>
      <timeOfUse></timeOfUse>
      <priceCompPriceItem></priceCompPriceItem>
      <priceCriteria></priceCriteria>
      <priceCompTierId></priceCompTierId>
      <tieringSeqNum></tieringSeqNum>
      <parmString></parmString>
    </pricecomptier>
  </priceComponent>
</pricing>
<pricing>
  <priceListId>5417730766</priceListId>
  <priceListDescription>PriceList -1</priceListDescription>
  <priority>3</priority>
  <validityFlag></validityFlag>

```

```

<noOfDays>60</noOfDays>
<priceItemCode>PI_022</priceItemCode>
<priceitemCodeDescr>V2-Monthly Acct Serv Fee</priceitemCodeDescr>
<priceAsgnId>5410009203</priceAsgnId>
<priceListStartDate>2022-01-11</priceListStartDate>
<priceListEndDate>2022-03-12</priceListEndDate>
<priceComponent>
  <priceCompId>5417300006</priceCompId>
  <priceCompDescr>FLAT</priceCompDescr>
  <valueAmt>112.040000000000000000</valueAmt>
  <tieredFlag></tieredFlag>
  <pricecomptier>
    <priceItemParmGroupId></priceItemParmGroupId>
    <toVal></toVal>
    <fromVal></fromVal>
    <timeOfUse></timeOfUse>
    <priceCompPriceItem></priceCompPriceItem>
    <priceCriteria></priceCriteria>
    <priceCompTierId></priceCompTierId>
    <tieringSeqNum></tieringSeqNum>
    <parmString></parmString>
  </pricecomptier>
</priceComponent>
</pricing>
<pricing>
  <priceListId>5417730766</priceListId>
  <priceListDescription>PriceList -1</priceListDescription>
  <priority>3</priority>
  <validityFlag></validityFlag>
  <noOfDays>60</noOfDays>
  <priceItemCode>PI_023</priceItemCode>
  <priceitemCodeDescr>V3-Audit Reports</priceitemCodeDescr>
  <priceAsgnId>5410009204</priceAsgnId>
  <priceListStartDate>2022-01-11</priceListStartDate>
  <priceListEndDate>2022-03-12</priceListEndDate>
  <priceComponent>
    <priceCompId>5417300008</priceCompId>
    <priceCompDescr>FLAT</priceCompDescr>
    <valueAmt>276.250000000000000000</valueAmt>
    <tieredFlag></tieredFlag>
    <pricecomptier>
      <priceItemParmGroupId></priceItemParmGroupId>
      <toVal></toVal>
      <fromVal></fromVal>
      <timeOfUse></timeOfUse>
      <priceCompPriceItem></priceCompPriceItem>
      <priceCriteria></priceCriteria>
      <priceCompTierId></priceCompTierId>
      <tieringSeqNum></tieringSeqNum>
      <parmString></parmString>
    </pricecomptier>
  </priceComponent>
</pricing>
<pricing>
  <priceListId>5417730766</priceListId>
  <priceListDescription>PriceList -1</priceListDescription>
  <priority>3</priority>
  <validityFlag></validityFlag>
  <noOfDays>60</noOfDays>
  <priceItemCode>PI_024</priceItemCode>
  <priceitemCodeDescr>V4-SEPA Transfers</priceitemCodeDescr>
  <priceAsgnId>5410009241</priceAsgnId>
  <priceListStartDate>2022-01-11</priceListStartDate>
  <priceListEndDate>2022-03-12</priceListEndDate>

```

```

<priceComponent>
  <priceCompId>5417400004</priceCompId>
  <priceCompDescr>Price per transaction - Step Tier 1</priceCompDescr>
  <valueAmt>12.950000000000000000</valueAmt>
  <tieredFlag></tieredFlag>
  <pricecomptier>
    <priceItemParmGroupId>1</priceItemParmGroupId>
    <toVal>1000.000000000000000000</toVal>
    <fromVal>0.000000000000000000</fromVal>
    <timeOfUse></timeOfUse>
    <priceCompPriceItem>PI_024</priceCompPriceItem>
    <priceCriteria>NBRTRAN</priceCriteria>
    <priceCompTierId></priceCompTierId>
    <tieringSeqNum>10</tieringSeqNum>
    <parmString></parmString>
  </pricecomptier>
  <pricecomptier>
    <priceItemParmGroupId>1</priceItemParmGroupId>
    <toVal>5000.000000000000000000</toVal>
    <fromVal>1000.000000000000000000</fromVal>
    <timeOfUse></timeOfUse>
    <priceCompPriceItem>PI_024</priceCompPriceItem>
    <priceCriteria>NBRTRAN</priceCriteria>
    <priceCompTierId></priceCompTierId>
    <tieringSeqNum>10</tieringSeqNum>
    <parmString></parmString>
  </pricecomptier>
  <pricecomptier>
    <priceItemParmGroupId>1</priceItemParmGroupId>
    <toVal>999999999999.990000000000000000</toVal>
    <fromVal>5000.000000000000000000</fromVal>
    <timeOfUse></timeOfUse>
    <priceCompPriceItem>PI_024</priceCompPriceItem>
    <priceCriteria>NBRTRAN</priceCriteria>
    <priceCompTierId></priceCompTierId>
    <tieringSeqNum>10</tieringSeqNum>
    <parmString></parmString>
  </pricecomptier>
</priceComponent>
<priceComponent>
  <priceCompId>5417400005</priceCompId>
  <priceCompDescr>Price per transaction - Step Tier 2</priceCompDescr>
  <valueAmt>12.150000000000000000</valueAmt>
  <tieredFlag></tieredFlag>
  <pricecomptier>
    <priceItemParmGroupId>1</priceItemParmGroupId>
    <toVal>1000.000000000000000000</toVal>
    <fromVal>0.000000000000000000</fromVal>
    <timeOfUse></timeOfUse>
    <priceCompPriceItem>PI_024</priceCompPriceItem>
    <priceCriteria>NBRTRAN</priceCriteria>
    <priceCompTierId></priceCompTierId>
    <tieringSeqNum>10</tieringSeqNum>
    <parmString></parmString>
  </pricecomptier>
  <pricecomptier>
    <priceItemParmGroupId>1</priceItemParmGroupId>
    <toVal>5000.000000000000000000</toVal>
    <fromVal>1000.000000000000000000</fromVal>
    <timeOfUse></timeOfUse>
    <priceCompPriceItem>PI_024</priceCompPriceItem>
    <priceCriteria>NBRTRAN</priceCriteria>
    <priceCompTierId></priceCompTierId>
    <tieringSeqNum>10</tieringSeqNum>
  </pricecomptier>

```

```

        <parmString></parmString>
    </pricecomptier>
    <pricecomptier>
        <priceItemParmGroupId>1</priceItemParmGroupId>
        <toVal>999999999999.99000000000000000000</toVal>
        <fromVal>5000.00000000000000000000</fromVal>
        <timeOfUse></timeOfUse>
        <priceCompPriceItem>PI_024</priceCompPriceItem>
        <priceCriteria>NBRTRAN</priceCriteria>
        <priceCompTierId></priceCompTierId>
        <tieringSeqNum>10</tieringSeqNum>
        <parmString></parmString>
    </pricecomptier>
</priceComponent>
<priceComponent>
    <priceCompId>5417400006</priceCompId>
    <priceCompDescr>Price per transaction - Step Tier 3</priceCompDescr>
    <valueAmt>11.95000000000000000000</valueAmt>
    <tieredFlag></tieredFlag>
    <pricecomptier>
        <priceItemParmGroupId>1</priceItemParmGroupId>
        <toVal>1000.00000000000000000000</toVal>
        <fromVal>0.00000000000000000000</fromVal>
        <timeOfUse></timeOfUse>
        <priceCompPriceItem>PI_024</priceCompPriceItem>
        <priceCriteria>NBRTRAN</priceCriteria>
        <priceCompTierId></priceCompTierId>
        <tieringSeqNum>10</tieringSeqNum>
        <parmString></parmString>
    </pricecomptier>
    <pricecomptier>
        <priceItemParmGroupId>1</priceItemParmGroupId>
        <toVal>5000.00000000000000000000</toVal>
        <fromVal>1000.00000000000000000000</fromVal>
        <timeOfUse></timeOfUse>
        <priceCompPriceItem>PI_024</priceCompPriceItem>
        <priceCriteria>NBRTRAN</priceCriteria>
        <priceCompTierId></priceCompTierId>
        <tieringSeqNum>10</tieringSeqNum>
        <parmString></parmString>
    </pricecomptier>
    <pricecomptier>
        <priceItemParmGroupId>1</priceItemParmGroupId>
        <toVal>999999999999.99000000000000000000</toVal>
        <fromVal>5000.00000000000000000000</fromVal>
        <timeOfUse></timeOfUse>
        <priceCompPriceItem>PI_024</priceCompPriceItem>
        <priceCriteria>NBRTRAN</priceCriteria>
        <priceCompTierId></priceCompTierId>
        <tieringSeqNum>10</tieringSeqNum>
        <parmString></parmString>
    </pricecomptier>
</priceComponent>
</pricing>
<pricing>
    <priceListId>5417730766</priceListId>
    <priceListDescription>PriceList -1</priceListDescription>
    <priority>3</priority>
    <validityFlag></validityFlag>
    <noOfDays>60</noOfDays>
    <priceItemCode>PI_025</priceItemCode>
    <priceitemCodeDescr>V5-Domestic Funds Transfer Fee</priceitemCodeDescr>
    <priceAsgnId>5410009242</priceAsgnId>
    <priceListStartDate>2022-01-11</priceListStartDate>

```

```

<priceListEndDate>2022-03-12</priceListEndDate>
<priceComponent>
  <priceCompId>5417400010</priceCompId>
  <priceCompDescr>Threshold price per transaction</priceCompDescr>
  <valueAmt>12.950000000000000000</valueAmt>
  <tieredFlag></tieredFlag>
  <pricecomptier>
    <priceItemParmGroupId>1</priceItemParmGroupId>
    <toVal>1000.000000000000000000</toVal>
    <fromVal>0.000000000000000000</fromVal>
    <timeOfUse></timeOfUse>
    <priceCompPriceItem>PI_025</priceCompPriceItem>
    <priceCriteria>NBRTRAN</priceCriteria>
    <priceCompTierId></priceCompTierId>
    <tieringSeqNum>10</tieringSeqNum>
    <parmString></parmString>
  </pricecomptier>
  <pricecomptier>
    <priceItemParmGroupId>1</priceItemParmGroupId>
    <toVal>5000.000000000000000000</toVal>
    <fromVal>1000.000000000000000000</fromVal>
    <timeOfUse></timeOfUse>
    <priceCompPriceItem>PI_025</priceCompPriceItem>
    <priceCriteria>NBRTRAN</priceCriteria>
    <priceCompTierId></priceCompTierId>
    <tieringSeqNum>10</tieringSeqNum>
    <parmString></parmString>
  </pricecomptier>
  <pricecomptier>
    <priceItemParmGroupId>1</priceItemParmGroupId>
    <toVal>999999999999.990000000000000000</toVal>
    <fromVal>5000.000000000000000000</fromVal>
    <timeOfUse></timeOfUse>
    <priceCompPriceItem>PI_025</priceCompPriceItem>
    <priceCriteria>NBRTRAN</priceCriteria>
    <priceCompTierId></priceCompTierId>
    <tieringSeqNum>10</tieringSeqNum>
    <parmString></parmString>
  </pricecomptier>
</priceComponent>
<priceComponent>
  <priceCompId>5417400011</priceCompId>
  <priceCompDescr>Threshold price per transaction</priceCompDescr>
  <valueAmt>12.150000000000000000</valueAmt>
  <tieredFlag></tieredFlag>
  <pricecomptier>
    <priceItemParmGroupId>1</priceItemParmGroupId>
    <toVal>1000.000000000000000000</toVal>
    <fromVal>0.000000000000000000</fromVal>
    <timeOfUse></timeOfUse>
    <priceCompPriceItem>PI_025</priceCompPriceItem>
    <priceCriteria>NBRTRAN</priceCriteria>
    <priceCompTierId></priceCompTierId>
    <tieringSeqNum>10</tieringSeqNum>
    <parmString></parmString>
  </pricecomptier>
  <pricecomptier>
    <priceItemParmGroupId>1</priceItemParmGroupId>
    <toVal>5000.000000000000000000</toVal>
    <fromVal>1000.000000000000000000</fromVal>
    <timeOfUse></timeOfUse>
    <priceCompPriceItem>PI_025</priceCompPriceItem>
    <priceCriteria>NBRTRAN</priceCriteria>
    <priceCompTierId></priceCompTierId>
  </pricecomptier>

```

```

        <tieringSeqNum>10</tieringSeqNum>
        <parmString></parmString>
    </pricecomptier>
    <pricecomptier>
        <priceItemParmGroupId>1</priceItemParmGroupId>
        <toVal>999999999999.99000000000000000000</toVal>
        <fromVal>5000.00000000000000000000</fromVal>
        <timeOfUse></timeOfUse>
        <priceCompPriceItem>PI_025</priceCompPriceItem>
        <priceCriteria>NBRTRAN</priceCriteria>
        <priceCompTierId></priceCompTierId>
        <tieringSeqNum>10</tieringSeqNum>
        <parmString></parmString>
    </pricecomptier>
</priceComponent>
<priceComponent>
    <priceCompId>5417400012</priceCompId>
    <priceCompDescr>Threshold price per transaction</priceCompDescr>
    <valueAmt>11.95000000000000000000</valueAmt>
    <tieredFlag></tieredFlag>
    <pricecomptier>
        <priceItemParmGroupId>1</priceItemParmGroupId>
        <toVal>1000.00000000000000000000</toVal>
        <fromVal>0.00000000000000000000</fromVal>
        <timeOfUse></timeOfUse>
        <priceCompPriceItem>PI_025</priceCompPriceItem>
        <priceCriteria>NBRTRAN</priceCriteria>
        <priceCompTierId></priceCompTierId>
        <tieringSeqNum>10</tieringSeqNum>
        <parmString></parmString>
    </pricecomptier>
    <pricecomptier>
        <priceItemParmGroupId>1</priceItemParmGroupId>
        <toVal>5000.00000000000000000000</toVal>
        <fromVal>1000.00000000000000000000</fromVal>
        <timeOfUse></timeOfUse>
        <priceCompPriceItem>PI_025</priceCompPriceItem>
        <priceCriteria>NBRTRAN</priceCriteria>
        <priceCompTierId></priceCompTierId>
        <tieringSeqNum>10</tieringSeqNum>
        <parmString></parmString>
    </pricecomptier>
    <pricecomptier>
        <priceItemParmGroupId>1</priceItemParmGroupId>
        <toVal>999999999999.99000000000000000000</toVal>
        <fromVal>5000.00000000000000000000</fromVal>
        <timeOfUse></timeOfUse>
        <priceCompPriceItem>PI_025</priceCompPriceItem>
        <priceCriteria>NBRTRAN</priceCriteria>
        <priceCompTierId></priceCompTierId>
        <tieringSeqNum>10</tieringSeqNum>
        <parmString></parmString>
    </pricecomptier>
</priceComponent>
</pricing>
<pricing>
    <priceListId>5417730766</priceListId>
    <priceListDescription>PriceList -1</priceListDescription>
    <priority>3</priority>
    <validityFlag></validityFlag>
    <noOfDays>60</noOfDays>
    <priceItemCode>PI_026</priceItemCode>
    <priceitemCodeDescr>V6-Electronic Credits</priceitemCodeDescr>
    <priceAsgnId>5410009243</priceAsgnId>

```



```

        <toVal>999999999999.99000000000000000000</toVal>
        <fromVal>5000.00000000000000000000</fromVal>
        <timeOfUse></timeOfUse>
        <priceCompPriceItem>PI_026</priceCompPriceItem>
        <priceCriteria>NBRTRAN</priceCriteria>
        <priceCompTierId></priceCompTierId>
        <tieringSeqNum>10</tieringSeqNum>
        <parmString></parmString>
    </pricecomptier>
</priceComponent>
<priceComponent>
    <priceCompId>5417400021</priceCompId>
    <priceCompDescr>Threshold price</priceCompDescr>
    <valueAmt>10.00000000000000000000</valueAmt>
    <tieredFlag></tieredFlag>
    <pricecomptier>
        <priceItemParmGroupId>1</priceItemParmGroupId>
        <toVal>1000.00000000000000000000</toVal>
        <fromVal>0.00000000000000000000</fromVal>
        <timeOfUse></timeOfUse>
        <priceCompPriceItem>PI_026</priceCompPriceItem>
        <priceCriteria>NBRTRAN</priceCriteria>
        <priceCompTierId></priceCompTierId>
        <tieringSeqNum>10</tieringSeqNum>
        <parmString></parmString>
    </pricecomptier>
    <pricecomptier>
        <priceItemParmGroupId>1</priceItemParmGroupId>
        <toVal>5000.00000000000000000000</toVal>
        <fromVal>1000.00000000000000000000</fromVal>
        <timeOfUse></timeOfUse>
        <priceCompPriceItem>PI_026</priceCompPriceItem>
        <priceCriteria>NBRTRAN</priceCriteria>
        <priceCompTierId></priceCompTierId>
        <tieringSeqNum>10</tieringSeqNum>
        <parmString></parmString>
    </pricecomptier>
    <pricecomptier>
        <priceItemParmGroupId>1</priceItemParmGroupId>
        <toVal>999999999999.99000000000000000000</toVal>
        <fromVal>5000.00000000000000000000</fromVal>
        <timeOfUse></timeOfUse>
        <priceCompPriceItem>PI_026</priceCompPriceItem>
        <priceCriteria>NBRTRAN</priceCriteria>
        <priceCompTierId></priceCompTierId>
        <tieringSeqNum>10</tieringSeqNum>
        <parmString></parmString>
    </pricecomptier>
    <pricecomptier>
        <priceItemParmGroupId>1</priceItemParmGroupId>
        <toVal>1000.00000000000000000000</toVal>
        <fromVal>0.00000000000000000000</fromVal>
        <timeOfUse></timeOfUse>
        <priceCompPriceItem>PI_026</priceCompPriceItem>
        <priceCriteria>NBRTRAN</priceCriteria>
        <priceCompTierId></priceCompTierId>
        <tieringSeqNum>10</tieringSeqNum>
        <parmString></parmString>
    </pricecomptier>
    <pricecomptier>
        <priceItemParmGroupId>1</priceItemParmGroupId>
        <toVal>5000.00000000000000000000</toVal>
        <fromVal>1000.00000000000000000000</fromVal>
        <timeOfUse></timeOfUse>

```

```

        <priceCompPriceItem>PI_026</priceCompPriceItem>
        <priceCriteria>NBRTRAN</priceCriteria>
        <priceCompTierId></priceCompTierId>
        <tieringSeqNum>10</tieringSeqNum>
        <parmString></parmString>
    </pricecomptier>
</pricecomptier>
    <priceItemParmGroupId>1</priceItemParmGroupId>
    <toVal>999999999999.99000000000000000000</toVal>
    <fromVal>5000.00000000000000000000</fromVal>
    <timeOfUse></timeOfUse>
    <priceCompPriceItem>PI_026</priceCompPriceItem>
    <priceCriteria>NBRTRAN</priceCriteria>
    <priceCompTierId></priceCompTierId>
    <tieringSeqNum>10</tieringSeqNum>
    <parmString></parmString>
</pricecomptier>
</priceComponent>
<priceComponent>
    <priceCompId>5417400022</priceCompId>
    <priceCompDescr>Threshold price</priceCompDescr>
    <valueAmt>8.00000000000000000000</valueAmt>
    <tieredFlag></tieredFlag>
    <pricecomptier>
        <priceItemParmGroupId>1</priceItemParmGroupId>
        <toVal>1000.00000000000000000000</toVal>
        <fromVal>0.00000000000000000000</fromVal>
        <timeOfUse></timeOfUse>
        <priceCompPriceItem>PI_026</priceCompPriceItem>
        <priceCriteria>NBRTRAN</priceCriteria>
        <priceCompTierId></priceCompTierId>
        <tieringSeqNum>10</tieringSeqNum>
        <parmString></parmString>
    </pricecomptier>
    <pricecomptier>
        <priceItemParmGroupId>1</priceItemParmGroupId>
        <toVal>5000.00000000000000000000</toVal>
        <fromVal>1000.00000000000000000000</fromVal>
        <timeOfUse></timeOfUse>
        <priceCompPriceItem>PI_026</priceCompPriceItem>
        <priceCriteria>NBRTRAN</priceCriteria>
        <priceCompTierId></priceCompTierId>
        <tieringSeqNum>10</tieringSeqNum>
        <parmString></parmString>
    </pricecomptier>
    <pricecomptier>
        <priceItemParmGroupId>1</priceItemParmGroupId>
        <toVal>999999999999.99000000000000000000</toVal>
        <fromVal>5000.00000000000000000000</fromVal>
        <timeOfUse></timeOfUse>
        <priceCompPriceItem>PI_026</priceCompPriceItem>
        <priceCriteria>NBRTRAN</priceCriteria>
        <priceCompTierId></priceCompTierId>
        <tieringSeqNum>10</tieringSeqNum>
        <parmString></parmString>
    </pricecomptier>
    <pricecomptier>
        <priceItemParmGroupId>1</priceItemParmGroupId>
        <toVal>1000.00000000000000000000</toVal>
        <fromVal>0.00000000000000000000</fromVal>
        <timeOfUse></timeOfUse>
        <priceCompPriceItem>PI_026</priceCompPriceItem>
        <priceCriteria>NBRTRAN</priceCriteria>
        <priceCompTierId></priceCompTierId>

```

```

        <tieringSeqNum>10</tieringSeqNum>
        <parmString></parmString>
    </pricecomptier>
</pricecomptier>
<pricecomptier>
    <priceItemParmGroupId>1</priceItemParmGroupId>
    <toVal>5000.000000000000000000</toVal>
    <fromVal>1000.000000000000000000</fromVal>
    <timeOfUse></timeOfUse>
    <priceCompPriceItem>PI_026</priceCompPriceItem>
    <priceCriteria>NBRTRAN</priceCriteria>
    <priceCompTierId></priceCompTierId>
    <tieringSeqNum>10</tieringSeqNum>
    <parmString></parmString>
</pricecomptier>
</pricecomptier>
    <priceItemParmGroupId>1</priceItemParmGroupId>
    <toVal>999999999999.990000000000000000</toVal>
    <fromVal>5000.000000000000000000</fromVal>
    <timeOfUse></timeOfUse>
    <priceCompPriceItem>PI_026</priceCompPriceItem>
    <priceCriteria>NBRTRAN</priceCriteria>
    <priceCompTierId></priceCompTierId>
    <tieringSeqNum>10</tieringSeqNum>
    <parmString></parmString>
</pricecomptier>
</priceComponent>
<priceComponent>
    <priceCompId>5417400023</priceCompId>
    <priceCompDescr>Threshold price</priceCompDescr>
    <valueAmt>6.000000000000000000</valueAmt>
    <tieredFlag></tieredFlag>
    <pricecomptier>
        <priceItemParmGroupId>1</priceItemParmGroupId>
        <toVal>1000.000000000000000000</toVal>
        <fromVal>0.000000000000000000</fromVal>
        <timeOfUse></timeOfUse>
        <priceCompPriceItem>PI_026</priceCompPriceItem>
        <priceCriteria>NBRTRAN</priceCriteria>
        <priceCompTierId></priceCompTierId>
        <tieringSeqNum>10</tieringSeqNum>
        <parmString></parmString>
    </pricecomptier>
    <pricecomptier>
        <priceItemParmGroupId>1</priceItemParmGroupId>
        <toVal>5000.000000000000000000</toVal>
        <fromVal>1000.000000000000000000</fromVal>
        <timeOfUse></timeOfUse>
        <priceCompPriceItem>PI_026</priceCompPriceItem>
        <priceCriteria>NBRTRAN</priceCriteria>
        <priceCompTierId></priceCompTierId>
        <tieringSeqNum>10</tieringSeqNum>
        <parmString></parmString>
    </pricecomptier>
    <pricecomptier>
        <priceItemParmGroupId>1</priceItemParmGroupId>
        <toVal>999999999999.990000000000000000</toVal>
        <fromVal>5000.000000000000000000</fromVal>
        <timeOfUse></timeOfUse>
        <priceCompPriceItem>PI_026</priceCompPriceItem>
        <priceCriteria>NBRTRAN</priceCriteria>
        <priceCompTierId></priceCompTierId>
        <tieringSeqNum>10</tieringSeqNum>
        <parmString></parmString>
    </pricecomptier>
</priceComponent>

```

```

    <pricecomptier>
      <priceItemParmGroupId>1</priceItemParmGroupId>
      <toVal>1000.000000000000000000</toVal>
      <fromVal>0.000000000000000000</fromVal>
      <timeOfUse></timeOfUse>
      <priceCompPriceItem>PI_026</priceCompPriceItem>
      <priceCriteria>NBRTRAN</priceCriteria>
      <priceCompTierId></priceCompTierId>
      <tieringSeqNum>10</tieringSeqNum>
      <parmString></parmString>
    </pricecomptier>
    <pricecomptier>
      <priceItemParmGroupId>1</priceItemParmGroupId>
      <toVal>5000.000000000000000000</toVal>
      <fromVal>1000.000000000000000000</fromVal>
      <timeOfUse></timeOfUse>
      <priceCompPriceItem>PI_026</priceCompPriceItem>
      <priceCriteria>NBRTRAN</priceCriteria>
      <priceCompTierId></priceCompTierId>
      <tieringSeqNum>10</tieringSeqNum>
      <parmString></parmString>
    </pricecomptier>
    <pricecomptier>
      <priceItemParmGroupId>1</priceItemParmGroupId>
      <toVal>999999999999.990000000000000000</toVal>
      <fromVal>5000.000000000000000000</fromVal>
      <timeOfUse></timeOfUse>
      <priceCompPriceItem>PI_026</priceCompPriceItem>
      <priceCriteria>NBRTRAN</priceCriteria>
      <priceCompTierId></priceCompTierId>
      <tieringSeqNum>10</tieringSeqNum>
      <parmString></parmString>
    </pricecomptier>
  </priceComponent>
  <priceComponent>
    <priceCompId>5417400024</priceCompId>
    <priceCompDescr>Step 1</priceCompDescr>
    <valueAmt>5.000000000000000000</valueAmt>
    <tieredFlag></tieredFlag>
    <pricecomptier>
      <priceItemParmGroupId>1</priceItemParmGroupId>
      <toVal>1000.000000000000000000</toVal>
      <fromVal>0.000000000000000000</fromVal>
      <timeOfUse></timeOfUse>
      <priceCompPriceItem>PI_026</priceCompPriceItem>
      <priceCriteria>NBRTRAN</priceCriteria>
      <priceCompTierId></priceCompTierId>
      <tieringSeqNum>10</tieringSeqNum>
      <parmString></parmString>
    </pricecomptier>
    <pricecomptier>
      <priceItemParmGroupId>1</priceItemParmGroupId>
      <toVal>5000.000000000000000000</toVal>
      <fromVal>1000.000000000000000000</fromVal>
      <timeOfUse></timeOfUse>
      <priceCompPriceItem>PI_026</priceCompPriceItem>
      <priceCriteria>NBRTRAN</priceCriteria>
      <priceCompTierId></priceCompTierId>
      <tieringSeqNum>10</tieringSeqNum>
      <parmString></parmString>
    </pricecomptier>
    <pricecomptier>
      <priceItemParmGroupId>1</priceItemParmGroupId>
      <toVal>999999999999.990000000000000000</toVal>

```

```

    <fromVal>5000.00000000000000000000</fromVal>
    <timeOfUse></timeOfUse>
    <priceCompPriceItem>PI_026</priceCompPriceItem>
    <priceCriteria>NBRTRAN</priceCriteria>
    <priceCompTierId></priceCompTierId>
    <tieringSeqNum>10</tieringSeqNum>
    <parmString></parmString>
  </pricecomptier>
  <pricecomptier>
    <priceItemParmGroupId>1</priceItemParmGroupId>
    <toVal>1000.00000000000000000000</toVal>
    <fromVal>0.00000000000000000000</fromVal>
    <timeOfUse></timeOfUse>
    <priceCompPriceItem>PI_026</priceCompPriceItem>
    <priceCriteria>NBRTRAN</priceCriteria>
    <priceCompTierId></priceCompTierId>
    <tieringSeqNum>10</tieringSeqNum>
    <parmString></parmString>
  </pricecomptier>
  <pricecomptier>
    <priceItemParmGroupId>1</priceItemParmGroupId>
    <toVal>5000.00000000000000000000</toVal>
    <fromVal>1000.00000000000000000000</fromVal>
    <timeOfUse></timeOfUse>
    <priceCompPriceItem>PI_026</priceCompPriceItem>
    <priceCriteria>NBRTRAN</priceCriteria>
    <priceCompTierId></priceCompTierId>
    <tieringSeqNum>10</tieringSeqNum>
    <parmString></parmString>
  </pricecomptier>
  <pricecomptier>
    <priceItemParmGroupId>1</priceItemParmGroupId>
    <toVal>99999999999.99000000000000000000</toVal>
    <fromVal>5000.00000000000000000000</fromVal>
    <timeOfUse></timeOfUse>
    <priceCompPriceItem>PI_026</priceCompPriceItem>
    <priceCriteria>NBRTRAN</priceCriteria>
    <priceCompTierId></priceCompTierId>
    <tieringSeqNum>10</tieringSeqNum>
    <parmString></parmString>
  </pricecomptier>
</priceComponent>
<priceComponent>
  <priceCompId>5417400025</priceCompId>
  <priceCompDescr>Step 2</priceCompDescr>
  <valueAmt>4.00000000000000000000</valueAmt>
  <tieredFlag></tieredFlag>
  <pricecomptier>
    <priceItemParmGroupId>1</priceItemParmGroupId>
    <toVal>1000.00000000000000000000</toVal>
    <fromVal>0.00000000000000000000</fromVal>
    <timeOfUse></timeOfUse>
    <priceCompPriceItem>PI_026</priceCompPriceItem>
    <priceCriteria>NBRTRAN</priceCriteria>
    <priceCompTierId></priceCompTierId>
    <tieringSeqNum>10</tieringSeqNum>
    <parmString></parmString>
  </pricecomptier>
  <pricecomptier>
    <priceItemParmGroupId>1</priceItemParmGroupId>
    <toVal>5000.00000000000000000000</toVal>
    <fromVal>1000.00000000000000000000</fromVal>
    <timeOfUse></timeOfUse>
    <priceCompPriceItem>PI_026</priceCompPriceItem>

```

```

        <priceCriteria>NBRTRAN</priceCriteria>
        <priceCompTierId></priceCompTierId>
        <tieringSeqNum>10</tieringSeqNum>
        <parmString></parmString>
    </pricecomptier>
    <pricecomptier>
        <priceItemParmGroupId>1</priceItemParmGroupId>
        <toVal>999999999999.99000000000000000000</toVal>
        <fromVal>5000.00000000000000000000</fromVal>
        <timeOfUse></timeOfUse>
        <priceCompPriceItem>PI_026</priceCompPriceItem>
        <priceCriteria>NBRTRAN</priceCriteria>
        <priceCompTierId></priceCompTierId>
        <tieringSeqNum>10</tieringSeqNum>
        <parmString></parmString>
    </pricecomptier>
    <pricecomptier>
        <priceItemParmGroupId>1</priceItemParmGroupId>
        <toVal>1000.00000000000000000000</toVal>
        <fromVal>0.00000000000000000000</fromVal>
        <timeOfUse></timeOfUse>
        <priceCompPriceItem>PI_026</priceCompPriceItem>
        <priceCriteria>NBRTRAN</priceCriteria>
        <priceCompTierId></priceCompTierId>
        <tieringSeqNum>10</tieringSeqNum>
        <parmString></parmString>
    </pricecomptier>
    <pricecomptier>
        <priceItemParmGroupId>1</priceItemParmGroupId>
        <toVal>5000.00000000000000000000</toVal>
        <fromVal>1000.00000000000000000000</fromVal>
        <timeOfUse></timeOfUse>
        <priceCompPriceItem>PI_026</priceCompPriceItem>
        <priceCriteria>NBRTRAN</priceCriteria>
        <priceCompTierId></priceCompTierId>
        <tieringSeqNum>10</tieringSeqNum>
        <parmString></parmString>
    </pricecomptier>
    <pricecomptier>
        <priceItemParmGroupId>1</priceItemParmGroupId>
        <toVal>999999999999.99000000000000000000</toVal>
        <fromVal>5000.00000000000000000000</fromVal>
        <timeOfUse></timeOfUse>
        <priceCompPriceItem>PI_026</priceCompPriceItem>
        <priceCriteria>NBRTRAN</priceCriteria>
        <priceCompTierId></priceCompTierId>
        <tieringSeqNum>10</tieringSeqNum>
        <parmString></parmString>
    </pricecomptier>
</priceComponent>
<priceComponent>
    <priceCompId>5417400026</priceCompId>
    <priceCompDescr>Step 3</priceCompDescr>
    <valueAmt>3.00000000000000000000</valueAmt>
    <tieredFlag></tieredFlag>
    <pricecomptier>
        <priceItemParmGroupId>1</priceItemParmGroupId>
        <toVal>1000.00000000000000000000</toVal>
        <fromVal>0.00000000000000000000</fromVal>
        <timeOfUse></timeOfUse>
        <priceCompPriceItem>PI_026</priceCompPriceItem>
        <priceCriteria>NBRTRAN</priceCriteria>
        <priceCompTierId></priceCompTierId>
        <tieringSeqNum>10</tieringSeqNum>
    </pricecomptier>

```

```

    <parmString></parmString>
  </pricecomptier>
  <pricecomptier>
    <priceItemParmGroupId>1</priceItemParmGroupId>
    <toVal>5000.00000000000000000000</toVal>
    <fromVal>1000.00000000000000000000</fromVal>
    <timeOfUse></timeOfUse>
    <priceCompPriceItem>PI_026</priceCompPriceItem>
    <priceCriteria>NBRTRAN</priceCriteria>
    <priceCompTierId></priceCompTierId>
    <tieringSeqNum>10</tieringSeqNum>
    <parmString></parmString>
  </pricecomptier>
  <pricecomptier>
    <priceItemParmGroupId>1</priceItemParmGroupId>
    <toVal>99999999999.99000000000000000000</toVal>
    <fromVal>5000.00000000000000000000</fromVal>
    <timeOfUse></timeOfUse>
    <priceCompPriceItem>PI_026</priceCompPriceItem>
    <priceCriteria>NBRTRAN</priceCriteria>
    <priceCompTierId></priceCompTierId>
    <tieringSeqNum>10</tieringSeqNum>
    <parmString></parmString>
  </pricecomptier>
  <pricecomptier>
    <priceItemParmGroupId>1</priceItemParmGroupId>
    <toVal>1000.00000000000000000000</toVal>
    <fromVal>0.00000000000000000000</fromVal>
    <timeOfUse></timeOfUse>
    <priceCompPriceItem>PI_026</priceCompPriceItem>
    <priceCriteria>NBRTRAN</priceCriteria>
    <priceCompTierId></priceCompTierId>
    <tieringSeqNum>10</tieringSeqNum>
    <parmString></parmString>
  </pricecomptier>
  <pricecomptier>
    <priceItemParmGroupId>1</priceItemParmGroupId>
    <toVal>5000.00000000000000000000</toVal>
    <fromVal>1000.00000000000000000000</fromVal>
    <timeOfUse></timeOfUse>
    <priceCompPriceItem>PI_026</priceCompPriceItem>
    <priceCriteria>NBRTRAN</priceCriteria>
    <priceCompTierId></priceCompTierId>
    <tieringSeqNum>10</tieringSeqNum>
    <parmString></parmString>
  </pricecomptier>
  <pricecomptier>
    <priceItemParmGroupId>1</priceItemParmGroupId>
    <toVal>99999999999.99000000000000000000</toVal>
    <fromVal>5000.00000000000000000000</fromVal>
    <timeOfUse></timeOfUse>
    <priceCompPriceItem>PI_026</priceCompPriceItem>
    <priceCriteria>NBRTRAN</priceCriteria>
    <priceCompTierId></priceCompTierId>
    <tieringSeqNum>10</tieringSeqNum>
    <parmString></parmString>
  </pricecomptier>
</priceComponent>
</pricing>
<pricing>
  <priceListId>5417730766</priceListId>
  <priceListDescription>PriceList -1</priceListDescription>
  <priority>3</priority>
  <validityFlag></validityFlag>

```

```

<noOfDays>60</noOfDays>
<priceItemCode>PI_027</priceItemCode>
<priceitemCodeDescr>V7-Direct Debit</priceitemCodeDescr>
<priceAsgnId>5410009209</priceAsgnId>
<priceListStartDate>2022-01-11</priceListStartDate>
<priceListEndDate>2022-03-12</priceListEndDate>
<priceComponent>
  <priceCompId>5417300038</priceCompId>
  <priceCompDescr>Basic BK-NBR</priceCompDescr>
  <valueAmt>0.150000000000000000</valueAmt>
  <tieredFlag></tieredFlag>
  <pricecomptier>
    <priceItemParmGroupId></priceItemParmGroupId>
    <toVal></toVal>
    <fromVal></fromVal>
    <timeOfUse></timeOfUse>
    <priceCompPriceItem></priceCompPriceItem>
    <priceCriteria></priceCriteria>
    <priceCompTierId></priceCompTierId>
    <tieringSeqNum></tieringSeqNum>
    <parmString></parmString>
  </pricecomptier>
</priceComponent>
</pricing>
<pricing>
  <priceListId>5417730766</priceListId>
  <priceListDescription>PriceList -1</priceListDescription>
  <priority>3</priority>
  <validityFlag></validityFlag>
  <noOfDays>60</noOfDays>
  <priceItemCode>PI_028</priceItemCode>
  <priceitemCodeDescr>V8-Cheque Collections</priceitemCodeDescr>
  <priceAsgnId>5410009210</priceAsgnId>
  <priceListStartDate>2022-01-11</priceListStartDate>
  <priceListEndDate>2022-03-12</priceListEndDate>
  <priceComponent>
    <priceCompId>5417300040</priceCompId>
    <priceCompDescr>FLAT</priceCompDescr>
    <valueAmt>0.750000000000000000</valueAmt>
    <tieredFlag></tieredFlag>
    <pricecomptier>
      <priceItemParmGroupId></priceItemParmGroupId>
      <toVal></toVal>
      <fromVal></fromVal>
      <timeOfUse></timeOfUse>
      <priceCompPriceItem></priceCompPriceItem>
      <priceCriteria></priceCriteria>
      <priceCompTierId></priceCompTierId>
      <tieringSeqNum></tieringSeqNum>
      <parmString></parmString>
    </pricecomptier>
  </priceComponent>
</pricing>
<pricing>
  <priceListId>5417730766</priceListId>
  <priceListDescription>PriceList -1</priceListDescription>
  <priority>3</priority>
  <validityFlag></validityFlag>
  <noOfDays>60</noOfDays>
  <priceItemCode>PI_028</priceItemCode>
  <priceitemCodeDescr>V8-Cheque Collections</priceitemCodeDescr>
  <priceAsgnId>5410009211</priceAsgnId>
  <priceListStartDate>2022-01-11</priceListStartDate>
  <priceListEndDate>2022-03-12</priceListEndDate>

```



```

    <priceComponent>
      <priceCompId>5417300042</priceCompId>
      <priceCompDescr>FLAT</priceCompDescr>
      <valueAmt>6.670000000000000000</valueAmt>
      <tieredFlag></tieredFlag>
      <pricecomptier>
        <priceItemParmGroupId></priceItemParmGroupId>
        <toVal></toVal>
        <fromVal></fromVal>
        <timeOfUse></timeOfUse>
        <priceCompPriceItem></priceCompPriceItem>
        <priceCriteria></priceCriteria>
        <priceCompTierId></priceCompTierId>
        <tieringSeqNum></tieringSeqNum>
        <parmString></parmString>
      </pricecomptier>
    </priceComponent>
  </pricing>
</pricing>
<pricing>
  <priceListId>5417730766</priceListId>
  <priceListDescription>PriceList -1</priceListDescription>
  <priority>3</priority>
  <validityFlag></validityFlag>
  <noOfDays>60</noOfDays>
  <priceItemCode>PI_028</priceItemCode>
  <priceitemCodeDescr>V8-Cheque Collections</priceitemCodeDescr>
  <priceAsgnId>5410009212</priceAsgnId>
  <priceListStartDate>2022-01-11</priceListStartDate>
  <priceListEndDate>2022-03-12</priceListEndDate>
  <priceComponent>
    <priceCompId>5417300044</priceCompId>
    <priceCompDescr>FLAT</priceCompDescr>
    <valueAmt>0.300000000000000000</valueAmt>
    <tieredFlag></tieredFlag>
    <pricecomptier>
      <priceItemParmGroupId></priceItemParmGroupId>
      <toVal></toVal>
      <fromVal></fromVal>
      <timeOfUse></timeOfUse>
      <priceCompPriceItem></priceCompPriceItem>
      <priceCriteria></priceCriteria>
      <priceCompTierId></priceCompTierId>
      <tieringSeqNum></tieringSeqNum>
      <parmString></parmString>
    </pricecomptier>
  </priceComponent>
</pricing>
</pricing>
<pricing>
  <priceListId>5417730766</priceListId>
  <priceListDescription>PriceList -1</priceListDescription>
  <priority>3</priority>
  <validityFlag></validityFlag>
  <noOfDays>60</noOfDays>
  <priceItemCode>PI_028</priceItemCode>
  <priceitemCodeDescr>V8-Cheque Collections</priceitemCodeDescr>
  <priceAsgnId>5410009213</priceAsgnId>
  <priceListStartDate>2022-01-11</priceListStartDate>
  <priceListEndDate>2022-03-12</priceListEndDate>
  <priceComponent>
    <priceCompId>5417300046</priceCompId>
    <priceCompDescr>FLAT</priceCompDescr>
    <valueAmt>2.050000000000000000</valueAmt>
    <tieredFlag></tieredFlag>
    <pricecomptier>

```

```

        <priceItemParmGroupId></priceItemParmGroupId>
        <toVal></toVal>
        <fromVal></fromVal>
        <timeOfUse></timeOfUse>
        <priceCompPriceItem></priceCompPriceItem>
        <priceCriteria></priceCriteria>
        <priceCompTierId></priceCompTierId>
        <tieringSeqNum></tieringSeqNum>
        <parmString></parmString>
    </pricecomptier>
</priceComponent>
</pricing>
<pricing>
    <priceListId>5417730766</priceListId>
    <priceListDescription>PriceList -1</priceListDescription>
    <priority>3</priority>
    <validityFlag></validityFlag>
    <noOfDays>60</noOfDays>
    <priceItemCode>PI_029</priceItemCode>
    <priceitemCodeDescr>V9-Domestic Liquidity</priceitemCodeDescr>
    <priceAsgnId>5410009214</priceAsgnId>
    <priceListStartDate>2022-01-11</priceListStartDate>
    <priceListEndDate>2022-03-12</priceListEndDate>
    <priceComponent>
        <priceCompId>5417300048</priceCompId>
        <priceCompDescr>FLAT</priceCompDescr>
        <valueAmt>0.400000000000000000</valueAmt>
        <tieredFlag></tieredFlag>
        <pricecomptier>
            <priceItemParmGroupId></priceItemParmGroupId>
            <toVal></toVal>
            <fromVal></fromVal>
            <timeOfUse></timeOfUse>
            <priceCompPriceItem></priceCompPriceItem>
            <priceCriteria></priceCriteria>
            <priceCompTierId></priceCompTierId>
            <tieringSeqNum></tieringSeqNum>
            <parmString></parmString>
        </pricecomptier>
    </priceComponent>
</pricing>
<pricing>
    <priceListId>5417730766</priceListId>
    <priceListDescription>PriceList -1</priceListDescription>
    <priority>3</priority>
    <validityFlag></validityFlag>
    <noOfDays>60</noOfDays>
    <priceItemCode>PI_030</priceItemCode>
    <priceitemCodeDescr>V10-Third Party Bank</priceitemCodeDescr>
    <priceAsgnId>5410009215</priceAsgnId>
    <priceListStartDate>2022-01-11</priceListStartDate>
    <priceListEndDate>2022-03-12</priceListEndDate>
    <priceComponent>
        <priceCompId>5417300050</priceCompId>
        <priceCompDescr>FLAT</priceCompDescr>
        <valueAmt>0.600000000000000000</valueAmt>
        <tieredFlag></tieredFlag>
        <pricecomptier>
            <priceItemParmGroupId></priceItemParmGroupId>
            <toVal></toVal>
            <fromVal></fromVal>
            <timeOfUse></timeOfUse>
            <priceCompPriceItem></priceCompPriceItem>
            <priceCriteria></priceCriteria>

```

```

        <priceCompTierId></priceCompTierId>
        <tieringSeqNum></tieringSeqNum>
        <parmString></parmString>
    </pricecomptier>
</priceComponent>
</pricing>
<pricing>
    <priceListId>5417730766</priceListId>
    <priceListDescription>PriceList -1</priceListDescription>
    <priority>3</priority>
    <validityFlag></validityFlag>
    <noOfDays>60</noOfDays>
    <priceItemCode>PI_031</priceItemCode>
    <priceitemCodeDescr>MT943_SWIFT_01</priceitemCodeDescr>
    <priceAsgnId>5410009201</priceAsgnId>
    <priceListStartDate>2022-01-11</priceListStartDate>
    <priceListEndDate>2022-03-12</priceListEndDate>
    <priceComponent>
        <priceCompId>5417300002</priceCompId>
        <priceCompDescr>FLAT</priceCompDescr>
        <valueAmt>16.660000000000000000</valueAmt>
        <tieredFlag></tieredFlag>
        <pricecomptier>
            <priceItemParmGroupId></priceItemParmGroupId>
            <toVal></toVal>
            <fromVal></fromVal>
            <timeOfUse></timeOfUse>
            <priceCompPriceItem></priceCompPriceItem>
            <priceCriteria></priceCriteria>
            <priceCompTierId></priceCompTierId>
            <tieringSeqNum></tieringSeqNum>
            <parmString></parmString>
        </pricecomptier>
    </priceComponent>
</pricing>
<pricing>
    <priceListId>5417730766</priceListId>
    <priceListDescription>PriceList -1</priceListDescription>
    <priority>3</priority>
    <validityFlag></validityFlag>
    <noOfDays>60</noOfDays>
    <priceItemCode>PI_032</priceItemCode>
    <priceitemCodeDescr>MT943_SWIFT_02</priceitemCodeDescr>
    <priceAsgnId>5410009261</priceAsgnId>
    <priceListStartDate>2022-01-11</priceListStartDate>
    <priceListEndDate>2022-03-12</priceListEndDate>
    <priceComponent>
        <priceCompId>5417450002</priceCompId>
        <priceCompDescr>FLAT</priceCompDescr>
        <valueAmt>15.000000000000000000</valueAmt>
        <tieredFlag></tieredFlag>
        <pricecomptier>
            <priceItemParmGroupId></priceItemParmGroupId>
            <toVal></toVal>
            <fromVal></fromVal>
            <timeOfUse></timeOfUse>
            <priceCompPriceItem></priceCompPriceItem>
            <priceCriteria></priceCriteria>
            <priceCompTierId></priceCompTierId>
            <tieringSeqNum></tieringSeqNum>
            <parmString></parmString>
        </pricecomptier>
    </priceComponent>
</pricing>

```

```
</C1-GetProdDetail>
```

Related Topics

For more information on...	See...
Market Product, Offer, or Bundle View Request and Response - Tags in XML Format	Market Product, Offer, or Bundle View Request - Tags in XML Format on page 3474

Sample Bundle View Request and Response in the XML Format

Using the below example, you can view bundles which are processed on **2022-01-11**.

Sample Bundle View Request in the XML Format

```
<C1-GetProdDetail>
  <entityCode>CHECKBUND_003</entityCode>
  <entityType>BNDL</entityType>
  <processDate>2022-01-11</processDate>
  <inquiryTypeFlag>DETL</inquiryTypeFlag>
  <division></division>
</C1-GetProdDetail>
```

Sample Bundle View Response in the XML Format

```
<C1-GetProdDetail>
  <entityCode>CHECKBUND_003</entityCode>
  <entityType>BNDL</entityType>
  <processDate>2022-01-11</processDate>
  <inquiryTypeFlag>DETL</inquiryTypeFlag>
  <division></division>
  <entityName>CHECKBUND_003</entityName>
  <entityStartDate>2022-01-11</entityStartDate>
  <entityEndDate></entityEndDate>
  <termsAndCondition>TERMSPRAAS</termsAndCondition>
  <status>ACTIVE</status>
  <termsAndCondndDescr>TERMSPRAAS</termsAndCondndDescr>
  <messageCategory>0</messageCategory>
  <messageNumber>0</messageNumber>
  <messageText></messageText>
  <longDescription></longDescription>
  <productlist>
    <productCode>LOAN_001</productCode>
    <productName>LOAN_001</productName>
    <prodTypFlg>Product</prodTypFlg>
    <productCategoryFlgDesc>Loans</productCategoryFlgDesc>
  </productlist>
  <EntityDivision>
    <divisionCode>IND</divisionCode>
  </EntityDivision>
  <EntityDivision>
    <divisionCode>MH</divisionCode>
  </EntityDivision>
  <productLinkedEntity>
    <linkedEntityCode>CHECKMP_001</linkedEntityCode>
    <linkedEntityName></linkedEntityName>
    <linkedEntityType>MP</linkedEntityType>
  </productLinkedEntity>
  <productLinkedEntity>
    <linkedEntityCode>CHEKCMP_002</linkedEntityCode>
    <linkedEntityName></linkedEntityName>
    <linkedEntityType>MP</linkedEntityType>
  </productLinkedEntity>
  <eligibilityDetails>
```

```

<eligibilityDescription>LOANDBUND_001</eligibilityDescription>
<eligibilityStartDate>2022-01-11</eligibilityStartDate>
<eligibilityEndDate></eligibilityEndDate>
<eligibilityRule>
  <rhsPriceParmCd></rhsPriceParmCd>
  <rhsPriceParmVal>MH</rhsPriceParmVal>
  <lhsPriceParmCd>ACC_DIVISION</lhsPriceParmCd>
  <rhsPriceParmTypeFlg>VAL</rhsPriceParmTypeFlg>
  <>trueFlag>RLTR</trueFlag>
  <>trueFlagDescr></trueFlagDescr>
  <>falseFlag>RLFS</falseFlag>
  <>falseFlagDescr></falseFlagDescr>
  <insufficientFlag>RLFS</insufficientFlag>
  <insufficientFlagDescr></insufficientFlagDescr>
  <eligibilityRuleFlg></eligibilityRuleFlg>
  <eligibilityDescr></eligibilityDescr>
  <operator>=</operator>
  <priceParmCode></priceParmCode>
  <sequenceNumber>10</sequenceNumber>
</eligibilityRule>
</eligibilityDetails>
<services>
  <serviceCd></serviceCd>
  <serviceName>Product Service PRASS1</serviceName>
  <mandatoryFlag>true</mandatoryFlag>
</services>
<services>
  <serviceCd></serviceCd>
  <serviceName>Product Service PRASS2</serviceName>
  <mandatoryFlag>true</mandatoryFlag>
</services>
<services>
  <serviceCd></serviceCd>
  <serviceName>MH division product service</serviceName>
  <mandatoryFlag>true</mandatoryFlag>
</services>
<pricing>
  <priceListId>4368251923</priceListId>
  <priceListDescription>Currency_Con_PriceList -1</priceListDescription>
  <priority>1</priority>
  <validityFlag></validityFlag>
  <noOfDays>30</noOfDays>
  <priceItemCode>CC_021</priceItemCode>
  <priceitemCodeDescr>CC_21-Account Opening Fee</priceitemCodeDescr>
  <priceAsgnId>4360009281</priceAsgnId>
  <priceListStartDate>2022-01-11</priceListStartDate>
  <priceListEndDate>2022-02-10</priceListEndDate>
  <priceComponent>
    <priceCompId>4367475002</priceCompId>
    <priceCompDescr>FLAT</priceCompDescr>
    <valueAmt>0.400000000000000000</valueAmt>
    <tieredFlag></tieredFlag>
    <pricecomptier>
      <priceItemParmGroupId></priceItemParmGroupId>
      <toVal></toVal>
      <fromVal></fromVal>
      <timeOfUse></timeOfUse>
      <priceCompPriceItem></priceCompPriceItem>
      <priceCriteria></priceCriteria>
      <priceCompTierId></priceCompTierId>
      <tieringSeqNum></tieringSeqNum>
      <parmString></parmString>
    </pricecomptier>
  </priceComponent>
</pricing>

```

```

</pricing>
<pricing>
  <priceListId>4368251923</priceListId>
  <priceListDescription>Currency_Con_PriceList -1</priceListDescription>
  <priority>1</priority>
  <validityFlag></validityFlag>
  <noOfDays>30</noOfDays>
  <priceItemCode>CC_022</priceItemCode>
  <priceitemCodeDescr>CC2-Monthly Acct Serv Fee</priceitemCodeDescr>
  <priceAsgnId>4360009282</priceAsgnId>
  <priceListStartDate>2022-01-11</priceListStartDate>
  <priceListEndDate>2022-02-10</priceListEndDate>
  <priceComponent>
    <priceCompId>4367475004</priceCompId>
    <priceCompDescr>FLAT</priceCompDescr>
    <valueAmt>0.600000000000000000</valueAmt>
    <tieredFlag></tieredFlag>
    <pricemcomptier>
      <priceItemParmGroupId></priceItemParmGroupId>
      <toVal></toVal>
      <fromVal></fromVal>
      <timeOfUse></timeOfUse>
      <priceCompPriceItem></priceCompPriceItem>
      <priceCriteria></priceCriteria>
      <priceCompTierId></priceCompTierId>
      <tieringSeqNum></tieringSeqNum>
      <parmString></parmString>
    </pricemcomptier>
  </priceComponent>
</pricing>
<pricing>
  <priceListId>4368251923</priceListId>
  <priceListDescription>Currency_Con_PriceList -1</priceListDescription>
  <priority>1</priority>
  <validityFlag></validityFlag>
  <noOfDays>30</noOfDays>
  <priceItemCode>CC_024</priceItemCode>
  <priceitemCodeDescr>CC3-SEPA Transfers</priceitemCodeDescr>
  <priceAsgnId>4360009283</priceAsgnId>
  <priceListStartDate>2022-01-11</priceListStartDate>
  <priceListEndDate>2022-02-10</priceListEndDate>
  <priceComponent>
    <priceCompId>4367475006</priceCompId>
    <priceCompDescr>FLAT</priceCompDescr>
    <valueAmt>0.250000000000000000</valueAmt>
    <tieredFlag></tieredFlag>
    <pricemcomptier>
      <priceItemParmGroupId></priceItemParmGroupId>
      <toVal></toVal>
      <fromVal></fromVal>
      <timeOfUse></timeOfUse>
      <priceCompPriceItem></priceCompPriceItem>
      <priceCriteria></priceCriteria>
      <priceCompTierId></priceCompTierId>
      <tieringSeqNum></tieringSeqNum>
      <parmString></parmString>
    </pricemcomptier>
  </priceComponent>
</pricing>
<pricing>
  <priceListId>4368251923</priceListId>
  <priceListDescription>Currency_Con_PriceList -1</priceListDescription>
  <priority>1</priority>
  <validityFlag></validityFlag>

```

```

    <noOfDays>30</noOfDays>
    <priceItemCode>CC_025</priceItemCode>
    <priceitemCodeDescr>CC4-Domestic Funds Transfer Fee</priceitemCodeDescr>
    <priceAsgnId>4360009284</priceAsgnId>
    <priceListStartDate>2022-01-11</priceListStartDate>
    <priceListEndDate>2022-02-10</priceListEndDate>
    <priceComponent>
      <priceCompId>4367475008</priceCompId>
      <priceCompDescr>FLAT</priceCompDescr>
      <valueAmt>112.040000000000000000</valueAmt>
      <tieredFlag></tieredFlag>
      <pricecomptier>
        <priceItemParmGroupId></priceItemParmGroupId>
        <toVal></toVal>
        <fromVal></fromVal>
        <timeOfUse></timeOfUse>
        <priceCompPriceItem></priceCompPriceItem>
        <priceCriteria></priceCriteria>
        <priceCompTierId></priceCompTierId>
        <tieringSeqNum></tieringSeqNum>
        <parmString></parmString>
      </pricecomptier>
    </priceComponent>
  </pricing>
</pricing>
<pricing>
  <priceListId>5417730766</priceListId>
  <priceListDescription>PriceList -1</priceListDescription>
  <priority>2</priority>
  <validityFlag></validityFlag>
  <noOfDays>10</noOfDays>
  <priceItemCode>PI_021</priceItemCode>
  <priceitemCodeDescr>V1-Account Opening Fee</priceitemCodeDescr>
  <priceAsgnId>5410009202</priceAsgnId>
  <priceListStartDate>2022-01-11</priceListStartDate>
  <priceListEndDate>2022-01-21</priceListEndDate>
  <priceComponent>
    <priceCompId>5417300004</priceCompId>
    <priceCompDescr>FLAT</priceCompDescr>
    <valueAmt>0.25000000000000000000</valueAmt>
    <tieredFlag></tieredFlag>
    <pricecomptier>
      <priceItemParmGroupId></priceItemParmGroupId>
      <toVal></toVal>
      <fromVal></fromVal>
      <timeOfUse></timeOfUse>
      <priceCompPriceItem></priceCompPriceItem>
      <priceCriteria></priceCriteria>
      <priceCompTierId></priceCompTierId>
      <tieringSeqNum></tieringSeqNum>
      <parmString></parmString>
    </pricecomptier>
  </priceComponent>
</pricing>
</pricing>
<pricing>
  <priceListId>5417730766</priceListId>
  <priceListDescription>PriceList -1</priceListDescription>
  <priority>2</priority>
  <validityFlag></validityFlag>
  <noOfDays>10</noOfDays>
  <priceItemCode>PI_022</priceItemCode>
  <priceitemCodeDescr>V2-Monthly Acct Serv Fee</priceitemCodeDescr>
  <priceAsgnId>5410009203</priceAsgnId>
  <priceListStartDate>2022-01-11</priceListStartDate>
  <priceListEndDate>2022-01-21</priceListEndDate>

```

```

    <priceComponent>
      <priceCompId>5417300006</priceCompId>
      <priceCompDescr>FLAT</priceCompDescr>
      <valueAmt>112.040000000000000000</valueAmt>
      <tieredFlag></tieredFlag>
      <pricecomptier>
        <priceItemParmGroupId></priceItemParmGroupId>
        <toVal></toVal>
        <fromVal></fromVal>
        <timeOfUse></timeOfUse>
        <priceCompPriceItem></priceCompPriceItem>
        <priceCriteria></priceCriteria>
        <priceCompTierId></priceCompTierId>
        <tieringSeqNum></tieringSeqNum>
        <parmString></parmString>
      </pricecomptier>
    </priceComponent>
  </pricing>
</pricing>
<pricing>
  <priceListId>5417730766</priceListId>
  <priceListDescription>PriceList -1</priceListDescription>
  <priority>2</priority>
  <validityFlag></validityFlag>
  <noOfDays>10</noOfDays>
  <priceItemCode>PI_023</priceItemCode>
  <priceitemCodeDescr>V3-Audit Reports</priceitemCodeDescr>
  <priceAsgnId>5410009204</priceAsgnId>
  <priceListStartDate>2022-01-11</priceListStartDate>
  <priceListEndDate>2022-01-21</priceListEndDate>
  <priceComponent>
    <priceCompId>5417300008</priceCompId>
    <priceCompDescr>FLAT</priceCompDescr>
    <valueAmt>276.250000000000000000</valueAmt>
    <tieredFlag></tieredFlag>
    <pricecomptier>
      <priceItemParmGroupId></priceItemParmGroupId>
      <toVal></toVal>
      <fromVal></fromVal>
      <timeOfUse></timeOfUse>
      <priceCompPriceItem></priceCompPriceItem>
      <priceCriteria></priceCriteria>
      <priceCompTierId></priceCompTierId>
      <tieringSeqNum></tieringSeqNum>
      <parmString></parmString>
    </pricecomptier>
  </priceComponent>
</pricing>
</pricing>
<pricing>
  <priceListId>5417730766</priceListId>
  <priceListDescription>PriceList -1</priceListDescription>
  <priority>2</priority>
  <validityFlag></validityFlag>
  <noOfDays>10</noOfDays>
  <priceItemCode>PI_024</priceItemCode>
  <priceitemCodeDescr>V4-SEPA Transfers</priceitemCodeDescr>
  <priceAsgnId>5410009241</priceAsgnId>
  <priceListStartDate>2022-01-11</priceListStartDate>
  <priceListEndDate>2022-01-21</priceListEndDate>
  <priceComponent>
    <priceCompId>5417400004</priceCompId>
    <priceCompDescr>Price per transaction - Step Tier 1</priceCompDescr>
    <valueAmt>12.950000000000000000</valueAmt>
    <tieredFlag></tieredFlag>
    <pricecomptier>

```



```

        <priceItemParmGroupId>1</priceItemParmGroupId>
        <toVal>1000.0000000000000000</toVal>
        <fromVal>0.0000000000000000</fromVal>
        <timeOfUse></timeOfUse>
        <priceCompPriceItem>PI_024</priceCompPriceItem>
        <priceCriteria>NBRTRAN</priceCriteria>
        <priceCompTierId></priceCompTierId>
        <tieringSeqNum>10</tieringSeqNum>
        <parmString></parmString>
    </pricecomptier>
</pricecomptier>
    <priceItemParmGroupId>1</priceItemParmGroupId>
    <toVal>5000.0000000000000000</toVal>
    <fromVal>1000.0000000000000000</fromVal>
    <timeOfUse></timeOfUse>
    <priceCompPriceItem>PI_024</priceCompPriceItem>
    <priceCriteria>NBRTRAN</priceCriteria>
    <priceCompTierId></priceCompTierId>
    <tieringSeqNum>10</tieringSeqNum>
    <parmString></parmString>
</pricecomptier>
</pricecomptier>
    <priceItemParmGroupId>1</priceItemParmGroupId>
    <toVal>99999999999.9900000000000000</toVal>
    <fromVal>5000.0000000000000000</fromVal>
    <timeOfUse></timeOfUse>
    <priceCompPriceItem>PI_024</priceCompPriceItem>
    <priceCriteria>NBRTRAN</priceCriteria>
    <priceCompTierId></priceCompTierId>
    <tieringSeqNum>10</tieringSeqNum>
    <parmString></parmString>
</pricecomptier>
</priceComponent>
<priceComponent>
    <priceCompId>5417400005</priceCompId>
    <priceCompDescr>Price per transaction - Step Tier 2</priceCompDescr>
    <valueAmt>12.1500000000000000</valueAmt>
    <tieredFlag></tieredFlag>
    <pricecomptier>
        <priceItemParmGroupId>1</priceItemParmGroupId>
        <toVal>1000.0000000000000000</toVal>
        <fromVal>0.0000000000000000</fromVal>
        <timeOfUse></timeOfUse>
        <priceCompPriceItem>PI_024</priceCompPriceItem>
        <priceCriteria>NBRTRAN</priceCriteria>
        <priceCompTierId></priceCompTierId>
        <tieringSeqNum>10</tieringSeqNum>
        <parmString></parmString>
    </pricecomptier>
    <pricecomptier>
        <priceItemParmGroupId>1</priceItemParmGroupId>
        <toVal>5000.0000000000000000</toVal>
        <fromVal>1000.0000000000000000</fromVal>
        <timeOfUse></timeOfUse>
        <priceCompPriceItem>PI_024</priceCompPriceItem>
        <priceCriteria>NBRTRAN</priceCriteria>
        <priceCompTierId></priceCompTierId>
        <tieringSeqNum>10</tieringSeqNum>
        <parmString></parmString>
    </pricecomptier>
    <pricecomptier>
        <priceItemParmGroupId>1</priceItemParmGroupId>
        <toVal>99999999999.9900000000000000</toVal>
        <fromVal>5000.0000000000000000</fromVal>

```

```

        <timeOfUse></timeOfUse>
        <priceCompPriceItem>PI_024</priceCompPriceItem>
        <priceCriteria>NBRTRAN</priceCriteria>
        <priceCompTierId></priceCompTierId>
        <tieringSeqNum>10</tieringSeqNum>
        <parmString></parmString>
    </pricecomptier>
</priceComponent>
<priceComponent>
    <priceCompId>5417400006</priceCompId>
    <priceCompDescr>Price per transaction - Step Tier 3</priceCompDescr>
    <valueAmt>11.950000000000000000</valueAmt>
    <tieredFlag></tieredFlag>
    <pricecomptier>
        <priceItemParmGroupId>1</priceItemParmGroupId>
        <toVal>1000.000000000000000000</toVal>
        <fromVal>0.000000000000000000</fromVal>
        <timeOfUse></timeOfUse>
        <priceCompPriceItem>PI_024</priceCompPriceItem>
        <priceCriteria>NBRTRAN</priceCriteria>
        <priceCompTierId></priceCompTierId>
        <tieringSeqNum>10</tieringSeqNum>
        <parmString></parmString>
    </pricecomptier>
    <pricecomptier>
        <priceItemParmGroupId>1</priceItemParmGroupId>
        <toVal>5000.000000000000000000</toVal>
        <fromVal>1000.000000000000000000</fromVal>
        <timeOfUse></timeOfUse>
        <priceCompPriceItem>PI_024</priceCompPriceItem>
        <priceCriteria>NBRTRAN</priceCriteria>
        <priceCompTierId></priceCompTierId>
        <tieringSeqNum>10</tieringSeqNum>
        <parmString></parmString>
    </pricecomptier>
    <pricecomptier>
        <priceItemParmGroupId>1</priceItemParmGroupId>
        <toVal>9999999999999.990000000000000000</toVal>
        <fromVal>5000.000000000000000000</fromVal>
        <timeOfUse></timeOfUse>
        <priceCompPriceItem>PI_024</priceCompPriceItem>
        <priceCriteria>NBRTRAN</priceCriteria>
        <priceCompTierId></priceCompTierId>
        <tieringSeqNum>10</tieringSeqNum>
        <parmString></parmString>
    </pricecomptier>
</priceComponent>
</pricing>
<pricing>
    <priceListId>5417730766</priceListId>
    <priceListDescription>PriceList -1</priceListDescription>
    <priority>2</priority>
    <validityFlag></validityFlag>
    <noOfDays>10</noOfDays>
    <priceItemCode>PI_025</priceItemCode>
    <priceitemCodeDescr>V5-Domestic Funds Transfer Fee</priceitemCodeDescr>
    <priceAsgnId>5410009242</priceAsgnId>
    <priceListStartDate>2022-01-11</priceListStartDate>
    <priceListEndDate>2022-01-21</priceListEndDate>
    <priceComponent>
        <priceCompId>5417400010</priceCompId>
        <priceCompDescr>Threshold price per transaction</priceCompDescr>
        <valueAmt>12.950000000000000000</valueAmt>
        <tieredFlag></tieredFlag>

```

```

<pricecomptier>
  <priceItemParmGroupId>1</priceItemParmGroupId>
  <toVal>1000.000000000000000000</toVal>
  <fromVal>0.000000000000000000</fromVal>
  <timeOfUse></timeOfUse>
  <priceCompPriceItem>PI_025</priceCompPriceItem>
  <priceCriteria>NBRTRAN</priceCriteria>
  <priceCompTierId></priceCompTierId>
  <tieringSeqNum>10</tieringSeqNum>
  <parmString></parmString>
</pricecomptier>
<pricecomptier>
  <priceItemParmGroupId>1</priceItemParmGroupId>
  <toVal>5000.000000000000000000</toVal>
  <fromVal>1000.000000000000000000</fromVal>
  <timeOfUse></timeOfUse>
  <priceCompPriceItem>PI_025</priceCompPriceItem>
  <priceCriteria>NBRTRAN</priceCriteria>
  <priceCompTierId></priceCompTierId>
  <tieringSeqNum>10</tieringSeqNum>
  <parmString></parmString>
</pricecomptier>
<pricecomptier>
  <priceItemParmGroupId>1</priceItemParmGroupId>
  <toVal>999999999999.990000000000000000</toVal>
  <fromVal>5000.000000000000000000</fromVal>
  <timeOfUse></timeOfUse>
  <priceCompPriceItem>PI_025</priceCompPriceItem>
  <priceCriteria>NBRTRAN</priceCriteria>
  <priceCompTierId></priceCompTierId>
  <tieringSeqNum>10</tieringSeqNum>
  <parmString></parmString>
</pricecomptier>
</priceComponent>
<priceComponent>
  <priceCompId>5417400011</priceCompId>
  <priceCompDescr>Threshold price per transaction</priceCompDescr>
  <valueAmt>12.150000000000000000</valueAmt>
  <tieredFlag></tieredFlag>
  <pricecomptier>
    <priceItemParmGroupId>1</priceItemParmGroupId>
    <toVal>1000.000000000000000000</toVal>
    <fromVal>0.000000000000000000</fromVal>
    <timeOfUse></timeOfUse>
    <priceCompPriceItem>PI_025</priceCompPriceItem>
    <priceCriteria>NBRTRAN</priceCriteria>
    <priceCompTierId></priceCompTierId>
    <tieringSeqNum>10</tieringSeqNum>
    <parmString></parmString>
  </pricecomptier>
  <pricecomptier>
    <priceItemParmGroupId>1</priceItemParmGroupId>
    <toVal>5000.000000000000000000</toVal>
    <fromVal>1000.000000000000000000</fromVal>
    <timeOfUse></timeOfUse>
    <priceCompPriceItem>PI_025</priceCompPriceItem>
    <priceCriteria>NBRTRAN</priceCriteria>
    <priceCompTierId></priceCompTierId>
    <tieringSeqNum>10</tieringSeqNum>
    <parmString></parmString>
  </pricecomptier>
</priceComponent>
  <priceItemParmGroupId>1</priceItemParmGroupId>
  <toVal>999999999999.990000000000000000</toVal>

```

```

        <fromVal>5000.00000000000000000000</fromVal>
        <timeOfUse></timeOfUse>
        <priceCompPriceItem>PI_025</priceCompPriceItem>
        <priceCriteria>NBRTRAN</priceCriteria>
        <priceCompTierId></priceCompTierId>
        <tieringSeqNum>10</tieringSeqNum>
        <parmString></parmString>
    </pricecomptier>
</priceComponent>
<priceComponent>
    <priceCompId>5417400012</priceCompId>
    <priceCompDescr>Threshold price per transaction</priceCompDescr>
    <valueAmt>11.95000000000000000000</valueAmt>
    <tieredFlag></tieredFlag>
    <pricecomptier>
        <priceItemParmGroupId>1</priceItemParmGroupId>
        <toVal>1000.00000000000000000000</toVal>
        <fromVal>0.00000000000000000000</fromVal>
        <timeOfUse></timeOfUse>
        <priceCompPriceItem>PI_025</priceCompPriceItem>
        <priceCriteria>NBRTRAN</priceCriteria>
        <priceCompTierId></priceCompTierId>
        <tieringSeqNum>10</tieringSeqNum>
        <parmString></parmString>
    </pricecomptier>
    <pricecomptier>
        <priceItemParmGroupId>1</priceItemParmGroupId>
        <toVal>5000.00000000000000000000</toVal>
        <fromVal>1000.00000000000000000000</fromVal>
        <timeOfUse></timeOfUse>
        <priceCompPriceItem>PI_025</priceCompPriceItem>
        <priceCriteria>NBRTRAN</priceCriteria>
        <priceCompTierId></priceCompTierId>
        <tieringSeqNum>10</tieringSeqNum>
        <parmString></parmString>
    </pricecomptier>
    <pricecomptier>
        <priceItemParmGroupId>1</priceItemParmGroupId>
        <toVal>999999999999.99000000000000000000</toVal>
        <fromVal>5000.00000000000000000000</fromVal>
        <timeOfUse></timeOfUse>
        <priceCompPriceItem>PI_025</priceCompPriceItem>
        <priceCriteria>NBRTRAN</priceCriteria>
        <priceCompTierId></priceCompTierId>
        <tieringSeqNum>10</tieringSeqNum>
        <parmString></parmString>
    </pricecomptier>
</priceComponent>
</pricing>
<pricing>
    <priceListId>5417730766</priceListId>
    <priceListDescription>PriceList -1</priceListDescription>
    <priority>2</priority>
    <validityFlag></validityFlag>
    <noOfDays>10</noOfDays>
    <priceItemCode>PI_026</priceItemCode>
    <priceitemCodeDescr>V6-Electronic Credits</priceitemCodeDescr>
    <priceAsgnId>5410009243</priceAsgnId>
    <priceListStartDate>2022-01-11</priceListStartDate>
    <priceListEndDate>2022-01-21</priceListEndDate>
    <priceComponent>
        <priceCompId>5417400020</priceCompId>
        <priceCompDescr>Basic charges</priceCompDescr>
        <valueAmt>20.00000000000000000000</valueAmt>

```

```

<tieredFlag></tieredFlag>
<pricecomptier>
  <priceItemParmGroupId>1</priceItemParmGroupId>
  <toVal>1000.00000000000000000000</toVal>
  <fromVal>0.00000000000000000000</fromVal>
  <timeOfUse></timeOfUse>
  <priceCompPriceItem>PI_026</priceCompPriceItem>
  <priceCriteria>NBRTRAN</priceCriteria>
  <priceCompTierId></priceCompTierId>
  <tieringSeqNum>10</tieringSeqNum>
  <parmString></parmString>
</pricecomptier>
<pricecomptier>
  <priceItemParmGroupId>1</priceItemParmGroupId>
  <toVal>5000.00000000000000000000</toVal>
  <fromVal>1000.00000000000000000000</fromVal>
  <timeOfUse></timeOfUse>
  <priceCompPriceItem>PI_026</priceCompPriceItem>
  <priceCriteria>NBRTRAN</priceCriteria>
  <priceCompTierId></priceCompTierId>
  <tieringSeqNum>10</tieringSeqNum>
  <parmString></parmString>
</pricecomptier>
<pricecomptier>
  <priceItemParmGroupId>1</priceItemParmGroupId>
  <toVal>999999999999.99000000000000000000</toVal>
  <fromVal>5000.00000000000000000000</fromVal>
  <timeOfUse></timeOfUse>
  <priceCompPriceItem>PI_026</priceCompPriceItem>
  <priceCriteria>NBRTRAN</priceCriteria>
  <priceCompTierId></priceCompTierId>
  <tieringSeqNum>10</tieringSeqNum>
  <parmString></parmString>
</pricecomptier>
<pricecomptier>
  <priceItemParmGroupId>1</priceItemParmGroupId>
  <toVal>1000.00000000000000000000</toVal>
  <fromVal>0.00000000000000000000</fromVal>
  <timeOfUse></timeOfUse>
  <priceCompPriceItem>PI_026</priceCompPriceItem>
  <priceCriteria>NBRTRAN</priceCriteria>
  <priceCompTierId></priceCompTierId>
  <tieringSeqNum>10</tieringSeqNum>
  <parmString></parmString>
</pricecomptier>
<pricecomptier>
  <priceItemParmGroupId>1</priceItemParmGroupId>
  <toVal>5000.00000000000000000000</toVal>
  <fromVal>1000.00000000000000000000</fromVal>
  <timeOfUse></timeOfUse>
  <priceCompPriceItem>PI_026</priceCompPriceItem>
  <priceCriteria>NBRTRAN</priceCriteria>
  <priceCompTierId></priceCompTierId>
  <tieringSeqNum>10</tieringSeqNum>
  <parmString></parmString>
</pricecomptier>
<pricecomptier>
  <priceItemParmGroupId>1</priceItemParmGroupId>
  <toVal>999999999999.99000000000000000000</toVal>
  <fromVal>5000.00000000000000000000</fromVal>
  <timeOfUse></timeOfUse>
  <priceCompPriceItem>PI_026</priceCompPriceItem>
  <priceCriteria>NBRTRAN</priceCriteria>
  <priceCompTierId></priceCompTierId>

```

```

        <tieringSeqNum>10</tieringSeqNum>
        <parmString></parmString>
    </pricecomptier>
</priceComponent>
<priceComponent>
    <priceCompId>5417400021</priceCompId>
    <priceCompDescr>Threshold price</priceCompDescr>
    <valueAmt>10.000000000000000000</valueAmt>
    <tieredFlag></tieredFlag>
    <pricecomptier>
        <priceItemParmGroupId>1</priceItemParmGroupId>
        <toVal>1000.000000000000000000</toVal>
        <fromVal>0.000000000000000000</fromVal>
        <timeOfUse></timeOfUse>
        <priceCompPriceItem>PI_026</priceCompPriceItem>
        <priceCriteria>NBRTRAN</priceCriteria>
        <priceCompTierId></priceCompTierId>
        <tieringSeqNum>10</tieringSeqNum>
        <parmString></parmString>
    </pricecomptier>
    <pricecomptier>
        <priceItemParmGroupId>1</priceItemParmGroupId>
        <toVal>5000.000000000000000000</toVal>
        <fromVal>1000.000000000000000000</fromVal>
        <timeOfUse></timeOfUse>
        <priceCompPriceItem>PI_026</priceCompPriceItem>
        <priceCriteria>NBRTRAN</priceCriteria>
        <priceCompTierId></priceCompTierId>
        <tieringSeqNum>10</tieringSeqNum>
        <parmString></parmString>
    </pricecomptier>
    <pricecomptier>
        <priceItemParmGroupId>1</priceItemParmGroupId>
        <toVal>999999999999.990000000000000000</toVal>
        <fromVal>5000.000000000000000000</fromVal>
        <timeOfUse></timeOfUse>
        <priceCompPriceItem>PI_026</priceCompPriceItem>
        <priceCriteria>NBRTRAN</priceCriteria>
        <priceCompTierId></priceCompTierId>
        <tieringSeqNum>10</tieringSeqNum>
        <parmString></parmString>
    </pricecomptier>
    <pricecomptier>
        <priceItemParmGroupId>1</priceItemParmGroupId>
        <toVal>1000.000000000000000000</toVal>
        <fromVal>0.000000000000000000</fromVal>
        <timeOfUse></timeOfUse>
        <priceCompPriceItem>PI_026</priceCompPriceItem>
        <priceCriteria>NBRTRAN</priceCriteria>
        <priceCompTierId></priceCompTierId>
        <tieringSeqNum>10</tieringSeqNum>
        <parmString></parmString>
    </pricecomptier>
    <pricecomptier>
        <priceItemParmGroupId>1</priceItemParmGroupId>
        <toVal>5000.000000000000000000</toVal>
        <fromVal>1000.000000000000000000</fromVal>
        <timeOfUse></timeOfUse>
        <priceCompPriceItem>PI_026</priceCompPriceItem>
        <priceCriteria>NBRTRAN</priceCriteria>
        <priceCompTierId></priceCompTierId>
        <tieringSeqNum>10</tieringSeqNum>
        <parmString></parmString>
    </pricecomptier>
</priceComponent>

```

```

    <pricecomptier>
      <priceItemParmGroupId>1</priceItemParmGroupId>
      <toVal>999999999999.99000000000000000000</toVal>
      <fromVal>5000.00000000000000000000</fromVal>
      <timeOfUse></timeOfUse>
      <priceCompPriceItem>PI_026</priceCompPriceItem>
      <priceCriteria>NBRTRAN</priceCriteria>
      <priceCompTierId></priceCompTierId>
      <tieringSeqNum>10</tieringSeqNum>
      <parmString></parmString>
    </pricecomptier>
  </priceComponent>
  <priceComponent>
    <priceCompId>5417400022</priceCompId>
    <priceCompDescr>Threshold price</priceCompDescr>
    <valueAmt>8.00000000000000000000</valueAmt>
    <tieredFlag></tieredFlag>
    <pricecomptier>
      <priceItemParmGroupId>1</priceItemParmGroupId>
      <toVal>1000.00000000000000000000</toVal>
      <fromVal>0.00000000000000000000</fromVal>
      <timeOfUse></timeOfUse>
      <priceCompPriceItem>PI_026</priceCompPriceItem>
      <priceCriteria>NBRTRAN</priceCriteria>
      <priceCompTierId></priceCompTierId>
      <tieringSeqNum>10</tieringSeqNum>
      <parmString></parmString>
    </pricecomptier>
    <pricecomptier>
      <priceItemParmGroupId>1</priceItemParmGroupId>
      <toVal>5000.00000000000000000000</toVal>
      <fromVal>1000.00000000000000000000</fromVal>
      <timeOfUse></timeOfUse>
      <priceCompPriceItem>PI_026</priceCompPriceItem>
      <priceCriteria>NBRTRAN</priceCriteria>
      <priceCompTierId></priceCompTierId>
      <tieringSeqNum>10</tieringSeqNum>
      <parmString></parmString>
    </pricecomptier>
    <pricecomptier>
      <priceItemParmGroupId>1</priceItemParmGroupId>
      <toVal>999999999999.99000000000000000000</toVal>
      <fromVal>5000.00000000000000000000</fromVal>
      <timeOfUse></timeOfUse>
      <priceCompPriceItem>PI_026</priceCompPriceItem>
      <priceCriteria>NBRTRAN</priceCriteria>
      <priceCompTierId></priceCompTierId>
      <tieringSeqNum>10</tieringSeqNum>
      <parmString></parmString>
    </pricecomptier>
    <pricecomptier>
      <priceItemParmGroupId>1</priceItemParmGroupId>
      <toVal>1000.00000000000000000000</toVal>
      <fromVal>0.00000000000000000000</fromVal>
      <timeOfUse></timeOfUse>
      <priceCompPriceItem>PI_026</priceCompPriceItem>
      <priceCriteria>NBRTRAN</priceCriteria>
      <priceCompTierId></priceCompTierId>
      <tieringSeqNum>10</tieringSeqNum>
      <parmString></parmString>
    </pricecomptier>
    <pricecomptier>
      <priceItemParmGroupId>1</priceItemParmGroupId>
      <toVal>5000.00000000000000000000</toVal>

```

```

    <fromVal>1000.000000000000000000</fromVal>
    <timeOfUse></timeOfUse>
    <priceCompPriceItem>PI_026</priceCompPriceItem>
    <priceCriteria>NBRTRAN</priceCriteria>
    <priceCompTierId></priceCompTierId>
    <tieringSeqNum>10</tieringSeqNum>
    <parmString></parmString>
  </pricecomptier>
</pricecomptier>
  <priceItemParmGroupId>1</priceItemParmGroupId>
  <toVal>999999999999.990000000000000000</toVal>
  <fromVal>5000.000000000000000000</fromVal>
  <timeOfUse></timeOfUse>
  <priceCompPriceItem>PI_026</priceCompPriceItem>
  <priceCriteria>NBRTRAN</priceCriteria>
  <priceCompTierId></priceCompTierId>
  <tieringSeqNum>10</tieringSeqNum>
  <parmString></parmString>
</pricecomptier>
</priceComponent>
<priceComponent>
  <priceCompId>5417400023</priceCompId>
  <priceCompDescr>Threshold price</priceCompDescr>
  <valueAmt>6.000000000000000000</valueAmt>
  <tieredFlag></tieredFlag>
  <pricecomptier>
    <priceItemParmGroupId>1</priceItemParmGroupId>
    <toVal>1000.000000000000000000</toVal>
    <fromVal>0.000000000000000000</fromVal>
    <timeOfUse></timeOfUse>
    <priceCompPriceItem>PI_026</priceCompPriceItem>
    <priceCriteria>NBRTRAN</priceCriteria>
    <priceCompTierId></priceCompTierId>
    <tieringSeqNum>10</tieringSeqNum>
    <parmString></parmString>
  </pricecomptier>
  <pricecomptier>
    <priceItemParmGroupId>1</priceItemParmGroupId>
    <toVal>5000.000000000000000000</toVal>
    <fromVal>1000.000000000000000000</fromVal>
    <timeOfUse></timeOfUse>
    <priceCompPriceItem>PI_026</priceCompPriceItem>
    <priceCriteria>NBRTRAN</priceCriteria>
    <priceCompTierId></priceCompTierId>
    <tieringSeqNum>10</tieringSeqNum>
    <parmString></parmString>
  </pricecomptier>
  <pricecomptier>
    <priceItemParmGroupId>1</priceItemParmGroupId>
    <toVal>999999999999.990000000000000000</toVal>
    <fromVal>5000.000000000000000000</fromVal>
    <timeOfUse></timeOfUse>
    <priceCompPriceItem>PI_026</priceCompPriceItem>
    <priceCriteria>NBRTRAN</priceCriteria>
    <priceCompTierId></priceCompTierId>
    <tieringSeqNum>10</tieringSeqNum>
    <parmString></parmString>
  </pricecomptier>
</pricecomptier>
  <priceItemParmGroupId>1</priceItemParmGroupId>
  <toVal>1000.000000000000000000</toVal>
  <fromVal>0.000000000000000000</fromVal>
  <timeOfUse></timeOfUse>
  <priceCompPriceItem>PI_026</priceCompPriceItem>

```



```

        <priceCriteria>NBRTRAN</priceCriteria>
        <priceCompTierId></priceCompTierId>
        <tieringSeqNum>10</tieringSeqNum>
        <parmString></parmString>
    </pricecomptier>
</pricecomptier>
    <pricecomptier>
        <priceItemParmGroupId>1</priceItemParmGroupId>
        <toVal>5000.000000000000000000</toVal>
        <fromVal>1000.000000000000000000</fromVal>
        <timeOfUse></timeOfUse>
        <priceCompPriceItem>PI_026</priceCompPriceItem>
        <priceCriteria>NBRTRAN</priceCriteria>
        <priceCompTierId></priceCompTierId>
        <tieringSeqNum>10</tieringSeqNum>
        <parmString></parmString>
    </pricecomptier>
</pricecomptier>
    <pricecomptier>
        <priceItemParmGroupId>1</priceItemParmGroupId>
        <toVal>99999999999.990000000000000000</toVal>
        <fromVal>5000.000000000000000000</fromVal>
        <timeOfUse></timeOfUse>
        <priceCompPriceItem>PI_026</priceCompPriceItem>
        <priceCriteria>NBRTRAN</priceCriteria>
        <priceCompTierId></priceCompTierId>
        <tieringSeqNum>10</tieringSeqNum>
        <parmString></parmString>
    </pricecomptier>
</pricecomptier>
</priceComponent>
<priceComponent>
<priceCompId>5417400024</priceCompId>
<priceCompDescr>Step 1</priceCompDescr>
<valueAmt>5.000000000000000000</valueAmt>
<tieredFlag></tieredFlag>
    <pricecomptier>
        <priceItemParmGroupId>1</priceItemParmGroupId>
        <toVal>1000.000000000000000000</toVal>
        <fromVal>0.000000000000000000</fromVal>
        <timeOfUse></timeOfUse>
        <priceCompPriceItem>PI_026</priceCompPriceItem>
        <priceCriteria>NBRTRAN</priceCriteria>
        <priceCompTierId></priceCompTierId>
        <tieringSeqNum>10</tieringSeqNum>
        <parmString></parmString>
    </pricecomptier>
</pricecomptier>
    <pricecomptier>
        <priceItemParmGroupId>1</priceItemParmGroupId>
        <toVal>5000.000000000000000000</toVal>
        <fromVal>1000.000000000000000000</fromVal>
        <timeOfUse></timeOfUse>
        <priceCompPriceItem>PI_026</priceCompPriceItem>
        <priceCriteria>NBRTRAN</priceCriteria>
        <priceCompTierId></priceCompTierId>
        <tieringSeqNum>10</tieringSeqNum>
        <parmString></parmString>
    </pricecomptier>
</pricecomptier>
    <pricecomptier>
        <priceItemParmGroupId>1</priceItemParmGroupId>
        <toVal>99999999999.990000000000000000</toVal>
        <fromVal>5000.000000000000000000</fromVal>
        <timeOfUse></timeOfUse>
        <priceCompPriceItem>PI_026</priceCompPriceItem>
        <priceCriteria>NBRTRAN</priceCriteria>
        <priceCompTierId></priceCompTierId>
        <tieringSeqNum>10</tieringSeqNum>
    </pricecomptier>
</pricecomptier>

```

```

    <parmString></parmString>
  </pricecomptier>
</pricecomptier>
  <priceItemParmGroupId>1</priceItemParmGroupId>
  <toVal>1000.00000000000000000000</toVal>
  <fromVal>0.00000000000000000000</fromVal>
  <timeOfUse></timeOfUse>
  <priceCompPriceItem>PI_026</priceCompPriceItem>
  <priceCriteria>NBRTRAN</priceCriteria>
  <priceCompTierId></priceCompTierId>
  <tieringSeqNum>10</tieringSeqNum>
  <parmString></parmString>
</pricecomptier>
</pricecomptier>
  <priceItemParmGroupId>1</priceItemParmGroupId>
  <toVal>5000.00000000000000000000</toVal>
  <fromVal>1000.00000000000000000000</fromVal>
  <timeOfUse></timeOfUse>
  <priceCompPriceItem>PI_026</priceCompPriceItem>
  <priceCriteria>NBRTRAN</priceCriteria>
  <priceCompTierId></priceCompTierId>
  <tieringSeqNum>10</tieringSeqNum>
  <parmString></parmString>
</pricecomptier>
</pricecomptier>
  <priceItemParmGroupId>1</priceItemParmGroupId>
  <toVal>999999999999.99000000000000000000</toVal>
  <fromVal>5000.00000000000000000000</fromVal>
  <timeOfUse></timeOfUse>
  <priceCompPriceItem>PI_026</priceCompPriceItem>
  <priceCriteria>NBRTRAN</priceCriteria>
  <priceCompTierId></priceCompTierId>
  <tieringSeqNum>10</tieringSeqNum>
  <parmString></parmString>
</pricecomptier>
</priceComponent>
<priceComponent>
  <priceCompId>5417400025</priceCompId>
  <priceCompDescr>Step 2</priceCompDescr>
  <valueAmt>4.00000000000000000000</valueAmt>
  <tieredFlag></tieredFlag>
  <pricecomptier>
    <priceItemParmGroupId>1</priceItemParmGroupId>
    <toVal>1000.00000000000000000000</toVal>
    <fromVal>0.00000000000000000000</fromVal>
    <timeOfUse></timeOfUse>
    <priceCompPriceItem>PI_026</priceCompPriceItem>
    <priceCriteria>NBRTRAN</priceCriteria>
    <priceCompTierId></priceCompTierId>
    <tieringSeqNum>10</tieringSeqNum>
    <parmString></parmString>
  </pricecomptier>
  </pricecomptier>
    <priceItemParmGroupId>1</priceItemParmGroupId>
    <toVal>5000.00000000000000000000</toVal>
    <fromVal>1000.00000000000000000000</fromVal>
    <timeOfUse></timeOfUse>
    <priceCompPriceItem>PI_026</priceCompPriceItem>
    <priceCriteria>NBRTRAN</priceCriteria>
    <priceCompTierId></priceCompTierId>
    <tieringSeqNum>10</tieringSeqNum>
    <parmString></parmString>
  </pricecomptier>
</pricecomptier>
</pricecomptier>

```

```

    <priceItemParmGroupId>1</priceItemParmGroupId>
    <toVal>999999999999.99000000000000000000</toVal>
    <fromVal>5000.00000000000000000000</fromVal>
    <timeOfUse></timeOfUse>
    <priceCompPriceItem>PI_026</priceCompPriceItem>
    <priceCriteria>NBRTRAN</priceCriteria>
    <priceCompTierId></priceCompTierId>
    <tieringSeqNum>10</tieringSeqNum>
    <parmString></parmString>
  </pricecomptier>
</pricecomptier>
  <pricecomptier>
    <priceItemParmGroupId>1</priceItemParmGroupId>
    <toVal>1000.00000000000000000000</toVal>
    <fromVal>0.00000000000000000000</fromVal>
    <timeOfUse></timeOfUse>
    <priceCompPriceItem>PI_026</priceCompPriceItem>
    <priceCriteria>NBRTRAN</priceCriteria>
    <priceCompTierId></priceCompTierId>
    <tieringSeqNum>10</tieringSeqNum>
    <parmString></parmString>
  </pricecomptier>
</pricecomptier>
  <pricecomptier>
    <priceItemParmGroupId>1</priceItemParmGroupId>
    <toVal>5000.00000000000000000000</toVal>
    <fromVal>1000.00000000000000000000</fromVal>
    <timeOfUse></timeOfUse>
    <priceCompPriceItem>PI_026</priceCompPriceItem>
    <priceCriteria>NBRTRAN</priceCriteria>
    <priceCompTierId></priceCompTierId>
    <tieringSeqNum>10</tieringSeqNum>
    <parmString></parmString>
  </pricecomptier>
</pricecomptier>
  <pricecomptier>
    <priceItemParmGroupId>1</priceItemParmGroupId>
    <toVal>999999999999.99000000000000000000</toVal>
    <fromVal>5000.00000000000000000000</fromVal>
    <timeOfUse></timeOfUse>
    <priceCompPriceItem>PI_026</priceCompPriceItem>
    <priceCriteria>NBRTRAN</priceCriteria>
    <priceCompTierId></priceCompTierId>
    <tieringSeqNum>10</tieringSeqNum>
    <parmString></parmString>
  </pricecomptier>
</pricecomptier>
<priceComponent>
  <priceCompId>5417400026</priceCompId>
  <priceCompDescr>Step 3</priceCompDescr>
  <valueAmt>3.00000000000000000000</valueAmt>
  <tieredFlag></tieredFlag>
  <pricecomptier>
    <priceItemParmGroupId>1</priceItemParmGroupId>
    <toVal>1000.00000000000000000000</toVal>
    <fromVal>0.00000000000000000000</fromVal>
    <timeOfUse></timeOfUse>
    <priceCompPriceItem>PI_026</priceCompPriceItem>
    <priceCriteria>NBRTRAN</priceCriteria>
    <priceCompTierId></priceCompTierId>
    <tieringSeqNum>10</tieringSeqNum>
    <parmString></parmString>
  </pricecomptier>
</pricecomptier>
  <pricecomptier>
    <priceItemParmGroupId>1</priceItemParmGroupId>
    <toVal>5000.00000000000000000000</toVal>
    <fromVal>1000.00000000000000000000</fromVal>
    <timeOfUse></timeOfUse>

```

```

        <priceCompPriceItem>PI_026</priceCompPriceItem>
        <priceCriteria>NBRTRAN</priceCriteria>
        <priceCompTierId></priceCompTierId>
        <tieringSeqNum>10</tieringSeqNum>
        <parmString></parmString>
    </pricecomptier>
</pricecomptier>
    <priceItemParmGroupId>1</priceItemParmGroupId>
    <toVal>999999999999.9900000000000000000</toVal>
    <fromVal>5000.0000000000000000000</fromVal>
    <timeOfUse></timeOfUse>
    <priceCompPriceItem>PI_026</priceCompPriceItem>
    <priceCriteria>NBRTRAN</priceCriteria>
    <priceCompTierId></priceCompTierId>
    <tieringSeqNum>10</tieringSeqNum>
    <parmString></parmString>
</pricecomptier>
<pricecomptier>
    <priceItemParmGroupId>1</priceItemParmGroupId>
    <toVal>1000.0000000000000000000</toVal>
    <fromVal>0.0000000000000000000</fromVal>
    <timeOfUse></timeOfUse>
    <priceCompPriceItem>PI_026</priceCompPriceItem>
    <priceCriteria>NBRTRAN</priceCriteria>
    <priceCompTierId></priceCompTierId>
    <tieringSeqNum>10</tieringSeqNum>
    <parmString></parmString>
</pricecomptier>
<pricecomptier>
    <priceItemParmGroupId>1</priceItemParmGroupId>
    <toVal>5000.0000000000000000000</toVal>
    <fromVal>1000.0000000000000000000</fromVal>
    <timeOfUse></timeOfUse>
    <priceCompPriceItem>PI_026</priceCompPriceItem>
    <priceCriteria>NBRTRAN</priceCriteria>
    <priceCompTierId></priceCompTierId>
    <tieringSeqNum>10</tieringSeqNum>
    <parmString></parmString>
</pricecomptier>
<pricecomptier>
    <priceItemParmGroupId>1</priceItemParmGroupId>
    <toVal>999999999999.9900000000000000000</toVal>
    <fromVal>5000.0000000000000000000</fromVal>
    <timeOfUse></timeOfUse>
    <priceCompPriceItem>PI_026</priceCompPriceItem>
    <priceCriteria>NBRTRAN</priceCriteria>
    <priceCompTierId></priceCompTierId>
    <tieringSeqNum>10</tieringSeqNum>
    <parmString></parmString>
</pricecomptier>
</priceComponent>
</pricing>
<pricing>
    <priceListId>5417730766</priceListId>
    <priceListDescription>PriceList -1</priceListDescription>
    <priority>2</priority>
    <validityFlag></validityFlag>
    <noOfDays>10</noOfDays>
    <priceItemCode>PI_027</priceItemCode>
    <priceitemCodeDescr>V7-Direct Debit</priceitemCodeDescr>
    <priceAsgnId>5410009209</priceAsgnId>
    <priceListStartDate>2022-01-11</priceListStartDate>
    <priceListEndDate>2022-01-21</priceListEndDate>
</priceComponent>

```

```

    <priceCompId>5417300038</priceCompId>
    <priceCompDescr>Basic BK-NBR</priceCompDescr>
    <valueAmt>0.150000000000000000</valueAmt>
    <tieredFlag></tieredFlag>
    <pricecomptier>
      <priceItemParmGroupId></priceItemParmGroupId>
      <toVal></toVal>
      <fromVal></fromVal>
      <timeOfUse></timeOfUse>
      <priceCompPriceItem></priceCompPriceItem>
      <priceCriteria></priceCriteria>
      <priceCompTierId></priceCompTierId>
      <tieringSeqNum></tieringSeqNum>
      <parmString></parmString>
    </pricecomptier>
  </priceComponent>
</pricing>
<pricing>
  <priceListId>5417730766</priceListId>
  <priceListDescription>PriceList -1</priceListDescription>
  <priority>2</priority>
  <validityFlag></validityFlag>
  <noOfDays>10</noOfDays>
  <priceItemCode>PI_028</priceItemCode>
  <priceitemCodeDescr>V8-Cheque Collections</priceitemCodeDescr>
  <priceAsgnId>5410009210</priceAsgnId>
  <priceListStartDate>2022-01-11</priceListStartDate>
  <priceListEndDate>2022-01-21</priceListEndDate>
  <priceComponent>
    <priceCompId>5417300040</priceCompId>
    <priceCompDescr>Basic BK-NBR</priceCompDescr>
    <valueAmt>0.750000000000000000</valueAmt>
    <tieredFlag></tieredFlag>
    <pricecomptier>
      <priceItemParmGroupId></priceItemParmGroupId>
      <toVal></toVal>
      <fromVal></fromVal>
      <timeOfUse></timeOfUse>
      <priceCompPriceItem></priceCompPriceItem>
      <priceCriteria></priceCriteria>
      <priceCompTierId></priceCompTierId>
      <tieringSeqNum></tieringSeqNum>
      <parmString></parmString>
    </pricecomptier>
  </priceComponent>
</pricing>
<pricing>
  <priceListId>5417730766</priceListId>
  <priceListDescription>PriceList -1</priceListDescription>
  <priority>2</priority>
  <validityFlag></validityFlag>
  <noOfDays>10</noOfDays>
  <priceItemCode>PI_028</priceItemCode>
  <priceitemCodeDescr>V8-Cheque Collections</priceitemCodeDescr>
  <priceAsgnId>5410009211</priceAsgnId>
  <priceListStartDate>2022-01-11</priceListStartDate>
  <priceListEndDate>2022-01-21</priceListEndDate>
  <priceComponent>
    <priceCompId>5417300042</priceCompId>
    <priceCompDescr>FLAT</priceCompDescr>
    <valueAmt>6.670000000000000000</valueAmt>
    <tieredFlag></tieredFlag>
    <pricecomptier>
      <priceItemParmGroupId></priceItemParmGroupId>

```

```

        <toVal></toVal>
        <fromVal></fromVal>
        <timeOfUse></timeOfUse>
        <priceCompPriceItem></priceCompPriceItem>
        <priceCriteria></priceCriteria>
        <priceCompTierId></priceCompTierId>
        <tieringSeqNum></tieringSeqNum>
        <parmString></parmString>
    </pricecomptier>
</priceComponent>
</pricing>
<pricing>
    <priceListId>5417730766</priceListId>
    <priceListDescription>PriceList -1</priceListDescription>
    <priority>2</priority>
    <validityFlag></validityFlag>
    <noOfDays>10</noOfDays>
    <priceItemCode>PI_028</priceItemCode>
    <priceitemCodeDescr>V8-Cheque Collections</priceitemCodeDescr>
    <priceAsgnId>5410009212</priceAsgnId>
    <priceListStartDate>2022-01-11</priceListStartDate>
    <priceListEndDate>2022-01-21</priceListEndDate>
    <priceComponent>
        <priceCompId>5417300044</priceCompId>
        <priceCompDescr>FLAT</priceCompDescr>
        <valueAmt>0.300000000000000000</valueAmt>
        <tieredFlag></tieredFlag>
        <pricecomptier>
            <priceItemParmGroupId></priceItemParmGroupId>
            <toVal></toVal>
            <fromVal></fromVal>
            <timeOfUse></timeOfUse>
            <priceCompPriceItem></priceCompPriceItem>
            <priceCriteria></priceCriteria>
            <priceCompTierId></priceCompTierId>
            <tieringSeqNum></tieringSeqNum>
            <parmString></parmString>
        </pricecomptier>
    </priceComponent>
</pricing>
<pricing>
    <priceListId>5417730766</priceListId>
    <priceListDescription>PriceList -1</priceListDescription>
    <priority>2</priority>
    <validityFlag></validityFlag>
    <noOfDays>10</noOfDays>
    <priceItemCode>PI_028</priceItemCode>
    <priceitemCodeDescr>V8-Cheque Collections</priceitemCodeDescr>
    <priceAsgnId>5410009213</priceAsgnId>
    <priceListStartDate>2022-01-11</priceListStartDate>
    <priceListEndDate>2022-01-21</priceListEndDate>
    <priceComponent>
        <priceCompId>5417300046</priceCompId>
        <priceCompDescr>FLAT</priceCompDescr>
        <valueAmt>2.050000000000000000</valueAmt>
        <tieredFlag></tieredFlag>
        <pricecomptier>
            <priceItemParmGroupId></priceItemParmGroupId>
            <toVal></toVal>
            <fromVal></fromVal>
            <timeOfUse></timeOfUse>
            <priceCompPriceItem></priceCompPriceItem>
            <priceCriteria></priceCriteria>
            <priceCompTierId></priceCompTierId>

```

```

        <tieringSeqNum></tieringSeqNum>
        <parmString></parmString>
    </pricecomptier>
</priceComponent>
</pricing>
<pricing>
    <priceListId>5417730766</priceListId>
    <priceListDescription>PriceList -1</priceListDescription>
    <priority>2</priority>
    <validityFlag></validityFlag>
    <noOfDays>10</noOfDays>
    <priceItemCode>PI_029</priceItemCode>
    <priceitemCodeDescr>V9-Domestic Liquidity</priceitemCodeDescr>
    <priceAsgnId>5410009214</priceAsgnId>
    <priceListStartDate>2022-01-11</priceListStartDate>
    <priceListEndDate>2022-01-21</priceListEndDate>
    <priceComponent>
        <priceCompId>5417300048</priceCompId>
        <priceCompDescr>FLAT</priceCompDescr>
        <valueAmt>0.400000000000000000</valueAmt>
        <tieredFlag></tieredFlag>
        <pricecomptier>
            <priceItemParmGroupId></priceItemParmGroupId>
            <toVal></toVal>
            <fromVal></fromVal>
            <timeOfUse></timeOfUse>
            <priceCompPriceItem></priceCompPriceItem>
            <priceCriteria></priceCriteria>
            <priceCompTierId></priceCompTierId>
            <tieringSeqNum></tieringSeqNum>
            <parmString></parmString>
        </pricecomptier>
    </priceComponent>
</pricing>
<pricing>
    <priceListId>5417730766</priceListId>
    <priceListDescription>PriceList -1</priceListDescription>
    <priority>2</priority>
    <validityFlag></validityFlag>
    <noOfDays>10</noOfDays>
    <priceItemCode>PI_030</priceItemCode>
    <priceitemCodeDescr>V10-Third Party Bank</priceitemCodeDescr>
    <priceAsgnId>5410009215</priceAsgnId>
    <priceListStartDate>2022-01-11</priceListStartDate>
    <priceListEndDate>2022-01-21</priceListEndDate>
    <priceComponent>
        <priceCompId>5417300050</priceCompId>
        <priceCompDescr>FLAT</priceCompDescr>
        <valueAmt>0.600000000000000000</valueAmt>
        <tieredFlag></tieredFlag>
        <pricecomptier>
            <priceItemParmGroupId></priceItemParmGroupId>
            <toVal></toVal>
            <fromVal></fromVal>
            <timeOfUse></timeOfUse>
            <priceCompPriceItem></priceCompPriceItem>
            <priceCriteria></priceCriteria>
            <priceCompTierId></priceCompTierId>
            <tieringSeqNum></tieringSeqNum>
            <parmString></parmString>
        </pricecomptier>
    </priceComponent>
</pricing>
</pricing>

```

```

<priceListId>5417730766</priceListId>
<priceListDescription>PriceList -1</priceListDescription>
<priority>2</priority>
<validityFlag></validityFlag>
<noOfDays>10</noOfDays>
<priceItemCode>PI_031</priceItemCode>
<priceitemCodeDescr>MT943_SWIFT_01</priceitemCodeDescr>
<priceAsgnId>5410009201</priceAsgnId>
<priceListStartDate>2022-01-11</priceListStartDate>
<priceListEndDate>2022-01-21</priceListEndDate>
<priceComponent>
  <priceCompId>5417300002</priceCompId>
  <priceCompDescr>FLAT</priceCompDescr>
  <valueAmt>16.660000000000000000</valueAmt>
  <tieredFlag></tieredFlag>
  <pricecomptier>
    <priceItemParmGroupId></priceItemParmGroupId>
    <toVal></toVal>
    <fromVal></fromVal>
    <timeOfUse></timeOfUse>
    <priceCompPriceItem></priceCompPriceItem>
    <priceCriteria></priceCriteria>
    <priceCompTierId></priceCompTierId>
    <tieringSeqNum></tieringSeqNum>
    <parmString></parmString>
  </pricecomptier>
</priceComponent>
</pricing>
<pricing>
  <priceListId>5417730766</priceListId>
  <priceListDescription>PriceList -1</priceListDescription>
  <priority>2</priority>
  <validityFlag></validityFlag>
  <noOfDays>10</noOfDays>
  <priceItemCode>PI_032</priceItemCode>
  <priceitemCodeDescr>MT943_SWIFT_02</priceitemCodeDescr>
  <priceAsgnId>5410009261</priceAsgnId>
  <priceListStartDate>2022-01-11</priceListStartDate>
  <priceListEndDate>2022-01-21</priceListEndDate>
  <priceComponent>
    <priceCompId>5417450002</priceCompId>
    <priceCompDescr>FLAT</priceCompDescr>
    <valueAmt>15.000000000000000000</valueAmt>
    <tieredFlag></tieredFlag>
    <pricecomptier>
      <priceItemParmGroupId></priceItemParmGroupId>
      <toVal></toVal>
      <fromVal></fromVal>
      <timeOfUse></timeOfUse>
      <priceCompPriceItem></priceCompPriceItem>
      <priceCriteria></priceCriteria>
      <priceCompTierId></priceCompTierId>
      <tieringSeqNum></tieringSeqNum>
      <parmString></parmString>
    </pricecomptier>
  </priceComponent>
</pricing>
</C1-GetProdDetail>

```

Related Topics

For more information on...	See...
Market Product, Offer, or Bundle View Request and Response - Tags in XML Format	Market Product, Offer, or Bundle View Request - Tags in XML Format on page 3474

Sample Market Product View Summary Request and Response in the XML Format

Using the below example, you can view summary of market products which are processed on **2022-01-11**.

Sample Summary View Request in the XML Format

```
<C1-GetProdDetail>
  <entityCode>CHECKMP_001</entityCode>
  <entityType>MP</entityType>
  <processDate>2022-01-11</processDate>
  <inquiryTypeFlag>SMRY</inquiryTypeFlag>
  <division></division>
</C1-GetProdDetail>
```

Sample Summary View Response in the XML Format

```
<C1-GetProdDetail>
  <entityCode>CHECKMP_001</entityCode>
  <entityType>MP</entityType>
  <processDate>2022-01-11</processDate>
  <inquiryTypeFlag>SMRY</inquiryTypeFlag>
  <division></division>
  <entityName>CHECKMP_001</entityName>
  <entityStartDate>2022-01-11</entityStartDate>
  <entityEndDate></entityEndDate>
  <termsAndCondition>TERMSPRAAS</termsAndCondition>
  <status>ACTIVE</status>
  <termsAndCondndDescr>TERMSPRAAS</termsAndCondndDescr>
  <messageCategory>0</messageCategory>
  <messageNumber>0</messageNumber>
  <messageText></messageText>
  <longDescription></longDescription>
  <productlist>
    <productCode>LOAN_001</productCode>
    <productName>LOAN_001</productName>
    <prodTypFlg>Product</prodTypFlg>
    <productCategoryFlgDesc>Loans</productCategoryFlgDesc>
  </productlist>
  <EntityDivision>
    <divisionCode>IND</divisionCode>
  </EntityDivision>
  <EntityDivision>
    <divisionCode>MH</divisionCode>
  </EntityDivision>
  <productLinkedEntity>
    <linkedEntityCode></linkedEntityCode>
    <linkedEntityName></linkedEntityName>
    <linkedEntityType></linkedEntityType>
  </productLinkedEntity>
  <eligibilityDetails>
    <eligibilityDescription>ELG_001</eligibilityDescription>
    <eligibilityStartDate>2022-01-11</eligibilityStartDate>
    <eligibilityEndDate></eligibilityEndDate>
    <eligibilityRule>
      <rhsPriceParmCd></rhsPriceParmCd>
      <rhsPriceParmVal>IND</rhsPriceParmVal>
      <lhsPriceParmCd>ACC_DIVISION</lhsPriceParmCd>
      <rhsPriceParmTypeFlg>VAL</rhsPriceParmTypeFlg>
      <trueFlag>RLTR</trueFlag>
    </eligibilityRule>
  </eligibilityDetails>
</C1-GetProdDetail>
```

```

        <trueFlagDescr></trueFlagDescr>
        <>falseFlag>RLFS</falseFlag>
        <>falseFlagDescr></falseFlagDescr>
        <insufficientFlag>RLFS</insufficientFlag>
        <insufficientFlagDescr></insufficientFlagDescr>
        <eligibilityRuleFlg></eligibilityRuleFlg>
        <eligibilityDescr></eligibilityDescr>
        <operator>=</operator>
        <priceParmCode></priceParmCode>
        <sequenceNumber>10</sequenceNumber>
    </eligibilityRule>
</eligibilityDetails>
<eligibilityDetails>
    <eligibilityDescription></eligibilityDescription>
    <eligibilityStartDate></eligibilityStartDate>
    <eligibilityEndDate></eligibilityEndDate>
    <eligibilityRule>
        <rhsPriceParmCd></rhsPriceParmCd>
        <rhsPriceParmVal>CA</rhsPriceParmVal>
        <lhsPriceParmCd>PERSON_STATE</lhsPriceParmCd>
        <rhsPriceParmTypeFlg>VAL</rhsPriceParmTypeFlg>
        <trueFlag>RLTR</trueFlag>
        <trueFlagDescr></trueFlagDescr>
        <falseFlag>RLTR</falseFlag>
        <falseFlagDescr></falseFlagDescr>
        <insufficientFlag>RLFS</insufficientFlag>
        <insufficientFlagDescr></insufficientFlagDescr>
        <eligibilityRuleFlg></eligibilityRuleFlg>
        <eligibilityDescr></eligibilityDescr>
        <operator><=</operator>
        <priceParmCode></priceParmCode>
        <sequenceNumber>20</sequenceNumber>
    </eligibilityRule>
</eligibilityDetails>
<eligibilityDetails>
    <eligibilityDescription></eligibilityDescription>
    <eligibilityStartDate></eligibilityStartDate>
    <eligibilityEndDate></eligibilityEndDate>
    <eligibilityRule>
        <rhsPriceParmCd></rhsPriceParmCd>
        <rhsPriceParmVal>USD</rhsPriceParmVal>
        <lhsPriceParmCd>ACCOUNT_CURRENCY</lhsPriceParmCd>
        <rhsPriceParmTypeFlg>VAL</rhsPriceParmTypeFlg>
        <trueFlag>RLTR</trueFlag>
        <trueFlagDescr></trueFlagDescr>
        <falseFlag>RLTR</falseFlag>
        <falseFlagDescr></falseFlagDescr>
        <insufficientFlag>RLFS</insufficientFlag>
        <insufficientFlagDescr></insufficientFlagDescr>
        <eligibilityRuleFlg></eligibilityRuleFlg>
        <eligibilityDescr></eligibilityDescr>
        <operator><></operator>
        <priceParmCode></priceParmCode>
        <sequenceNumber>30</sequenceNumber>
    </eligibilityRule>
</eligibilityDetails>
<services>
    <serviceCd></serviceCd>
    <serviceName>Product Service PRASS1</serviceName>
    <mandatoryFlag>true</mandatoryFlag>
</services>
<services>
    <serviceCd></serviceCd>
    <serviceName>Product Service PRASS2</serviceName>

```

```

    <mandatoryFlag>true</mandatoryFlag>
  </services>
</services>
  <serviceCd></serviceCd>
  <serviceName>MH division product service</serviceName>
  <mandatoryFlag>true</mandatoryFlag>
</services>
</C1-GetProdDetail>

```

Related Topics

For more information on...	See...
Market Product, Offer, or Bundle View Request and Response - Tags in XML Format	Market Product, Offer, or Bundle View Request - Tags in XML Format on page 3474

Sample Market Product View Detail Request and Response in the XML Format

Using the below example, you can view details of market products which are processed on **2022-01-11**.

Sample Detail View Request in the XML Format

```

<C1-GetProdDetail>
  <entityCode>CHECKMP_001</entityCode>
  <entityType>MP</entityType>
  <processDate>2022-01-11</processDate>
  <inquiryTypeFlag>DETL</inquiryTypeFlag>
  <division></division>
</C1-GetProdDetail>

```

Sample Detail View Response in the XML Format

```

<C1-GetProdDetail>
  <entityCode>CHECKMP_001</entityCode>
  <entityType>MP</entityType>
  <processDate>2022-01-11</processDate>
  <inquiryTypeFlag>DETL</inquiryTypeFlag>
  <division></division>
  <entityName>CHECKMP_001</entityName>
  <entityStartDate>2022-01-11</entityStartDate>
  <entityEndDate></entityEndDate>
  <termsAndCondition>TERMSPRAAS</termsAndCondition>
  <status>ACTIVE</status>
  <termsAndCondndescrip>TERMSPRAAS</termsAndCondndescrip>
  <messageCategory>0</messageCategory>
  <messageNumber>0</messageNumber>
  <messageText></messageText>
  <longDescription></longDescription>
  <productlist>
    <productCode>LOAN_001</productCode>
    <productName>LOAN_001</productName>
    <prodTypFlg>Product</prodTypFlg>
    <productCategoryFlgDesc>Loans</productCategoryFlgDesc>
  </productlist>
  <EntityDivision>
    <divisionCode>IND</divisionCode>
  </EntityDivision>
  <EntityDivision>
    <divisionCode>MH</divisionCode>
  </EntityDivision>
  <productLinkedEntity>
    <linkedEntityCode></linkedEntityCode>
    <linkedEntityName></linkedEntityName>
    <linkedEntityType></linkedEntityType>

```

```

</productLinkedEntity
<eligibilityDetails>
  <eligibilityDescription>ELG_001</eligibilityDescription>
  <eligibilityStartDate>2022-01-11</eligibilityStartDate>
  <eligibilityEndDate></eligibilityEndDate>
  <eligibilityRule>
    <rhsPriceParmCd></rhsPriceParmCd>
    <rhsPriceParmVal>IND</rhsPriceParmVal>
    <lhsPriceParmCd>ACC_DIVISION</lhsPriceParmCd>
    <rhsPriceParmTypeFlg>VAL</rhsPriceParmTypeFlg>
    <trueFlag>RLTR</trueFlag>
    <trueFlagDescr></trueFlagDescr>
    <falseFlag>RLFS</falseFlag>
    <falseFlagDescr></falseFlagDescr>
    <insufficientFlag>RLFS</insufficientFlag>
    <insufficientFlagDescr></insufficientFlagDescr>
    <eligibilityRuleFlg></eligibilityRuleFlg>
    <eligibilityDescr></eligibilityDescr>
    <operator>=</operator>
    <priceParmCode></priceParmCode>
    <sequenceNumber>10</sequenceNumber>
  </eligibilityRule>
</eligibilityDetails>
<eligibilityDetails>
  <eligibilityDescription></eligibilityDescription>
  <eligibilityStartDate></eligibilityStartDate>
  <eligibilityEndDate></eligibilityEndDate>
  <eligibilityRule>
    <rhsPriceParmCd></rhsPriceParmCd>
    <rhsPriceParmVal>CA</rhsPriceParmVal>
    <lhsPriceParmCd>PERSON_STATE</lhsPriceParmCd>
    <rhsPriceParmTypeFlg>VAL</rhsPriceParmTypeFlg>
    <trueFlag>RLTR</trueFlag>
    <trueFlagDescr></trueFlagDescr>
    <falseFlag>RLTR</falseFlag>
    <falseFlagDescr></falseFlagDescr>
    <insufficientFlag>RLFS</insufficientFlag>
    <insufficientFlagDescr></insufficientFlagDescr>
    <eligibilityRuleFlg></eligibilityRuleFlg>
    <eligibilityDescr></eligibilityDescr>
    <operator>=</operator>
    <priceParmCode></priceParmCode>
    <sequenceNumber>20</sequenceNumber>
  </eligibilityRule>
</eligibilityDetails>
<eligibilityDetails>
  <eligibilityDescription></eligibilityDescription>
  <eligibilityStartDate></eligibilityStartDate>
  <eligibilityEndDate></eligibilityEndDate>
  <eligibilityRule>
    <rhsPriceParmCd></rhsPriceParmCd>
    <rhsPriceParmVal>USD</rhsPriceParmVal>
    <lhsPriceParmCd>ACCOUNT_CURRENCY</lhsPriceParmCd>
    <rhsPriceParmTypeFlg>VAL</rhsPriceParmTypeFlg>
    <trueFlag>RLTR</trueFlag>
    <trueFlagDescr></trueFlagDescr>
    <falseFlag>RLTR</falseFlag>
    <falseFlagDescr></falseFlagDescr>
    <insufficientFlag>RLFS</insufficientFlag>
    <insufficientFlagDescr></insufficientFlagDescr>
    <eligibilityRuleFlg></eligibilityRuleFlg>
    <eligibilityDescr></eligibilityDescr>
    <operator><></operator>
    <priceParmCode></priceParmCode>

```

```

        <sequenceNumber>30</sequenceNumber>
    </eligibilityRule>
</eligibilityDetails>
<services>
    <serviceCd></serviceCd>
    <serviceName>Product Service PRASS1</serviceName>
    <mandatoryFlag>true</mandatoryFlag>
</services>
<services>
    <serviceCd></serviceCd>
    <serviceName>Product Service PRASS2</serviceName>
    <mandatoryFlag>true</mandatoryFlag>
</services>
<services>
    <serviceCd></serviceCd>
    <serviceName>MH division product service</serviceName>
    <mandatoryFlag>true</mandatoryFlag>
</services>
<pricing>
    <priceListId>4368251923</priceListId>
    <priceListDescription>Currency_Con_PriceList -1</priceListDescription>
    <priority>2</priority>
    <validityFlag></validityFlag>
    <noOfDays>30</noOfDays>
    <priceItemCode>CC_021</priceItemCode>
    <priceitemCodeDescr>CC_21-Account Opening Fee</priceitemCodeDescr>
    <priceAsgnId>4360009281</priceAsgnId>
    <priceListStartDate>2022-01-11</priceListStartDate>
    <priceListEndDate>2022-02-10</priceListEndDate>
    <priceComponent>
        <priceCompId>4367475002</priceCompId>
        <priceCompDescr>FLAT</priceCompDescr>
        <valueAmt>0.400000000000000000</valueAmt>
        <tieredFlag></tieredFlag>
        <pricemcomptier>
            <priceItemParmGroupId></priceItemParmGroupId>
            <toVal></toVal>
            <fromVal></fromVal>
            <timeOfUse></timeOfUse>
            <priceCompPriceItem></priceCompPriceItem>
            <priceCriteria></priceCriteria>
            <priceCompTierId></priceCompTierId>
            <tieringSeqNum></tieringSeqNum>
            <parmString></parmString>
        </pricemcomptier>
    </priceComponent>
</pricing>
<pricing>
    <priceListId>4368251923</priceListId>
    <priceListDescription>Currency_Con_PriceList -1</priceListDescription>
    <priority>2</priority>
    <validityFlag></validityFlag>
    <noOfDays>30</noOfDays>
    <priceItemCode>CC_022</priceItemCode>
    <priceitemCodeDescr>CC2-Monthly Acct Serv Fee</priceitemCodeDescr>
    <priceAsgnId>4360009282</priceAsgnId>
    <priceListStartDate>2022-01-11</priceListStartDate>
    <priceListEndDate>2022-02-10</priceListEndDate>
    <priceComponent>
        <priceCompId>4367475004</priceCompId>
        <priceCompDescr>FLAT</priceCompDescr>
        <valueAmt>0.600000000000000000</valueAmt>
        <tieredFlag></tieredFlag>
        <pricemcomptier>

```

```

        <priceItemParmGroupId></priceItemParmGroupId>
        <toVal></toVal>
        <fromVal></fromVal>
        <timeOfUse></timeOfUse>
        <priceCompPriceItem></priceCompPriceItem>
        <priceCriteria></priceCriteria>
        <priceCompTierId></priceCompTierId>
        <tieringSeqNum></tieringSeqNum>
        <parmString></parmString>
    </pricecomptier>
</priceComponent>
</pricing>
<pricing>
    <priceListId>4368251923</priceListId>
    <priceListDescription>Currency_Con_PriceList -1</priceListDescription>
    <priority>2</priority>
    <validityFlag></validityFlag>
    <noOfDays>30</noOfDays>
    <priceItemCode>CC_024</priceItemCode>
    <priceitemCodeDescr>CC3-SEPA Transfers</priceitemCodeDescr>
    <priceAsgnId>4360009283</priceAsgnId>
    <priceListStartDate>2022-01-11</priceListStartDate>
    <priceListEndDate>2022-02-10</priceListEndDate>
    <priceComponent>
        <priceCompId>4367475006</priceCompId>
        <priceCompDescr>FLAT</priceCompDescr>
        <valueAmt>0.250000000000000000</valueAmt>
        <tieredFlag></tieredFlag>
        <pricecomptier>
            <priceItemParmGroupId></priceItemParmGroupId>
            <toVal></toVal>
            <fromVal></fromVal>
            <timeOfUse></timeOfUse>
            <priceCompPriceItem></priceCompPriceItem>
            <priceCriteria></priceCriteria>
            <priceCompTierId></priceCompTierId>
            <tieringSeqNum></tieringSeqNum>
            <parmString></parmString>
        </pricecomptier>
    </priceComponent>
</pricing>
<pricing>
    <priceListId>4368251923</priceListId>
    <priceListDescription>Currency_Con_PriceList -1</priceListDescription>
    <priority>2</priority>
    <validityFlag></validityFlag>
    <noOfDays>30</noOfDays>
    <priceItemCode>CC_025</priceItemCode>
    <priceitemCodeDescr>CC4-Domestic Funds Transfer Fee</priceitemCodeDescr>
    <priceAsgnId>4360009284</priceAsgnId>
    <priceListStartDate>2022-01-11</priceListStartDate>
    <priceListEndDate>2022-02-10</priceListEndDate>
    <priceComponent>
        <priceCompId>4367475008</priceCompId>
        <priceCompDescr>FLAT</priceCompDescr>
        <valueAmt>112.040000000000000000</valueAmt>
        <tieredFlag></tieredFlag>
        <pricecomptier>
            <priceItemParmGroupId></priceItemParmGroupId>
            <toVal></toVal>
            <fromVal></fromVal>
            <timeOfUse></timeOfUse>
            <priceCompPriceItem></priceCompPriceItem>
            <priceCriteria></priceCriteria>

```

```

        <priceCompTierId></priceCompTierId>
        <tieringSeqNum></tieringSeqNum>
        <parmString></parmString>
    </pricecomptier>
</priceComponent>
</pricing>
<pricing>
    <priceListId>5417730766</priceListId>
    <priceListDescription>PriceList -1</priceListDescription>
    <priority>1</priority>
    <validityFlag></validityFlag>
    <noOfDays></noOfDays>
    <priceItemCode>PI_021</priceItemCode>
    <priceitemCodeDescr>V1-Account Opening Fee</priceitemCodeDescr>
    <priceAsgnId>5410009202</priceAsgnId>
    <priceListStartDate>2022-01-11</priceListStartDate>
    <priceListEndDate>2022-02-28</priceListEndDate>
    <priceComponent>
        <priceCompId>5417300004</priceCompId>
        <priceCompDescr>FLAT</priceCompDescr>
        <valueAmt>0.250000000000000000</valueAmt>
        <tieredFlag></tieredFlag>
        <pricecomptier>
            <priceItemParmGroupId></priceItemParmGroupId>
            <toVal></toVal>
            <fromVal></fromVal>
            <timeOfUse></timeOfUse>
            <priceCompPriceItem></priceCompPriceItem>
            <priceCriteria></priceCriteria>
            <priceCompTierId></priceCompTierId>
            <tieringSeqNum></tieringSeqNum>
            <parmString></parmString>
        </pricecomptier>
    </priceComponent>
</pricing>
<pricing>
    <priceListId>5417730766</priceListId>
    <priceListDescription>PriceList -1</priceListDescription>
    <priority>1</priority>
    <validityFlag></validityFlag>
    <noOfDays></noOfDays>
    <priceItemCode>PI_022</priceItemCode>
    <priceitemCodeDescr>V2-Monthly Acct Serv Fee</priceitemCodeDescr>
    <priceAsgnId>5410009203</priceAsgnId>
    <priceListStartDate>2022-01-11</priceListStartDate>
    <priceListEndDate>2022-02-28</priceListEndDate>
    <priceComponent>
        <priceCompId>5417300006</priceCompId>
        <priceCompDescr>FLAT</priceCompDescr>
        <valueAmt>112.040000000000000000</valueAmt>
        <tieredFlag></tieredFlag>
        <pricecomptier>
            <priceItemParmGroupId></priceItemParmGroupId>
            <toVal></toVal>
            <fromVal></fromVal>
            <timeOfUse></timeOfUse>
            <priceCompPriceItem></priceCompPriceItem>
            <priceCriteria></priceCriteria>
            <priceCompTierId></priceCompTierId>
            <tieringSeqNum></tieringSeqNum>
            <parmString></parmString>
        </pricecomptier>
    </priceComponent>
</pricing>

```

```

<pricing>
  <priceListId>5417730766</priceListId>
  <priceListDescription>PriceList -1</priceListDescription>
  <priority>1</priority>
  <validityFlag></validityFlag>
  <noOfDays></noOfDays>
  <priceItemCode>PI_023</priceItemCode>
  <priceitemCodeDescr>V3-Audit Reports</priceitemCodeDescr>
  <priceAsgnId>5410009204</priceAsgnId>
  <priceListStartDate>2022-01-11</priceListStartDate>
  <priceListEndDate>2022-02-28</priceListEndDate>
  <priceComponent>
    <priceCompId>5417300008</priceCompId>
    <priceCompDescr>FLAT</priceCompDescr>
    <valueAmt>276.250000000000000000</valueAmt>
    <tieredFlag></tieredFlag>
    <pricecomptier>
      <priceItemParmGroupId></priceItemParmGroupId>
      <toVal></toVal>
      <fromVal></fromVal>
      <timeOfUse></timeOfUse>
      <priceCompPriceItem></priceCompPriceItem>
      <priceCriteria></priceCriteria>
      <priceCompTierId></priceCompTierId>
      <tieringSeqNum></tieringSeqNum>
      <parmString></parmString>
    </pricecomptier>
  </priceComponent>
</pricing>
<pricing>
  <priceListId>5417730766</priceListId>
  <priceListDescription>PriceList -1</priceListDescription>
  <priority>1</priority>
  <validityFlag></validityFlag>
  <noOfDays></noOfDays>
  <priceItemCode>PI_024</priceItemCode>
  <priceitemCodeDescr>V4-SEPA Transfers</priceitemCodeDescr>
  <priceAsgnId>5410009241</priceAsgnId>
  <priceListStartDate>2022-01-11</priceListStartDate>
  <priceListEndDate>2022-02-28</priceListEndDate>
  <priceComponent>
    <priceCompId>5417400004</priceCompId>
    <priceCompDescr>Price per transaction - Step Tier 1</priceCompDescr>
    <valueAmt>12.950000000000000000</valueAmt>
    <tieredFlag></tieredFlag>
    <pricecomptier>
      <priceItemParmGroupId>1</priceItemParmGroupId>
      <toVal>1000.000000000000000000</toVal>
      <fromVal>0.000000000000000000</fromVal>
      <timeOfUse></timeOfUse>
      <priceCompPriceItem>PI_024</priceCompPriceItem>
      <priceCriteria>NBRTRAN</priceCriteria>
      <priceCompTierId></priceCompTierId>
      <tieringSeqNum>10</tieringSeqNum>
      <parmString></parmString>
    </pricecomptier>
    <pricecomptier>
      <priceItemParmGroupId>0</priceItemParmGroupId>
      <toVal>5000.000000000000000000</toVal>
      <fromVal>1000.000000000000000000</fromVal>
      <timeOfUse></timeOfUse>
      <priceCompPriceItem>PI_024</priceCompPriceItem>
      <priceCriteria>NBRTRAN</priceCriteria>
      <priceCompTierId></priceCompTierId>

```



```

        <tieringSeqNum>10</tieringSeqNum>
        <parmString></parmString>
    </pricecomptier>
</pricecomptier>
<priceComponent>
    <priceCompId>5417400005</priceCompId>
    <priceCompDescr>Price per transaction - Step Tier 2</priceCompDescr>
    <valueAmt>12.150000000000000000</valueAmt>
    <tieredFlag></tieredFlag>
    <pricecomptier>
        <priceItemParmGroupId>1</priceItemParmGroupId>
        <toVal>1000.000000000000000000</toVal>
        <fromVal>0.000000000000000000</fromVal>
        <timeOfUse></timeOfUse>
        <priceCompPriceItem>PI_024</priceCompPriceItem>
        <priceCriteria>NBRTRAN</priceCriteria>
        <priceCompTierId></priceCompTierId>
        <tieringSeqNum>10</tieringSeqNum>
        <parmString></parmString>
    </pricecomptier>
    <pricecomptier>
        <priceItemParmGroupId>0</priceItemParmGroupId>
        <toVal>5000.000000000000000000</toVal>
        <fromVal>1000.000000000000000000</fromVal>
        <timeOfUse></timeOfUse>
        <priceCompPriceItem>PI_024</priceCompPriceItem>
        <priceCriteria>NBRTRAN</priceCriteria>
        <priceCompTierId></priceCompTierId>
        <tieringSeqNum>10</tieringSeqNum>
        <parmString></parmString>
    </pricecomptier>
    <pricecomptier>
        <priceItemParmGroupId>1</priceItemParmGroupId>
        <toVal>999999999999.990000000000000000</toVal>
        <fromVal>5000.000000000000000000</fromVal>
        <timeOfUse></timeOfUse>
        <priceCompPriceItem>PI_024</priceCompPriceItem>
        <priceCriteria>NBRTRAN</priceCriteria>
        <priceCompTierId></priceCompTierId>
        <tieringSeqNum>10</tieringSeqNum>
        <parmString></parmString>
    </pricecomptier>
</priceComponent>
<priceComponent>
    <priceCompId>5417400006</priceCompId>
    <priceCompDescr>Price per transaction - Step Tier 3</priceCompDescr>
    <valueAmt>11.950000000000000000</valueAmt>
    <tieredFlag></tieredFlag>
    <pricecomptier>
        <priceItemParmGroupId>1</priceItemParmGroupId>
        <toVal>1000.000000000000000000</toVal>
        <fromVal>0.000000000000000000</fromVal>
        <timeOfUse></timeOfUse>

```

```

        <priceCompPriceItem>PI_024</priceCompPriceItem>
        <priceCriteria>NBRTRAN</priceCriteria>
        <priceCompTierId></priceCompTierId>
        <tieringSeqNum>10</tieringSeqNum>
        <parmString></parmString>
    </pricecomptier>
</pricecomptier>
    <priceItemParmGroupId>0</priceItemParmGroupId>
    <toVal>5000.000000000000000000</toVal>
    <fromVal>1000.000000000000000000</fromVal>
    <timeOfUse></timeOfUse>
    <priceCompPriceItem>PI_024</priceCompPriceItem>
    <priceCriteria>NBRTRAN</priceCriteria>
    <priceCompTierId></priceCompTierId>
    <tieringSeqNum>10</tieringSeqNum>
    <parmString></parmString>
</pricecomptier>
</pricecomptier>
    <priceItemParmGroupId>1</priceItemParmGroupId>
    <toVal>999999999999.990000000000000000</toVal>
    <fromVal>5000.000000000000000000</fromVal>
    <timeOfUse></timeOfUse>
    <priceCompPriceItem>PI_024</priceCompPriceItem>
    <priceCriteria>NBRTRAN</priceCriteria>
    <priceCompTierId></priceCompTierId>
    <tieringSeqNum>10</tieringSeqNum>
    <parmString></parmString>
</pricecomptier>
</priceComponent>
</pricing>
<pricing>
    <priceListId>5417730766</priceListId>
    <priceListDescription>PriceList -1</priceListDescription>
    <priority>1</priority>
    <validityFlag></validityFlag>
    <noOfDays></noOfDays>
    <priceItemCode>PI_025</priceItemCode>
    <priceItemCodeDescr>V5-Domestic Funds Transfer Fee</priceItemCodeDescr>
    <priceAsgnId>5410009242</priceAsgnId>
    <priceListStartDate>2022-01-11</priceListStartDate>
    <priceListEndDate>2022-02-28</priceListEndDate>
    <priceComponent>
        <priceCompId>5417400010</priceCompId>
        <priceCompDescr>Threshold price per transaction</priceCompDescr>
        <valueAmt>12.950000000000000000</valueAmt>
        <tieredFlag></tieredFlag>
        <pricecomptier>
            <priceItemParmGroupId>1</priceItemParmGroupId>
            <toVal>1000.000000000000000000</toVal>
            <fromVal>0.000000000000000000</fromVal>
            <timeOfUse></timeOfUse>
            <priceCompPriceItem>PI_025</priceCompPriceItem>
            <priceCriteria>NBRTRAN</priceCriteria>
            <priceCompTierId></priceCompTierId>
            <tieringSeqNum>10</tieringSeqNum>
            <parmString></parmString>
        </pricecomptier>
        <pricecomptier>
            <priceItemParmGroupId>0</priceItemParmGroupId>
            <toVal>5000.000000000000000000</toVal>
            <fromVal>1000.000000000000000000</fromVal>
            <timeOfUse></timeOfUse>
            <priceCompPriceItem>PI_025</priceCompPriceItem>
            <priceCriteria>NBRTRAN</priceCriteria>

```

```

        <priceCompTierId></priceCompTierId>
        <tieringSeqNum>10</tieringSeqNum>
        <parmString></parmString>
    </pricecomptier>
    <pricecomptier>
        <priceItemParmGroupId>1</priceItemParmGroupId>
        <toVal>999999999999.99000000000000000000</toVal>
        <fromVal>5000.00000000000000000000</fromVal>
        <timeOfUse></timeOfUse>
        <priceCompPriceItem>PI_025</priceCompPriceItem>
        <priceCriteria>NBRTRAN</priceCriteria>
        <priceCompTierId></priceCompTierId>
        <tieringSeqNum>10</tieringSeqNum>
        <parmString></parmString>
    </pricecomptier>
</priceComponent>
<priceComponent>
    <priceCompId>5417400010</priceCompId>
    <priceCompDescr>Threshold price per transaction</priceCompDescr>
    <valueAmt>12.95000000000000000000</valueAmt>
    <tieredFlag></tieredFlag>
    <pricecomptier>
        <priceItemParmGroupId>1</priceItemParmGroupId>
        <toVal>1000.00000000000000000000</toVal>
        <fromVal>0.00000000000000000000</fromVal>
        <timeOfUse></timeOfUse>
        <priceCompPriceItem>PI_025</priceCompPriceItem>
        <priceCriteria>NBRTRAN</priceCriteria>
        <priceCompTierId></priceCompTierId>
        <tieringSeqNum>10</tieringSeqNum>
        <parmString></parmString>
    </pricecomptier>
    <pricecomptier>
        <priceItemParmGroupId>0</priceItemParmGroupId>
        <toVal>5000.00000000000000000000</toVal>
        <fromVal>1000.00000000000000000000</fromVal>
        <timeOfUse></timeOfUse>
        <priceCompPriceItem>PI_025</priceCompPriceItem>
        <priceCriteria>NBRTRAN</priceCriteria>
        <priceCompTierId></priceCompTierId>
        <tieringSeqNum>10</tieringSeqNum>
        <parmString></parmString>
    </pricecomptier>
    <pricecomptier>
        <priceItemParmGroupId>1</priceItemParmGroupId>
        <toVal>999999999999.99000000000000000000</toVal>
        <fromVal>5000.00000000000000000000</fromVal>
        <timeOfUse></timeOfUse>
        <priceCompPriceItem>PI_025</priceCompPriceItem>
        <priceCriteria>NBRTRAN</priceCriteria>
        <priceCompTierId></priceCompTierId>
        <tieringSeqNum>10</tieringSeqNum>
        <parmString></parmString>
    </pricecomptier>
</priceComponent>
<priceComponent>
    <priceCompId>5417400011</priceCompId>
    <priceCompDescr>Threshold price per transaction</priceCompDescr>
    <valueAmt>12.15000000000000000000</valueAmt>
    <tieredFlag></tieredFlag>
    <pricecomptier>
        <priceItemParmGroupId>1</priceItemParmGroupId>
        <toVal>1000.00000000000000000000</toVal>
        <fromVal>0.00000000000000000000</fromVal>

```

```

        <timeOfUse></timeOfUse>
        <priceCompPriceItem>PI_025</priceCompPriceItem>
        <priceCriteria>NBRTRAN</priceCriteria>
        <priceCompTierId></priceCompTierId>
        <tieringSeqNum>10</tieringSeqNum>
        <parmString></parmString>
    </pricecomptier>
</pricecomptier>
    <priceItemParmGroupId>0</priceItemParmGroupId>
    <toVal>5000.000000000000000000</toVal>
    <fromVal>1000.000000000000000000</fromVal>
    <timeOfUse></timeOfUse>
    <priceCompPriceItem>PI_025</priceCompPriceItem>
    <priceCriteria>NBRTRAN</priceCriteria>
    <priceCompTierId></priceCompTierId>
    <tieringSeqNum>10</tieringSeqNum>
    <parmString></parmString>
</pricecomptier>
</pricecomptier>
    <priceItemParmGroupId>1</priceItemParmGroupId>
    <toVal>9999999999999.990000000000000000</toVal>
    <fromVal>5000.000000000000000000</fromVal>
    <timeOfUse></timeOfUse>
    <priceCompPriceItem>PI_025</priceCompPriceItem>
    <priceCriteria>NBRTRAN</priceCriteria>
    <priceCompTierId></priceCompTierId>
    <tieringSeqNum>10</tieringSeqNum>
    <parmString></parmString>
</pricecomptier>
</priceComponent>
<priceComponent>
    <priceCompId>5417400012</priceCompId>
    <priceCompDescr>Threshold price per transaction</priceCompDescr>
    <valueAmt>11.950000000000000000</valueAmt>
    <tieredFlag></tieredFlag>
    <pricecomptier>
        <priceItemParmGroupId>1</priceItemParmGroupId>
        <toVal>1000.000000000000000000</toVal>
        <fromVal>0.000000000000000000</fromVal>
        <timeOfUse></timeOfUse>
        <priceCompPriceItem>PI_025</priceCompPriceItem>
        <priceCriteria>NBRTRAN</priceCriteria>
        <priceCompTierId></priceCompTierId>
        <tieringSeqNum>10</tieringSeqNum>
        <parmString></parmString>
    </pricecomptier>
    <pricecomptier>
        <priceItemParmGroupId>0</priceItemParmGroupId>
        <toVal>5000.000000000000000000</toVal>
        <fromVal>1000.000000000000000000</fromVal>
        <timeOfUse></timeOfUse>
        <priceCompPriceItem>PI_025</priceCompPriceItem>
        <priceCriteria>NBRTRAN</priceCriteria>
        <priceCompTierId></priceCompTierId>
        <tieringSeqNum>10</tieringSeqNum>
        <parmString></parmString>
    </pricecomptier>
    <pricecomptier>
        <priceItemParmGroupId>1</priceItemParmGroupId>
        <toVal>9999999999999.990000000000000000</toVal>
        <fromVal>5000.000000000000000000</fromVal>
        <timeOfUse></timeOfUse>
        <priceCompPriceItem>PI_025</priceCompPriceItem>
        <priceCriteria>NBRTRAN</priceCriteria>

```

```

        <priceCompTierId></priceCompTierId>
        <tieringSeqNum>10</tieringSeqNum>
        <parmString></parmString>
    </pricecomptier>
</priceComponent>
</pricing>
<pricing>
    <priceListId>5417730766</priceListId>
    <priceListDescription>PriceList -1</priceListDescription>
    <priority>1</priority>
    <validityFlag></validityFlag>
    <noOfDays></noOfDays>
    <priceItemCode>PI_026</priceItemCode>
    <priceitemCodeDescr>V6-Electronic Credits</priceitemCodeDescr>
    <priceAsgnId>5410009243</priceAsgnId>
    <priceListStartDate>2022-01-11</priceListStartDate>
    <priceListEndDate>2022-02-28</priceListEndDate>
    <priceComponent>
        <priceCompId>5417400020</priceCompId>
        <priceCompDescr>Basic charges</priceCompDescr>
        <valueAmt>20.000000000000000000</valueAmt>
        <tieredFlag></tieredFlag>
        <pricecomptier>
            <priceItemParmGroupId>1</priceItemParmGroupId>
            <toVal>1000.000000000000000000</toVal>
            <fromVal>0.000000000000000000</fromVal>
            <timeOfUse></timeOfUse>
            <priceCompPriceItem>PI_026</priceCompPriceItem>
            <priceCriteria>NBRTRAN</priceCriteria>
            <priceCompTierId></priceCompTierId>
            <tieringSeqNum>10</tieringSeqNum>
            <parmString></parmString>
        </pricecomptier>
        <pricecomptier>
            <priceItemParmGroupId>0</priceItemParmGroupId>
            <toVal>5000.000000000000000000</toVal>
            <fromVal>1000.000000000000000000</fromVal>
            <timeOfUse></timeOfUse>
            <priceCompPriceItem>PI_026</priceCompPriceItem>
            <priceCriteria>NBRTRAN</priceCriteria>
            <priceCompTierId></priceCompTierId>
            <tieringSeqNum>10</tieringSeqNum>
            <parmString></parmString>
        </pricecomptier>
        <pricecomptier>
            <priceItemParmGroupId>1</priceItemParmGroupId>
            <toVal>999999999999.990000000000000000</toVal>
            <fromVal>5000.000000000000000000</fromVal>
            <timeOfUse></timeOfUse>
            <priceCompPriceItem>PI_026</priceCompPriceItem>
            <priceCriteria>NBRTRAN</priceCriteria>
            <priceCompTierId></priceCompTierId>
            <tieringSeqNum>10</tieringSeqNum>
            <parmString></parmString>
        </pricecomptier>
        <pricecomptier>
            <priceItemParmGroupId>1</priceItemParmGroupId>
            <toVal>1000.000000000000000000</toVal>
            <fromVal>0.000000000000000000</fromVal>
            <timeOfUse></timeOfUse>
            <priceCompPriceItem>PI_026</priceCompPriceItem>
            <priceCriteria>NBRTRAN</priceCriteria>
            <priceCompTierId></priceCompTierId>
            <tieringSeqNum>10</tieringSeqNum>
        </pricecomptier>
    </priceComponent>
</pricing>

```

```

    <parmString></parmString>
  </pricecomptier>
</pricecomptier>
  <priceItemParmGroupId>0</priceItemParmGroupId>
  <toVal>5000.00000000000000000000</toVal>
  <fromVal>1000.00000000000000000000</fromVal>
  <timeOfUse></timeOfUse>
  <priceCompPriceItem>PI_026</priceCompPriceItem>
  <priceCriteria>NBRTRAN</priceCriteria>
  <priceCompTierId></priceCompTierId>
  <tieringSeqNum>10</tieringSeqNum>
  <parmString></parmString>
</pricecomptier>
</pricecomptier>
  <priceItemParmGroupId>1</priceItemParmGroupId>
  <toVal>99999999999.99000000000000000000</toVal>
  <fromVal>5000.00000000000000000000</fromVal>
  <timeOfUse></timeOfUse>
  <priceCompPriceItem>PI_026</priceCompPriceItem>
  <priceCriteria>NBRTRAN</priceCriteria>
  <priceCompTierId></priceCompTierId>
  <tieringSeqNum>10</tieringSeqNum>
  <parmString></parmString>
</pricecomptier>
</priceComponent>
</priceComponent>
  <priceCompId>5417400021</priceCompId>
  <priceCompDescr>Threshold price</priceCompDescr>
  <valueAmt>10.00000000000000000000</valueAmt>
  <tieredFlag></tieredFlag>
  <pricecomptier>
    <priceItemParmGroupId>1</priceItemParmGroupId>
    <toVal>1000.00000000000000000000</toVal>
    <fromVal>0.00000000000000000000</fromVal>
    <timeOfUse></timeOfUse>
    <priceCompPriceItem>PI_026</priceCompPriceItem>
    <priceCriteria>NBRTRAN</priceCriteria>
    <priceCompTierId></priceCompTierId>
    <tieringSeqNum>10</tieringSeqNum>
    <parmString></parmString>
  </pricecomptier>
  </pricecomptier>
  <priceItemParmGroupId>0</priceItemParmGroupId>
  <toVal>5000.00000000000000000000</toVal>
  <fromVal>1000.00000000000000000000</fromVal>
  <timeOfUse></timeOfUse>
  <priceCompPriceItem>PI_026</priceCompPriceItem>
  <priceCriteria>NBRTRAN</priceCriteria>
  <priceCompTierId></priceCompTierId>
  <tieringSeqNum>10</tieringSeqNum>
  <parmString></parmString>
</pricecomptier>
</pricecomptier>
  <priceItemParmGroupId>1</priceItemParmGroupId>
  <toVal>99999999999.99000000000000000000</toVal>
  <fromVal>5000.00000000000000000000</fromVal>
  <timeOfUse></timeOfUse>
  <priceCompPriceItem>PI_026</priceCompPriceItem>
  <priceCriteria>NBRTRAN</priceCriteria>
  <priceCompTierId></priceCompTierId>
  <tieringSeqNum>10</tieringSeqNum>
  <parmString></parmString>
</pricecomptier>
</pricecomptier>

```

```

    <priceItemParmGroupId>1</priceItemParmGroupId>
    <toVal>1000.0000000000000000</toVal>
    <fromVal>0.0000000000000000</fromVal>
    <timeOfUse></timeOfUse>
    <priceCompPriceItem>PI_026</priceCompPriceItem>
    <priceCriteria>NBRTRAN</priceCriteria>
    <priceCompTierId></priceCompTierId>
    <tieringSeqNum>10</tieringSeqNum>
    <parmString></parmString>
  </pricecomptier>
</pricecomptier>
  <priceItemParmGroupId>0</priceItemParmGroupId>
  <toVal>5000.0000000000000000</toVal>
  <fromVal>1000.0000000000000000</fromVal>
  <timeOfUse></timeOfUse>
  <priceCompPriceItem>PI_026</priceCompPriceItem>
  <priceCriteria>NBRTRAN</priceCriteria>
  <priceCompTierId></priceCompTierId>
  <tieringSeqNum>10</tieringSeqNum>
  <parmString></parmString>
</pricecomptier>
</pricecomptier>
  <priceItemParmGroupId>1</priceItemParmGroupId>
  <toVal>99999999999.9900000000000000</toVal>
  <fromVal>5000.0000000000000000</fromVal>
  <timeOfUse></timeOfUse>
  <priceCompPriceItem>PI_026</priceCompPriceItem>
  <priceCriteria>NBRTRAN</priceCriteria>
  <priceCompTierId></priceCompTierId>
  <tieringSeqNum>10</tieringSeqNum>
  <parmString></parmString>
</pricecomptier>
</priceComponent>
<priceComponent>
  <priceCompId>5417400022</priceCompId>
  <priceCompDescr>Threshold price</priceCompDescr>
  <valueAmt>8.0000000000000000</valueAmt>
  <tieredFlag></tieredFlag>
  <pricecomptier>
    <priceItemParmGroupId>1</priceItemParmGroupId>
    <toVal>1000.0000000000000000</toVal>
    <fromVal>0.0000000000000000</fromVal>
    <timeOfUse></timeOfUse>
    <priceCompPriceItem>PI_026</priceCompPriceItem>
    <priceCriteria>NBRTRAN</priceCriteria>
    <priceCompTierId></priceCompTierId>
    <tieringSeqNum>10</tieringSeqNum>
    <parmString></parmString>
  </pricecomptier>
  <pricecomptier>
    <priceItemParmGroupId>0</priceItemParmGroupId>
    <toVal>5000.0000000000000000</toVal>
    <fromVal>1000.0000000000000000</fromVal>
    <timeOfUse></timeOfUse>
    <priceCompPriceItem>PI_026</priceCompPriceItem>
    <priceCriteria>NBRTRAN</priceCriteria>
    <priceCompTierId></priceCompTierId>
    <tieringSeqNum>10</tieringSeqNum>
    <parmString></parmString>
  </pricecomptier>
  <pricecomptier>
    <priceItemParmGroupId>1</priceItemParmGroupId>
    <toVal>99999999999.9900000000000000</toVal>
    <fromVal>5000.0000000000000000</fromVal>

```

```

        <timeOfUse></timeOfUse>
        <priceCompPriceItem>PI_026</priceCompPriceItem>
        <priceCriteria>NBRTRAN</priceCriteria>
        <priceCompTierId></priceCompTierId>
        <tieringSeqNum>10</tieringSeqNum>
        <parmString></parmString>
    </pricecomptier>
</pricecomptier>
    <priceItemParmGroupId>1</priceItemParmGroupId>
    <toVal>1000.000000000000000000</toVal>
    <fromVal>0.000000000000000000</fromVal>
    <timeOfUse></timeOfUse>
    <priceCompPriceItem>PI_026</priceCompPriceItem>
    <priceCriteria>NBRTRAN</priceCriteria>
    <priceCompTierId></priceCompTierId>
    <tieringSeqNum>10</tieringSeqNum>
    <parmString></parmString>
</pricecomptier>
</pricecomptier>
    <priceItemParmGroupId>0</priceItemParmGroupId>
    <toVal>5000.000000000000000000</toVal>
    <fromVal>1000.000000000000000000</fromVal>
    <timeOfUse></timeOfUse>
    <priceCompPriceItem>PI_026</priceCompPriceItem>
    <priceCriteria>NBRTRAN</priceCriteria>
    <priceCompTierId></priceCompTierId>
    <tieringSeqNum>10</tieringSeqNum>
    <parmString></parmString>
</pricecomptier>
</pricecomptier>
    <priceItemParmGroupId>1</priceItemParmGroupId>
    <toVal>99999999999.990000000000000000</toVal>
    <fromVal>5000.000000000000000000</fromVal>
    <timeOfUse></timeOfUse>
    <priceCompPriceItem>PI_026</priceCompPriceItem>
    <priceCriteria>NBRTRAN</priceCriteria>
    <priceCompTierId></priceCompTierId>
    <tieringSeqNum>10</tieringSeqNum>
    <parmString></parmString>
</pricecomptier>
</priceComponent>
<priceComponent>
    <priceCompId>5417400023</priceCompId>
    <priceCompDescr>Threshold price</priceCompDescr>
    <valueAmt>6.000000000000000000</valueAmt>
    <tieredFlag></tieredFlag>
    <pricecomptier>
        <priceItemParmGroupId>1</priceItemParmGroupId>
        <toVal>1000.000000000000000000</toVal>
        <fromVal>0.000000000000000000</fromVal>
        <timeOfUse></timeOfUse>
        <priceCompPriceItem>PI_026</priceCompPriceItem>
        <priceCriteria>NBRTRAN</priceCriteria>
        <priceCompTierId></priceCompTierId>
        <tieringSeqNum>10</tieringSeqNum>
        <parmString></parmString>
    </pricecomptier>
</pricecomptier>
    <priceItemParmGroupId>0</priceItemParmGroupId>
    <toVal>5000.000000000000000000</toVal>
    <fromVal>1000.000000000000000000</fromVal>
    <timeOfUse></timeOfUse>
    <priceCompPriceItem>PI_026</priceCompPriceItem>
    <priceCriteria>NBRTRAN</priceCriteria>

```



```

    <priceCompTierId></priceCompTierId>
    <tieringSeqNum>10</tieringSeqNum>
    <parmString></parmString>
  </pricecomptier>
  <pricecomptier>
    <priceItemParmGroupId>1</priceItemParmGroupId>
    <toVal>999999999999.99000000000000000000</toVal>
    <fromVal>5000.00000000000000000000</fromVal>
    <timeOfUse></timeOfUse>
    <priceCompPriceItem>PI_026</priceCompPriceItem>
    <priceCriteria>NBRTRAN</priceCriteria>
    <priceCompTierId></priceCompTierId>
    <tieringSeqNum>10</tieringSeqNum>
    <parmString></parmString>
  </pricecomptier>
  <pricecomptier>
    <priceItemParmGroupId>1</priceItemParmGroupId>
    <toVal>1000.00000000000000000000</toVal>
    <fromVal>0.00000000000000000000</fromVal>
    <timeOfUse></timeOfUse>
    <priceCompPriceItem>PI_026</priceCompPriceItem>
    <priceCriteria>NBRTRAN</priceCriteria>
    <priceCompTierId></priceCompTierId>
    <tieringSeqNum>10</tieringSeqNum>
    <parmString></parmString>
  </pricecomptier>
  <pricecomptier>
    <priceItemParmGroupId>0</priceItemParmGroupId>
    <toVal>5000.00000000000000000000</toVal>
    <fromVal>1000.00000000000000000000</fromVal>
    <timeOfUse></timeOfUse>
    <priceCompPriceItem>PI_026</priceCompPriceItem>
    <priceCriteria>NBRTRAN</priceCriteria>
    <priceCompTierId></priceCompTierId>
    <tieringSeqNum>10</tieringSeqNum>
    <parmString></parmString>
  </pricecomptier>
  <pricecomptier>
    <priceItemParmGroupId>1</priceItemParmGroupId>
    <toVal>999999999999.99000000000000000000</toVal>
    <fromVal>5000.00000000000000000000</fromVal>
    <timeOfUse></timeOfUse>
    <priceCompPriceItem>PI_026</priceCompPriceItem>
    <priceCriteria>NBRTRAN</priceCriteria>
    <priceCompTierId></priceCompTierId>
    <tieringSeqNum>10</tieringSeqNum>
    <parmString></parmString>
  </pricecomptier>
</priceComponent>
<priceComponent>
  <priceCompId>5417400024</priceCompId>
  <priceCompDescr>Step 1</priceCompDescr>
  <valueAmt>5.00000000000000000000</valueAmt>
  <tieredFlag></tieredFlag>
  <pricecomptier>
    <priceItemParmGroupId>1</priceItemParmGroupId>
    <toVal>1000.00000000000000000000</toVal>
    <fromVal>0.00000000000000000000</fromVal>
    <timeOfUse></timeOfUse>
    <priceCompPriceItem>PI_026</priceCompPriceItem>
    <priceCriteria>NBRTRAN</priceCriteria>
    <priceCompTierId></priceCompTierId>
    <tieringSeqNum>10</tieringSeqNum>
    <parmString></parmString>
  </pricecomptier>

```

```

</pricecomptier>
<pricecomptier>
  <priceItemParmGroupId>0</priceItemParmGroupId>
  <toVal>5000.00000000000000000000</toVal>
  <fromVal>1000.00000000000000000000</fromVal>
  <timeOfUse></timeOfUse>
  <priceCompPriceItem>PI_026</priceCompPriceItem>
  <priceCriteria>NBRTRAN</priceCriteria>
  <priceCompTierId></priceCompTierId>
  <tieringSeqNum>10</tieringSeqNum>
  <parmString></parmString>
</pricecomptier>
<pricecomptier>
  <priceItemParmGroupId>1</priceItemParmGroupId>
  <toVal>999999999999.99000000000000000000</toVal>
  <fromVal>5000.00000000000000000000</fromVal>
  <timeOfUse></timeOfUse>
  <priceCompPriceItem>PI_026</priceCompPriceItem>
  <priceCriteria>NBRTRAN</priceCriteria>
  <priceCompTierId></priceCompTierId>
  <tieringSeqNum>10</tieringSeqNum>
  <parmString></parmString>
</pricecomptier>
<pricecomptier>
  <priceItemParmGroupId>1</priceItemParmGroupId>
  <toVal>1000.00000000000000000000</toVal>
  <fromVal>0.00000000000000000000</fromVal>
  <timeOfUse></timeOfUse>
  <priceCompPriceItem>PI_026</priceCompPriceItem>
  <priceCriteria>NBRTRAN</priceCriteria>
  <priceCompTierId></priceCompTierId>
  <tieringSeqNum>10</tieringSeqNum>
  <parmString></parmString>
</pricecomptier>
<pricecomptier>
  <priceItemParmGroupId>0</priceItemParmGroupId>
  <toVal>5000.00000000000000000000</toVal>
  <fromVal>1000.00000000000000000000</fromVal>
  <timeOfUse></timeOfUse>
  <priceCompPriceItem>PI_026</priceCompPriceItem>
  <priceCriteria>NBRTRAN</priceCriteria>
  <priceCompTierId></priceCompTierId>
  <tieringSeqNum>10</tieringSeqNum>
  <parmString></parmString>
</pricecomptier>
<pricecomptier>
  <priceItemParmGroupId>1</priceItemParmGroupId>
  <toVal>999999999999.99000000000000000000</toVal>
  <fromVal>5000.00000000000000000000</fromVal>
  <timeOfUse></timeOfUse>
  <priceCompPriceItem>PI_026</priceCompPriceItem>
  <priceCriteria>NBRTRAN</priceCriteria>
  <priceCompTierId></priceCompTierId>
  <tieringSeqNum>10</tieringSeqNum>
  <parmString></parmString>
</pricecomptier>
</priceComponent>
<priceComponent>
  <priceCompId>5417400025</priceCompId>
  <priceCompDescr>Step 2</priceCompDescr>
  <valueAmt>4.00000000000000000000</valueAmt>
  <tieredFlag></tieredFlag>
  <pricecomptier>
    <priceItemParmGroupId>1</priceItemParmGroupId>

```

```

    <toVal>1000.00000000000000000000</toVal>
    <fromVal>0.00000000000000000000</fromVal>
    <timeOfUse></timeOfUse>
    <priceCompPriceItem>PI_026</priceCompPriceItem>
    <priceCriteria>NBRTRAN</priceCriteria>
    <priceCompTierId></priceCompTierId>
    <tieringSeqNum>10</tieringSeqNum>
    <parmString></parmString>
  </pricecomptier>
</pricecomptier>
  <priceItemParmGroupId>0</priceItemParmGroupId>
  <toVal>5000.00000000000000000000</toVal>
  <fromVal>1000.00000000000000000000</fromVal>
  <timeOfUse></timeOfUse>
  <priceCompPriceItem>PI_026</priceCompPriceItem>
  <priceCriteria>NBRTRAN</priceCriteria>
  <priceCompTierId></priceCompTierId>
  <tieringSeqNum>10</tieringSeqNum>
  <parmString></parmString>
</pricecomptier>
<pricecomptier>
  <priceItemParmGroupId>1</priceItemParmGroupId>
  <toVal>999999999999.99000000000000000000</toVal>
  <fromVal>5000.00000000000000000000</fromVal>
  <timeOfUse></timeOfUse>
  <priceCompPriceItem>PI_026</priceCompPriceItem>
  <priceCriteria>NBRTRAN</priceCriteria>
  <priceCompTierId></priceCompTierId>
  <tieringSeqNum>10</tieringSeqNum>
  <parmString></parmString>
</pricecomptier>
<pricecomptier>
  <priceItemParmGroupId>1</priceItemParmGroupId>
  <toVal>1000.00000000000000000000</toVal>
  <fromVal>0.00000000000000000000</fromVal>
  <timeOfUse></timeOfUse>
  <priceCompPriceItem>PI_026</priceCompPriceItem>
  <priceCriteria>NBRTRAN</priceCriteria>
  <priceCompTierId></priceCompTierId>
  <tieringSeqNum>10</tieringSeqNum>
  <parmString></parmString>
</pricecomptier>
<pricecomptier>
  <priceItemParmGroupId>0</priceItemParmGroupId>
  <toVal>5000.00000000000000000000</toVal>
  <fromVal>1000.00000000000000000000</fromVal>
  <timeOfUse></timeOfUse>
  <priceCompPriceItem>PI_026</priceCompPriceItem>
  <priceCriteria>NBRTRAN</priceCriteria>
  <priceCompTierId></priceCompTierId>
  <tieringSeqNum>10</tieringSeqNum>
  <parmString></parmString>
</pricecomptier>
<pricecomptier>
  <priceItemParmGroupId>1</priceItemParmGroupId>
  <toVal>999999999999.99000000000000000000</toVal>
  <fromVal>5000.00000000000000000000</fromVal>
  <timeOfUse></timeOfUse>
  <priceCompPriceItem>PI_026</priceCompPriceItem>
  <priceCriteria>NBRTRAN</priceCriteria>
  <priceCompTierId></priceCompTierId>
  <tieringSeqNum>10</tieringSeqNum>
  <parmString></parmString>
</pricecomptier>

```

```

</priceComponent>
<priceComponent>
  <priceCompId>5417400026</priceCompId>
  <priceCompDescr>Step 3</priceCompDescr>
  <valueAmt>3.000000000000000000</valueAmt>
  <tieredFlag></tieredFlag>
  <pricecomptier>
    <priceItemParmGroupId>1</priceItemParmGroupId>
    <toVal>1000.000000000000000000</toVal>
    <fromVal>0.000000000000000000</fromVal>
    <timeOfUse></timeOfUse>
    <priceCompPriceItem>PI_026</priceCompPriceItem>
    <priceCriteria>NBRTRAN</priceCriteria>
    <priceCompTierId></priceCompTierId>
    <tieringSeqNum>10</tieringSeqNum>
    <parmString></parmString>
  </pricecomptier>
  <pricecomptier>
    <priceItemParmGroupId>0</priceItemParmGroupId>
    <toVal>5000.000000000000000000</toVal>
    <fromVal>1000.000000000000000000</fromVal>
    <timeOfUse></timeOfUse>
    <priceCompPriceItem>PI_026</priceCompPriceItem>
    <priceCriteria>NBRTRAN</priceCriteria>
    <priceCompTierId></priceCompTierId>
    <tieringSeqNum>10</tieringSeqNum>
    <parmString></parmString>
  </pricecomptier>
  <pricecomptier>
    <priceItemParmGroupId>1</priceItemParmGroupId>
    <toVal>999999999999.990000000000000000</toVal>
    <fromVal>5000.000000000000000000</fromVal>
    <timeOfUse></timeOfUse>
    <priceCompPriceItem>PI_026</priceCompPriceItem>
    <priceCriteria>NBRTRAN</priceCriteria>
    <priceCompTierId></priceCompTierId>
    <tieringSeqNum>10</tieringSeqNum>
    <parmString></parmString>
  </pricecomptier>
  <pricecomptier>
    <priceItemParmGroupId>1</priceItemParmGroupId>
    <toVal>1000.000000000000000000</toVal>
    <fromVal>0.000000000000000000</fromVal>
    <timeOfUse></timeOfUse>
    <priceCompPriceItem>PI_026</priceCompPriceItem>
    <priceCriteria>NBRTRAN</priceCriteria>
    <priceCompTierId></priceCompTierId>
    <tieringSeqNum>10</tieringSeqNum>
    <parmString></parmString>
  </pricecomptier>
  <pricecomptier>
    <priceItemParmGroupId>0</priceItemParmGroupId>
    <toVal>5000.000000000000000000</toVal>
    <fromVal>1000.000000000000000000</fromVal>
    <timeOfUse></timeOfUse>
    <priceCompPriceItem>PI_026</priceCompPriceItem>
    <priceCriteria>NBRTRAN</priceCriteria>
    <priceCompTierId></priceCompTierId>
    <tieringSeqNum>10</tieringSeqNum>
    <parmString></parmString>
  </pricecomptier>
  <pricecomptier>
    <priceItemParmGroupId>1</priceItemParmGroupId>
    <toVal>999999999999.990000000000000000</toVal>

```

```

        <fromVal>5000.000000000000000000</fromVal>
        <timeOfUse></timeOfUse>
        <priceCompPriceItem>PI_026</priceCompPriceItem>
        <priceCriteria>NBRTRAN</priceCriteria>
        <priceCompTierId></priceCompTierId>
        <tieringSeqNum>10</tieringSeqNum>
        <parmString></parmString>
    </pricecomptier>
</priceComponent>
</pricing>
<pricing>
    <priceListId>5417730766</priceListId>
    <priceListDescription>PriceList -1</priceListDescription>
    <priority>1</priority>
    <validityFlag></validityFlag>
    <noOfDays></noOfDays>
    <priceItemCode>PI_027</priceItemCode>
    <priceitemCodeDescr>V7-Direct Debit</priceitemCodeDescr>
    <priceAsgnId>5410009209</priceAsgnId>
    <priceListStartDate>2022-01-11</priceListStartDate>
    <priceListEndDate>2022-02-28</priceListEndDate>
    <priceComponent>
        <priceCompId>5417300038</priceCompId>
        <priceCompDescr>Basic BK-NBR</priceCompDescr>
        <valueAmt>0.150000000000000000</valueAmt>
        <tieredFlag></tieredFlag>
        <pricecomptier>
            <priceItemParmGroupId></priceItemParmGroupId>
            <toVal></toVal>
            <fromVal></fromVal>
            <timeOfUse></timeOfUse>
            <priceCompPriceItem></priceCompPriceItem>
            <priceCriteria>NBRTRAN</priceCriteria>
            <priceCompTierId></priceCompTierId>
            <tieringSeqNum></tieringSeqNum>
            <parmString></parmString>
        </pricecomptier>
    </priceComponent>
</pricing>
<pricing>
    <priceListId>5417730766</priceListId>
    <priceListDescription>PriceList -1</priceListDescription>
    <priority>1</priority>
    <validityFlag></validityFlag>
    <noOfDays></noOfDays>
    <priceItemCode>PI_028</priceItemCode>
    <priceitemCodeDescr>V8-Cheque Collections</priceitemCodeDescr>
    <priceAsgnId>5410009210</priceAsgnId>
    <priceListStartDate>2022-01-11</priceListStartDate>
    <priceListEndDate>2022-02-28</priceListEndDate>
    <priceComponent>
        <priceCompId>5417300040</priceCompId>
        <priceCompDescr>FLAT</priceCompDescr>
        <valueAmt>0.750000000000000000</valueAmt>
        <tieredFlag></tieredFlag>
        <pricecomptier>
            <priceItemParmGroupId></priceItemParmGroupId>
            <toVal></toVal>
            <fromVal></fromVal>
            <timeOfUse></timeOfUse>
            <priceCompPriceItem></priceCompPriceItem>
            <priceCriteria>NBRTRAN</priceCriteria>
            <priceCompTierId></priceCompTierId>
            <tieringSeqNum></tieringSeqNum>
        </pricecomptier>
    </priceComponent>
</pricing>

```

```

        <parmString></parmString>
    </pricecomptier>
</priceComponent>
</pricing>
<pricing>
    <priceListId>5417730766</priceListId>
    <priceListDescription>PriceList -1</priceListDescription>
    <priority>1</priority>
    <validityFlag></validityFlag>
    <noOfDays></noOfDays>
    <priceItemCode>PI_028</priceItemCode>
    <priceitemCodeDescr>V8-Cheque Collections</priceitemCodeDescr>
    <priceAsgnId>5410009211</priceAsgnId>
    <priceListStartDate>2022-01-11</priceListStartDate>
    <priceListEndDate>2022-02-28</priceListEndDate>
    <priceComponent>
        <priceCompId>5417300042</priceCompId>
        <priceCompDescr>FLAT</priceCompDescr>
        <valueAmt>6.670000000000000000</valueAmt>
        <tieredFlag></tieredFlag>
        <pricecomptier>
            <priceItemParmGroupId></priceItemParmGroupId>
            <toVal></toVal>
            <fromVal></fromVal>
            <timeOfUse></timeOfUse>
            <priceCompPriceItem></priceCompPriceItem>
            <priceCriteria>NBRTRAN</priceCriteria>
            <priceCompTierId></priceCompTierId>
            <tieringSeqNum></tieringSeqNum>
            <parmString></parmString>
        </pricecomptier>
    </priceComponent>
</pricing>
<pricing>
    <priceListId>5417730766</priceListId>
    <priceListDescription>PriceList -1</priceListDescription>
    <priority>1</priority>
    <validityFlag></validityFlag>
    <noOfDays></noOfDays>
    <priceItemCode>PI_028</priceItemCode>
    <priceitemCodeDescr>V8-Cheque Collections</priceitemCodeDescr>
    <priceAsgnId>5410009212</priceAsgnId>
    <priceListStartDate>2022-01-11</priceListStartDate>
    <priceListEndDate>2022-02-28</priceListEndDate>
    <priceComponent>
        <priceCompId>5417300044</priceCompId>
        <priceCompDescr>FLAT</priceCompDescr>
        <valueAmt>0.300000000000000000</valueAmt>
        <tieredFlag></tieredFlag>
        <pricecomptier>
            <priceItemParmGroupId></priceItemParmGroupId>
            <toVal></toVal>
            <fromVal></fromVal>
            <timeOfUse></timeOfUse>
            <priceCompPriceItem></priceCompPriceItem>
            <priceCriteria>NBRTRAN</priceCriteria>
            <priceCompTierId></priceCompTierId>
            <tieringSeqNum></tieringSeqNum>
            <parmString></parmString>
        </pricecomptier>
    </priceComponent>
</pricing>
<pricing>
    <priceListId>5417730766</priceListId>

```

```

<priceListDescription>PriceList -1</priceListDescription>
<priority>1</priority>
<validityFlag></validityFlag>
<noOfDays></noOfDays>
<priceItemCode>PI_028</priceItemCode>
<priceitemCodeDescr>V8-Cheque Collections</priceitemCodeDescr>
<priceAsgnId>5410009213</priceAsgnId>
<priceListStartDate>2022-01-11</priceListStartDate>
<priceListEndDate>2022-02-28</priceListEndDate>
<priceComponent>
  <priceCompId>5417300046</priceCompId>
  <priceCompDescr>FLAT</priceCompDescr>
  <valueAmt>2.05000000000000000000</valueAmt>
  <tieredFlag></tieredFlag>
  <pricecomptier>
    <priceItemParmGroupId></priceItemParmGroupId>
    <toVal></toVal>
    <fromVal></fromVal>
    <timeOfUse></timeOfUse>
    <priceCompPriceItem></priceCompPriceItem>
    <priceCriteria>NBRTRAN</priceCriteria>
    <priceCompTierId></priceCompTierId>
    <tieringSeqNum></tieringSeqNum>
    <parmString></parmString>
  </pricecomptier>
</priceComponent>
</pricing>
<pricing>
  <priceListId>5417730766</priceListId>
  <priceListDescription>PriceList -1</priceListDescription>
  <priority>1</priority>
  <validityFlag></validityFlag>
  <noOfDays></noOfDays>
  <priceItemCode>PI_029</priceItemCode>
  <priceitemCodeDescr>V9-Domestic Liquidity</priceitemCodeDescr>
  <priceAsgnId>5410009214</priceAsgnId>
  <priceListStartDate>2022-01-11</priceListStartDate>
  <priceListEndDate>2022-02-28</priceListEndDate>
  <priceComponent>
    <priceCompId>5417300048</priceCompId>
    <priceCompDescr>FLAT</priceCompDescr>
    <valueAmt>0.40000000000000000000</valueAmt>
    <tieredFlag></tieredFlag>
    <pricecomptier>
      <priceItemParmGroupId></priceItemParmGroupId>
      <toVal></toVal>
      <fromVal></fromVal>
      <timeOfUse></timeOfUse>
      <priceCompPriceItem></priceCompPriceItem>
      <priceCriteria>NBRTRAN</priceCriteria>
      <priceCompTierId></priceCompTierId>
      <tieringSeqNum></tieringSeqNum>
      <parmString></parmString>
    </pricecomptier>
  </priceComponent>
</pricing>
<pricing>
  <priceListId>5417730766</priceListId>
  <priceListDescription>PriceList -1</priceListDescription>
  <priority>1</priority>
  <validityFlag></validityFlag>
  <noOfDays></noOfDays>
  <priceItemCode>PI_030</priceItemCode>
  <priceitemCodeDescr>V10-Third Party Bank</priceitemCodeDescr>

```

```

<priceAsgnId>5410009215</priceAsgnId>
<priceListStartDate>2022-01-11</priceListStartDate>
<priceListEndDate>2022-02-28</priceListEndDate>
<priceComponent>
  <priceCompId>5417300050</priceCompId>
  <priceCompDescr>FLAT</priceCompDescr>
  <valueAmt>0.600000000000000000</valueAmt>
  <tieredFlag></tieredFlag>
  <pricecomptier>
    <priceItemParmGroupId></priceItemParmGroupId>
    <toVal></toVal>
    <fromVal></fromVal>
    <timeOfUse></timeOfUse>
    <priceCompPriceItem></priceCompPriceItem>
    <priceCriteria>NBRTRAN</priceCriteria>
    <priceCompTierId></priceCompTierId>
    <tieringSeqNum></tieringSeqNum>
    <parmString></parmString>
  </pricecomptier>
</priceComponent>
</pricing>
<pricing>
  <priceListId>5417730766</priceListId>
  <priceListDescription>PriceList -1</priceListDescription>
  <priority>1</priority>
  <validityFlag></validityFlag>
  <noOfDays></noOfDays>
  <priceItemCode>PI_031</priceItemCode>
  <priceitemCodeDescr>MT943_SWIFT_01</priceitemCodeDescr>
  <priceAsgnId>5410009201</priceAsgnId>
  <priceListStartDate>2022-01-11</priceListStartDate>
  <priceListEndDate>2022-02-28</priceListEndDate>
  <priceComponent>
    <priceCompId>5417300002</priceCompId>
    <priceCompDescr>FLAT</priceCompDescr>
    <valueAmt>16.660000000000000000</valueAmt>
    <tieredFlag></tieredFlag>
    <pricecomptier>
      <priceItemParmGroupId></priceItemParmGroupId>
      <toVal></toVal>
      <fromVal></fromVal>
      <timeOfUse></timeOfUse>
      <priceCompPriceItem></priceCompPriceItem>
      <priceCriteria>NBRTRAN</priceCriteria>
      <priceCompTierId></priceCompTierId>
      <tieringSeqNum></tieringSeqNum>
      <parmString></parmString>
    </pricecomptier>
  </priceComponent>
</pricing>
<pricing>
  <priceListId>5417730766</priceListId>
  <priceListDescription>PriceList -1</priceListDescription>
  <priority>1</priority>
  <validityFlag></validityFlag>
  <noOfDays></noOfDays>
  <priceItemCode>PI_032</priceItemCode>
  <priceitemCodeDescr>MT943_SWIFT_02</priceitemCodeDescr>
  <priceAsgnId>5410009261</priceAsgnId>
  <priceListStartDate>2022-01-11</priceListStartDate>
  <priceListEndDate>2022-02-28</priceListEndDate>
  <priceComponent>
    <priceCompId>5417450002</priceCompId>
    <priceCompDescr>FLAT</priceCompDescr>

```



```

<valueAmt>15.000000000000000000</valueAmt>
<tieredFlag></tieredFlag>
<pricecomptier>
  <priceItemParmGroupId></priceItemParmGroupId>
  <toVal></toVal>
  <fromVal></fromVal>
  <timeOfUse></timeOfUse>
  <priceCompPriceItem></priceCompPriceItem>
  <priceCriteria>NBRTRAN</priceCriteria>
  <priceCompTierId></priceCompTierId>
  <tieringSeqNum></tieringSeqNum>
  <parmString></parmString>
</pricecomptier>
</priceComponent>
</pricing>
</C1-GetProdDetail>

```

Related Topics

For more information on...	See...
Market Product, Offer, or Bundle View Request and Response - Tags in XML Format	Market Product, Offer, or Bundle View Request - Tags in XML Format on page 3474

Market Product, Offer, or Bundle View Request in the JSON Format

The following code snippet illustrates how the attribute/value pairs should be structured while receiving the market product, offer, or bundle view request in the JSON format:

```

{
  "C1-GetProdDetail":
  {
    "entityCode": "",
    "entityType": "",
    "processDate": "",
    "inquiryTypeFlag": "",
    "division": ""
  }
}

```

Related Topics

For more information on...	See...
Market Product, Offer, or Bundle View Request and Response - Attribute/Value Pairs in JSON Format	Market Product, Offer, or Bundle View Request and Response - Attribute/Value Pairs in JSON Format on page 3568
Sample Market Product View Request and Response in the JSON Format	Sample Market Product View Request and Response in the JSON Format on page 3571
Sample Offer View Request and Response in the JSON Format	Sample Offer View Request and Response in the JSON Format on page 3575
Sample Bundle View Request and Response in the JSON Format	Sample Bundle View Request and Response in the JSON Format on page 3598
Sample Bundle View Summary Request and Response in the JSON Format	Sample Bundle View Summary Request and Response in the JSON Format on page 3620
Sample Bundle View Detail Request and Response in the JSON Format	Sample Bundle View Detail Request and Response in the JSON Format on page 3622

Market Product, Offer, or Bundle View Response in the JSON Format

The following code snippet illustrates how the attribute/value pairs should be structured while sending the market product, offer, or bundle view response in the JSON format:

```
{
  "C1-GetProdDetail":
  {
    "entityCode": "",
    "entityType": "",
    "processDate": "",
    "inquiryTypeFlag": "",
    "division": "",
    "entityName": "",
    "entityStartDate": "",
    "entityEndDate": "",
    "termsAndCondition": "",
    "status": "",
    "termsAndCondDescr": "",
    "messageCategory": "",
    "messageNumber": "",
    "messageText": "",
    "longDescription": "",
    "productlist":
    {
      "productCode": "",
      "productName": "",
      "prodTypFlg": "",
      "productCategoryFlgDesc": "",
    }
    "EntityDivision":
    {
      "divisionCode": "",
    }
    "productLinkedEntity type":
    {
      "linkedEntityCode": "",
      "linkedEntityName": "",
      "linkedEntityType": "",
    }
    "eligibilityDetails":
    {
      "eligibilityDescription": "",
      "eligibilityStartDate": "",
      "eligibilityEndDate": "",
      "eligibilityRule":
      {
        "rhsPriceParmCd": "",
        "rhsPriceParmVal": "",
        "lhsPriceParmCd": "",
        "rhsPriceParmTypeFlg": "",
        "trueFlag": "",
        "trueFlagDescr": "",
        "falseFlag": "",
        "falseFlagDescr": "",
        "insufficientFlag": "",
        "insufficientFlagDescr": "",
        "eligibilityRuleFlg": "",
        "eligibilityDescr": "",
        "operator": "",
        "priceParmCode": "",
        "sequenceNumber": "",
      }
    }
  }
}
```

Market Product, Offer, or Bundle View Request and Response - Attribute/Value Pairs in JSON Format

Note: We recommend you to refer the topics [Market Product, Offer, or Bundle View Request in the JSON Format](#) on page 3565 and [Market Product, Offer, or Bundle View Response in the JSON Format](#) on page 3566 in parallel while understanding the below mentioned tags. This will help you to understand how the attribute/value pairs structured in the JSON format.

Before calling the **C1-GetProdDetail** business service through an inbound web service, you need to ensure that the active market products, offers, or bundles view request contains the following attributes:

Attribute Name	Attribute Description	Mandatory (Yes or No)
entityCode	Used to specify the entity code to get the active entity.	Yes
	Note: Entity is referred to market product, offer or bundle.	
entityType	Used to indicate the entity type to get the active entity.	Yes
processDate	Used to specify the date to get the effective market product, offer, or bundle for that date.	Yes(Conditional)
		Note: If the date is not entered then it will display the default date from the system on which the enquiry is made.
inquiryTypeFlag	Used to indicate whether you want to view the basic details without price components or the complete details with price components of the entity. The valid values are: <ul style="list-style-type: none"> Detail (DETL) - Used to indicate whether you want to view the complete details with price components of the entity. Summary (SMRY) - Used to indicate whether you want to view the basic details without price components of the entity. 	Yes(Conditional)
		Note: The default is SMRY.
division	Used to indicate the division to which the entity belongs.	Yes(Conditional)
		Note: This field is required with product code, product category, entity type or entity code to extract the entity of the specific division.

The following table lists and describes the attributes which appear in the view active market products, offers, or bundles derivation response JSON format:

Attribute Name	Attribute Description
entityName	Displays the entity name.

Attribute Name	Attribute Description
entityStartDate	Displays the date from when the entity is effective.
entityEndDate	Displays the date till when the entity is effective.
termsAndCondition	Displays the terms and condition of the entity.
status	Displays the status of the entity.
termsAndCondndescri	Displays the description of the terms and conditions of the entity.
messageCategory	Indicates the category of the message.
messageNumber	Indicates the number of the message.
messageText	Displays the message.
longDescription	Displays the long description.
productlist	Displays the list of the eligible product to which the requested entity belongs.
productCode	Used to display the code of the parent product.
productName	Used to display the parent product.
prodTypFlg	Displays the code of the eligible product to which the requested entity belongs.
productCategoryFlgDes	Displays the description of the eligible product category flag to which the requested entity belongs.
EntityDivision	Used to indicate the division of the requested entity.
divisionCode	Displays the division to which the requested entity belongs.
productLinkedEntity	Displays the list of eligible market product, offer, and bundle.
linkedEntityCode	Displays the linked entity code for the requested entity code.
linkedEntityName	Displays the linked entity for the requested entity code.
linkedEntityType	Displays the linked entity type for the requested entity code.
eligibilityDetails	Indicates the name of group tag.
eligibilityDescription	Displays the description of the eligibility to which the requested entity belongs.
eligibilityStartDate	Displays the date from when the eligibility of the entity is effective.
eligibilityEndDate	Displays the date till when the eligibility of the entity is effective.
eligibilityRule	This is group tag under the eligibility details.
rhsPriceParmCd	Indicates the right side parameter code of the eligibility condition.
rhsPriceParmVal	Indicates the right side parameter value of the eligibility condition.
lhsPriceParmCd	Indicates the left side parameter code of the eligibility condition.
rhsPriceParmTypeFlg	Indicates the value of the right side flag.
trueFlag	Indicates the true condition.
trueFlagDescr	Displays the description for the true flag condition.
falseFlag	Indicates the false condition.
falseFlagDescr	Displays the description for the false flag condition.
insufficientFlag	Indicates the insufficient condition.

Attribute Name	Attribute Description
insufficientFlagDescr	Displays the description for the insufficient flag condition.
eligibilityRuleFlg	Indicates the eligibility rule flag condition.
eligibilityDescr	Displays the description of the eligibility criteria for the input entity.
operator	Indicates the operator to evaluate the condition.
priceParmCode	Displays the price parameter code.
sequenceNumber	Displays the sequence number of the eligibility condition.
pricing	Displays the price of the requested entity.
priceListId	Displays the price list ID.
priceListDescription	Displays the description of the Price List.
priority	Displays the priority in sequence of the price list of the entity.
validityFlag	Indicates the validity of the price item.
noOfDays	Displays the validity of price list in number of days.
priceItemCode	Displays the price item code.
priceitemCodeDescr	Displays the description of the price item.
priceAsgnId	Displays the price assignment ID.
priceListStartDate	Displays the date from when the price list of the entity is effective.
priceListEndDate	Displays the date till when the price list of the entity is effective.
priceComponent	Indicates the name of group tag.
priceCompId	Displays the price component ID.
priceCompDescr	Displays the description of the price component.
valueAmt	Displays the value amount of the price component.
tieredFlag	Indicates the tire flag.
pricecomptier	Indicates the name of group tag.
priceItemParmGroupID	Displays the parameter group ID of the price item.
toVal	Indicates the tiering to value of the price item.
fromVal	Indicates the tiering from value of the price item.
timeOfUse	Indicates the tiering time of use.
priceCompPriceItem	Displays the price component of the price item.
priceCriteria	Displays the price criteria of the price item.
priceCompTierId	Displays the price component tier ID.
tieringSeqNum	Indicates the tiering sequence number.
parmString	Indicates the parameter string of the price item.

Related Topics

For more information on...	See...
Sample Market Product View Request and Response in the JSON Format	Sample Market Product View Request and Response in the JSON Format on page 3571
Sample Offer View Request and Response in the JSON Format	Sample Offer View Request and Response in the JSON Format on page 3575
Sample Bundle View Request and Response in the JSON Format	Sample Bundle View Request and Response in the JSON Format on page 3598
Sample Bundle View Summary Request and Response in the JSON Format	Sample Bundle View Summary Request and Response in the JSON Format on page 3620
Sample Bundle View Detail Request and Response in the JSON Format	Sample Bundle View Detail Request and Response in the JSON Format on page 3622

Sample Market Product View Request and Response in the JSON Format

Using the below example, you can view market products which are processed on **2022-01-11**.

Sample Market Product View Request in the JSON Format

```
{
  "C1-GetProdDetail":
  {
    "entityCode": "CHECKMP_001",
    "entityType": "MP",
    "processDate": "2022-03-01",
    "inquiryTypeFlag": "DETL",
    "division": "IND",
  }
}
```

Sample Market Product View Response in the JSON Format

```
{
  "C1-GetProdDetail":
  {
    "entityCode": "CHECKMP_001",
    "entityType": "MP",
    "processDate": "2022-03-01",
    "inquiryTypeFlag": "",
    "division": "IND",
    "entityName": "CHECKMP_001",
    "entityStartDate": "2022-01-11",
    "entityEndDate": "",
    "termsAndCondition": "TERMSPRAAS",
    "status": "ACTIVE",
    "termsAndCondndDescr": "TERMSPRAAS",
    "messageCategory": "0",
    "messageNumber": "0",
    "messageText": "",
    "longDescription": "",
    "productlist":
    {
      "productCode": "LOAN_001",
      "productName": "LOAN_001",
      "prodTypFlg": "Product",
      "productCategoryFlgDesc": "Loans",
    }
  }
  "EntityDivision":
  {
    "divisionCode": "IND",
  }
}
```

```

}
"productLinkedEntity type":
{
  "linkedEntityCode": "",
  "linkedEntityName": "",
  "linkedEntityType": "",
}
"eligibilityDetails":
{
  "eligibilityDescription": "ELG_001",
  "eligibilityStartDate": "2022-01-11",
  "eligibilityEndDate": "",
  "eligibilityRule":
  {
    "rhsPriceParmCd": "",
    "rhsPriceParmVal": "IND",
    "lhsPriceParmCd": "ACC_DIVISION",
    "rhsPriceParmTypeFlg": "VAL",
    "trueFlag": "RLTR",
    "trueFlagDescr": "",
    "falseFlag": "RLFS",
    "falseFlagDescr": "",
    "insufficientFlag": "RLFS",
    "insufficientFlagDescr": "",
    "eligibilityRuleFlg": "",
    "eligibilityDescr": "",
    "operator": "=",
    "priceParmCode": "",
    "sequenceNumber": "10",
  }
  "eligibilityRule":
  {
    "rhsPriceParmCd": "",
    "rhsPriceParmVal": "CA",
    "lhsPriceParmCd": "PERSON_STATE",
    "rhsPriceParmTypeFlg": "VAL",
    "trueFlag": "RLTR",
    "trueFlagDescr": "",
    "falseFlag": "RLTR",
    "falseFlagDescr": "",
    "insufficientFlag": "RLFS",
    "insufficientFlagDescr": "",
    "eligibilityRuleFlg": "",
    "eligibilityDescr": "",
    "operator": "<=",
    "priceParmCode": "",
    "sequenceNumber": "20",
  }
  "eligibilityRule":
  {
    "rhsPriceParmCd": "",
    "rhsPriceParmVal": "USD",
    "lhsPriceParmCd": "ACCOUNT_CURRENCY",
    "rhsPriceParmTypeFlg": "VAL",
    "trueFlag": "RLTR",
    "trueFlagDescr": "",
    "falseFlag": "RLTR",
    "falseFlagDescr": "",
    "insufficientFlag": "RLFS",
    "insufficientFlagDescr": "",
    "eligibilityRuleFlg": "",
    "eligibilityDescr": "",
    "operator": "<>",
    "priceParmCode": "",
  }
}

```



```

        "sequenceNumber": "30",
    }
}
"services":
{
    "serviceCd": "",
    "serviceName": "Product Service PRASS2",
    "mandatoryFlag": "true",
}
"services":
{
    "serviceCd": "",
    "serviceName": "MH division product service",
    "mandatoryFlag": "true",
}
"services":
{
    "serviceCd": "",
    "serviceName": "Product Service PRASS1",
    "mandatoryFlag": "true",
}
"pricing":
{
    "priceListId": "4368251923",
    "priceListDescription": "Currency_Con_PriceList -1",
    "priority": "2",
    "validityFlag": "",
    "noOfDays": "30",
    "priceItemCode": "CC_021",
    "priceitemCodeDescr": "CC_21-Account Opening Fee",
    "priceAsgnId": "4360009281",
    "priceListStartDate": "2022-03-01",
    "priceListEndDate": "2022-03-31",
    "priceComponent":
    {
        "priceCompId": "4367475002",
        "priceCompDescr": "FLAT",
        "valueAmt": "0.400000000000000000",
        "tieredFlag": "",
        "pricecomptier":
        {
            "priceItemParmGroupId": "",
            "toVal": "",
            "fromVal": "",
            "timeOfUse": "",
            "priceCompPriceItem": "",
            "priceCriteria": "",
            "priceCompTierId": "",
            "tieringSeqNum": "",
            "parmString": "",
        }
    }
}
"pricing":
{
    "priceListId": "4368251923",
    "priceListDescription": "Currency_Con_PriceList -1",
    "priority": "2",
    "validityFlag": "",
    "noOfDays": "30",
    "priceItemCode": "CC_022",
    "priceitemCodeDescr": "CC2-Monthly Acct Serv Fee",
    "priceAsgnId": "4360009282",
    "priceListStartDate": "2022-03-01",

```

```

    "priceListEndDate": "2022-03-31",
    "priceComponent":
    {
        "priceCompId": "4367475004",
        "priceCompDescr": "FLAT",
        "valueAmt": "0.600000000000000000",
        "tieredFlag": "",
        "pricecomptier":
        {
            "priceItemParmGroupId": "",
            "toVal": "",
            "fromVal": "",
            "timeOfUse": "",
            "priceCompPriceItem": "",
            "priceCriteria": "",
            "priceCompTierId": "",
            "tieringSeqNum": "",
            "parmString": "",
        }
    }
}
"pricing":
{
    "priceListId": "4368251923",
    "priceListDescription": "Currency_Con_PriceList -1",
    "priority": "2",
    "validityFlag": "",
    "noOfDays": "30",
    "priceItemCode": "CC_024",
    "priceitemCodeDescr": "CC3-SEPA Transfers",
    "priceAsgnId": "4360009283",
    "priceListStartDate": "2022-03-01",
    "priceListEndDate": "2022-03-31",
    "priceComponent":
    {
        "priceCompId": "4367475006",
        "priceCompDescr": "FLAT",
        "valueAmt": "0.250000000000000000",
        "tieredFlag": "",
        "pricecomptier":
        {
            "priceItemParmGroupId": "",
            "toVal": "",
            "fromVal": "",
            "timeOfUse": "",
            "priceCompPriceItem": "",
            "priceCriteria": "",
            "priceCompTierId": "",
            "tieringSeqNum": "",
            "parmString": "",
        }
    }
}
"pricing":
{
    "priceListId": "4368251923",
    "priceListDescription": "Currency_Con_PriceList -1",
    "priority": "2",
    "validityFlag": "",
    "noOfDays": "30",
    "priceItemCode": "CC_025",
    "priceitemCodeDescr": "CC4-Domestic Funds Transfer Fee",
    "priceAsgnId": "4360009284",
    "priceListStartDate": "2022-03-01",

```

```

    "priceListEndDate": "2022-03-31",
    "priceComponent":
    {
      "priceCompId": "4367475008",
      "priceCompDescr": "FLAT",
      "valueAmt": "112.040000000000000000",
      "tieredFlag": "",
      "pricecomptier":
      {
        "priceItemParmGroupId": "",
        "toVal": "",
        "fromVal": "",
        "timeOfUse": "",
        "priceCompPriceItem": "",
        "priceCriteria": "",
        "priceCompTierId": "",
        "tieringSeqNum": "",
        "parmString": "",
      }
    }
  }
}

```

Related Topics

For more information on...	See...
Market Product, Offer, or Bundle View Request and Response - Attribute/Value Pairs in JSON Format	Market Product, Offer, or Bundle View Request and Response - Attribute/Value Pairs in JSON Format on page 3568

Sample Offer View Request and Response in the JSON Format

Using the below example, you can view offers which are processed on **2022-01-11**.

Sample Offer View Request in the JSON Format

```

{
  "C1-GetProdDetail":
  {
    "entityCode": "CHECKOFF_01",
    "entityType": "OFFR",
    "processDate": "2022-02-11",
    "inquiryTypeFlag": "DETL",
    "division": "IND",
  }
}

```

Sample Offer View Response in the JSON Format

```

{
  "C1-GetProdDetail":
  {
    "entityCode": "CHECKOFF_01",
    "entityType": "OFFR",
    "processDate": "2022-02-11",
    "inquiryTypeFlag": "",
    "division": "IND",
    "entityName": "CHECKOFF_01",
    "entityStartDate": "2022-01-11",
    "entityEndDate": "2022-03-31",
    "termsAndCondition": "TERMSPRAAS2",
    "status": "ACTIVE",
    "termsAndCondndDescr": "TERMSPRAAS2",
  }
}

```

```

"messageCategory": "0",
"messageNumber": "0",
"messageText": "",
"longDescription": "",
"productlist":
{
  "productCode": "LOAN_001",
  "productName": "",
  "prodTypFlg": "",
  "productCategoryFlgDesc": "Loans",
}
"EntityDivision":
{
  "divisionCode": "IND",
}
"productLinkedEntity type":
{
  "linkedEntityCode": "CHECKMP_001",
  "linkedEntityName": "",
  "linkedEntityType": "MP",
}
"productLinkedEntity type":
{
  "linkedEntityCode": "CHEKCMP_002",
  "linkedEntityName": "",
  "linkedEntityType": "MP",
}
"productLinkedEntity type":
{
  "linkedEntityCode": "LOANSMP_003",
  "linkedEntityName": "",
  "linkedEntityType": "MP",
}
"productLinkedEntity type":
{
  "linkedEntityCode": "LOANSMP_004",
  "linkedEntityName": "",
  "linkedEntityType": "MP",
}
"eligibilityDetails":
{
  "eligibilityDescription": "ELG_001",
  "eligibilityStartDate": "2022-01-11",
  "eligibilityEndDate": "",
  "eligibilityRule":
  {
    "rhsPriceParmCd": "",
    "rhsPriceParmVal": "IND",
    "lhsPriceParmCd": "ACC_DIVISION",
    "rhsPriceParmTypeFlg": "VAL",
    "trueFlag": "RLTR",
    "trueFlagDescr": "",
    "falseFlag": "RLFS",
    "falseFlagDescr": "",
    "insufficientFlag": "RLFS",
    "insufficientFlagDescr": "",
    "eligibilityRuleFlg": "",
    "eligibilityDescr": "",
    "operator": "=",
    "priceParmCode": "",
    "sequenceNumber": "10",
  }
}
"services":

```

```

{
  "serviceCd": "",
  "serviceName": "Product Service PRASS2",
  "mandatoryFlag": "true",
}
"services":
{
  "serviceCd": "",
  "serviceName": "MH division product service",
  "mandatoryFlag": "true",
}
"services":
{
  "serviceCd": "",
  "serviceName": "Product Service PRASS1",
  "mandatoryFlag": "true",
}
"pricing":
{
  {
    "priceListId": "4368251923",
    "priceListDescription": "Currency_Con_PriceList -1",
    "priority": "1",
    "validityFlag": "",
    "noOfDays": "90",
    "priceItemCode": "CC_021",
    "priceitemCodeDescr": "",
    "priceAsgnId": "4360009281",
    "priceListStartDate": "2022-02-11",
    "priceListEndDate": "2022-05-12",
    "priceComponent":
    {
      "priceCompId": "4367475002",
      "priceCompDescr": "FLAT",
      "valueAmt": "0.400000000000000000",
      "tieredFlag": "",
      "pricecomptier":
      {
        "priceItemParmGroupId": "",
        "toVal": "",
        "fromVal": "",
        "timeOfUse": "",
        "priceCompPriceItem": "",
        "priceCriteria": "",
        "priceCompTierId": "",
        "tieringSeqNum": "",
        "parmString": "",
      }
    }
  }
}
{
  "priceListId": "4368251923",
  "priceListDescription": "Currency_Con_PriceList -1",
  "priority": "1",
  "validityFlag": "",
  "noOfDays": "90",
  "priceItemCode": "CC_022",
  "priceitemCodeDescr": "",
  "priceAsgnId": "4360009282",
  "priceListStartDate": "2022-02-11",
  "priceListEndDate": "2022-05-12",
  "priceComponent":
  {
    "priceCompId": "4367475004",

```

```

        "priceCompDescr": "FLAT",
        "valueAmt": "0.600000000000000000",
        "tieredFlag": "",
        "pricecomptier":
        {
            "priceItemParmGroupId": "",
            "toVal": "",
            "fromVal": "",
            "timeOfUse": "",
            "priceCompPriceItem": "",
            "priceCriteria": "",
            "priceCompTierId": "",
            "tieringSeqNum": "",
            "parmString": "",
        }
    }
}
{
    "priceListId": "4368251923",
    "priceListDescription": "Currency_Con_PriceList -1",
    "priority": "1",
    "validityFlag": "",
    "noOfDays": "90",
    "priceItemCode": "CC_024",
    "priceitemCodeDescr": "",
    "priceAsgnId": "4360009283",
    "priceListStartDate": "2022-02-11",
    "priceListEndDate": "2022-05-12",
    "priceComponent":
    {
        "priceCompId": "4367475006",
        "priceCompDescr": "FLAT",
        "valueAmt": "0.250000000000000000",
        "tieredFlag": "",
        "pricecomptier":
        {
            "priceItemParmGroupId": "",
            "toVal": "",
            "fromVal": "",
            "timeOfUse": "",
            "priceCompPriceItem": "",
            "priceCriteria": "",
            "priceCompTierId": "",
            "tieringSeqNum": "",
            "parmString": "",
        }
    }
}
{
    "priceListId": "4368251923",
    "priceListDescription": "Currency_Con_PriceList -1",
    "priority": "1",
    "validityFlag": "",
    "noOfDays": "90",
    "priceItemCode": "CC_025",
    "priceitemCodeDescr": "",
    "priceAsgnId": "4360009284",
    "priceListStartDate": "2022-02-11",
    "priceListEndDate": "2022-05-12",
    "priceComponent":
    {
        "priceCompId": "4367475008",
        "priceCompDescr": "FLAT",
        "valueAmt": "112.040000000000000000",

```

```

        "tieredFlag": "",
        "pricecomptier":
        {
            "priceItemParmGroupId": "",
            "toVal": "",
            "fromVal": "",
            "timeOfUse": "",
            "priceCompPriceItem": "",
            "priceCriteria": "",
            "priceCompTierId": "",
            "tieringSeqNum": "",
            "parmString": "",
        }
    }
}
{
    "priceListId": "5417730766",
    "priceListDescription": "PriceList -1",
    "priority": "3",
    "validityFlag": "",
    "noOfDays": "60",
    "priceItemCode": "PI_021",
    "priceitemCodeDescr": "",
    "priceAsgnId": "5410009202",
    "priceListStartDate": "2022-02-11",
    "priceListEndDate": "2022-04-12",
    "priceComponent":
    {
        "priceCompId": "5417300004",
        "priceCompDescr": "FLAT",
        "valueAmt": "0.25000000000000000000",
        "tieredFlag": "",
        "pricecomptier":
        {
            "priceItemParmGroupId": "",
            "toVal": "",
            "fromVal": "",
            "timeOfUse": "",
            "priceCompPriceItem": "",
            "priceCriteria": "",
            "priceCompTierId": "",
            "tieringSeqNum": "",
            "parmString": "",
        }
    }
}
{
    "priceListId": "5417730766",
    "priceListDescription": "PriceList -1",
    "priority": "3",
    "validityFlag": "",
    "noOfDays": "60",
    "priceItemCode": "PI_022",
    "priceitemCodeDescr": "",
    "priceAsgnId": "5410009203",
    "priceListStartDate": "2022-02-11",
    "priceListEndDate": "2022-04-12",
    "priceComponent":
    {
        "priceCompId": "5417300006",
        "priceCompDescr": "FLAT",
        "valueAmt": "112.040000000000000000",
        "tieredFlag": "",
        "pricecomptier":

```

```

        {
            "priceItemParmGroupId": "",
            "toVal": "",
            "fromVal": "",
            "timeOfUse": "",
            "priceCompPriceItem": "",
            "priceCriteria": "",
            "priceCompTierId": "",
            "tieringSeqNum": "",
            "parmString": ""
        }
    }
}
{
    "priceListId": "5417730766",
    "priceListDescription": "PriceList -1",
    "priority": "3",
    "validityFlag": "",
    "noOfDays": "60",
    "priceItemCode": "PI_023",
    "priceitemCodeDescr": "",
    "priceAsgnId": "5410009204",
    "priceListStartDate": "2022-02-11",
    "priceListEndDate": "2022-04-12",
    "priceComponent":
    {
        {
            "priceCompId": "5417300008",
            "priceCompDescr": "FLAT",
            "valueAmt": "276.25000000000000000000",
            "tieredFlag": "",
            "pricecomptier":
            {
                "priceItemParmGroupId": "",
                "toVal": "",
                "fromVal": "",
                "timeOfUse": "",
                "priceCompPriceItem": "",
                "priceCriteria": "",
                "priceCompTierId": "",
                "tieringSeqNum": "",
                "parmString": ""
            }
        }
    }
}
{
    "priceListId": "5417730766",
    "priceListDescription": "PriceList -1",
    "priority": "3",
    "validityFlag": "",
    "noOfDays": "60",
    "priceItemCode": "PI_024",
    "priceitemCodeDescr": "",
    "priceAsgnId": "5410009241",
    "priceListStartDate": "2022-02-11",
    "priceListEndDate": "2022-04-12",
    "priceComponent":
    {
        {
            "priceCompId": "5417400004",
            "priceCompDescr": "Price per transaction - Step Tier 1",
            "valueAmt": "12.95000000000000000000",
            "tieredFlag": "",
            "pricecomptier":

```



```

    {
      {
        "priceItemParmGroupId": "1",
        "toVal": "1000.00000000000000000000",
        "fromVal": "0.00000000000000000000",
        "timeOfUse": "",
        "priceCompPriceItem": "",
        "priceCriteria": "NBRTRAN",
        "priceCompTierId": "",
        "tieringSeqNum": "10",
        "parmString": "",
      }
      {
        "priceItemParmGroupId": "1",
        "toVal": "5000.00000000000000000000",
        "fromVal": "1000.00000000000000000000",
        "timeOfUse": "",
        "priceCompPriceItem": "",
        "priceCriteria": "NBRTRAN",
        "priceCompTierId": "",
        "tieringSeqNum": "10",
        "parmString": "",
      }
    }
    {
      "priceItemParmGroupId": "1",
      "toVal": "999999999999.99000000000000000000",
      "fromVal": "5000.00000000000000000000",
      "timeOfUse": "",
      "priceCompPriceItem": "",
      "priceCriteria": "NBRTRAN",
      "priceCompTierId": "",
      "tieringSeqNum": "10",
      "parmString": "",
    }
  }
}
{
  "priceCompId": "5417400005",
  "priceCompDescr": "Price per transaction - Step Tier 2",
  "valueAmt": "12.15000000000000000000",
  "tieredFlag": "",
  "pricecomptier":
  {
    {
      "priceItemParmGroupId": "1",
      "toVal": "1000.00000000000000000000",
      "fromVal": "0.00000000000000000000",
      "timeOfUse": "",
      "priceCompPriceItem": "",
      "priceCriteria": "NBRTRAN",
      "priceCompTierId": "",
      "tieringSeqNum": "10",
      "parmString": "",
    }
    {
      "priceItemParmGroupId": "1",
      "toVal": "5000.00000000000000000000",
      "fromVal": "1000.00000000000000000000",
      "timeOfUse": "",
      "priceCompPriceItem": "",
      "priceCriteria": "NBRTRAN",
      "priceCompTierId": "",
      "tieringSeqNum": "10",
      "parmString": "",
    }
  }
}

```



```

"priceItemCode": "PI_025",
"priceitemCodeDescr": "",
"priceAsgnId": "5410009242",
"priceListStartDate": "2022-02-11",
"priceListEndDate": "2022-04-12",
"priceComponent":
{
  {
    "priceCompId": "5417400010",
    "priceCompDescr": "Threshold price per transaction",
    "valueAmt": "12.950000000000000000",
    "tieredFlag": "",
    "pricemcptier":
    {
      {
        "priceItemParmGroupId": "1",
        "toVal": "1000.000000000000000000",
        "fromVal": "0.000000000000000000",
        "timeOfUse": "",
        "priceCompPriceItem": "",
        "priceCriteria": "NBRTRAN",
        "priceCompTierId": "",
        "tieringSeqNum": "10",
        "parmString": "",
      }
      {
        "priceItemParmGroupId": "1",
        "toVal": "5000.000000000000000000",
        "fromVal": "1000.000000000000000000",
        "timeOfUse": "",
        "priceCompPriceItem": "",
        "priceCriteria": "NBRTRAN",
        "priceCompTierId": "",
        "tieringSeqNum": "10",
        "parmString": "",
      }
    }
  }
  {
    "priceCompId": "5417400011",
    "priceCompDescr": "Threshold price per transaction",
    "valueAmt": "12.150000000000000000",
    "tieredFlag": "",
    "pricemcptier":
    {
      {
        "priceItemParmGroupId": "1",
        "toVal": "1000.000000000000000000",
        "fromVal": "0.000000000000000000",
        "timeOfUse": "",
        "priceCompPriceItem": "",
        "priceCriteria": "NBRTRAN",
        "priceCompTierId": "",

```

```

        "tieringSeqNum": "10",
        "parmString": "",
    }
}
    "priceItemParmGroupId": "1",
    "toVal": "5000.0000000000000000000000",
    "fromVal": "1000.0000000000000000000000",
    "timeOfUse": "",
    "priceCompPriceItem": "",
    "priceCriteria": "NBRTRAN",
    "priceCompTierId": "",
    "tieringSeqNum": "10",
    "parmString": "",
}
}
    "priceItemParmGroupId": "1",
    "toVal": "999999999999.9900000000000000000000",
    "fromVal": "5000.0000000000000000000000",
    "timeOfUse": "",
    "priceCompPriceItem": "",
    "priceCriteria": "NBRTRAN",
    "priceCompTierId": "",
    "tieringSeqNum": "10",
    "parmString": "",
}
}
}
    "priceCompId": "5417400012",
    "priceCompDescr": "Threshold price per transaction",
    "valueAmt": "11.9500000000000000000000",
    "tieredFlag": "",
    "pricecomptier":
    {
        {
            "priceItemParmGroupId": "1",
            "toVal": "1000.0000000000000000000000",
            "fromVal": "0.0000000000000000000000",
            "timeOfUse": "",
            "priceCompPriceItem": "",
            "priceCriteria": "NBRTRAN",
            "priceCompTierId": "",
            "tieringSeqNum": "10",
            "parmString": "",
        }
        {
            "priceItemParmGroupId": "1",
            "toVal": "5000.0000000000000000000000",
            "fromVal": "1000.0000000000000000000000",
            "timeOfUse": "",
            "priceCompPriceItem": "",
            "priceCriteria": "NBRTRAN",
            "priceCompTierId": "",
            "tieringSeqNum": "10",
            "parmString": "",
        }
        {
            "priceItemParmGroupId": "1",
            "toVal": "999999999999.9900000000000000000000",
            "fromVal": "5000.0000000000000000000000",
            "timeOfUse": "",
            "priceCompPriceItem": "",
            "priceCriteria": "NBRTRAN",
            "priceCompTierId": "",
        }
    }
}

```



```

        "timeOfUse": "",
        "priceCompPriceItem": "",
        "priceCriteria": "NBRTRAN",
        "priceCompTierId": "",
        "tieringSeqNum": "10",
        "parmString": "",
    }
}
    "priceItemParmGroupId": "1",
    "toVal": "5000.0000000000000000000000",
    "fromVal": "1000.0000000000000000000000",
    "timeOfUse": "",
    "priceCompPriceItem": "",
    "priceCriteria": "NBRTRAN",
    "priceCompTierId": "",
    "tieringSeqNum": "10",
    "parmString": "",
}
}
    "priceItemParmGroupId": "1",
    "toVal": "999999999999.9900000000000000000000",
    "fromVal": "5000.0000000000000000000000",
    "timeOfUse": "",
    "priceCompPriceItem": "",
    "priceCriteria": "NBRTRAN",
    "priceCompTierId": "",
    "tieringSeqNum": "10",
    "parmString": "",
}
}
}
    "priceCompId": "5417400021",
    "priceCompDescr": "Threshold price",
    "valueAmt": "10.0000000000000000000000",
    "tieredFlag": "",
    "pricecomptier":
    {
        {
            "priceItemParmGroupId": "1",
            "toVal": "1000.0000000000000000000000",
            "fromVal": "0.0000000000000000000000",
            "timeOfUse": "",
            "priceCompPriceItem": "",
            "priceCriteria": "NBRTRAN",
            "priceCompTierId": "",
            "tieringSeqNum": "10",
            "parmString": "",
        }
        {
            "priceItemParmGroupId": "1",
            "toVal": "5000.0000000000000000000000",
            "fromVal": "1000.0000000000000000000000",
            "timeOfUse": "",
            "priceCompPriceItem": "",
            "priceCriteria": "NBRTRAN",
            "priceCompTierId": "",
            "tieringSeqNum": "10",
            "parmString": "",
        }
        {
            "priceItemParmGroupId": "1",
            "toVal": "999999999999.9900000000000000000000",
            "fromVal": "5000.0000000000000000000000",

```

```

        "timeOfUse": "",
        "priceCompPriceItem": "",
        "priceCriteria": "NBRTRAN",
        "priceCompTierId": "",
        "tieringSeqNum": "10",
        "parmString": "",
    }
}
{
    "priceItemParmGroupId": "1",
    "toVal": "1000.00000000000000000000",
    "fromVal": "0.00000000000000000000",
    "timeOfUse": "",
    "priceCompPriceItem": "",
    "priceCriteria": "NBRTRAN",
    "priceCompTierId": "",
    "tieringSeqNum": "10",
    "parmString": "",
}
{
    "priceItemParmGroupId": "1",
    "toVal": "5000.00000000000000000000",
    "fromVal": "1000.00000000000000000000",
    "timeOfUse": "",
    "priceCompPriceItem": "",
    "priceCriteria": "NBRTRAN",
    "priceCompTierId": "",
    "tieringSeqNum": "10",
    "parmString": "",
}
{
    "priceItemParmGroupId": "1",
    "toVal": "99999999999.99000000000000000000",
    "fromVal": "5000.00000000000000000000",
    "timeOfUse": "",
    "priceCompPriceItem": "",
    "priceCriteria": "NBRTRAN",
    "priceCompTierId": "",
    "tieringSeqNum": "10",
    "parmString": "",
}
}
}
{
    "priceCompId": "5417400022",
    "priceCompDescr": "Threshold price",
    "valueAmt": "8.00000000000000000000",
    "tieredFlag": "",
    "pricecomptier":
    {
        {
            "priceItemParmGroupId": "1",
            "toVal": "1000.00000000000000000000",
            "fromVal": "0.00000000000000000000",
            "timeOfUse": "",
            "priceCompPriceItem": "",
            "priceCriteria": "NBRTRAN",
            "priceCompTierId": "",
            "tieringSeqNum": "10",
            "parmString": "",
        }
        {
            "priceItemParmGroupId": "1",
            "toVal": "5000.00000000000000000000",
            "fromVal": "1000.00000000000000000000",

```

```

        "timeOfUse": "",
        "priceCompPriceItem": "",
        "priceCriteria": "NBRTRAN",
        "priceCompTierId": "",
        "tieringSeqNum": "10",
        "parmString": "",
    }
}
{
    "priceItemParmGroupId": "1",
    "toVal": "999999999999.99000000000000000000",
    "fromVal": "5000.00000000000000000000",
    "timeOfUse": "",
    "priceCompPriceItem": "",
    "priceCriteria": "NBRTRAN",
    "priceCompTierId": "",
    "tieringSeqNum": "10",
    "parmString": "",
}
{
    "priceItemParmGroupId": "1",
    "toVal": "1000.00000000000000000000",
    "fromVal": "0.00000000000000000000",
    "timeOfUse": "",
    "priceCompPriceItem": "",
    "priceCriteria": "NBRTRAN",
    "priceCompTierId": "",
    "tieringSeqNum": "10",
    "parmString": "",
}
{
    "priceItemParmGroupId": "1",
    "toVal": "5000.00000000000000000000",
    "fromVal": "1000.00000000000000000000",
    "timeOfUse": "",
    "priceCompPriceItem": "",
    "priceCriteria": "NBRTRAN",
    "priceCompTierId": "",
    "tieringSeqNum": "10",
    "parmString": "",
}
}
{
    "priceItemParmGroupId": "1",
    "toVal": "999999999999.99000000000000000000",
    "fromVal": "5000.00000000000000000000",
    "timeOfUse": "",
    "priceCompPriceItem": "",
    "priceCriteria": "NBRTRAN",
    "priceCompTierId": "",
    "tieringSeqNum": "10",
    "parmString": "",
}
}
}
{
    "priceCompId": "5417400023",
    "priceCompDescr": "Threshold price",
    "valueAmt": "6.00000000000000000000",
    "tieredFlag": "",
    "pricecomptier":
    {
        {
            "priceItemParmGroupId": "1",
            "toVal": "1000.00000000000000000000",
            "fromVal": "0.00000000000000000000",

```



```

{
  "priceCompId": "5417400024",
  "priceCompDescr": "Step 1",
  "valueAmt": "5.000000000000000000",
  "tieredFlag": "",
  "pricecomptier":
  {
    {
      "priceItemParmGroupId": "1",
      "toVal": "1000.000000000000000000",
      "fromVal": "0.000000000000000000",
      "timeOfUse": "",
      "priceCompPriceItem": "",
      "priceCriteria": "NBRTRAN",
      "priceCompTierId": "",
      "tieringSeqNum": "10",
      "parmString": "",
    }
    {
      "priceItemParmGroupId": "1",
      "toVal": "5000.000000000000000000",
      "fromVal": "1000.000000000000000000",
      "timeOfUse": "",
      "priceCompPriceItem": "",
      "priceCriteria": "NBRTRAN",
      "priceCompTierId": "",
      "tieringSeqNum": "10",
      "parmString": "",
    }
    {
      "priceItemParmGroupId": "1",
      "toVal": "99999999999.990000000000000000",
      "fromVal": "5000.000000000000000000",
      "timeOfUse": "",
      "priceCompPriceItem": "",
      "priceCriteria": "NBRTRAN",
      "priceCompTierId": "",
      "tieringSeqNum": "10",
      "parmString": "",
    }
    {
      "priceItemParmGroupId": "1",
      "toVal": "1000.000000000000000000",
      "fromVal": "0.000000000000000000",
      "timeOfUse": "",
      "priceCompPriceItem": "",
      "priceCriteria": "NBRTRAN",
      "priceCompTierId": "",
      "tieringSeqNum": "10",
      "parmString": "",
    }
    {
      "priceItemParmGroupId": "1",
      "toVal": "5000.000000000000000000",
      "fromVal": "1000.000000000000000000",
      "timeOfUse": "",
      "priceCompPriceItem": "",
      "priceCriteria": "NBRTRAN",
      "priceCompTierId": "",
      "tieringSeqNum": "10",
      "parmString": "",
    }
    {
      "priceItemParmGroupId": "1",
    }
  }
}

```

```

        "toVal": "999999999999.99000000000000000000",
        "fromVal": "5000.00000000000000000000",
        "timeOfUse": "",
        "priceCompPriceItem": "",
        "priceCriteria": "NBRTRAN",
        "priceCompTierId": "",
        "tieringSeqNum": "10",
        "parmString": "",
    }
}
}
{
    "priceCompId": "5417400025",
    "priceCompDescr": "Step 2",
    "valueAmt": "4.00000000000000000000",
    "tieredFlag": "",
    "pricecomptier":
    {
        {
            "priceItemParmGroupId": "1",
            "toVal": "1000.00000000000000000000",
            "fromVal": "0.00000000000000000000",
            "timeOfUse": "",
            "priceCompPriceItem": "",
            "priceCriteria": "NBRTRAN",
            "priceCompTierId": "",
            "tieringSeqNum": "10",
            "parmString": "",
        }
        {
            "priceItemParmGroupId": "1",
            "toVal": "5000.00000000000000000000",
            "fromVal": "1000.00000000000000000000",
            "timeOfUse": "",
            "priceCompPriceItem": "",
            "priceCriteria": "NBRTRAN",
            "priceCompTierId": "",
            "tieringSeqNum": "10",
            "parmString": "",
        }
    }
    {
        "priceItemParmGroupId": "1",
        "toVal": "999999999999.99000000000000000000",
        "fromVal": "5000.00000000000000000000",
        "timeOfUse": "",
        "priceCompPriceItem": "",
        "priceCriteria": "NBRTRAN",
        "priceCompTierId": "",
        "tieringSeqNum": "10",
        "parmString": "",
    }
}
{
    "priceItemParmGroupId": "1",
    "toVal": "1000.00000000000000000000",
    "fromVal": "0.00000000000000000000",
    "timeOfUse": "",
    "priceCompPriceItem": "",
    "priceCriteria": "NBRTRAN",
    "priceCompTierId": "",
    "tieringSeqNum": "10",
    "parmString": "",
}
}
    "priceItemParmGroupId": "1",

```

```

        "toVal": "5000.00000000000000000000",
        "fromVal": "1000.00000000000000000000",
        "timeOfUse": "",
        "priceCompPriceItem": "",
        "priceCriteria": "NBRTRAN",
        "priceCompTierId": "",
        "tieringSeqNum": "10",
        "parmString": "",
    }
}
{
    "priceItemParmGroupId": "1",
    "toVal": "999999999999.99000000000000000000",
    "fromVal": "5000.00000000000000000000",
    "timeOfUse": "",
    "priceCompPriceItem": "",
    "priceCriteria": "NBRTRAN",
    "priceCompTierId": "",
    "tieringSeqNum": "10",
    "parmString": "",
}
}
}
{
    "priceCompId": "5417400026",
    "priceCompDescr": "Step 3",
    "valueAmt": "3.00000000000000000000",
    "tieredFlag": "",
    "pricecomptier":
    {
        {
            "priceItemParmGroupId": "1",
            "toVal": "1000.00000000000000000000",
            "fromVal": "0.00000000000000000000",
            "timeOfUse": "",
            "priceCompPriceItem": "",
            "priceCriteria": "NBRTRAN",
            "priceCompTierId": "",
            "tieringSeqNum": "10",
            "parmString": "",
        }
        {
            "priceItemParmGroupId": "1",
            "toVal": "5000.00000000000000000000",
            "fromVal": "1000.00000000000000000000",
            "timeOfUse": "",
            "priceCompPriceItem": "",
            "priceCriteria": "NBRTRAN",
            "priceCompTierId": "",
            "tieringSeqNum": "10",
            "parmString": "",
        }
    }
}
{
    "priceItemParmGroupId": "1",
    "toVal": "999999999999.99000000000000000000",
    "fromVal": "5000.00000000000000000000",
    "timeOfUse": "",
    "priceCompPriceItem": "",
    "priceCriteria": "NBRTRAN",
    "priceCompTierId": "",
    "tieringSeqNum": "10",
    "parmString": "",
}
}
{
    "priceItemParmGroupId": "1",

```



```

    }
  }
  {
    "priceListId": "5417730766",
    "priceListDescription": "PriceList -1",
    "priority": "3",
    "validityFlag": "",
    "noOfDays": "60",
    "priceItemCode": "PI_028",
    "priceitemCodeDescr": "",
    "priceAsgnId": "5410009210",
    "priceListStartDate": "2022-02-11",
    "priceListEndDate": "2022-04-12",
    "priceComponent":
    {
      "priceCompId": "5417300040",
      "priceCompDescr": "Basic BK-NBR",
      "valueAmt": "0.75000000000000000000",
      "tieredFlag": "",
      "pricecomptier":
      {
        "priceItemParmGroupId": "",
        "toVal": "",
        "fromVal": "",
        "timeOfUse": "",
        "priceCompPriceItem": "",
        "priceCriteria": "",
        "priceCompTierId": "",
        "tieringSeqNum": "",
        "parmString": "",
      }
    }
  }
  {
    "priceListId": "5417730766",
    "priceListDescription": "PriceList -1",
    "priority": "3",
    "validityFlag": "",
    "noOfDays": "60",
    "priceItemCode": "PI_028",
    "priceitemCodeDescr": "",
    "priceAsgnId": "5410009211",
    "priceListStartDate": "2022-02-11",
    "priceListEndDate": "2022-04-12",
    "priceComponent":
    {
      "priceCompId": "5417300042",
      "priceCompDescr": "FLAT",
      "valueAmt": "6.67000000000000000000",
      "tieredFlag": "",
      "pricecomptier":
      {
        "priceItemParmGroupId": "",
        "toVal": "",
        "fromVal": "",
        "timeOfUse": "",
        "priceCompPriceItem": "",
        "priceCriteria": "",
        "priceCompTierId": "",
        "tieringSeqNum": "",
        "parmString": "",
      }
    }
  }
}

```

```

{
  "priceListId": "5417730766",
  "priceListDescription": "PriceList -1",
  "priority": "3",
  "validityFlag": "",
  "noOfDays": "60",
  "priceItemCode": "PI_028",
  "priceitemCodeDescr": "",
  "priceAsgnId": "5410009212",
  "priceListStartDate": "2022-02-11",
  "priceListEndDate": "2022-04-12",
  "priceComponent":
  {
    "priceCompId": "5417300044",
    "priceCompDescr": "FLAT",
    "valueAmt": "0.30000000000000000000",
    "tieredFlag": "",
    "pricecomptier":
    {
      "priceItemParmGroupId": "",
      "toVal": "",
      "fromVal": "",
      "timeOfUse": "",
      "priceCompPriceItem": "",
      "priceCriteria": "",
      "priceCompTierId": "",
      "tieringSeqNum": "",
      "parmString": ""
    }
  }
}
{
  "priceListId": "5417730766",
  "priceListDescription": "PriceList -1",
  "priority": "3",
  "validityFlag": "",
  "noOfDays": "60",
  "priceItemCode": "PI_028",
  "priceitemCodeDescr": "",
  "priceAsgnId": "5410009213",
  "priceListStartDate": "2022-02-11",
  "priceListEndDate": "2022-04-12",
  "priceComponent":
  {
    "priceCompId": "5417300046",
    "priceCompDescr": "FLAT",
    "valueAmt": "2.05000000000000000000",
    "tieredFlag": "",
    "pricecomptier":
    {
      "priceItemParmGroupId": "",
      "toVal": "",
      "fromVal": "",
      "timeOfUse": "",
      "priceCompPriceItem": "",
      "priceCriteria": "",
      "priceCompTierId": "",
      "tieringSeqNum": "",
      "parmString": ""
    }
  }
}
{
  "priceListId": "5417730766",

```

```

    "priceListDescription": "PriceList -1",
    "priority": "3",
    "validityFlag": "",
    "noOfDays": "60",
    "priceItemCode": "PI_029",
    "priceitemCodeDescr": "",
    "priceAsgnId": "5410009214",
    "priceListStartDate": "2022-02-11",
    "priceListEndDate": "2022-04-12",
    "priceComponent":
    {
      "priceCompId": "5417300048",
      "priceCompDescr": "FLAT",
      "valueAmt": "0.40000000000000000000",
      "tieredFlag": "",
      "pricecomptier":
      {
        "priceItemParmGroupId": "",
        "toVal": "",
        "fromVal": "",
        "timeOfUse": "",
        "priceCompPriceItem": "",
        "priceCriteria": "",
        "priceCompTierId": "",
        "tieringSeqNum": "",
        "parmString": "",
      }
    }
  }
  {
    "priceListId": "5417730766",
    "priceListDescription": "PriceList -1",
    "priority": "3",
    "validityFlag": "",
    "noOfDays": "60",
    "priceItemCode": "PI_030",
    "priceitemCodeDescr": "",
    "priceAsgnId": "5410009215",
    "priceListStartDate": "2022-02-11",
    "priceListEndDate": "2022-04-12",
    "priceComponent":
    {
      "priceCompId": "5417300050",
      "priceCompDescr": "FLAT",
      "valueAmt": "0.60000000000000000000",
      "tieredFlag": "",
      "pricecomptier":
      {
        "priceItemParmGroupId": "",
        "toVal": "",
        "fromVal": "",
        "timeOfUse": "",
        "priceCompPriceItem": "",
        "priceCriteria": "",
        "priceCompTierId": "",
        "tieringSeqNum": "",
        "parmString": "",
      }
    }
  }
  {
    "priceListId": "5417730766",
    "priceListDescription": "PriceList -1",
    "priority": "3",

```

For more information on...	See...
Market Product, Offer, or Bundle View Request and Response - Attribute/Value Pairs in JSON Format	Market Product, Offer, or Bundle View Request and Response - Attribute/Value Pairs in JSON Format on page 3568

Sample Bundle View Request and Response in the JSON Format

Using the below example, you can view bundles which are processed on the date 2022-01-11.

Sample Bundle View Request in the JSON Format

```
{
  "C1-GetProdDetail":
  {
    "entityCode": "CHECKBUND_003",
    "entityType": "BNDL",
    "processDate": "2022-02-11",
    "inquiryTypeFlag": "DETL",
    "division": "IND",
  }
}
```

Sample Bundle View Response in the JSON Format

```
{
  "C1-GetProdDetail":
  {
    "entityCode": "CHECKBUND_003",
    "entityType": "BNDL",
    "processDate": "2022-02-11",
    "inquiryTypeFlag": "",
    "division": "IND",
  }
  "viewResponse":
  {
    "entityName": "CHECKBUND_003",
    "entityStartDate": "2022-01-11",
    "entityEndDate": "",
    "termsAndCondition": "TERMSPRAAS",
    "status": "ACTIVE",
    "termsAndCondndescrip": "TERMSPRAAS",
    "messageCategory": "0",
    "messageNumber": "0",
    "messageText": "",
    "longDescription": "",
    "productlist":
    {
      "productCode": "LOAN_001",
      "productName": "LOAN_001",
      "prodTypFlg": "PROD",
      "productCategoryFlgDesc": "Loans",
    }
    "EntityDivision":
    {
      "divisionCode": "IND",
    }
    "productLinkedEntity":
    {
      {
        "linkedEntityCode": "CHECKMP_001",
        "linkedEntityName": "CHECKMP_001",
        "linkedEntityType": "MP",
      }
    }
  }
}
```

```

        "linkedEntityCode": "CHEKCMP_002",
        "linkedEntityName": "CHEKCMP_002",
        "linkedEntityType": "MP",
    }
}
"eligibilityDetails":
{
    "eligibilityDescription": "LOANDBUND_001",
    "eligibilityStartDate": "2022-01-11",
    "eligibilityEndDate": "",
    "eligibilityRule":
    {
        "rhsPriceParmCd": "",
        "rhsPriceParmVal": "MH",
        "lhsPriceParmCd": "ACC_DIVISION",
        "rhsPriceParmTypeFlg": "VAL",
        "trueFlag": "RLTR",
        "trueFlagDescr": "",
        "falseFlag": "RLFS",
        "falseFlagDescr": "",
        "insufficientFlag": "RLFS",
        "insufficientFlagDescr": "",
        "eligibilityRuleFlg": "",
        "eligibilityDescr": "",
        "operator": "=",
        "priceParmCode": "",
        "sequenceNumber": "10",
    }
}
"services":
{
    "serviceCd": "",
    "serviceName": "Product Service PRASS2",
    "mandatoryFlag": "true",
}
"services":
{
    "serviceCd": "",
    "serviceName": "MH division product service",
    "mandatoryFlag": "true",
}
"services":
{
    "serviceCd": "",
    "serviceName": "Product Service PRASS1",
    "mandatoryFlag": "true",
}
"pricing":
{
    "priceListId": "4368251923",
    "priceListDescription": "Currency_Con_PriceList -1",
    "priority": "1",
    "validityFlag": "",
    "noOfDays": "30",
    "priceItemCode": "CC_021",
    "priceitemCodeDescr": "CC_21-Account Opening Fee",
    "priceAsgnId": "4360009281",
    "priceListStartDate": "2022-02-11",
    "priceListEndDate": "2022-03-13",
    "priceComponent":
    {
        "priceCompId": "4367475002",
        "priceCompDescr": "FLAT",
        "valueAmt": "0.40000000000000000000",
    }
}

```

```

        "tieredFlag": "",
        "pricecomptier":
        {
            "priceItemParmGroupId": "",
            "toVal": "",
            "fromVal": "",
            "timeOfUse": "",
            "priceCompPriceItem": "",
            "priceCriteria": "",
            "priceCompTierId": "",
            "tieringSeqNum": "",
            "parmString": "",
        }
    }
}
"pricing":
{
    "priceListId": "4368251923",
    "priceListDescription": "Currency_Con_PriceList -1",
    "priority": "1",
    "validityFlag": "",
    "noOfDays": "30",
    "priceItemCode": "CC_022",
    "priceitemCodeDescr": "CC2-Monthly Acct Serv Fee",
    "priceAsgnId": "4360009282",
    "priceListStartDate": "2022-02-11",
    "priceListEndDate": "2022-03-13",
    "priceComponent":
    {
        "priceCompId": "4367475004",
        "priceCompDescr": "FLAT",
        "valueAmt": "0.60000000000000000000",
        "tieredFlag": "",
        "pricecomptier":
        {
            "priceItemParmGroupId": "",
            "toVal": "",
            "fromVal": "",
            "timeOfUse": "",
            "priceCompPriceItem": "",
            "priceCriteria": "",
            "priceCompTierId": "",
            "tieringSeqNum": "",
            "parmString": "",
        }
    }
}
"pricing":
{
    "priceListId": "4368251923",
    "priceListDescription": "Currency_Con_PriceList -1",
    "priority": "1",
    "validityFlag": "",
    "noOfDays": "30",
    "priceItemCode": "CC_024",
    "priceitemCodeDescr": "CC3-SEPA Transfers",
    "priceAsgnId": "4360009283",
    "priceListStartDate": "2022-02-11",
    "priceListEndDate": "2022-03-13",
    "priceComponent":
    {
        "priceCompId": "4367475006",
        "priceCompDescr": "FLAT",
        "valueAmt": "0.25000000000000000000",

```

```

        "tieredFlag": "",
        "pricecomptier":
        {
            "priceItemParmGroupId": "",
            "toVal": "",
            "fromVal": "",
            "timeOfUse": "",
            "priceCompPriceItem": "",
            "priceCriteria": "",
            "priceCompTierId": "",
            "tieringSeqNum": "",
            "parmString": "",
        }
    }
}
"pricing":
{
    "priceListId": "4368251923",
    "priceListDescription": "Currency_Con_PriceList -1",
    "priority": "1",
    "validityFlag": "",
    "noOfDays": "30",
    "priceItemCode": "CC_025",
    "priceitemCodeDescr": "CC4-Domestic Funds Transfer Fee",
    "priceAsgnId": "4360009284",
    "priceListStartDate": "2022-02-11",
    "priceListEndDate": "2022-03-13",
    "priceComponent":
    {
        "priceCompId": "4367475008",
        "priceCompDescr": "FLAT",
        "valueAmt": "112.040000000000000000",
        "tieredFlag": "",
        "pricecomptier":
        {
            "priceItemParmGroupId": "",
            "toVal": "",
            "fromVal": "",
            "timeOfUse": "",
            "priceCompPriceItem": "",
            "priceCriteria": "",
            "priceCompTierId": "",
            "tieringSeqNum": "",
            "parmString": "",
        }
    }
}
"pricing":
{
    "priceListId": "5417730766",
    "priceListDescription": "PriceList -1",
    "priority": "2",
    "validityFlag": "",
    "noOfDays": "10",
    "priceItemCode": "PI_021",
    "priceitemCodeDescr": "V1-Account Opening Fee",
    "priceAsgnId": "5410009202",
    "priceListStartDate": "2022-02-11",
    "priceListEndDate": "2022-02-21",
    "priceComponent":
    {
        "priceCompId": "5417300004",
        "priceCompDescr": "FLAT",
        "valueAmt": "0.250000000000000000",
    }
}

```

```

        "tieredFlag": "",
        "pricecomptier":
        {
            "priceItemParmGroupId": "",
            "toVal": "",
            "fromVal": "",
            "timeOfUse": "",
            "priceCompPriceItem": "",
            "priceCriteria": "",
            "priceCompTierId": "",
            "tieringSeqNum": "",
            "parmString": "",
        }
    }
}
"pricing":
{
    "priceListId": "5417730766",
    "priceListDescription": "PriceList -1",
    "priority": "2",
    "validityFlag": "",
    "noOfDays": "10",
    "priceItemCode": "PI_022",
    "priceitemCodeDescr": "V2-Monthly Acct Serv Fee",
    "priceAsgnId": "5410009203",
    "priceListStartDate": "2022-02-11",
    "priceListEndDate": "2022-02-21",
    "priceComponent":
    {
        "priceCompId": "5417300006",
        "priceCompDescr": "FLAT",
        "valueAmt": "112.040000000000000000",
        "tieredFlag": "",
        "pricecomptier":
        {
            "priceItemParmGroupId": "",
            "toVal": "",
            "fromVal": "",
            "timeOfUse": "",
            "priceCompPriceItem": "",
            "priceCriteria": "",
            "priceCompTierId": "",
            "tieringSeqNum": "",
            "parmString": "",
        }
    }
}
"pricing":
{
    "priceListId": "5417730766",
    "priceListDescription": "PriceList -1",
    "priority": "2",
    "validityFlag": "",
    "noOfDays": "10",
    "priceItemCode": "PI_023",
    "priceitemCodeDescr": "V3-Audit Reports",
    "priceAsgnId": "5410009204",
    "priceListStartDate": "2022-02-11",
    "priceListEndDate": "2022-02-21",
    "priceComponent":
    {
        "priceCompId": "5417300008",
        "priceCompDescr": "FLAT",
        "valueAmt": "276.250000000000000000",

```

```

        "tieredFlag": "",
        "pricecomptier":
        {
            "priceItemParmGroupId": "",
            "toVal": "",
            "fromVal": "",
            "timeOfUse": "",
            "priceCompPriceItem": "",
            "priceCriteria": "",
            "priceCompTierId": "",
            "tieringSeqNum": "",
            "parmString": "",
        }
    }
}
{
    "priceListId": "5417730766",
    "priceListDescription": "PriceList -1",
    "priority": "2",
    "validityFlag": "",
    "noOfDays": "10",
    "priceItemCode": "PI_024",
    "priceitemCodeDescr": "V4-SEPA Transfers",
    "priceAsgnId": "5410009241",
    "priceListStartDate": "2022-02-11",
    "priceListEndDate": "2022-02-21",
    "priceComponent":
    {
        {
            "priceCompId": "5417400004",
            "priceCompDescr": "Price per transaction - Step Tier 1",
            "valueAmt": "12.950000000000000000",
            "tieredFlag": "",
            "pricecomptier":
            {
                {
                    "priceItemParmGroupId": "1",
                    "toVal": "1000.000000000000000000",
                    "fromVal": "0.000000000000000000",
                    "timeOfUse": "",
                    "priceCompPriceItem": "PI_024",
                    "priceCriteria": "NBRTRAN",
                    "priceCompTierId": "",
                    "tieringSeqNum": "10",
                    "parmString": "",
                }
            }
            {
                "priceItemParmGroupId": "1",
                "toVal": "5000.000000000000000000",
                "fromVal": "1000.000000000000000000",
                "timeOfUse": "",
                "priceCompPriceItem": "PI_024",
                "priceCriteria": "NBRTRAN",
                "priceCompTierId": "",
                "tieringSeqNum": "10",
                "parmString": "",
            }
        }
        {
            "priceItemParmGroupId": "1",
            "toVal": "999999999999.990000000000000000",
            "fromVal": "5000.000000000000000000",
            "timeOfUse": "",
            "priceCompPriceItem": "PI_024",
            "priceCriteria": "NBRTRAN",
        }
    }
}

```

```

        "priceCompTierId": "",
        "tieringSeqNum": "10",
        "parmString": "",
    }
}
}
{
    "priceCompId": "5417400005",
    "priceCompDescr": "Price per transaction - Step Tier 2",
    "valueAmt": "12.150000000000000000",
    "tieredFlag": "",
    "pricecomptier":
    {
        {
            "priceItemParmGroupId": "1",
            "toVal": "1000.000000000000000000",
            "fromVal": "0.000000000000000000",
            "timeOfUse": "",
            "priceCompPriceItem": "PI_024",
            "priceCriteria": "NBRTRAN",
            "priceCompTierId": "",
            "tieringSeqNum": "10",
            "parmString": "",
        }
        {
            "priceItemParmGroupId": "1",
            "toVal": "5000.000000000000000000",
            "fromVal": "1000.000000000000000000",
            "timeOfUse": "",
            "priceCompPriceItem": "PI_024",
            "priceCriteria": "NBRTRAN",
            "priceCompTierId": "",
            "tieringSeqNum": "10",
            "parmString": "",
        }
        {
            "priceItemParmGroupId": "1",
            "toVal": "999999999999.990000000000000000",
            "fromVal": "5000.000000000000000000",
            "timeOfUse": "",
            "priceCompPriceItem": "PI_024",
            "priceCriteria": "NBRTRAN",
            "priceCompTierId": "",
            "tieringSeqNum": "10",
            "parmString": "",
        }
    }
}
{
    "priceCompId": "5417400006",
    "priceCompDescr": "Price per transaction - Step Tier 3",
    "valueAmt": "11.950000000000000000",
    "tieredFlag": "",
    "pricecomptier":
    {
        {
            "priceItemParmGroupId": "1",
            "toVal": "1000.000000000000000000",
            "fromVal": "0.000000000000000000",
            "timeOfUse": "",
            "priceCompPriceItem": "PI_024",
            "priceCriteria": "NBRTRAN",
            "priceCompTierId": "",
            "tieringSeqNum": "10",

```



```

        "parmString": "",
    }
}
    "priceItemParmGroupId": "1",
    "toVal": "5000.000000000000000000000000",
    "fromVal": "1000.000000000000000000000000",
    "timeOfUse": "",
    "priceCompPriceItem": "PI_024",
    "priceCriteria": "NBRTRAN",
    "priceCompTierId": "",
    "tieringSeqNum": "10",
    "parmString": "",
}
}
    "priceItemParmGroupId": "1",
    "toVal": "999999999999.990000000000000000000000",
    "fromVal": "5000.000000000000000000000000",
    "timeOfUse": "",
    "priceCompPriceItem": "PI_024",
    "priceCriteria": "NBRTRAN",
    "priceCompTierId": "",
    "tieringSeqNum": "10",
    "parmString": "",
}
}
}
}
}
    "priceListId": "5417730766",
    "priceListDescription": "PriceList -1",
    "priority": "2",
    "validityFlag": "",
    "noOfDays": "10",
    "priceItemCode": "PI_025",
    "priceitemCodeDescr": "V5-Domestic Funds Transfer Fee",
    "priceAsgnId": "5410009242",
    "priceListStartDate": "2022-02-11",
    "priceListEndDate": "2022-02-21",
    "priceComponent":
    {
        {
            "priceCompId": "5417400010",
            "priceCompDescr": "Threshold price per transaction",
            "valueAmt": "12.950000000000000000000000",
            "tieredFlag": "",
            "pricecomptier":
            {
                {
                    "priceItemParmGroupId": "1",
                    "toVal": "1000.000000000000000000000000",
                    "fromVal": "0.000000000000000000000000",
                    "timeOfUse": "",
                    "priceCompPriceItem": "PI_025",
                    "priceCriteria": "NBRTRAN",
                    "priceCompTierId": "",
                    "tieringSeqNum": "10",
                    "parmString": "",
                }
            }
        }
        "priceItemParmGroupId": "1",
        "toVal": "5000.000000000000000000000000",
        "fromVal": "1000.000000000000000000000000",
        "timeOfUse": "",
    }
}

```

```

        "priceCompPriceItem": "PI_025",
        "priceCriteria": "NBRTRAN",
        "priceCompTierId": "",
        "tieringSeqNum": "10",
        "parmString": "",
    }
}
{
    "priceItemParmGroupId": "1",
    "toVal": "999999999999.99000000000000000000",
    "fromVal": "5000.00000000000000000000",
    "timeOfUse": "",
    "priceCompPriceItem": "PI_025",
    "priceCriteria": "NBRTRAN",
    "priceCompTierId": "",
    "tieringSeqNum": "10",
    "parmString": "",
}
}
}
{
    "priceCompId": "5417400011",
    "priceCompDescr": "Threshold price per transaction",
    "valueAmt": "12.15000000000000000000",
    "tieredFlag": "",
    "pricecomptier":
    {
        {
            "priceItemParmGroupId": "1",
            "toVal": "1000.00000000000000000000",
            "fromVal": "0.00000000000000000000",
            "timeOfUse": "",
            "priceCompPriceItem": "PI_025",
            "priceCriteria": "NBRTRAN",
            "priceCompTierId": "",
            "tieringSeqNum": "10",
            "parmString": "",
        }
    }
    {
        "priceItemParmGroupId": "1",
        "toVal": "5000.00000000000000000000",
        "fromVal": "1000.00000000000000000000",
        "timeOfUse": "",
        "priceCompPriceItem": "PI_025",
        "priceCriteria": "NBRTRAN",
        "priceCompTierId": "",
        "tieringSeqNum": "10",
        "parmString": "",
    }
}
}
}
{
    "priceItemParmGroupId": "1",
    "toVal": "999999999999.99000000000000000000",
    "fromVal": "5000.00000000000000000000",
    "timeOfUse": "",
    "priceCompPriceItem": "PI_025",
    "priceCriteria": "NBRTRAN",
    "priceCompTierId": "",
    "tieringSeqNum": "10",
    "parmString": "",
}
}
}
}
{
    "priceCompId": "5417400012",
    "priceCompDescr": "Threshold price per transaction",

```



```

        "fromVal": "0.000000000000000000",
        "timeOfUse": "",
        "priceCompPriceItem": "PI_026",
        "priceCriteria": "NBRTRAN",
        "priceCompTierId": "",
        "tieringSeqNum": "10",
        "parmString": "",
    }
}
{
    "priceItemParmGroupId": "1",
    "toVal": "5000.000000000000000000",
    "fromVal": "1000.000000000000000000",
    "timeOfUse": "",
    "priceCompPriceItem": "PI_026",
    "priceCriteria": "NBRTRAN",
    "priceCompTierId": "",
    "tieringSeqNum": "10",
    "parmString": "",
}
{
    "priceItemParmGroupId": "1",
    "toVal": "999999999999.990000000000000000",
    "fromVal": "5000.000000000000000000",
    "timeOfUse": "",
    "priceCompPriceItem": "PI_026",
    "priceCriteria": "NBRTRAN",
    "priceCompTierId": "",
    "tieringSeqNum": "10",
    "parmString": "",
}
{
    "priceItemParmGroupId": "1",
    "toVal": "1000.000000000000000000",
    "fromVal": "0.000000000000000000",
    "timeOfUse": "",
    "priceCompPriceItem": "PI_026",
    "priceCriteria": "NBRTRAN",
    "priceCompTierId": "",
    "tieringSeqNum": "10",
    "parmString": "",
}
{
    "priceItemParmGroupId": "1",
    "toVal": "5000.000000000000000000",
    "fromVal": "1000.000000000000000000",
    "timeOfUse": "",
    "priceCompPriceItem": "PI_026",
    "priceCriteria": "NBRTRAN",
    "priceCompTierId": "",
    "tieringSeqNum": "10",
    "parmString": "",
}
{
    "priceItemParmGroupId": "1",
    "toVal": "999999999999.990000000000000000",
    "fromVal": "5000.000000000000000000",
    "timeOfUse": "",
    "priceCompPriceItem": "PI_026",
    "priceCriteria": "NBRTRAN",
    "priceCompTierId": "",
    "tieringSeqNum": "10",
    "parmString": "",
}
}

```

```

}
{
  "priceCompId": "5417400021",
  "priceCompDescr": "Threshold price",
  "valueAmt": "10.000000000000000000",
  "tieredFlag": "",
  "pricecomptier":
  {
    {
      "priceItemParmGroupId": "1",
      "toVal": "1000.000000000000000000",
      "fromVal": "0.000000000000000000",
      "timeOfUse": "",
      "priceCompPriceItem": "PI_026",
      "priceCriteria": "NBRTRAN",
      "priceCompTierId": "",
      "tieringSeqNum": "10",
      "parmString": "",
    }
    {
      "priceItemParmGroupId": "1",
      "toVal": "5000.000000000000000000",
      "fromVal": "1000.000000000000000000",
      "timeOfUse": "",
      "priceCompPriceItem": "PI_026",
      "priceCriteria": "NBRTRAN",
      "priceCompTierId": "",
      "tieringSeqNum": "10",
      "parmString": "",
    }
  }
  {
    "priceItemParmGroupId": "1",
    "toVal": "99999999999.990000000000000000",
    "fromVal": "5000.000000000000000000",
    "timeOfUse": "",
    "priceCompPriceItem": "PI_026",
    "priceCriteria": "NBRTRAN",
    "priceCompTierId": "",
    "tieringSeqNum": "10",
    "parmString": "",
  }
  {
    "priceItemParmGroupId": "1",
    "toVal": "1000.000000000000000000",
    "fromVal": "0.000000000000000000",
    "timeOfUse": "",
    "priceCompPriceItem": "PI_026",
    "priceCriteria": "NBRTRAN",
    "priceCompTierId": "",
    "tieringSeqNum": "10",
    "parmString": "",
  }
  {
    "priceItemParmGroupId": "1",
    "toVal": "5000.000000000000000000",
    "fromVal": "1000.000000000000000000",
    "timeOfUse": "",
    "priceCompPriceItem": "PI_026",
    "priceCriteria": "NBRTRAN",
    "priceCompTierId": "",
    "tieringSeqNum": "10",
    "parmString": "",
  }
}
}

```

```

        "priceItemParmGroupId": "1",
        "toVal": "99999999999.99000000000000000000",
        "fromVal": "5000.00000000000000000000",
        "timeOfUse": "",
        "priceCompPriceItem": "PI_026",
        "priceCriteria": "NBRTRAN",
        "priceCompTierId": "",
        "tieringSeqNum": "10",
        "parmString": "",
    }
}
}
{
    "priceCompId": "5417400022",
    "priceCompDescr": "Threshold price",
    "valueAmt": "8.00000000000000000000",
    "tieredFlag": "",
    "priccomptier":
    {
        {
            "priceItemParmGroupId": "1",
            "toVal": "1000.00000000000000000000",
            "fromVal": "0.00000000000000000000",
            "timeOfUse": "",
            "priceCompPriceItem": "PI_026",
            "priceCriteria": "NBRTRAN",
            "priceCompTierId": "",
            "tieringSeqNum": "10",
            "parmString": "",
        }
        {
            "priceItemParmGroupId": "1",
            "toVal": "5000.00000000000000000000",
            "fromVal": "1000.00000000000000000000",
            "timeOfUse": "",
            "priceCompPriceItem": "PI_026",
            "priceCriteria": "NBRTRAN",
            "priceCompTierId": "",
            "tieringSeqNum": "10",
            "parmString": "",
        }
        {
            "priceItemParmGroupId": "1",
            "toVal": "99999999999.99000000000000000000",
            "fromVal": "5000.00000000000000000000",
            "timeOfUse": "",
            "priceCompPriceItem": "PI_026",
            "priceCriteria": "NBRTRAN",
            "priceCompTierId": "",
            "tieringSeqNum": "10",
            "parmString": "",
        }
        {
            "priceItemParmGroupId": "1",
            "toVal": "1000.00000000000000000000",
            "fromVal": "0.00000000000000000000",
            "timeOfUse": "",
            "priceCompPriceItem": "PI_026",
            "priceCriteria": "NBRTRAN",
            "priceCompTierId": "",
            "tieringSeqNum": "10",
            "parmString": "",
        }
    }
}

```

```

        "priceItemParmGroupId": "1",
        "toVal": "5000.00000000000000000000",
        "fromVal": "1000.00000000000000000000",
        "timeOfUse": "",
        "priceCompPriceItem": "PI_026",
        "priceCriteria": "NBRTRAN",
        "priceCompTierId": "",
        "tieringSeqNum": "10",
        "parmString": "",
    }
}

        "priceItemParmGroupId": "1",
        "toVal": "999999999999.99000000000000000000",
        "fromVal": "5000.00000000000000000000",
        "timeOfUse": "",
        "priceCompPriceItem": "PI_026",
        "priceCriteria": "NBRTRAN",
        "priceCompTierId": "",
        "tieringSeqNum": "10",
        "parmString": "",
    }
}

}

"priceCompId": "5417400023",
"priceCompDescr": "Threshold price",
"valueAmt": "6.00000000000000000000",
"tieredFlag": "",
"pricecomptier":
{
    {
        "priceItemParmGroupId": "1",
        "toVal": "1000.00000000000000000000",
        "fromVal": "0.00000000000000000000",
        "timeOfUse": "",
        "priceCompPriceItem": "PI_026",
        "priceCriteria": "NBRTRAN",
        "priceCompTierId": "",
        "tieringSeqNum": "10",
        "parmString": "",
    }
}

        "priceItemParmGroupId": "1",
        "toVal": "5000.00000000000000000000",
        "fromVal": "1000.00000000000000000000",
        "timeOfUse": "",
        "priceCompPriceItem": "PI_026",
        "priceCriteria": "NBRTRAN",
        "priceCompTierId": "",
        "tieringSeqNum": "10",
        "parmString": "",
    }
}

        "priceItemParmGroupId": "1",
        "toVal": "999999999999.99000000000000000000",
        "fromVal": "5000.00000000000000000000",
        "timeOfUse": "",
        "priceCompPriceItem": "PI_026",
        "priceCriteria": "NBRTRAN",
        "priceCompTierId": "",
        "tieringSeqNum": "10",
        "parmString": "",
    }
}
}

```

```

        "priceItemParmGroupId": "1",
        "toVal": "1000.00000000000000000000",
        "fromVal": "0.00000000000000000000",
        "timeOfUse": "",
        "priceCompPriceItem": "PI_026",
        "priceCriteria": "NBRTRAN",
        "priceCompTierId": "",
        "tieringSeqNum": "10",
        "parmString": "",
    }
}
        "priceItemParmGroupId": "1",
        "toVal": "5000.00000000000000000000",
        "fromVal": "1000.00000000000000000000",
        "timeOfUse": "",
        "priceCompPriceItem": "PI_026",
        "priceCriteria": "NBRTRAN",
        "priceCompTierId": "",
        "tieringSeqNum": "10",
        "parmString": "",
    }
}
        "priceItemParmGroupId": "1",
        "toVal": "99999999999.99000000000000000000",
        "fromVal": "5000.00000000000000000000",
        "timeOfUse": "",
        "priceCompPriceItem": "PI_026",
        "priceCriteria": "NBRTRAN",
        "priceCompTierId": "",
        "tieringSeqNum": "10",
        "parmString": "",
    }
}
}
    "priceCompId": "5417400024",
    "priceCompDescr": "Step 1",
    "valueAmt": "5.00000000000000000000",
    "tieredFlag": "",
    "pricecomptier":
    {
        {
            "priceItemParmGroupId": "1",
            "toVal": "1000.00000000000000000000",
            "fromVal": "0.00000000000000000000",
            "timeOfUse": "",
            "priceCompPriceItem": "PI_026",
            "priceCriteria": "NBRTRAN",
            "priceCompTierId": "",
            "tieringSeqNum": "10",
            "parmString": "",
        }
        {
            "priceItemParmGroupId": "1",
            "toVal": "5000.00000000000000000000",
            "fromVal": "1000.00000000000000000000",
            "timeOfUse": "",
            "priceCompPriceItem": "PI_026",
            "priceCriteria": "NBRTRAN",
            "priceCompTierId": "",
            "tieringSeqNum": "10",
            "parmString": "",
        }
    }
}

```



```

        "priceItemParmGroupId": "1",
        "toVal": "99999999999.99000000000000000000",
        "fromVal": "5000.00000000000000000000",
        "timeOfUse": "",
        "priceCompPriceItem": "PI_026",
        "priceCriteria": "NBRTRAN",
        "priceCompTierId": "",
        "tieringSeqNum": "10",
        "parmString": "",
    }
}
{
    "priceItemParmGroupId": "1",
    "toVal": "1000.00000000000000000000",
    "fromVal": "0.00000000000000000000",
    "timeOfUse": "",
    "priceCompPriceItem": "PI_026",
    "priceCriteria": "NBRTRAN",
    "priceCompTierId": "",
    "tieringSeqNum": "10",
    "parmString": "",
}
}
{
    "priceItemParmGroupId": "1",
    "toVal": "5000.00000000000000000000",
    "fromVal": "1000.00000000000000000000",
    "timeOfUse": "",
    "priceCompPriceItem": "PI_026",
    "priceCriteria": "NBRTRAN",
    "priceCompTierId": "",
    "tieringSeqNum": "10",
    "parmString": "",
}
}
{
    "priceItemParmGroupId": "1",
    "toVal": "99999999999.99000000000000000000",
    "fromVal": "5000.00000000000000000000",
    "timeOfUse": "",
    "priceCompPriceItem": "PI_026",
    "priceCriteria": "NBRTRAN",
    "priceCompTierId": "",
    "tieringSeqNum": "10",
    "parmString": "",
}
}
}
{
    "priceCompId": "5417400025",
    "priceCompDescr": "Step 2",
    "valueAmt": "4.00000000000000000000",
    "tieredFlag": "",
    "pricecomptier":
    {
        {
            "priceItemParmGroupId": "1",
            "toVal": "1000.00000000000000000000",
            "fromVal": "0.00000000000000000000",
            "timeOfUse": "",
            "priceCompPriceItem": "PI_026",
            "priceCriteria": "NBRTRAN",
            "priceCompTierId": "",
            "tieringSeqNum": "10",
            "parmString": "",
        }
    }
}
}

```

```

        "priceItemParmGroupId": "1",
        "toVal": "5000.00000000000000000000",
        "fromVal": "1000.00000000000000000000",
        "timeOfUse": "",
        "priceCompPriceItem": "PI_026",
        "priceCriteria": "NBRTRAN",
        "priceCompTierId": "",
        "tieringSeqNum": "10",
        "parmString": "",
    }
}
{
    "priceItemParmGroupId": "1",
    "toVal": "999999999999.99000000000000000000",
    "fromVal": "5000.00000000000000000000",
    "timeOfUse": "",
    "priceCompPriceItem": "PI_026",
    "priceCriteria": "NBRTRAN",
    "priceCompTierId": "",
    "tieringSeqNum": "10",
    "parmString": "",
}
}
{
    "priceItemParmGroupId": "1",
    "toVal": "1000.00000000000000000000",
    "fromVal": "0.00000000000000000000",
    "timeOfUse": "",
    "priceCompPriceItem": "PI_026",
    "priceCriteria": "NBRTRAN",
    "priceCompTierId": "",
    "tieringSeqNum": "10",
    "parmString": "",
}
}
{
    "priceItemParmGroupId": "1",
    "toVal": "5000.00000000000000000000",
    "fromVal": "1000.00000000000000000000",
    "timeOfUse": "",
    "priceCompPriceItem": "PI_026",
    "priceCriteria": "NBRTRAN",
    "priceCompTierId": "",
    "tieringSeqNum": "10",
    "parmString": "",
}
}
{
    "priceItemParmGroupId": "1",
    "toVal": "999999999999.99000000000000000000",
    "fromVal": "5000.00000000000000000000",
    "timeOfUse": "",
    "priceCompPriceItem": "PI_026",
    "priceCriteria": "NBRTRAN",
    "priceCompTierId": "",
    "tieringSeqNum": "10",
    "parmString": "",
}
}
}
{
    "priceCompId": "541740026",
    "priceCompDescr": "Step 3",
    "valueAmt": "3.00000000000000000000",
    "tieredFlag": "",
    "pricecomptier":
    {
        {

```

```

    "priceItemParmGroupId": "1",
    "toVal": "1000.00000000000000000000",
    "fromVal": "0.00000000000000000000",
    "timeOfUse": "",
    "priceCompPriceItem": "PI_026",
    "priceCriteria": "NBRTRAN",
    "priceCompTierId": "",
    "tieringSeqNum": "10",
    "parmString": "",
  }
}

    "priceItemParmGroupId": "1",
    "toVal": "5000.00000000000000000000",
    "fromVal": "1000.00000000000000000000",
    "timeOfUse": "",
    "priceCompPriceItem": "PI_026",
    "priceCriteria": "NBRTRAN",
    "priceCompTierId": "",
    "tieringSeqNum": "10",
    "parmString": "",
  }
}

    "priceItemParmGroupId": "1",
    "toVal": "999999999999.99000000000000000000",
    "fromVal": "5000.00000000000000000000",
    "timeOfUse": "",
    "priceCompPriceItem": "PI_026",
    "priceCriteria": "NBRTRAN",
    "priceCompTierId": "",
    "tieringSeqNum": "10",
    "parmString": "",
  }
}

    "priceItemParmGroupId": "1",
    "toVal": "1000.00000000000000000000",
    "fromVal": "0.00000000000000000000",
    "timeOfUse": "",
    "priceCompPriceItem": "PI_026",
    "priceCriteria": "NBRTRAN",
    "priceCompTierId": "",
    "tieringSeqNum": "10",
    "parmString": "",
  }
}

    "priceItemParmGroupId": "1",
    "toVal": "5000.00000000000000000000",
    "fromVal": "1000.00000000000000000000",
    "timeOfUse": "",
    "priceCompPriceItem": "PI_026",
    "priceCriteria": "NBRTRAN",
    "priceCompTierId": "",
    "tieringSeqNum": "10",
    "parmString": "",
  }
}

    "priceItemParmGroupId": "1",
    "toVal": "999999999999.99000000000000000000",
    "fromVal": "5000.00000000000000000000",
    "timeOfUse": "",
    "priceCompPriceItem": "PI_026",
    "priceCriteria": "NBRTRAN",
    "priceCompTierId": "",
    "tieringSeqNum": "10",
    "parmString": "",
  }
}

```

```

    }
  }
}
{
  "priceListId": "5417730766",
  "priceListDescription": "PriceList -1",
  "priority": "2",
  "validityFlag": "",
  "noOfDays": "10",
  "priceItemCode": "PI_027",
  "priceitemCodeDescr": "V7-Direct Debit",
  "priceAsgnId": "5410009209",
  "priceListStartDate": "2022-02-11",
  "priceListEndDate": "2022-02-21",
  "priceComponent":
  {
    "priceCompId": "5417300038",
    "priceCompDescr": "Basic BK-NBR",
    "valueAmt": "0.150000000000000000",
    "tieredFlag": "",
    "pricecomptier":
    {
      "priceItemParmGroupId": "",
      "toVal": "",
      "fromVal": "",
      "timeOfUse": "",
      "priceCompPriceItem": "",
      "priceCriteria": "",
      "priceCompTierId": "",
      "tieringSeqNum": "",
      "parmString": "",
    }
  }
}
{
  "priceListId": "5417730766",
  "priceListDescription": "PriceList -1",
  "priority": "2",
  "validityFlag": "",
  "noOfDays": "10",
  "priceItemCode": "PI_028",
  "priceitemCodeDescr": "V8-Cheque Collections",
  "priceAsgnId": "5410009210",
  "priceListStartDate": "2022-02-11",
  "priceListEndDate": "2022-02-21",
  "priceComponent":
  {
    "priceCompId": "5417300040",
    "priceCompDescr": "FLAT",
    "valueAmt": "0.750000000000000000",
    "tieredFlag": "",
    "pricecomptier":
    {
      "priceItemParmGroupId": "",
      "toVal": "",
      "fromVal": "",
      "timeOfUse": "",
      "priceCompPriceItem": "",
      "priceCriteria": "",
      "priceCompTierId": "",
      "tieringSeqNum": "",
      "parmString": "",
    }
  }
}

```

```

    }
  }
}
{
  "priceListId": "5417730766",
  "priceListDescription": "PriceList -1",
  "priority": "2",
  "validityFlag": "",
  "noOfDays": "10",
  "priceItemCode": "PI_028",
  "priceitemCodeDescr": "V8-Cheque Collections",
  "priceAsgnId": "5410009211",
  "priceListStartDate": "2022-02-11",
  "priceListEndDate": "2022-02-21",
  "priceComponent":
  {
    "priceCompId": "5417300042",
    "priceCompDescr": "FLAT",
    "valueAmt": "6.670000000000000000",
    "tieredFlag": "",
    "pricecomptier":
    {
      "priceItemParmGroupId": "",
      "toVal": "",
      "fromVal": "",
      "timeOfUse": "",
      "priceCompPriceItem": "",
      "priceCriteria": "",
      "priceCompTierId": "",
      "tieringSeqNum": "",
      "parmString": "",
    }
  }
}
}
{
  "priceListId": "5417730766",
  "priceListDescription": "PriceList -1",
  "priority": "2",
  "validityFlag": "",
  "noOfDays": "10",
  "priceItemCode": "PI_028",
  "priceitemCodeDescr": "V8-Cheque Collections",
  "priceAsgnId": "5410009212",
  "priceListStartDate": "2022-02-11",
  "priceListEndDate": "2022-02-21",
  "priceComponent":
  {
    "priceCompId": "5417300044",
    "priceCompDescr": "FLAT",
    "valueAmt": "0.300000000000000000",
    "tieredFlag": "",
    "pricecomptier":
    {
      "priceItemParmGroupId": "",
      "toVal": "",
      "fromVal": "",
      "timeOfUse": "",
      "priceCompPriceItem": "",
      "priceCriteria": "",
      "priceCompTierId": "",
      "tieringSeqNum": "",
      "parmString": "",
    }
  }
}
}

```

```

    }
    {
      "priceListId": "5417730766",
      "priceListDescription": "PriceList -1",
      "priority": "2",
      "validityFlag": "",
      "noOfDays": "10",
      "priceItemCode": "PI_028",
      "priceitemCodeDescr": "V8-Cheque Collections",
      "priceAsgnId": "5410009213",
      "priceListStartDate": "2022-02-11",
      "priceListEndDate": "2022-02-21",
      "priceComponent":
      {
        "priceCompId": "5417300046",
        "priceCompDescr": "FLAT",
        "valueAmt": "2.05000000000000000000",
        "tieredFlag": "",
        "pricecomptier":
        {
          "priceItemParmGroupId": "",
          "toVal": "",
          "fromVal": "",
          "timeOfUse": "",
          "priceCompPriceItem": "",
          "priceCriteria": "",
          "priceCompTierId": "",
          "tieringSeqNum": "",
          "parmString": "",
        }
      }
    }
  }
  {
    "priceListId": "5417730766",
    "priceListDescription": "PriceList -1",
    "priority": "2",
    "validityFlag": "",
    "noOfDays": "10",
    "priceItemCode": "PI_029",
    "priceitemCodeDescr": "V9-Domestic Liquidity",
    "priceAsgnId": "5410009214",
    "priceListStartDate": "2022-02-11",
    "priceListEndDate": "2022-02-21",
    "priceComponent":
    {
      "priceCompId": "5417300046",
      "priceCompDescr": "FLAT",
      "valueAmt": "0.40000000000000000000",
      "tieredFlag": "",
      "pricecomptier":
      {
        "priceItemParmGroupId": "",
        "toVal": "",
        "fromVal": "",
        "timeOfUse": "",
        "priceCompPriceItem": "",
        "priceCriteria": "",
        "priceCompTierId": "",
        "tieringSeqNum": "",
        "parmString": "",
      }
    }
  }
}
{

```

```

"priceListId": "5417730766",
"priceListDescription": "PriceList -1",
"priority": "2",
"validityFlag": "",
"noOfDays": "10",
"priceItemCode": "PI_030",
"priceitemCodeDescr": "V10-Third Party Bank",
"priceAsgnId": "5410009215",
"priceListStartDate": "2022-02-11",
"priceListEndDate": "2022-02-21",
"priceComponent":
{
  "priceCompId": "5417300050",
  "priceCompDescr": "FLAT",
  "valueAmt": "0.600000000000000000",
  "tieredFlag": "",
  "pricemcptier":
  {
    "priceItemParmGroupId": "",
    "toVal": "",
    "fromVal": "",
    "timeOfUse": "",
    "priceCompPriceItem": "",
    "priceCriteria": "",
    "priceCompTierId": "",
    "tieringSeqNum": "",
    "parmString": "",
  }
}
}
{
"priceListId": "5417730766",
"priceListDescription": "PriceList -1",
"priority": "2",
"validityFlag": "",
"noOfDays": "10",
"priceItemCode": "PI_031",
"priceitemCodeDescr": "MT943_SWIFT_01",
"priceAsgnId": "5417300002",
"priceListStartDate": "2022-02-11",
"priceListEndDate": "2022-02-21",
"priceComponent":
{
  "priceCompId": "5417300002",
  "priceCompDescr": "FLAT",
  "valueAmt": "16.660000000000000000",
  "tieredFlag": "",
  "pricemcptier":
  {
    "priceItemParmGroupId": "",
    "toVal": "",
    "fromVal": "",
    "timeOfUse": "",
    "priceCompPriceItem": "",
    "priceCriteria": "",
    "priceCompTierId": "",
    "tieringSeqNum": "",
    "parmString": "",
  }
}
}
}
{
"priceListId": "5417730766",
"priceListDescription": "PriceList -1",

```

```

    "priority": "2",
    "validityFlag": "",
    "noOfDays": "10",
    "priceItemCode": "PI_032",
    "priceitemCodeDescr": "MT943_SWIFT_02",
    "priceAsgnId": "5410009261",
    "priceListStartDate": "2022-02-11",
    "priceListEndDate": "2022-02-21",
    "priceComponent":
    {
        "priceCompId": "5417450002",
        "priceCompDescr": "FLAT",
        "valueAmt": "15.000000000000000000",
        "tieredFlag": "",
        "pricecomptier":
        {
            "priceItemParmGroupId": "",
            "toVal": "",
            "fromVal": "",
            "timeOfUse": "",
            "priceCompPriceItem": "",
            "priceCriteria": "",
            "priceCompTierId": "",
            "tieringSeqNum": "",
            "parmString": "",
        }
    }
}

```

Related Topics

For more information on...	See...
Market Product, Offer, or Bundle View Request and Response - Attribute/Value Pairs in JSON Format	Market Product, Offer, or Bundle View Request and Response - Attribute/Value Pairs in JSON Format on page 3568

Sample Bundle View Summary Request and Response in the JSON Format

Using the below example, you can view summary of bundles which are processed on the date 2022-01-11.

Sample Bundle View Summary Request in the JSON Format

```

{
  "C1-GetProdDetail":
  {
    "entityCode": "CHECKBUND_003",
    "entityType": "BNDL",
    "processDate": "2022-02-11",
    "inquiryTypeFlag": "SMRY",
    "division": "IND",
  }
}

```

Sample Bundle View Summary Response in the JSON Format

```

{
  "C1-GetProdDetail":
  {
    "entityCode": "CHECKBUND_003",
    "entityType": "BNDL",
    "processDate": "2022-02-11",
    "inquiryTypeFlag": "SMRY",
  }
}

```



```

"division": "IND",
"entityName": "CHECKBUND_003",
"entityStartDate": "2022-01-11",
"entityEndDate": "",
"termsAndCondition": "TERMSPRAAS",
"status": "ACTIVE",
"termsAndCondDescr": "TERMSPRAAS",
"messageCategory": "0",
"messageNumber": "0",
"messageText": "",
"longDescription": "",
"productlist":
{
  "productCode": "LOAN_001",
  "productName": "LOAN_001",
  "prodTypFlg": "PROD",
  "productCategoryFlgDesc": "Loans",
}
"EntityDivision":
{
  "divisionCode": "IND",
}
"productLinkedEntity":
{
  {
    "linkedEntityCode": "CHECKMP_001",
    "linkedEntityName": "CHECKMP_001",
    "linkedEntityType": "MP",
  }
  {
    "linkedEntityCode": "CHEKCOMP_002",
    "linkedEntityName": "CHEKCOMP_002",
    "linkedEntityType": "MP",
  }
}
"eligibilityDetails":
{
  "eligibilityDescription": "LOANBUND_001",
  "eligibilityStartDate": "2022-01-11",
  "eligibilityEndDate": "",
  "eligibilityRule":
  {
    "rhsPriceParmCd": "",
    "rhsPriceParmVal": "MH",
    "lhsPriceParmCd": "ACC_DIVISION",
    "rhsPriceParmTypeFlg": "VAL",
    "trueFlag": "RLTR",
    "trueFlagDescr": "",
    "falseFlag": "RLFS",
    "falseFlagDescr": "",
    "insufficientFlag": "RLFS",
    "insufficientFlagDescr": "",
    "eligibilityRuleFlg": "",
    "eligibilityDescr": "",
    "operator": "=",
    "priceParmCode": "",
    "sequenceNumber": "10",
  }
}
"services":
{
  "serviceCd": "",
  "serviceName": "Product Service PRASS2",
  "mandatoryFlag": "true",

```

```

    }
    "services":
    {
      "serviceCd": "",
      "serviceName": "MH division product service",
      "mandatoryFlag": "true",
    }
    "services":
    {
      "serviceCd": "",
      "serviceName": "Product Service PRASS1",
      "mandatoryFlag": "true",
    }
  }
}

```

Related Topics

For more information on...	See...
Market Product, Offer, or Bundle View Request and Response - Attribute/Value Pairs in JSON Format	Market Product, Offer, or Bundle View Request and Response - Attribute/Value Pairs in JSON Format on page 3568

Sample Bundle View Detail Request and Response in the JSON Format

Using the below example, you can view bundles which are processed on the date 2022-01-11.

Sample Bundle View Detail Request in the JSON Format

```

{
  "C1-GetProdDetail":
  {
    "entityCode": "CHECKBUND_003",
    "entityType": "BNDL",
    "processDate": "2022-02-11",
    "inquiryTypeFlag": "DETL",
    "division": "IND",
  }
}

```

Sample Bundle View Detail Response in the JSON Format

```

{
  "C1-GetProdDetail":
  {
    "entityCode": "CHECKBUND_003",
    "entityType": "BNDL",
    "processDate": "2022-02-11",
    "inquiryTypeFlag": "",
    "division": "IND",
  }
  "viewResponse":
  {
    "entityName": "CHECKBUND_003",
    "entityStartDate": "2022-01-11",
    "entityEndDate": "",
    "termsAndCondition": "TERMSPRAAS",
    "status": "ACTIVE",
    "termsAndCondndDescr": "TERMSPRAAS",
    "messageCategory": "0",
    "messageNumber": "0",
    "messageText": "",
    "longDescription": "",
    "productlist":
  }
}

```

```

{
  "productCode": "LOAN_001",
  "productName": "LOAN_001",
  "prodTypFlg": "PROD",
  "productCategoryFlgDesc": "Loans",
}
"EntityDivision":
{
  "divisionCode": "IND",
}
"productLinkedEntity":
{
  {
    "linkedEntityCode": "CHECKMP_001",
    "linkedEntityName": "CHECKMP_001",
    "linkedEntityType": "MP",
  }
  {
    "linkedEntityCode": "CHEKCMP_002",
    "linkedEntityName": "CHEKCMP_002",
    "linkedEntityType": "MP",
  }
}
"eligibilityDetails"
{
  "eligibilityDescription": "LOANDBUND_001",
  "eligibilityStartDate": "2022-01-11",
  "eligibilityEndDate": "",
  "eligibilityRule":
  {
    "rhsPriceParmCd": "",
    "rhsPriceParmVal": "MH",
    "lhsPriceParmCd": "ACC_DIVISION",
    "rhsPriceParmTypeFlg": "VAL",
    "trueFlag": "RLTR",
    "trueFlagDescr": "",
    "falseFlag": "RLFS",
    "falseFlagDescr": "",
    "insufficientFlag": "RLFS",
    "insufficientFlagDescr": "",
    "eligibilityRuleFlg": "",
    "eligibilityDescr": "",
    "operator": "=",
    "priceParmCode": "",
    "sequenceNumber": "10",
  }
}
"services":
{
  "serviceCd": "",
  "serviceName": "Product Service PRASS2",
  "mandatoryFlag": "true",
}
"services":
{
  "serviceCd": "",
  "serviceName": "MH division product service",
  "mandatoryFlag": "true",
}
"services":
{
  "serviceCd": "",
  "serviceName": "Product Service PRASS1",
  "mandatoryFlag": "true",
}

```

```

}
"pricing":
{
  "priceListId": "4368251923",
  "priceListDescription": "Currency_Con_PriceList -1",
  "priority": "1",
  "validityFlag": "",
  "noOfDays": "30",
  "priceItemCode": "CC_021",
  "priceitemCodeDescr": "CC_21-Account Opening Fee",
  "priceAsgnId": "4360009281",
  "priceListStartDate": "2022-02-11",
  "priceListEndDate": "2022-03-13",
  "priceComponent":
  {
    "priceCompId": "4367475002",
    "priceCompDescr": "FLAT",
    "valueAmt": "0.400000000000000000",
    "tieredFlag": "",
    "pricecomptier":
    {
      "priceItemParmGroupId": "",
      "toVal": "",
      "fromVal": "",
      "timeOfUse": "",
      "priceCompPriceItem": "",
      "priceCriteria": "",
      "priceCompTierId": "",
      "tieringSeqNum": "",
      "parmString": "",
    }
  }
}
"pricing":
{
  "priceListId": "4368251923",
  "priceListDescription": "Currency_Con_PriceList -1",
  "priority": "1",
  "validityFlag": "",
  "noOfDays": "30",
  "priceItemCode": "CC_022",
  "priceitemCodeDescr": "CC2-Monthly Acct Serv Fee",
  "priceAsgnId": "4360009282",
  "priceListStartDate": "2022-02-11",
  "priceListEndDate": "2022-03-13",
  "priceComponent":
  {
    "priceCompId": "4367475004",
    "priceCompDescr": "FLAT",
    "valueAmt": "0.600000000000000000",
    "tieredFlag": "",
    "pricecomptier":
    {
      "priceItemParmGroupId": "",
      "toVal": "",
      "fromVal": "",
      "timeOfUse": "",
      "priceCompPriceItem": "",
      "priceCriteria": "",
      "priceCompTierId": "",
      "tieringSeqNum": "",
      "parmString": "",
    }
  }
}

```

```

}
"pricing":
{
  "priceListId": "4368251923",
  "priceListDescription": "Currency_Con_PriceList -1",
  "priority": "1",
  "validityFlag": "",
  "noOfDays": "30",
  "priceItemCode": "CC_024",
  "priceitemCodeDescr": "CC3-SEPA Transfers",
  "priceAsgnId": "4360009283",
  "priceListStartDate": "2022-02-11",
  "priceListEndDate": "2022-03-13",
  "priceComponent":
  {
    "priceCompId": "4367475006",
    "priceCompDescr": "FLAT",
    "valueAmt": "0.250000000000000000",
    "tieredFlag": "",
    "pricecomptier":
    {
      "priceItemParmGroupId": "",
      "toVal": "",
      "fromVal": "",
      "timeOfUse": "",
      "priceCompPriceItem": "",
      "priceCriteria": "",
      "priceCompTierId": "",
      "tieringSeqNum": "",
      "parmString": "",
    }
  }
}
"pricing":
{
  "priceListId": "4368251923",
  "priceListDescription": "Currency_Con_PriceList -1",
  "priority": "1",
  "validityFlag": "",
  "noOfDays": "30",
  "priceItemCode": "CC_025",
  "priceitemCodeDescr": "CC4-Domestic Funds Transfer Fee",
  "priceAsgnId": "4360009284",
  "priceListStartDate": "2022-02-11",
  "priceListEndDate": "2022-03-13",
  "priceComponent":
  {
    "priceCompId": "4367475008",
    "priceCompDescr": "FLAT",
    "valueAmt": "112.040000000000000000",
    "tieredFlag": "",
    "pricecomptier":
    {
      "priceItemParmGroupId": "",
      "toVal": "",
      "fromVal": "",
      "timeOfUse": "",
      "priceCompPriceItem": "",
      "priceCriteria": "",
      "priceCompTierId": "",
      "tieringSeqNum": "",
      "parmString": "",
    }
  }
}

```

```

}
"pricing":
{
  "priceListId": "5417730766",
  "priceListDescription": "PriceList -1",
  "priority": "2",
  "validityFlag": "",
  "noOfDays": "10",
  "priceItemCode": "PI_021",
  "priceitemCodeDescr": "V1-Account Opening Fee",
  "priceAsgnId": "5410009202",
  "priceListStartDate": "2022-02-11",
  "priceListEndDate": "2022-02-21",
  "priceComponent":
  {
    "priceCompId": "5417300004",
    "priceCompDescr": "FLAT",
    "valueAmt": "0.250000000000000000",
    "tieredFlag": "",
    "pricecomptier":
    {
      "priceItemParmGroupId": "",
      "toVal": "",
      "fromVal": "",
      "timeOfUse": "",
      "priceCompPriceItem": "",
      "priceCriteria": "",
      "priceCompTierId": "",
      "tieringSeqNum": "",
      "parmString": "",
    }
  }
}
"pricing":
{
  "priceListId": "5417730766",
  "priceListDescription": "PriceList -1",
  "priority": "2",
  "validityFlag": "",
  "noOfDays": "10",
  "priceItemCode": "PI_022",
  "priceitemCodeDescr": "V2-Monthly Acct Serv Fee",
  "priceAsgnId": "5410009203",
  "priceListStartDate": "2022-02-11",
  "priceListEndDate": "2022-02-21",
  "priceComponent":
  {
    "priceCompId": "5417300006",
    "priceCompDescr": "FLAT",
    "valueAmt": "112.040000000000000000",
    "tieredFlag": "",
    "pricecomptier":
    {
      "priceItemParmGroupId": "",
      "toVal": "",
      "fromVal": "",
      "timeOfUse": "",
      "priceCompPriceItem": "",
      "priceCriteria": "",
      "priceCompTierId": "",
      "tieringSeqNum": "",
      "parmString": "",
    }
  }
}

```

```

}
"pricing":
{
  "priceListId": "5417730766",
  "priceListDescription": "PriceList -1",
  "priority": "2",
  "validityFlag": "",
  "noOfDays": "10",
  "priceItemCode": "PI_023",
  "priceitemCodeDescr": "V3-Audit Reports",
  "priceAsgnId": "5410009204",
  "priceListStartDate": "2022-02-11",
  "priceListEndDate": "2022-02-21",
  "priceComponent":
  {
    "priceCompId": "5417300008",
    "priceCompDescr": "FLAT",
    "valueAmt": "276.250000000000000000",
    "tieredFlag": "",
    "pricecomptier":
    {
      "priceItemParmGroupId": "",
      "toVal": "",
      "fromVal": "",
      "timeOfUse": "",
      "priceCompPriceItem": "",
      "priceCriteria": "",
      "priceCompTierId": "",
      "tieringSeqNum": "",
      "parmString": "",
    }
  }
}
}
{
  "priceListId": "5417730766",
  "priceListDescription": "PriceList -1",
  "priority": "2",
  "validityFlag": "",
  "noOfDays": "10",
  "priceItemCode": "PI_024",
  "priceitemCodeDescr": "V4-SEPA Transfers",
  "priceAsgnId": "5410009241",
  "priceListStartDate": "2022-02-11",
  "priceListEndDate": "2022-02-21",
  "priceComponent":
  {
    "priceCompId": "5417400004",
    "priceCompDescr": "Price per transaction - Step Tier 1",
    "valueAmt": "12.950000000000000000",
    "tieredFlag": "",
    "pricecomptier":
    {
      "priceItemParmGroupId": "1",
      "toVal": "1000.000000000000000000",
      "fromVal": "0.000000000000000000",
      "timeOfUse": "",
      "priceCompPriceItem": "PI_024",
      "priceCriteria": "NBRTRAN",
      "priceCompTierId": "",
      "tieringSeqNum": "10",
      "parmString": "",
    }
  }
}

```

```

    }
    {
        "priceItemParmGroupId": "1",
        "toVal": "5000.000000000000000000000000",
        "fromVal": "1000.000000000000000000000000",
        "timeOfUse": "",
        "priceCompPriceItem": "PI_024",
        "priceCriteria": "NBRTRAN",
        "priceCompTierId": "",
        "tieringSeqNum": "10",
        "parmString": "",
    }
    {
        "priceItemParmGroupId": "1",
        "toVal": "999999999999.990000000000000000000000",
        "fromVal": "5000.000000000000000000000000",
        "timeOfUse": "",
        "priceCompPriceItem": "PI_024",
        "priceCriteria": "NBRTRAN",
        "priceCompTierId": "",
        "tieringSeqNum": "10",
        "parmString": "",
    }
}
}
"priceCompId": "5417400005",
"priceCompDescr": "Price per transaction - Step Tier 2",
"valueAmt": "12.150000000000000000000000",
"tieredFlag": "",
"pricecomptier":
{
    {
        "priceItemParmGroupId": "1",
        "toVal": "1000.000000000000000000000000",
        "fromVal": "0.000000000000000000000000",
        "timeOfUse": "",
        "priceCompPriceItem": "PI_024",
        "priceCriteria": "NBRTRAN",
        "priceCompTierId": "",
        "tieringSeqNum": "10",
        "parmString": "",
    }
    {
        "priceItemParmGroupId": "1",
        "toVal": "5000.000000000000000000000000",
        "fromVal": "1000.000000000000000000000000",
        "timeOfUse": "",
        "priceCompPriceItem": "PI_024",
        "priceCriteria": "NBRTRAN",
        "priceCompTierId": "",
        "tieringSeqNum": "10",
        "parmString": "",
    }
    {
        "priceItemParmGroupId": "1",
        "toVal": "999999999999.990000000000000000000000",
        "fromVal": "5000.000000000000000000000000",
        "timeOfUse": "",
        "priceCompPriceItem": "PI_024",
        "priceCriteria": "NBRTRAN",
        "priceCompTierId": "",
        "tieringSeqNum": "10",
        "parmString": "",
    }
}
}

```



```

    }
  }
}
{
  "priceCompId": "5417400006",
  "priceCompDescr": "Price per transaction - Step Tier 3",
  "valueAmt": "11.950000000000000000",
  "tieredFlag": "",
  "pricecomptier":
  {
    {
      "priceItemParmGroupId": "1",
      "toVal": "1000.000000000000000000",
      "fromVal": "0.000000000000000000",
      "timeOfUse": "",
      "priceCompPriceItem": "PI_024",
      "priceCriteria": "NBRTRAN",
      "priceCompTierId": "",
      "tieringSeqNum": "10",
      "parmString": "",
    }
    {
      "priceItemParmGroupId": "1",
      "toVal": "5000.000000000000000000",
      "fromVal": "1000.000000000000000000",
      "timeOfUse": "",
      "priceCompPriceItem": "PI_024",
      "priceCriteria": "NBRTRAN",
      "priceCompTierId": "",
      "tieringSeqNum": "10",
      "parmString": "",
    }
    {
      "priceItemParmGroupId": "1",
      "toVal": "99999999999.990000000000000000",
      "fromVal": "5000.000000000000000000",
      "timeOfUse": "",
      "priceCompPriceItem": "PI_024",
      "priceCriteria": "NBRTRAN",
      "priceCompTierId": "",
      "tieringSeqNum": "10",
      "parmString": "",
    }
  }
}
}
{
  "priceListId": "5417730766",
  "priceListDescription": "PriceList -1",
  "priority": "2",
  "validityFlag": "",
  "noOfDays": "10",
  "priceItemCode": "PI_025",
  "priceitemCodeDescr": "V5-Domestic Funds Transfer Fee",
  "priceAsgnId": "5410009242",
  "priceListStartDate": "2022-02-11",
  "priceListEndDate": "2022-02-21",
  "priceComponent":
  {
    {
      "priceCompId": "5417400010",
      "priceCompDescr": "Threshold price per transaction",
      "valueAmt": "12.950000000000000000",
    }
  }
}

```

```

    "tieredFlag": "",
    "pricecomptier":
    {
      {
        "priceItemParmGroupId": "1",
        "toVal": "1000.00000000000000000000",
        "fromVal": "0.00000000000000000000",
        "timeOfUse": "",
        "priceCompPriceItem": "PI_025",
        "priceCriteria": "NBRTRAN",
        "priceCompTierId": "",
        "tieringSeqNum": "10",
        "parmString": "",
      }
      {
        "priceItemParmGroupId": "1",
        "toVal": "5000.00000000000000000000",
        "fromVal": "1000.00000000000000000000",
        "timeOfUse": "",
        "priceCompPriceItem": "PI_025",
        "priceCriteria": "NBRTRAN",
        "priceCompTierId": "",
        "tieringSeqNum": "10",
        "parmString": "",
      }
    }
  }
  {
    "priceCompId": "5417400011",
    "priceCompDescr": "Threshold price per transaction",
    "valueAmt": "12.15000000000000000000",
    "tieredFlag": "",
    "pricecomptier":
    {
      {
        "priceItemParmGroupId": "1",
        "toVal": "1000.00000000000000000000",
        "fromVal": "0.00000000000000000000",
        "timeOfUse": "",
        "priceCompPriceItem": "PI_025",
        "priceCriteria": "NBRTRAN",
        "priceCompTierId": "",
        "tieringSeqNum": "10",
        "parmString": "",
      }
      {
        "priceItemParmGroupId": "1",
        "toVal": "5000.00000000000000000000",
        "fromVal": "1000.00000000000000000000",
        "timeOfUse": "",
        "priceCompPriceItem": "PI_025",
        "priceCriteria": "NBRTRAN",
        "priceCompTierId": "",
      }
    }
  }

```

```

        "tieringSeqNum": "10",
        "parmString": "",
    }
}
{
    "priceItemParmGroupId": "1",
    "toVal": "999999999999.99000000000000000000",
    "fromVal": "5000.00000000000000000000",
    "timeOfUse": "",
    "priceCompPriceItem": "PI_025",
    "priceCriteria": "NBRTRAN",
    "priceCompTierId": "",
    "tieringSeqNum": "10",
    "parmString": "",
}
}
}
"priceCompId": "5417400012",
"priceCompDescr": "Threshold price per transaction",
"valueAmt": "11.95000000000000000000",
"tieredFlag": "",
"pricecomptier":
{
    {
        "priceItemParmGroupId": "1",
        "toVal": "1000.00000000000000000000",
        "fromVal": "0.00000000000000000000",
        "timeOfUse": "",
        "priceCompPriceItem": "PI_025",
        "priceCriteria": "NBRTRAN",
        "priceCompTierId": "",
        "tieringSeqNum": "10",
        "parmString": "",
    }
}
{
    "priceItemParmGroupId": "1",
    "toVal": "5000.00000000000000000000",
    "fromVal": "1000.00000000000000000000",
    "timeOfUse": "",
    "priceCompPriceItem": "PI_025",
    "priceCriteria": "NBRTRAN",
    "priceCompTierId": "",
    "tieringSeqNum": "10",
    "parmString": "",
}
}
{
    "priceItemParmGroupId": "1",
    "toVal": "999999999999.99000000000000000000",
    "fromVal": "5000.00000000000000000000",
    "timeOfUse": "",
    "priceCompPriceItem": "PI_025",
    "priceCriteria": "NBRTRAN",
    "priceCompTierId": "",
    "tieringSeqNum": "10",
    "parmString": "",
}
}
}
}
}
"priceListId": "5417730766",
"priceListDescription": "PriceList -1",
"priority": "2",

```

```

"validityFlag": "",
"noOfDays": "10",
"priceItemCode": "PI_026",
"priceItemCodeDescr": "V6-Electronic Credits",
"priceAsgnId": "5410009243",
"priceListStartDate": "2022-02-11",
"priceListEndDate": "2022-02-21",
"priceComponent":
{
  {
    "priceCompId": "5417400020",
    "priceCompDescr": "Basic charges",
    "valueAmt": "20.000000000000000000",
    "tieredFlag": "",
    "pricecomptier":
    {
      {
        "priceItemParmGroupId": "1",
        "toVal": "1000.000000000000000000",
        "fromVal": "0.000000000000000000",
        "timeOfUse": "",
        "priceCompPriceItem": "PI_026",
        "priceCriteria": "NBRTRAN",
        "priceCompTierId": "",
        "tieringSeqNum": "10",
        "parmString": "",
      }
    }
    {
      "priceItemParmGroupId": "1",
      "toVal": "5000.000000000000000000",
      "fromVal": "1000.000000000000000000",
      "timeOfUse": "",
      "priceCompPriceItem": "PI_026",
      "priceCriteria": "NBRTRAN",
      "priceCompTierId": "",
      "tieringSeqNum": "10",
      "parmString": "",
    }
  }
  {
    "priceItemParmGroupId": "1",
    "toVal": "99999999999.990000000000000000",
    "fromVal": "5000.000000000000000000",
    "timeOfUse": "",
    "priceCompPriceItem": "PI_026",
    "priceCriteria": "NBRTRAN",
    "priceCompTierId": "",
    "tieringSeqNum": "10",
    "parmString": "",
  }
}
  {
    "priceItemParmGroupId": "1",
    "toVal": "1000.000000000000000000",
    "fromVal": "0.000000000000000000",
    "timeOfUse": "",
    "priceCompPriceItem": "PI_026",
    "priceCriteria": "NBRTRAN",
    "priceCompTierId": "",
    "tieringSeqNum": "10",
    "parmString": "",
  }
}
  {
    "priceItemParmGroupId": "1",
    "toVal": "5000.000000000000000000",
    "fromVal": "1000.000000000000000000",
  }
}

```

```

        "timeOfUse": "",
        "priceCompPriceItem": "PI_026",
        "priceCriteria": "NBRTRAN",
        "priceCompTierId": "",
        "tieringSeqNum": "10",
        "parmString": "",
    }
}
    "priceItemParmGroupId": "1",
    "toVal": "999999999999.99000000000000000000",
    "fromVal": "5000.00000000000000000000",
    "timeOfUse": "",
    "priceCompPriceItem": "PI_026",
    "priceCriteria": "NBRTRAN",
    "priceCompTierId": "",
    "tieringSeqNum": "10",
    "parmString": "",
}
}
}
    "priceCompId": "5417400021",
    "priceCompDescr": "Threshold price",
    "valueAmt": "10.00000000000000000000",
    "tieredFlag": "",
    "pricecomptier":
    {
        {
            "priceItemParmGroupId": "1",
            "toVal": "1000.00000000000000000000",
            "fromVal": "0.00000000000000000000",
            "timeOfUse": "",
            "priceCompPriceItem": "PI_026",
            "priceCriteria": "NBRTRAN",
            "priceCompTierId": "",
            "tieringSeqNum": "10",
            "parmString": "",
        }
        {
            "priceItemParmGroupId": "1",
            "toVal": "5000.00000000000000000000",
            "fromVal": "1000.00000000000000000000",
            "timeOfUse": "",
            "priceCompPriceItem": "PI_026",
            "priceCriteria": "NBRTRAN",
            "priceCompTierId": "",
            "tieringSeqNum": "10",
            "parmString": "",
        }
        {
            "priceItemParmGroupId": "1",
            "toVal": "999999999999.99000000000000000000",
            "fromVal": "5000.00000000000000000000",
            "timeOfUse": "",
            "priceCompPriceItem": "PI_026",
            "priceCriteria": "NBRTRAN",
            "priceCompTierId": "",
            "tieringSeqNum": "10",
            "parmString": "",
        }
        {
            "priceItemParmGroupId": "1",
            "toVal": "1000.00000000000000000000",
            "fromVal": "0.00000000000000000000",

```

```

        "timeOfUse": "",
        "priceCompPriceItem": "PI_026",
        "priceCriteria": "NBRTRAN",
        "priceCompTierId": "",
        "tieringSeqNum": "10",
        "parmString": "",
    }
}
{
    "priceItemParmGroupId": "1",
    "toVal": "5000.0000000000000000000000",
    "fromVal": "1000.0000000000000000000000",
    "timeOfUse": "",
    "priceCompPriceItem": "PI_026",
    "priceCriteria": "NBRTRAN",
    "priceCompTierId": "",
    "tieringSeqNum": "10",
    "parmString": "",
}
}
{
    "priceItemParmGroupId": "1",
    "toVal": "999999999999.99000000000000000000",
    "fromVal": "5000.0000000000000000000000",
    "timeOfUse": "",
    "priceCompPriceItem": "PI_026",
    "priceCriteria": "NBRTRAN",
    "priceCompTierId": "",
    "tieringSeqNum": "10",
    "parmString": "",
}
}
}
{
    "priceCompId": "5417400022",
    "priceCompDescr": "Threshold price",
    "valueAmt": "8.0000000000000000000000",
    "tieredFlag": "",
    "pricecomptier":
    {
        {
            "priceItemParmGroupId": "1",
            "toVal": "1000.0000000000000000000000",
            "fromVal": "0.0000000000000000000000",
            "timeOfUse": "",
            "priceCompPriceItem": "PI_026",
            "priceCriteria": "NBRTRAN",
            "priceCompTierId": "",
            "tieringSeqNum": "10",
            "parmString": "",
        }
        {
            "priceItemParmGroupId": "1",
            "toVal": "5000.0000000000000000000000",
            "fromVal": "1000.0000000000000000000000",
            "timeOfUse": "",
            "priceCompPriceItem": "PI_026",
            "priceCriteria": "NBRTRAN",
            "priceCompTierId": "",
            "tieringSeqNum": "10",
            "parmString": "",
        }
        {
            "priceItemParmGroupId": "1",
            "toVal": "999999999999.99000000000000000000",
            "fromVal": "5000.0000000000000000000000",

```

```

        "timeOfUse": "",
        "priceCompPriceItem": "PI_026",
        "priceCriteria": "NBRTRAN",
        "priceCompTierId": "",
        "tieringSeqNum": "10",
        "parmString": "",
    }
}
{
    "priceItemParmGroupId": "1",
    "toVal": "1000.00000000000000000000",
    "fromVal": "0.00000000000000000000",
    "timeOfUse": "",
    "priceCompPriceItem": "PI_026",
    "priceCriteria": "NBRTRAN",
    "priceCompTierId": "",
    "tieringSeqNum": "10",
    "parmString": "",
}
{
    "priceItemParmGroupId": "1",
    "toVal": "5000.00000000000000000000",
    "fromVal": "1000.00000000000000000000",
    "timeOfUse": "",
    "priceCompPriceItem": "PI_026",
    "priceCriteria": "NBRTRAN",
    "priceCompTierId": "",
    "tieringSeqNum": "10",
    "parmString": "",
}
{
    "priceItemParmGroupId": "1",
    "toVal": "99999999999.99000000000000000000",
    "fromVal": "5000.00000000000000000000",
    "timeOfUse": "",
    "priceCompPriceItem": "PI_026",
    "priceCriteria": "NBRTRAN",
    "priceCompTierId": "",
    "tieringSeqNum": "10",
    "parmString": "",
}
}
}
{
    "priceCompId": "5417400023",
    "priceCompDescr": "Threshold price",
    "valueAmt": "6.00000000000000000000",
    "tieredFlag": "",
    "pricecomptier":
    {
        {
            "priceItemParmGroupId": "1",
            "toVal": "1000.00000000000000000000",
            "fromVal": "0.00000000000000000000",
            "timeOfUse": "",
            "priceCompPriceItem": "PI_026",
            "priceCriteria": "NBRTRAN",
            "priceCompTierId": "",
            "tieringSeqNum": "10",
            "parmString": "",
        }
        {
            "priceItemParmGroupId": "1",
            "toVal": "5000.00000000000000000000",
            "fromVal": "1000.00000000000000000000",

```

```

        "timeOfUse": "",
        "priceCompPriceItem": "PI_026",
        "priceCriteria": "NBRTRAN",
        "priceCompTierId": "",
        "tieringSeqNum": "10",
        "parmString": "",
    }
}
{
    "priceItemParmGroupId": "1",
    "toVal": "999999999999.99000000000000000000",
    "fromVal": "5000.00000000000000000000",
    "timeOfUse": "",
    "priceCompPriceItem": "PI_026",
    "priceCriteria": "NBRTRAN",
    "priceCompTierId": "",
    "tieringSeqNum": "10",
    "parmString": "",
}
{
    "priceItemParmGroupId": "1",
    "toVal": "1000.00000000000000000000",
    "fromVal": "0.00000000000000000000",
    "timeOfUse": "",
    "priceCompPriceItem": "PI_026",
    "priceCriteria": "NBRTRAN",
    "priceCompTierId": "",
    "tieringSeqNum": "10",
    "parmString": "",
}
{
    "priceItemParmGroupId": "1",
    "toVal": "5000.00000000000000000000",
    "fromVal": "1000.00000000000000000000",
    "timeOfUse": "",
    "priceCompPriceItem": "PI_026",
    "priceCriteria": "NBRTRAN",
    "priceCompTierId": "",
    "tieringSeqNum": "10",
    "parmString": "",
}
}
{
    "priceItemParmGroupId": "1",
    "toVal": "999999999999.99000000000000000000",
    "fromVal": "5000.00000000000000000000",
    "timeOfUse": "",
    "priceCompPriceItem": "PI_026",
    "priceCriteria": "NBRTRAN",
    "priceCompTierId": "",
    "tieringSeqNum": "10",
    "parmString": "",
}
}
}
{
    "priceCompId": "5417400024",
    "priceCompDescr": "Step 1",
    "valueAmt": "5.00000000000000000000",
    "tieredFlag": "",
    "pricecomptier":
    {
        {
            "priceItemParmGroupId": "1",
            "toVal": "1000.00000000000000000000",
            "fromVal": "0.00000000000000000000",

```



```

{
  "priceCompId": "5417400025",
  "priceCompDescr": "Step 2",
  "valueAmt": "4.000000000000000000",
  "tieredFlag": "",
  "pricecomptier":
  {
    {
      "priceItemParmGroupId": "1",
      "toVal": "1000.000000000000000000",
      "fromVal": "0.000000000000000000",
      "timeOfUse": "",
      "priceCompPriceItem": "PI_026",
      "priceCriteria": "NBRTRAN",
      "priceCompTierId": "",
      "tieringSeqNum": "10",
      "parmString": "",
    }
    {
      "priceItemParmGroupId": "1",
      "toVal": "5000.000000000000000000",
      "fromVal": "1000.000000000000000000",
      "timeOfUse": "",
      "priceCompPriceItem": "PI_026",
      "priceCriteria": "NBRTRAN",
      "priceCompTierId": "",
      "tieringSeqNum": "10",
      "parmString": "",
    }
    {
      "priceItemParmGroupId": "1",
      "toVal": "99999999999.990000000000000000",
      "fromVal": "5000.000000000000000000",
      "timeOfUse": "",
      "priceCompPriceItem": "PI_026",
      "priceCriteria": "NBRTRAN",
      "priceCompTierId": "",
      "tieringSeqNum": "10",
      "parmString": "",
    }
    {
      "priceItemParmGroupId": "1",
      "toVal": "1000.000000000000000000",
      "fromVal": "0.000000000000000000",
      "timeOfUse": "",
      "priceCompPriceItem": "PI_026",
      "priceCriteria": "NBRTRAN",
      "priceCompTierId": "",
      "tieringSeqNum": "10",
      "parmString": "",
    }
    {
      "priceItemParmGroupId": "1",
      "toVal": "5000.000000000000000000",
      "fromVal": "1000.000000000000000000",
      "timeOfUse": "",
      "priceCompPriceItem": "PI_026",
      "priceCriteria": "NBRTRAN",
      "priceCompTierId": "",
      "tieringSeqNum": "10",
      "parmString": "",
    }
    {
      "priceItemParmGroupId": "1",

```

```

        "toVal": "999999999999.99000000000000000000",
        "fromVal": "5000.00000000000000000000",
        "timeOfUse": "",
        "priceCompPriceItem": "PI_026",
        "priceCriteria": "NBRTRAN",
        "priceCompTierId": "",
        "tieringSeqNum": "10",
        "parmString": "",
    }
}
}
{
    "priceCompId": "5417400026",
    "priceCompDescr": "Step 3",
    "valueAmt": "3.00000000000000000000",
    "tieredFlag": "",
    "pricecomptier":
    {
        {
            "priceItemParmGroupId": "1",
            "toVal": "1000.00000000000000000000",
            "fromVal": "0.00000000000000000000",
            "timeOfUse": "",
            "priceCompPriceItem": "PI_026",
            "priceCriteria": "NBRTRAN",
            "priceCompTierId": "",
            "tieringSeqNum": "10",
            "parmString": "",
        }
        {
            "priceItemParmGroupId": "1",
            "toVal": "5000.00000000000000000000",
            "fromVal": "1000.00000000000000000000",
            "timeOfUse": "",
            "priceCompPriceItem": "PI_026",
            "priceCriteria": "NBRTRAN",
            "priceCompTierId": "",
            "tieringSeqNum": "10",
            "parmString": "",
        }
    }
    {
        "priceItemParmGroupId": "1",
        "toVal": "999999999999.99000000000000000000",
        "fromVal": "5000.00000000000000000000",
        "timeOfUse": "",
        "priceCompPriceItem": "PI_026",
        "priceCriteria": "NBRTRAN",
        "priceCompTierId": "",
        "tieringSeqNum": "10",
        "parmString": "",
    }
}
{
    "priceItemParmGroupId": "1",
    "toVal": "1000.00000000000000000000",
    "fromVal": "0.00000000000000000000",
    "timeOfUse": "",
    "priceCompPriceItem": "PI_026",
    "priceCriteria": "NBRTRAN",
    "priceCompTierId": "",
    "tieringSeqNum": "10",
    "parmString": "",
}
}
    "priceItemParmGroupId": "1",

```

```

        "toVal": "5000.00000000000000000000",
        "fromVal": "1000.00000000000000000000",
        "timeOfUse": "",
        "priceCompPriceItem": "PI_026",
        "priceCriteria": "NBRTRAN",
        "priceCompTierId": "",
        "tieringSeqNum": "10",
        "parmString": "",
    }
}
    "priceItemParmGroupId": "1",
    "toVal": "999999999999.99000000000000000000",
    "fromVal": "5000.00000000000000000000",
    "timeOfUse": "",
    "priceCompPriceItem": "PI_026",
    "priceCriteria": "NBRTRAN",
    "priceCompTierId": "",
    "tieringSeqNum": "10",
    "parmString": "",
}
}
}
}
}
    "priceListId": "5417730766",
    "priceListDescription": "PriceList -1",
    "priority": "2",
    "validityFlag": "",
    "noOfDays": "10",
    "priceItemCode": "PI_027",
    "priceitemCodeDescr": "V7-Direct Debit",
    "priceAsgnId": "5410009209",
    "priceListStartDate": "2022-02-11",
    "priceListEndDate": "2022-02-21",
    "priceComponent":
    {
        "priceCompId": "5417300038",
        "priceCompDescr": "Basic BK-NBR",
        "valueAmt": "0.15000000000000000000",
        "tieredFlag": "",
        "pricecomptier":
        {
            "priceItemParmGroupId": "",
            "toVal": "",
            "fromVal": "",
            "timeOfUse": "",
            "priceCompPriceItem": "",
            "priceCriteria": "",
            "priceCompTierId": "",
            "tieringSeqNum": "",
            "parmString": "",
        }
    }
}
}
    "priceListId": "5417730766",
    "priceListDescription": "PriceList -1",
    "priority": "2",
    "validityFlag": "",
    "noOfDays": "10",
    "priceItemCode": "PI_028",
    "priceitemCodeDescr": "V8-Cheque Collections",
    "priceAsgnId": "5410009210",

```

```

"priceListStartDate": "2022-02-11",
"priceListEndDate": "2022-02-21",
"priceComponent":
{
  "priceCompId": "5417300040",
  "priceCompDescr": "FLAT",
  "valueAmt": "0.750000000000000000",
  "tieredFlag": "",
  "pricecomptier":
  {
    "priceItemParmGroupId": "",
    "toVal": "",
    "fromVal": "",
    "timeOfUse": "",
    "priceCompPriceItem": "",
    "priceCriteria": "",
    "priceCompTierId": "",
    "tieringSeqNum": "",
    "parmString": ""
  }
}
}
{
"priceListId": "5417730766",
"priceListDescription": "PriceList -1",
"priority": "2",
"validityFlag": "",
"noOfDays": "10",
"priceItemCode": "PI_028",
"priceitemCodeDescr": "V8-Cheque Collections",
"priceAsgnId": "5410009211",
"priceListStartDate": "2022-02-11",
"priceListEndDate": "2022-02-21",
"priceComponent":
{
  "priceCompId": "5417300042",
  "priceCompDescr": "FLAT",
  "valueAmt": "6.670000000000000000",
  "tieredFlag": "",
  "pricecomptier":
  {
    "priceItemParmGroupId": "",
    "toVal": "",
    "fromVal": "",
    "timeOfUse": "",
    "priceCompPriceItem": "",
    "priceCriteria": "",
    "priceCompTierId": "",
    "tieringSeqNum": "",
    "parmString": ""
  }
}
}
}
{
"priceListId": "5417730766",
"priceListDescription": "PriceList -1",
"priority": "2",
"validityFlag": "",
"noOfDays": "10",
"priceItemCode": "PI_028",
"priceitemCodeDescr": "V8-Cheque Collections",
"priceAsgnId": "5410009212",
"priceListStartDate": "2022-02-11",
"priceListEndDate": "2022-02-21",

```

```

    "priceComponent":
    {
        "priceCompId": "5417300044",
        "priceCompDescr": "FLAT",
        "valueAmt": "0.300000000000000000",
        "tieredFlag": "",
        "pricecomptier":
        {
            "priceItemParmGroupId": "",
            "toVal": "",
            "fromVal": "",
            "timeOfUse": "",
            "priceCompPriceItem": "",
            "priceCriteria": "",
            "priceCompTierId": "",
            "tieringSeqNum": "",
            "parmString": "",
        }
    }
}
{
    "priceListId": "5417730766",
    "priceListDescription": "PriceList -1",
    "priority": "2",
    "validityFlag": "",
    "noOfDays": "10",
    "priceItemCode": "PI_028",
    "priceitemCodeDescr": "V8-Cheque Collections",
    "priceAsgnId": "5410009213",
    "priceListStartDate": "2022-02-11",
    "priceListEndDate": "2022-02-21",
    "priceComponent":
    {
        "priceCompId": "5417300046",
        "priceCompDescr": "FLAT",
        "valueAmt": "2.050000000000000000",
        "tieredFlag": "",
        "pricecomptier":
        {
            "priceItemParmGroupId": "",
            "toVal": "",
            "fromVal": "",
            "timeOfUse": "",
            "priceCompPriceItem": "",
            "priceCriteria": "",
            "priceCompTierId": "",
            "tieringSeqNum": "",
            "parmString": "",
        }
    }
}
{
    "priceListId": "5417730766",
    "priceListDescription": "PriceList -1",
    "priority": "2",
    "validityFlag": "",
    "noOfDays": "10",
    "priceItemCode": "PI_029",
    "priceitemCodeDescr": "V9-Domestic Liquidity",
    "priceAsgnId": "5410009214",
    "priceListStartDate": "2022-02-11",
    "priceListEndDate": "2022-02-21",
    "priceComponent":
    {

```

```

        "priceCompId": "5417300048",
        "priceCompDescr": "FLAT",
        "valueAmt": "0.400000000000000000",
        "tieredFlag": "",
        "pricecomptier":
        {
            "priceItemParmGroupId": "",
            "toVal": "",
            "fromVal": "",
            "timeOfUse": "",
            "priceCompPriceItem": "",
            "priceCriteria": "",
            "priceCompTierId": "",
            "tieringSeqNum": "",
            "parmString": "",
        }
    }
}
{
    "priceListId": "5417730766",
    "priceListDescription": "PriceList -1",
    "priority": "2",
    "validityFlag": "",
    "noOfDays": "10",
    "priceItemCode": "PI_030",
    "priceitemCodeDescr": "V10-Third Party Bank",
    "priceAsgnId": "5410009215",
    "priceListStartDate": "2022-02-11",
    "priceListEndDate": "2022-02-21",
    "priceComponent":
    {
        "priceCompId": "5417300050",
        "priceCompDescr": "FLAT",
        "valueAmt": "0.600000000000000000",
        "tieredFlag": "",
        "pricecomptier":
        {
            "priceItemParmGroupId": "",
            "toVal": "",
            "fromVal": "",
            "timeOfUse": "",
            "priceCompPriceItem": "",
            "priceCriteria": "",
            "priceCompTierId": "",
            "tieringSeqNum": "",
            "parmString": "",
        }
    }
}
{
    "priceListId": "5417730766",
    "priceListDescription": "PriceList -1",
    "priority": "2",
    "validityFlag": "",
    "noOfDays": "10",
    "priceItemCode": "PI_031",
    "priceitemCodeDescr": "MT943_SWIFT_01",
    "priceAsgnId": "5417300002",
    "priceListStartDate": "2022-02-11",
    "priceListEndDate": "2022-02-21",
    "priceComponent":
    {
        "priceCompId": "5417300002",
        "priceCompDescr": "FLAT",
    }
}

```

```

    "valueAmt": "16.660000000000000000",
    "tieredFlag": "",
    "pricecomptier":
    {
      "priceItemParmGroupId": "",
      "toVal": "",
      "fromVal": "",
      "timeOfUse": "",
      "priceCompPriceItem": "",
      "priceCriteria": "",
      "priceCompTierId": "",
      "tieringSeqNum": "",
      "parmString": "",
    }
  }
}
"priceListId": "5417730766",
"priceListDescription": "PriceList -1",
"priority": "2",
"validityFlag": "",
"noOfDays": "10",
"priceItemCode": "PI_032",
"priceitemCodeDescr": "MT943_SWIFT_02",
"priceAsgnId": "5410009261",
"priceListStartDate": "2022-02-11",
"priceListEndDate": "2022-02-21",
"priceComponent":
{
  "priceCompId": "5417450002",
  "priceCompDescr": "FLAT",
  "valueAmt": "15.000000000000000000",
  "tieredFlag": "",
  "pricecomptier":
  {
    "priceItemParmGroupId": "",
    "toVal": "",
    "fromVal": "",
    "timeOfUse": "",
    "priceCompPriceItem": "",
    "priceCriteria": "",
    "priceCompTierId": "",
    "tieringSeqNum": "",
    "parmString": "",
  }
}
}
}
}

```

Related Topics

For more information on...	See...
Market Product, Offer, or Bundle View Request and Response - Attribute/Value Pairs in JSON Format	Market Product, Offer, or Bundle View Request and Response - Attribute/Value Pairs in JSON Format on page 3568

C1PRDCTENRL Business Service

The **C1PRDCTENRL** business service enables you to enroll the account to market product, offer, or bundle for the person.

The **C1-CUSTACCSA** algorithm is invoked to create new person, account, and contract, if the person, account, and contract is not created while account enrollment with passing parameter values received for this service. This algorithm is attached at Division's algorithm. This algorithm do the following:

- Checks input service parameters which are required person such as person identifier type, person identifier type/value, account identifier, account identifier type/value, or division are not null. If the parameters are null the system send the error message.
- Checks whether the person id or person identifier type values exist in the system. If the values are exist in the system then it retrieve the person details or set the values to create the new person in the system. The values are:
 - Person Type
 - Primary Person Name Type
 - Person Name
 - Primary Person Identifier Type
 - Primary Person Identifier Type Value
 - Division Code
 - Date of Birth
 - Effective Date
 - Address Type
 - Address Line 1
 - Address Line 2
 - Address Line 3
 - Address Line 4
 - Phone
 - City
 - State
 - Zip Code
 - Country
 - Email
 - Characteristic Effective Date
 - Characteristic Type
 - Characteristic Value
- Get the required default values by fetching values configured at person defaulting template code passed as input to the algorithm. For example, Access Group
- Invoke the personDTO.new.entity() or person BO to create new person in the system.
- Create new account for person on successful person creation/retrieval.
- Get the required default values by fetching values configured at account defaulting template code passed as input to the algorithm.
- Sets required values to create new account in the system. The values are:
 - Customer Class - It can be fetched from account default template.
 - Access Group - It can be fetched from account default template.
 - Person ID - It can be used from retrieved or newly created person.

- Account Source - It can be fetched from account default template.
- Bill Route Type - It can be fetched from account default template. For example, Postal
- Account Category - It can be fetched from account default template. For example, Usage
- Relationship Type - It can be fetched from account default template. For example, Main Customer

The input values from service are:

- Setup Date - Account Opening Date
- Invoice Currency - Account Currency Code
- Account Closure Date - Closing date
- Account Closure Date - Closing date

Note: If the account closing date is provided then should not be less than Account Opening Date.

- Account Number Type code - Account Identifier Type
- Account Number - Account Identifier Value
- Division - Division Code
- Invokes the accountDTO.new.entity() or account BO to create new person in the system.
- On successful account creation, to retrieve the distinct contract types configured at price items associated with market product. The values for contract creation are:
 - Account ID
 - Division
 - Contract Type
 - Start Date
 - End Date

The soft parameter of the algorithm are:

- Person Defaulting Template - This parameter value is person defaulting template code. The parameter value is used to fetch default values required in the process of new person creation process.
- Account Defaulting Template - This parameter value is account defaulting template code. The parameter value is used to fetch default values required in the process of new account creation process.

This business service enables to edit the enrollment status and close/stop the enrollment by using action flag. The valid values of action flag are:

- Active
- Inactive
- Closed

The validation algorithm is executed before persisting the data using the business object. There are different validation for different action flag (Add, Edit, and Close) and different entities (Market Product, Offer and Bundle). The scenarios are:

If...	Then...
The entity type is Market Product and value of action flag is Add	<ul style="list-style-type: none"> • The market product should be in Active status while enrolling to the account. The account enrollment date should be within market product start date and end date.

If...	Then...
	<ul style="list-style-type: none"> The division code of the respective market product should be defined in which the account is opened.
The entity type is Market Product and value of action flag is Edit	
The entity type is Market Product and value of action flag is Close	<ul style="list-style-type: none"> The system should not accept future date as account close date.
The entity type is Offer and value of action flag is Add/Edit	<ul style="list-style-type: none"> The account can be enrolled to only one active offer at a time. The offer should be active while enrolling to the account. The offer subscription date should be within offer start date and end date. The account can be enrolled to the offer only if the market product in which that particular offer is defined is enrolled to the account. If the enrollment status is either Active or Inactive for “Account ID + Offer Code” combination then the same account ID cannot be enrolled to that offer once again. If there is Active offer subscribed to the account then same account cannot enroll to the other offer. The division code of the respective offer should be defined in which the account is opened.
The entity type is Offer and value of action flag is Close	<ul style="list-style-type: none"> The system should not accept future date as account close date.
The entity type is Bundle and value of action flag is Add/Edit	<ul style="list-style-type: none"> The account can be enrolled to only one active bundle at a time. The bundle should be active while enrolling to the account. The bundle subscription date should be within bundle start date and end date. The account numbers which are enrolled to the bundle should belongs to the same person. The division code of the respective offer should be defined in which the account is opened. If there is Active bundle subscribed to the account then same account cannot enroll to the other bundle.
The entity type is Bundle and value of action flag is Close	<ul style="list-style-type: none"> The system should not accept future date as account close date.

You can call this business service from an external system through an inbound web service. You can send the request in XML or JSON format through inbound web service in Oracle Revenue Management and Billing.

If you want to send the request in the XML and/or JSON format, you need to ensure that you create a REST based inbound web service in Oracle Revenue Management and Billing. However, if you want to send the request in the XML format, you can create a SOAP or REST based inbound web service in Oracle Revenue Management and Billing.

To search for viewing the details active market product, offer, or bundle for the person or account, provide the following input parameters:

- Person Detail

- Account Detail
- Market Product Detail
- Offer Detail
- Bundle Detail

Related Topics

For more information on...	See...
Market Product, Offer, or Bundle Enrollment Request in the XML Format	Market Product, Offer, or Bundle Enrollment Request in the XML Format on page 3649
Market Product, Offer, or Bundle Enrollment Response in the XML Format	Market Product, Offer, or Bundle Enrollment Response in the XML Format on page 3650
Market Product, Offer, or Bundle Enrollment Request and Response - Tags in XML Format	Market Product, Offer, or Bundle Enrollment Request and Response - Tags in XML Format on page 3652
Sample Market Product Enrollment Request and Response in the XML Format	Sample Market Product Enrollment Request and Response in the XML Format on page 3660
Sample Market Product Enrollment Edit Request and Response in the XML Format	Sample Market Product Enrollment Edit Request and Response in the XML Format on page 3661
Sample Market Product Enrollment Close Request and Response in the XML Format	Sample Market Product Enrollment Close Request and Response in the XML Format on page 3663
Sample Offer Enrollment Request and Response in the XML Format	Sample Offer Enrollment Request and Response in the XML Format on page 3664
Sample Offer Enrollment Edit Request and Response in the XML Format	Sample Offer Enrollment Edit Request and Response in the XML Format on page 3665
Sample Offer Enrollment Close Request and Response in the XML Format	Sample Offer Enrollment Close Request and Response in the XML Format on page 3667
Sample Bundle Enrollment Request and Response in the XML Format	Sample Bundle Enrollment Request and Response in the XML Format on page 3668
Sample Bundle Enrollment Edit Request and Response in the XML Format	Sample Bundle Enrollment Edit Request and Response in the XML Format on page 3670
Sample Bundle Enrollment Close Request and Response in the XML Format	Sample Bundle Enrollment Close Request and Response in the XML Format on page 3671
Market Product, Offer, or Bundle Enrollment Request in the JSON Format	Market Product, Offer, or Bundle Enrollment Request in the JSON Format on page 3672
Market Product, Offer, or Bundle Enrollment Response in the JSON Format	Market Product, Offer, or Bundle Enrollment Response in the JSON Format on page 3674
Market Product, Offer, or Bundle Enrollment Request and Response - Attribute/Value Pairs in JSON Format	Market Product, Offer, or Bundle Enrollment Request and Response - Attribute/Value Pairs in JSON Format on page 3676
Sample Market Product Enrollment Request and Response in the JSON Format	Sample Market Product Enrollment Request and Response in the JSON Format on page 3683
Sample Market Product Enrollment Edit Request and Response in the JSON Format	Sample Market Product Enrollment Edit Request and Response in the JSON Format on page 3685

For more information on...	See...
Sample Market Product Enrollment Close Request and Response in the JSON Format	Sample Market Product Enrollment Close Request and Response in the JSON Format on page 3687
Sample Offer Enrollment Request and Response in the JSON Format	Sample Offer Enrollment Request and Response in the JSON Format on page 3688
Sample Offer Enrollment Edit Request and Response in the JSON Format	Sample Offer Enrollment Edit Request and Response in the JSON Format on page 3690
Sample Offer Enrollment Close Request and Response in the JSON Format	Sample Offer Enrollment Close Request and Response in the JSON Format on page 3691
Sample Bundle Enrollment Request and Response in the JSON Format	Sample Bundle Enrollment Request and Response in the JSON Format on page 3693
Sample Bundle Enrollment Edit Request and Response in the JSON Format	Sample Bundle Enrollment Edit Request and Response in the JSON Format on page 3695
Sample Bundle Enrollment Close Request and Response in the JSON Format	Sample Bundle Enrollment Close Request and Response in the JSON Format on page 3696

Market Product, Offer, or Bundle Enrollment Request in the XML Format

The following code snippet illustrates how the tags should be nested while sending the market product, offer, or bundle enrollment request in the XML format:

```
<C1PRDCTENRL>
  <enrollment>
    <enrollmentcharlist>
      <characteristicValue></characteristicValue>
      <characteristicType></characteristicType>
      <effectiveDate></effectiveDate>
      <actionFlag></actionFlag>
    </enrollmentcharlist>
    <personDetails>
      <personId></personId>
      <accountdetailslist>
        <accountcharlist>
          <characteristicValue2></characteristicValue2>
          <characteristicType2></characteristicType2>
          <effectiveDate2></effectiveDate2>
          <actionFlag2></actionFlag2>
        </accountcharlist>
        <enrollmentStatus></enrollmentStatus>
        <closingDate></closingDate>
        <accountId></accountId>
        <currency></currency>
        <setUpDate></setUpDate>
        <division></division>
        <accountNumber></accountNumber>
        <accountIdentifierType></accountIdentifierType>
      </accountdetailslist>
      <personcharlist>
        <characteristicValue3></characteristicValue3>
        <characteristicType3></characteristicType3>
        <effectiveDate3></effectiveDate3>
        <actionFlag3></actionFlag3>
      </personcharlist>
      <emailAddress></emailAddress>
      <country></country>
      <state></state>
    </personDetails>
  </enrollment>
</C1PRDCTENRL>
```

```

    <city></city>
    <address4></address4>
    <address3></address3>
    <address2></address2>
    <address1></address1>
    <addressTypeFlg></addressTypeFlg>
    <creationDateTime></creationDateTime>
    <birthDate></birthDate>
    <division2></division2>
    <personIdNumber></personIdNumber>
    <personIdentifiers></personIdentifiers>
    <personNames></personNames>
    <nameType></nameType>
    <personOrBusiness></personOrBusiness>
  </personDetails>
  <startDate></startDate>
  <comments></comments>
  <entityCode></entityCode>
  <entityType></entityType>
  <enrollmentAction></enrollmentAction>
</enrollment>
</C1PRDCTENRL>

```

Related Topics

For more information on...	See...
Market Product, Offer, or Bundle Enrollment Request and Response - Tags in XML Format	Market Product, Offer, or Bundle Enrollment Request and Response - Tags in XML Format on page 3652
Sample Market Product Enrollment Request and Response in the XML Format	Sample Market Product Enrollment Request and Response in the XML Format on page 3660
Sample Market Product Enrollment Edit Request and Response in the XML Format	Sample Market Product Enrollment Edit Request and Response in the XML Format on page 3661
Sample Market Product Enrollment Close Request and Response in the XML Format	Sample Market Product Enrollment Close Request and Response in the XML Format on page 3663
Sample Offer Enrollment Request and Response in the XML Format	Sample Offer Enrollment Request and Response in the XML Format on page 3664
Sample Offer Enrollment Edit Request and Response in the XML Format	Sample Offer Enrollment Edit Request and Response in the XML Format on page 3665
Sample Offer Enrollment Close Request and Response in the XML Format	Sample Offer Enrollment Close Request and Response in the XML Format on page 3667
Sample Bundle Enrollment Request and Response in the XML Format	Sample Bundle Enrollment Request and Response in the XML Format on page 3668
Sample Bundle Enrollment Edit Request and Response in the XML Format	Sample Bundle Enrollment Edit Request and Response in the XML Format on page 3670
Sample Bundle Enrollment Close Request and Response in the XML Format	Sample Bundle Enrollment Close Request and Response in the XML Format on page 3671

Market Product, Offer, or Bundle Enrollment Response in the XML Format

The following code snippet illustrates how the tags should be nested while sending the market product, offer, or bundle enrollment response in the XML format:

```

<C1PRDCTENRL>
  <enrollmentResponse>

```

```

<error>
  <errorDescription></errorDescription>
  <errorMsgText></errorMsgText>
  <messageNumber></messageNumber>
  <erroCategory></erroCategory>
</error>
<enrollResponse>
  <messageText></messageText>
  <productEnrollmentId></productEnrollmentId>
</enrollResponse>
</enrollmentResponse>
<enrollment>
  <enrollmentcharlist>
    <characteristicValue></characteristicValue>
    <characteristicType></characteristicType>
    <effectiveDate></effectiveDate>
    <actionFlag></actionFlag>
  </enrollmentcharlist>
  <personDetails>
    <personId></personId>
    <accountdetailslist>
      <accountcharlist>
        <characteristicValue2></characteristicValue2>
        <characteristicType2></characteristicType2>
        <effectiveDate2></effectiveDate2>
        <actionFlag2></actionFlag2>
      </accountcharlist>
      <enrollmentStatus></enrollmentStatus>
      <closingDate></closingDate>
      <accountId></accountId>
      <currency></currency>
      <setUpDate></setUpDate>
      <division></division>
      <accountNumber></accountNumber>
      <accountIdentifierType></accountIdentifierType>
    </accountdetailslist>
    <personcharlist>
      <characteristicValue3></characteristicValue3>
      <characteristicType3></characteristicType3>
      <effectiveDate3></effectiveDate3>
      <actionFlag3></actionFlag3>
    </personcharlist>
    <emailAddress></emailAddress>
    <country></country>
    <state></state>
    <city></city>
    <address4></address4>
    <address3></address3>
    <address2></address2>
    <address1></address1>
    <addressTypeFlg></addressTypeFlg>
    <creationDateTime></creationDateTime>
    <birthDate></birthDate>
    <division2></division2>
    <personIdNumber></personIdNumber>
    <personIdentifiers></personIdentifiers>
    <personNames></personNames>
    <nameType></nameType>
    <personOrBusiness></personOrBusiness>
  </personDetails>
  <startDate></startDate>
  <comments></comments>
  <entityCode></entityCode>
  <entityType></entityType>

```

```

    <enrollmentAction></enrollmentAction>
  </enrollment>
</C1PRDCTENRL>

```

Related Topics

For more information on...	See...
Market Product, Offer, or Bundle Enrollment Request and Response - Tags in XML Format	Market Product, Offer, or Bundle Enrollment Request and Response - Tags in XML Format on page 3652
Sample Market Product Enrollment Request and Response in the XML Format	Sample Market Product Enrollment Request and Response in the XML Format on page 3660
Sample Market Product Enrollment Edit Request and Response in the XML Format	Sample Market Product Enrollment Edit Request and Response in the XML Format on page 3661
Sample Market Product Enrollment Close Request and Response in the XML Format	Sample Market Product Enrollment Close Request and Response in the XML Format on page 3663
Sample Offer Enrollment Request and Response in the XML Format	Sample Offer Enrollment Request and Response in the XML Format on page 3664
Sample Offer Enrollment Edit Request and Response in the XML Format	Sample Offer Enrollment Edit Request and Response in the XML Format on page 3665
Sample Offer Enrollment Close Request and Response in the XML Format	Sample Offer Enrollment Close Request and Response in the XML Format on page 3667
Sample Bundle Enrollment Request and Response in the XML Format	Sample Bundle Enrollment Request and Response in the XML Format on page 3668
Sample Bundle Enrollment Edit Request and Response in the XML Format	Sample Bundle Enrollment Edit Request and Response in the XML Format on page 3670
Sample Bundle Enrollment Close Request and Response in the XML Format	Sample Bundle Enrollment Close Request and Response in the XML Format on page 3671

Market Product, Offer, or Bundle Enrollment Request and Response - Tags in XML Format

Note: We recommend you to refer the topics [Market Product, Offer, or Bundle Enrollment Request in the XML Format](#) on page 3649 and [Market Product, Offer, or Bundle Enrollment Response in the XML Format](#) on page 3650 in parallel while understanding the below mentioned tags. This will help you to understand how the tags are nested in the XML format.

Before calling the **C1PRDCTENRL** business service through an inbound web service, you need to ensure that the market product, offer, or bundle enrollment request contains the following tags:

Tag Name	Tag Description	Mandatory (Yes or No)
enrollment	Indicates the name of group tag which encapsulates the single enrollment request.	No
		Note: The market product should be enrolled to the account in the system before the offer or bundle is enrolled. The enrollment status for market product should be Active during enrollment and will change to Closed when action flag is pass as close.

Tag Name	Tag Description	Mandatory (Yes or No)
		<p>Note: The market product, offer or bundle should be in Active status while enrolling to the account.</p>
		<p>Note: When the service is called to enroll the account to offer / bundle subscription then offer / bundle subscription will created with the account which is already enrolled to market product.</p>
		<p>Note: The enrollment start date of offer or bundle should be between start date and end date of the offer or bundle definition.</p>
		<p>Note: If there is 'Active Offer or Bundle subscription' exists in the system then same account cannot be enrolled to other offer or bundle.</p>
		<p>Note: Only one account can be enroll to one market product.</p>
		<p>Note: The account can be enrolled to another offer if the existing offer enrollment is closed.</p>
		<p>Note: The account can be enrolled to another bundle if the existing bundle enrollment is closed.</p>
		<p>Note: Multiple accounts of the same person can be enrolled to the bundle. If multiple accounts of the person are enrolled to the bundle then bundle enrollment/ subscription date and enrollment characteristics will be same for all accounts which are enrolled/ subscribed to the bundle.</p>
		<p>Note: The service will create new account if the account is not exist in the system while enrolling a market product to the person account.</p>

Tag Name	Tag Description	Mandatory (Yes or No)
		<p>Note: The service will create new person if the person is not exist in the system while enrolling a market product to the person account.</p>
		<p>Note: The service will find contract types which are assigned to price items of the market product and creates the contract for each contract type.</p>
enrollmentcharlist	Indicates the name of group tag.	No
characteristicValue	Used to specify the characteristic value.	Yes(Conditional)
		<p>Note: This field is required if other characteristic value fields are not specified.</p>
characteristicType	Used to indicate the characteristic type for characteristics.	Yes
effectiveDate	Used to specify the effective date for characteristics.	Yes
actionFlag	<p>Used to indicate for which action service is called. This service is called to add, edit, or close the enrollment. The valid values are:</p> <ul style="list-style-type: none"> • Add • Edit • Close 	Yes
	<p>Note: In edit market product scenario, the account closing date should not be null and it should be greater than account opening date.</p>	
	<p>Note: In edit market product scenario, you can only edit account characteristics. You cannot edit the other details.</p>	
	<p>Note: In edit offer/bundle scenario, you can only modify the status from Active to Inactive or Inactive to Active.</p>	
	<p>Note: If service invokes Close account enrollment request to market product, then it will only close the enrollment to market product and not to offer or bundle.</p>	
	<p>Note: You should invoke another Close request to close enrollment to offer or bundle.</p>	

Tag Name	Tag Description	Mandatory (Yes or No)
	<p>Note: In edit offer/bundle scenario, you can only modify the enrollment status from Active to Inactive or Inactive to Active.</p> <p>Note: If service invokes Close account enrollment request to the market product, then it will only close the enrollment to market product and not to the offer or bundle. The system should invoke another close request to close account enrollment to offer or bundle.</p> <p>Note: To stop or close enrollment the system should pass Action Flag value as Close, the Action Flag value is edit and enrollment is close then the system will throw an error.</p>	
personDetails	Indicates the name of group tag.	No
personId	Used to indicate Person ID.	Yes(Conditional)
		Note: This field is required if person identifier type and value are not specified.
accountdetailslist	Indicates the name of group tag.	No
accountcharlist	Indicates the name of group tag.	No
characteristicValue2	Used to specify the characteristic value.	Yes(Conditional)
		Note: This field is required if other characteristic value fields are not specified.
characteristicType2	Used to specify the characteristic type for characteristics.	Yes
effectiveDate2	Used to specify the effective date for characteristics.	Yes
actionFlag2	<p>Used to indicate for which action service is called. This service is called to add, edit, or close the enrollment. The valid values are:</p> <ul style="list-style-type: none"> • Add • Edit • Close <p>Note: In edit market product scenario, you can only edit account characteristics. You cannot edit the other details.</p>	No
enrollmentStatus	<p>Used to indicate status of enrollment/subscription.</p> <p>The valid values are:</p>	Yes(Conditional)

Tag Name	Tag Description	Mandatory (Yes or No)
	<ul style="list-style-type: none"> • Active • Inactive • Closed 	<p>Note: You can edit enrollment status only if the entity type is either offer or bundle.</p> <p>Note: The Market Product is set to Active during the enrollment and remains the same even after the enrollment end date is stamped. The status will change to Closed only when the action flag passes the Close value.</p> <p>Note:</p> <ul style="list-style-type: none"> • The account can be enrolled to the offer if the status of the existing offer enrollment is Closed. • The account cannot be enrolled to another offer if Active offer enrollment already exists in the system. <p>Note: You cannot enroll to another bundle if one bundle enrollment is already exists for an account in the system. It can be enrolled if the status of existing bundle is Closed.</p> <p>Note: The services which are associated with market product, offer, or bundle will be enrolled to the account. You cannot select or exclude the service available in market product, offer, or bundle.</p>
closingDate	<p>Used to indicate the account close date.</p> <p>Note: This will be considered as account enrollment end date.</p> <p>Note: If the close date is specified, then the close date should be not be less than account opening date.</p>	<p>Yes(Conditional)</p> <p>Note: This field is required if the entity type is market product.</p>
accountId	<p>Used to indicate the account ID.</p>	<p>Yes(Conditional)</p> <p>Note: This field is required if the entity type is market product.</p>
currency	<p>Used to indicate the currency code of account.</p>	<p>Yes</p>

Tag Name	Tag Description	Mandatory (Yes or No)
setUpDate	Used to specify the date which is used as account enrollment date and new account setup date.	Yes
	Note: This date should not be the future date.	
division	Used to indicate the division to which the account belongs.	Yes
accountNumber	Used to indicate the bank account number.	Yes(Conditional)
		Note: This field is required if the account identifier type is specified.
accountIdentifierType	Used to indicate the account identifier type.	Yes(Conditional)
		Note: This field is required if the Account ID is not specified.
personcharlist	Indicates the name of group tag.	No
characteristicValue3	Used to specify the characteristic value.	Yes(Conditional)
		Note: This field is required if other characteristic value fields are not specified.
characteristicType3	Used to specify the characteristic type for characteristics.	Yes
effectiveDate3	Used to specify the effective date for characteristics.	Yes
actionFlag3		
emailAddress	Used to specify email address of the person.	Yes(Conditional)
		Note: This field is required for new customer.
country	Used to indicate the country where person belongs to.	Yes(Conditional)
		Note: This field is required for new customer.
state	Used to indicate the state where person belongs to.	Yes(Conditional)
		Note: This field is required for new customer.
city	Used to indicate the city where person belongs to.	Yes(Conditional)
		Note: This field is required for new customer.
address4	Used to indicate address line.	Yes(Conditional)

Tag Name	Tag Description	Mandatory (Yes or No)
		Note: This field is required for new customer.
address3	Used to indicate address line.	Yes(Conditional) Note: This field is required for new customer.
address2	Used to indicate address line.	Yes(Conditional) Note: This field is required for new customer.
address1	Used to indicate address line.	Yes(Conditional) Note: This field is required for new customer.
addressTypeFlg	Used to indicate type of address.	Yes(Conditional) Note: This field is required for new customer.
creationDateTime	Used to specify the date and time when the person exists in the system.	Yes(Conditional) Note: This field is required for new customer.
birthDate	Used to indicate the date of birth of the person.	Yes(Conditional) Note: This field is required for new customer.
division2	Used to indicate the division to which the person account belongs.	No
personIdNumber	Used to indicate the person ID.	Yes(Conditional) Note: This field is required if the person identifier type and value is not specified.
personIdentifiers	Used to indicate the person identifier.	Yes(Conditional) Note: This field is required either person type or ID.
personNames	Used to specify the person name whose account you want to create.	Yes(Conditional) Note: This field is required for new customer.
nameType	Used to indicate the person name type of the person name.	Yes(Conditional)

Tag Name	Tag Description	Mandatory (Yes or No)
		Note: This field is required for new customer.
personOrBusiness		
startDate	Used to indicate offer/bundle enrollment start date. This date should not be back date. Note: It is applicable only to the offer/bundle .	Yes(Conditional) Note: This field is required if action flag is set to add and entity type is offer or bundle. Note: If the date is not specified then the field is set to the system date.
comments	Used to specify additional comments while enrollment.	No
entityCode	Used to indicate the entity code. Note: Entity is referred to market product, offer or bundle.	Yes
entityType	Used to indicate the type of entity for which enrollment is done.	Yes
enrollmentAction		

The following table lists and describes the tags which appear in the eligible active market products, offers, or bundles derivation response XML format:

Tag Name	Tag Description
error	Indicates the name of group tag.
errorDescription	Displays the error description.
errorMsgText	Displays the error message.
messageNumber	Displays the number of the message.
erroCategory	Displays the category of the error.
enrollResponse	Indicates the name of group tag which encloses the complete response of the service.
messageText	Displays the success message of the enrollment.
productEnrollmentId	Displays the product enrollment ID.

Related Topics

For more information on...	See...
Sample Market Product Enrollment Request and Response in the XML Format	Sample Market Product Enrollment Request and Response in the XML Format on page 3660
Sample Market Product Enrollment Edit Request and Response in the XML Format	Sample Market Product Enrollment Edit Request and Response in the XML Format on page 3661

For more information on...	See...
Sample Market Product Enrollment Close Request and Response in the XML Format	Sample Market Product Enrollment Close Request and Response in the XML Format on page 3663
Sample Offer Enrollment Request and Response in the XML Format	Sample Offer Enrollment Request and Response in the XML Format on page 3664
Sample Offer Enrollment Edit Request and Response in the XML Format	Sample Offer Enrollment Edit Request and Response in the XML Format on page 3665
Sample Offer Enrollment Close Request and Response in the XML Format	Sample Offer Enrollment Close Request and Response in the XML Format on page 3667
Sample Bundle Enrollment Request and Response in the XML Format	Sample Bundle Enrollment Request and Response in the XML Format on page 3668
Sample Bundle Enrollment Edit Request and Response in the XML Format	Sample Bundle Enrollment Edit Request and Response in the XML Format on page 3670
Sample Bundle Enrollment Close Request and Response in the XML Format	Sample Bundle Enrollment Close Request and Response in the XML Format on page 3671

Sample Market Product Enrollment Request and Response in the XML Format

Using the below example, you can enroll market product to the account.

Sample Market Product Enrollment Request in the XML Format

```
<C1PRDCTENRL>
  <enrollment>
    <enrollmentcharlist>
      <characteristicValue></characteristicValue>
      <characteristicType></characteristicType>
      <effectiveDate></effectiveDate>
      <actionFlag></actionFlag>
    </enrollmentcharlist>
    <personDetails>
      <personId></personId>
      <accountdetailslist>
        <accountcharlist>
          <characteristicValue2></characteristicValue2>
          <characteristicType2></characteristicType2>
          <effectiveDate2></effectiveDate2>
          <actionFlag2></actionFlag2>
        </accountcharlist>
        <enrollmentStatus>ACTIVE</enrollmentStatus>
        <closingDate>2023-01-12</closingDate>
        <accountId>Dental Account</accountId>
        <currency>USD</currency>
        <setUpDate>2023-01-01</setUpDate>
        <division>BK</division>
        <accountNumber></accountNumber>
        <accountIdentifierType></accountIdentifierType>
      </accountdetailslist>
      <personcharlist>
        <characteristicValue3></characteristicValue3>
        <characteristicType3></characteristicType3>
        <effectiveDate3></effectiveDate3>
        <actionFlag3></actionFlag3>
      </personcharlist>
      <emailAddress>leticia.walsh@example.com</emailAddress>
      <country>USA</country>
      <state>OH</state>
    </personDetails>
  </enrollment>
</C1PRDCTENRL>
```



```

    <city>CINCINNATI</city>
    <address4></address4>
    <address3>RIVERDALE ROAD</address3>
    <address2>CULLINAN STREET</address2>
    <address1>TREVOR MANSION</address1>
    <addressTypeFlg></addressTypeFlg>
    <creationDateTime></creationDateTime>
    <birthDate>1968-05-10</birthDate>
    <division2>BK</division2>
    <personIdNumber></personIdNumber>
    <personIdentifiers></personIdentifiers>
    <personNames>LETICIA, WALSH</personNames>
    <nameType>PRIM</nameType>
    <personOrBusiness></personOrBusiness>
  </personDetails>
  <startDate></startDate>
  <comments></comments>
  <entityCode>CHECKMP_001</entityCode>
  <entityType>MP</entityType>
  <enrollmentAction>Add</enrollmentAction>
</enrollment>
</C1PRDCTENRL>

```

Sample Market Product Enrollment Response in the XML Format

```

<C1PRDCTENRL>
  <enrollmentResponse>
    <error>
      <errorDescription></errorDescription>
      <errorMsgText></errorMsgText>
      <messageNumber></messageNumber>
      <errorCategory></errorCategory>
    </error>
    <enrollResponse>
      <messageText>Successfully Enrolled</messageText>
      <productEnrollmentId>4368251923</productEnrollmentId>
    </enrollResponse>
  </enrollmentResponse>
</C1PRDCTENRL>

```

Related Topics

For more information on...	See...
Market Product, Offer, or Bundle Enrollment Request and Response - Tags in XML Format	Market Product, Offer, or Bundle Enrollment Request and Response - Tags in XML Format on page 3652

Sample Market Product Enrollment Edit Request and Response in the XML Format

Using the below example, you can edit the market product enrollment.

Sample Market Product Enrollment Edit Request in the XML Format

```

<C1PRDCTENRL>
  <enrollment>
    <enrollmentcharlist>
      <characteristicValue></characteristicValue>
      <characteristicType></characteristicType>
      <effectiveDate></effectiveDate>
      <actionFlag></actionFlag>
    </enrollmentcharlist>
    <personDetails>
      <personId></personId>
      <accountdetailslist>

```

```

        <accountcharlist>
            <characteristicValue2></characteristicValue2>
            <characteristicType2></characteristicType2>
            <effectiveDate2></effectiveDate2>
            <actionFlag2></actionFlag2>
        </accountcharlist>
        <enrollmentStatus>INACTIVE</enrollmentStatus>
        <closingDate>2023-01-12</closingDate>
        <accountId>Dental Account</accountId>
        <currency>USD</currency>
        <setUpDate>2023-01-01</setUpDate>
        <division>BK</division>
        <accountNumber></accountNumber>
        <accountIdentifierType></accountIdentifierType>
    </accountdetailslist>
    <personcharlist>
        <characteristicValue3></characteristicValue3>
        <characteristicType3></characteristicType3>
        <effectiveDate3></effectiveDate3>
        <actionFlag3></actionFlag3>
    </personcharlist>
    <emailAddress>leticia.walsh@example.com</emailAddress>
    <country>USA</country>
    <state>OH</state>
    <city>CINCINNATI</city>
    <address4></address4>
    <address3>RIVERDALE ROAD</address3>
    <address2>CULLINAN STREET</address2>
    <address1>TREVOR MANSION</address1>
    <addressTypeFlg></addressTypeFlg>
    <creationDateTime></creationDateTime>
    <birthDate>1968-05-10</birthDate>
    <division2>BK</division2>
    <personIdNumber></personIdNumber>
    <personIdentifiers></personIdentifiers>
    <personNames>LETICIA,WALSH</personNames>
    <nameType>PRIM</nameType>
    <personOrBusiness></personOrBusiness>
</personDetails>
<startDate></startDate>
<comments></comments>
<entityCode>CHECKMP_001</entityCode>
<entityType>MP</entityType>
<enrollmentAction>Edit</enrollmentAction>
</enrollment>
</C1PRDCTENRL>

```

Sample Market Product Enrollment Edit Response in the XML Format

```

<C1PRDCTENRL>
    <enrollmentResponse>
        <error>
            <errorDescription></errorDescription>
            <errorMsgText></errorMsgText>
            <messageNumber></messageNumber>
            <erroCategory></erroCategory>
        </error>
        <enrollResponse>
            <messageText>Successfully Updated</messageText>
            <productEnrollmentId>4368251923</productEnrollmentId>
        </enrollResponse>
    </enrollmentResponse>
</C1PRDCTENRL>

```

Related Topics

For more information on...	See...
Market Product, Offer, or Bundle Enrollment Request and Response - Tags in XML Format	Market Product, Offer, or Bundle Enrollment Request and Response - Tags in XML Format on page 3652

Sample Market Product Enrollment Close Request and Response in the XML Format

Using the below example, you can close the market product enrollment.

Sample Market Product Enrollment Close Request in the XML Format

```
<C1PRDCTENRL>
  <enrollment>
    <enrollmentcharlist>
      <characteristicValue></characteristicValue>
      <characteristicType></characteristicType>
      <effectiveDate></effectiveDate>
      <actionFlag></actionFlag>
    </enrollmentcharlist>
    <personDetails>
      <personId></personId>
      <accountdetailslist>
        <accountcharlist>
          <characteristicValue2></characteristicValue2>
          <characteristicType2></characteristicType2>
          <effectiveDate2></effectiveDate2>
          <actionFlag2></actionFlag2>
        </accountcharlist>
        <enrollmentStatus>INACTIVE</enrollmentStatus>
        <closingDate>2023-01-12</closingDate>
        <accountId>Dental Account</accountId>
        <currency>USD</currency>
        <setUpDate>2023-01-01</setUpDate>
        <division>BK</division>
        <accountNumber></accountNumber>
        <accountIdentifierType></accountIdentifierType>
      </accountdetailslist>
      <personcharlist>
        <characteristicValue3></characteristicValue3>
        <characteristicType3></characteristicType3>
        <effectiveDate3></effectiveDate3>
        <actionFlag3></actionFlag3>
      </personcharlist>
      <emailAddress>leticia.walsh@example.com</emailAddress>
      <country>USA</country>
      <state>OH</state>
      <city>CINCINNATI</city>
      <address4></address4>
      <address3>RIVERDALE ROAD</address3>
      <address2>CULLINAN STREET</address2>
      <address1>TREVOR MANSION</address1>
      <addressTypeFlg></addressTypeFlg>
      <creationDateTime></creationDateTime>
      <birthDate>1968-05-10</birthDate>
      <division2>BK</division2>
      <personIdNumber></personIdNumber>
      <personIdentifiers></personIdentifiers>
      <personNames>LETICIA, WALSH</personNames>
      <nameType>PRIM</nameType>
      <personOrBusiness></personOrBusiness>
    </personDetails>
  </enrollment>
</C1PRDCTENRL>
```

```

    <startDate></startDate>
    <comments></comments>
    <entityCode>CHECKMP_001</entityCode>
    <entityType>MP</entityType>
    <enrollmentAction>Close</enrollmentAction>
  </enrollment>
</C1PRDCTENRL>

```

Sample Market Product Enrollment Close Response in the XML Format

```

<C1PRDCTENRL>
  <enrollmentResponse>
    <error>
      <errorDescription></errorDescription>
      <errorMsgText></errorMsgText>
      <messageNumber></messageNumber>
      <errorCategory></errorCategory>
    </error>
    <enrollResponse>
      <messageText>Successfully Closed</messageText>
      <productEnrollmentId>4368251923</productEnrollmentId>
    </enrollResponse>
  </enrollmentResponse>
</C1PRDCTENRL>

```

Related Topics

For more information on...	See...
Market Product, Offer, or Bundle Enrollment Request and Response - Tags in XML Format	Market Product, Offer, or Bundle Enrollment Request and Response - Tags in XML Format on page 3652

Sample Offer Enrollment Request and Response in the XML Format

Using the below example, you can enroll offer to the account.

Sample offer Enrollment Request in the XML Format

```

<C1PRDCTENRL>
  <enrollment>
    <enrollmentcharlist>
      <characteristicValue></characteristicValue>
      <characteristicType></characteristicType>
      <effectiveDate></effectiveDate>
      <actionFlag></actionFlag>
    </enrollmentcharlist>
    <personDetails>
      <personId></personId>
      <accountdetailslist>
        <accountcharlist>
          <characteristicValue2></characteristicValue2>
          <characteristicType2></characteristicType2>
          <effectiveDate2></effectiveDate2>
          <actionFlag2></actionFlag2>
        </accountcharlist>
        <enrollmentStatus>ACTIVE</enrollmentStatus>
        <closingDate></closingDate>
        <accountId>Dental Account</accountId>
        <currency>USD</currency>
        <setUpDate>2023-01-01</setUpDate>
        <division>BK</division>
        <accountNumber></accountNumber>
        <accountIdentifierType></accountIdentifierType>
      </accountdetailslist>
    </personDetails>
  </enrollment>
</C1PRDCTENRL>

```

```

    <personcharlist>
      <characteristicValue3></characteristicValue3>
      <characteristicType3></characteristicType3>
      <effectiveDate3></effectiveDate3>
      <actionFlag3></actionFlag3>
    </personcharlist>
    <emailAddress>leticia.walsh@example.com</emailAddress>
    <country>USA</country>
    <state>OH</state>
    <city>CINCINNATI</city>
    <address4></address4>
    <address3>RIVERDALE ROAD</address3>
    <address2>CULLINAN STREET</address2>
    <address1>TREVOR MANSION</address1>
    <addressTypeFlg></addressTypeFlg>
    <creationDateTime></creationDateTime>
    <birthDate>1968-05-10</birthDate>
    <division2>BK</division2>
    <personIdNumber></personIdNumber>
    <personIdentifiers></personIdentifiers>
    <personNames>LETICIA,WALSH</personNames>
    <nameType>PRIM</nameType>
    <personOrBusiness></personOrBusiness>
  </personDetails>
  <startDate></startDate>
  <comments></comments>
  <entityCode>CHECKOFF_01</entityCode>
  <entityType>OFFR</entityType>
  <enrollmentAction>Add</enrollmentAction>
</enrollment>
</C1PRDCTENRL>

```

Sample Offer Enrollment Response in the XML Format

```

<C1PRDCTENRL>
  <enrollmentResponse>
    <error>
      <errorDescription></errorDescription>
      <errorMsgText></errorMsgText>
      <messageNumber></messageNumber>
      <errorCategory></errorCategory>
    </error>
    <enrollResponse>
      <messageText>Successfully Enrolled</messageText>
      <productEnrollmentId>4368251923</productEnrollmentId>
    </enrollResponse>
  </enrollmentResponse>
</C1PRDCTENRL>

```

Related Topics

For more information on...	See...
Market Product, Offer, or Bundle Enrollment Request and Response - Tags in XML Format	Market Product, Offer, or Bundle Enrollment Request and Response - Tags in XML Format on page 3652

Sample Offer Enrollment Edit Request and Response in the XML Format

Using the below example, you can edit the offer enrollment.

Sample Offer Enrollment Edit Request in the XML Format

```

<C1PRDCTENRL>
  <enrollment>

```

```

    <enrollmentcharlist>
      <characteristicValue></characteristicValue>
      <characteristicType></characteristicType>
      <effectiveDate></effectiveDate>
      <actionFlag></actionFlag>
    </enrollmentcharlist>
  </personDetails>
  <personId></personId>
  <accountdetailslist>
    <accountcharlist>
      <characteristicValue2></characteristicValue2>
      <characteristicType2></characteristicType2>
      <effectiveDate2></effectiveDate2>
      <actionFlag2></actionFlag2>
    </accountcharlist>
    <enrollmentStatus>INACTIVE</enrollmentStatus>
    <closingDate></closingDate>
    <accountId>Dental Account</accountId>
    <currency>USD</currency>
    <setUpDate>2023-01-01</setUpDate>
    <division>BK</division>
    <accountNumber></accountNumber>
    <accountIdentifierType></accountIdentifierType>
  </accountdetailslist>
  <personcharlist>
    <characteristicValue3></characteristicValue3>
    <characteristicType3></characteristicType3>
    <effectiveDate3></effectiveDate3>
    <actionFlag3></actionFlag3>
  </personcharlist>
  <emailAddress>leticia.walsh@example.com</emailAddress>
  <country>USA</country>
  <state>OH</state>
  <city>CINCINNATI</city>
  <address4></address4>
  <address3>RIVERDALE ROAD</address3>
  <address2>CULLINAN STREET</address2>
  <address1>TREVOR MANSION</address1>
  <addressTypeFlg></addressTypeFlg>
  <creationDateTime></creationDateTime>
  <birthDate>1968-05-10</birthDate>
  <division2>BK</division2>
  <personIdNumber></personIdNumber>
  <personIdentifiers></personIdentifiers>
  <personNames>LETICIA, WALSH</personNames>
  <nameType>PRIM</nameType>
  <personOrBusiness></personOrBusiness>
</personDetails>
<startDate></startDate>
<comments></comments>
<entityCode>CHECKOFF_01</entityCode>
<entityType>OFFR</entityType>
<enrollmentAction>Edit</enrollmentAction>
</enrollment>
</C1PRDCTENRL>

```

Sample Offer Enrollment Edit Response in the XML Format

```

<C1PRDCTENRL>
  <enrollmentResponse>
    <error>
      <errorDescription></errorDescription>
      <errorMsgText></errorMsgText>
      <messageNumber></messageNumber>
    </error>
  </enrollmentResponse>
</C1PRDCTENRL>

```

```

        <erroCategory></erroCategory>
    </error>
    <enrollResponse>
        <messageText>Successfully Updated</messageText>
        <productEnrollmentId>4368251923</productEnrollmentId>
    </enrollResponse>
</enrollmentResponse>
</C1PRDCTENRL>

```

Related Topics

For more information on...	See...
Market Product, Offer, or Bundle Enrollment Request and Response - Tags in XML Format	Market Product, Offer, or Bundle Enrollment Request and Response - Tags in XML Format on page 3652

Sample Offer Enrollment Close Request and Response in the XML Format

Using the below example, you can close the offer enrollment.

Sample Offer Enrollment Close Request in the XML Format

```

<C1PRDCTENRL>
  <enrollment>
    <enrollmentcharlist>
      <characteristicValue></characteristicValue>
      <characteristicType></characteristicType>
      <effectiveDate></effectiveDate>
      <actionFlag></actionFlag>
    </enrollmentcharlist>
    <personDetails>
      <personId></personId>
      <accountdetailslist>
        <accountcharlist>
          <characteristicValue2></characteristicValue2>
          <characteristicType2></characteristicType2>
          <effectiveDate2></effectiveDate2>
          <actionFlag2></actionFlag2>
        </accountcharlist>
        <enrollmentStatus>INACTIVE</enrollmentStatus>
        <closingDate></closingDate>
        <accountId>Dental Account</accountId>
        <currency>USD</currency>
        <setUpDate>2023-01-01</setUpDate>
        <division>BK</division>
        <accountNumber></accountNumber>
        <accountIdentifierType></accountIdentifierType>
      </accountdetailslist>
      <personcharlist>
        <characteristicValue3></characteristicValue3>
        <characteristicType3></characteristicType3>
        <effectiveDate3></effectiveDate3>
        <actionFlag3></actionFlag3>
      </personcharlist>
      <emailAddress>leticia.walsh@example.com</emailAddress>
      <country>USA</country>
      <state>OH</state>
      <city>CINCINNATI</city>
      <address4></address4>
      <address3>RIVERDALE ROAD</address3>
      <address2>CULLINAN STREET</address2>
      <address1>TREVOR MANSION</address1>
      <addressTypeFlg></addressTypeFlg>
      <creationDateTime></creationDateTime>
    </personDetails>
  </enrollment>
</C1PRDCTENRL>

```

```

    <birthDate>1968-05-10</birthDate>
    <division2>BK</division2>
    <personIdNumber></personIdNumber>
    <personIdentifiers></personIdentifiers>
    <personNames>LETICIA, WALSH</personNames>
    <nameType>PRIM</nameType>
    <personOrBusiness></personOrBusiness>
  </personDetails>
  <startDate></startDate>
  <comments></comments>
  <entityCode>CHECKOFF_01</entityCode>
  <entityType>OFFR</entityType>
  <enrollmentAction>Close</enrollmentAction>
</enrollment>
</C1PRDCTENRL>

```

Sample Offer Enrollment Close Response in the XML Format

```

<C1PRDCTENRL>
  <enrollmentResponse>
    <error>
      <errorDescription></errorDescription>
      <errorMsgText></errorMsgText>
      <messageNumber></messageNumber>
      <errorCategory></errorCategory>
    </error>
    <enrollResponse>
      <messageText>Successfully Closed</messageText>
      <productEnrollmentId>4368251923</productEnrollmentId>
    </enrollResponse>
  </enrollmentResponse>
</C1PRDCTENRL>

```

Related Topics

For more information on...	See...
Market Product, Offer, or Bundle Enrollment Request and Response - Tags in XML Format	Market Product, Offer, or Bundle Enrollment Request and Response - Tags in XML Format on page 3652

Sample Bundle Enrollment Request and Response in the XML Format

Using the below example, you can enroll bundle to the account.

Sample Bundle Enrollment Request in the XML Format

```

<C1PRDCTENRL>
  <enrollment>
    <enrollmentcharlist>
      <characteristicValue></characteristicValue>
      <characteristicType></characteristicType>
      <effectiveDate></effectiveDate>
      <actionFlag></actionFlag>
    </enrollmentcharlist>
    <personDetails>
      <personId></personId>
      <accountdetailslist>
        <accountcharlist>
          <characteristicValue2></characteristicValue2>
          <characteristicType2></characteristicType2>
          <effectiveDate2></effectiveDate2>
          <actionFlag2></actionFlag2>
        </accountcharlist>
      </accountdetailslist>
      <enrollmentStatus>ACTIVE</enrollmentStatus>
    </personDetails>
  </enrollment>
</C1PRDCTENRL>

```



```

        <closingDate></closingDate>
        <accountId>Dental Account</accountId>
        <currency>USD</currency>
        <setUpDate>2023-01-01</setUpDate>
        <division>BK</division>
        <accountNumber></accountNumber>
        <accountIdentifierType></accountIdentifierType>
    </accountdetailslist>
    <personcharlist>
        <characteristicValue3></characteristicValue3>
        <characteristicType3></characteristicType3>
        <effectiveDate3></effectiveDate3>
        <actionFlag3></actionFlag3>
    </personcharlist>
    <emailAddress>leticia.walsh@example.com</emailAddress>
    <country>USA</country>
    <state>OH</state>
    <city>CINCINNATI</city>
    <address4></address4>
    <address3>RIVERDALE ROAD</address3>
    <address2>CULLINAN STREET</address2>
    <address1>TREVOR MANSION</address1>
    <addressTypeFlg></addressTypeFlg>
    <creationDateTime></creationDateTime>
    <birthDate>1968-05-10</birthDate>
    <division2>BK</division2>
    <personIdNumber></personIdNumber>
    <personIdentifiers></personIdentifiers>
    <personNames>LETICIA, WALSH</personNames>
    <nameType>PRIM</nameType>
    <personOrBusiness></personOrBusiness>
</personDetails>
<startDate></startDate>
<comments></comments>
<entityCode>CHECKBUND_003</entityCode>
<entityType>BNDL</entityType>
<enrollmentAction>Add</enrollmentAction>
</enrollment>
</C1PRDCTENRL>

```

Sample Bundle Enrollment Response in the XML Format

```

<C1PRDCTENRL>
    <enrollmentResponse>
        <error>
            <errorDescription></errorDescription>
            <errorMsgText></errorMsgText>
            <messageNumber></messageNumber>
            <erroCategory></erroCategory>
        </error>
        <enrollResponse>
            <messageText>Successfully Enrolled</messageText>
            <productEnrollmentId>4368251923</productEnrollmentId>
        </enrollResponse>
    </enrollmentResponse>
</C1PRDCTENRL>

```

Related Topics

For more information on...	See...
Market Product, Offer, or Bundle Enrollment Request and Response - Tags in XML Format	Market Product, Offer, or Bundle Enrollment Request and Response - Tags in XML Format on page 3652

Sample Bundle Enrollment Edit Request and Response in the XML Format

Using the below example, you can edit the bundle enrollment.

Sample Bundle Enrollment Edit Request in the XML Format

```
<C1PRDCTENRL>
  <enrollment>
    <enrollmentcharlist>
      <characteristicValue></characteristicValue>
      <characteristicType></characteristicType>
      <effectiveDate></effectiveDate>
      <actionFlag></actionFlag>
    </enrollmentcharlist>
    <personDetails>
      <personId></personId>
      <accountdetailslist>
        <accountcharlist>
          <characteristicValue2></characteristicValue2>
          <characteristicType2></characteristicType2>
          <effectiveDate2></effectiveDate2>
          <actionFlag2></actionFlag2>
        </accountcharlist>
        <enrollmentStatus>INACTIVE</enrollmentStatus>
        <closingDate></closingDate>
        <accountId>Dental Account</accountId>
        <currency>USD</currency>
        <setUpDate>2023-01-01</setUpDate>
        <division>BK</division>
        <accountNumber></accountNumber>
        <accountIdentifierType></accountIdentifierType>
      </accountdetailslist>
      <personcharlist>
        <characteristicValue3></characteristicValue3>
        <characteristicType3></characteristicType3>
        <effectiveDate3></effectiveDate3>
        <actionFlag3></actionFlag3>
      </personcharlist>
      <emailAddress>leticia.walsh@example.com</emailAddress>
      <country>USA</country>
      <state>OH</state>
      <city>CINCINNATI</city>
      <address4></address4>
      <address3>RIVERDALE ROAD</address3>
      <address2>CULLINAN STREET</address2>
      <address1>TREVOR MANSION</address1>
      <addressTypeFlg></addressTypeFlg>
      <creationDateTime></creationDateTime>
      <birthDate>1968-05-10</birthDate>
      <division2>BK</division2>
      <personIdNumber></personIdNumber>
      <personIdentifiers></personIdentifiers>
      <personNames>LETICIA, WALSH</personNames>
      <nameType>PRIM</nameType>
      <personOrBusiness></personOrBusiness>
    </personDetails>
    <startDate></startDate>
    <comments></comments>
    <entityCode>CHECKBUND_003</entityCode>
    <entityType>BNDL</entityType>
    <enrollmentAction>Edit</enrollmentAction>
  </enrollment>
</C1PRDCTENRL>
```

Sample Bundle Enrollment Edit Response in the XML Format

```

<C1PRDCTENRL>
  <enrollmentResponse>
    <error>
      <errorDescription></errorDescription>
      <errorMsgText></errorMsgText>
      <messageNumber></messageNumber>
      <erroCategory></erroCategory>
    </error>
    <enrollResponse>
      <messageText>Successfully updated</messageText>
      <productEnrollmentId>4368251923</productEnrollmentId>
    </enrollResponse>
  </enrollmentResponse>
</C1PRDCTENRL>

```

Related Topics

For more information on...	See...
Market Product, Offer, or Bundle Enrollment Request and Response - Tags in XML Format	Market Product, Offer, or Bundle Enrollment Request and Response - Tags in XML Format on page 3652

Sample Bundle Enrollment Close Request and Response in the XML Format

Using the below example, you can close the bundle enrollment.

Sample Bundle Enrollment Close Request in the XML Format

```

<C1PRDCTENRL>
  <enrollment>
    <enrollmentcharlist>
      <characteristicValue></characteristicValue>
      <characteristicType></characteristicType>
      <effectiveDate></effectiveDate>
      <actionFlag></actionFlag>
    </enrollmentcharlist>
    <personDetails>
      <personId></personId>
      <accountdetailslist>
        <accountcharlist>
          <characteristicValue2></characteristicValue2>
          <characteristicType2></characteristicType2>
          <effectiveDate2></effectiveDate2>
          <actionFlag2></actionFlag2>
        </accountcharlist>
        <enrollmentStatus>INACTIVE</enrollmentStatus>
        <closingDate></closingDate>
        <accountId>Dental Account</accountId>
        <currency>USD</currency>
        <setUpDate>2023-01-01</setUpDate>
        <division>BK</division>
        <accountNumber></accountNumber>
        <accountIdentifierType></accountIdentifierType>
      </accountdetailslist>
      <personcharlist>
        <characteristicValue3></characteristicValue3>
        <characteristicType3></characteristicType3>
        <effectiveDate3></effectiveDate3>
        <actionFlag3></actionFlag3>
      </personcharlist>
      <emailAddress>leticia.walsh@example.com</emailAddress>
      <country>USA</country>
    </personDetails>
  </enrollment>
</C1PRDCTENRL>

```

```

    <state>OH</state>
    <city>CINCINNATI</city>
    <address4></address4>
    <address3>RIVERDALE ROAD</address3>
    <address2>CULLINAN STREET</address2>
    <address1>TREVOR MANSION</address1>
    <addressTypeFlg></addressTypeFlg>
    <creationDateTime></creationDateTime>
    <birthDate>1968-05-10</birthDate>
    <division2>BK</division2>
    <personIdNumber></personIdNumber>
    <personIdentifiers></personIdentifiers>
    <personNames>LETICIA, WALSH</personNames>
    <nameType>PRIM</nameType>
    <personOrBusiness></personOrBusiness>
  </personDetails>
  <startDate></startDate>
  <comments></comments>
  <entityCode>CHECKBUND_003</entityCode>
  <entityType>BNDL</entityType>
  <enrollmentAction>Close</enrollmentAction>
</enrollment>
</C1PRDCTENRL>

```

Sample Bundle Enrollment Close Response in the XML Format

```

<C1PRDCTENRL>
  <enrollmentResponse>
    <error>
      <errorDescription></errorDescription>
      <errorMsgText></errorMsgText>
      <messageNumber></messageNumber>
      <errorCategory></errorCategory>
    </error>
    <enrollResponse>
      <messageText>Successfully closed</messageText>
      <productEnrollmentId>4368251923</productEnrollmentId>
    </enrollResponse>
  </enrollmentResponse>
</C1PRDCTENRL>

```

Related Topics

For more information on...	See...
Market Product, Offer, or Bundle Enrollment Request and Response - Tags in XML Format	Market Product, Offer, or Bundle Enrollment Request and Response - Tags in XML Format on page 3652

Market Product, Offer, or Bundle Enrollment Request in the JSON Format

The following code snippet illustrates how the attribute/value pairs should be structured while receiving the market product, offer, or bundle enrollment request in the JSON format:

```

{
  "C1PRDCTENRL" :
  {
    "enrollment" : "",
    "enrollmentcharlist" :
    {
      "characteristicValue" : "",
      "characteristicType" : "",
      "effectiveDate" : "",
      "actionFlag" : ""
    }
  }
}

```

```

"personDetails":
{
  "personId": "",
  "accountdetailslist":
  {
    "accountcharlist":
    {
      "characteristicValue2": "",
      "characteristicType2": "",
      "effectiveDate2": "",
      "actionFlag2": "",
    }
    "enrollmentStatus": "",
    "closingDate": "",
    "accountId": "",
    "currency": "",
    "setUpDate": "",
    "division": "",
    "accountNumber": "",
    "accountIdentifierType": "",
  }
  "personcharlist":
  {
    "characteristicValue3": "",
    "characteristicType3": "",
    "effectiveDate3": "",
    "actionFlag3": "",
  }
  "emailAddress": "",
  "country": "",
  "state": "",
  "city": "",
  "address4": "",
  "address3": "",
  "address2": "",
  "address1": "",
  "addressTypeFlg": "",
  "creationDateTime": "",
  "birthDate": "",
  "division2": "",
  "personIdNumber": "",
  "personIdentifiers": "",
  "personNames": "",
  "nameType": "",
  "personOrBusiness": "",
}
"startDate": "",
"comments": "",
"entityCode": "",
"entityType": "",
"enrollmentAction": "",
}
}
}

```

Related Topics

For more information on...	See...
Market Product, Offer, or Bundle Enrollment Request and Response - Attribute/Value Pairs in JSON Format	Market Product, Offer, or Bundle Enrollment Request and Response - Attribute/Value Pairs in JSON Format on page 3676

For more information on...	See...
Sample Market Product Enrollment Request and Response in the JSON Format	Sample Market Product Enrollment Request and Response in the JSON Format on page 3683
Sample Market Product Enrollment Edit Request and Response in the JSON Format	Sample Market Product Enrollment Edit Request and Response in the JSON Format on page 3685
Sample Market Product Enrollment Close Request and Response in the JSON Format	Sample Market Product Enrollment Close Request and Response in the JSON Format on page 3687
Sample Offer Enrollment Request and Response in the JSON Format	Sample Offer Enrollment Request and Response in the JSON Format on page 3688
Sample Offer Enrollment Edit Request and Response in the JSON Format	Sample Offer Enrollment Edit Request and Response in the JSON Format on page 3690
Sample Offer Enrollment Close Request and Response in the JSON Format	Sample Offer Enrollment Close Request and Response in the JSON Format on page 3691
Sample Bundle Enrollment Request and Response in the JSON Format	Sample Bundle Enrollment Request and Response in the JSON Format on page 3693
Sample Bundle Enrollment Edit Request and Response in the JSON Format	Sample Bundle Enrollment Edit Request and Response in the JSON Format on page 3695
Sample Bundle Enrollment Close Request and Response in the JSON Format	Sample Bundle Enrollment Close Request and Response in the JSON Format on page 3696

Market Product, Offer, or Bundle Enrollment Response in the JSON Format

The following code snippet illustrates how the attribute/value pairs should be structured while sending the market product, offer, or bundle enrollment response in the JSON format:

```
{
  "C1PRDCTENRL" :
  {
    "enrollmentResponse" :
    {
      "error" :
      {
        "errorDescription" : "",
        "errorMsgText" : "",
        "messageNumber" : "",
        "erroCategory" : "",
      }
      "enrollResponse" :
      {
        "messageText" : "",
        "productEnrollmentId" : "",
      }
    }
    "enrollment" : "",
    {
      "enrollmentcharlist" :
      {
        "characteristicValue" : "",
        "characteristicType" : "",
        "effectiveDate" : "",
        "actionFlag" : "",
      }
      "personDetails" :
    }
  }
}
```

```

    "personId": "",
    "accountdetailslist":
    {
      "accountcharlist":
      {
        "characteristicValue2": "",
        "characteristicType2": "",
        "effectiveDate2": "",
        "actionFlag2": "",
      }
      "enrollmentStatus": "",
      "closingDate": "",
      "accountId": "",
      "currency": "",
      "setUpDate": "",
      "division": "",
      "accountNumber": "",
      "accountIdentifierType": "",
    }
    "personcharlist":
    {
      "characteristicValue3": "",
      "characteristicType3": "",
      "effectiveDate3": "",
      "actionFlag3": "",
    }
    "emailAddress": "",
    "country": "",
    "state": "",
    "city": "",
    "address4": "",
    "address3": "",
    "address2": "",
    "address1": "",
    "addressTypeFlg": "",
    "creationDateTime": "",
    "birthDate": "",
    "division2": "",
    "personIdNumber": "",
    "personIdentifiers": "",
    "personNames": "",
    "nameType": "",
    "personOrBusiness": "",
  }
  "startDate": "",
  "comments": "",
  "entityCode": "",
  "entityType": "",
  "enrollmentAction": "",
}
}
}

```

Related Topics

For more information on...	See...
Market Product, Offer, or Bundle Enrollment Request and Response - Attribute/Value Pairs in JSON Format	Market Product, Offer, or Bundle View Request and Response - Attribute/Value Pairs in JSON Format on page 3568

For more information on...	See...
Sample Market Product Enrollment Request and Response in the JSON Format	Sample Market Product Enrollment Request and Response in the JSON Format on page 3683
Sample Market Product Enrollment Edit Request and Response in the JSON Format	Sample Market Product Enrollment Edit Request and Response in the JSON Format on page 3685
Sample Market Product Enrollment Close Request and Response in the JSON Format	Sample Market Product Enrollment Close Request and Response in the JSON Format on page 3687
Sample Offer Enrollment Request and Response in the JSON Format	Sample Offer Enrollment Request and Response in the JSON Format on page 3688
Sample Offer Enrollment Edit Request and Response in the JSON Format	Sample Offer Enrollment Edit Request and Response in the JSON Format on page 3690
Sample Offer Enrollment Close Request and Response in the JSON Format	Sample Offer Enrollment Close Request and Response in the JSON Format on page 3691
Sample Bundle Enrollment Request and Response in the JSON Format	Sample Bundle Enrollment Request and Response in the JSON Format on page 3693
Sample Bundle Enrollment Edit Request and Response in the JSON Format	Sample Bundle Enrollment Edit Request and Response in the JSON Format on page 3695
Sample Bundle Enrollment Close Request and Response in the JSON Format	Sample Bundle Enrollment Close Request and Response in the JSON Format on page 3696

Market Product, Offer, or Bundle Enrollment Request and Response - Attribute/Value Pairs in JSON Format

Note: We recommend you to refer the topics [Market Product, Offer, or Bundle Enrollment Request in the JSON Format](#) on page 3672 and [Market Product, Offer, or Bundle Enrollment Response in the JSON Format](#) on page 3674 in parallel while understanding the below mentioned attributes/values. This will help you to understand how the attributes/values are structured in the JSON format.

Before calling the **C1PRDCTENRL** business service through an inbound web service, you need to ensure that the market product, offer, or bundle enrollment request contains the following attribute:

Attribute Name	Attribute Description	Mandatory (Yes or No)
enrollment	Indicates the name of group attribute which encapsulates the single enrollment request.	No Note: The market product should be enroll to the account in the system before the offer or bundle is enrolled. Note: The market product, offer or bundle should be in active status while enrolling to the account. Note: The enrollment start date of offer or bundle should be between start date and end date of the offer or bundle definition.

Attribute Name	Attribute Description	Mandatory (Yes or No)
		<p>Note: If there is 'Active Offer or Bundle subscription' exists in the system then same account cannot be enrolled to other offer or bundle.</p> <p>Note: Only one account can be enroll to one market product, offer, or bundle.</p> <p>Note: Multiple accounts of the same person can be enrolled to the bundle. If multiple accounts of the person are enrolled to the bundle then bundle enrollment/subscription date and enrollment characteristics will be same for all accounts which are enrolled/subscribed to the bundle.</p> <p>Note: The service will create new account if the account is not exist in the system while enrolling a market product to the person account.</p> <p>Note: The service will create new person if the person is not exist in the system while enrolling a market product to the person account.</p> <p>Note: The service will find contract types which are assigned to price items of the market product and creates the contract for each contract type.</p>
enrollmentcharlist	Indicates the name of group attribute.	No
characteristicValue	Used to specify the characteristic value.	Yes(Conditional) <p>Note: This field is required if other characteristic value fields are not specified.</p>
characteristicType	Used to indicate the characteristic type for characteristics.	Yes
effectiveDate	Used to specify the effective date for characteristics.	Yes

Attribute Name	Attribute Description	Mandatory (Yes or No)
actionFlag	Used to indicate for which action service is called. This service is called to add, edit, or close the enrollment. The valid values are: <ul style="list-style-type: none"> • Add • Edit • Close 	Yes
	Note: In edit market product scenario, the account closing date should not be null and it should be greater than account opening date.	
	Note: In edit market product scenario, you can only edit account characteristics. You cannot edit the other details.	
	Note: In edit offer/bundle scenario, you can only modify the status from Active to Inactive or Inactive to Active .	
	Note: If service invokes Close account enrollment request to market product, then it will only close the enrollment to market product and not to offer or bundle.	
	Note: You should invoke another Close request to close enrollment to offer or bundle.	
personDetails	Indicates the name of group attribute.	No
personId	Used to indicate Person ID.	Yes(Conditional)
		Note: This field is required if person identifier type and value are not specified.
accountdetaillist	Indicates the name of group attribute.	No
accountcharlist	Indicates the name of group attribute.	No
characteristicValue2	Used to specify the characteristic value.	Yes(Conditional)
		Note: This field is required if other characteristic value fields are not specified.
characteristicType2	Used to specify the characteristic type for characteristics.	Yes
effectiveDate2	Used to specify the effective date for characteristics.	Yes
actionFlag2	Used to indicate for which action service is called. This service is called to add, edit, or close the enrollment. The valid values are:	No

Attribute Name	Attribute Description	Mandatory (Yes or No)
	<ul style="list-style-type: none"> • Add • Edit • Close <p>Note: In edit market product scenario, you can only edit account characteristics. You cannot edit the other details.</p> <p>Note: In edit offer/bundle scenario, you can only modify the status from Active to Inactive or Inactive to Active.</p> <p>Note: If service invokes Close account enrollment request to the market product, then it will only close the enrollment to market product and not to the offer or bundle.</p> <p>Note: You should invoke another Close request to close enrollment to offer or bundle.</p>	
enrollmentStatus	<p>Used to indicate status of enrollment/subscription.</p> <p>The valid values are:</p> <ul style="list-style-type: none"> • Active • Inactive • Closed 	<p>Yes(Conditional)</p> <p>Note: You can edit enrollment status only if the entity type is either offer or bundle.</p> <p>Note: The Market Product is set to Active during the enrollment and remains the same even after the enrollment end date is stamped. The status will change to Closed only when the action flag passes the Close value.</p> <p>Note:</p> <ul style="list-style-type: none"> • The account can be enrolled to the offer if the status of the existing offer enrollment is Closed. • The account cannot be enrolled to another offer if Active offer enrollment already exists in the system. <p>Note: You cannot enroll to another bundle if one bundle enrollment is already exists for an account in the system. It can be enrolled if the status of existing bundle is Closed.</p>

Attribute Name	Attribute Description	Mandatory (Yes or No)
		Note: The services which are associated with market product, offer, or bundle will be enrolled to the account. You cannot select or exclude the service available in market product, offer, or bundle.
closingDate	Used to indicate the account close date.	Yes(Conditional)
	Note: This will be considered as account enrollment end date.	Note: This field is required if the entity type is market product.
	Note: If the close date is specified, then the close date should be not be less than account opening date.	
accountId	Used to indicate the account ID.	Yes(Conditional)
		Note: This field is required if the entity type is market product.
currency	Used to indicate the currency code of account.	Yes
setUpDate	Used to specify the date which is used as account enrollment date and new account setup date.	Yes
	Note: This date should not be the future date.	
division	Used to indicate the division to which the account belongs.	Yes
accountNumber	Used to indicate the bank account number.	Yes(Conditional)
		Note: This field is required if the account identifier type is specified.
accountIdentifierType	Used to indicate the account identifier type.	Yes(Conditional)
		Note: This field is required if the Account ID is not specified.
personcharlist	Indicates the name of group attribute.	No
characteristicValue3	Used to specify the characteristic value.	Yes(Conditional)
		Note: This field is required if other characteristic value fields are not specified.
characteristicType3	Used to specify the characteristic type for characteristics.	Yes
effectiveDate3	Used to specify the effective date for characteristics.	Yes
actionFlag3		

Attribute Name	Attribute Description	Mandatory (Yes or No)
emailAddress	Used to specify email address of the person.	Yes(Conditional) Note: This field is required for new customer.
country	Used to indicate the country where person belongs to.	Yes(Conditional) Note: This field is required for new customer.
state	Used to indicate the state where person belongs to.	Yes(Conditional) Note: This field is required for new customer.
city	Used to indicate the city where person belongs to.	Yes(Conditional) Note: This field is required for new customer.
address4	Used to indicate address line.	Yes(Conditional) Note: This field is required for new customer.
address3	Used to indicate address line.	Yes(Conditional) Note: This field is required for new customer.
address2	Used to indicate address line.	Yes(Conditional) Note: This field is required for new customer.
address1	Used to indicate address line.	Yes(Conditional) Note: This field is required for new customer.
addressTypeFlg	Used to indicate type of address.	Yes(Conditional) Note: This field is required for new customer.
creationDateTime	Used to specify the date and time when the person exists in the system.	Yes(Conditional) Note: This field is required for new customer.
birthDate	Used to indicate the date of birth of the person.	Yes(Conditional)

Attribute Name	Attribute Description	Mandatory (Yes or No)
		Note: This field is required for new customer.
division2	Used to indicate the division to which the person account belongs.	No
personIdNumber	Used to indicate the person ID.	Yes(Conditional) Note: This field is required if the person identifier type and value is not specified.
personIdentifiers	Used to indicate the person identifier type and person ID.	Yes(Conditional) Note: This field is required either person type or ID.
personNames	Used to specify the person name whose account you want to create.	Yes(Conditional) Note: This field is required for new customer.
nameType	Used to indicate the person name type of the person name.	Yes(Conditional) Note: This field is required for new customer.
personOrBusiness		
startDate	Used to indicate offer/bundle enrollment start date. This date should not be back date. Note: It is applicable only to the offer/bundle .	Yes(Conditional) Note: This field is required if action flag is set to add and entity type is offer or bundle. Note: If the date is not specified then the field is set to the system date.
comments	Used to specify additional comments while enrollment.	No
entityCode	Used to indicate the entity code. Note: Entity is referred to market product, offer or bundle.	Yes
entityType	Used to indicate the type of entity for which enrollment is done.	Yes
enrollmentAction		

The following table lists and describes the attribute which appear in the eligible active market products, offers, or bundles derivation response JSON format:

Attribute Name	Attribute Description
error	Indicates the name of group attribute.
errorDescription	Displays the error description.
errorMsgText	Displays the error message.
messageNumber	Displays the number of the message.
erroCategory	Displays the category of the error.
enrollResponse	Indicates the name of group attribute which encloses the complete response of the service.
messageText	Displays the success message of the enrollment.
productEnrollmentId	Displays the product enrollment ID.

Related Topics

For more information on...	See...
Sample Market Product Enrollment Request and Response in the JSON Format	Sample Market Product Enrollment Request and Response in the JSON Format on page 3683
Sample Market Product Enrollment Edit Request and Response in the JSON Format	Sample Market Product Enrollment Edit Request and Response in the JSON Format on page 3685
Sample Market Product Enrollment Close Request and Response in the JSON Format	Sample Market Product Enrollment Close Request and Response in the JSON Format on page 3687
Sample Offer Enrollment Request and Response in the JSON Format	Sample Offer Enrollment Request and Response in the JSON Format on page 3688
Sample Offer Enrollment Edit Request and Response in the JSON Format	Sample Offer Enrollment Edit Request and Response in the JSON Format on page 3690
Sample Offer Enrollment Close Request and Response in the JSON Format	Sample Offer Enrollment Close Request and Response in the JSON Format on page 3691
Sample Bundle Enrollment Request and Response in the JSON Format	Sample Bundle Enrollment Request and Response in the JSON Format on page 3693
Sample Bundle Enrollment Edit Request and Response in the JSON Format	Sample Bundle Enrollment Edit Request and Response in the JSON Format on page 3695
Sample Bundle Enrollment Close Request and Response in the JSON Format	Sample Bundle Enrollment Close Request and Response in the JSON Format on page 3696

Sample Market Product Enrollment Request and Response in the JSON Format

Using the below example, you can enroll market product to the account.

Sample Market Product Enrollment Request in the JSON Format

```
{
  "C1PRDCTENRL" :
  {
    "enrollment" : " ",
    {
      "enrollmentcharlist" :
      {
        "characteristicValue" : " ",
        "characteristicType" : " ",
        "effectiveDate" : " ",

```

```

        "actionFlag": "",
    }
    "personDetails":
    {
        "personId": "",
        "accountdetailslist":
        {
            "accountcharlist":
            {
                "characteristicValue2": "",
                "characteristicType2": "",
                "effectiveDate2": "",
                "actionFlag2": "",
            }
            "enrollmentStatus": "ACTIVE",
            "closingDate": "2023-01-12",
            "accountId": "Dental Account",
            "currency": "USD",
            "setUpDate": "2023-01-01",
            "division": "BK",
            "accountNumber": "",
            "accountIdentifierType": "",
        }
        "personcharlist":
        {
            "characteristicValue3": "",
            "characteristicType3": "",
            "effectiveDate3": "",
            "actionFlag3": "",
        }
        "emailAddress": "leticia.walsh@example.com",
        "country": "USA",
        "state": "OH",
        "city": "CINCINNATI",
        "address4": "",
        "address3": "RIVERDALE ROAD",
        "address2": "CULLINAN STREET",
        "address1": "TREVOR MANSION",
        "addressTypeFlg": "",
        "creationDateTime": "",
        "birthDate": "1968-05-10",
        "division2": "BK",
        "personIdNumber": "",
        "personIdentifiers": "",
        "personNames": "LETICIA,WALSH",
        "nameType": "PRIM",
        "personOrBusiness": "",
    }
    "startDate": "",
    "comments": "",
    "entityCode": "CHECKMP_001",
    "entityType": "MP",
    "enrollmentAction": "Add",
}
}
}

```

Sample Market Product Enrollment Response in the JSON Format

```

{
    "C1PRDCTENRL":
    {
        "enrollmentResponse":
        {

```



```

      "error":
      {
        "errorDescription" : "",
        "errorMsgText" : "",
        "messageNumber" : "",
        "erroCategory" : "",
      }
      "enrollResponse":
      {
        "messageText" : "Successfully Enrolled",
        "productEnrollmentId" : "4368251923",
      }
    }
  }
}

```

Related Topics

For more information on...	See...
Market Product, Offer, or Bundle Enrollment Request and Response - Attribute/Value Pairs in JSON Format	Market Product, Offer, or Bundle Enrollment Request and Response - Attribute/Value Pairs in JSON Format on page 3676

Sample Market Product Enrollment Edit Request and Response in the JSON Format

Using the below example, you can edit the market product enrollment.

Sample Market Product Enrollment Edit Request in the JSON Format

```

{
  "C1PRDCTENRL" :
  {
    "enrollment": "",
    {
      "enrollmentcharlist":
      {
        "characteristicValue": "",
        "characteristicType": "",
        "effectiveDate": "",
        "actionFlag": "",
      }
      "personDetails":
      {
        "personId": "",
        "accountdetailslist":
        {
          "accountcharlist":
          {
            "characteristicValue2": "",
            "characteristicType2": "",
            "effectiveDate2": "",
            "actionFlag2": "",
          }
          "enrollmentStatus": "INACTIVE",
          "closingDate": "2023-01-12",
          "accountId": "Dental Account",
          "currency": "USD",
          "setUpDate": "2023-01-01",
          "division": "BK",
          "accountNumber": "",
          "accountIdentifierType": "",
        }
      }
    }
  }
}

```

```

        "personcharlist":
        {
            "characteristicValue3": "",
            "characteristicType3": "",
            "effectiveDate3": "",
            "actionFlag3": "",
        }
        "emailAddress": "leticia.walsh@example.com",
        "country": "USA",
        "state": "OH",
        "city": "CINCINNATI",
        "address4": "",
        "address3": "RIVERDALE ROAD",
        "address2": "CULLINAN STREET",
        "address1": "TREVOR MANSION",
        "addressTypeFlg": "",
        "creationDateTime": "",
        "birthDate": "1968-05-10",
        "division2": "BK",
        "personIdNumber": "",
        "personIdentifiers": "",
        "personNames": "LETICIA,WALSH",
        "nameType": "PRIM",
        "personOrBusiness": "",
    }
    "startDate": "",
    "comments": "",
    "entityCode": "CHECKMP_001",
    "entityType": "MP",
    "enrollmentAction": "Edit",
}
}
}

```

Sample Market Product Enrollment Edit Response in the JSON Format

```

{
  "C1PRDCTENRL":
  {
    "enrollmentResponse":
    {
      "error":
      {
        "errorDescription": "",
        "errorMsgText": "",
        "messageNumber": "",
        "erroCategory": "",
      }
      "enrollResponse":
      {
        "messageText": "Successfully Updated",
        "productEnrollmentId": "4368251923",
      }
    }
  }
}

```

Related Topics

For more information on...	See...
Market Product, Offer, or Bundle Enrollment Request and Response - Attribute/Value Pairs in JSON Format	Market Product, Offer, or Bundle Enrollment Request and Response - Attribute/Value Pairs in JSON Format on page 3676

Sample Market Product Enrollment Close Request and Response in the JSON Format

Using the below example, you can close the market product enrollment.

Sample Market Product Enrollment Close Request in the JSON Format

```
{
  "C1PRDCTENRL":
  {
    "enrollment": "",
    {
      "enrollmentcharlist":
      {
        "characteristicValue": "",
        "characteristicType": "",
        "effectiveDate": "",
        "actionFlag": "",
      }
      "personDetails":
      {
        "personId": "",
        "accountdetailslist":
        {
          "accountcharlist":
          {
            "characteristicValue2": "",
            "characteristicType2": "",
            "effectiveDate2": "",
            "actionFlag2": "",
          }
          "enrollmentStatus": "INACTIVE",
          "closingDate": "2023-01-12",
          "accountId": "Dental Account",
          "currency": "USD",
          "setUpDate": "2023-01-01",
          "division": "BK",
          "accountNumber": "",
          "accountIdentifierType": "",
        }
        "personcharlist":
        {
          "characteristicValue3": "",
          "characteristicType3": "",
          "effectiveDate3": "",
          "actionFlag3": "",
        }
        "emailAddress": "leticia.walsh@example.com",
        "country": "USA",
        "state": "OH",
        "city": "CINCINNATI",
        "address4": "",
        "address3": "RIVERDALE ROAD",
        "address2": "CULLINAN STREET",
        "address1": "TREVOR MANSION",
        "addressTypeFlg": "",
        "creationDateTime": "",
        "birthDate": "1968-05-10",
        "division2": "BK",
        "personIdNumber": "",
        "personIdentifiers": "",
        "personNames": "LETICIA,WALSH",
        "nameType": "PRIM",
        "personOrBusiness": "",
      }
    }
  }
}
```

```

    }
    "startDate": "",
    "comments": "",
    "entityCode": "CHECKMP_001",
    "entityType": "MP",
    "enrollmentAction": "Close",
  }
}

```

Sample Market Product Enrollment Close Response in the JSON Format

```

{
  "C1PRDCTENRL":
  {
    "enrollmentResponse":
    {
      "error":
      {
        "errorDescription": "",
        "errorMsgText": "",
        "messageNumber": "",
        "erroCategory": "",
      }
      "enrollResponse":
      {
        "messageText": "Successfully Closed",
        "productEnrollmentId": "4368251923",
      }
    }
  }
}

```

Related Topics

For more information on...	See...
Market Product, Offer, or Bundle Enrollment Request and Response - Attribute/Value Pairs in JSON Format	Market Product, Offer, or Bundle Enrollment Request and Response - Attribute/Value Pairs in JSON Format on page 3676

Sample Offer Enrollment Request and Response in the JSON Format

Using the below example, you can enroll offer to the account.

Sample Offer Enrollment Request in the JSON Format

```

{
  "C1PRDCTENRL":
  {
    "enrollment": "",
    {
      "enrollmentcharlist":
      {
        "characteristicValue": "",
        "characteristicType": "",
        "effectiveDate": "",
        "actionFlag": "",
      }
      "personDetails":
      {
        "personId": "",
        "accountdetailslist":
        {

```

```

        "accountcharlist":
        {
            "characteristicValue2": "",
            "characteristicType2": "",
            "effectiveDate2": "",
            "actionFlag2": "",
        }
        "enrollmentStatus": "ACTIVE",
        "closingDate": "2023-01-12",
        "accountId": "Dental Account",
        "currency": "USD",
        "setUpDate": "2023-01-01",
        "division": "BK",
        "accountNumber": "",
        "accountIdentifierType": "",
    }
    "personcharlist":
    {
        "characteristicValue3": "",
        "characteristicType3": "",
        "effectiveDate3": "",
        "actionFlag3": "",
    }
    "emailAddress": "leticia.walsh@example.com",
    "country": "USA",
    "state": "OH",
    "city": "CINCINNATI",
    "address4": "",
    "address3": "RIVERDALE ROAD",
    "address2": "CULLINAN STREET",
    "address1": "TREVOR MANSION",
    "addressTypeFlg": "",
    "creationDateTime": "",
    "birthDate": "1968-05-10",
    "division2": "BK",
    "personIdNumber": "",
    "personIdentifiers": "",
    "personNames": "LETICIA,WALSH",
    "nameType": "PRIM",
    "personOrBusiness": "",
    }
    "startDate": "",
    "comments": "",
    "entityCode": "CHECKOFF_01",
    "entityType": "OFFR",
    "enrollmentAction": "Add",
    }
}
}

```

Sample Offer Enrollment Response in the JSON Format

```

{
    "C1PRDCTENRL":
    {
        "enrollmentResponse":
        {
            "error":
            {
                "errorDescription" : "",
                "errorMsgText" : "",
                "messageNumber" : "",
                "erroCategory" : "",
            }
        }
    }
}

```

```

    "enrollResponse" :
    {
      "messageText" : "Successfully Enrolled",
      "productEnrollmentId" : "4368251923",
    }
  }
}

```

Related Topics

For more information on...	See...
Market Product, Offer, or Bundle Enrollment Request and Response - Attribute/Value Pairs in JSON Format	Market Product, Offer, or Bundle Enrollment Request and Response - Attribute/Value Pairs in JSON Format on page 3676

Sample Offer Enrollment Edit Request and Response in the JSON Format

Using the below example, you can edit the offer enrollment.

Sample Offer Enrollment Edit Request in the JSON Format

```

{
  "C1PRDCTENRL" :
  {
    "enrollment" : "",
    {
      "enrollmentcharlist" :
      {
        "characteristicValue" : "",
        "characteristicType" : "",
        "effectiveDate" : "",
        "actionFlag" : "",
      }
      "personDetails" :
      {
        "personId" : "",
        "accountdetailslist" :
        {
          "accountcharlist" :
          {
            "characteristicValue2" : "",
            "characteristicType2" : "",
            "effectiveDate2" : "",
            "actionFlag2" : "",
          }
          "enrollmentStatus" : "INACTIVE",
          "closingDate" : "2023-01-12",
          "accountId" : "Dental Account",
          "currency" : "USD",
          "setUpDate" : "2023-01-01",
          "division" : "BK",
          "accountNumber" : "",
          "accountIdentifierType" : "",
        }
        "personcharlist" :
        {
          "characteristicValue3" : "",
          "characteristicType3" : "",
          "effectiveDate3" : "",
          "actionFlag3" : "",
        }
      }
    }
  }
}

```

```

        "emailAddress": "leticia.walsh@example.com",
        "country": "USA",
        "state": "OH",
        "city": "CINCINNATI",
        "address4": "",
        "address3": "RIVERDALE ROAD",
        "address2": "CULLINAN STREET",
        "address1": "TREVOR MANSION",
        "addressTypeFlg": "",
        "creationDateTime": "",
        "birthDate": "1968-05-10",
        "division2": "BK",
        "personIdNumber": "",
        "personIdentifiers": "",
        "personNames": "LETICIA,WALSH",
        "nameType": "PRIM",
        "personOrBusiness": "",
    }
    "startDate": "",
    "comments": "",
    "entityCode": "CHECKOFF_01",
    "entityType": "OFFR",
    "enrollmentAction": "Edit",
}
}
}

```

Sample Offer Enrollment Edit Response in the JSON Format

```

{
  "C1PRDCTENRL":
  {
    "enrollmentResponse":
    {
      "error":
      {
        "errorDescription" : "",
        "errorMsgText" : "",
        "messageNumber" : "",
        "erroCategory" : "",
      }
      "enrollResponse":
      {
        "messageText" : "Successfully Enrolled",
        "productEnrollmentId" : "4368251923",
      }
    }
  }
}

```

Related Topics

For more information on...	See...
Market Product, Offer, or Bundle Enrollment Request and Response - Attribute/Value Pairs in JSON Format	Market Product, Offer, or Bundle Enrollment Request and Response - Attribute/Value Pairs in JSON Format on page 3676

Sample Offer Enrollment Close Request and Response in the JSON Format

Using the below example, you can close the offer enrollment.

Sample Offer Enrollment Close Request in the JSON Format

```

{
  "C1PRDCTENRL":
  {
    "enrollment": "",
    {
      "enrollmentcharlist":
      {
        "characteristicValue": "",
        "characteristicType": "",
        "effectiveDate": "",
        "actionFlag": "",
      }
      "personDetails":
      {
        "personId": "",
        "accountdetailslist":
        {
          "accountcharlist":
          {
            "characteristicValue2": "",
            "characteristicType2": "",
            "effectiveDate2": "",
            "actionFlag2": "",
          }
          "enrollmentStatus": "INACTIVE",
          "closingDate": "2023-01-12",
          "accountId": "Dental Account",
          "currency": "USD",
          "setUpDate": "2023-01-01",
          "division": "BK",
          "accountNumber": "",
          "accountIdentifierType": "",
        }
        "personcharlist":
        {
          "characteristicValue3": "",
          "characteristicType3": "",
          "effectiveDate3": "",
          "actionFlag3": "",
        }
        "emailAddress": "leticia.walsh@example.com",
        "country": "USA",
        "state": "OH",
        "city": "CINCINNATI",
        "address4": "",
        "address3": "RIVERDALE ROAD",
        "address2": "CULLINAN STREET",
        "address1": "TREVOR MANSION",
        "addressTypeFlg": "",
        "creationDateTime": "",
        "birthDate": "1968-05-10",
        "division2": "BK",
        "personIdNumber": "",
        "personIdentifiers": "",
        "personNames": "LETICIA,WALSH",
        "nameType": "PRIM",
        "personOrBusiness": "",
      }
      "startDate": "",
      "comments": "",
      "entityCode": "CHECKOFF_01",
      "entityType": "OFFR",
    }
  }
}

```



```

    "enrollmentAction": "Close",
  }
}

```

Sample Offer Enrollment Close Response in the JSON Format

```

{
  "C1PRDCTENRL":
  {
    "enrollmentResponse":
    {
      "error":
      {
        "errorDescription": "",
        "errorMsgText": "",
        "messageNumber": "",
        "erroCategory": "",
      }
      "enrollResponse":
      {
        "messageText": "Successfully Closed",
        "productEnrollmentId": "4368251923",
      }
    }
  }
}

```

Related Topics

For more information on...	See...
Market Product, Offer, or Bundle Enrollment Request and Response - Attribute/Value Pairs in JSON Format	Market Product, Offer, or Bundle Enrollment Request and Response - Attribute/Value Pairs in JSON Format on page 3676

Sample Bundle Enrollment Request and Response in the JSON Format

Using the below example, you can bundle offer to the account.

Sample Bundle Enrollment Request in the JSON Format

```

{
  "C1PRDCTENRL":
  {
    "enrollment": "",
    {
      "enrollmentcharlist":
      {
        "characteristicValue": "",
        "characteristicType": "",
        "effectiveDate": "",
        "actionFlag": "",
      }
      "personDetails":
      {
        "personId": "",
        "accountdetailslist":
        {
          "accountcharlist":
          {
            "characteristicValue2": "",
            "characteristicType2": "",
            "effectiveDate2": "",

```

```

        "actionFlag2": "",
    }
    "enrollmentStatus": "ACTIVE",
    "closingDate": "2023-01-12",
    "accountId": "Dental Account",
    "currency": "USD",
    "setUpDate": "2023-01-01",
    "division": "BK",
    "accountNumber": "",
    "accountIdentifierType": "",
}
"personcharlist":
{
    "characteristicValue3": "",
    "characteristicType3": "",
    "effectiveDate3": "",
    "actionFlag3": "",
}
"emailAddress": "leticia.walsh@example.com",
"country": "USA",
"state": "OH",
"city": "CINCINNATI",
"address4": "",
"address3": "RIVERDALE ROAD",
"address2": "CULLINAN STREET",
"address1": "TREVOR MANSION",
"addressTypeFlg": "",
"creationDateTime": "",
"birthDate": "1968-05-10",
"division2": "BK",
"personIdNumber": "",
"personIdentifiers": "",
"personNames": "LETICIA,WALSH",
"nameType": "PRIM",
"personOrBusiness": "",
}
"startDate": "",
"comments": "",
"entityCode": "CHECKBUND_003",
"entityType": "BNDL",
"enrollmentAction": "Add",
}
}
}

```

Sample Bundle Enrollment Response in the JSON Format

```

{
  "C1PRDCTENRL":
  {
    "enrollmentResponse":
    {
      "error":
      {
        "errorDescription" : "",
        "errorMsgText" : "",
        "messageNumber" : "",
        "erroCategory" : "",
      }
      "enrollResponse":
      {
        "messageText" : "Successfully Enrolled",
        "productEnrollmentId" : "4368251923",
      }
    }
  }
}

```

```

    }
  }
}

```

Related Topics

For more information on...	See...
Market Product, Offer, or Bundle Enrollment Request and Response - Attribute/Value Pairs in JSON Format	Market Product, Offer, or Bundle Enrollment Request and Response - Attribute/Value Pairs in JSON Format on page 3676

Sample Bundle Enrollment Edit Request and Response in the JSON Format

Using the below example, you can edit the bundle enrollment.

Sample Bundle Enrollment Edit Request in the JSON Format

```

{
  "C1PRDCTENRL":
  {
    "enrollment": "",
    {
      "enrollmentcharlist":
      {
        "characteristicValue": "",
        "characteristicType": "",
        "effectiveDate": "",
        "actionFlag": "",
      }
      "personDetails":
      {
        "personId": "",
        "accountdetailslist":
        {
          "accountcharlist":
          {
            "characteristicValue2": "",
            "characteristicType2": "",
            "effectiveDate2": "",
            "actionFlag2": "",
          }
          "enrollmentStatus": "ACTIVE",
          "closingDate": "2023-01-12",
          "accountId": "Dental Account",
          "currency": "USD",
          "setUpDate": "2023-01-01",
          "division": "BK",
          "accountNumber": "",
          "accountIdentifierType": "",
        }
        "personcharlist":
        {
          "characteristicValue3": "",
          "characteristicType3": "",
          "effectiveDate3": "",
          "actionFlag3": "",
        }
        "emailAddress": "leticia.walsh@example.com",
        "country": "USA",
        "state": "OH",
        "city": "CINCINNATI",
        "address4": "",
      }
    }
  }
}

```

```

        "address3": "RIVERDALE ROAD",
        "address2": "CULLINAN STREET",
        "address1": "TREVOR MANSION",
        "addressTypeFlg": "",
        "creationDateTime": "",
        "birthDate": "1968-05-10",
        "division2": "BK",
        "personIdNumber": "",
        "personIdentifiers": "",
        "personNames": "LETICIA,WALSH",
        "nameType": "PRIM",
        "personOrBusiness": "",
    }
    "startDate": "",
    "comments": "",
    "entityCode": "CHECKBUND_003",
    "entityType": "BNDL",
    "enrollmentAction": "Edit",
}
}
}

```

Sample Bundle Enrollment Edit Response in the JSON Format

```

{
  "C1PRDCTENRL":
  {
    "enrollmentResponse":
    {
      "error":
      {
        "errorDescription": "",
        "errorMsgText": "",
        "messageNumber": "",
        "erroCategory": "",
      }
      "enrollResponse":
      {
        "messageText": "Successfully Updated",
        "productEnrollmentId": "4368251923",
      }
    }
  }
}

```

Related Topics

For more information on...	See...
Market Product, Offer, or Bundle Enrollment Request and Response - Attribute/Value Pairs in JSON Format	Market Product, Offer, or Bundle Enrollment Request and Response - Attribute/Value Pairs in JSON Format on page 3676

Sample Bundle Enrollment Close Request and Response in the JSON Format

Using the below example, you can close the bundle enrollment.

Sample Bundle Enrollment Close Request in the JSON Format

```

{
  "C1PRDCTENRL":
  {
    "enrollment": "",
  }
}

```

```

"enrollmentcharlist":
{
  "characteristicValue": "",
  "characteristicType": "",
  "effectiveDate": "",
  "actionFlag": "",
}
"personDetails":
{
  "personId": "",
  "accountdetailslist":
  {
    "accountcharlist":
    {
      "characteristicValue2": "",
      "characteristicType2": "",
      "effectiveDate2": "",
      "actionFlag2": "",
    }
    "enrollmentStatus": "ACTIVE",
    "closingDate": "2023-01-12",
    "accountId": "Dental Account",
    "currency": "USD",
    "setUpDate": "2023-01-01",
    "division": "BK",
    "accountNumber": "",
    "accountIdentifierType": "",
  }
  "personcharlist":
  {
    "characteristicValue3": "",
    "characteristicType3": "",
    "effectiveDate3": "",
    "actionFlag3": "",
  }
  "emailAddress": "leticia.walsh@example.com",
  "country": "USA",
  "state": "OH",
  "city": "CINCINNATI",
  "address4": "",
  "address3": "RIVERDALE ROAD",
  "address2": "CULLINAN STREET",
  "address1": "TREVOR MANSION",
  "addressTypeFlg": "",
  "creationDateTime": "",
  "birthDate": "1968-05-10",
  "division2": "BK",
  "personIdNumber": "",
  "personIdentifiers": "",
  "personNames": "LETICIA,WALSH",
  "nameType": "PRIM",
  "personOrBusiness": "",
}
"startDate": "",
"comments": "",
"entityCode": "CHECKBUND_003",
"entityType": "BNDL",
"enrollmentAction": "Close",
}
}
}

```

Sample Bundle Enrollment Close Response in the JSON Format

```

{
  "C1PRDCTENRL" :
  {
    "enrollmentResponse" :
    {
      "error" :
      {
        "errorDescription" : "",
        "errorMsgText" : "",
        "messageNumber" : "",
        "erroCategory" : "",
      }
      "enrollResponse" :
      {
        "messageText" : "Successfully Closed",
        "productEnrollmentId" : "4368251923",
      }
    }
  }
}

```

Related Topics

For more information on...	See...
Market Product, Offer, or Bundle Enrollment Request and Response - Attribute/Value Pairs in JSON Format	Market Product, Offer, or Bundle Enrollment Request and Response - Attribute/Value Pairs in JSON Format on page 3676

Chapter 50

Deal Management through Inbound Web Services

Topics:

- [Prospect Creation, Modification, and View through Inbound Web Service](#)
- [Prospect Account Creation, Modification, and View through Inbound Web Service](#)
- [Price List Assignments in Deal through Inbound Web Service](#)
- [Deal Price Assignments and Commitments through Inbound Web Service](#)
- [Deal Creation, Modification, and View through Inbound Web Service](#)
- [Deal Extraction through Inbound Web Service](#)

Oracle Revenue Management and Billing enables you to manage prospects and deals through the following inbound web services:

- [Prospect Creation, Modification, and View through Inbound Web Service](#) on page 3700
- [Prospect Account Creation, Modification, and View through Inbound Web Service](#) on page 3772
- [Deal Creation, Modification, and View through Inbound Web Service](#) on page 3973
- [Price List Assignments in Deal through Inbound Web Service](#) on page 3804
- [Deal Price Assignments and Commitments through Inbound Web Service](#) on page 3838
- [Deal Extraction through Inbound Web Service](#) on page 4171

Prospect Creation, Modification, and View through Inbound Web Service

Oracle Revenue Management and Billing enables you to create and edit a prospect person and its accounts through a web service. It also enables you to view the details of a prospect person and its accounts through a web service. You can send the prospect person creation, modification, or view request from the external system through an inbound web service. We have shipped the following two inbound web services in this release:

- **C1-ProspectPerson** – This is a SOAP based web service. You can use this web service when you want to send the prospect person creation, modification, or view request in the XML format.
- **C1-ProspectPersonREST** – This is a REST based web service. You can use this web service when you want to send the prospect person creation, modification, or view request in the XML or JSON format.

Both these inbound web services call the **C1-ADDPROSPERSON** business service. This business service is used to do the following:

- **Create or edit a prospect person** – While creating a prospect person, you can specify the following details:
 - Name, division, customer segment, customer tier, access group, date of birth, e-mail address, and residential address of the prospect person
 - Characteristics of the prospect person
 - Identifiers of the prospect person
 - Parent and child persons of the prospect person

Note: Other prospect person can be a child of the prospect person. But, only existing person can be a parent of the prospect person.

To add a prospect person through the web service, you must set the action flag to **ADD**. However, to edit a prospect person through the web service, you must set the action flag to **UPD**. While editing a prospect person, you need to specify the prospect person ID to identify the prospect person whose details you want to change. During the update operation, the system replaces the prospect person data instead of editing it. Therefore, you should provide all the details of prospect person including the data that you want to change. For example, if you want to update the characteristics of a prospect person through the web service, you need to provide all details of the prospect person including the new characteristics. While updating the prospect person, the system deletes the old characteristics and creates the new characteristics for the prospect person.

At a time, you can create or edit only one prospect person through the web service. While adding a prospect person, the status of the prospect person can only be set to **ACTIVE**. If you do not specify the status while adding a prospect person, the system, by default sets the status of the prospect person to **ACTIVE**. While updating a prospect person, you can change the status of the prospect person from **ACTIVE** to **INACTIVE**. On inactivating a prospect person, the system automatically changes the status of all its prospect accounts to **INACTIVE**. However, while activating an inactive prospect person, the system does not automatically activates all its prospect accounts. You need to explicitly send the request for activating the required prospect accounts of the prospect person. Also, note that you cannot update the details of an inactive prospect person unless you activate it. Similarly, you cannot update the details of an inactive prospect account unless you activate the prospect person and the respective prospect account.

- **Create or edit a prospect account of a prospect person** – While creating or updating a prospect person, you can create a prospect account for the prospect person. However, while updating a prospect person, you can create or edit a prospect account of the prospect person. While creating a prospect account, you can specify the following details:
 - Division, setup date, invoice currency, bill cycle, and access group of the prospect account
 - Characteristics of the prospect account
 - Identifiers of the prospect account

Note: The division and access group of the prospect account and prospect person should be same.

While associating the prospect person with the prospect account, the system by default sets the **Main Customer** flag to **true**, the **Financially Responsible** flag to **true**, the **Relationship Type** flag to **Main Customer**, and the **Address Source** flag to **PER**.

While editing a prospect account, you need to specify the prospect account ID to identify the prospect account whose details you want to change. During the update operation, the system replaces the prospect account data instead of editing it.

At a time, you can create or edit multiple prospect accounts of a prospect person through the web service. While adding a prospect account, the status of the prospect account can only be set to **ACTIVE**.

If you do not specify the status while adding a prospect account, the system, by default sets the status of the prospect account to **ACTIVE**. While updating a prospect account, you can change the status of the prospect account from **ACTIVE** to **INACTIVE**.

Note that you cannot update the details of an inactive prospect account unless you activate it. You cannot activate a prospect account when the main customer (i.e. prospect person) of the prospect account is inactive.

- **View the details of a prospect person** – While viewing the details of a prospect person, you need to:
 - Specify the prospect person ID or the primary prospect person identifier type, primary prospect person identifier, and division to determine the prospect person whose details you want to view
 - Set the action flag to **READ**

On processing the request, the system displays all details of the prospect person including the details of all its accounts in the response.

Prospect Add Request in the XML Format

The following code snippet illustrates how the tags should be nested while receiving the prospect add request in the XML format.

```
<C1-ADDPROSPERSON>
  <actionFlag></actionFlag>
  <prospectPersonName></prospectPersonName>
  <division></division>
  <customerSegment></customerSegment>
  <customerTier></customerTier>
  <accessGroup></accessGroup>
  <emailAddress></emailAddress>
  <status></status>
  <birthDate></birthDate>
  <address1></address1>
  <address2></address2>
  <address3></address3>
  <address4></address4>
  <city></city>
  <state></state>
  <country></country>
  <postal></postal>
  <prosPerIdentifierList>
    <personIdNumber></personIdNumber>
    <persIsPrimaryId></persIsPrimaryId>
    <idType></idType>
  </prosPerIdentifierList>
  <prosChildRelationList>
    <childPersonId></childPersonId>
    <personRelationshipType></personRelationshipType>
    <childPerType></childPerType>
    <division></division>
```

```

    <childPersonIdType></childPersonIdType>
    <childPersonIdNumber></childPersonIdNumber>
    <endDate></endDate>
    <startDate></startDate>
  </prosChildRelationList>
  <prosParentPerRelationList>
    <parentPersonId></parentPersonId>
    <personRelationshipType></personRelationshipType>
    <parentPerType></parentPerType>
    <division></division>
    <parentPersonIdType></parentPersonIdType>
    <parentPersonIdNumber></parentPersonIdNumber>
    <endDate></endDate>
    <startDate></startDate>
  </prosParentPerRelationList>
  <prosAccountList>
    <personId></personId>
    <prospectAccountId></prospectAccountId>
    <customerClass></customerClass>
    <accountDivision></accountDivision>
    <status></status>
    <setUpDate></setUpDate>
    <currency></currency>
    <billCycle></billCycle>
    <accountAccessGroup></accountAccessGroup>
    <prosAcctCharacteristicList>
      <characteristicValue></characteristicValue>
      <effectiveDate></effectiveDate>
      <characteristicType></characteristicType>
    </prosAcctCharacteristicList>
    <prosAcctIdentifierList>
      <accountIdentifierType></accountIdentifierType>
      <isPrimaryId></isPrimaryId>
      <accountNumber></accountNumber>
    </prosAcctIdentifierList>
  </prosAccountList>
  <prosPerCharacteristicList>
    <personcharacteristicValue></personcharacteristicValue>
    <personEffectiveDate></personEffectiveDate>
    <personCharType></personCharType>
  </prosPerCharacteristicList>
</C1-ADDPROSPERSON>

```

Related Topics

For more information on...	See...
Prospect add request and response tags in the XML format	Prospect Add Request and Response - Tags in the XML Format on page 3708
Sample prospect creation request and response in the XML format	Sample Prospect Creation Request and Response in the XML Format on page 3726

Prospect Add Response in the XML Format

The following code snippet illustrates how the tags should be nested while sending the prospect add response in the XML format.

```

<C1-ADDPROSPERSON>
  <prospectPersonId></prospectPersonId>
  <actionFlag></actionFlag>
  <prospectPersonName></prospectPersonName>
  <division></division>

```

```

<customerSegment></customerSegment>
<customerTier></customerTier>
<accessGroup></accessGroup>
<emailAddress></emailAddress>
<status></status>
<birthDate></birthDate>
<address1></address1>
<address2></address2>
<address3></address3>
<address4></address4>
<city></city>
<state></state>
<country></country>
<postal></postal>
<prosPerIdentifierList>
  <personIdNumber></personIdNumber>
  <persIsPrimaryId></persIsPrimaryId>
  <idType></idType>
</prosPerIdentifierList>
<prosChildRelationList>
  <childPersonId></childPersonId>
  <personRelationshipType></personRelationshipType>
  <childPerType></childPerType>
  <division></division>
  <childPersonIdType></childPersonIdType>
  <childPersonIdNumber></childPersonIdNumber>
  <endDate></endDate>
  <startDate></startDate>
</prosChildRelationList>
<prosParentPerRelationList>
  <parentPersonId></parentPersonId>
  <personRelationshipType></personRelationshipType>
  <parentPerType></parentPerType>
  <division></division>
  <parentPersonIdType></parentPersonIdType>
  <parentPersonIdNumber></parentPersonIdNumber>
  <endDate></endDate>
  <startDate></startDate>
</prosParentPerRelationList>
<prosAccountList>
  <personId></personId>
  <prospectAccountId></prospectAccountId>
  <customerClass></customerClass>
  <accountDivision></accountDivision>
  <status></status>
  <setUpDate></setUpDate>
  <currency></currency>
  <billCycle></billCycle>
  <accountAccessGroup></accountAccessGroup>
  <prosAcctCharacteristicList>
    <characteristicValue></characteristicValue>
    <effectiveDate></effectiveDate>
    <characteristicType></characteristicType>
  </prosAcctCharacteristicList>
  <prosAcctIdentifierList>
    <accountIdentifierType></accountIdentifierType>
    <isPrimaryId></isPrimaryId>
    <accountNumber></accountNumber>
  </prosAcctIdentifierList>
</prosAccountList>
<prosPerCharacteristicList>
  <personCharacteristicValue></personCharacteristicValue>
  <personEffectiveDate></personEffectiveDate>
  <personCharType></personCharType>

```

```

    </prosPerCharacteristicList>
</C1-ADDPROSPERSON>

```

Related Topics

For more information on...	See...
Prospect add request and response tags in the XML format	Prospect Add Request and Response - Tags in the XML Format on page 3708
Sample prospect creation request and response in the XML format	Sample Prospect Creation Request and Response in the XML Format on page 3726

Prospect Update Request in the XML Format

The following code snippet illustrates how the tags should be nested while receiving the prospect update request in the XML format:

```

<C1-ADDPROSPERSON>
  <prospectPersonId></prospectPersonId>
  <actionFlag></actionFlag>
  <prospectPersonName></prospectPersonName>
  <division></division>
  <customerSegment></customerSegment>
  <customerTier></customerTier>
  <accessGroup></accessGroup>
  <emailAddress></emailAddress>
  <status></status>
  <birthDate></birthDate>
  <address1></address1>
  <address2></address2>
  <address3></address3>
  <address4></address4>
  <city></city>
  <state></state>
  <country></country>
  <postal></postal>
  <prosPerIdentifierList>
    <personIdNumber></personIdNumber>
    <persIsPrimaryId></persIsPrimaryId>
    <idType></idType>
  </prosPerIdentifierList>
  <prosChildRelationList>
    <childPersonId></childPersonId>
    <personRelationshipType></personRelationshipType>
    <childPerType></childPerType>
    <division></division>
    <childPersonIdType></childPersonIdType>
    <childPersonIdNumber></childPersonIdNumber>
    <endDate></endDate>
    <startDate></startDate>
  </prosChildRelationList>
  <prosParentPerRelationList>
    <parentPersonId></parentPersonId>
    <personRelationshipType></personRelationshipType>
    <parentPerType></parentPerType>
    <division></division>
    <parentPersonIdType></parentPersonIdType>
    <parentPersonIdNumber></parentPersonIdNumber>
    <endDate></endDate>
    <startDate></startDate>
  </prosParentPerRelationList>
  <prosAccountList>

```

```

    <personId></personId>
    <prospectAccountId></prospectAccountId>
    <customerClass></customerClass>
    <accountDivision></accountDivision>
    <status></status>
    <setUpDate></setUpDate>
    <currency></currency>
    <billCycle></billCycle>
    <accountAccessGroup></accountAccessGroup>
    <prosAcctCharacteristicList>
      <characteristicValue></characteristicValue>
      <effectiveDate></effectiveDate>
      <characteristicType></characteristicType>
    </prosAcctCharacteristicList>
    <prosAcctIdentifierList>
      <accountIdentifierType></accountIdentifierType>
      <isPrimaryId></isPrimaryId>
      <accountNumber></accountNumber>
    </prosAcctIdentifierList>
  </prosAccountList>
  <prosPerCharacteristicList>
    <personcharacteristicValue></personcharacteristicValue>
    <personEffectiveDate></personEffectiveDate>
    <personCharType></personCharType>
  </prosPerCharacteristicList>
</C1-ADDPROSPERSON>

```

Related Topics

For more information on...	See...
Prospect update request and response tags in the XML format	Prospect Update Request and Response - Tags in the XML Format on page 3716
Sample prospect update request and response in the XML format	Sample Prospect Update Request and Response in the XML Format on page 3729

Prospect Update Response in the XML Format

The following code snippet illustrates how the tags should be nested while sending the prospect update response in the XML Format.

```

<C1-ADDPROSPERSON>
  <prospectPersonId></prospectPersonId>
  <actionFlag></actionFlag>
  <prospectPersonName></prospectPersonName>
  <division></division>
  <customerSegment></customerSegment>
  <customerTier></customerTier>
  <accessGroup></accessGroup>
  <emailAddress></emailAddress>
  <status></status>
  <birthDate></birthDate>
  <address1></address1>
  <address2></address2>
  <address3></address3>
  <address4></address4>
  <city></city>
  <state></state>
  <country></country>
  <postal></postal>
  <prosPerIdentifierList>
    <personIdNumber></personIdNumber>

```

```

    <persIsPrimaryId></persIsPrimaryId>
    <idType></idType>
  </prosPerIdentifierList>
  <prosChildRelationList>
    <childPersonId></childPersonId>
    <personRelationshipType></personRelationshipType>
    <childPerType></childPerType>
    <division></division>
    <childPersonIdType></childPersonIdType>
    <childPersonIdNumber></childPersonIdNumber>
    <endDate></endDate>
    <startDate></startDate>
  </prosChildRelationList>
  <prosParentPerRelationList>
    <parentPersonId></parentPersonId>
    <personRelationshipType></personRelationshipType>
    <parentPerType></parentPerType>
    <division></division>
    <parentPersonIdType></parentPersonIdType>
    <parentPersonIdNumber></parentPersonIdNumber>
    <endDate></endDate>
    <startDate></startDate>
  </prosParentPerRelationList>
  <prosAccountList>
    <personId></personId>
    <prospectAccountId></prospectAccountId>
    <customerClass></customerClass>
    <accountDivision></accountDivision>
    <status></status>
    <setUpDate></setUpDate>
    <currency></currency>
    <billCycle></billCycle>
    <accountAccessGroup></accountAccessGroup>
    <prosAcctCharacteristicList>
      <characteristicValue></characteristicValue>
      <effectiveDate></effectiveDate>
      <characteristicType></characteristicType>
    </prosAcctCharacteristicList>
    <prosAcctIdentifierList>
      <accountIdentifierType></accountIdentifierType>
      <isPrimaryId></isPrimaryId>
      <accountNumber></accountNumber>
    </prosAcctIdentifierList>
  </prosAccountList>
  <prosPerCharacteristicList>
    <personCharacteristicValue></personCharacteristicValue>
    <personEffectiveDate></personEffectiveDate>
    <personCharType></personCharType>
  </prosPerCharacteristicList>
</C1-ADDPROSPERSON>

```

Related Topics

For more information on...	See...
Prospect update request and response tags in the XML format	Prospect Update Request and Response - Tags in the XML Format on page 3716
Sample prospect update request and response in the XML format	Sample Prospect Update Request and Response in the XML Format on page 3729

Prospect View Request in the XML Format

The following code snippet illustrates how the tags should be nested while receiving the prospect view request in the XML format:

```
<C1-ADDPROSPERSON>
  <prospectPersonId></prospectPersonId>
  <actionFlag></actionFlag>
</C1-ADDPROSPERSON>
```

Related Topics

For more information on...	See...
Prospect view request and response tags in the XML format	Prospect View Request and Response - Tags in the XML Format on page 3723
Sample prospect view request and response in the XML format	Sample Prospect View Request and Response in the XML Format on page 3733

Prospect View Response in the XML Format

The following code snippet illustrates how the tags should be nested while sending the prospect view response in the XML format:

```
<C1-ADDPROSPERSON>
  <prospectPersonId></prospectPersonId>
  <actionFlag></actionFlag>
  <prospectPersonName></prospectPersonName>
  <division></division>
  <customerSegment></customerSegment>
  <customerTier></customerTier>
  <accessGroup></accessGroup>
  <emailAddress></emailAddress>
  <status></status>
  <birthDate></birthDate>
  <address1></address1>
  <address2></address2>
  <address3></address3>
  <address4></address4>
  <city></city>
  <state></state>
  <country></country>
  <postal></postal>
  <prosPerIdentifierList>
    <personIdNumber></personIdNumber>
    <persIsPrimaryId></persIsPrimaryId>
    <idType></idType>
  </prosPerIdentifierList>
  <prosChildRelationList>
    <childPersonId></childPersonId>
    <personRelationshipType></personRelationshipType>
    <childPerType></childPerType>
    <division></division>
    <childPersonIdType></childPersonIdType>
    <childPersonIdNumber></childPersonIdNumber>
    <endDate></endDate>
    <startDate></startDate>
  </prosChildRelationList>
  <prosParentPerRelationList>
    <parentPersonId></parentPersonId>
    <personRelationshipType></personRelationshipType>
    <parentPerType></parentPerType>
    <division></division>
    <parentPersonIdType></parentPersonIdType>
```

```

    <parentPersonIdNumber></parentPersonIdNumber>
    <endDate></endDate>
    <startDate></startDate>
  </prosParentPerRelationList>
  <prosAccountList>
    <personId></personId>
    <prospectAccountId></prospectAccountId>
    <customerClass></customerClass>
    <accountDivision></accountDivision>
    <status></status>
    <setUpDate></setUpDate>
    <currency></currency>
    <billCycle></billCycle>
    <accountAccessGroup></accountAccessGroup>
    <prosAcctCharacteristicList>
      <characteristicValue></characteristicValue>
      <effectiveDate></effectiveDate>
      <characteristicType></characteristicType>
    </prosAcctCharacteristicList>
    <prosAcctIdentifierList>
      <accountIdentifierType></accountIdentifierType>
      <isPrimaryId></isPrimaryId>
      <accountNumber></accountNumber>
    </prosAcctIdentifierList>
  </prosAccountList>
  <prosPerCharacteristicList>
    <personCharacteristicValue></personCharacteristicValue>
    <personEffectiveDate></personEffectiveDate>
    <personCharType></personCharType>
  </prosPerCharacteristicList>
</C1-ADDPROSPERSON>

```

Related Topics

For more information on...	See...
Prospect view request and response tags in the XML format	Prospect View Request and Response - Tags in the XML Format on page 3723
Sample prospect view request and response in the XML format	Sample Prospect View Request and Response in the XML Format on page 3733

Prospect Add Request and Response - Tags in the XML Format

Note: We recommend you to refer the topics [Prospect Add Request in the XML Format](#) on page 3701 and [Prospect Add Response in the XML Format](#) on page 3702 in parallel while understanding the below mentioned tags. This will help you to understand how the tags are nested in the XML format.

Before calling the **C1-ADDPROSPERSON** business service through an inbound web service, you need to ensure that the prospect add request contains the following tags:

Tag Name	Tag Description	Mandatory (Yes or No)
actionFlag	Used to indicate that you want to create request to add a prospect. The valid value is: <ul style="list-style-type: none"> ADD <p>Note: If you do not specify the value in this tag, the system considers it as an ADD action.</p>	Yes

Tag Name	Tag Description	Mandatory (Yes or No)
prospectPersonName	Used to specify the name of the prospect person.	Yes
	Note: You should specify a person name which is already present in the system.	
division	Used to indicate the division to which you want to associate the prospect person.	Yes
	Note: You must specify a division which is already defined in the system.	
customerSegment	Used to indicate the business component using which you want to create the prospect person.	No
	Note: You should specify only those values which are present in the CUST_SEG_FLG lookup field.	
customerTier	Used to indicate the customer tier of the customer segment to which you want to associate the prospect person.	No
	Note: You should specify only those values which are present in the CUST_TIER_FLG lookup field.	
accessGroup	Used to indicate the user groups who can view and edit the details of the prospect person.	Yes
	Note: You must specify an access group which is associated with the division to which the prospect belongs.	
emailAddress	Used to specify the email address of the prospect person.	No
status	Used to indicate the status in which you want to create the prospect person. <ul style="list-style-type: none"> • ACTIVE • INACTIVE 	Yes
	Note: The status of the prospect person can only be set to ACTIVE while adding a prospect person. If you do not specify the value in this tag, the system, by default sets the status of the prospect person to ACTIVE .	
birthDate	Used to specify the date of birth of the prospect person.	No

Tag Name	Tag Description	Mandatory (Yes or No)
address1	Used to specify the first line of the address. It may contain details, such as the house number.	No
address2	Used to specify the second line of the address. It may contain details, such as the apartment name.	No
address3	Used to specify the third line of the address. It may contain details, such as the street name.	No
address4	Used to specify the fourth line of the address. It may contain the landmark details.	No
city	Used to specify the city where the prospect is located.	No
state	Used to specify the state where the city is located.	No
country	Used to specify the country where the state is located.	No
postal	Used to specify the postal code of the address.	No
prosPerIdentifierList	Used to specify a list of person identifiers for the prospect person.	No
personIdNumber	Used to specify the value of the person identifier type. Note: If you specify the idType tag, you need to specify the personIdNumber tag.	Yes (Conditional) Note: This data is required while specifying the prospect person identifier.
persIsPrimaryId	Used to indicate whether the prospect person identifier is primary or not. The valid values are: <ul style="list-style-type: none"> • True • False 	Yes (Conditional) Note: This data is required while specifying the prospect person identifier.
idType	Used to specify the identifier type using which you want to add the prospect person in the system. Note: If you specify the personIdNumber tag, you need to specify the idType tag.	Yes (Conditional) Note: This data is required while specifying the prospect person identifier.
prosChildRelationList	Used to specify a list of child persons associated with the prospect person.	No
childPersonId	Used to specify the child person of the prospect person.	Yes (Conditional) Note: This data is required while specifying the child person of the prospect person.
personRelationshipType	Used to indicate how the child person is associated with the prospect person.	Yes (Conditional)

Tag Name	Tag Description	Mandatory (Yes or No)
		Note: This data is required while specifying the child person of the prospect person.
childPerType	Used to indicate the type of the child person.	Yes (Conditional) Note: This data is required while specifying the child person of the prospect person.
division	Used to indicate the division to which the child person belongs. Note: You must specify a division which is already defined in the system. The child person must belong to the division to which the prospect person is associated.	Yes (Conditional) Note: This data is required while specifying the child person of the prospect person.
childPersonIdType	Used to specify the identifier type using which the child person is created in the system. Note: If you specify the childPersonIdNumber tag, you need to specify the childPersonIdType tag.	Yes (Conditional) Note: This data is required while specifying the child person of the prospect person.
childPersonIdNumber	Used to specify the value of the identifier type using which the child person is created in the system. Note: If you specify the childPersonIdType tag, you need to specify the childPersonIdNumber tag.	Yes (Conditional) Note: This data is required while specifying the child person of the prospect person.
endDate	Used to specify the date till when the child person is associated with the prospect person.	No
startDate	Used to specify the date from when the child person is associated with the prospect person.	Yes (Conditional) Note: This data is required while specifying the child person of the prospect person.
prosParentPerRelationList	Used to specify a list of parent persons associated with the prospect person.	No

Tag Name	Tag Description	Mandatory (Yes or No)
	<p>Note: You can now add a prospect person or account to an existing person in the system. In other words, the system allows you to add a prospect person or account in an existing person's hierarchy. Also, you can create deals for such prospect person's or account's, if required.</p>	
parentPersonId	Used to specify the parent person of the prospect person.	Yes (Conditional) <p>Note: This data is required while specifying the parent person relationship of the prospect person.</p>
personRelationshipType	Used to indicate how the prospect person is associated with the specified person.	Yes (Conditional) <p>Note: This data is required while specifying the parent person relationship of the prospect person.</p>
parentPerType	Used to indicate the type of the parent person. The valid values are: <ul style="list-style-type: none"> • EPER - Used to indicate that the parent person is an existing person in the system. • PRSP - Used to indicate that the parent person is a prospect in the system. 	Yes (Conditional) <p>Note: This data is required while specifying the parent person relationship of the prospect person.</p>
division	Used to indicate the division to which the parent person belongs. <p>Note: You must specify a division which is already defined in the system. The parent person must belong to the division to which the prospect person is associated.</p>	Yes (Conditional) <p>Note: This data is required while specifying the parent person relationship of the prospect person.</p>
parentPersonIdType	Used to specify the identifier type using which the parent person is created in the system. <p>Note: If you specify the parentPersonIdNumber tag, you need to specify the parentPersonIdType tag.</p>	Yes (Conditional) <p>Note: This data is required while specifying the parent person relationship of the prospect person.</p>
parentPersonIdNumber	Used to specify the value of the identifier type using which the parent person is created in the system.	Yes (Conditional) <p>Note: This data is required while specifying the parent person relationship of the prospect person.</p>

Tag Name	Tag Description	Mandatory (Yes or No)
	Note: If you specify the parentPersonIdType tag, you need to specify the parentPersonIdNumber tag.	
endDate	Used to specify the date till when the prospect person is associated with the parent person.	No
startDate	Used to specify the date from when the prospect person is associated with the parent person.	Yes (Conditional) Note: This data is required while specifying the parent person relationship of the prospect person.
prosAccountList	Used to specify a list of accounts for the prospect person.	No
personId	Used to specify the person to which the account belongs.	Yes (Conditional) Note: This data is required while adding an account for the prospect person.
customerClass	Used to indicate the customer class to which the account is associated. Note: You must specify a customer class which is associated with the division to which the prospect account belongs.	Yes (Conditional) Note: This data is required while adding an account for the prospect person.
accountDivision	Used to indicate the division to which the account belongs. Note: If you do not specify the value in this tag, the system considers the division of the person to whom the account is associated.	Yes (Conditional) Note: This data is required while adding an account for the prospect person.
status	Used to indicate the status of the account. The valid values are: <ul style="list-style-type: none"> ACTIVE INACTIVE Note: The status of the prospect account can only be set to ACTIVE while adding a prospect account. If you do not specify the value in this tag, the system, by default sets the status of the prospect account to ACTIVE .	Yes (Conditional) Note: This data is required while adding an account for the prospect person.
setUpDate	Used to specify the date from when the account is available for the prospect person.	Yes (Conditional)

Tag Name	Tag Description	Mandatory (Yes or No)
		Note: This data is required while adding an account for the prospect person.
currency	Used to indicate the currency code of the account. Note: You must specify a currency which is already defined in the system and which is associated with the division to which the prospect account belongs.	Yes
billCycle	Used to indicate the time interval in which you want to create the bills for the account.	Yes (Conditional) Note: This data is required while adding an account for the prospect person.
accountAccessGroup	Used to indicate the user group who can view and edit the details of the account. Note: If you do not specify the value in this tag, the system considers the access group of the person to whom the account belongs.	Yes (Conditional) Note: This data is required while adding an account for the prospect person.
prosAcctCharacteristicList	Used to specify a list of characteristics for the prospect account.	No
characteristicValue	Used to specify the value for the characteristic type.	Yes (Conditional) Note: This data is required while adding a characteristic for the prospect account.
effectiveDate	Used to specify the date from when the characteristic is effective for the prospect account.	Yes (Conditional) Note: This data is required while adding a characteristic for the prospect account.
characteristicType	Used to indicate the characteristic type. Note: You must specify a characteristic type which is associated with the division to which the prospect account belongs.	Yes (Conditional) Note: This data is required while adding a characteristic for the prospect account.
prosAcctIdentifierList	Used to specify a list of identifiers for the prospect account.	No
accountIdentifierType	Used to indicate the identifier type based on which you want to define the prospect account.	Yes (Conditional) Note: This data is required while associating an identifier with the prospect account.

Tag Name	Tag Description	Mandatory (Yes or No)
	<p>Note:</p> <p>If you specify the accountNumber tag, you need to specify the accountIdentifierType tag.</p> <p>You must specify an identifier type which is associated with the division to which the prospect account belongs.</p>	
isPrimaryId	<p>Used to indicate whether the prospect account identifier is primary or not. The valid values are:</p> <ul style="list-style-type: none"> • True • False <p>Note: If you do not specify the value in this tag, the system considers the value as False.</p>	<p>Yes (Conditional)</p> <p>Note: This data is required while associating an identifier with the prospect account.</p>
accountNumber	<p>Used to specify the prospect account to which you want to associate the identifier.</p> <p>Note: If you specify the accountIdentifierType tag, you need to specify the accountNumber tag.</p>	<p>Yes (Conditional)</p> <p>Note: This data is required while associating an identifier with the prospect account.</p>
prosPerCharacteristicList	<p>Used to specify a list of characteristics for the prospect person.</p>	No
personcharacteristicValue	<p>Used to specify the value for the characteristic type.</p>	<p>Yes (Conditional)</p> <p>Note: This data is required while adding a characteristic for the prospect person.</p>
personEffectiveDate	<p>Used to specify the date from when the characteristic is effective for the prospect person.</p>	<p>Yes (Conditional)</p> <p>Note: This data is required while adding a characteristic for the prospect person.</p>
personCharType	<p>Used to indicate the characteristic type.</p> <p>Note: You must specify a characteristic type which is associated with the division to which the prospect person belongs.</p>	<p>Yes (Conditional)</p> <p>Note: This data is required while adding a characteristic for the prospect person.</p>

Note: At a time, you can add only one prospect person using the **C1-ADDPROSPERSON** business service. However, you can add multiple accounts for the prospect person using the **C1-ADDPROSPERSON** business service.

Once the prospect is created, all the details of prospect are listed in the above mentioned tags along with the following tags:

Tag Name	Tag Description
prospectPersonId	Displays the identification value generated for the prospect person.
prospectAccountId	Displays the identification value generated for the prospect account.

Related Topics

For more information on...	See...
Sample prospect creation request and response in the XML format	Sample Prospect Creation Request and Response in the XML Format on page 3726

Prospect Update Request and Response - Tags in the XML Format

Note: We recommend you to refer the topics [Prospect Update Request in the XML Format](#) on page 3704 and [Prospect Update Response in the XML Format](#) on page 3705 in parallel while understanding the below mentioned tags. This will help you to understand how the tags are nested in the XML format.

Before calling the **C1-ADDPROSPERSON** business service through an inbound web service, you need to ensure that the prospect update request contains the following tags:

Tag Name	Tag Description	Mandatory (Yes or No)
prospectPersonId	Used to specify the prospect person for whom you want to create the update request.	Yes
actionFlag	Used to indicate that you want to create request to update a prospect person. The valid value is: <ul style="list-style-type: none"> UPD <p>Note: If you do not specify the value in this tag, the system considers it as an ADD action.</p>	Yes
prospectPersonName	Used to specify the name of the prospect person. <p>Note: You should specify a person name which is already present in the system.</p>	Yes
division	Used to indicate the division to which you want to associate the prospect person. <p>Note: You must specify a division which is already defined in the system.</p>	Yes
customerSegment	Used to indicate the business component using which you want to update the prospect person. <p>Note: You should specify only those values which are present in the CUST_SEG_FLG lookup field.</p>	No
customerTier	Used to indicate the customer tier of the customer segment to which you want to associate the prospect person.	No

Tag Name	Tag Description	Mandatory (Yes or No)
	Note: You should specify only those values which are present in the CUST_TIER_FLG lookup field.	
accessGroup	Used to indicate the user groups who can view and edit the details of the prospect person. Note: You can specify only those access groups which are associated with the division to which the prospect belongs.	Yes
emailAddress	Used to specify the email address of the prospect person.	No
status	Used to indicate the status in which you want to create the prospect person. <ul style="list-style-type: none"> • ACTIVE • INACTIVE Note: The status of the prospect person can only be set to ACTIVE while adding a prospect person. If you do not specify the value in this tag, the system, by default sets the status of the prospect person to ACTIVE .	Yes
birthDate	Used to specify the date of birth of the prospect person.	No
address1	Used to specify the first line of the address. It may contain details, such as the house number.	No
address2	Used to specify the second line of the address. It may contain details, such as the apartment name.	No
address3	Used to specify the third line of the address. It may contain details, such as the street name.	No
address4	Used to specify the fourth line of the address. It may contain the landmark details.	No
city	Used to specify the city where the prospect is located.	No
state	Used to specify the state where the city is located.	No
country	Used to specify the country where the state is located.	No
postal	Used to specify the postal code of the address.	No
prosPerIdentifierList	Used to specify a list of person identifiers for the prospect person.	No

Tag Name	Tag Description	Mandatory (Yes or No)
personIdNumber	Used to specify the value of the person identifier type.	Yes (Conditional)
	Note: If you specify the idType tag, you need to specify the personIdNumber tag.	Note: This data is required while specifying the prospect person identifier.
persIsPrimaryId	Used to indicate whether the prospect person identifier is primary or not. The valid values are: <ul style="list-style-type: none"> • True • False 	Yes (Conditional)
		Note: This data is required while specifying the prospect person identifier.
idType	Used to specify the identifier type using which you want to add the prospect person in the system.	Yes (Conditional)
	Note: If you specify the personIdNumber tag, you need to specify the idType tag.	Note: This data is required while specifying the prospect person identifier.
prosChildRelationList	Used to specify a list of child persons associated with the prospect person.	No
childPersonId	Used to specify the child person of the prospect person.	Yes (Conditional)
		Note: This data is required while specifying the child person of the prospect person.
personRelationshipType	Used to indicate how the child person is associated with the prospect person.	Yes (Conditional)
		Note: This data is required while specifying the child person of the prospect person.
childPerType	Used to indicate the type of the child person.	Yes (Conditional)
		Note: This data is required while specifying the child person of the prospect person.
division	Used to indicate the division to which the child person belongs.	Yes (Conditional)
	Note: You must specify a division which is already defined in the system. The child person must belong to the division to which the prospect person is associated.	Note: This data is required while specifying the child person of the prospect person.
childPersonIdType	Used to specify the identifier type using which the child person is created in the system.	Yes (Conditional)

Tag Name	Tag Description	Mandatory (Yes or No)
	Note: If you specify the childPersonIdNumber tag, you need to specify the childPersonIdType tag.	Note: This data is required while specifying the child person of the prospect person.
childPersonIdNumber	Used to specify the value of the identifier type using which the child person is created in the system. Note: If you specify the childPersonIdType tag, you need to specify the childPersonIdNumber tag.	Yes (Conditional) Note: This data is required while specifying the child person of the prospect person.
endDate	Used to specify the date till when the child person is associated with the prospect person.	No
startDate	Used to specify the date from when the child person is associated with the prospect person.	Yes (Conditional) Note: This data is required while specifying the child person of the prospect person.
prosParentPerRelationList	Used to specify a list of parent persons associated with the prospect person. Note: You can now add a prospect person or account to an existing person in the system. In other words, the system allows you to add a prospect person or account in an existing person's hierarchy. Also, you can create deals for such prospect person's or account's, if required.	No
parentPersonId	Used to specify the parent person of the prospect person.	Yes (Conditional) Note: This data is required while specifying the parent person relationship of the prospect person.
personRelationshipType	Used to indicate how the prospect person is associated with the specified person.	Yes (Conditional) Note: This data is required while specifying the parent person relationship of the prospect person.
parentPerType	Used to indicate the type of the parent person. The valid values are: <ul style="list-style-type: none"> • EPER - Used to indicate that the parent person is an existing person in the system. • PRSP - Used to indicate that the parent person is a prospect in the system. 	Yes (Conditional) Note: This data is required while specifying the parent person relationship of the prospect person.

Tag Name	Tag Description	Mandatory (Yes or No)
division	Used to indicate the division to which the parent person belongs.	Yes (Conditional)
	<p>Note:</p> <p>You must specify a division which is already defined in the system.</p> <p>The parent person must belong to the division to which the prospect person is associated.</p>	<p>Note: This data is required while specifying the parent person relationship of the prospect person.</p>
parentPersonIdType	Used to specify the identifier type using which the parent person is created in the system.	Yes (Conditional)
	<p>Note: If you specify the parentPersonIdNumber tag, you need to specify the parentPersonIdType tag.</p>	<p>Note: This data is required while specifying the parent person relationship of the prospect person.</p>
parentPersonIdNumber	Used to specify the value of the identifier type using which the parent person is created in the system.	Yes (Conditional)
	<p>Note: If you specify the parentPersonIdType tag, you need to specify the parentPersonIdNumber tag.</p>	<p>Note: This data is required while specifying the parent person relationship of the prospect person.</p>
endDate	Used to specify the date till when the prospect person is associated with the parent person.	No
startDate	Used to specify the date from when the prospect person is associated with the parent person.	Yes (Conditional)
		<p>Note: This data is required while specifying the parent person relationship of the prospect person.</p>
prosAccountList	Used to specify a list of accounts for the prospect person.	No
personId	Used to specify the person to which the account belongs.	Yes (Conditional)
		<p>Note: This data is required while adding an account for the prospect person.</p>
customerClass	Used to indicate the customer class to which the account is associated.	Yes (Conditional)
	<p>Note: You must specify a customer class which is associated with the division to which the prospect account belongs.</p>	<p>Note: This data is required while adding an account for the prospect person.</p>
accountDivision	Used to indicate the division to which the account belongs.	Yes (Conditional)

Tag Name	Tag Description	Mandatory (Yes or No)
	Note: If you do not specify the value in this tag, the system considers the division of the person to whom the account is associated.	Note: This data is required while adding an account for the prospect person.
status	Used to indicate the status of the account. The valid values are: <ul style="list-style-type: none"> ACTIVE INACTIVE Note: The status of the prospect account can only be set to ACTIVE while adding a prospect account. If you do not specify the value in this tag, the system, by default sets the status of the prospect account to ACTIVE .	Yes (Conditional) Note: This data is required while adding an account for the prospect person.
setUpDate	Used to specify the date from when the account is available for the prospect person.	Yes (Conditional) Note: This data is required while adding an account for the prospect person.
currency	Used to indicate the currency code of the account. Note: You must specify a currency which is already defined in the system and which is associated with the division to which the prospect account belongs.	Yes
billCycle	Used to indicate the time interval in which you want to create the bills for the account.	Yes (Conditional) Note: This data is required while adding an account for the prospect person.
accountAccessGroup	Used to indicate the user group who can view and edit the details of the account. Note: If you do not specify the value in this tag, the system considers the access group of the person to whom the account belongs.	Yes (Conditional) Note: This data is required while adding an account for the prospect person.
prosAcctCharacteristicList	Used to specify a list of characteristics for the prospect account.	No
characteristicValue	Used to specify the value for the characteristic type.	Yes (Conditional)

Tag Name	Tag Description	Mandatory (Yes or No)
		Note: This data is required while adding a characteristic for the prospect account.
effectiveDate	Used to specify the date from when the characteristic is effective for the prospect account.	Yes (Conditional) Note: This data is required while adding a characteristic for the prospect account.
characteristicType	Used to indicate the characteristic type. Note: You must specify a characteristic type which is associated with the division to which the prospect account belongs.	Yes (Conditional) Note: This data is required while adding a characteristic for the prospect account.
prosAcctIdentifierList	Used to specify a list of identifiers for the prospect account.	No
accountIdentifierType	Used to indicate the identifier type based on which you want to define the prospect account. Note: If you specify the accountNumber tag, you need to specify the accountIdentifierType tag. You must specify an identifier type which is associated with the division to which the prospect account belongs.	Yes (Conditional) Note: This data is required while associating an identifier with the prospect account.
isPrimaryId	Used to indicate whether the prospect account identifier is primary or not. The valid values are: <ul style="list-style-type: none">• True• False Note: If you do not specify the value in this tag, the system considers the value as False .	Yes (Conditional) Note: This data is required while associating an identifier with the prospect account.
accountNumber	Used to specify the prospect account to which you want to associate the identifier. Note: If you specify the accountIdentifierType tag, you need to specify the accountNumber tag.	Yes (Conditional) Note: This data is required while associating an identifier with the prospect account.
prosPerCharacteristicList	Used to specify a list of characteristics for the prospect person.	No
personcharacteristicValue	Used to specify the value for the characteristic type.	Yes (Conditional) Note: This data is required while adding a characteristic for the prospect person.

Tag Name	Tag Description	Mandatory (Yes or No)
personEffectiveDate	Used to specify the date from when the characteristic is effective for the prospect person.	Yes (Conditional)
		Note: This data is required while adding a characteristic for the prospect person.
personCharType	Used to indicate the characteristic type.	Yes (Conditional)
	Note: You must specify a characteristic type which is associated with the division to which the prospect person belongs.	Note: This data is required while adding a characteristic for the prospect person.

Note:

At a time, you can edit only one prospect person through the web service.

While updating the prospect person, the system replaces the prospect person data instead of editing it. Therefore, you should provide all the details of prospect person including the data that you want to change.

Once the prospect person is updated, all the details of prospect person are listed in the above mentioned tags.

Related Topics

For more information on...	See...
Sample prospect update request and response in the XML format	Sample Prospect Update Request and Response in the XML Format on page 3729

Prospect View Request and Response - Tags in the XML Format

Note: We recommend you to refer the topics [Prospect View Request in the XML Format](#) on page 3706 and [Prospect View Response in the XML Format](#) on page 3707 in parallel while understanding the below mentioned tags. This will help you to understand how the tags are nested in the XML format.

Before calling the **C1-ADDPROSPERSON** business service through an inbound web service, you need to ensure that the prospect view request contains the following tags:

Tag Name	Tag Description	Mandatory (Yes or No)
prospectPersonId	Used to specify the prospect for which you want to create the view request..	Yes (Conditional)
	Note: If you do not specify the value in the prospectPersonId tag, you have to specify the personIdNumber and idType tags.	Note: This data is required for creating view request for a particular prospect.
actionFlag	Used to indicate that you want to create request to view a prospect. The valid value is: <ul style="list-style-type: none"> • READ 	Yes
	Note: If you do not specify the value in this tag, the system considers it as an ADD action.	

Tag Name	Tag Description	Mandatory (Yes or No)
personIdNumber	Used to specify the value of the person identifier type using which you want to create the view request for a prospect.	Yes (Conditional)
	Note: If you specify the idType tag, you need to specify the personIdNumber tag.	Note: This data is required for creating view request for a prospect using its person identifier details.
idType	Used to specify the identifier type using which you want to create the view request for a prospect.	Yes (Conditional)
	Note: If you specify the personIdNumber tag, you need to specify the idType tag. The data in this tag is required if you do not specify the value in the prospectPersonId tag. You should specify an identifier type which is associated with the division to which the prospect belongs.	Note: This data is required for creating view request for a prospect using its person identifier details.
division	Used to specify the division of the identifier type using which you want to create the view request for a prospect.	Yes (Conditional)
	Note: If you specify the personIdNumber and idType tags, you need to specify the division tag. You must specify a division which is already defined in the system.	Note: This data is required for creating view request for a prospect using its person identifier details.

Once the view request is created for the prospect, all the details of prospect are listed in the above mentioned tags along with the following tags:

Tag Name	Tag Description
prospectPersonName	Displays the name of the prospect person.
division	Display the division to which the prospect person belongs.
customerSegment	Indicates the business component using which the prospect person is created in the system.
customerTier	Indicates the customer tier of the customer segment to which the prospect person is associated.
accessGroup	Indicates the user groups who can view and edit the details of the prospect person.
emailAddress	Displays the email address of the prospect person.
status	Indicates the current status of the prospect. The valid values are: <ul style="list-style-type: none"> • ACTIVE

Tag Name	Tag Description
	<ul style="list-style-type: none"> INACTIVE
birthDate	Displays the date of birth of the prospect person.
address1	Displays the first line of the address. It may contain details, such as the house number.
address2	Displays the second line of the address. It may contain details, such as the apartment name.
address3	Displays the third line of the address. It may contain details, such as the street name.
address4	Displays the fourth line of the address. It may contain the landmark details.
city	Displays the city where the prospect person is located.
state	Displays the state where the city is located.
country	Displays the country where the state is located.
postal	Displays the postal code of the address.
prosPerIdentifierList	Displays a list of person identifiers for the prospect.
personIdNumber	Displays the value of the person identifier type.
persIsPrimaryId	<p>Indicates whether the prospect person identifier is primary or not. The valid values are:</p> <ul style="list-style-type: none"> True False
idType	Displays the identifier type using which the prospect person is created in the system.
prosChildRelationList	Displays the list of child persons associated with the prospect person.
childPersonId	Displays the child person of the prospect person.
personRelationshipType	Indicates how the child person is associated with the prospect person.
childPerType	Indicates the type of the child person.
division	Indicates the division to which the child person belongs.
childPersonIdType	Indicates the identifier type using which the child person is created in the system.
childPersonIdNumber	Displays the value of the identifier type using which the child person is created in the system.
endDate	Displays the date till when the child person is associated with the prospect person.
startDate	Displays the date from when the child person is associated with the prospect person.
prosParentPerRelationList	Displays the list of parent persons associated with the prospect person.
parentPersonId	Displays the parent person of the prospect person.
personRelationshipType	Indicates how the parent person is associated with the prospect person.
parentPerType	Indicates the type of the parent person.
division	Indicates the division to which the parent person belongs.
parentPersonIdType	Indicates the identifier type using which the parent person is created in the system.
parentPersonIdNumber	Displays the value of the identifier type using which the parent person is created in the system.

Tag Name	Tag Description
endDate	Displays the date till when the prospect person is associated with the parent person.
startDate	Displays the date from when the prospect person is associated with the parent person.
prosAccountList	Displays the list of accounts for the prospect person.
personId	Displays the prospect person identification value.
prospectAccountId	Displays the account identification value that is generated for the prospect person.
customerClass	Indicates the customer class to which the account is associated.
accountDivision	Indicate the division to which the account belongs.
status	Indicates the status of the account. The valid values are: <ul style="list-style-type: none"> ACTIVE INACTIVE
setUpDate	Displays the date from when the account is available for the prospect person.
currency	Indicates the currency code of the account.
billCycle	Indicates the time interval in which the bills are created for the account.
accountAccessGroup	Indicates the user group who can view and edit the details of the account.
prosAcctCharacteristicList	Displays the list of characteristics for the prospect account.
characteristicValue	Displays the value of the characteristic type.
effectiveDate	Displays the date from when the characteristic is effective for the account.
characteristicType	Indicates the characteristic type.
prosAcctIdentifierList	Displays the list of identifiers for the prospect account.
accountIdentifierType	Indicates the identifier type based on which the account is defined.
isPrimaryId	Indicates whether the prospect account identifier is primary or not. The valid values are: <ul style="list-style-type: none"> True False
accountNumber	Displays the account to which the identifier is associated.
prosPerCharacteristicList	Displays the list of characteristics defined for the prospect person.
personcharacteristicValue	Displays the value of the characteristic type.
personEffectiveDate	Displays the date from when the characteristic is effective for the prospect person.
personCharType	Indicates the characteristic type.

Related Topics

For more information on...	See...
Sample prospect view request and response in the XML format	Sample Prospect View Request and Response in the XML Format on page 3733

Sample Prospect Creation Request and Response in the XML Format

Using the below example, you can create the Smith prospect person in 930 division.

Sample Prospect Creation Request in the XML Format

```
<C1-ADDPROSPERSON>
  <actionFlag>ADD</actionFlag>
  <prospectPersonName>Smith</prospectPersonName>
  <division>930</division>
  <customerSegment>COMM</customerSegment>
  <customerTier>T</customerTier>
  <accessGroup>***</accessGroup>
  <emailAddress>smith@example.com</emailAddress>
  <status>ACTIVE</status>
  <birthDate>2000-01-01</birthDate>
  <address1>401</address1>
  <address2>Island Parkway</address2>
  <address3>Redwood Shores</address3>
  <address4>Redwood Shores</address4>
  <city>CA</city>
  <state>NEW YORK</state>
  <country>USA</country>
  <postal>94065</postal>
  <prosPerIdentifierList>
    <personIdNumber>smith</personIdNumber>
    <persIsPrimaryId>true</persIsPrimaryId>
    <idType>COREG</idType>
  </prosPerIdentifierList>
  <prosChildRelationList>
    <childPersonId>3784437346</childPersonId>
    <personRelationshipType>CHILD</personRelationshipType>
    <childPerType>PRSP</childPerType>
    <division>930</division>
    <childPersonIdType>Social Security number</childPersonIdType>
    <childPersonIdNumber>3167070400</childPersonIdNumber>
    <endDate>2025-01-01</endDate>
    <startDate>2019-01-01</startDate>
  </prosChildRelationList>
  <prosParentPerRelationList>
    <parentPersonId>1600395396</parentPersonId>
    <personRelationshipType>CHILD</personRelationshipType>
    <parentPerType>EPER</parentPerType>
    <division>930</division>
    <parentPersonIdType>Social Security number</parentPersonIdType>
    <parentPersonIdNumber>4598409119</parentPersonIdNumber>
    <endDate>2025-01-01</endDate>
    <startDate>2019-01-01</startDate>
  </prosParentPerRelationList>
  <prosAccountList>
    <personId>6709873933</personId>
    <customerClass>BKCORPV1</customerClass>
    <accountDivision>930</accountDivision>
    <status>ACTIVE</status>
    <setUpDate>2021-01-01</setUpDate>
    <currency>USD</currency>
    <billCycle>BKEM</billCycle>
    <accountAccessGroup>***</accountAccessGroup>
    <prosAcctCharacteristicList>
      <characteristicValue>PROS</characteristicValue>
      <effectiveDate>2025-01-01</effectiveDate>
      <characteristicType>C1_F_ANO</characteristicType>
    </prosAcctCharacteristicList>
    <prosAcctIdentifierList>
      <accountIdentifierType>ACCT_NM</accountIdentifierType>
      <isPrimaryId>true</isPrimaryId>
    </prosAcctIdentifierList>
  </prosAccountList>
</C1-ADDPROSPERSON>
```

```

        <accountNumber>PROS</accountNumber>
      </prosAcctIdentifierList>
    </prosAccountList>
    <prosPerCharacteristicList>
      <personCharacteristicValue>ORG</personCharacteristicValue>
      <personEffectiveDate>2025-01-01</personEffectiveDate>
      <personCharType>ORGORFI</personCharType>
    </prosPerCharacteristicList>
  </C1-ADDPROSPERSON>

```

Note: If you do not want to enter the data in the list tags (i.e. tags where the type is set to list), you should not include them in the request. Adding empty list tags will give erroneous results.

Sample Prospect Creation Response in the XML Format

```

<C1-ADDPROSPERSON>
  <prospectPersonId>7253834552</prospectPersonId>
  <actionFlag>ADD</actionFlag>
  <prospectPersonName>Smith</prospectPersonName>
  <division>930</division>
  <customerSegment>COMM</customerSegment>
  <customerTier>T</customerTier>
  <accessGroup>***</accessGroup>
  <emailAddress>smith@example.com</emailAddress>
  <status>ACTIVE</status>
  <birthDate>2000-01-01</birthDate>
  <address1>401</address1>
  <address2>Island Parkway</address2>
  <address3>Redwood Shores</address3>
  <address4>Redwood Shores</address4>
  <city>CA</city>
  <state>New York</state>
  <country>USA</country>
  <postal>94065</postal>
  <prosPerIdentifierList>
    <personIdNumber>Smith</personIdNumber>
    <persIsPrimaryId>true</persIsPrimaryId>
    <idType>COREG</idType>
  </prosPerIdentifierList>
  <prosChildRelationList>
    <childPersonId>3784437346</childPersonId>
    <personRelationshipType>CHILD</personRelationshipType>
    <childPerType>PRSP</childPerType>
    <division>930</division>
    <childPersonIdType>Social Security number</childPersonIdType>
    <childPersonIdNumber>3167070400</childPersonIdNumber>
    <endDate>2025-01-01</endDate>
    <startDate>2018-01-01</startDate>
  </prosChildRelationList>
  <prosParentPerRelationList>
    <parentPersonId>1600395396</parentPersonId>
    <personRelationshipType>CHILD</personRelationshipType>
    <parentPerType>EPER</parentPerType>
    <division>930</division>
    <parentPersonIdType>Social Security number</parentPersonIdType>
    <parentPersonIdNumber>4598409119</parentPersonIdNumber>
    <endDate>2025-01-01</endDate>
    <startDate>2019-01-01</startDate>
  </prosParentPerRelationList>
  <prosAccountList>
    <personId>6709873933</personId>
    <prospectAccountId>7649992977</prospectAccountId>
    <customerClass>BKCORPV1</customerClass>
  </prosAccountList>

```

```

<accountDivision>930</accountDivision>
<status>ACTIVE</status>
<setUpDate>2021-01-01</setUpDate>
<currency>USD</currency>
<billCycle>BKEM</billCycle>
<accountAccessGroup>***</accountAccessGroup>
<prosAcctCharacteristicList>
  <characteristicValue>PROS</characteristicValue>
  <effectiveDate>2025-01-01</effectiveDate>
  <characteristicType>Cl_F_ANO</characteristicType>
</prosAcctCharacteristicList>
<prosAcctIdentifierList>
  <accountIdentifierType>ACCT_NM</accountIdentifierType>
  <isPrimaryId>>true</isPrimaryId>
  <accountNumber>PROS</accountNumber>
</prosAcctIdentifierList>
</prosAccountList>
<prosPerCharacteristicList>
  <personcharacteristicValue>ORG</personcharacteristicValue>
  <personEffectiveDate>2025-01-01</personEffectiveDate>
  <personCharType>ORGORFI</personCharType>
</prosPerCharacteristicList>
</Cl-ADDPROSPERSON>

```

Note: We have given the above request and response samples to illustrate how the tags should be nested while sending a prospect creation request from the external system. However, you should not seamlessly use this request sample in your environment because the required pre-requisite data may not be available in your environment. In such case, the system will give erroneous results.

Related Topics

For more information on...	See...
Prospect add request and response tags in the XML format	Prospect Add Request and Response - Tags in the XML Format on page 3708

Sample Prospect Update Request and Response in the XML Format

Using the below example, you can update the prospect person for 3009626623 prospect person ID.

Sample Prospect Update Request in the XML Format

```

<Cl-ADDPROSPERSON>
  <prospectPersonId>3009626623</prospectPersonId>
  <actionFlag>UPD</actionFlag>
  <prospectPersonName>Smith</prospectPersonName>
  <division>930</division>
  <customerSegment>CORP</customerSegment>
  <customerTier>T</customerTier>
  <accessGroup>BKUSER</accessGroup>
  <emailAddress>smith@example.com</emailAddress>
  <status>ACTIVE</status>
  <birthDate>2000-01-01</birthDate>
  <address1>401</address1>
  <address2>Island Parkway</address2>
  <address3>Redwood Shores</address3>
  <address4>Redwood Shores</address4>
  <city>CA</city>
  <state>New York</state>
  <country>CA</country>
  <postal>94065</postal>
  <prosPerIdentifierList>
    <personIdNumber>456</personIdNumber>
  </prosPerIdentifierList>
</Cl-ADDPROSPERSON>

```

```

    <persIsPrimaryId>true</persIsPrimaryId>
    <idType>TAXID</idType>
  </prosPerIdentifierList>
  <prosChildRelationList>
    <childPersonId>0146105591</childPersonId>
    <personRelationshipType>PARENT</personRelationshipType>
    <childPerType>PRSP</childPerType>
    <division>930</division>
    <childPersonIdType>Social Security number</childPersonIdType>
    <childPersonIdNumber>3167070400</childPersonIdNumber>
    <endDate>2025-01-01</endDate>
    <startDate>2024-01-01</startDate>
  </prosChildRelationList>
  <prosParentPerRelationList>
    <parentPersonId>1600395396</parentPersonId>
    <personRelationshipType>CHILD</personRelationshipType>
    <parentPerType>EPER</parentPerType>
    <division>930</division>
    <parentPersonIdType>Social Security number</parentPersonIdType>
    <parentPersonIdNumber>4598409119</parentPersonIdNumber>
    <endDate>2025-01-01</endDate>
    <startDate>2024-01-01</startDate>
  </prosParentPerRelationList>
  <prosAccountList>
    <personId>6709873933</personId>
    <customerClass>BK</customerClass>
    <accountDivision>930</accountDivision>
    <status>ACTIVE</status>
    <setUpDate>2024-01-01</setUpDate>
    <currency>USD</currency>
    <billCycle>ASH3</billCycle>
    <accountAccessGroup>BKUSER</accountAccessGroup>
    <prosAcctCharacteristicList>
      <characteristicValue>PROS</characteristicValue>
      <effectiveDate>2024-01-01</effectiveDate>
      <characteristicType>C1_F_ANO</characteristicType>
    </prosAcctCharacteristicList>
    <prosAcctIdentifierList>
      <accountIdentifierType>ACCT_NM</accountIdentifierType>
      <isPrimaryId>true</isPrimaryId>
      <accountNumber>PROS</accountNumber>
    </prosAcctIdentifierList>
  </prosAccountList>
  <prosPerCharacteristicList>
    <personCharacteristicValue>I</personCharacteristicValue>
    <personEffectiveDate>2025-01-01</personEffectiveDate>
    <personCharType>C1CUSTAT</personCharType>
  </prosPerCharacteristicList>
</C1-ADDPROSPERSON>

```

Note: If you do not want to enter the data in the list tags (i.e. tags where the type is set to list), you should not include them in the request. Adding empty list tags will give erroneous results.

Sample Prospect Update Response in the XML Format

```

<C1-ADDPROSPERSON>
  <prospectPersonId>8982132112</prospectPersonId>
  <actionFlag>UPD</actionFlag>
  <prospectPersonName>Smith</prospectPersonName>
  <division>930</division>
  <customerSegment>COMM</customerSegment>
  <customerTier>T</customerTier>
  <accessGroup>BKUSER</accessGroup>

```

```

<emailAddress>smith@example.com</emailAddress>
<status>Active</status>
<birthDate>2000-01-01</birthDate>
<address1>401</address1>
<address2>Island Parkway</address2>
<address3>Redwood Shores</address3>
<address4>Redwood Shores</address4>
<city>CA</city>
<state>New York</state>
<country>USA</country>
<postal>94065</postal>
<prosPerIdentifierList>
  <personIdNumber>456</personIdNumber>
  <persIsPrimaryId>false</persIsPrimaryId>
  <idType>PIN</idType>
</prosPerIdentifierList>
<prosPerIdentifierList>
  <personIdNumber>456</personIdNumber>
  <persIsPrimaryId>true</persIsPrimaryId>
  <idType>TAXID</idType>
</prosPerIdentifierList>
<prosChildRelationList>
  <childPersonId>0146105591</childPersonId>
  <personRelationshipType>PARENT</personRelationshipType>
  <childPerType>PRSP</childPerType>
  <division>930</division>
  <childPersonIdType>Social Security number</childPersonIdType>
  <childPersonIdNumber>3167070400</childPersonIdNumber>
  <endDate>2025-01-01</endDate>
  <startDate>2024-01-01</startDate>
</prosChildRelationList>
<prosParentPerRelationList>
  <parentPersonId>1600395396</parentPersonId>
  <personRelationshipType>CHILD</personRelationshipType>
  <parentPerType>EPER</parentPerType>
  <division>930</division>
  <parentPersonIdType>Social Security number</parentPersonIdType>
  <parentPersonIdNumber>4598409119</parentPersonIdNumber>
  <endDate>2025-01-01</endDate>
  <startDate>2024-01-01</startDate>
</prosParentPerRelationList>
<prosAccountList>
  <personId>6709873933</personId>
  <prospectAccountId>0017549904</prospectAccountId>
  <customerClass>BK</customerClass>
  <accountDivision>930</accountDivision>
  <status>ACTIVE</status>
  <setUpDate>2024-01-01</setUpDate>
  <currency>USD</currency>
  <billCycle>ASH3</billCycle>
  <accountAccessGroup>BKUSER</accountAccessGroup>
  <prosAcctCharacteristicList>
    <characteristicValue>PROS</characteristicValue>
    <effectiveDate>2024-01-01</effectiveDate>
    <characteristicType>Cl_F_ANO</characteristicType>
  </prosAcctCharacteristicList>
  <prosAcctIdentifierList>
    <accountIdentifierType>CCT_NM</accountIdentifierType>
    <isPrimaryId>true</isPrimaryId>
    <accountNumber>PROS</accountNumber>
  </prosAcctIdentifierList>
</prosAccountList>
<prosAccountList>
  <personId>6709873933</personId>

```

```

<prospectAccountId>0261587703</prospectAccountId>
<customerClass>BK</customerClass>
<accountDivision>930</accountDivision>
<status>ACTIVE</status>
<setUpDate>2024-01-01</setUpDate>
<currency>USD</currency>
<billCycle>ASH3</billCycle>
<accountAccessGroup>BKUSER</accountAccessGroup>
<prosAcctCharacteristicList>
  <characteristicValue>PROS</characteristicValue>
  <effectiveDate>2024-01-01</effectiveDate>
  <characteristicType>Cl_F_ANO</characteristicType>
</prosAcctCharacteristicList>
<prosAcctIdentifierList>
  <accountIdentifierType>CCT_NM</accountIdentifierType>
  <isPrimaryId>true</isPrimaryId>
  <accountNumber>PROS</accountNumber>
</prosAcctIdentifierList>
</prosAccountList>
<prosAccountList>
  <personId>6081480244</personId>
  <prospectAccountId>0261587703</prospectAccountId>
  <customerClass>BK</customerClass>
  <accountDivision>930</accountDivision>
  <status>ACTIVE</status>
  <setUpDate>2024-01-01</setUpDate>
  <currency>USD</currency>
  <billCycle>ASH3</billCycle>
  <accountAccessGroup>BKUSER</accountAccessGroup>
  <prosAcctCharacteristicList>
    <characteristicValue>PROS</characteristicValue>
    <effectiveDate>2024-01-01</effectiveDate>
    <characteristicType>Cl_F_ANO</characteristicType>
  </prosAcctCharacteristicList>
  <prosAcctIdentifierList>
    <accountIdentifierType>CCT_NM</accountIdentifierType>
    <isPrimaryId>true</isPrimaryId>
    <accountNumber>PROS</accountNumber>
  </prosAcctIdentifierList>
</prosAccountList>
<prosAccountList>
  <personId>3055256440</personId>
  <prospectAccountId>0261587703</prospectAccountId>
  <customerClass>BK</customerClass>
  <accountDivision>930</accountDivision>
  <status>ACTIVE</status>
  <setUpDate>2024-01-01</setUpDate>
  <currency>USD</currency>
  <billCycle>ASH3</billCycle>
  <accountAccessGroup>BKUSER</accountAccessGroup>
  <prosAcctCharacteristicList>
    <characteristicValue>PROS</characteristicValue>
    <effectiveDate>2024-01-01</effectiveDate>
    <characteristicType>Cl_F_ANO</characteristicType>
  </prosAcctCharacteristicList>
  <prosAcctIdentifierList>
    <accountIdentifierType>CCT_NM</accountIdentifierType>
    <isPrimaryId>true</isPrimaryId>
    <accountNumber>PROS</accountNumber>
  </prosAcctIdentifierList>
</prosAccountList>
<prosAccountList>
  <personId>3749439310</personId>
  <prospectAccountId>0261587703</prospectAccountId>

```



```

<customerClass>BK</customerClass>
<accountDivision>930</accountDivision>
<status>ACTIVE</status>
<setUpDate>2024-01-01</setUpDate>
<currency>USD</currency>
<billCycle>ASH3</billCycle>
<accountAccessGroup>BKUSER</accountAccessGroup>
<prosAcctCharacteristicList>
  <characteristicValue>PROS</characteristicValue>
  <effectiveDate>2024-01-01</effectiveDate>
  <characteristicType>C1_F_ANO</characteristicType>
</prosAcctCharacteristicList>
<prosAcctIdentifierList>
  <accountIdentifierType>CCT_NM</accountIdentifierType>
  <isPrimaryId>true</isPrimaryId>
  <accountNumber>PROS</accountNumber>
</prosAcctIdentifierList>
</prosAccountList>
<prosPerCharacteristicList>
  <personCharacteristicValue>A</personCharacteristicValue>
  <personEffectiveDate>2011-01-01</personEffectiveDate>
  <personCharType>C1CUSTAT</personCharType>
</prosPerCharacteristicList>
</C1-ADDPROSPERSON>

```

Note: We have given the above request and response samples to illustrate how the tags should be nested while sending a prospect update request from the external system. However, you should not seamlessly use this request sample in your environment because the required pre-requisite data may not be available in your environment. In such case, the system will give erroneous results.

Related Topics

For more information on...	See...
Prospect update request and response tags in the XML format	Prospect Update Request and Response - Tags in the XML Format on page 3716

Sample Prospect View Request and Response in the XML Format

Using the below example, you can view the prospect person of 8982132112 prospect person ID.

Sample Prospect View Request in the XML Format

```

<C1-ADDPROSPERSON>
  <prospectPersonId>8982132112</prospectPersonId>
  <actionFlag>READ</actionFlag>
</C1-ADDPROSPERSON>

```

Sample Prospect View Response in the XML Format

```

<C1-ADDPROSPERSON>
  <prospectPersonId>8982132112</prospectPersonId>
  <actionFlag>READ</actionFlag>
  <prospectPersonName>Smith</prospectPersonName>
  <division>930</division>
  <customerSegment>COMM</customerSegment>
  <customerTier>T</customerTier>
  <accessGroup>BKUSER</accessGroup>
  <emailAddress>smith@example.com</emailAddress>
  <status>ACTIVE</status>
  <birthDate>2022-01-01</birthDate>
  <address1>401</address1>
  <address2>Island Parkway</address2>

```

```

<address3>Redwood Shores</address3>
<address4>Redwood Shores</address4>
<city>CA</city>
<state>New York</state>
<country>USA</country>
<postal>94065</postal>
<prosPerIdentifierList>
  <personIdNumber>123</personIdNumber>
  <persIsPrimaryId>>false</persIsPrimaryId>
  <idType>PIN</idType>
</prosPerIdentifierList>
<prosPerIdentifierList>
  <personIdNumber>456</personIdNumber>
  <persIsPrimaryId>>true</persIsPrimaryId>
  <idType>SSN</idType>
</prosPerIdentifierList>
<prosChildRelationList>
  <childPersonId>9773712881</childPersonId>
  <personRelationshipType>CHILD</personRelationshipType>
  <childPerType>PRSP</childPerType>
  <division>930</division>
  <childPersonIdType>Social Security number</childPersonIdType>
  <childPersonIdNumber>3167070400</childPersonIdNumber>
  <endDate>2025-01-01</endDate>
  <startDate>2024-01-01</startDate>
</prosChildRelationList>
<prosParentPerRelationList>
  <parentPersonId>1600395396</parentPersonId>
  <personRelationshipType>CHILD</personRelationshipType>
  <parentPerType>EPER</parentPerType>
  <division>930</division>
  <parentPersonIdType>Social Security number</parentPersonIdType>
  <parentPersonIdNumber>4598409119</parentPersonIdNumber>
  <endDate>2025-01-01</endDate>
  <startDate>2024-01-01</startDate>
</prosParentPerRelationList>
<prosAccountList>
  <personId>6709873933</personId>
  <prospectAccountId>0017549904</prospectAccountId>
  <customerClass>BK</customerClass>
  <accountDivision>930</accountDivision>
  <status>ACTIVE</status>
  <setUpDate>2024-01-01</setUpDate>
  <currency>USD</currency>
  <billCycle>ASH3</billCycle>
  <accountAccessGroup>BKUSER</accountAccessGroup>
  <prosAcctCharacteristicList>
    <characteristicValue>PROS</characteristicValue>
    <effectiveDate>2024-01-01</effectiveDate>
    <characteristicType>C1_F_ANO</characteristicType>
  </prosAcctCharacteristicList>
  <prosAcctIdentifierList>
    <accountIdentifierType>CCT_NM</accountIdentifierType>
    <isPrimaryId>PROS</isPrimaryId>
    <accountNumber>PROS</accountNumber>
  </prosAcctIdentifierList>
</prosAccountList>
<prosAccountList>
  <personId>6709873933</personId>
  <prospectAccountId>0261587703</prospectAccountId>
  <customerClass>BK</customerClass>
  <accountDivision>930</accountDivision>
  <status>ACTIVE</status>
  <setUpDate>2024-01-01</setUpDate>

```

```

<currency>USD</currency>
<billCycle>ASH3</billCycle>
<accountAccessGroup>BKUSER</accountAccessGroup>
<prosAcctCharacteristicList>
  <characteristicValue>PROS</characteristicValue>
  <effectiveDate>2024-01-01</effectiveDate>
  <characteristicType>C1_F_ANO</characteristicType>
</prosAcctCharacteristicList>
<prosAcctIdentifierList>
  <accountIdentifierType>CCT_NM</accountIdentifierType>
  <isPrimaryId>>true</isPrimaryId>
  <accountNumber>PROS</accountNumber>
</prosAcctIdentifierList>
</prosAccountList>
<prosAccountList>
  <personId>6081480244</personId>
  <prospectAccountId>4409313506</prospectAccountId>
  <customerClass>BK</customerClass>
  <accountDivision>930</accountDivision>
  <status>ACTIVE</status>
  <setUpDate>2024-01-01</setUpDate>
  <currency>USD</currency>
  <billCycle>ASH3</billCycle>
  <accountAccessGroup>BKUSER</accountAccessGroup>
  <prosAcctCharacteristicList>
    <characteristicValue>PROS</characteristicValue>
    <effectiveDate>2024-01-01</effectiveDate>
    <characteristicType>C1_F_ANO</characteristicType>
  </prosAcctCharacteristicList>
  <prosAcctIdentifierList>
    <accountIdentifierType>CCT_NM</accountIdentifierType>
    <isPrimaryId>>true</isPrimaryId>
    <accountNumber>PROS</accountNumber>
  </prosAcctIdentifierList>
</prosAccountList>
<prosAccountList>
  <personId>3055256440</personId>
  <prospectAccountId>7285093705</prospectAccountId>
  <customerClass>BK</customerClass>
  <accountDivision>930</accountDivision>
  <status>ACTIVE</status>
  <setUpDate>2024-01-01</setUpDate>
  <currency>USD</currency>
  <billCycle>ASH3</billCycle>
  <accountAccessGroup>BKUSER</accountAccessGroup>
  <prosAcctCharacteristicList>
    <characteristicValue>008</characteristicValue>
    <effectiveDate>2024-01-01</effectiveDate>
    <characteristicType>C2CNTSER</characteristicType>
  </prosAcctCharacteristicList>
  <prosAcctIdentifierList>
    <accountIdentifierType>C1_F_ANO</accountIdentifierType>
    <isPrimaryId>>true</isPrimaryId>
    <accountNumber>4567</accountNumber>
  </prosAcctIdentifierList>
</prosAccountList>
<prosPerCharacteristicList>
  <personCharacteristicValue>A</personCharacteristicValue>
  <personEffectiveDate>2011-01-01</personEffectiveDate>
  <personCharType>C1CUSTAT</personCharType>
</prosPerCharacteristicList>
</C1-ADDPROSPERSON>

```

Note: We have given the above request and response samples to illustrate how the tags should be nested while sending a prospect view request from the external system. However, you should not seamlessly use this request sample in your environment because the required pre-requisite data may not be available in your environment. In such case, the system will give erroneous results.

Related Topics

For more information on...	See...
Prospect view request and response tags in the XML format	Prospect View Request and Response - Tags in the XML Format on page 3723

Prospect Add Request in the JSON Format

The following code snippet illustrates how the attribute/value pairs should be structured while receiving the prospect add request in the JSON format:

```
{
  "C1-ADDPROSPERSON"
  {
    "actionFlag" : "",
    "prospectPersonName" : "",
    "division" : "",
    "customerSegment" : "",
    "customerTier" : "",
    "accessGroup" : "",
    "emailAddress" : "",
    "status" : "",
    "birthDate" : "",
    "address1" : "",
    "address2" : "",
    "address3" : "",
    "address4" : "",
    "city" : "",
    "state" : "",
    "country" : "",
    "postal" : "",
    "prosPerIdentifierList"
    {
      "personIdNumber" : "",
      "persIsPrimaryId" : "",
      "idType" : "",
    }
    "prosChildRelationList"
    {
      "childPersonId" : "",
      "personRelationshipType" : "",
      "childPerType" : "",
      "division" : "",
      "childPersonIdType" : "",
      "childPersonIdNumber" : "",
      "endDate" : "",
      "startDate" : "",
    }
    "prosParentPerRelationList"
    {
      "parentPersonId" : "",
      "personRelationshipType" : "",
      "parentPerType" : "",
      "division" : "",
      "parentPersonIdType" : "",
      "parentPersonIdNumber" : "",
    }
  }
}
```

```

        "endDate" : "",
        "startDate" : "",
    }
    "prosAccountList"
    {
        "personId" : "",
        "prospectAccountId" : "",
        "customerClass" : "",
        "accountDivision" : "",
        "status" : "",
        "setUpDate" : "",
        "currency" : "",
        "billCycle" : "",
        "accountAccessGroup" : "",
        "prosAcctCharacteristicList"
        {
            "characteristicValue" : "",
            "effectiveDate" : "",
            "characteristicType" : "",
        }
        "prosAcctIdentifierList"
        {
            "accountIdentifierType" : "",
            "isPrimaryId" : "",
            "accountNumber" : "",
        }
    }
    "prosPerCharacteristicList"
    {
        "personcharacteristicValue" : "",
        "personEffectiveDate" : "",
        "personCharType" : "",
    }
}
}

```

Related Topics

For more information on...	See...
Prospect add request and response attribute/value pairs in the JSON format	Prospect Add Request and Response - Attribute/Value Pairs in the JSON Format on page 3744
Sample prospect creation request and response in the JSON format	Sample Prospect Creation Request and Response in the JSON Format on page 3762

Prospect Add Response in the JSON Format

The following code snippet illustrates how the attribute/value pairs should be structured while sending the prospect add response in the JSON format:

```

{
  "C1-ADDPROSPERSON"
  {
    "prospectPersonId" : "",
    "actionFlag" : "",
    "prospectPersonName" : "",
    "division" : "",
    "customerSegment" : "",
    "customerTier" : "",
    "accessGroup" : "",
    "emailAddress" : "",
    "status" : "",
  }
}

```

```

"birthDate" : "",
"address1" : "",
"address2" : "",
"address3" : "",
"address4" : "",
"city" : "",
"state" : "",
"country" : "",
"postal" : "",
"prosPerIdentifierList"
{
  "personIdNumber" : "",
  "persIsPrimaryId" : "",
  "idType" : "",
}
"prosChildRelationList"
{
  "childPersonId" : "",
  "personRelationshipType" : "",
  "childPerType" : "",
  "division" : "",
  "childPersonIdType" : "",
  "childPersonIdNumber" : "",
  "endDate" : "",
  "startDate" : "",
}
"prosParentPerRelationList"
{
  "parentPersonId" : "",
  "personRelationshipType" : "",
  "parentPerType" : "",
  "division" : "",
  "parentPersonIdType" : "",
  "parentPersonIdNumber" : "",
  "endDate" : "",
  "startDate" : "",
}
"prosAccountList"
{
  "personId" : "",
  "prospectAccountId" : "",
  "customerClass" : "",
  "accountDivision" : "",
  "status" : "",
  "setUpDate" : "",
  "currency" : "",
  "billCycle" : "",
  "accountAccessGroup" : "",
  "prosAcctCharacteristicList"
  {
    "characteristicValue" : "",
    "effectiveDate" : "",
    "characteristicType" : "",
  }
  "prosAcctIdentifierList"
  {
    "accountIdentifierType" : "",
    "isPrimaryId" : "",
    "accountNumber" : "",
  }
}
"prosPerCharacteristicList"
{
  "personcharacteristicValue" : "",

```

```

        "personEffectiveDate" : "",
        "personCharType" : "",
    }
}

```

Related Topics

For more information on...	See...
Prospect add request and response attribute/value pairs in the JSON format	Prospect Add Request and Response - Attribute/Value Pairs in the JSON Format on page 3744
Sample prospect creation request and response in the JSON format	Sample Prospect Creation Request and Response in the JSON Format on page 3762

Prospect Update Request in the JSON Format

The following code snippet illustrates how the attribute/value pairs should be structured while receiving the prospect update request in the JSON format:

```

{
  "C1-ADDPROSPERSON"
  {
    "prospectPersonId" : "",
    "actionFlag" : "",
    "prospectPersonName" : "",
    "division" : "",
    "customerSegment" : "",
    "customerTier" : "",
    "accessGroup" : "",
    "emailAddress" : "",
    "status" : "",
    "birthDate" : "",
    "address1" : "",
    "address2" : "",
    "address3" : "",
    "address4" : "",
    "city" : "",
    "state" : "",
    "country" : "",
    "postal" : "",
    "prosPerIdentifierList"
    {
      "personIdNumber" : "",
      "persIsPrimaryId" : "",
      "idType" : "",
    }
    "prosChildRelationList"
    {
      "childPersonId" : "",
      "personRelationshipType" : "",
      "childPerType" : "",
      "division" : "",
      "childPersonIdType" : "",
      "childPersonIdNumber" : "",
      "endDate" : "",
      "startDate" : "",
    }
    "prosParentPerRelationList"
    {
      "parentPersonId" : "",
      "personRelationshipType" : "",
    }
  }
}

```

```

        "parentPerType" : "",
        "division" : "",
        "parentPersonIdType" : "",
        "parentPersonIdNumber" : "",
        "endDate" : "",
        "startDate" : "",
    }
    "prosAccountList"
    {
        "personId" : "",
        "prospectAccountId" : "",
        "customerClass" : "",
        "accountDivision" : "",
        "status" : "",
        "setUpDate" : "",
        "currency" : "",
        "billCycle" : "",
        "accountAccessGroup" : "",
        "prosAcctCharacteristicList"
        {
            "characteristicValue" : "",
            "effectiveDate" : "",
            "characteristicType" : "",
        }
        "prosAcctIdentifierList"
        {
            "accountIdentifierType" : "",
            "isPrimaryId" : "",
            "accountNumber" : "",
        }
    }
    "prosPerCharacteristicList"
    {
        "personcharacteristicValue" : "",
        "personEffectiveDate" : "",
        "personCharType" : "",
    }
}

```

Related Topics

For more information on...	See...
Prospect update request and response attribute/value pairs in the JSON format	Prospect Update Request and Response - Attribute/Value Pairs in the JSON Format on page 3751
Sample prospect update request and response in the JSON format	Sample Prospect Update Request and Response in the JSON Format on page 3765

Prospect Update Response in the JSON Format

The following code snippet illustrates how the attribute/value pairs should be structured while receiving the prospect update response in the JSON format:

```

{
    "C1-ADDPROSPERSON"
    {
        "prospectPersonId" : "",
        "actionFlag" : "",
        "prospectPersonName" : "",
        "division" : "",
        "customerSegment" : "",
    }
}

```



```

"customerTier" : "",
"accessGroup" : "",
"emailAddress" : "",
"status" : "",
"birthDate" : "",
"address1" : "",
"address2" : "",
"address3" : "",
"address4" : "",
"city" : "",
"state" : "",
"country" : "",
"postal" : "",
"prosPerIdentifierList"
{
  "personIdNumber" : "",
  "persIsPrimaryId" : "",
  "idType" : "",
}
"prosChildRelationList"
{
  "childPersonId" : "",
  "personRelationshipType" : "",
  "childPerType" : "",
  "division" : "",
  "childPersonIdType" : "",
  "childPersonIdNumber" : "",
  "endDate" : "",
  "startDate" : "",
}
"prosParentPerRelationList"
{
  "parentPersonId" : "",
  "personRelationshipType" : "",
  "parentPerType" : "",
  "division" : "",
  "parentPersonIdType" : "",
  "parentPersonIdNumber" : "",
  "endDate" : "",
  "startDate" : "",
}
"prosAccountList"
{
  "personId" : "",
  "prospectAccountId" : "",
  "customerClass" : "",
  "accountDivision" : "",
  "status" : "",
  "setUpDate" : "",
  "currency" : "",
  "billCycle" : "",
  "accountAccessGroup" : "",
  "prosAcctCharacteristicList"
  {
    "characteristicValue" : "",
    "effectiveDate" : "",
    "characteristicType" : "",
  }
  "prosAcctIdentifierList"
  {
    "accountIdentifierType" : "",
    "isPrimaryId" : "",
    "accountNumber" : "",
  }
}

```

```

    }
    "prosperCharacteristicList"
    {
        "personCharacteristicValue" : "",
        "personEffectiveDate" : "",
        "personCharType" : "",
    }
}

```

Related Topics

For more information on...	See...
Prospect update request and response attribute/value pairs in the JSON format	Prospect Update Request and Response - Attribute/Value Pairs in the JSON Format on page 3751
Sample prospect update request and response in the JSON format	Sample Prospect Update Request and Response in the JSON Format on page 3765

Prospect View Request in the JSON Format

The following code snippet illustrates how the attribute/value pairs should be structured while receiving the prospect view request in the JSON format:

```

{
    "C1-ADDPROSPERSON"
    {
        "prospectPersonId" : ""
        "actionFlag" : "",
    }
}

```

Related Topics

For more information on...	See...
Prospect view request and response attribute/value pairs in the JSON format	Prospect View Request and Response - Attribute/Value Pairs in the JSON Format on page 3758
Sample prospect view request and response in the JSON format	Sample Prospect View Request and Response in the JSON Format on page 3769

Prospect View Response in the JSON Format

The following code snippet illustrates how the attribute/value pairs should be structured while sending the prospect view response in the JSON format:

```

{
    "C1-ADDPROSPERSON"
    {
        "prospectPersonId" : ""
        "actionFlag" : "",
        "prospectPersonName" : "",
        "division" : "",
        "customerSegment" : "",
        "customerTier" : "",
        "accessGroup" : "",
        "emailAddress" : "",
        "status" : "",
        "birthDate" : "",
        "address1" : "",
        "address2" : "",
    }
}

```

```

"address3" : "",
"address4" : "",
"city" : "",
"state" : "",
"country" : "",
"postal" : "",
"prosPerIdentifierList"
{
  "personIdNumber" : "",
  "persIsPrimaryId" : "",
  "idType" : "",
}
"prosChildRelationList"
{
  "childPersonId" : "",
  "personRelationshipType" : "",
  "childPerType" : "",
  "division" : "",
  "childPersonIdType" : "",
  "childPersonIdNumber" : "",
  "endDate" : "",
  "startDate" : "",
}
"prosParentPerRelationList"
{
  "parentPersonId" : "",
  "personRelationshipType" : "",
  "parentPerType" : "",
  "division" : "",
  "parentPersonIdType" : "",
  "parentPersonIdNumber" : "",
  "endDate" : "",
  "startDate" : "",
}
"prosAccountList"
{
  "personId" : "",
  "prospectAccountId" : "",
  "customerClass" : "",
  "accountDivision" : "",
  "status" : "",
  "setUpDate" : "",
  "currency" : "",
  "billCycle" : "",
  "accountAccessGroup" : "",
  "prosAcctCharacteristicList"
  {
    "characteristicValue" : "",
    "effectiveDate" : "",
    "characteristicType" : "",
  }
  "prosAcctIdentifierList"
  {
    "accountIdentifierType" : "",
    "isPrimaryId" : "",
    "accountNumber" : "",
  }
}
"prosPerCharacteristicList"
{
  "personCharacteristicValue" : "",
  "personEffectiveDate" : "",
  "personCharType" : "",
}

```

```
}
}
```

Related Topics

For more information on...	See...
Prospect view request and response attribute/value pairs in the JSON format	Prospect View Request and Response - Attribute/Value Pairs in the JSON Format on page 3758
Sample prospect view request and response in the JSON format	Sample Prospect View Request and Response in the JSON Format on page 3769

Prospect Add Request and Response - Attribute/Value Pairs in the JSON Format

Note: We recommend you to refer the topics [Prospect Add Request in the JSON Format](#) on page 3736 and [Prospect Add Response in the JSON Format](#) on page 3737 in parallel while understanding the below mentioned attributes. This will help you to understand how the attribute/value pairs are nested in the JSON format.

Before calling the **C1-ADDPROSPERSON** business service through an inbound web service, you need to ensure that the prospect add request contains the following attributes:

Attribute Name	Attribute Description	Mandatory (Yes or No)
actionFlag	Used to indicate that you want to create request to add a prospect. The valid value is: <ul style="list-style-type: none"> ADD 	Yes
	Note: If you do not specify the value in this attribute, the system considers it as an ADD action.	
prospectPersonName	Used to specify the name of the prospect person.	Yes
	Note: You should specify a person name which is already present in the system.	
division	Used to indicate the division to which you want to associate the prospect.	Yes
	Note: You must specify a division which is already defined in the system.	
customerSegment	Used to indicate the business component using which you want to create the prospect.	No
	Note: You should specify only those values which are present in the CUST_SEG_FLG lookup field.	
customerTier	Used to indicate the customer tier of the customer segment to which you want to associate the prospect.	No
	Note: You should specify only those values which are present in the CUST_TIER_FLG lookup field.	

Attribute Name	Attribute Description	Mandatory (Yes or No)
accessGroup	Used to indicate the user groups who can view and edit the details of the prospect.	Yes
	Note: You must specify an access group which is associated with the division to which the prospect belongs.	
emailAddress	Used to specify the email address of the prospect.	No
status	Used to indicate the status in which you want to create the prospect. <ul style="list-style-type: none"> • ACTIVE • INACTIVE 	Yes
	Note: The status of the prospect person can only be set to ACTIVE while adding a prospect person. If you do not specify the value in this attribute, the system, by default sets the status of the prospect person to ACTIVE .	
birthDate	Used to specify the date of birth of the prospect person.	No
address1	Used to specify the first line of the address. It may contain details, such as the house number.	No
address2	Used to specify the second line of the address. It may contain details, such as the apartment name.	No
address3	Used to specify the third line of the address. It may contain details, such as the street name.	No
address4	Used to specify the fourth line of the address. It may contain the landmark details.	No
city	Used to specify the city where the prospect is located.	No
state	Used to specify the state where the city is located.	No
country	Used to specify the country where the state is located.	No
postal	Used to specify the postal code of the address.	No
prosPerIdentifierList	Used to specify a list of person identifiers for the prospect.	No
personIdNumber	Used to specify the value of the person identifier type.	Yes (Conditional)
	Note: If you specify the idType attribute, you need to specify the personIdNumber attribute.	

Attribute Name	Attribute Description	Mandatory (Yes or No)
persIsPrimaryId	Used to indicate whether the prospect person identifier is primary or not. The valid values are: <ul style="list-style-type: none"> • True • False 	Yes (Conditional)
		Note: This data is required while specifying the prospect person identifier.
idType	Used to specify the identifier type using which you want to add the prospect person in the system. Note: If you specify the personIdNumber attribute, you need to specify the idType attribute.	Yes (Conditional)
		Note: This data is required while specifying the prospect person identifier.
prosChildRelationList	Used to specify a list of child persons associated with the prospect person.	No
childPersonId	Used to specify the child person of the prospect person.	Yes (Conditional)
		Note: This data is required while specifying the child person of the prospect person.
personRelationshipType	Used to indicate how the child person is associated with the prospect person.	Yes (Conditional)
		Note: This data is required while specifying the child person of the prospect person.
childPerType	Used to indicate the type of the child person.	Yes (Conditional)
		Note: This data is required while specifying the child person of the prospect person.
division	Used to indicate the division to which the child person belongs. Note: You must specify a division which is already defined in the system.	Yes (Conditional)
		Note: This data is required while specifying the child person of the prospect person.
childPersonIdType	Used to specify the identifier type using which the child person is created in the system. Note: If you specify the childPersonIdNumber attribute, you need to specify the childPersonIdType attribute.	Yes (Conditional)
		Note: This data is required while specifying the child person of the prospect person.
childPersonIdNumber	Used to specify the value of the identifier type using which the child person is created in the system.	Yes (Conditional)
		Note: This data is required while specifying the child person of the prospect person.

Attribute Name	Attribute Description	Mandatory (Yes or No)
	<p>Note: If you specify the childPersonIdType attribute, you need to specify the childPersonIdNumber attribute.</p>	
endDate	Used to specify the date till when the child person is associated with the prospect person.	No
startDate	Used to specify the date from when the child person is associated with the prospect person.	Yes (Conditional) <p>Note: This data is required while specifying the child person of the prospect person.</p>
prosParentPerRelationList	Used to specify a list of parent persons associated with the prospect person. <p>Note: You can now add a prospect person or account to an existing person in the system. In other words, the system allows you to add a prospect person or account in an existing person's hierarchy. Also, you can create deals for such prospect person's or account's, if required.</p>	No
parentPersonId	Used to specify the parent person of the prospect person.	Yes (Conditional) <p>Note: This data is required while specifying the parent person relationship of the prospect person.</p>
personRelationshipType	Used to indicate how the prospect person is associated with the specified person.	Yes (Conditional) <p>Note: This data is required while specifying the parent person relationship of the prospect person.</p>
parentPerType	Used to indicate the type of the parent person. The valid values are: <ul style="list-style-type: none"> • EPER - Used to indicate that the parent person is an existing person in the system. • PRSP - Used to indicate that the parent person is a prospect in the system. 	Yes (Conditional) <p>Note: This data is required while specifying the parent person relationship of the prospect person.</p>
division	Used to indicate the division to which the parent person belongs. <p>Note: You must specify a division which is already defined in the system.</p>	Yes (Conditional) <p>Note: This data is required while specifying the parent person relationship of the prospect person.</p>
parentPersonIdType	Used to specify the identifier type using which the parent person is created in the system.	Yes (Conditional)

Attribute Name	Attribute Description	Mandatory (Yes or No)
	<p>Note: If you specify the parentPersonIdNumber attribute, you need to specify the parentPersonIdType attribute.</p>	<p>Note: This data is required while specifying the parent person relationship of the prospect person.</p>
parentPersonIdNumber	<p>Used to specify the value of the identifier type using which the parent person is created in the system.</p> <p>Note: If you specify the parentPersonIdType attribute, you need to specify the parentPersonIdNumber attribute.</p>	<p>Yes (Conditional)</p> <p>Note: This data is required while specifying the parent person relationship of the prospect person.</p>
endDate	Used to specify the date till when the prospect person is associated with the parent person.	No
startDate	Used to specify the date from when the prospect person is associated with the parent person.	<p>Yes (Conditional)</p> <p>Note: This data is required while specifying the parent person relationship of the prospect person.</p>
prosAccountList	Used to specify a list of accounts for the prospect person.	No
personId	Used to specify the person to which the account belongs.	<p>Yes (Conditional)</p> <p>Note: This data is required while adding an account for the prospect person.</p>
customerClass	<p>Used to indicate the customer class to which the account is associated.</p> <p>Note: You must specify a customer class which is associated with the division to which the prospect account belongs.</p>	<p>Yes (Conditional)</p> <p>Note: This data is required while adding an account for the prospect person.</p>
accountDivision	<p>Used to indicate the division to which the account belongs.</p> <p>Note: If you do not specify the value in this attribute, the system considers the division of the person to whom the account is associated.</p>	<p>Yes (Conditional)</p> <p>Note: This data is required while adding an account for the prospect person.</p>
status	<p>Used to indicate the status of the account. The valid values are:</p> <ul style="list-style-type: none"> • ACTIVE • INACTIVE 	<p>Yes (Conditional)</p> <p>Note: This data is required while adding an account for the prospect person.</p>

Attribute Name	Attribute Description	Mandatory (Yes or No)
	<p>Note:</p> <p>The status of the prospect account can only be set to ACTIVE while adding a prospect account.</p> <p>If you do not specify the value in this attribute, the system, by default sets the status of the prospect account to ACTIVE.</p>	
setUpDate	Used to specify the date from when the account is available for the prospect person.	<p>Yes (Conditional)</p> <p>Note: This data is required while adding an account for the prospect person.</p>
currency	<p>Used to indicate the currency code of the account.</p> <p>Note: You must specify a currency which is already defined in the system and which is associated with the division to which the prospect account belongs.</p>	Yes
billCycle	Used to indicate the time interval in which you want to create the bills for the account.	<p>Yes (Conditional)</p> <p>Note: This data is required while adding an account for the prospect person.</p>
accountAccessGroup	<p>Used to indicate the user group who can view and edit the details of the account.</p> <p>Note: If you do not specify the value in this attribute, the system considers the access group of the person to whom the account belongs.</p>	<p>Yes (Conditional)</p> <p>Note: This data is required while adding an account for the prospect person.</p>
prosAcctCharacteristicList	Used to specify a list of characteristics for the prospect account.	No
characteristicValue	Used to specify the value for the characteristic type.	<p>Yes (Conditional)</p> <p>Note: This data is required while adding a characteristic for the prospect account.</p>
effectiveDate	Used to specify the date from when the characteristic is effective for the prospect account.	<p>Yes (Conditional)</p> <p>Note: This data is required while adding a characteristic for the prospect account.</p>
characteristicType	Used to indicate the characteristic type.	Yes (Conditional)

Attribute Name	Attribute Description	Mandatory (Yes or No)
	<p>Note: You must specify a characteristic type which is associated with the division to which the prospect account belongs.</p>	<p>Note: This data is required while adding a characteristic for the prospect account.</p>
prosAcctIdentifierList	Used to specify a list of identifiers for the prospect account.	No
accountIdentifierType	<p>Used to indicate the identifier type based on which you want to define the prospect account.</p> <p>Note: If you specify the accountNumber attribute, you need to specify the accountIdentifierType attribute.</p> <p>You must specify an identifier type which is associated with the division to which the prospect account belongs.</p>	<p>Yes (Conditional)</p> <p>Note: This data is required while associating an identifier with the prospect account.</p>
isPrimaryId	<p>Used to indicate whether the prospect account identifier is primary or not. The valid values are:</p> <ul style="list-style-type: none"> • True • False <p>Note: If you do not specify the value in this attribute, the system considers the value as False.</p>	<p>Yes (Conditional)</p> <p>Note: This data is required while associating an identifier with the prospect account.</p>
accountNumber	<p>Used to specify the prospect account to which you want to associate the identifier.</p> <p>Note: If you specify the accountIdentifierType attribute, you need to specify the accountNumber attribute.</p>	<p>Yes (Conditional)</p> <p>Note: This data is required while associating an identifier with the prospect account.</p>
prosPerCharacteristicList	Used to specify a list of characteristics for the prospect person.	No
personcharacteristicValue	Used to specify the value for the characteristic type.	<p>Yes (Conditional)</p> <p>Note: This data is required while adding a characteristic for the prospect person.</p>
personEffectiveDate	Used to specify the date from when the characteristic is effective for the prospect person.	<p>Yes (Conditional)</p> <p>Note: This data is required while adding a characteristic for the prospect person.</p>
personCharType	Used to indicate the characteristic type.	Yes (Conditional)

Attribute Name	Attribute Description	Mandatory (Yes or No)
	Note: You must specify a characteristic type which is associated with the division to which the prospect person belongs.	Note: This data is required while adding a characteristic for the prospect person.

Note: At a time, you can add only one prospect person using the **C1-ADDPROSPERSON** business service. However, you can add multiple accounts for the prospect person using the **C1-ADDPROSPERSON** business service.

Once the prospect is created, all the details of prospect are listed in the above mentioned attributes along with the following attributes:

Attribute Name	Attribute Description
prospectPersonId	Displays the identification value generated for the prospect person.
prospectAccountId	Displays the identification value generated for the prospect account.

Related Topics

For more information on...	See...
Sample prospect creation request and response in the JSON format	Sample Prospect Creation Request and Response in the JSON Format on page 3762

Prospect Update Request and Response - Attribute/Value Pairs in the JSON Format

Note: We recommend you to refer the topics [Prospect Update Request in the JSON Format](#) on page 3739 and [Prospect Update Response in the JSON Format](#) on page 3740 in parallel while understanding the below mentioned attributes. This will help you to understand how the attribute/value pairs are nested in the JSON format.

Before calling the **C1-ADDPROSPERSON** business service through an inbound web service, you need to ensure that the prospect update request contains the following attributes:

Attribute Name	Attribute Description	Mandatory (Yes or No)
prospectPersonId	Used to specify the prospect person for whom you want to create the update request.	Yes
actionFlag	Used to indicate that you want to create request to update a prospect person. The valid value is: <ul style="list-style-type: none"> • UPD Note: If you do not specify the value in this attribute, the system considers it as an ADD action.	Yes
prospectPersonName	Used to specify the name of the prospect person. Note: You should specify a person name which is already present in the system.	Yes
division	Used to indicate the division to which you want to associate the prospect person.	Yes

Attribute Name	Attribute Description	Mandatory (Yes or No)
	Note: You must specify a division which is already defined in the system.	
customerSegment	Used to indicate the business component using which you want to update the prospect person. Note: You should specify only those values which are present in the CUST_SEG_FLG lookup field.	No
customerTier	Used to indicate the customer tier of the customer segment to which you want to associate the prospect person. Note: You should specify only those values which are present in the CUST_TIER_FLG lookup field.	No
accessGroup	Used to indicate the user groups who can view and edit the details of the prospect person. Note: You can specify only those access groups which are associated with the division to which the prospect belongs.	Yes
emailAddress	Used to specify the email address of the prospect person.	No
status	Used to indicate the status in which you want to create the prospect person. <ul style="list-style-type: none"> • ACTIVE • INACTIVE Note: The status of the prospect person can only be set to ACTIVE while adding a prospect person. If you do not specify the value in this attribute, the system, by default sets the status of the prospect person to ACTIVE .	Yes
birthDate	Used to specify the date of birth of the prospect person.	No
address1	Used to specify the first line of the address. It may contain details, such as the house number.	No
address2	Used to specify the second line of the address. It may contain details, such as the apartment name.	No
address3	Used to specify the third line of the address. It may contain details, such as the street name.	No

Attribute Name	Attribute Description	Mandatory (Yes or No)
address4	Used to specify the fourth line of the address. It may contain the landmark details.	No
city	Used to specify the city where the prospect is located.	No
state	Used to specify the state where the city is located.	No
country	Used to specify the country where the state is located.	No
postal	Used to specify the postal code of the address.	No
prosPerIdentifierList	Used to specify a list of person identifiers for the prospect person.	No
personIdNumber	Used to specify the value of the person identifier type.	Yes (Conditional)
	Note: If you specify the idType attribute, you need to specify the personIdNumber attribute.	Note: This data is required while specifying the prospect person identifier.
persIsPrimaryId	Used to indicate whether the prospect person identifier is primary or not. The valid values are: <ul style="list-style-type: none"> • True • False 	Yes (Conditional)
		Note: This data is required while specifying the prospect person identifier.
idType	Used to specify the identifier type using which you want to add the prospect person in the system.	Yes (Conditional)
	Note: If you specify the personIdNumber attribute, you need to specify the idType attribute.	Note: This data is required while specifying the prospect person identifier.
prosChildRelationList	Used to specify a list of child persons associated with the prospect person.	No
childPersonId	Used to specify the child person of the prospect person.	Yes (Conditional)
		Note: This data is required while specifying the child person of the prospect person.
personRelationshipType	Used to indicate how the child person is associated with the prospect person.	Yes (Conditional)
		Note: This data is required while specifying the child person of the prospect person.
childPerType	Used to indicate the type of the child person.	Yes (Conditional)

Attribute Name	Attribute Description	Mandatory (Yes or No)
		Note: This data is required while specifying the child person of the prospect person.
division	Used to indicate the division to which the child person belongs. Note: You must specify a division which is already defined in the system. The child person must belong to the division to which the prospect person is associated.	Yes (Conditional) Note: This data is required while specifying the child person of the prospect person.
childPersonIdType	Used to specify the identifier type using which the child person is created in the system. Note: If you specify the childPersonIdNumber attribute, you need to specify the childPersonIdType attribute.	Yes (Conditional) Note: This data is required while specifying the child person of the prospect person.
childPersonIdNumber	Used to specify the value of the identifier type using which the child person is created in the system. Note: If you specify the childPersonIdType attribute, you need to specify the childPersonIdNumber attribute.	Yes (Conditional) Note: This data is required while specifying the child person of the prospect person.
endDate	Used to specify the date till when the child person is associated with the prospect person.	No
startDate	Used to specify the date from when the child person is associated with the prospect person.	Yes (Conditional) Note: This data is required while specifying the child person of the prospect person.
prosParentPerRelationList	Used to specify a list of parent persons associated with the prospect person. Note: You can now add a prospect person or account to an existing person in the system. In other words, the system allows you to add a prospect person or account in an existing person's hierarchy. Also, you can create deals for such prospect person's or account's, if required.	No
parentPersonId	Used to specify the parent person of the prospect person.	Yes (Conditional)

Attribute Name	Attribute Description	Mandatory (Yes or No)
		<p>Note: This data is required while specifying the parent person relationship of the prospect person.</p>
personRelationshipType	Used to indicate how the prospect person is associated with the specified person.	<p>Yes (Conditional)</p> <p>Note: This data is required while specifying the parent person relationship of the prospect person.</p>
parentPerType	<p>Used to indicate the type of the parent person. The valid values are:</p> <ul style="list-style-type: none"> • EPER - Used to indicate that the parent person is an existing person in the system. • PRSP - Used to indicate that the parent person is a prospect in the system. 	<p>Yes (Conditional)</p> <p>Note: This data is required while specifying the parent person relationship of the prospect person.</p>
division	<p>Used to indicate the division to which the parent person belongs.</p> <p>Note: You must specify a division which is already defined in the system. The parent person must belong to the division to which the prospect person is associated.</p>	<p>Yes (Conditional)</p> <p>Note: This data is required while specifying the parent person relationship of the prospect person.</p>
parentPersonIdType	<p>Used to specify the identifier type using which the parent person is created in the system.</p> <p>Note: If you specify the parentPersonIdNumber attribute, you need to specify the parentPersonIdType attribute.</p>	<p>Yes (Conditional)</p> <p>Note: This data is required while specifying the parent person relationship of the prospect person.</p>
parentPersonIdNumber	<p>Used to specify the value of the identifier type using which the parent person is created in the system.</p> <p>Note: If you specify the parentPersonIdType attribute, you need to specify the parentPersonIdNumber attribute.</p>	<p>Yes (Conditional)</p> <p>Note: This data is required while specifying the parent person relationship of the prospect person.</p>
endDate	Used to specify the date till when the prospect person is associated with the parent person.	No
startDate	Used to specify the date from when the prospect person is associated with the parent person.	Yes (Conditional)

Attribute Name	Attribute Description	Mandatory (Yes or No)
		Note: This data is required while specifying the parent person relationship of the prospect person.
prosAccountList	Used to specify a list of accounts for the prospect person.	No
personId	Used to specify the person to which the account belongs.	Yes (Conditional) Note: This data is required while adding an account for the prospect person.
customerClass	Used to indicate the customer class to which the account is associated. Note: You must specify a customer class which is associated with the division to which the prospect account belongs.	Yes (Conditional) Note: This data is required while adding an account for the prospect person.
accountDivision	Used to indicate the division to which the account belongs. Note: If you do not specify the value in this attribute, the system considers the division of the person to whom the account is associated.	Yes (Conditional) Note: This data is required while adding an account for the prospect person.
status	Used to indicate the status of the account. The valid values are: <ul style="list-style-type: none"> • ACTIVE • INACTIVE Note: The status of the prospect account can only be set to ACTIVE while adding a prospect account. If you do not specify the value in this attribute, the system, by default sets the status of the prospect account to ACTIVE .	Yes (Conditional) Note: This data is required while adding an account for the prospect person.
setUpDate	Used to specify the date from when the account is available for the prospect person.	Yes (Conditional) Note: This data is required while adding an account for the prospect person.
currency	Used to indicate the currency code of the account.	Yes

Attribute Name	Attribute Description	Mandatory (Yes or No)
	<p>Note: You must specify a currency which is already defined in the system and which is associated with the division to which the prospect account belongs.</p>	
billCycle	Used to indicate the time interval in which you want to create the bills for the account.	<p>Yes (Conditional)</p> <p>Note: This data is required while adding an account for the prospect person.</p>
accountAccessGroup	<p>Used to indicate the user group who can view and edit the details of the account.</p> <p>Note: If you do not specify the value in this attribute, the system considers the access group of the person to whom the account belongs.</p>	<p>Yes (Conditional)</p> <p>Note: This data is required while adding an account for the prospect person.</p>
prosAcctCharacteristicList	Used to specify a list of characteristics for the prospect account.	No
characteristicValue	Used to specify the value for the characteristic type.	<p>Yes (Conditional)</p> <p>Note: This data is required while adding a characteristic for the prospect account.</p>
effectiveDate	Used to specify the date from when the characteristic is effective for the prospect account.	<p>Yes (Conditional)</p> <p>Note: This data is required while adding a characteristic for the prospect account.</p>
characteristicType	<p>Used to indicate the characteristic type.</p> <p>Note: You must specify a characteristic type which is associated with the division to which the prospect account belongs.</p>	<p>Yes (Conditional)</p> <p>Note: This data is required while adding a characteristic for the prospect account.</p>
prosAcctIdentifierList	Used to specify a list of identifiers for the prospect account.	No
accountIdentifierType	<p>Used to indicate the identifier type based on which you want to define the prospect account.</p> <p>Note: If you specify the accountNumber attribute, you need to specify the accountIdentifierType attribute. You must specify an identifier type which is associated with the division to which the prospect account belongs.</p>	<p>Yes (Conditional)</p> <p>Note: This data is required while associating an identifier with the prospect account.</p>

Attribute Name	Attribute Description	Mandatory (Yes or No)
isPrimaryId	Used to indicate whether the prospect account identifier is primary or not. The valid values are: <ul style="list-style-type: none"> • True • False 	Yes (Conditional)
	Note: If you do not specify the value in this attribute, the system considers the value as False .	Note: This data is required while associating an identifier with the prospect account.
accountNumber	Used to specify the prospect account to which you want to associate the identifier.	Yes (Conditional)
	Note: If you specify the accountIdentifierType attribute, you need to specify the accountNumber attribute.	Note: This data is required while associating an identifier with the prospect account.
prosPerCharacteristicList	Used to specify a list of characteristics for the prospect person.	No
personCharacteristicValue	Used to specify the value for the characteristic type.	Yes (Conditional)
		Note: This data is required while adding a characteristic for the prospect person.
personEffectiveDate	Used to specify the date from when the characteristic is effective for the prospect person.	Yes (Conditional)
		Note: This data is required while adding a characteristic for the prospect person.
personCharType	Used to indicate the characteristic type.	Yes (Conditional)
	Note: You must specify a characteristic type which is associated with the division to which the prospect person belongs.	Note: This data is required while adding a characteristic for the prospect person.

Note:

At a time, you can edit only one prospect person through the web service.

While updating the prospect person, the system replaces the prospect person data instead of editing it. Therefore, you should provide all the details of prospect person including the data that you want to change.

Once the prospect is updated, all the details of prospect are listed in the above mentioned attributes.

Related Topics

For more information on...	See...
Sample prospect update request and response in the JSON format	Sample Prospect Update Request and Response in the JSON Format on page 3765

Prospect View Request and Response - Attribute/Value Pairs in the JSON Format

Note: We recommend you to refer the topics [Prospect View Request in the JSON Format](#) on page 3742 and [Prospect View Response in the JSON Format](#) on page 3742 in parallel while understanding the below mentioned attributes. This will help you to understand how the attribute/value pairs are structured in the JSON format.

Before calling the **C1-ADDPROSPERSON** business service through an inbound web service, you need to ensure that the prospect view request contains the following attributes:

Attribute Name	Attribute Description	Mandatory (Yes or No)
prospectPersonId	Used to specify the prospect for which you want to create the view request.	Yes (Conditional)
	Note: If you do not specify the value in the prospectPersonId attribute, you have to specify the personIdNumber and idType attributes.	Note: This data is required for creating view request for a particular prospect.
actionFlag	Used to indicate that you want to create request to view a prospect. The valid value is: <ul style="list-style-type: none"> • READ 	Yes
	Note: If you do not specify the value in this attribute, the system considers it as an ADD action.	
personIdNumber	Used to specify the value of the person identifier type using which you want to create the view request for a prospect.	Yes (Conditional)
	Note: If you specify the idType attribute, you need to specify the personIdNumber attribute.	Note: This data is required for creating view request for a prospect using its person identifier details.
idType	Used to specify the identifier type using which you want to create the view request for a prospect.	Yes (Conditional)
	Note: If you specify the personIdNumber attribute, you need to specify the idType attribute. The data in this attribute is required if you do not specify the value in the prospectPersonId attribute. You should specify an identifier type which is associated with the division to which the prospect belongs.	Note: This data is required for creating view request for a prospect using its person identifier details.
division	Used to specify the division of the identifier type using which you want to create the view request for a prospect.	Yes (Conditional)

Attribute Name	Attribute Description	Mandatory (Yes or No)
	<p>Note:</p> <p>If you specify the personIdNumber and idType attributes, you need to specify the division attribute.</p> <p>You must specify a division which is already defined in the system.</p>	<p>Note: This data is required for creating view request for a prospect using its person identifier details.</p>

Once the view request is created for the prospect, all the details of prospect are listed in the above mentioned attributes along with the following attributes:

Attribute Name	Attribute Description
prospectPersonName	Displays the name of the prospect person.
division	Display the division to which the prospect person belongs.
customerSegment	Indicates the business component using which the prospect person is created in the system.
customerTier	Indicates the customer tier of the customer segment to which the prospect person is associated.
accessGroup	Indicates the user groups who can view and edit the details of the prospect person.
emailAddress	Displays the email address of the prospect person.
status	Indicates the current status of the prospect. The valid values are: <ul style="list-style-type: none"> ACTIVE INACTIVE
birthDate	Displays the date of birth of the prospect person.
address1	Displays the first line of the address. It may contain details, such as the house number.
address2	Displays the second line of the address. It may contain details, such as the apartment name.
address3	Displays the third line of the address. It may contain details, such as the street name.
address4	Displays the fourth line of the address. It may contain the landmark details.
city	Displays the city where the prospect person is located.
state	Displays the state where the city is located.
country	Displays the country where the state is located.
postal	Displays the postal code of the address.
prosPerIdentifierList	Displays a list of person identifiers for the prospect.
personIdNumber	Displays the value of the person identifier type.
persIsPrimaryId	Indicates whether the prospect person identifier is primary or not. The valid values are: <ul style="list-style-type: none"> True False

Attribute Name	Attribute Description
idType	Displays the identifier type using which the prospect person is created in the system.
prosChildRelationList	Displays the list of child persons associated with the prospect person.
childPersonId	Displays the child person of the prospect person.
personRelationshipType	Indicates how the child person is associated with the prospect person.
childPerType	Indicates the type of the child person.
division	Indicates the division to which the child person belongs.
childPersonIdType	Indicates the identifier type using which the child person is created in the system.
childPersonIdNumber	Displays the value of the identifier type using which the child person is created in the system.
endDate	Displays the date till when the child person is associated with the prospect person.
startDate	Displays the date from when the child person is associated with the prospect person.
prosParentPerRelationList	Displays the list of parent persons associated with the prospect person.
parentPersonId	Displays the parent person of the prospect person.
personRelationshipType	Indicates how the parent person is associated with the prospect person.
parentPerType	Indicates the type of the parent person.
division	Indicates the division to which the parent person belongs.
parentPersonIdType	Indicates the identifier type using which the parent person is created in the system.
parentPersonIdNumber	Displays the value of the identifier type using which the parent person is created in the system.
endDate	Displays the date till when the prospect person is associated with the parent person.
startDate	Displays the date from when the prospect person is associated with the parent person.
prosAccountList	Displays the list of accounts for the prospect person.
personId	Displays the prospect person identification value.
prospectAccountId	Displays the account identification value that is generated for the prospect person.
customerClass	Indicates the customer class to which the account is associated.
accountDivision	Indicate the division to which the account belongs.
status	Indicates the status of the account. The valid values are: <ul style="list-style-type: none"> • ACTIVE • INACTIVE
setUpDate	Displays the date from when the account is available for the prospect person.
currency	Indicates the currency code of the account.
billCycle	Indicates the time interval in which the bills are created for the account.
accountAccessGroup	Indicates the user group who can view and edit the details of the account.
prosAcctCharacteristicList	Displays the list of characteristics for the prospect account.
characteristicValue	Displays the value of the characteristic type.

Attribute Name	Attribute Description
effectiveDate	Displays the date from when the characteristic is effective for the account.
characteristicType	Indicates the characteristic type.
prosAcctIdentifierList	Displays the list of identifiers for the prospect account.
accountIdentifierType	Indicates the identifier type based on which the account is defined.
isPrimaryId	Indicates whether the prospect account identifier is primary or not. The valid values are: <ul style="list-style-type: none"> • True • False
accountNumber	Displays the account to which the identifier is associated.
prosPerCharacteristicList	Displays the list of characteristics defined for the prospect person.
personcharacteristicValue	Displays the value of the characteristic type.
personEffectiveDate	Displays the date from when the characteristic is effective for the prospect person.
personCharType	Indicates the characteristic type.

Related Topics

For more information on...	See...
Sample prospect view request and response in the JSON format	Sample Prospect View Request and Response in the JSON Format on page 3769

Sample Prospect Creation Request and Response in the JSON Format

Using the below example, you can create the Smith prospect person in 930 division.

Sample Prospect Creation Request in the JSON Format

```
{
  "C1-ADDPROSPERSON"
  {
    "actionFlag" : "ADD",
    "prospectPersonName" : "Smith",
    "division" : "930",
    "customerSegment" : "COMM",
    "customerTier" : "T",
    "accessGroup" : "***",
    "emailAddress" : "smith@example.com",
    "status" : "ACTIVE",
    "birthDate" : "2000-01-01",
    "address1" : "401",
    "address2" : "Island Parkway",
    "address3" : "Redwood Shores",
    "address4" : "Redwood Shores",
    "city" : "CA",
    "state" : "NEW YORK",
    "country" : "USA",
    "postal" : "94065",
    "prosPerIdentifierList"
    {
      "personIdNumber" : "Smith",
      "persIsPrimaryId" : "true",
      "idType" : "COREG",
    }
  }
}
```

```

    }
    "prosChildRelationList"
    {
      "childPersonId" : "3784437346",
      "personRelationshipType" : "CHILD",
      "childPerType" : "PRSP",
      "division" : "930",
      "childPersonIdType" : "Social Security number",
      "childPersonIdNumber" : "3167070400",
      "endDate" : "2025-01-01",
      "startDate" : "2019-01-01",
    }
    "prosParentPerRelationList"
    {
      "parentPersonId" : "1600395396",
      "personRelationshipType" : "CHILD",
      "parentPerType" : "EPER",
      "division" : "930",
      "parentPersonIdType" : "Social Security number",
      "parentPersonIdNumber" : "4598409119",
      "endDate" : "2025-01-01",
      "startDate" : "2019-01-01",
    }
    "prosAccountList"
    {
      "personId" : "6709873933",
      "customerClass" : "BKCORPV1",
      "accountDivision" : "930",
      "status" : "ACTIVE",
      "setUpDate" : "2021-01-01",
      "currency" : "USD",
      "billCycle" : "BKEM",
      "accountAccessGroup" : "****",
      "prosAcctCharacteristicList"
      {
        {
          "characteristicValue" : "PROS",
          "effectiveDate" : "2025-01-01",
          "characteristicType" : "C1_F_ANO",
        }
      }
      "prosAcctIdentifierList"
      {
        {
          "accountIdentifierType" : "ACCT_NM",
          "isPrimaryId" : "true",
          "accountNumber" : "PROS",
        }
      }
    }
    "prosPerCharacteristicList"
    {
      {
        "personcharacteristicValue" : "ORG",
        "personEffectiveDate" : "2025-01-01",
        "personCharType" : "ORGORFI",
      }
    }
  }
}

```

Note: If you do not want to enter the data in the list attributes (i.e. attributes where the type is set to list), you should not include them in the request. Adding empty list attributes will give erroneous results.

Sample Prospect Creation Response in the JSON Format

```

{
  "C1-ADDPROSPERSON"
  {

```

```

"prospectPersonId" : "7253834552",
"actionFlag" : "ADD",
"prospectPersonName" : "Smith",
"division" : "930",
"customerSegment" : "COMM",
"customerTier" : "T",
"accessGroup" : "****",
"emailAddress" : "smith@example.com",
"status" : "ACTIVE",
"birthDate" : "2000-01-01",
"address1" : "401",
"address2" : "Island Parkway",
"address3" : "Redwood Shores",
"address4" : "Redwood Shores",
"city" : "CA",
"state" : "NEW YORK",
"country" : "USA",
"postal" : "94065",
"prosPerIdentifierList"
{
  "personIdNumber" : "Smith",
  "persIsPrimaryId" : "true",
  "idType" : "COREG",
}
"prosChildRelationList"
{
  "childPersonId" : "3784437346",
  "personRelationshipType" : "CHILD",
  "childPerType" : "PRSP",
  "division" : "930",
  "childPersonIdType" : "Social Security number",
  "childPersonIdNumber" : "3167070400",
  "endDate" : "2025-01-01",
  "startDate" : "2018-01-01",
}
"prosParentPerRelationList"
{
  "parentPersonId" : "1600395396",
  "personRelationshipType" : "CHILD",
  "parentPerType" : "EPER",
  "division" : "",
  "parentPersonIdType" : "Social Security number",
  "parentPersonIdNumber" : "4598409119",
  "endDate" : "2025-01-01",
  "startDate" : "2019-01-01",
}
"prosAccountList"
{
  "personId" : "6709873933",
  "prospectAccountId" : "7649992977",
  "customerClass" : "BKCORPV1",
  "accountDivision" : "930",
  "status" : "ACTIVE",
  "setUpDate" : "2021-01-01",
  "currency" : "USD",
  "billCycle" : "BKEM",
  "accountAccessGroup" : "****",
  "prosAcctCharacteristicList"
  {
    "characteristicValue" : "PROS",
    "effectiveDate" : "2025-01-01",
    "characteristicType" : "Cl_F_ANO",
  }
  "prosAcctIdentifierList"

```



```

    {
      "accountIdentifierType" : "ACCT_NM",
      "isPrimaryId" : "true",
      "accountNumber" : "PROS",
    }
  }
  "prosPerCharacteristicList"
  {
    "personCharacteristicValue" : "ORG",
    "personEffectiveDate" : "2025-01-01",
    "personCharType" : "ORGORFI",
  }
}

```

Note: We have given the above request and response samples to illustrate how the attribute value pairs should be structured while sending a prospect creation request from the external system. However, you should not seamlessly use this request sample in your environment because the required pre-requisite data may not be available in your environment. In such case, the system will give erroneous results.

Related Topics

For more information on...	See...
Prospect add request and response attribute/value pairs in the JSON format	Prospect Add Request and Response - Attribute/Value Pairs in the JSON Format on page 3744

Sample Prospect Update Request and Response in the JSON Format

Using the below example, you can update the prospect person for 3009626623 prospect person ID.

Sample Prospect Update Request in the JSON Format

```

{
  "C1-ADDPROSPERSON"
  {
    "prospectPersonId" : "3009626623",
    "actionFlag" : "UPD",
    "prospectPersonName" : "Smith",
    "division" : "930",
    "customerSegment" : "CORP",
    "customerTier" : "T",
    "accessGroup" : "BKUSER",
    "emailAddress" : "smith@example.com",
    "status" : "Active",
    "birthDate" : "2020-01-01",
    "address1" : "401",
    "address2" : "Island Parkway",
    "address3" : "Redwood Shores",
    "address4" : "Redwood Shores",
    "city" : "CA",
    "state" : "New York",
    "country" : "USA",
    "postal" : "94065",
    "prosPerIdentifierList"
    {
      "personIdNumber" : "456",
      "persIsPrimaryId" : "true",
      "idType" : "TAXID",
    }
    "prosChildRelationList"
    {
      "childPersonId" : "0146105591",
    }
  }
}

```

```

    "personRelationshipType" : "PARENT",
    "childPerType" : "PRSP",
    "division" : "930",
    "childPersonIdType" : "Social Security number",
    "childPersonIdNumber" : "3167070400",
    "endDate" : "2025-01-01",
    "startDate" : "2024-01-01",
  }
  "prosParentPerRelationList"
  {
    "parentPersonId" : "1600395396",
    "personRelationshipType" : "CHILD",
    "parentPerType" : "EPER",
    "division" : "930",
    "parentPersonIdType" : "Social Security number",
    "parentPersonIdNumber" : "4598409119",
    "endDate" : "2025-01-01",
    "startDate" : "2024-01-01",
  }
  "prosAccountList"
  {
    "personId" : "6709873933",
    "customerClass" : "BK",
    "accountDivision" : "930",
    "status" : "ACTIVE",
    "setUpDate" : "2024-01-01",
    "currency" : "USD",
    "billCycle" : "ASH3",
    "accountAccessGroup" : "BKUSER",
    "prosAcctCharacteristicList"
    {
      "characteristicValue" : "PROS",
      "effectiveDate" : "2024-01-01",
      "characteristicType" : "C1_F_ANO",
    }
    "prosAcctIdentifierList"
    {
      "accountIdentifierType" : "ACCT_NM",
      "isPrimaryId" : "true",
      "accountNumber" : "PROS",
    }
  }
  "prosPerCharacteristicList"
  {
    "personcharacteristicValue" : "I",
    "personEffectiveDate" : "2025-01-01",
    "personCharType" : "C1CUSTAT",
  }
}

```

Note: If you do not want to enter the data in the list attributes (i.e. attributes where the type is set to list), you should not include them in the request. Adding empty list attributes will give erroneous results.

Sample Prospect Update Response in the JSON Format

```

{
  "C1-ADDPROSPERSON"
  {
    "prospectPersonId" : "8982132112",
    "actionFlag" : "UPD",
    "prospectPersonName" : "Smith",
    "division" : "930",
    "customerSegment" : "COMM",
  }
}

```

```

"customerTier" : "T",
"accessGroup" : "BKUSER",
"emailAddress" : "smith@example.com",
"status" : "ACTIVE",
"birthDate" : "2000-01-01",
"address1" : "401",
"address2" : "Island Parkway",
"address3" : "Redwood Shores",
"address4" : "Redwood Shores",
"city" : "CA",
"state" : "New York",
"country" : "USA",
"postal" : "94065",
"prosPerIdentifierList"
{
  "personIdNumber" : "456",
  "persIsPrimaryId" : "false",
  "idType" : "PIN",
}
{
  "personIdNumber" : "456",
  "persIsPrimaryId" : "true",
  "idType" : "TAXID",
}
"prosChildRelationList"
{
  "childPersonId" : "0146105591",
  "personRelationshipType" : "PARENT",
  "childPerType" : "PRSP",
  "division" : "930",
  "childPersonIdType" : "Social Security number",
  "childPersonIdNumber" : "3167070400",
  "endDate" : "2025-01-01",
  "startDate" : "2024-01-01",
}
"prosParentPerRelationList"
{
  "parentPersonId" : "1600395396",
  "personRelationshipType" : "CHILD",
  "parentPerType" : "EPER",
  "division" : "930",
  "parentPersonIdType" : "Social Security number",
  "parentPersonIdNumber" : "4598409119",
  "endDate" : "2025-01-01",
  "startDate" : "2024-01-01",
}
"prosAccountList"
{
  "personId" : "6709873933",
  "prospectAccountId" : "0017549904",
  "customerClass" : "BK",
  "accountDivision" : "930",
  "status" : "ACTIVE",
  "setUpDate" : "2024-01-01",
  "currency" : "USD",
  "billCycle" : "ASH3",
  "accountAccessGroup" : "BKUSER",
  "prosAcctCharacteristicList"
  {
    "characteristicValue" : "PROS",
    "effectiveDate" : "2024-01-01",
    "characteristicType" : "Cl_F_ANO",
  }
  "prosAcctIdentifierList"

```

```

    {
      "accountIdentifierType" : "CCT_NM",
      "isPrimaryId" : "true",
      "accountNumber" : "PROS",
    }
  }
  "prosAccountList"
  {
    "personId" : "6709873933",
    "prospectAccountId" : "0261587703",
    "customerClass" : "BK",
    "accountDivision" : "930",
    "status" : "ACTIVE",
    "setUpDate" : "2024-01-01",
    "currency" : "USD",
    "billCycle" : "ASH3",
    "accountAccessGroup" : "BKUSER",
    "prosAcctCharacteristicList"
    {
      "characteristicValue" : "PROS",
      "effectiveDate" : "2024-01-01",
      "characteristicType" : "Cl_F_ANO",
    }
    "prosAcctIdentifierList"
    {
      "accountIdentifierType" : "CCT_NM",
      "isPrimaryId" : "true",
      "accountNumber" : "PROS",
    }
  }
  "prosAccountList"
  {
    "personId" : "6081480244",
    "prospectAccountId" : "0261587703",
    "customerClass" : "BK",
    "accountDivision" : "930",
    "status" : "ACTIVE",
    "setUpDate" : "2024-01-01",
    "currency" : "USD",
    "billCycle" : "ASH3",
    "accountAccessGroup" : "BKUSER",
    "prosAcctCharacteristicList"
    {
      "characteristicValue" : "PROS",
      "effectiveDate" : "2024-01-01",
      "characteristicType" : "Cl_F_ANO",
    }
    "prosAcctIdentifierList"
    {
      "accountIdentifierType" : "CCT_NM",
      "isPrimaryId" : "true",
      "accountNumber" : "PROS",
    }
  }
  "prosAccountList"
  {
    "personId" : "3055256440",
    "prospectAccountId" : "0261587703",
    "customerClass" : "BK",
    "accountDivision" : "930",
    "status" : "ACTIVE",
    "setUpDate" : "2024-01-01",
    "currency" : "USD",
    "billCycle" : "ASH3",
  }

```

```

"accountAccessGroup" : "BKUSER",
"prosAcctCharacteristicList"
{
  "characteristicValue" : "PROS",
  "effectiveDate" : "2024-01-01",
  "characteristicType" : "C1_F_ANO",
}
"prosAcctIdentifierList"
{
  "accountIdentifierType" : "CCT_NM",
  "isPrimaryId" : "true",
  "accountNumber" : "PROS",
}
}
"prosAccountList"
{
  "personId" : "3749439310",
  "prospectAccountId" : "0261587703",
  "customerClass" : "BK",
  "accountDivision" : "930",
  "status" : "ACTIVE",
  "setUpDate" : "2024-01-01",
  "currency" : "USD",
  "billCycle" : "ASH3",
  "accountAccessGroup" : "BKUSER",
  "prosAcctCharacteristicList"
  {
    "characteristicValue" : "PROS",
    "effectiveDate" : "2024-01-01",
    "characteristicType" : "C2CNTSER",
  }
  "prosAcctIdentifierList"
  {
    "accountIdentifierType" : "CCT_NM",
    "isPrimaryId" : "true",
    "accountNumber" : "PROS",
  }
}
"prosPerCharacteristicList"
{
  "personcharacteristicValue" : "A",
  "personEffectiveDate" : "2011-01-01",
  "personCharType" : "C1CUSTAT",
}
}
}

```

Note: We have given the above request and response samples to illustrate how the attribute value pairs should be structured while sending a prospect update request from the external system. However, you should not seamlessly use this request sample in your environment because the required pre-requisite data may not be available in your environment. In such case, the system will give erroneous results.

Related Topics

For more information on...	See...
Prospect update request and response attribute/value pairs in the JSON format	Prospect Update Request and Response - Attribute/Value Pairs in the JSON Format on page 3751

Sample Prospect View Request and Response in the JSON Format

Using the below example, you can view the prospect person of 8982132112 prospect person ID.

Sample Prospect View Request in the JSON Format

```
{
  "C1-ADDPROSPERSON"
  {
    "prospectPersonId" : "8982132112",
    "actionFlag" : "READ",
  }
}
```

Sample Prospect View Response in the JSON Format

```
{
  "C1-ADDPROSPERSON"
  {
    "prospectPersonId" : "8982132112",
    "actionFlag" : "READ",
    "prospectPersonName" : "Smith",
    "division" : "930",
    "customerSegment" : "COMM",
    "customerTier" : "T",
    "accessGroup" : "BKUSER",
    "emailAddress" : "smith@example.com",
    "status" : "ACTIVE",
    "birthDate" : "2022-01-01",
    "address1" : "401",
    "address2" : "Island Parkway",
    "address3" : "Redwood Shores",
    "address4" : "Redwood Shores",
    "city" : "CA",
    "state" : "New York",
    "country" : "USA",
    "postal" : "94065",
    "prosPerIdentifierList"
    {
      "personIdNumber" : "123",
      "persIsPrimaryId" : "false",
      "idType" : "PIN",
    }
    "prosPerIdentifierList"
    {
      "personIdNumber" : "456",
      "persIsPrimaryId" : "true",
      "idType" : "SSN",
    }
    "prosChildRelationList"
    {
      "childPersonId" : "9773712881",
      "personRelationshipType" : "CHILD",
      "childPerType" : "PRSP",
      "division" : "930",
      "childPersonIdType" : "Social Security number",
      "childPersonIdNumber" : "3167070400",
      "endDate" : "2025-01-01",
      "startDate" : "2024-01-01",
    }
    "prosParentPerRelationList"
    {
      "parentPersonId" : "1600395396",
      "personRelationshipType" : "CHILD",
      "parentPerType" : "EPER",
      "division" : "930",
      "parentPersonIdType" : "Social Security number",
      "parentPersonIdNumber" : "4598409119",
    }
  }
}
```

```

        "endDate" : "2025-01-01",
        "startDate" : "2024-01-01",
    }
    "prosAccountList"
    {
        "personId" : "6709873933",
        "prospectAccountId" : "0017549904",
        "customerClass" : "BK",
        "accountDivision" : "930",
        "status" : "ACTIVE",
        "setUpDate" : "2024-01-01",
        "currency" : "USD",
        "billCycle" : "ASH3",
        "accountAccessGroup" : "BKUSER",
        "prosAcctCharacteristicList"
        {
            "characteristicValue" : "PROS",
            "effectiveDate" : "2024-01-01",
            "characteristicType" : "Cl_F_ANO",
        }
        "prosAcctIdentifierList"
        {
            "accountIdentifierType" : "CCT_NM",
            "isPrimaryId" : "PROS",
            "accountNumber" : "PROS",
        }
    }
    "prosAccountList"
    {
        "personId" : "6709873933",
        "prospectAccountId" : "0261587703",
        "customerClass" : "BK",
        "accountDivision" : "930",
        "status" : "ACTIVE",
        "setUpDate" : "2024-01-01",
        "currency" : "USD",
        "billCycle" : "ASH3",
        "accountAccessGroup" : "BKUSER",
        "prosAcctCharacteristicList"
        {
            "characteristicValue" : "PROS",
            "effectiveDate" : "2024-01-01",
            "characteristicType" : "Cl_F_ANO",
        }
        "prosAcctIdentifierList"
        {
            "accountIdentifierType" : "CCT_NM",
            "isPrimaryId" : "true",
            "accountNumber" : "PROS",
        }
    }
    "prosAccountList"
    {
        "personId" : "6081480244",
        "prospectAccountId" : "4409313506",
        "customerClass" : "BK",
        "accountDivision" : "930",
        "status" : "ACTIVE",
        "setUpDate" : "2024-01-01",
        "currency" : "USD",
        "billCycle" : "ASH3",
        "accountAccessGroup" : "BKUSER",
        "prosAcctCharacteristicList"
        {

```

```

        "characteristicValue" : "PROS",
        "effectiveDate" : "2024-01-01",
        "characteristicType" : "C1_F_ANO",
    }
    "prosAcctIdentifierList"
    {
        "accountIdentifierType" : "CCT_NM",
        "isPrimaryId" : "true",
        "accountNumber" : "PROS",
    }
}
"prosAccountList"
{
    "personId" : "3055256440",
    "prospectAccountId" : "7285093705",
    "customerClass" : "BK",
    "accountDivision" : "930",
    "status" : "ACTIVE",
    "setUpDate" : "2024-01-01",
    "currency" : "USD",
    "billCycle" : "ASH3",
    "accountAccessGroup" : "BKUSER",
    "prosAcctCharacteristicList"
    {
        "characteristicValue" : "008",
        "effectiveDate" : "2024-01-01",
        "characteristicType" : "C2CNTSER",
    }
    "prosAcctIdentifierList"
    {
        "accountIdentifierType" : "C1_F_ANO",
        "isPrimaryId" : "true",
        "accountNumber" : "4567",
    }
}
"prosPerCharacteristicList"
{
    "personCharacteristicValue" : "A",
    "personEffectiveDate" : "2011-01-01",
    "personCharType" : "C1CUSTAT",
}
}
}

```

Note: We have given the above request and response samples to illustrate how the attribute value pairs should be structured while sending a prospect view request from the external system. However, you should not seamlessly use this request sample in your environment because the required pre-requisite data may not be available in your environment. In such case, the system will give erroneous results.

Related Topics

For more information on...	See...
Prospect view request and response attribute/value pairs in the JSON format	Prospect View Request and Response - Attribute/Value Pairs in the JSON Format on page 3758

Prospect Account Creation, Modification, and View through Inbound Web Service

Oracle Revenue Management and Billing enables you to create and edit a prospect account of an existing person or a prospect person through a web service. It also enables you to view the details of a prospect account through a web service. You can send the prospect account creation, modification, or view request from the external system through an inbound web service. We have shipped the following two inbound web services in this release:

- **C1-ProspectAccount** – This is a SOAP based web service. You can use this web service when you want to send the prospect account creation, modification, or view request in the XML format.
- **C1-ProspectAccountREST** – This is a REST based web service. You can use this web service when you want to send the prospect account creation, modification, or view request in the XML or JSON format.

Both these inbound web services call the **C1_PRSACCT_SERVICE** business service. This business service is used to do the following:

- **Create or edit a prospect account** – While creating a prospect account, you can specify the following details:
 - Entity (i.e. existing person or prospect person) for whom you want to create the prospect account
 - Division, setup date, invoice currency, bill cycle, and access group of the prospect account
 - Characteristics of the prospect account
 - Identifiers of the prospect account

Note: The division and access group of the prospect account and the existing or prospect person should be same.

While associating the existing or prospect person with the prospect account, the system by default sets the **Main Customer** flag to **true**, the **Financially Responsible** flag to **true**, the **Relationship Type** flag to **Main Customer**, and the **Address Source** flag to **PER**.

To add a prospect account for an existing or prospect person through the web service, you must set the action flag to **ADD**. However, to edit a prospect account of an existing or prospect person through the web service, you must set the action flag to **UPD**. While editing a prospect account, you need to specify the following details to identify the prospect account whose details you want to change:

- Entity (i.e. existing person or prospect person) whose prospect account you want edit
- Prospect Account ID

During the update operation, the system replaces the prospect account data instead of editing it. At a time, you can create or edit one prospect account of an existing or prospect person through the web service. While adding a prospect account, the status of the prospect account can only be set to **ACTIVE**. If you do not specify the status while adding a prospect account, the system, by default sets the status of the prospect account to **ACTIVE**. While updating a prospect account, you can change the status of the prospect account from **ACTIVE** to **INACTIVE**. You can activate an inactive prospect account of an existing or prospect person whenever required. While activating an inactive prospect account of a prospect person, the system checks whether the status of the prospect person is **ACTIVE**. If so, the system enables you to activate an inactive prospect account of the prospect person.

- **View the details of a prospect account** – While viewing the details of a prospect account, you need to:
 - Specify the prospect account ID to determine the prospect account whose details you want to view
 - Set the action flag to **READ**

On processing the request, the system displays all details of the prospect account including its identifiers and characteristics in the response.

Prospect Account Add Request in the XML Format

The following code snippet illustrates how the tags should be nested while receiving the prospect account add request in the XML format:

```
<C1_PRSACCT_SERVICE>
  <mainEntityId></mainEntityId>
  <mainEntityType></mainEntityType>
```

```

<actionFlag></actionFlag>
<status></status>
<customerClass></customerClass>
<accountDivision></accountDivision>
<setUpDate></setUpDate>
<currency></currency>
<billCycle></billCycle>
<accountAccessGroup></accountAccessGroup>
<prosAcctCharacteristicList>
  <characteristicValue></characteristicValue>
  <effectiveDate></effectiveDate>
  <characteristicType></characteristicType>
</prosAcctCharacteristicList>
<prosAcctIdentifierList>
  <accountIdentifierType></accountIdentifierType>
  <isPrimaryId></isPrimaryId>
  <accountNumber></accountNumber>
</prosAcctIdentifierList>
</C1_PRACCT_SERVICE>

```

Related Topics

For more information on...	See...
Prospect account add request and response tags in the XML format	Prospect Account Add Request and Response - Tags in the XML Format on page 3777
Sample prospect account add request and response in the XML format	Sample Prospect Account Creation Request and Response in the XML Format on page 3785

Prospect Account Add Response in the XML Format

The following code snippet illustrates how the tags should be nested while sending the prospect account add response in the XML format:

```

<C1_PRACCT_SERVICE>
  <mainEntityId></mainEntityId>
  <mainEntityType></mainEntityType>
  <actionFlag></actionFlag>
  <prospectAccountId></prospectAccountId>
  <status></status>
  <customerClass></customerClass>
  <accountDivision></accountDivision>
  <setUpDate></setUpDate>
  <currency></currency>
  <billCycle></billCycle>
  <accountAccessGroup></accountAccessGroup>
  <prosAcctCharacteristicList>
    <characteristicValue></characteristicValue>
    <effectiveDate></effectiveDate>
    <characteristicType></characteristicType>
  </prosAcctCharacteristicList>
  <prosAcctIdentifierList>
    <accountIdentifierType></accountIdentifierType>
    <isPrimaryId></isPrimaryId>
    <accountNumber></accountNumber>
  </prosAcctIdentifierList>
</C1_PRACCT_SERVICE>

```

Related Topics

For more information on...	See...
Prospect account add request and response tags in the XML format	Prospect Account Add Request and Response - Tags in the XML Format on page 3777
Sample prospect account add request and response in the XML format	Sample Prospect Account Creation Request and Response in the XML Format on page 3785

Prospect Account Update Request in the XML Format

The following code snippet illustrates how the tags should be nested while receiving the prospect account update request in the XML format:

```
<C1_PRISACCT_SERVICE>
  <mainEntityId></mainEntityId>
  <mainEntityType></mainEntityType>
  <actionFlag></actionFlag>
  <prospectAccountId></prospectAccountId>
  <status></status>
  <customerClass></customerClass>
  <accountDivision></accountDivision>
  <setUpDate></setUpDate>
  <currency></currency>
  <billCycle></billCycle>
  <accountAccessGroup></accountAccessGroup>
  <prosAcctCharacteristicList>
    <characteristicValue></characteristicValue>
    <effectiveDate></effectiveDate>
    <characteristicType></characteristicType>
  </prosAcctCharacteristicList>
  <prosAcctIdentifierList>
    <accountIdentifierType></accountIdentifierType>
    <isPrimaryId></isPrimaryId>
    <accountNumber></accountNumber>
  </prosAcctIdentifierList>
</C1_PRISACCT_SERVICE>
```

Related Topics

For more information on...	See...
Prospect account update request and response tags in the XML format	Prospect Account Update Request and Response - Tags in the XML Format on page 3780
Sample prospect account update request and response in the XML format	Sample Prospect Account Update Request and Response in the XML Format on page 3786

Prospect Account Update Response in the XML Format

The following code snippet illustrates how the tags should be nested while sending the prospect account update response in the XML format:

```
<C1_PRISACCT_SERVICE>
  <mainEntityId></mainEntityId>
  <mainEntityType></mainEntityType>
  <actionFlag></actionFlag>
  <prospectAccountId></prospectAccountId>
  <status></status>
  <customerClass></customerClass>
  <accountDivision></accountDivision>
  <setUpDate></setUpDate>
  <currency></currency>
```

```

<billCycle></billCycle>
<accountAccessGroup></accountAccessGroup>
<prosAcctCharacteristicList>
  <characteristicValue></characteristicValue>
  <effectiveDate></effectiveDate>
  <characteristicType></characteristicType>
</prosAcctCharacteristicList>
<prosAcctIdentifierList>
  <accountIdentifierType></accountIdentifierType>
  <isPrimaryId></isPrimaryId>
  <accountNumber></accountNumber>
</prosAcctIdentifierList>
</C1_PRSACCT_SERVICE>

```

Related Topics

For more information on...	See...
Prospect account update request and response tags in the XML format	Prospect Account Update Request and Response - Tags in the XML Format on page 3780
Sample prospect account update request and response in the XML format	Sample Prospect Account Update Request and Response in the XML Format on page 3786

Prospect Account View Request in the XML Format

The following code snippet illustrates how the tags should be nested while receiving the prospect account view request in the XML format:

```

<C1_PRSACCT_SERVICE>
  <actionFlag></actionFlag>
  <prospectAccountId></prospectAccountId>
</C1_PRSACCT_SERVICE>

```

Related Topics

For more information on...	See...
Prospect account view request and response tags in the XML format	Prospect Account View Request and Response - Tags in the XML Format on page 3783
Sample prospect account view request and response in the XML format	Sample Prospect Account View Request and Response in the XML Format on page 3787

Prospect Account View Response in the XML Format

The following code snippet illustrates how the tags should be nested while sending the prospect account view response in the XML format:

```

<C1_PRSACCT_SERVICE>
  <mainEntityId></mainEntityId>
  <mainEntityType></mainEntityType>
  <actionFlag></actionFlag>
  <prospectAccountId></prospectAccountId>
  <status></status>
  <customerClass></customerClass>
  <accountDivision></accountDivision>
  <setUpDate></setUpDate>
  <currency></currency>
  <billCycle></billCycle>
  <accountAccessGroup></accountAccessGroup>
  <prosAcctCharacteristicList>
    <characteristicValue></characteristicValue>

```

```

    <effectiveDate></effectiveDate>
    <characteristicType></characteristicType>
  </prosAcctCharacteristicList>
  <prosAcctIdentifierList>
    <accountIdentifierType></accountIdentifierType>
    <isPrimaryId></isPrimaryId>
    <accountNumber></accountNumber>
  </prosAcctIdentifierList>
</C1_PRSACCT_SERVICE>

```

Related Topics

For more information on...	See...
Prospect account view request and response tags in the XML format	Prospect Account View Request and Response - Tags in the XML Format on page 3783
Sample prospect account view request and response in the XML format	Sample Prospect Account View Request and Response in the XML Format on page 3787

Prospect Account Add Request and Response - Tags in the XML Format

Note: We recommend you to refer the topics [Prospect Account Add Request in the XML Format](#) on page 3773 and [Prospect Account Add Response in the XML Format](#) on page 3774 in parallel while understanding the below mentioned tags. This will help you to understand how the tags are nested in the XML format.

Before calling the **C1_PRSACCT_SERVICE** business service through an inbound web service, you need to ensure that the prospect account add request contains the following tags:

Tag Name	Tag Description	Mandatory (Yes or No)
mainEntityId	Used to specify the person for whom you want to add the prospect account.	Yes
mainEntityType	Used to indicate whether the person is an existing person or a prospect person for whom you want to add the prospect account. The valid values are: <ul style="list-style-type: none"> • EPER • PRSP 	Yes
actionFlag	Used to indicate that you want to create request to add a prospect account. The valid value is: <ul style="list-style-type: none"> • ADD <p>Note: If you do not specify the value in this tag, by default, the system considers it as an ADD action.</p>	Yes
status	Used to indicate the status of the prospect account. <ul style="list-style-type: none"> • ACTIVE • INACTIVE 	No

Tag Name	Tag Description	Mandatory (Yes or No)
	<p>Note:</p> <p>While adding a prospect account, the status of the prospect account can only be set to ACTIVE.</p> <p>If you do not specify the value in this tag, by default, the system considers it as ACTIVE status.</p>	
customerClass	<p>Used to indicate the customer class to which the prospect account belongs.</p> <p>Note: You must specify a customer class which is associated with the division to which the prospect account belongs.</p>	Yes
accountDivision	<p>Used to indicate the division to which the prospect account belongs.</p> <p>Note:</p> <p>You must specify a division which is already defined in the system.</p> <p>You must specify a division to which the prospect account and the person belongs (i.e. the division of the prospect account and the person for whom the account is added should be the same).</p> <p>If you do not specify the division, by default, the system considers the division to which the person belongs.</p>	Yes
setUpDate	Used to specify the date from when the prospect account is configured for the person.	Yes
currency	<p>Used to indicate the currency which you want to use for generating the invoice of the prospect account.</p> <p>Note: You must specify a currency which is already defined in the system and which is associated with the division to which the prospect account belongs.</p>	Yes
billCycle	Used to indicate the time interval in which you want to generate the bills for the prospect account.	Yes (Conditional)
		Note: This data is required while defining the prospect account.
accountAccessGroup	Used to indicate the user group who can view and edit the details of the prospect account.	Yes

Tag Name	Tag Description	Mandatory (Yes or No)
	<p>Note:</p> <p>If you do not specify the value in this tag, the system considers the access group of the person to whom the account belongs.</p> <p>You must specify an access group which is associated with the division to which the prospect account and the person belongs.</p>	
prosAcctCharacteristicList	Used to specify a list of characteristics for the prospect account.	No
characteristicValue	Used to specify the value for the characteristic type.	Yes (Conditional)
		Note: This data is required while defining a characteristic for the prospect account.
effectiveDate	Used to specify the date from when the characteristic is effective for the prospect account.	Yes (Conditional)
		Note: This data is required while defining a characteristic for the prospect account.
characteristicType	Used to indicate the characteristic type.	Yes (Conditional)
	Note: You must specify a characteristic type which is associated with the division to which the prospect account belongs.	Note: This data is required while defining a characteristic for the prospect account.
prosAcctIdentifierList	Used to specify a list of identifiers for the prospect account.	No
accountIdentifierType	Used to indicate the identifier type based on which you want to define the prospect account.	Yes (Conditional)
	<p>Note:</p> <p>If you specify the accountNumber tag, you need to specify the accountIdentifierType tag.</p> <p>You must specify an identifier type which is associated with the division to which the prospect account belongs.</p>	Note: This data is required while associating an identifier with the prospect account.
isPrimaryId	Used to indicate whether the prospect account identifier is primary or not. The valid values are:	Yes (Conditional)
	<ul style="list-style-type: none"> • True • False 	Note: This data is required while associating an identifier with the prospect account.
	Note: If you do not specify the value in this tag, the system considers the value as False .	

Tag Name	Tag Description	Mandatory (Yes or No)
accountNumber	Used to specify the value of the identifier type using which you want to add the prospect account.	Yes (Conditional)
	Note: If you specify the accountIdentifierType tag, you need to specify the accountNumber tag.	Note: This data is required while associating an identifier with the prospect account.

Note:

At a time, you can add only one prospect account for the existing or prospect person through the **C1_PRSACCT_SERVICE** business service.

If the prospect account status is **INACTIVE** in the system, you must set the action flag as **UPD** while adding the prospect account through the inbound web service.

Once the prospect account is created, all the details of prospect account are listed in the above mentioned tags along with the following tag:

Tag Name	Tag Description
prospectAccountId	Displays the prospect account identification number.

Related Topics

For more information on...	See...
Sample prospect account add request and response in the XML format	Sample Prospect Account Creation Request and Response in the XML Format on page 3785

Prospect Account Update Request and Response - Tags in the XML Format

Note: We recommend you to refer the topics [Prospect Account Update Request in the XML Format](#) on page 3775 and [Prospect Account Update Response in the XML Format](#) on page 3775 in parallel while understanding the below mentioned tags. This will help you to understand how the tags are nested in the XML format.

Before calling the **C1_PRSACCT_SERVICE** business service through an inbound web service, you need to ensure that the prospect account update request contains the following tags:

Tag Name	Tag Description	Mandatory (Yes or No)
mainEntityId	Used to specify the person whose prospect account you want to update.	Yes
mainEntityType	Used to indicate whether the person is an existing person or a prospect person whose prospect account you want to update. The valid values are: <ul style="list-style-type: none"> • EPER • PRSP 	Yes
actionFlag	Used to indicate that you want to create request to update a prospect account. The valid value is: <ul style="list-style-type: none"> • UPD 	Yes

Tag Name	Tag Description	Mandatory (Yes or No)
	<p>Note: If you do not specify the value in this tag, by default, the system considers it as an ADD action.</p>	
prospectAccountId	Used to specify the prospect account whose details you want to update.	Yes
status	<p>Used to indicate the current status of the prospect account.</p> <ul style="list-style-type: none"> • ACTIVE • INACTIVE <p>Note:</p> <p>You can change the status of the prospect account from ACTIVE to INACTIVE while updating.</p> <p>You can change the status of a prospect account from INACTIVE to ACTIVE only when the status of the existing or prospect person to whom the prospect account belongs is ACTIVE.</p> <p>If you do not specify the value in this tag, the system considers it as an ACTIVE status.</p>	No
customerClass	<p>Used to indicate the customer class to which the prospect account belongs.</p> <p>Note: You must specify a customer class which is associated with the division to which the prospect account belongs.</p>	Yes
accountDivision	<p>Used to indicate the division to which the prospect account belongs.</p> <p>Note:</p> <p>You must specify a division which is already defined in the system.</p> <p>You must specify a division to which the prospect account and the person belongs (i.e. the division of the prospect account and the person for whom the account is added should be the same).</p> <p>If you do not specify the division, by default, the system considers the division to which the person belongs.</p>	Yes
setUpDate	Used to specify the date from when the prospect account is configured for the person.	Yes

Tag Name	Tag Description	Mandatory (Yes or No)
currency	Used to indicate the currency which you want to use for generating the invoice of the prospect account.	Yes
	Note: You must specify a currency which is already defined in the system and which is associated with the division to which the prospect account belongs.	
billCycle	Used to indicate the time interval in which you want to generate the bills for the prospect account.	Yes
accountAccessGroup	Used to indicate the user group who can view and edit the details of the prospect account.	Yes
	Note: If you do not specify the value in this tag, the system considers the access group of the person to whom the account belongs. You must specify an access group which is associated with the division to which the prospect account and the person belongs.	
prosAcctCharacteristicList	Used to specify a list of characteristics for the prospect account.	No
characteristicValue	Used to specify the value for the characteristic type.	Yes (Conditional)
		Note: This data is required while defining a characteristic for the prospect account.
effectiveDate	Used to specify the date from when the characteristic is effective for the prospect account.	Yes (Conditional)
		Note: This data is required while defining a characteristic for the prospect account.
characteristicType	Used to indicate the characteristic type.	Yes (Conditional)
	Note: You must specify a characteristic type which is associated with the division to which the prospect account belongs.	Note: This data is required while defining a characteristic for the prospect account.
prosAcctIdentifierList	Used to specify a list of identifiers for the prospect account.	No
accountIdentifierType	Used to indicate the identifier type based on which you want to define the prospect account.	Yes (Conditional)
		Note: This data is required while associating an identifier with the prospect account.

Tag Name	Tag Description	Mandatory (Yes or No)
	<p>Note:</p> <p>If you specify the accountNumber tag, you need to specify the accountIdentifierType tag.</p> <p>You must specify an identifier type which is associated with the division to which the prospect account belongs.</p>	
isPrimaryId	<p>Used to indicate whether the prospect account identifier is primary or not. The valid values are:</p> <ul style="list-style-type: none"> • True • False <p>Note: If you do not specify the value in this tag, the system considers the value as False.</p>	<p>Yes (Conditional)</p> <p>Note: This data is required while associating an identifier with the prospect account.</p>
accountNumber	<p>Used to specify the value of the identifier type using which you want to add the prospect account.</p> <p>Note: If you specify the accountIdentifierType tag, you need to specify the accountNumber tag.</p>	<p>Yes (Conditional)</p> <p>Note: This data is required while associating an identifier with the prospect account.</p>

Note:

At a time, you can update only one prospect account of the existing or prospect person through the **C1_PRSACCT_SERVICE** business service.

When you create a request to update a prospect account, the system replaces the prospect account data instead of editing it. Therefore, you should provide all details of the prospect account including the data that you want to change.

Once the prospect account is updated, all the details of prospect account are listed in the above mentioned tags.

Related Topics

For more information on...	See...
Sample prospect account update request and response in the XML format	Sample Prospect Account Update Request and Response in the XML Format on page 3786

Prospect Account View Request and Response - Tags in the XML Format

Note: We recommend you to refer the topics [Prospect Account View Request in the XML Format](#) on page 3776 and [Prospect Account View Response in the XML Format](#) on page 3776 in parallel while understanding the below mentioned tags. This will help you to understand how the tags are nested in the XML format.

Before calling the **C1_PRSACCT_SERVICE** business service through an inbound web service, you need to ensure that the prospect account view request contains the following tags:

Tag Name	Tag Description	Mandatory (Yes or No)
actionFlag	Used to indicate that you want to create request to view the prospect account details. The valid value is: <ul style="list-style-type: none"> • READ 	Yes
	Note: If you do not specify the value in this tag, by default, the system considers it as an ADD action.	
prospectAccountId	Used to specify the prospect account whose details you want to view.	Yes

Once the prospect account view request is created, all the details of prospect account are listed in the above mentioned tags along with the following tags:

Tag Name	Tag Description
mainEntityId	Displays the person to whom the prospect account belongs.
mainEntityType	Indicates whether the person is an existing person or a prospect person to whom the prospect account belongs. The valid values are: <ul style="list-style-type: none"> • EPER • PRSP
status	Indicates the status of the prospect account. The valid values are: <ul style="list-style-type: none"> • ACTIVE • INACTIVE
customerClass	Indicates the customer class to which the prospect account belongs.
accountDivision	Indicates the division to which the prospect account belongs.
setUpDate	Displays the date from when the prospect account is configured for the person.
currency	Indicates the currency which you want to use for generating the invoice of the prospect account.
billCycle	Indicate the time interval in which you want to generate the bills for the prospect account.
accountAccessGroup	Indicates the user group who can view and edit the details of the prospect account.
prosAcctCharacteristicList	Displays the list of characteristic for the prospect account.
characteristicValue	Displays the value of the characteristic type.
effectiveDate	Displays the date from when the characteristic is effective for the prospect account.
characteristicType	Indicates the characteristic type.
prosAcctIdentifierList	Displays a list of account identifiers for the prospect account.
accountIdentifierType	Indicates the identifier type based on which the prospect account is defined.
isPrimaryId	Indicates whether the prospect account identifier is primary or not. The valid values are: <ul style="list-style-type: none"> • True

Tag Name	Tag Description
	<ul style="list-style-type: none"> False
accountNumber	Displays the value of the identifier type using which the prospect account is created.

Related Topics

For more information on...	See...
Sample prospect account view request and response in the XML format	Sample Prospect Account View Request and Response in the XML Format on page 3787

Sample Prospect Account Creation Request and Response in the XML Format

Using the below example, you can create the prospect account for 1723682728 prospect person in 930 division.

Sample Prospect Account Creation Request in the XML Format

```
<C1_PRSACT_SERVICE>
  <mainEntityId>1723682728</mainEntityId>
  <mainEntityType>PRSP</mainEntityType>
  <actionFlag>ADD</actionFlag>
  <status>ACTIVE</status>
  <customerClass>BK</customerClass>
  <accountDivision>930</accountDivision>
  <setUpDate>2019-11-21</setUpDate>
  <currency>USD</currency>
  <billCycle>YEAR</billCycle>
  <accountAccessGroup>***</accountAccessGroup>
  <prosAcctCharacteristicList>
    <characteristicValue>CURRENT</characteristicValue>
    <effectiveDate>2019-11-21</effectiveDate>
    <characteristicType>C1_F_ATY</characteristicType>
  </prosAcctCharacteristicList>
  <prosAcctIdentifierList>
    <accountIdentifierType>ACCT_NM</accountIdentifierType>
    <isPrimaryId>TRUE</isPrimaryId>
    <accountNumber>2429108813</accountNumber>
  </prosAcctIdentifierList>
</C1_PRSACT_SERVICE>
```

Note: If you do not want to enter the data in the list tags (i.e. tags where the type is set to list), you should not include them in the request. Adding empty list tags will give erroneous results.

Sample Prospect Account Creation Response in the XML Format

```
<C1_PRSACT_SERVICE>
  <mainEntityId>1723682728</mainEntityId>
  <mainEntityType>PRSP</mainEntityType>
  <actionFlag>ADD</actionFlag>
  <prospectAccountId>1368615549</prospectAccountId>
  <status>ACTIVE</status>
  <customerClass>BK</customerClass>
  <accountDivision>930</accountDivision>
  <setUpDate>2019-11-21</setUpDate>
  <currency>USD</currency>
  <billCycle>YEAR</billCycle>
  <accountAccessGroup>***</accountAccessGroup>
  <prosAcctCharacteristicList>
    <characteristicValue>CURRENT</characteristicValue>
    <effectiveDate>2019-11-21</effectiveDate>
    <characteristicType>C1_F_ATY</characteristicType>
```

```

</prosAcctCharacteristicList>
<prosAcctIdentifierList>
  <accountIdentifierType>ACCT_NM</accountIdentifierType>
  <isPrimaryId>TRUE</isPrimaryId>
  <accountNumber>2429108813</accountNumber>
</prosAcctIdentifierList>
</C1_PRISACCT_SERVICE>

```

Note: We have given the above request and response samples to illustrate how the tags should be nested while sending a prospect account creation request from the external system. However, you should not seamlessly use this request sample in your environment because the required pre-requisite data may not be available in your environment. In such case, the system will give erroneous results.

Related Topics

For more information on...	See...
Prospect account add request and response tags in the XML format	Prospect Account Add Request and Response - Tags in the XML Format on page 3777

Sample Prospect Account Update Request and Response in the XML Format

Using the below example, you can update the prospect account for 1723682728 entity in 930 division.

Sample Prospect Account Update Request in the XML Format

```

<C1_PRISACCT_SERVICE>
  <mainEntityId>1723682728</mainEntityId>
  <mainEntityType>PRSP</mainEntityType>
  <actionFlag>UPD</actionFlag>
  <prospectAccountId>0164426022</prospectAccountId>
  <status>ACTIVE</status>
  <customerClass>BK</customerClass>
  <accountDivision>930</accountDivision>
  <setUpDate>2019-11-21</setUpDate>
  <currency>AUD</currency>
  <billCycle>YEAR</billCycle>
  <accountAccessGroup>***</accountAccessGroup>
  <prosAcctCharacteristicList>
    <characteristicValue>CURRENT</characteristicValue>
    <effectiveDate>2019-11-21</effectiveDate>
    <characteristicType>C1_F_ATY</characteristicType>
  </prosAcctCharacteristicList>
  <prosAcctIdentifierList>
    <accountIdentifierType>ACCT_NM</accountIdentifierType>
    <isPrimaryId>TRUE</isPrimaryId>
    <accountNumber>2429108813</accountNumber>
  </prosAcctIdentifierList>
</C1_PRISACCT_SERVICE>

```

Note: If you do not want to enter the data in the list tags (i.e. tags where the type is set to list), you should not include them in the request. Adding empty list tags will give erroneous results.

Sample Prospect Account Update Response in the XML Format

```

<C1_PRISACCT_SERVICE>
  <mainEntityId>1723682728</mainEntityId>
  <mainEntityType>PRSP</mainEntityType>
  <actionFlag>UPD</actionFlag>
  <prospectAccountId>0164426022</prospectAccountId>
  <status>ACTIVE</status>
  <customerClass>BK</customerClass>
  <accountDivision>930</accountDivision>

```

```

<setUpDate>2019-11-21</setUpDate>
<currency>AUD</currency>
<billCycle>YEAR</billCycle>
<accountAccessGroup>***</accountAccessGroup>
<prosAcctCharacteristicList>
  <characteristicValue>CURRENT</characteristicValue>
  <effectiveDate>2019-11-21</effectiveDate>
  <characteristicType>C1_F_ATY</characteristicType>
</prosAcctCharacteristicList>
<prosAcctIdentifierList>
  <accountIdentifierType>ACCT_NM</accountIdentifierType>
  <isPrimaryId>TRUE</isPrimaryId>
  <accountNumber>2429108813</accountNumber>
</prosAcctIdentifierList>
</C1_PRSACCT_SERVICE>

```

Note: We have given the above request and response samples to illustrate how the tags should be nested while sending a prospect account update request from the external system. However, you should not seamlessly use this request sample in your environment because the required pre-requisite data may not be available in your environment. In such case, the system will give erroneous results.

Related Topics

For more information on...	See...
Prospect account update request and response tags in the XML format	Prospect Account Update Request and Response - Tags in the XML Format on page 3780

Sample Prospect Account View Request and Response in the XML Format

Using the below example, you can view the prospect account of 0164426022 prospect account ID.

Sample Prospect Account View Request in the XML Format

```

<C1_PRSACCT_SERVICE>
  <actionFlag>READ</actionFlag>
  <prospectAccountId>0164426022</prospectAccountId>
</C1_PRSACCT_SERVICE>

```

Sample Prospect Account View Response in the XML Format

```

<C1_PRSACCT_SERVICE>
  <mainEntityId>1723682728</mainEntityId>
  <mainEntityType>PRSP</mainEntityType>
  <actionFlag>READ</actionFlag>
  <prospectAccountId>0164426022</prospectAccountId>
  <status>ACTIVE</status>
  <customerClass>BK</customerClass>
  <accountDivision>930</accountDivision>
  <setUpDate>2019-11-21</setUpDate>
  <currency>AUD</currency>
  <billCycle>YEAR</billCycle>
  <accountAccessGroup>***</accountAccessGroup>
  <prosAcctCharacteristicList>
    <characteristicValue>CURRENT</characteristicValue>
    <effectiveDate>2019-11-21</effectiveDate>
    <characteristicType>C1_F_ATY</characteristicType>
  </prosAcctCharacteristicList>
  <prosAcctIdentifierList>
    <accountIdentifierType>ACCT_NM</accountIdentifierType>
    <isPrimaryId>TRUE</isPrimaryId>
    <accountNumber>2429108813</accountNumber>
  </prosAcctIdentifierList>

```

</C1_PRSACT_SERVICE>

Note: We have given the above request and response samples to illustrate how the tags should be nested while sending a prospect account view request from the external system. However, you should not seamlessly use this request sample in your environment because the required pre-requisite data may not be available in your environment. In such case, the system will give erroneous results.

Related Topics

For more information on...	See...
Prospect account view request and response tags in the XML format	Prospect Account View Request and Response - Tags in the XML Format on page 3783

Prospect Account Add Request in the JSON Format

The following code snippet illustrates how the attribute/value pairs should be structured while receiving the prospect account add request in the JSON format:

```
{
  "C1_PRSACT_SERVICE"
  {
    "mainEntityId" : "",
    "mainEntityType" : "",
    "actionFlag" : "",
    "status" : "",
    "customerClass" : "",
    "accountDivision" : "",
    "setUpDate" : "",
    "currency" : "",
    "billCycle" : "",
    "accountAccessGroup" : "",
    "prosAcctCharacteristicList"
    {
      "characteristicValue" : "",
      "effectiveDate" : "",
      "characteristicType" : ""
    }
    "prosAcctIdentifierList"
    {
      "accountIdentifierType" : "",
      "isPrimaryId" : "",
      "accountNumber" : ""
    }
  }
}
```

Related Topics

For more information on...	See...
Prospect account add request and response attribute/value pairs in the JSON format	Prospect Account Add Request and Response - Attribute/Value Pairs in the JSON Format on page 3792
Sample prospect account creation request and response in the JSON format	Sample Prospect Account Creation Request and Response in the JSON Format on page 3800

Prospect Account Add Response in the JSON Format

The following code snippet illustrates how the attribute/value pairs should be structured while sending the prospect account add response in the JSON format:

```
{
  "C1_PRSACCT_SERVICE"
  {
    "mainEntityId" : "",
    "mainEntityType" : "",
    "actionFlag" : "",
    "prospectAccountId" : "",
    "status" : "",
    "customerClass" : "",
    "accountDivision" : "",
    "setUpDate" : "",
    "currency" : "",
    "billCycle" : "",
    "accountAccessGroup" : "",
    "prosAcctCharacteristicList"
    {
      "characteristicValue" : "",
      "effectiveDate" : "",
      "characteristicType" : ""
    }
    "prosAcctIdentifierList"
    {
      "accountIdentifierType" : "",
      "isPrimaryId" : "",
      "accountNumber" : ""
    }
  }
}
```

Related Topics

For more information on...	See...
Prospect account add request and response attribute/value pairs in the JSON format	Prospect Account Add Request and Response - Attribute/Value Pairs in the JSON Format on page 3792
Sample prospect account creation request and response in the JSON format	Sample Prospect Account Creation Request and Response in the JSON Format on page 3800

Prospect Account Update Request in the JSON Format

The following code snippet illustrates how the attribute/value pairs should be structured while receiving the prospect account update request in the JSON format:

```
{
  "C1_PRSACCT_SERVICE"
  {
    "mainEntityId" : "",
    "mainEntityType" : "",
    "actionFlag" : "",
    "prospectAccountId" : "",
    "status" : "",
    "customerClass" : "",
    "accountDivision" : "",
    "setUpDate" : "",
    "currency" : "",
    "billCycle" : "",
    "accountAccessGroup" : "",
    "prosAcctCharacteristicList"
    {

```

```

        "characteristicValue" : "",
        "effectiveDate" : "",
        "characteristicType" : "",
    }
    "prosAcctIdentifierList"
    {
        "accountIdentifierType" : "",
        "isPrimaryId" : "",
        "accountNumber" : "",
    }
}

```

Related Topics

For more information on...	See...
Prospect account update request and response attribute/value pairs in the JSON format	Prospect Account Update Request and Response - Attribute/Value Pairs in the JSON Format on page 3795
Sample prospect account update request and response in the JSON format	Sample Prospect Account Update Request and Response in the JSON Format on page 3801

Prospect Account Update Response in the JSON Format

The following code snippet illustrates how the attribute/value pairs should be structured while sending the prospect account update response in the JSON format:

```

{
  "C1_PRSACCT_SERVICE"
  {
    "mainEntityId" : "",
    "mainEntityType" : "",
    "actionFlag" : "",
    "prospectAccountId" : "",
    "status" : "",
    "customerClass" : "",
    "accountDivision" : "",
    "setUpDate" : "",
    "currency" : "",
    "billCycle" : "",
    "accountAccessGroup" : "",
    "prosAcctCharacteristicList"
    {
      "characteristicValue" : "",
      "effectiveDate" : "",
      "characteristicType" : ""
    }
    "prosAcctIdentifierList"
    {
      "accountIdentifierType" : "",
      "isPrimaryId" : "",
      "accountNumber" : ""
    }
  }
}

```

Related Topics

For more information on...	See...
Prospect account update request and response attribute/value pairs in the JSON format	Prospect Account Update Request and Response - Attribute/Value Pairs in the JSON Format on page 3795
Sample prospect account update request and response in the JSON format	Sample Prospect Account Update Request and Response in the JSON Format on page 3801

Prospect Account View Request in the JSON Format

The following code snippet illustrates how the attribute/value pairs should be structured while receiving the prospect account view request in the JSON format:

```
{
  "C1_PRSACCT_SERVICE"
  {
    "actionFlag" : "",
    "prospectAccountId" : "",
  }
}
```

Related Topics

For more information on...	See...
Prospect account view request and response attribute/value pairs in the JSON format	Prospect Account View Request and Response - Attribute/Value Pairs in the JSON Format on page 3799
Sample prospect account view request and response in the JSON format	Sample Prospect Account View Request and Response in the JSON Format on page 3803

Prospect Account View Response in the JSON Format

The following code snippet illustrates how the attribute/value pairs should be structured while sending the prospect account view response in the JSON format:

```
{
  "C1_PRSACCT_SERVICE"
  {
    "mainEntityId" : "",
    "mainEntityType" : "",
    "actionFlag" : "",
    "prospectAccountId" : "",
    "status" : "",
    "customerClass" : "",
    "accountDivision" : "",
    "setUpDate" : "",
    "currency" : "",
    "billCycle" : "",
    "accountAccessGroup" : "",
    "prosAcctCharacteristicList"
    {
      "characteristicValue" : "",
      "effectiveDate" : "",
      "characteristicType" : "",
    }
    "prosAcctIdentifierList"
    {
      "accountIdentifierType" : "",
      "isPrimaryId" : "",
      "accountNumber" : "",
    }
  }
}
```

```

    }
  }
}

```

Related Topics

For more information on...	See...
Prospect account view request and response attribute/value pairs in the JSON format	Prospect Account View Request and Response - Attribute/Value Pairs in the JSON Format on page 3799
Sample prospect account view request and response in the JSON format	Sample Prospect Account View Request and Response in the JSON Format on page 3803

Prospect Account Add Request and Response - Attribute/Value Pairs in the JSON Format

Note: We recommend you to refer the topics [Prospect Account Add Request in the JSON Format](#) on page 3788 and [Prospect Account Add Response in the JSON Format](#) on page 3788 in parallel while understanding the below mentioned attributes. This will help you to understand how the attribute/value pairs are nested in the JSON format.

Before calling the **CI_PRSACT_SERVICE** business service through an inbound web service, you need to ensure that the prospect account add request contains the following attributes:

Attribute Name	Attribute Description	Mandatory (Yes or No)
mainEntityId	Used to specify the person for whom you want to add the prospect account.	Yes
mainEntityType	Used to indicate whether the person is an existing person or a prospect person for whom you want to add the prospect account. The valid values are: <ul style="list-style-type: none"> MAIN PRSP 	Yes
actionFlag	Used to indicate that you want to create request to add a prospect account. The valid value is: <ul style="list-style-type: none"> ADD 	Yes
	Note: If you do not specify the value in this attribute, by default, the system considers it as an ADD action.	
status	Used to indicate the status of the prospect account. <ul style="list-style-type: none"> ACTIVE INACTIVE 	No

Attribute Name	Attribute Description	Mandatory (Yes or No)
	<p>Note:</p> <p>While adding a prospect account, the status of the prospect account can only be set to ACTIVE.</p> <p>If you do not specify the value in this attribute, by default, the system considers it as ACTIVE status.</p>	
customerClass	<p>Used to indicate the customer class to which the prospect account belongs.</p> <p>Note: You must specify a customer class which is associated with the division to which the prospect account belongs.</p>	Yes
accountDivision	<p>Used to indicate the division to which the prospect account belongs.</p> <p>Note:</p> <p>You must specify a division which is already defined in the system.</p> <p>You must specify a division to which the prospect account and the person belongs (i.e. the division of the prospect account and the person for whom the account is added should be the same).</p> <p>If you do not specify the division, by default, the system considers the division to which the person belongs.</p>	Yes
setUpDate	Used to specify the date from when the prospect account is configured for the person.	Yes
currency	<p>Used to indicate the currency which you want to use for generating the invoice of the prospect account.</p> <p>Note: You must specify a currency which is already defined in the system and which is associated with the division to which the prospect account belongs.</p>	Yes
billCycle	Used to indicate the time interval in which you want to generate the bills for the prospect account.	<p>Yes (Conditional)</p> <p>Note: This data is required while defining the prospect account.</p>
accountAccessGroup	Used to indicate the user group who can view and edit the details of the prospect account.	Yes

Attribute Name	Attribute Description	Mandatory (Yes or No)
	<p>Note:</p> <p>If you do not specify the value in this attribute, the system considers the access group of the person to whom the account belongs.</p> <p>You must specify an access group which is associated with the division to which the prospect account and the person belongs.</p>	
prosAcctCharacteristicList	Used to specify a list of characteristics for the prospect account.	No
characteristicValue	Used to specify the value for the characteristic type.	Yes (Conditional) <p>Note: This data is required while defining a characteristic for the prospect account.</p>
effectiveDate	Used to specify the date from when the characteristic is effective for the prospect account.	Yes (Conditional) <p>Note: This data is required while defining a characteristic for the prospect account.</p>
characteristicType	Used to indicate the characteristic type. <p>Note: You must specify a characteristic type which is associated with the division to which the prospect account belongs.</p>	Yes (Conditional) <p>Note: This data is required while defining a characteristic for the prospect account.</p>
prosAcctIdentifierList	Used to specify a list of identifiers for the prospect account.	No
accountIdentifierType	Used to indicate the identifier type based on which you want to define the prospect account. <p>Note:</p> <p>If you specify the accountNumber attribute, you need to specify the accountIdentifierType attribute.</p> <p>You must specify an identifier type which is associated with the division to which the prospect account belongs.</p>	Yes (Conditional) <p>Note: This data is required while associating an identifier with the prospect account.</p>
isPrimaryId	Used to indicate whether the prospect account identifier is primary or not. The valid values are: <ul style="list-style-type: none"> • True • False 	Yes (Conditional) <p>Note: This data is required while associating an identifier with the prospect account.</p>

Attribute Name	Attribute Description	Mandatory (Yes or No)
	Note: If you do not specify the value in this attribute, the system considers the value as False .	
accountNumber	Used to specify the value of the identifier type using which you want to add the prospect account. Note: If you specify the accountIdentifierType attribute, you need to specify the accountNumber attribute.	Yes (Conditional) Note: This data is required while associating an identifier with the prospect account.

Note:

At a time, you can add only one prospect account for the person through the **C1_PRSACCT_SERVICE** business service.

If the prospect account status is **INACTIVE** in the system, you must set the action flag as **UPD** while adding the prospect account through the inbound web service.

Once the prospect account is created, all the details of prospect account are listed in the above mentioned attributes along with the following attribute:

Attribute Name	Attribute Description
prospectAccountId	Displays the prospect account identification number.

Related Topics

For more information on...	See...
Sample prospect account add request and response in the JSON format	Sample Prospect Creation Request and Response in the JSON Format on page 3762

Prospect Account Update Request and Response - Attribute/Value Pairs in the JSON Format

Note: We recommend you to refer the topics [Prospect Account Update Request in the JSON Format](#) on page 3789 and [Prospect Account Update Response in the JSON Format](#) on page 3790 in parallel while understanding the below mentioned attributes. This will help you to understand how the attributes are nested in the JSON format.

Before calling the **C1_PRSACCT_SERVICE** business service through an inbound web service, you need to ensure that the prospect account update request contains the following attributes:

Attribute Name	Attribute Description	Mandatory (Yes or No)
mainEntityId	Used to specify the person whose prospect account you want to update.	Yes
mainEntityType	Used to indicate whether the person is an existing person or a prospect person whose prospect account you want to update. The valid values are: <ul style="list-style-type: none"> • EPER 	Yes

Attribute Name	Attribute Description	Mandatory (Yes or No)
	<ul style="list-style-type: none"> • PRSP 	
actionFlag	Used to indicate that you want to create request to update a prospect account. The valid value is: <ul style="list-style-type: none"> • UPD 	Yes
	Note: If you do not specify the value in this attribute, by default, the system considers it as an ADD action.	
prospectAccountId	Used to specify the prospect account whose details you want to update.	Yes
status	Used to indicate the current status of the prospect account. <ul style="list-style-type: none"> • ACTIVE • INACTIVE 	No
	Note: You can change the status of the prospect account from ACTIVE to INACTIVE while updating. You can change the status of a prospect account from INACTIVE to ACTIVE only when the status of the existing or prospect person to whom the prospect account belongs is ACTIVE . If you do not specify the value in this attribute, the system considers it as an ACTIVE status.	
customerClass	Used to indicate the customer class to which the prospect account belongs.	Yes
	Note: You must specify a customer class which is associated with the division to which the prospect account belongs.	
accountDivision	Used to indicate the division to which the prospect account belongs.	Yes

Attribute Name	Attribute Description	Mandatory (Yes or No)
	<p>Note:</p> <p>You must specify a division which is already defined in the system.</p> <p>You must specify a division to which the prospect account and the person belongs (i.e. the division of the prospect account and the person for whom the account is added should be the same).</p> <p>If you do not specify the division, by default, the system considers the division to which the person belongs.</p>	
setUpDate	Used to specify the date from when the prospect account is configured for the person.	Yes
currency	<p>Used to indicate the currency which you want to use for generating the invoice of the prospect account.</p> <p>Note: You must specify a currency which is already defined in the system and which is associated with the division to which the prospect account belongs.</p>	Yes
billCycle	Used to indicate the time interval in which you want to generate the bills for the prospect account.	Yes
accountAccessGroup	<p>Used to indicate the user group who can view and edit the details of the prospect account.</p> <p>Note:</p> <p>If you do not specify the value in this attribute, the system considers the access group of the person to whom the account belongs.</p> <p>You must specify an access group which is associated with the division to which the prospect account and the person belongs.</p>	Yes
prosAcctCharacteristicList	Used to specify a list of characteristics for the prospect account.	No
characteristicValue	Used to specify the value for the characteristic type.	<p>Yes (Conditional)</p> <p>Note: This data is required while defining a characteristic for the prospect account.</p>
effectiveDate	Used to specify the date from when the characteristic is effective for the prospect account.	Yes (Conditional)

Attribute Name	Attribute Description	Mandatory (Yes or No)
		Note: This data is required while defining a characteristic for the prospect account.
characteristicType	Used to indicate the characteristic type.	Yes (Conditional)
	Note: You must specify a characteristic type which is associated with the division to which the prospect account belongs.	Note: This data is required while defining a characteristic for the prospect account.
prosAcctIdentifierList	Used to specify a list of identifiers for the prospect account.	No
accountIdentifierType	Used to indicate the identifier type based on which you want to define the prospect account.	Yes (Conditional)
	Note: If you specify the accountNumber attribute, you need to specify the accountIdentifierType attribute. You must specify an identifier type which is associated with the division to which the prospect account belongs.	Note: This data is required while associating an identifier with the prospect account.
isPrimaryId	Used to indicate whether the prospect account identifier is primary or not. The valid values are: <ul style="list-style-type: none"> • True • False 	Yes (Conditional)
	Note: If you do not specify the value in this attribute, the system considers the value as False .	Note: This data is required while associating an identifier with the prospect account.
accountNumber	Used to specify the value of the identifier type using which you want to add the prospect account.	Yes (Conditional)
	Note: If you specify the accountIdentifierType attribute, you need to specify the accountNumber attribute.	Note: This data is required while associating an identifier with the prospect account.

Note:

At a time, you can update only one prospect account of the existing or prospect person through the **C1_PRSACCT_SERVICE** business service.

When you create a request to update a prospect account, the system replaces the prospect account data instead of editing it. Therefore, you should provide all details of the prospect account including the data that you want to change.

Once the prospect account is updated, all the details of prospect account are listed in the above mentioned attributes.

Related Topics

For more information on...	See...
Sample prospect account update request and response in the JSON format	Sample Prospect Account Update Request and Response in the JSON Format on page 3801

Prospect Account View Request and Response - Attribute/Value Pairs in the JSON Format

Note: We recommend you to refer the topics [Prospect Account View Request in the JSON Format](#) on page 3791 and [Prospect Account View Response in the JSON Format](#) on page 3791 in parallel while understanding the below mentioned attributes. This will help you to understand the attribute/value pairs are structured in the JSON format.

Before calling the **C1_PRSACT_SERVICE** business service through an inbound web service, you need to ensure that the prospect account view request contains the following attributes:

Attribute Name	Attribute Description	Mandatory (Yes or No)
actionFlag	Used to indicate that you want to create request to view the prospect account details. The valid value is: <ul style="list-style-type: none"> • READ <p>Note: If you do not specify the value in this attribute, by default, the system considers it as an ADD action.</p>	Yes
prospectAccountId	Used to specify the prospect account whose details you want to view.	Yes

Once the prospect account view request is created, all the details of prospect account are listed in the above mentioned attributes along with the following attributes:

Attribute Name	Attribute Description
mainEntityId	Displays the person to whom the prospect account belongs.
mainEntityType	Indicates whether the person is an existing person or a prospect person to whom the prospect account belongs. The valid values are: <ul style="list-style-type: none"> • EPER • PRSP
status	Indicates the status of the prospect account. The valid values are: <ul style="list-style-type: none"> • ACTIVE • INACTIVE
customerClass	Indicates the customer class to which the prospect account belongs.
accountDivision	Indicates the division to which the prospect account belongs.
setUpDate	Displays the date from when the prospect account is configured for the person.
currency	Indicates the currency which you want to use for generating the invoice of the prospect account.
billCycle	Indicate the time interval in which you want to generate the bills for the prospect account.

Attribute Name	Attribute Description
accountAccessGroup	Indicates the user group who can view and edit the details of the prospect account.
prosAcctCharacteristicList	Displays the list of characteristic for the prospect account.
characteristicValue	Displays the value of the characteristic type.
effectiveDate	Displays the date from when the characteristic is effective for the prospect account.
characteristicType	Indicates the characteristic type.
prosAcctIdentifierList	Displays a list of account identifiers for the prospect account.
accountIdentifierType	Indicates the identifier type based on which the prospect account is defined.
isPrimaryId	Indicates whether the prospect account identifier is primary or not. The valid values are: <ul style="list-style-type: none"> • True • False
accountNumber	Displays the value of the identifier type using which the prospect account is created.

Related Topics

For more information on...	See...
Sample prospect account view request and response in the JSON format	Sample Prospect Account View Request and Response in the JSON Format on page 3803

Sample Prospect Account Creation Request and Response in the JSON Format

Using the below example, you can create the prospect account for 1723682728 prospect person in 930 division.

Sample Prospect Account Creation Request in the JSON Format

```
{
  "C1_PRSACCT_SERVICE"
  {
    "mainEntityId" : "1723682728",
    "mainEntityType" : "PRSP",
    "actionFlag" : "ADD",
    "status" : "ACTIVE",
    "customerClass" : "BK",
    "accountDivision" : "930",
    "setUpDate" : "2019-11-21",
    "currency" : "USD",
    "billCycle" : "YEAR",
    "accountAccessGroup" : "****",
    "prosAcctCharacteristicList"
    {
      "characteristicValue" : "CURRENT",
      "effectiveDate" : "2019-11-21",
      "characteristicType" : "C1_F_ATY",
    }
    "prosAcctIdentifierList"
    {
      "accountIdentifierType" : "ACCT_NM",
      "isPrimaryId" : "TRUE",
      "accountNumber" : "2429108813",
    }
  }
}
```

Note: If you do not want to enter the data in the list attributes (i.e. attributes where the type is set to list), you should not include them in the request. Adding empty list attributes will give erroneous results.

Sample Prospect Account Creation Response in the JSON Format

```
{
  "C1_PRSACCT_SERVICE"
  {
    "mainEntityId" : "1723682728",
    "mainEntityType" : "PRSP",
    "actionFlag" : "ADD",
    "prospectAccountId" : "1368615549",
    "status" : "ACTIVE",
    "customerClass" : "BK",
    "accountDivision" : "930",
    "setUpDate" : "2019-11-21",
    "currency" : "USD",
    "billCycle" : "YEAR",
    "accountAccessGroup" : "****",
    "prosAcctCharacteristicList"
    {
      "characteristicValue" : "CURRENT",
      "effectiveDate" : "2019-11-21",
      "characteristicType" : "C1_F_ATY",
    }
    "prosAcctIdentifierList"
    {
      "accountIdentifierType" : "ACCT_NM",
      "isPrimaryId" : "TRUE",
      "accountNumber" : "2429108813",
    }
  }
}
```

Note: We have given the above request and response samples to illustrate how the attribute value pairs should be structured while sending a prospect account creation request from the external system. However, you should not seamlessly use this request sample in your environment because the required pre-requisite data may not be available in your environment. In such case, the system will give erroneous results.

Related Topics

For more information on...	See...
Prospect account add request and response attribute/value pairs in the JSON format	Prospect Account Add Request and Response - Attribute/Value Pairs in the JSON Format on page 3792

Sample Prospect Account Update Request and Response in the JSON Format

Using the below example, you can update the prospect account for 1723682728 entity in 930 division.

Sample Prospect Account Update Request in the JSON Format.

```
{
  "C1_PRSACCT_SERVICE"
  {
    "mainEntityId" : "1723682728",
    "mainEntityType" : "PRSP",
    "actionFlag" : "UPD",
    "prospectAccountId" : "0164426022",
    "status" : "ACTIVE",
    "customerClass" : "BK",
    "accountDivision" : "930",
  }
}
```

```

    "setUpDate" : "2019-11-21",
    "currency" : "AUD",
    "billCycle" : "YEAR",
    "accountAccessGroup" : "****",
    "prosAcctCharacteristicList"
    {
        "characteristicValue" : "CURRENT",
        "effectiveDate" : "2019-11-21",
        "characteristicType" : "Cl_F_ATY",
    }
    "prosAcctIdentifierList"
    {
        "accountIdentifierType" : "ACCT_NM",
        "isPrimaryId" : "TRUE",
        "accountNumber" : "2429108813",
    }
}

```

Note: If you do not want to enter the data in the list attributes (i.e. attributes where the type is set to list), you should not include them in the request. Adding empty list attributes will give erroneous results.

Sample Prospect Account Update Response in the JSON Format.

```

{
  "Cl_PRSACCT_SERVICE"
  {
    "mainEntityId" : "1723682728",
    "mainEntityType" : "PRSP",
    "actionFlag" : "UPD",
    "prospectAccountId" : "0164426022",
    "status" : "ACTIVE",
    "customerClass" : "BK",
    "accountDivision" : "930",
    "setUpDate" : "2019-11-21",
    "currency" : "AUD",
    "billCycle" : "YEAR",
    "accountAccessGroup" : "****",
    "prosAcctCharacteristicList"
    {
        "characteristicValue" : "CURRENT",
        "effectiveDate" : "2019-11-21",
        "characteristicType" : "Cl_F_ATY",
    }
    "prosAcctIdentifierList"
    {
        "accountIdentifierType" : "ACCT_NM",
        "isPrimaryId" : "TRUE",
        "accountNumber" : "2429108813",
    }
  }
}

```

Note: We have given the above request and response samples to illustrate how the attribute value pairs should be structured while sending a prospect account update request from the external system. However, you should not seamlessly use this request sample in your environment because the required pre-requisite data may not be available in your environment. In such case, the system will give erroneous results.

Related Topics

For more information on...	See...
Prospect account update request and response attribute/value pairs in the JSON format	Prospect Account Update Request and Response - Attribute/Value Pairs in the JSON Format on page 3795

Sample Prospect Account View Request and Response in the JSON Format

Using the below example, you can view the prospect account of 0164426022 prospect account ID.

Sample Prospect Account View Request in the JSON Format

```
{
  "C1_PRSACT_SERVICE"
  {
    "actionFlag" : "READ",
    "prospectAccountId" : "0164426022",
  }
}
```

Sample Prospect Account View Response in the JSON Format

```
{
  "C1_PRSACT_SERVICE"
  {
    "mainEntityId" : "1723682728",
    "mainEntityType" : "PRSP",
    "actionFlag" : "READ",
    "prospectAccountId" : "0164426022",
    "status" : "ACTIVE",
    "customerClass" : "BK",
    "accountDivision" : "930",
    "setUpDate" : "2019-11-21",
    "currency" : "AUD",
    "billCycle" : "YEAR",
    "accountAccessGroup" : "****",
    "prosAcctCharacteristicList"
    {
      "characteristicValue" : "CURRENT",
      "effectiveDate" : "2019-11-21",
      "characteristicType" : "C1_F_ATY",
    }
    "prosAcctIdentifierList"
    {
      "accountIdentifierType" : "ACCT_NM",
      "isPrimaryId" : "TRUE",
      "accountNumber" : "2429108813",
    }
  }
}
```

Note: We have given the above request and response samples to illustrate how the attribute value pairs should be structured while sending a prospect account view request from the external system. However, you should not seamlessly use this request sample in your environment because the required pre-requisite data may not be available in your environment. In such case, the system will give erroneous results.

Related Topics

For more information on...	See...
Prospect account view request and response attribute/value pairs in the JSON format	Prospect Account View Request and Response - Attribute/Value Pairs in the JSON Format on page 3799

Price List Assignments in Deal through Inbound Web Service

Oracle Revenue Management and Billing enables you to assign a price list to an existing or prospect customer or account in a deal through a web service. It also enables you to edit and delete a price list assignment of a deal and view the details of a price list assignment through a web service. You can send a request from the external system to do the following through an inbound web service:

- Assign a price list to an existing or prospect customer or account in a deal
- Edit a price list assignment of a deal
- Delete a price list assignment of a deal
- View the details of a price list assignment

At a time, you can send a request either for viewing the details of one or more price list assignments or for creating, updating, and/or deleting one or more price list assignments of a deal. We have shipped the following two inbound web services in this release:

- **C1-DealPricelistAssignment** - This is a SOAP based web service. You can use this web service when you want to send the above requests with respect to price list assignment in the XML format.
- **C1-DealPricelistAssignmentREST** - This is a REST based web service. You can use this web service when you want to send the above requests with respect to price list assignment in the XML or JSON format.

Both these inbound web services call the **C1-DealPricelistAssignmentBS** business service. This business service is used to do the following:

- **Assign a price list to a customer or an account in a deal** – While assigning a price list to a customer or an account in a deal, you can specify the following details:
 - Deal Version ID or Deal ID or Deal Identifier to determine the deal version in which you want to assign the price list to an entity
 - Entity (i.e. person or account) to whom you want to assign the price list
 - Price list that you want to assign
 - Start and end dates of the price list assignment
 - Priority of the price list assignment
 - Whether the customer or account can inherit pricing from the parent price list

To assign a price list to a customer or an account in a deal through the web service, you must set the action flag to **ADD**. On processing the request, the system assigns the price list to the entity in the deal in the **Proposed** status.

- **Edit a price list assignment of a deal** – While editing a price list assignment of a deal, you need to:
 - Specify the deal version ID or deal ID or deal identifier to determine the deal version whose proposed price list assignment you want to edit
 - Specify the price list assignment ID
 - Specify the entity (i.e. person or account) whose price list assignment you want to edit
 - Set the action flag to **UPD**

During the update operation, the system replaces the price list assignment data instead of editing it. Therefore, you should provide all details of the price list assignment including the data that you want to change.

- **Delete a price list assignment of a deal** – While deleting a price list assignment of a deal, you need to:
 - Specify the deal version ID or deal ID or deal identifier to determine the deal version whose proposed price list assignment you want to delete
 - Specify the price list assignment ID

- Specify the entity (i.e. person or account) whose price list assignment you want to delete
- Set the action flag to **DEL**

On processing the request, the system deletes the proposed price list assignment of the entity from the deal.

- **View the details of a price list assignment** – While viewing the details of a price list assignment, you can specify either of the following:
 - **Price List Assignment ID** – Used when you want to view the details of a particular price list assignment.
 - **Entity Type and Entity ID** – Used when you want to view all price list assignments of a particular entity (i.e. person or account).
 - **Deal Version ID, Deal ID, or Deal Identifier** – Used when you want to view the price list assignments of all customers and accounts in a particular deal.

Note that if you provide the price list assignment ID, entity details, and deal details, the system fetches the details of a price list assignment using the price list assignment ID and ignores the entity and deal details. However, if you provide the entity and deal details, the system fetches the price list assignments of the given entity and ignores the deal details. Similarly, if you only provide the deal details, the system fetches all price list assignments of all entities from the given deal.

To view the details of a price list assignment through the web service, you must set the action flag to **READ**. On processing the request, the system displays the details of the price list assignment in the response.

If both the deal version and deal ID or deal identifier are given in the request, the system considers the deal version. However, if only the deal ID or deal identifier is given in the request, the system derives the deal version. Note that an error occurs when the given deal has multiple deal versions. For more information about the Deal Management functionality, refer to *Oracle Revenue Management and Billing Banking User Guide*.

Deal Price List Assignment Add Request in the XML Format

The following code snippet illustrates how the tags should be nested while receiving the deal price list assignment creation request in the XML format:

```
<C1-DealPricelistAssignmentBS>
  <dealIdentifier></dealIdentifier>
  <dealId></dealId>
  <modelId></modelId>
  <pricelistassignmentlist>
    <entityId></entityId>
    <entityType></entityType>
    <actionFlag></actionFlag>
    <startDate></startDate>
    <endDate></endDate>
    <priority></priority>
    <priceListId></priceListId>
    <priceListInheritanceSw></priceListInheritanceSw>
  </pricelistassignmentlist>
</C1-DealPricelistAssignmentBS>
```

Related Topics

For more information on...	See...
Deal price list assignment add request and response tags in the XML format	Deal Price List Assignment Add Request and Response - Tags in the XML Format on page 3809
Sample deal price list assignment add request and response in the XML format	Sample Deal Price List Assignment Add Request and Response in the XML Format on page 3817

Deal Price List Assignment Add Response in the XML Format

The following code snippet illustrates how the tags should be nested while sending the deal price list assignment creation response in the XML format:

```
<C1-DealPricelistAssignmentBS>
  <dealIdentifier></dealIdentifier>
  <dealId></dealId>
  <modelId></modelId>
  <priceListAssignmentId></priceListAssignmentId>
  <pricelistassignmentlist>
    <entityId></entityId>
    <entityType></entityType>
    <actionFlag></actionFlag>
    <priceListAssignmentId></priceListAssignmentId>
    <startDate></startDate>
    <endDate></endDate>
    <priority></priority>
    <priceListId></priceListId>
    <priceListAssignStatusFlag></priceListAssignStatusFlag>
    <priceListInheritanceSw></priceListInheritanceSw>
  </pricelistassignmentlist>
</C1-DealPricelistAssignmentBS>
```

Related Topics

For more information on...	See...
Deal price list assignment add request and response tags in the XML format	Deal Price List Assignment Add Request and Response - Tags in the XML Format on page 3809
Sample deal price list assignment add request and response in the XML format	Sample Deal Price List Assignment Add Request and Response in the XML Format on page 3817

Deal Price List Assignment Delete Request in the XML Format

The following code snippet illustrates how the tags should be nested while receiving the deal price list assignment delete request in the XML format:

```
<C1-DealPricelistAssignmentBS>
  <dealIdentifier></dealIdentifier>
  <dealId></dealId>
  <modelId></modelId>
  <pricelistassignmentlist>
    <entityId></entityId>
    <entityType></entityType>
    <actionFlag></actionFlag>
    <priceListAssignmentId></priceListAssignmentId>
    <startDate></startDate>
    <endDate></endDate>
    <priority></priority>
    <priceListId></priceListId>
    <priceListInheritanceSw></priceListInheritanceSw>
  </pricelistassignmentlist>
</C1-DealPricelistAssignmentBS>
```

Related Topics

For more information on...	See...
Deal price list assignment delete request and response tags in the XML format	Deal Price List Assignment Delete Request and Response - Tags in the XML Format on page 3811

For more information on...	See...
Sample deal price list assignment delete request and response in the XML format	Sample Deal Price List Assignment Delete Request and Response in the XML Format on page 3818

Deal Price List Assignment Delete Response in the XML Format

The following code snippet illustrates how the tags should be nested while sending the deal price list assignment delete response in the XML format:

```
<C1-DealPricelistAssignmentBS>
  <dealIdentifier></dealIdentifier>
  <dealId></dealId>
  <modelId></modelId>
  <pricelistassignmentlist>
    <entityId></entityId>
    <entityType></entityType>
    <actionFlag></actionFlag>
    <priceListAssignmentId></priceListAssignmentId>
    <startDate></startDate>
    <endDate></endDate>
    <priority></priority>
    <priceListId></priceListId>
    <priceListInheritanceSw></priceListInheritanceSw>
  </pricelistassignmentlist>
</C1-DealPricelistAssignmentBS>
```

Related Topics

For more information on...	See...
Deal price list assignment delete request and response tags in the XML format	Deal Price List Assignment Delete Request and Response - Tags in the XML Format on page 3811
Sample deal price list assignment delete request and response in the XML format	Sample Deal Price List Assignment Delete Request and Response in the XML Format on page 3818

Deal Price List Assignment Update Request in the XML Format

The following code snippet illustrates how the tags should be nested while sending the deal price list assignment update request in the XML format:

```
<C1-DealPricelistAssignmentBS>
  <dealIdentifier></dealIdentifier>
  <dealId></dealId>
  <modelId></modelId>
  <pricelistassignmentlist>
    <entityId></entityId>
    <entityType></entityType>
    <actionFlag></actionFlag>
    <priceListAssignmentId></priceListAssignmentId>
    <startDate></startDate>
    <endDate></endDate>
    <priority></priority>
    <priceListId></priceListId>
    <priceListInheritanceSw></priceListInheritanceSw>
  </pricelistassignmentlist>
</C1-DealPricelistAssignmentBS>
```

Related Topics

For more information on...	See...
Deal price list assignment update request and response tags in the XML format	Deal Price List Assignment Update Request and Response - Tags in the XML Format on page 3813
Sample deal price list assignment update request and response in the XML format	Sample Deal Price List Assignment Update Request and Response in the XML Format on page 3819

Deal Price List Assignment Update Response in the XML Format

The following code snippet illustrates how the tags should be nested while sending the deal price list assignment update response in the XML Format.

```
<C1-DealPricelistAssignmentBS>
  <dealIdentifier></dealIdentifier>
  <dealId></dealId>
  <modelId></modelId>
  <pricelistassignmentlist>
    <entityId></entityId>
    <entityType></entityType>
    <actionFlag></actionFlag>
    <priceListAssignmentId></priceListAssignmentId>
    <startDate></startDate>
    <endDate></endDate>
    <priority></priority>
    <priceListId></priceListId>
    <priceListInheritanceSw></priceListInheritanceSw>
  </pricelistassignmentlist>
</C1-DealPricelistAssignmentBS>
```

Related Topics

For more information on...	See...
Deal price list assignment update request and response tags in the XML format	Deal Price List Assignment Update Request and Response - Tags in the XML Format on page 3813
Sample deal price list assignment update request and response in the XML format	Sample Deal Price List Assignment Update Request and Response in the XML Format on page 3819

Deal Price List Assignment View Request in the XML Format

The following code snippet illustrates how the tags should be nested while receiving the deal price list assignment view request in the XML format:

```
<C1-DealPricelistAssignmentBS>
  <dealIdentifier></dealIdentifier>
  <dealId></dealId>
  <modelId></modelId>
  <actionFlag></actionFlag>
  <entityId></entityId>
  <entityType></entityType>
  <priceListAssignmentId></priceListAssignmentId>
</C1-DealPricelistAssignmentBS>
```

Related Topics

For more information on...	See...
Deal price list assignment view request and response tags in the XML format	Deal Price List Assignment View Request and Response - Tags in the XML Format on page 3815

For more information on...	See...
Sample deal price list assignment view request and response in the XML format	Sample Deal Price List Assignment View Request and Response in the XML Format on page 3820

Deal Price List Assignment View Response in the XML Format

The following code snippet illustrates how the tags should be nested while sending the deal price list assignment view response in the XML format:

```
<C1-DealPricelistAssignmentBS>
  <dealIdentifier></dealIdentifier>
  <dealId></dealId>
  <modelId></modelId>
  <actionFlag></actionFlag>
  <entityId></entityId>
  <entityType></entityType>
  <priceListAssignmentId></priceListAssignmentId>
  <pricelistassignmentlist>
    <entityId></entityId>
    <entityType></entityType>
    <actionFlag></actionFlag>
    <priceListAssignmentId></priceListAssignmentId>
    <startDate></startDate>
    <endDate></endDate>
    <priority></priority>
    <priceListId></priceListId>
    <priceListAssignStatusFlag></priceListAssignStatusFlag>
    <priceListInheritanceSw></priceListInheritanceSw>
  </pricelistassignmentlist>
</C1-DealPricelistAssignmentBS>
```

Related Topics

For more information on...	See...
Deal price list assignment view request and response tags in the XML format	Deal Price List Assignment View Request and Response - Tags in the XML Format on page 3815
Sample deal price list assignment view request and response in the XML format	Sample Deal Price List Assignment View Request and Response in the XML Format on page 3820

Deal Price List Assignment Add Request and Response - Tags in the XML Format

Note: We recommend you to refer the topics [Deal Price List Assignment Add Request in the XML Format](#) on page 3805 and [Deal Price List Assignment Add Response in the XML Format](#) on page 3805 in parallel while understanding the below mentioned tags. This will help you to understand how the tags are nested in the XML format.

Before calling the **C1-DealPricelistAssignmentBS** business service through an inbound web service, you need to ensure that the deal price list assignment add request contains the following tags:

Tag Name	Tag Description	Mandatory (Yes or No)
dealIdentifier	Used to assign price list to the entity (i.e. existing or prospect person or account) in the entity hierarchy of a deal which is created using a particular deal identifier.	Yes (Conditional)
		Note: This data is required if you do not specify the dealID or modelID tags.

Tag Name	Tag Description	Mandatory (Yes or No)
dealId	Used to specify the deal for which you want to add the price list assignment.	Yes (Conditional)
		Note: This data is required if you do not specify the dealIdentifier or modelID tags.
modelId	Used to specify the deal version for which you want to add the price list assignment.	Yes (Conditional)
		Note: This data is required if you do not specify the dealIdentifier or dealID tags.
pricelistassignmentlist	Used to assign the price list to the entities (i.e. existing or prospect person or account) in the entity hierarchy of the deal.	Yes
entityId	Used to specify the entity (i.e. existing or prospect person or account) to which you want to assign the price list.	Yes
entityType	Used to indicate the type of the entity to which you want to assign the price list. The valid values are: <ul style="list-style-type: none"> • PERS • ACCT 	Yes
actionFlag	Used to indicate that you want to create request to add the price list assignment. The valid value is: <ul style="list-style-type: none"> • ADD 	Yes
	Note: If you do not specify the value in this tag, the system considers it as an Add action.	
startDate	Used to specify the date from when the price list assignment is effective for the entity (i.e. existing or prospect person or account).	No
	Note: The price list assignment start date must be equal to the deal start date. The price list assignment start date cannot be later than the price list assignment end date. If you do not specify the value in this tag, the system considers the deal start date as the price list assignment start date.	
endDate	Used to specify the date till when the price list assignment is effective for the entity (i.e. existing or prospect person or account).	No

Tag Name	Tag Description	Mandatory (Yes or No)
	<p>Note:</p> <p>The price list assignment end date cannot be later than the deal end date.</p> <p>The price list assignment end date cannot be earlier than the price list assignment start date.</p>	
priority	<p>Used to specify the priority in which the price list should be considered to determine the price item pricing.</p> <p>Note:</p> <p>The priority of the price list assignment must be greater than zero.</p> <p>You cannot have same priority for price list assignments having the same effective start date and end date.</p>	Yes
priceListId	Used to specify the price list that you want to assign to the entity (i.e. existing or prospect person or account).	Yes
priceListInheritanceSw	<p>Used to indicate whether the price item pricing is inherited from the parent price list hierarchy defined for the price list which is assigned to the entity (i.e. existing or prospect person or account). The valid values are:</p> <ul style="list-style-type: none"> • Y • N <p>Note: If you do not specify the value in this tag, the system considers it as N.</p>	No

Once the price list assignment is created, all the details of price list assignment are listed in the above mentioned tags along with the following tag:

Tag Name	Tag Description
priceListAssignmentId	Displays the price list assignment ID.
	<p>Note: A new price list assignment ID is generated by the system when you create a request to add a price list assignment.</p>

Related Topics

For more information on...	See...
Sample deal price list assignment add request and response in the XML format	Sample Deal Price List Assignment Add Request and Response in the XML Format on page 3817

Deal Price List Assignment Delete Request and Response - Tags in the XML Format

Note: We recommend you to refer the topics [Deal Price List Assignment Delete Request in the XML Format](#) on page 3806 and [Deal Price List Assignment Delete Response in the XML Format](#) on page 3807 in parallel while understanding the below mentioned tags. This will help you to understand how the tags are nested in the XML format.

Before calling the **C1-DealPricelistAssignmentBS** business service through an inbound web service, you need to ensure that the deal price list assignment delete request contains the following tags:

Tag Name	Tag Description	Mandatory (Yes or No)
dealIdentifier	Used to delete the price list assignment of an entity (i.e. existing or prospect person or account) in the entity hierarchy of a deal which is created using a particular deal identifier.	Yes (Conditional) Note: This data is required if you do not specify the dealID or modelID tags.
dealId	Used to specify the deal whose entities (i.e. existing or prospect person or account) price list assignment you want to delete.	Yes (Conditional) Note: This data is required if you do not specify the dealIdentifier or modelID tags.
modelId	Used to specify the deal version whose entities (i.e. existing or prospect person or account) price list assignment you want to delete.	Yes (Conditional) Note: This data is required if you do not specify the dealIdentifier or dealID tags.
pricelistassignmentlist	Used to specify a list of price list assignments of the entities (i.e. existing or prospect person or account) in the entity hierarchy of a deal that you want to delete.	Yes
entityId	Used to specify the entity (i.e. existing or prospect person or account) whose price list assignment you want to delete.	Yes
entityType	Used to indicate the entity type of the entity for which you want to delete the price list assignment. The valid values are: <ul style="list-style-type: none"> PERS ACCT 	Yes
actionFlag	Used to indicate that you want to create a request to delete the price list assignment. The valid value is: <ul style="list-style-type: none"> DEL Note: If you do not specify the value in this tag, the system considers it as an Add action.	Yes
priceListAssignmentId	Used to specify the price list assignment which you want to delete.	Yes
startDate	Used to specify the date from when the price list assignment is effective for the entity.	No

Tag Name	Tag Description	Mandatory (Yes or No)
endDate	Used to specify the date till when the price list assignment is effective for the entity (i.e. existing or prospect person or account).	No
priority	Used to specify the priority in which the price list is considered to determine the price item pricing.	No
priceListId	Used to specify the price list that you want to delete from the entity (i.e. existing or prospect person or account).	No
priceListInheritanceSw	Used to indicate whether the price item pricing is inherited from the parent price list hierarchy defined for the price list which is assigned to the entity (i.e. existing or prospect person or account). The valid values are: <ul style="list-style-type: none"> • Y • N 	No

Once the price list assignment is deleted, all the details of price list assignment are listed in the above mentioned tags.

Related Topics

For more information on...	See...
Sample deal price list assignment delete request and response in the XML format	Sample Deal Price List Assignment Delete Request and Response in the XML Format on page 3818

Deal Price List Assignment Update Request and Response - Tags in the XML Format

Note: We recommend you to refer the topics [Deal Price List Assignment Update Request in the XML Format](#) on page 3807 and [Deal Price List Assignment Update Response in the XML Format](#) on page 3808 in parallel while understanding the below mentioned tags. This will help you to understand how the tags are nested in the XML format.

Before calling the **C1-DealPricelistAssignmentBS** business service through an inbound web service, you need to ensure that the deal price list assignment update request contains the following tags:

Tag Name	Tag Description	Mandatory (Yes or No)
dealIdentifier	Used to update the price list assignment of an entity (i.e. existing or prospect person or account) in the entity hierarchy of a deal which is created using a particular deal identifier.	Yes (Conditional) Note: This data is required if you do not specify the dealID or modelID tags.
dealId	Used to specify the deal for which you want to update the price list assignment.	Yes (Conditional) Note: This data is required if you do not specify the dealIdentifier or modelID tags.
modelId	Used to specify the deal version for which you want to update the price list assignment.	Yes (Conditional)

Tag Name	Tag Description	Mandatory (Yes or No)
		Note: This data is required if you do not specify the dealIdentifier or dealID tags.
pricelistassignmentlist	Used to update the price list assignment of the entities (i.e. existing or prospect person or account) in the entity hierarchy of the deal.	Yes
entityId	Used to specify the entity (i.e. existing or prospect person or account) whose price list assignment you want to update.	Yes
entityType	Used to indicate the type of the entity whose price list assignment you want to update. The valid values are: <ul style="list-style-type: none"> • PERS • ACCT 	Yes
actionFlag	Used to indicate that you want to create a request to update the price list assignment. The valid value is: <ul style="list-style-type: none"> • UPD <p>Note: If you do not specify the value in this tag, the system considers it as an Add action.</p>	Yes
priceListAssignmentId	Used to specify the price list assignment which you want to update.	Yes
startDate	Used to specify the date from when the price list assignment is effective for the entity (i.e. existing or prospect person or account). <p>Note:</p> <p>The price list assignment start date must be equal to the deal start date.</p> <p>The price list assignment start date cannot be later than the price list assignment end date.</p> <p>If you do not specify the value in this tag, the system considers the deal start date as the price list assignment start date.</p>	Yes
endDate	Used to specify the date till when the price list assignment is effective for the entity (i.e. existing or prospect person or account).	Yes

Tag Name	Tag Description	Mandatory (Yes or No)
	<p>Note:</p> <p>The price list assignment end date cannot be later than the deal end date.</p> <p>The price list assignment end date cannot be earlier than the price list assignment start date.</p>	
priority	<p>Used to specify the priority in which the price list is considered to determine the price item pricing.</p> <p>Note:</p> <p>The priority of the price list assignment must be greater than zero.</p> <p>You cannot have same priority for price list assignments having the same effective start date and end date.</p>	Yes
priceListId	Used to specify the price list that you want to assign to the entity (i.e. existing or prospect person or account).	Yes
priceListInheritanceSw	<p>Used to indicate whether the price item pricing is inherited from the parent price list hierarchy defined for the price list which is assigned to the entity (i.e. existing or prospect person or account). The valid values are:</p> <ul style="list-style-type: none"> • Y • N <p>Note: If you do not specify the value in this tag, the system considers it as N.</p>	Yes

Note: When you create a request to update a price list assignment, the system replaces the price list assignment data instead of editing it. Therefore, you should provide all details of the price list assignment including the data that you want to change.

Once the deal price list assignment is updated, all the details of deal price list assignment are listed in the above mentioned tags.

Related Topics

For more information on...	See...
Sample deal price list assignment update request and response in the XML format	Sample Deal Price List Assignment Update Request and Response in the XML Format on page 3819

Deal Price List Assignment View Request and Response - Tags in the XML Format

Note: We recommend you to refer the topics *Deal Price List Assignment View Request in the XML Format* on page 3808 and *Deal Price List Assignment View Response in the XML Format* on page 3809 in parallel while understanding the below mentioned tags. This will help you to understand how the tags are nested in the XML format.

Before calling the **C1-DealPricelistAssignmentBS** business service through an inbound web service, you need to ensure that the deal price list assignment view request contains the following tags:

Tag Name	Tag Description	Mandatory (Yes or No)
actionFlag	Used to indicate that you want to view the price list assignments of all the entities (i.e. existing or prospect person or account) in the entity hierarchy of the deal. The valid value is: <ul style="list-style-type: none"> • READ 	Yes (Conditional)
	Note: If you do not specify the value in this tag, the system considers the value provided in the actionFlag tag of the pricelistassignmentlist tag.	Note: This data is required if the actionFlag tag is not specified in the pricelistassignmentlist tag.
dealIdentifier	Used to view the price list of the entities (i.e. existing or prospect person or account) in the entity hierarchy of a deal which is created using a particular deal identifier.	Yes (Conditional)
		Note: This data is required if you do not specify the dealID or modelID tags.
dealId	Used to specify the deal whose entities (i.e. existing or prospect person or account) price list assignment you want to view.	Yes (Conditional)
		Note: This data is required if you do not specify the dealIdentifier or modelID tags.
modelID	Used to specify the deal version whose entities (i.e. existing or prospect person or account) price list assignment you want to view.	Yes (Conditional)
		Note: This data is required if you do not specify the dealIdentifier or dealID tags.
entityId	Used to specify the entity (i.e. existing or prospect person or account) in the entity hierarchy of the deal whose price list assignment you want to view.	No
entityType	Used to indicate the type of the entity whose price list assignment you want to view. The valid values are: <ul style="list-style-type: none"> • PERS • ACCT 	Yes (Conditional)
	Note: If you specify the entityId tag, you need to specify the entityType tag.	Note: This data is required for viewing the price list assignments of a particular entity in the entity hierarchy of a deal.
priceListAssignmentId	Used to specify the price list assignment whose details you want to view.	Yes

Once the price list assignment view request is created, all the details of price list assignment are listed in the above mentioned tags along with the following tags:

Tag Name	Tag Description
pricelistassignmentlist	Lists the price list assignments of the entities (i.e. existing or prospect person or account) in the entity hierarchy of the deal.
entityId	Displays the entity (i.e. existing or prospect person or account) in the entity hierarchy of the deal.
entityType	Indicates the type of the entity. The valid values are: <ul style="list-style-type: none"> • PERS • ACCT
actionFlag	Indicates the action performed for viewing the price list assignment of the entity (i.e. existing or prospect person or account). The valid value is: <ul style="list-style-type: none"> • READ
priceListAssignmentId	Displays the price list assignment ID.
startDate	Displays date from when the price list assignment is effective for the entity.
endDate	Displays the date till when the price list assignment is effective for the entity.
priority	Displays the priority in which the price list is considered to determine the price item pricing.
priceListId	Displays the price list that is assigned to the entity (i.e. existing or prospect person or account).
priceListAssignStatusFlag	Indicates the current status of the price list assignment. The valid values are: <ul style="list-style-type: none"> • Active • Proposed • Inactive • Rejected
priceListInheritanceSw	Indicates whether the price item pricing is inherited from the parent price list hierarchy defined for the price list which is assigned to the entity (i.e. existing or prospect person or account). The valid values are: <ul style="list-style-type: none"> • Y • N

Related Topics

For more information on...	See...
Sample deal price list assignment view request and response in the XML format	Sample Deal Price List Assignment View Request and Response in the XML Format on page 3820

Sample Deal Price List Assignment Add Request and Response in the XML Format

Using the below example, you can create the price list assignment for 1600395396 entity in 3336086427 deal.

Sample Price List Assignment Creation Request in the XML Format

```
<C1-DealPricelistAssignmentBS>
```

```

<dealId>3336086427</dealId>
<pricelistassignmentlist>
  <entityId>1600395396</entityId>
  <entityType>PERS</entityType>
  <actionFlag>ADD</actionFlag>
  <startDate>2024-01-01</startDate>
  <endDate>2025-01-01</endDate>
  <priority>9</priority>
  <priceListId>0106513196</priceListId>
  <priceListInheritanceSw>N</priceListInheritanceSw>
</pricelistassignmentlist>
</C1-DealPricelistAssignmentBS>

```

Note: If you do not want to enter the data in the list tags (i.e. tags where the type is set to list), you should not include them in the request. Adding empty list tags will give erroneous results.

Sample Price List Assignment Creation Response in the XML Format

```

<C1-DealPricelistAssignmentBS>
  <dealId>3336086427</dealId>
  <modelId>8729119397</modelId>
  <pricelistassignmentlist>
    <entityId>1600395396</entityId>
    <entityType>PERS</entityType>
    <actionFlag>ADD</actionFlag>
    <priceListAssignmentId>0710416227</priceListAssignmentId>
    <startDate>2024-01-01</startDate>
    <endDate>2025-01-01</endDate>
    <priority>9</priority>
    <priceListId>0106513196</priceListId>
    <priceListInheritanceSw>N</priceListInheritanceSw>
  </pricelistassignmentlist>
</C1-DealPricelistAssignmentBS>

```

Note: We have given the above request and response samples to illustrate how the tags should be nested while sending a deal price list assignment add request from the external system. However, you should not seamlessly use this request sample in your environment because the required pre-requisite data may not be available in your environment. In such case, the system will give erroneous results.

Related Topics

For more information on...	See...
Deal price list assignment add request and response tags in the XML format	Deal Price List Assignment Add Request and Response - Tags in the XML Format on page 3809

Sample Deal Price List Assignment Delete Request and Response in the XML Format

Using the below example, you can delete the price list assignment of 0073281975 entity in 7781868561 deal.

Sample Deal Price List Assignment Delete Request in the XML Format

```

<C1-DealPricelistAssignmentBS>
  <dealId>7781868561</dealId>
  <pricelistassignmentlist>
    <entityId>0073281975</entityId>
    <entityType>PERS</entityType>
    <actionFlag>DEL</actionFlag>
    <priceListAssignmentId>1164917538</priceListAssignmentId>
    <startDate>2024-01-01</startDate>
    <endDate>2024-01-01</endDate>
    <priority>7</priority>
    <priceListId>0014720899</priceListId>
  </pricelistassignmentlist>
</C1-DealPricelistAssignmentBS>

```

```

    <priceListInheritanceSw>Y</priceListInheritanceSw>
  </pricelistassignmentlist>
</C1-DealPricelistAssignmentBS>

```

Sample Deal Price List Assignment Delete Response in the XML Format

```

<C1-DealPricelistAssignmentBS>
  <dealId>7781868561</dealId>
  <modelId>1782818851</modelId>
  <pricelistassignmentlist>
    <entityId>0073281975</entityId>
    <entityType>PERS</entityType>
    <actionFlag>DEL</actionFlag>
    <priceListAssignmentId>1164917538</priceListAssignmentId>
    <startDate>2024-01-01</startDate>
    <endDate>2025-01-01</endDate>
    <priority>7</priority>
    <priceListId>0014720899</priceListId>
    <priceListInheritanceSw>Y</priceListInheritanceSw>
  </pricelistassignmentlist>
</C1-DealPricelistAssignmentBS>

```

Note: We have given the above request and response samples to illustrate how the tags should be nested while sending a deal price list assignment delete request from the external system. However, you should not seamlessly use this request sample in your environment because the required pre-requisite data may not be available in your environment. In such case, the system will give erroneous results.

Related Topics

For more information on...	See...
Deal price list assignment delete request and response tags in the XML format	Deal Price List Assignment Delete Request and Response - Tags in the XML Format on page 3811

Sample Deal Price List Assignment Update Request and Response in the XML Format

Using the below example, you can update the price list assignment for 0073281975 entity in 7781868561 deal.

Sample Deal Price List Assignment Update Request in the XML Format

```

<C1-DealPricelistAssignmentBS>
  <dealId>7781868561</dealId>
  <pricelistassignmentlist>
    <entityId>0073281975</entityId>
    <entityType>PERS</entityType>
    <actionFlag>UPD</actionFlag>
    <priceListAssignmentId>9884925490</priceListAssignmentId>
    <startDate>2024-01-01</startDate>
    <endDate>2025-01-01</endDate>
    <priority>6</priority>
    <priceListId>0014720899</priceListId>
    <priceListInheritanceSw>Y</priceListInheritanceSw>
  </pricelistassignmentlist>
</C1-DealPricelistAssignmentBS>

```

Note: If you do not want to enter the data in the list tags (i.e. tags where the type is set to list), you should not include them in the request. Adding empty list tags will give erroneous results.

Sample Deal Price List Assignment Update Response in the XML Format

```

<C1-DealPricelistAssignmentBS>
  <dealId>7781868561</dealId>
  <modelId>1782818851</modelId>

```

```

<pricelistassignmentlist>
  <entityId>0073281975</entityId>
  <entityType>PERS</entityType>
  <actionFlag>UPD</actionFlag>
  <priceListAssignmentId>9884925490</priceListAssignmentId>
  <startDate>2024-01-01</startDate>
  <endDate>2025-01-01</endDate>
  <priority>6</priority>
  <priceListId>0014720899</priceListId>
  <priceListInheritanceSw>Y</priceListInheritanceSw>
</pricelistassignmentlist>
</C1-DealPricelistAssignmentBS>

```

Note: We have given the above request and response samples to illustrate how the tags should be nested while sending a deal price list assignment update request from the external system. However, you should not seamlessly use this request sample in your environment because the required pre-requisite data may not be available in your environment. In such case, the system will give erroneous results.

Related Topics

For more information on...	See...
Deal price list assignment update request and response tags in the XML format	Deal Price List Assignment Update Request and Response - Tags in the XML Format on page 3813

Sample Deal Price List Assignment View Request and Response in the XML Format

Using the below example, you can view the price list assignment of 0710416227 price list assignment ID in 3336086427 deal.

Sample Deal Price List Assignment View Request in the XML Format

```

<C1-DealPricelistAssignmentBS>
  <dealId>3336086427</dealId>
  <actionFlag>READ</actionFlag>
  <priceListAssignmentId>0710416227</priceListAssignmentId>
</C1-DealPricelistAssignmentBS>

```

Sample Deal Price List Assignment View Response in the XML Format

```

<C1-DealPricelistAssignmentBS>
  <dealId>3336086427</dealId>
  <modelId>8729119397</modelId>
  <actionFlag>READ</actionFlag>
  <priceListAssignmentId>0710416227</priceListAssignmentId>
  <pricelistassignmentlist>
    <entityId>1600395396</entityId>
    <entityType>PERS</entityType>
    <priceListAssignmentId>0710416227</priceListAssignmentId>
    <startDate>2024-01-01</startDate>
    <endDate>2025-01-01</endDate>
    <priority>9</priority>
    <priceListId>0106513196</priceListId>
    <priceListAssignStatusFlag>PRPD</priceListAssignStatusFlag>
    <priceListInheritanceSw>N</priceListInheritanceSw>
  </pricelistassignmentlist>
</C1-DealPricelistAssignmentBS>

```

Note: We have given the above request and response samples to illustrate how the tags should be nested while sending a deal price list assignment view request from the external system. However, you should not seamlessly use this request sample in your environment because the required pre-requisite data may not be available in your environment. In such case, the system will give erroneous results.

Related Topics

For more information on...	See...
Deal price list assignment view request and response tags in the XML format	Deal Price List Assignment View Request and Response - Tags in the XML Format on page 3815

Deal Price List Assignment Add Request in the JSON Format

The following code snippet illustrates how the attribute/value pairs should be structured while receiving the deal price list assignment creation request in the JSON format:

```
{
  "Cl-DealPricelistAssignmentBS"
  {
    "dealIdentifier" : "",
    "dealId" : "",
    "modelId" : "",
    "pricelistassignmentlist"
    {
      "entityId" : "",
      "entityType" : "",
      "actionFlag" : "",
      "startDate" : "",
      "endDate" : "",
      "priority" : "",
      "priceListId" : "",
      "priceListInheritanceSw" : "",
    }
  }
}
```

Related Topics

For more information on...	See...
Deal price list assignment add request and response attribute/value pairs in the JSON format	Deal Price List Assignment Add Request and Response - Attribute/Value Pairs in the JSON Format on page 3826
Sample deal price list assignment add request and response in the JSON format	Sample Deal Price List Assignment Add Request and Response in the JSON Format on page 3834

Deal Price List Assignment Add Response in the JSON Format

The following code snippet illustrates how the attribute/value pairs should be structured while sending the deal price list assignment creation response in the JSON format:

```
{
  "Cl-DealPricelistAssignmentBS"
  {
    "dealIdentifier" : "",
    "dealId" : "",
    "modelId" : "",
    "priceListAssignmentId" : "",
    "pricelistassignmentlist"
    {
      "entityId" : "",
      "entityType" : "",
      "actionFlag" : "",
    }
  }
}
```

```

    "priceListAssignmentId" : "",
    "startDate" : "",
    "endDate" : "",
    "priority" : "",
    "priceListId" : "",
    "priceListAssignStatusFlag" : "",
    "priceListInheritanceSw" : "",
  }
}

```

Related Topics

For more information on...	See...
Deal price list assignment add request and response attribute/value pairs in the JSON format	Deal Price List Assignment Add Request and Response - Attribute/Value Pairs in the JSON Format on page 3826
Sample deal price list assignment add request and response in the JSON format	Sample Deal Price List Assignment Add Request and Response in the JSON Format on page 3834

Deal Price List Assignment Delete Request in the JSON Format

The following code snippet illustrates how the attribute/value pairs should be structured while receiving the deal price list assignment delete request in the JSON format:

```

{
  "Cl-DealPricelistAssignmentBS"
  {
    "dealIdentifier" : "",
    "dealId" : "",
    "modelId" : "",
    "pricelistassignmentlist"
    {
      "entityId" : "",
      "entityType" : "",
      "actionFlag" : "",
      "priceListAssignmentId" : "",
      "startDate" : "",
      "endDate" : "",
      "priority" : "",
      "priceListId" : "",
      "priceListInheritanceSw" : "",
    }
  }
}

```

Related Topics

For more information on...	See...
Deal price list assignment delete request and response attribute/value pairs in the JSON format	Deal Price List Assignment Delete Request and Response - Attribute/Value Pairs in the JSON Format on page 3828
Sample deal price list assignment delete request and response in the JSON format	Sample Deal Price List Assignment Delete Request and Response in the JSON Format on page 3835

Deal Price List Assignment Delete Response in the JSON Format

The following code snippet illustrates how the attribute/value pairs should be structured while sending the deal price list assignment delete response in the JSON format:

```
{
  "Cl-DealPricelistAssignmentBS"
  {
    "dealIdentifier" : "",
    "dealId" : "",
    "modelId" : "",
    "pricelistassignmentlist"
    {
      "entityId" : "",
      "entityType" : "",
      "actionFlag" : "",
      "priceListAssignmentId" : "",
      "startDate: : " ",
      "endDate" : "",
      "priority" : "",
      "priceListId" : "",
      "priceListInheritanceSw" : "",
    }
  }
}
```

Related Topics

For more information on...	See...
Deal price list assignment delete request and response attribute/value pairs in the JSON format	Deal Price List Assignment Delete Request and Response - Attribute/Value Pairs in the JSON Format on page 3828
Sample deal price list assignment delete request and response in the JSON format	Sample Deal Price List Assignment Delete Request and Response in the JSON Format on page 3835

Deal Price List Assignment Update Request in the JSON Format

The following code snippet illustrates how the attribute/value pairs are structured while receiving the deal price list assignment update request in the JSON format:

```
{
  "Cl-DealPricelistAssignmentBS"
  {
    "dealIdentifier" : "",
    "dealId" : "",
    "modelId" : "",
    "pricelistassignmentlist"
    {
      "entityId" : "",
      "entityType" : "",
      "actionFlag" : "",
      "priceListAssignmentId" : "",
      "startDate: : " ",
      "endDate" : "",
      "priority" : "",
      "priceListId" : "",
      "priceListInheritanceSw" : "",
    }
  }
}
```

Related Topics

For more information on...	See...
Deal price list assignment update request and response attribute/value pairs in the JSON format	Deal Price List Assignment Update Request and Response - Attribute/Value Pairs in the JSON Format on page 3829
Sample deal price list assignment update request and response in the JSON format	Sample Deal Price List Assignment Update Request and Response in the JSON Format on page 3836

Deal Price List Assignment Update Response in the JSON Format

The following code snippet illustrates how the attribute/value pairs are structured while sending the deal price list assignment update response in the JSON format:

```
{
  "C1-DealPricelistAssignmentBS"
  {
    "dealIdentifier" : "",
    "dealId" : "",
    "modelId" : "",
    "actionFlag" : "",
    "pricelistassignmentlist"
    {
      "entityId" : "",
      "entityType" : "",
      "actionFlag" : "",
      "priceListAssignmentId" : "",
      "startDate" : "",
      "endDate" : "",
      "priority" : "",
      "priceListId" : "",
      "priceListInheritanceSw" : "",
    }
  }
}
```

Related Topics

For more information on...	See...
Deal price list assignment update request and response attribute/value pairs in the JSON format	Deal Price List Assignment Update Request and Response - Attribute/Value Pairs in the JSON Format on page 3829
Sample deal price list assignment update request and response in the JSON format	Sample Deal Price List Assignment Update Request and Response in the JSON Format on page 3836

Deal Price List Assignment View Request in the JSON Format

The following code snippet illustrates how the attribute/value pairs should be structured while receiving the deal price list assignment view request in the JSON format:

```
{
  "C1-DealPricelistAssignmentBS"
  {
    "dealIdentifier" : "",
    "dealId" : "",
    "modelId" : "",
  }
}
```

```

    "actionFlag" : "",
    "entityId" : "",
    "entityType" : "",
    "priceListAssignmentId" : "",
  }
}

```

Related Topics

For more information on...	See...
Deal price list assignment view request and response attribute/value pairs in the JSON format	Deal Price List Assignment View Request and Response - Attribute/Value Pairs in the JSON Format on page 3832
Sample Deal Price List Assignment View Request and Response in the JSON Format	Sample Deal Price List Assignment View Request and Response in the JSON Format on page 3837

Deal Price List Assignment View Response in the JSON Format

The following code snippet illustrates how the attribute/value pairs should be structured while sending the deal price list assignment view response in the JSON format:

```

{
  "Cl-DealPricelistAssignmentBS"
  {
    "dealIdentifier" : "",
    "dealId" : "",
    "modelId" : "",
    "actionFlag" : "",
    "entityId" : "",
    "entityType" : "",
    "priceListAssignmentId" : "",
    "pricelistassignmentlist"
    {
      "entityId" : "",
      "entityType" : "",
      "actionFlag" : "",
      "priceListAssignmentId" : "",
      "startDate" : "",
      "endDate" : "",
      "priority" : "",
      "priceListId" : "",
      "priceListAssignStatusFlag" : "",
      "priceListInheritanceSw" : "",
    }
  }
}

```

Related Topics

For more information on...	See...
Deal price list assignment view request and response attribute/value pairs in the JSON format	Deal Price List Assignment View Request and Response - Attribute/Value Pairs in the JSON Format on page 3832
Sample deal price list assignment view request and response in the JSON format	Sample Deal Price List Assignment View Request and Response in the JSON Format on page 3837

Deal Price List Assignment Add Request and Response - Attribute/Value Pairs in the JSON Format

Note: We recommend you to refer the topics [Deal Price List Assignment Add Request in the JSON Format](#) on page 3821 and [Deal Price List Assignment Add Response in the JSON Format](#) on page 3821 in parallel while understanding the below mentioned attributes. This will help you to understand how the attributes are nested in the JSON format.

Before calling the **C1-DealPricelistAssignmentBS** business service through an inbound web service, you need to ensure that the deal price list assignment add request contains the following attributes:

Attribute Name	Attribute Description	Mandatory (Yes or No)
dealIdentifier	Used to assign price list to the entity (i.e. existing or prospect person or account) in the entity hierarchy of a deal which is created using a particular deal identifier.	Yes (Conditional) Note: This data is required if you do not specify the dealID or modelID attributes.
dealId	Used to specify the deal for which you want to add the price list assignment.	Yes (Conditional) Note: This data is required if you do not specify the dealIdentifier or modelID attributes.
modelId	Used to specify the deal version for which you want to add the price list assignment.	Yes (Conditional) Note: This data is required if you do not specify the dealIdentifier or dealID attributes.
pricelistassignmentlist	Used to assign the price list to the entities (i.e. existing or prospect person or account) in the entity hierarchy of the deal.	Yes
entityId	Used to specify the entity (i.e. existing or prospect person or account) to which you want to assign the price list.	Yes
entityType	Used to indicate the type of the entity to which you want to assign the price list. The valid values are: <ul style="list-style-type: none"> • PERS • ACCT 	Yes
actionFlag	Used to indicate that you want to create request to add the price list assignment. The valid value is: <ul style="list-style-type: none"> • ADD Note: If you do not specify the value in this attribute, the system considers it as an Add action.	Yes

Attribute Name	Attribute Description	Mandatory (Yes or No)
startDate	<p>Used to specify the date from when the price list assignment is effective for the entity (i.e. existing or prospect person or account).</p> <p>Note:</p> <p>The price list assignment start date must be equal to the deal start date.</p> <p>The price list assignment start date cannot be later than the price list assignment end date.</p> <p>If you do not specify the value in this tag, the system considers the deal start date as the price list assignment start date.</p>	No
endDate	<p>Used to specify the date till when the price list assignment is effective for the entity (i.e. existing or prospect person or account).</p> <p>Note:</p> <p>The price list assignment end date cannot be later than the deal end date.</p> <p>The price list assignment end date cannot be earlier than the price list assignment start date.</p>	No
priority	<p>Used to specify the priority in which the price list should be considered to determine the price item pricing.</p> <p>Note:</p> <p>The priority of the price list assignment must be greater than zero.</p> <p>You cannot have same priority for price list assignments having the same effective start date and end date.</p>	Yes
priceListId	Used to specify the price list that you want to assign to the entity (i.e. existing or prospect person or account).	Yes
priceListInheritanceSw	<p>Used to indicate whether the price item pricing is inherited from the parent price list hierarchy defined for the price list which is assigned to the entity (i.e. existing or prospect person or account). The valid values are:</p> <ul style="list-style-type: none"> • Y • N <p>Note: If you do not specify the value in this attribute, the system considers it as N.</p>	No

Once the price list assignment is created, all the details of price list assignment are listed in the above mentioned attributes along with the following attribute:

Attribute Name	Attribute Description
priceListAssignmentId	Displays the price list assignment ID. Note: A new price list assignment ID is generated by the system when you create a request to add a price list assignment.

Related Topics

For more information on...	See...
Sample deal price list assignment add request and response in the JSON format	Sample Deal Price List Assignment Add Request and Response in the JSON Format on page 3834

Deal Price List Assignment Delete Request and Response - Attribute/Value Pairs in the JSON Format

Note: We recommend you to refer the topics [Deal Price List Assignment Delete Request in the JSON Format](#) on page 3822 and [Deal Price List Assignment Delete Response in the JSON Format](#) on page 3822 in parallel while understanding the below mentioned attributes. This will help you to understand how the attributes are nested in the JSON format.

Before calling the **C1-DealPricelistAssignmentBS** business service through an inbound web service, you need to ensure that the deal price list assignment delete request contains the following attributes:

Attribute Name	Attribute Description	Mandatory (Yes or No)
dealIdentifier	Used to delete the price list assignment of an entity (i.e. existing or prospect person or account) in the entity hierarchy of a deal which is created using a particular deal identifier.	Yes (Conditional) Note: This data is required if you do not specify the dealID or modelID attributes.
dealId	Used to specify the deal whose entities (i.e. existing or prospect person or account) price list assignment you want to delete.	Yes (Conditional) Note: This data is required if you do not specify the dealIdentifier or modelID attributes.
modelId	Used to specify the deal version whose entities (i.e. existing or prospect person or account) price list assignment you want to delete.	Yes (Conditional) Note: This data is required if you do not specify the dealIdentifier or dealID attributes.
pricelistassignmentlist	Used to specify a list of price list assignments of the entities (i.e. existing or prospect person or account) in the entity hierarchy of a deal that you want to delete.	Yes
entityId	Used to specify the entity (i.e. existing or prospect person or account) whose price list assignment you want to delete.	Yes

Attribute Name	Attribute Description	Mandatory (Yes or No)
entityType	Used to indicate the entity type of the entity for which you want to delete the price list assignment. The valid values are: <ul style="list-style-type: none"> • PERS • ACCT 	Yes
actionFlag	Used to indicate that you want to create a request to delete the price list assignment. The valid value is: <ul style="list-style-type: none"> • DEL <p>Note: If you do not specify the value in this attribute, the system considers it as an Add action.</p>	Yes
priceListAssignmentId	Used to specify the price list assignment which you want to delete.	Yes
startDate	Used to specify the date from when the price list assignment is effective for the entity.	No
endDate	Used to specify the date till when the price list assignment is effective for the entity (i.e. existing or prospect person or account).	No
priority	Used to specify the priority in which the price list is considered to determine the price item pricing.	No
priceListId	Used to specify the price list that you want to delete from the entity (i.e. existing or prospect person or account).	No
priceListInheritanceSw	Used to indicate whether the price item pricing is inherited from the parent price list hierarchy defined for the price list which is assigned to the entity (i.e. existing or prospect person or account). The valid values are: <ul style="list-style-type: none"> • Y • N 	No

Once the price list assignment is deleted, all the details of price list assignment are listed in the above mentioned attributes.

Related Topics

For more information on...	See...
Sample deal price list assignment delete request and response in the JSON format	Sample Deal Price List Assignment Delete Request and Response in the JSON Format on page 3835

Deal Price List Assignment Update Request and Response - Attribute/Value Pairs in the JSON Format

Note: We recommend you to refer the topics [Deal Price List Assignment Update Request in the JSON Format](#) on page 3823 and [Deal Price List Assignment Update Response in the JSON Format](#) on page 3824 in parallel while understanding the below mentioned attributes. This will help you to understand how the attributes are nested in the JSON format.

Before calling the **C1-DealPricelistAssignmentBS** business service through an inbound web service, you need to ensure that the deal price list assignment update request contains the following attributes:

Attribute Name	Attribute Description	Mandatory (Yes or No)
dealIdentifier	Used to update the price list assignment of an entity (i.e. existing or prospect person or account) in the entity hierarchy of a deal which is created using a particular deal identifier.	Yes (Conditional) Note: This data is required if you do not specify the dealID or modelID attributes.
dealId	Used to specify the deal for which you want to update the price list assignment.	Yes (Conditional) Note: This data is required if you do not specify the dealIdentifier or modelID attributes.
modelId	Used to specify the deal version for which you want to update the price list assignment.	Yes (Conditional) Note: This data is required if you do not specify the dealIdentifier or dealID attributes.
pricelistassignmentlist	Used to update the price list assignment of the entities (i.e. existing or prospect person or account) in the entity hierarchy of the deal.	Yes
entityId	Used to specify the entity (i.e. existing or prospect person or account) whose price list assignment you want to update.	Yes
entityType	Used to indicate the type of the entity whose price list assignment you want to update. The valid values are: <ul style="list-style-type: none"> PERS ACCT 	Yes
actionFlag	Used to indicate that you want to create a request to update the price list assignment. The valid value is: <ul style="list-style-type: none"> UPD Note: If you do not specify the value in this attribute, the system considers it as an Add action.	Yes
priceListAssignmentId	Used to specify the price list assignment which you want to update.	Yes

Attribute Name	Attribute Description	Mandatory (Yes or No)
startDate	<p>Used to specify the date from when the price list assignment is effective for the entity (i.e. existing or prospect person or account).</p> <p>Note:</p> <p>The price list assignment start date must be equal to the deal start date.</p> <p>The price list assignment start date cannot be later than the price list assignment end date.</p> <p>If you do not specify the value in this tag, the system considers the deal start date as the price list assignment start date.</p>	Yes
endDate	<p>Used to specify the date till when the price list assignment is effective for the entity (i.e. existing or prospect person or account).</p> <p>Note:</p> <p>The price list assignment end date cannot be later than the deal end date.</p> <p>The price list assignment end date cannot be earlier than the price list assignment start date.</p>	Yes
priority	<p>Used to specify the priority in which the price list is considered to determine the price item pricing.</p> <p>Note:</p> <p>The priority of the price list assignment must be greater than zero.</p> <p>You cannot have same priority for price list assignments having the same effective start date and end date.</p>	Yes
priceListId	Used to specify the price list that you want to assign to the entity (i.e. existing or prospect person or account).	Yes
priceListInheritanceSw	<p>Used to indicate whether the price item pricing is inherited from the parent price list hierarchy defined for the price list which is assigned to the entity (i.e. existing or prospect person or account). The valid values are:</p> <ul style="list-style-type: none"> • Y • N <p>Note: If you do not specify the value in this attribute, the system considers it as N.</p>	Yes

Note: When you create a request to update a price list assignment, the system replaces the price list assignment data instead of editing it. Therefore, you should provide all details of the price list assignment including the data that you want to change.

Once the deal price list assignment is updated, all the details of deal price list assignment are listed in the above mentioned attributes.

Related Topics

For more information on...	See...
Sample deal price list assignment update request and response in the JSON format	Sample Deal Price List Assignment Update Request and Response in the JSON Format on page 3836

Deal Price List Assignment View Request and Response - Attribute/Value Pairs in the JSON Format

Note: We recommend you to refer the topics [Deal Price List Assignment View Request in the JSON Format](#) on page 3824 and [Deal Price List Assignment View Response in the JSON Format](#) on page 3825 in parallel while understanding the below mentioned attributes. This will help you to understand how the attributes are structured in the JSON format.

Before calling the **C1-DealPricelistAssignmentBS** business service through an inbound web service, you need to ensure that the deal price list assignment view request contains the following attributes:

Attribute Name	Attribute Description	Mandatory (Yes or No)
actionFlag	Used to indicate that you want to view the price list assignments of all the entities (i.e. existing or prospect person or account) in the entity hierarchy of the deal. The valid value is: <ul style="list-style-type: none"> • READ 	Yes (Conditional)
	Note: If you do not specify the value in this attribute, the system considers the value provided in the actionFlag attribute of the pricelistassignmentlist attribute.	Note: This data is required if the actionFlag attribute is not specified in the pricelistassignmentlist attribute.
dealIdentifier	Used to view the price list of the entities (i.e. existing or prospect person or account) in the entity hierarchy of a deal which is created using a particular deal identifier.	Yes (Conditional)
		Note: This data is required if you do not specify the dealID or modelID attributes.
dealId	Used to specify the deal whose entities (i.e. existing or prospect person or account) price list assignment you want to view.	Yes (Conditional)
		Note: This data is required if you do not specify the dealIdentifier or modelID attributes.
modelID	Used to specify the deal version whose entities (i.e. existing or prospect person or account) price list assignment you want to view.	Yes (Conditional)
		Note: This data is required if you do not specify the dealIdentifier or dealID attributes.

Attribute Name	Attribute Description	Mandatory (Yes or No)
entityId	Used to specify the entity (i.e. existing or prospect person or account) in the entity hierarchy of the deal whose price list assignment you want to view.	No
entityType	Used to indicate the type of the entity whose price list assignment you want to view. The valid values are: <ul style="list-style-type: none"> PERS ACCT 	Yes (Conditional)
	Note: If you specify the entityId attribute, you need to specify the entityType attribute.	Note: This data is required for viewing the price list assignments of a particular entity in the entity hierarchy of a deal.
priceListAssignmentId	Used to specify the price list assignment whose details you want to view.	Yes

Once the price list assignment view request is created, all the details of price list assignment are listed in the above mentioned attributes along with the following attributes:

Attribute Name	Attribute Description
pricelistassignmentlist	Lists the price list assignments of the entities (i.e. existing or prospect person or account) in the entity hierarchy of the deal.
entityId	Displays the entity (i.e. existing or prospect person or account) in the entity hierarchy of the deal.
entityType	Indicates the type of the entity. The valid values are: <ul style="list-style-type: none"> PERS ACCT
actionFlag	Indicates the action performed for viewing the price list assignment of the entity (i.e. existing or prospect person or account). The valid value is: <ul style="list-style-type: none"> READ
priceListAssignmentId	Displays the price list assignment ID.
startDate	Displays date from when the price list assignment is effective for the entity.
endDate	Displays the date till when the price list assignment is effective for the entity.
priority	Displays the priority in which the price list is considered to determine the price item pricing.
priceListId	Displays the price list that is assigned to the entity (i.e. existing or prospect person or account).
priceListAssignStatusFlag	Indicates the current status of the price list assignment. The valid values are: <ul style="list-style-type: none"> Active Proposed Inactive Rejected

Attribute Name	Attribute Description
priceListInheritanceSw	Indicates whether the price item pricing is inherited from the parent price list hierarchy defined for the price list which is assigned to the entity (i.e. existing or prospect person or account). The valid values are: <ul style="list-style-type: none"> • Y • N

Related Topics

For more information on...	See...
Sample deal price list assignment view request and response in the JSON format	Sample Deal Price List Assignment View Request and Response in the JSON Format on page 3837

Sample Deal Price List Assignment Add Request and Response in the JSON Format

Using the below example, you can create the price list assignment for 1600395396 entity in 3336086427 deal.

Sample Deal Price List Assignment Creation Request in the JSON Format

```
{
  "C1-DealPricelistAssignmentBS"
  {
    "dealIdentifier" : "3336086427",
    "pricelistassignmentlist"
    {
      "entityId" : "1600395396",
      "entityType" : "PERS",
      "actionFlag" : "ADD",
      "startDate" : "2024-01-01",
      "endDate" : "2025-01-01",
      "priority" : "9",
      "priceListId" : "0106513196",
      "priceListInheritanceSw" : "N",
    }
  }
}
```

Note: If you do not want to enter the data in the list attributes (i.e. attributes where the type is set to list), you should not include them in the request. Adding empty list attributes will give erroneous results.

Sample Deal Price List Assignment Creation Response in the JSON Format

```
{
  "C1-DealPricelistAssignmentBS"
  {
    "dealIdentifier" : "3336086427",
    {
      "entityId" : "1600395396",
      "entityType" : "PERS",
      "actionFlag" : "ADD",
      "priceListAssignmentId" : "0710416227",
      "startDate" : "2024-01-01",
      "endDate" : "2025-01-01",
      "priority" : "9",
      "priceListId" : "0106513196",
      "priceListInheritanceSw" : "N",
    }
  }
}
```

```

}
}

```

Note: We have given the above request and response samples to illustrate how the attribute value pairs should be structured while sending a deal price list assignment add request from the external system. However, you should not seamlessly use this request sample in your environment because the required pre-requisite data may not be available in your environment. In such case, the system will give erroneous results.

Related Topics

For more information on...	See...
Deal price list assignment add request and response attribute/value pairs in the JSON format	Deal Price List Assignment Add Request and Response - Attribute/Value Pairs in the JSON Format on page 3826

Sample Deal Price List Assignment Delete Request and Response in the JSON Format

Using the below example, you can delete the price list assignment of 0073281975 entity in 7781868561 deal.

Sample Deal Price List Assignment Delete Request in the JSON Format

```

{
  "C1-DealPricelistAssignmentBS"
  {
    "dealIdentifier" : "7781868561",
    "pricelistassignmentlist"
    {
      "entityId" : "0073281975",
      "entityType" : "PERS",
      "actionFlag" : "DEL",
      "priceListAssignmentId" : "1164917538",
      "startDate" : "2024-01-01",
      "endDate" : "2025-01-01",
      "priority" : "7",
      "priceListId" : "0014720899",
      "priceListInheritanceSw" : "Y",
    }
  }
}

```

Sample Deal Price List Assignment Delete Response in the JSON Format

```

{
  "C1-DealPricelistAssignmentBS"
  {
    "dealIdentifier" : "7781868561",
    "pricelistassignmentlist"
    {
      "entityId" : "0073281975",
      "entityType" : "PERS",
      "actionFlag" : "DEL",
      "priceListAssignmentId" : "1164917538",
      "startDate" : "2024-01-01",
      "endDate" : "2025-01-01",
      "priority" : "7",
      "priceListId" : "0014720899",
      "priceListInheritanceSw" : "Y",
    }
  }
}

```

Note: We have given the above request and response samples to illustrate how the attribute value pairs should be structured while sending a deal price list assignment delete request from the external system. However, you should not seamlessly use this request sample in your environment because the required pre-requisite data may not be available in your environment. In such case, the system will give erroneous results.

Related Topics

For more information on...	See...
Deal price list assignment delete request and response attribute/value pairs in the JSON format	Deal Price List Assignment Delete Request and Response - Attribute/Value Pairs in the JSON Format on page 3828

Sample Deal Price List Assignment Update Request and Response in the JSON Format

Using the below example, you can update the price list assignment for 0073281975 entity in 7781868561 deal.

Sample Deal Price List Assignment Update Request in the JSON Format

```
{
  "C1-DealPricelistAssignmentBS"
  {
    "dealIdentifier" : "7781868561",
    "pricelistassignmentlist"
    {
      "entityId" : "0073281975",
      "entityType" : "PERS",
      "actionFlag" : "UPD",
      "priceListAssignmentId" : "9884925490",
      "startDate" : "2024-01-01",
      "endDate" : "2025-01-01",
      "priority" : "6",
      "priceListId" : "0014720899",
      "priceListInheritanceSw" : "Y",
    }
  }
}
```

Note: If you do not want to enter the data in the list attributes (i.e. attributes where the type is set to list), you should not include them in the request. Adding empty list attributes will give erroneous results.

Sample Deal Price List Assignment Update Response in the JSON Format

```
{
  "C1-DealPricelistAssignmentBS"
  {
    "dealIdentifier" : "7781868561",
    "pricelistassignmentlist"
    {
      "entityId" : "0073281975",
      "entityType" : "PERS",
      "actionFlag" : "UPD",
      "priceListAssignmentId" : "9884925490",
      "startDate" : "2024-01-01",
      "endDate" : "2025-01-01",
      "priority" : "6",
      "priceListId" : "0014720899",
      "priceListInheritanceSw" : "Y",
    }
  }
}
```

}

Note: We have given the above request and response samples to illustrate how the attribute value pairs should be structured while sending a deal price list assignment update request from the external system. However, you should not seamlessly use this request sample in your environment because the required pre-requisite data may not be available in your environment. In such case, the system will give erroneous results.

Related Topics

For more information on...	See...
Deal price list assignment update request and response attribute/value pairs in the JSON format	Deal Price List Assignment Update Request and Response - Attribute/Value Pairs in the JSON Format on page 3829

Sample Deal Price List Assignment View Request and Response in the JSON Format

Using the below example, you can view the price list assignment of 0710416227 price list assignment ID in 3336086427 deal.

Sample Deal Price List Assignment View Request in the JSON Format

```
{
  "C1-DealPricelistAssignmentBS"
  {
    "dealIdentifier" : "3336086427",
    "actionFlag" : "READ",
    "entityId" : "1278130724",
    "entityType" : "Entity_NM",
    "priceListAssignmentId" : "0710416227",
  }
}
```

Sample Deal Price List Assignment View Response in the JSON Format

```
{
  "C1-DealPricelistAssignmentBS"
  {
    "dealIdentifier" : "3336086427",
    "actionFlag" : "READ",
    "entityId" : "1278130724",
    "entityType" : "Entity_NM",
    "priceListAssignmentId" : "0710416227",
    "pricelistassignmentlist"
    {
      "entityId" : "1600395396",
      "entityType" : "PERS",
      "actionFlag" : "READ",
      "priceListAssignmentId" : "0710416227",
      "startDate" : "2024-01-01",
      "endDate" : "2025-01-01",
      "priority" : "9",
      "priceListId" : "0106513196",
      "priceListAssignStatusFlag" : "PRPD",
      "priceListInheritanceSw" : "Y",
    }
  }
}
```

Note: We have given the above request and response samples to illustrate how the attribute value pairs should be structured while sending a deal price list assignment view request from the external system. However, you should not seamlessly use this request sample in your environment because the required pre-requisite data may not be available in your environment. In such case, the system will give erroneous results.

Related Topics

For more information on...	See...
Deal price list assignment view request and response attribute/value pairs in the JSON format	Deal Price List Assignment View Request and Response - Attribute/Value Pairs in the JSON Format on page 3832

Deal Price Assignments and Commitments through Inbound Web Service

Oracle Revenue Management and Billing enables you to override, edit, recommend, and delete a price item pricing of an entity in a deal through a web service. It also enables you to add or update the commitments of a price item and pricing parameters combination in a deal through a web service. In addition, it enables you to view the pricing and commitment details of a deal through a web service.

You can send a request from the external system to do the following through an inbound web service:

- Override a price item pricing of an existing or prospect customer or account in a deal
- Edit or delete a price item pricing of a deal
- Recommend a price item pricing for an existing or prospect customer or account in a deal
- Add or edit commitments of a price item and pricing parameters combination
- View the price item pricing and commitments details of a deal

At a time, you can send a request either for viewing the pricing and/or commitments details of all or particular entity in a deal, or for creating, updating, recommending, and/or deleting one or more pricing of a deal and/or for adding or editing commitments of one or more price item and pricing parameters combinations in a deal. We have shipped the following two inbound web services in this release:

- **C1-DealPriceAsgnCommitments** - This is a SOAP based web service. You can use this web service when you want to send the above requests with respect to pricing and commitments in the XML format.
- **C1-DealPriceAsgnCommitmentsREST** - This is a REST based web service. You can use this web service when you want to send the above requests with respect to pricing and commitments in the XML or JSON format.

Both these inbound web services call the **C1-DealPriceAsgnCommitmentBS** business service. This business service is used to do the following:

- **Override a price item pricing of an existing or prospect customer or account in a deal** - While overriding a price item pricing of a customer or an account in a deal, you need to:
 - Specify the deal version ID or deal ID or deal identifier to determine the deal version in which you want to override the pricing of an entity
 - Specify the entity (i.e. person or account) whose pricing you want override and thereby create an agreed pricing
 - Specify the price assignment ID
 - Specify the pricing details including pricing parameters, characteristics, and flat and tiered price components
 - Specify the tiering criteria and eligibility for the required price components
 - Set the action flag to **OVRD**

On processing the request, the system creates an agreed pricing for the entity in the deal in the **Proposed** status.

- **Edit a price item pricing of a deal** - While editing a price item pricing of an entity in a deal, you need to:
 - Specify the deal version ID or deal ID or deal identifier to determine the deal version whose proposed pricing you want to edit
 - Specify the entity (i.e. person or account) whose pricing you want edit
 - Specify the price assignment ID
 - Set the action flag to **UPD**

During the update operation, the system replaces the pricing data instead of editing it. Therefore, you should provide all details of the pricing including the data that you want to change.

- **Delete a price item pricing of a deal** - While deleting a price item pricing of an entity in a deal, you need to:
 - Specify the deal version ID or deal ID or deal identifier to determine the deal version whose proposed pricing you want to delete
 - Specify the entity (i.e. person or account) whose pricing you want to delete
 - Specify the price assignment ID
 - Set the action flag to **DEL**

On processing the request, the system deletes the proposed pricing of the entity from the deal.

- **Recommend a price item pricing for an existing or prospect customer or account in a deal** - While recommending a price item pricing for an entity in a deal, you need to:
 - Specify the deal version ID or deal ID or deal identifier to determine the deal version in which you want to recommend pricing for an entity
 - Specify the entity (i.e. person or account) for whom you want to recommend a pricing
 - Specify the price assignment ID
 - Set the action flag to **RECM**

During the update operation, the system replaces the pricing data instead of editing it. Therefore, you should provide all details of the pricing including the data that you want to change.

- **Add commitments for a price item pricing** - While adding commitments for a pricing in a deal, you need to:
 - Specify the deal version ID or deal ID or deal identifier to determine the deal version in which you want to add commitments for the price item and pricing parameters combination
 - Specify the entity (i.e. person or account) for whom you want to add commitments
 - Specify the price item and pricing parameters combination for which you want to add commitments
 - Specify the commitments for the SQIs
 - Set the action flag to **ADD**

On processing the request, the system adds commitments for the price item and pricing parameters combination in the deal in the **Proposed** status.

- **Edit commitments of a price item pricing** - While editing commitments of a price item and pricing parameters combination in a deal, you need to:
 - Specify the deal version ID or deal ID or deal identifier to determine the deal version whose proposed commitments you want to edit
 - Specify the entity (i.e. person or account) whose commitments you want to edit
 - Specify the price item and pricing parameters combination whose commitments you want to edit
 - Set the action flag to **UPD**

During the update operation, the system replaces the commitment data instead of editing it. Therefore, you should provide all commitment details including the data that you want to change.

- **View the price item pricing and/or commitments details** - While viewing the pricing and/or commitment details of a deal, you need to:
 - Specify the deal version ID or deal ID or deal identifier to determine the deal version whose pricing and commitment details you want to view
 - Set the action flag to **READ**

On processing the request, the system then displays the pricing and commitment details of all customers and accounts in the deal version. You can also view the pricing and commitment details of a particular entity in the deal version. In addition, you can opt to view either pricing or commitment details or both pricing and commitment details of a deal version. If you want to view the pricing details of a deal version, you must set the inquiry mode to **PRIC**. If you want to view the commitment details of a deal version, you must set the inquiry mode to **COMT**. And, if you want to view both the pricing and commitment details of a deal version, you must set the inquiry mode to **BOTH**. Note that the system displays all active, proposed, and recommended price item pricing of the entities and all active and proposed commitments of the price item and parameters combination in the response.

If both the deal version and deal ID or deal identifier are given in the request, the system considers the deal version. However, if only the deal ID or deal identifier is given in the request, the system derives the deal version. Note that an error occurs when the given deal has multiple deal versions. The system allows you to override, edit, delete, or recommend pricing and/or add or edit commitments for multiple entities of a deal in the same request. For more information about the Deal Management functionality, refer to *Oracle Revenue Management and Billing Banking User Guide*.

Deal Price Assignment Override Request in the XML Format

The following code snippet illustrates how the tags should be nested while sending the deal price assignment override request in the XML format.

```
<C1-DealPriceAsgnCommitmentBS>
  <dealIdentifier></dealIdentifier>
  <dealId></dealId>
  <modelId></modelId>
  <inquiryModeFlag></inquiryModeFlag>
  <pricingcmntmntdtls>
    <entityId></entityId>
    <entityType></entityType>
    <pricingdtls>
      <priceAsgnId></priceAsgnId>
      <actionFlag></actionFlag>
      <priceItemCode></priceItemCode>
      <priceStatusFlag></priceStatusFlag>
      <priceCurrencyCode></priceCurrencyCode>
      <rateSchedule></rateSchedule>
      <startDate></startDate>
      <endDate></endDate>
      <isEligible></isEligible>
      <paTypeFlag></paTypeFlag>
      <printIfZero></printIfZero>
      <priceasgnchar>
        <characteristicType></characteristicType>
        <effectiveDate></effectiveDate>
        <characteristicValue></characteristicValue>
      </priceasgnchar>
      <priceasgnparm>
        <priceParmCode></priceParmCode>
        <priceParmVal></priceParmVal>
      </priceasgnparm>
    </pricingdtls>
  </pricingcmntmntdtls>
  <txnDailyRatingCrt></txnDailyRatingCrt>
</C1-DealPriceAsgnCommitmentBS>
```

```

<ignoreSw></ignoreSw>
<doNotAggSw></doNotAggSw>
<scheduleCode></scheduleCode>
<pricecompdtls>
  <priceCompTier>
    <toVal></toVal>
    <fromVal></fromVal>
    <priceCriteria></priceCriteria>
    <tieSeqNum></tieSeqNum>
    <priceparm>
      <parmCodeType></parmCodeType>
      <priceParmCode></priceParmCode>
    </priceparm>
  </priceCompTier>
  <priceCompElg>
    <rhsPriceParmCd></rhsPriceParmCd>
    <rhsPriceParmVal></rhsPriceParmVal>
    <lhsPriceParmCd></lhsPriceParmCd>
    <rhsPriceParmTypeFlg></rhsPriceParmTypeFlg>
    <isInsufficientFlg></isInsufficientFlg>
    <isFalseFlg></isFalseFlg>
    <isTrueFlg></isTrueFlg>
    <operator></operator>
    <sequenceNumber></sequenceNumber>
  </priceCompElg>
  <priceCompSequenceNo></priceCompSequenceNo>
  <priceCompDesc></priceCompDesc>
  <valueAmt></valueAmt>
  <priceComponentDisplay></priceComponentDisplay>
  <rcMapId></rcMapId>
  <tieredFlag></tieredFlag>
</pricecompdtls>
</pricingdtls>
</pricingcmtmntdtls>
</C1-DealPriceAsgnCommitmentBS>

```

Related Topics

For more information on...	See...
Deal price assignment override request and response tags in the XML format	Deal Price Assignment Override Request and Response - Tags in the XML Format on page 3854
Sample deal price assignment override request and response in the XML format	Sample Deal Price Assignment Override Request and Response in the XML Format on page 3891

Deal Price Assignment Override Response in the XML Format

The following code snippet illustrates how the tags are nested while receiving the deal price assignment override response in the XML Format.

```

<C1-DealPriceAsgnCommitmentBS>
  <dealIdentifier></dealIdentifier>
  <dealId></dealId>
  <modelId></modelId>
  <inquiryModeFlag></inquiryModeFlag>
  <pricingcmtmntdtls>
    <entityId></entityId>
    <entityType></entityType>
    <entityIdentifierValue></entityIdentifierValue>
    <entityIdentifierType></entityIdentifierType>
    <entityDivision></entityDivision>
  </pricingdtls>

```

```

<priceAsgnId></priceAsgnId>
<actionFlag></actionFlag>
<priceItemCode></priceItemCode>
<priceItemDescription></priceItemDescription>
<hierarchyDetails></hierarchyDetails>
<priceStatusFlag></priceStatusFlag>
<priceCurrencyCode></priceCurrencyCode>
<rateSchedule></rateSchedule>
<startDate></startDate>
<endDate></endDate>
<isEligible></isEligible>
<assignmentLevel></assignmentLevel>
<paTypeFlag></paTypeFlag>
<printIfZero></printIfZero>
<priceasgnchar>
  <characteristicType></characteristicType>
  <effectiveDate></effectiveDate>
  <characteristicValue></characteristicValue>
</priceasgnchar>
<priceasgnparm>
  <priceParmCode></priceParmCode>
  <priceParmVal></priceParmVal>
</priceasgnparm>
<txnDailyRatingCrt></txnDailyRatingCrt>
<ignoreSw></ignoreSw>
<doNotAggSw></doNotAggSw>
<scheduleCode></scheduleCode>
<pricecompdtls>
  <priceCompTier>
    <toVal></toVal>
    <fromVal></fromVal>
    <priceCriteria></priceCriteria>
    <tieSeqNum></tieSeqNum>
    <priceparm>
      <parmCodeType></parmCodeType>
      <priceParmCode></priceParmCode>
    </priceparm>
  </priceCompTier>
  <priceCompElg>
    <rhsPriceParmCd></rhsPriceParmCd>
    <rhsPriceParmVal></rhsPriceParmVal>
    <lhsPriceParmCd></lhsPriceParmCd>
    <rhsPriceParmTypeFlg></rhsPriceParmTypeFlg>
    <isInsufficientFlag></isInsufficientFlag>
    <isFalseFlag></isFalseFlag>
    <isTrueFlag></isTrueFlag>
    <operator></operator>
    <sequenceNumber></sequenceNumber>
  </priceCompElg>
  <priceCompSequenceNo></priceCompSequenceNo>
  <priceCompId></priceCompId>
  <priceCompDesc></priceCompDesc>
  <valueAmt></valueAmt>
  <priceComponentDisplay></priceComponentDisplay>
  <rcMapId></rcMapId>
  <tieredFlag></tieredFlag>
</pricecompdtls>
</pricingdtls>
</pricingcmtmtdtls>
</C1-DealPriceAsgnCommitmentBS>

```

Related Topics

For more information on...	See...
Deal price assignment override request and response tags in the XML format	Deal Price Assignment Override Request and Response - Tags in the XML Format on page 3854
Sample deal price assignment override request and response in the XML format	Sample Deal Price Assignment Override Request and Response in the XML Format on page 3891

Deal Price Assignment Update Request in the XML Format

The following code snippet illustrates how the tags should be nested while sending the deal price assignment update request in the XML format.

```
<Cl-DealPriceAsgnCommitmentBS>
  <dealIdentifier></dealIdentifier>
  <dealId></dealId>
  <modelId></modelId>
  <inquiryModeFlag></inquiryModeFlag>
  <pricingcmtmtdtls>
    <entityId></entityId>
    <entityType></entityType>
    <pricingdtls>
      <priceAsgnId></priceAsgnId>
      <actionFlag></actionFlag>
      <priceItemCode></priceItemCode>
      <priceStatusFlag></priceStatusFlag>
      <priceCurrencyCode></priceCurrencyCode>
      <rateSchedule></rateSchedule>
      <startDate></startDate>
      <endDate></endDate>
      <isEligible></isEligible>
      <paTypeFlag></paTypeFlag>
      <printIfZero></printIfZero>
      <priceasgnchar>
        <characteristicType></characteristicType>
        <effectiveDate></effectiveDate>
        <characteristicValue></characteristicValue>
      </priceasgnchar>
      <priceasgnparm>
        <priceParmCode></priceParmCode>
        <priceParmVal></priceParmVal>
      </priceasgnparm>
      <txndailyRatingCrt></txndailyRatingCrt>
      <ignoreSw></ignoreSw>
      <doNotAggSw></doNotAggSw>
      <scheduleCode></scheduleCode>
      <pricecompdtls>
        <priceCompTier>
          <toVal></toVal>
          <fromVal></fromVal>
          <priceCriteria></priceCriteria>
          <tieSeqNum></tieSeqNum>
          <priceparm>
            <parmCodeType></parmCodeType>
            <priceParmCode></priceParmCode>
          </priceparm>
        </priceCompTier>
        <priceCompElg>
          <rhsPriceParmCd></rhsPriceParmCd>
          <rhsPriceParmVal></rhsPriceParmVal>
          <lhsPriceParmCd></lhsPriceParmCd>
          <rhsPriceParmTypeFlg></rhsPriceParmTypeFlg>
          <isInsufficientFlag></isInsufficientFlag>
        </priceCompElg>
      </pricecompdtls>
    </pricingdtls>
  </pricingcmtmtdtls>
</Cl-DealPriceAsgnCommitmentBS>
```

```

        <isFalseFlag></isFalseFlag>
        <isTrueFlag></isTrueFlag>
        <operator></operator>
        <sequenceNumber></sequenceNumber>
    </priceCompElg>
    <priceCompSequenceNo></priceCompSequenceNo>
    <priceCompDesc></priceCompDesc>
    <valueAmt></valueAmt>
    <priceComponentDisplay></priceComponentDisplay>
    <rcMapId></rcMapId>
    <tieredFlag></tieredFlag>
</pricecompdtls>
</pricingdtls>
</pricingcmtmtdtls>
</C1-DealPriceAsgnCommitmentBS>

```

Related Topics

For more information on...	See...
Deal price assignment update request and response tags in the XML format	Deal Price Assignment Update Request and Response - Tags in the XML Format on page 3862
Sample deal price assignment update request and response in the XML format	Sample Deal Price Assignment Update Request and Response in the XML Format on page 3894

Deal Price Assignment Update Response in the XML Format

The following code snippet illustrates how the tags are nested while receiving the deal price assignment update response in the XML Format.

```

<C1-DealPriceAsgnCommitmentBS>
  <dealIdentifier></dealIdentifier>
  <dealId></dealId>
  <modelId></modelId>
  <inquiryModeFlag></inquiryModeFlag>
  <pricingcmtmtdtls>
    <entityId></entityId>
    <entityType></entityType>
    <entityIdentifierValue></entityIdentifierValue>
    <entityIdentifierType></entityIdentifierType>
    <entityDivision></entityDivision>
  </pricingdtls>
    <priceAsgnId></priceAsgnId>
    <actionFlag></actionFlag>
    <priceItemCode></priceItemCode>
    <priceItemDescription></priceItemDescription>
    <hierarchyDetails></hierarchyDetails>
    <priceStatusFlag></priceStatusFlag>
    <priceCurrencyCode></priceCurrencyCode>
    <rateSchedule></rateSchedule>
    <startDate></startDate>
    <endDate></endDate>
    <isEligible></isEligible>
    <assignmentLevel></assignmentLevel>
    <paTypeFlag></paTypeFlag>
    <printIfZero></printIfZero>
    <priceasgnchar>
      <characteristicType></characteristicType>
      <effectiveDate></effectiveDate>
      <characteristicValue></characteristicValue>
    </priceasgnchar>
  </priceasgnparm>

```



```

        <priceParmCode></priceParmCode>
        <priceParmVal></priceParmVal>
    </priceasgnparm>
    <txnDailyRatingCrt></txnDailyRatingCrt>
    <ignoreSw></ignoreSw>
    <doNotAggSw></doNotAggSw>
    <scheduleCode></scheduleCode>
    <pricecompdtls>
        <priceCompTier>
            <toVal></toVal>
            <fromVal></fromVal>
            <priceCriteria></priceCriteria>
            <tieSeqNum></tieSeqNum>
            <priceparm>
                <parmCodeType></parmCodeType>
                <priceParmCode></priceParmCode>
            </priceparm>
        </priceCompTier>
        <priceCompElg>
            <rhsPriceParmCd></rhsPriceParmCd>
            <rhsPriceParmVal></rhsPriceParmVal>
            <lhsPriceParmCd></lhsPriceParmCd>
            <rhsPriceParmTypeFlg></rhsPriceParmTypeFlg>
            <isInsufficientFlag></isInsufficientFlag>
            <isFalseFlag></isFalseFlag>
            <isTrueFlag></isTrueFlag>
            <operator></operator>
            <sequenceNumber></sequenceNumber>
        </priceCompElg>
        <priceCompSequenceNo></priceCompSequenceNo>
        <priceCompId></priceCompId>
        <priceCompDesc></priceCompDesc>
        <valueAmt></valueAmt>
        <priceComponentDisplay></priceComponentDisplay>
        <rcMapId></rcMapId>
        <tieredFlag></tieredFlag>
    </pricecompdtls>
</pricingdtls>
</pricingcmtmntdtls>
</C1-DealPriceAsgnCommitmentBS>

```

Related Topics

For more information on...	See...
Deal price assignment update request and response tags in the XML format	Deal Price Assignment Update Request and Response - Tags in the XML Format on page 3862
Sample deal price assignment update request and response in the XML format	Sample Deal Price Assignment Update Request and Response in the XML Format on page 3894

Deal Price Assignment Recommend Request in the XML Format

The following code snippet illustrates how the tags should be nested while sending the deal price assignment recommend request in the XML format.

```

<C1-DealPriceAsgnCommitmentBS>
    <dealIdentifier></dealIdentifier>
    <dealId></dealId>
    <modelId></modelId>
    <inquiryModeFlag></inquiryModeFlag>
    <pricingcmtmntdtls>
        <entityId></entityId>

```

```

<entityType></entityType>
<pricingdtls>
  <priceAsgnId></priceAsgnId>
  <actionFlag></actionFlag>
  <priceItemCode></priceItemCode>
  <priceStatusFlag></priceStatusFlag>
  <priceCurrencyCode></priceCurrencyCode>
  <rateSchedule></rateSchedule>
  <startDate></startDate>
  <endDate></endDate>
  <isEligible></isEligible>
  <paTypeFlag></paTypeFlag>
  <printIfZero></printIfZero>
  <priceasgnchar>
    <characteristicType></characteristicType>
    <effectiveDate></effectiveDate>
    <characteristicValue></characteristicValue>
  </priceasgnchar>
  <priceasgnparm>
    <priceParmCode></priceParmCode>
    <priceParmVal></priceParmVal>
  </priceasgnparm>
  <txnDailyRatingCrt></txnDailyRatingCrt>
  <ignoreSw></ignoreSw>
  <doNotAggSw></doNotAggSw>
  <scheduleCode></scheduleCode>
  <pricecompdtls>
    <priceCompTier>
      <toVal></toVal>
      <fromVal></fromVal>
      <priceCriteria></priceCriteria>
      <tieSeqNum></tieSeqNum>
      <priceparm>
        <parmCodeType></parmCodeType>
        <priceParmCode></priceParmCode>
      </priceparm>
    </priceCompTier>
    <priceCompElg>
      <rhsPriceParmCd></rhsPriceParmCd>
      <rhsPriceParmVal></rhsPriceParmVal>
      <lhsPriceParmCd></lhsPriceParmCd>
      <rhsPriceParmTypeFlg></rhsPriceParmTypeFlg>
      <isInsufficientFlag></isInsufficientFlag>
      <isFalseFlag></isFalseFlag>
      <isTrueFlag></isTrueFlag>
      <operator></operator>
      <sequenceNumber></sequenceNumber>
    </priceCompElg>
    <priceCompSequenceNo></priceCompSequenceNo>
    <priceCompDesc></priceCompDesc>
    <valueAmt></valueAmt>
    <priceComponentDisplay></priceComponentDisplay>
    <rcMapId></rcMapId>
    <tieredFlag></tieredFlag>
  </pricecompdtls>
</pricingdtls>
</pricingcmtmtdtls>
</C1-DealPriceAsgnCommitmentBS>

```

Related Topics

For more information on...	See...
Deal price assignment recommend request and response tags in the XML format	Deal Price Assignment Recommend Request and Response - Tags in the XML Format on page 3870
Sample deal price assignment recommend request and response in the XML format	Sample Deal Price Assignment Recommend Request and Response in the XML Format on page 3897

Deal Price Assignment Recommend Response in the XML Format

The following code snippet illustrates how the tags are nested while receiving the deal price assignment override response in the XML Format.

```
<Cl-DealPriceAsgnCommitmentBS>
  <dealIdentifier></dealIdentifier>
  <dealId></dealId>
  <modelId></modelId>
  <inquiryModeFlag></inquiryModeFlag>
  <pricingcmtmtdtls>
    <entityId></entityId>
    <entityType></entityType>
    <entityIdentifierValue></entityIdentifierValue>
    <entityIdentifierType></entityIdentifierType>
    <entityDivision></entityDivision>
  <pricingdtdtls>
    <priceAsgnId></priceAsgnId>
    <actionFlag></actionFlag>
    <priceItemCode></priceItemCode>
    <priceItemDescription></priceItemDescription>
    <hierarchyDetails></hierarchyDetails>
    <priceStatusFlag></priceStatusFlag>
    <priceCurrencyCode></priceCurrencyCode>
    <rateSchedule></rateSchedule>
    <startDate></startDate>
    <endDate></endDate>
    <isEligible></isEligible>
    <assignmentLevel></assignmentLevel>
    <paTypeFlag></paTypeFlag>
    <printIfZero></printIfZero>
    <priceasgnchar>
      <characteristicType></characteristicType>
      <effectiveDate></effectiveDate>
      <characteristicValue></characteristicValue>
    </priceasgnchar>
    <priceasgnparm>
      <priceParmCode></priceParmCode>
      <priceParmVal></priceParmVal>
    </priceasgnparm>
    <txnDailyRatingCrt></txnDailyRatingCrt>
    <ignoreSw></ignoreSw>
    <doNotAggSw></doNotAggSw>
    <scheduleCode></scheduleCode>
  <pricecompdtdtls>
    <priceCompTier>
      <toVal></toVal>
      <fromVal></fromVal>
      <priceCriteria></priceCriteria>
      <tieSeqNum></tieSeqNum>
      <priceparm>
        <parmCodeType></parmCodeType>
        <priceParmCode></priceParmCode>
      </priceparm>
    </priceCompTier>
  </pricecompdtdtls>
</Cl-DealPriceAsgnCommitmentBS>
```

```

        <priceCompElg>
          <rhsPriceParmCd></rhsPriceParmCd>
          <rhsPriceParmVal></rhsPriceParmVal>
          <lhsPriceParmCd></lhsPriceParmCd>
          <rhsPriceParmTypeFlg></rhsPriceParmTypeFlg>
          <isInsufficientFlag></isInsufficientFlag>
          <isFalseFlag></isFalseFlag>
          <isTrueFlag></isTrueFlag>
          <operator></operator>
          <sequenceNumber></sequenceNumber>
        </priceCompElg>
      <priceCompSequenceNo></priceCompSequenceNo>
      <priceCompId></priceCompId>
      <priceCompDesc></priceCompDesc>
      <valueAmt></valueAmt>
      <priceComponentDisplay></priceComponentDisplay>
      <rcMapId></rcMapId>
      <tieredFlag></tieredFlag>
    </pricecompdtls>
  </pricingdtls>
</pricingcmtmntdtls>
</C1-DealPriceAsgnCommitmentBS>

```

Related Topics

For more information on...	See...
Deal price assignment recommend request and response tags in the XML format	Deal Price Assignment Recommend Request and Response - Tags in the XML Format on page 3870
Sample deal price assignment recommend request and response in the XML format	Sample Deal Price Assignment Recommend Request and Response in the XML Format on page 3897

Deal Price Assignment Delete Request in the XML Format

The following code snippet illustrates how the tags should be nested while sending the deal price assignment delete request in the XML format.

```

<C1-DealPriceAsgnCommitmentBS>
  <dealIdentifier></dealIdentifier>
  <dealId></dealId>
  <modelId></modelId>
  <inquiryModeFlag></inquiryModeFlag>
  <pricingcmtmntdtls>
    <entityId></entityId>
    <entityType></entityType>
    <pricingdtls>
      <priceAsgnId></priceAsgnId>
      <actionFlag></actionFlag>
    </pricingdtls>
  </pricingcmtmntdtls>
</C1-DealPriceAsgnCommitmentBS>

```

Related Topics

For more information on...	See...
Deal price assignment delete request and response tags in the XML format	Deal Price Assignment Delete Request and Response - Tags in the XML Format on page 3878
Sample deal price assignment delete request and response in the XML format	Sample Deal Price Assignment Delete Request and Response in the XML Format on page 3899

Deal Price Assignment Delete Response in the XML Format

The following code snippet illustrates how the tags are nested while receiving the deal price assignment delete response in the XML Format.

```
<C1-DealPriceAsgnCommitmentBS>
  <dealIdentifier></dealIdentifier>
  <dealId></dealId>
  <modelId></modelId>
  <inquiryModeFlag></inquiryModeFlag>
  <pricingcmtmntdtls>
    <entityId></entityId>
    <entityType></entityType>
    <pricingdtls>
      <priceAsgnId></priceAsgnId>
      <actionFlag></actionFlag>
      <isEligible></isEligible>
    </pricingdtls>
  </pricingcmtmntdtls>
</C1-DealPriceAsgnCommitmentBS>
```

Related Topics

For more information on...	See...
Deal price assignment delete request and response tags in the XML format	Deal Price Assignment Delete Request and Response - Tags in the XML Format on page 3878
Sample deal price assignment delete request and response in the XML format	Sample Deal Price Assignment Delete Request and Response in the XML Format on page 3899

Deal Price Assignment and Commitments View Request in the XML Format

The following code snippet illustrates how the tags should be nested while sending the deal price assignment and commitments view request in the XML format.

```
<C1-DealPriceAsgnCommitmentBS>
  <dealIdentifier></dealIdentifier>
  <dealId></dealId>
  <modelId></modelId>
  <actionflag></actionflag>
  <inquiryModeFlag></inquiryModeFlag>
</C1-DealPriceAsgnCommitmentBS>
```

Related Topics

For more information on...	See...
Deal price assignment and commitments view request and response tags in the XML format	Deal Price Assignment and Commitments View Request and Response - Tags in the XML Format on page 3880
Sample deal price assignment and commitments view request and response in the XML Format	Sample Deal Price Assignment and Commitments View Request and Response in the XML Format on page 3900

Deal Price Assignment and Commitments View Response in the XML Format

The following code snippet illustrates how the tags are nested while receiving the deal price assignment and commitments view response in the XML Format.

```
<C1-DealPriceAsgnCommitmentBS>
  <dealIdentifier></dealIdentifier>
  <dealId></dealId>
```

```

<modelId></modelId>
<inquiryModeFlag></inquiryModeFlag>
<actionFlag></actionFlag>
<pricingcmtmtdtls>
  <entityId></entityId>
  <entityType></entityType>
  <entityIdentifierValue></entityIdentifierValue>
  <entityIdentifierType></entityIdentifierType>
  <entityDivision></entityDivision>
</pricingdtls>
  <priceAsgnId></priceAsgnId>
  <priceItemId></priceItemId>
  <priceItemDescription></priceItemDescription>
  <hierarchyDetails></hierarchyDetails>
  <priceStatusFlag></priceStatusFlag>
  <priceCurrencyCode></priceCurrencyCode>
  <rateSchedule></rateSchedule>
  <startDate></startDate>
  <endDate></endDate>
  <isEligible></isEligible>
  <assignmentLevel></assignmentLevel>
  <paTypeFlag></paTypeFlag>
  <printIfZero></printIfZero>
  <priceasgnchar>
    <characteristicType></characteristicType>
    <effectiveDate></effectiveDate>
    <characteristicValue></characteristicValue>
  </priceasgnchar>
  <priceasgnparm>
    <priceParmCode></priceParmCode>
    <priceParmVal></priceParmVal>
  </priceasgnparm>
  <txnDailyRatingCrt></txnDailyRatingCrt>
  <ignoreSw></ignoreSw>
  <doNotAggSw></doNotAggSw>
  <scheduleCode></scheduleCode>
  <pricecompdtls>
    <priceCompTier>
      <toVal></toVal>
      <fromVal></fromVal>
      <priceCriteria></priceCriteria>
      <tieSeqNum></tieSeqNum>
      <priceparm>
        <parmCodeType></parmCodeType>
        <priceParmCode></priceParmCode>
      </priceparm>
    </priceCompTier>
    <priceCompElg>
      <rhsPriceParmCd></rhsPriceParmCd>
      <rhsPriceParmVal></rhsPriceParmVal>
      <lhsPriceParmCd></lhsPriceParmCd>
      <rhsPriceParmTypeFlg></rhsPriceParmTypeFlg>
      <isInsufficientFlag></isInsufficientFlag>
      <isFalseFlag></isFalseFlag>
      <isTrueFlag></isTrueFlag>
      <operator></operator>
      <sequenceNumber></sequenceNumber>
    </priceCompElg>
    <priceCompSequenceNo></priceCompSequenceNo>
    <priceCompId></priceCompId>
    <priceCompDesc></priceCompDesc>
    <valueAmt></valueAmt>
    <priceComponentDisplay></priceComponentDisplay>
  </rcMapId></rcMapId>

```

```

        <tieredFlag></tieredFlag>
    </pricecompdtls>
</pricingdtls>
<commitmentDetails>
    <priceItemCode></priceItemCode>
    <priceItemDescription></priceItemDescription>
    <parameterDetails>
        <parameterCode></parameterCode>
        <parameterValue></parameterValue>
    </parameterDetails>
    <SQIDetails>
        <serviceQuantityIdentifier></serviceQuantityIdentifier>
        <sqiValue></sqiValue>
        <sqiTypeFlg></sqiTypeFlg>
    </SQIDetails>
</commitmentDetails>
</pricingcmtmntdtls>
</C1-DealPriceAsgnCommitmentBS>

```

Related Topics

For more information on...	See...
Deal price assignment and commitments view request and response tags in the XML format	Deal Price Assignment and Commitments View Request and Response - Tags in the XML Format on page 3880
Sample deal price assignment and commitments view request and response in the XML Format	Sample Deal Price Assignment and Commitments View Request and Response in the XML Format on page 3900

Deal Commitments Add Request in the XML Format

The following code snippet illustrates how the tags should be nested while sending the deal commitments add request in the XML format.

```

<C1-DealPriceAsgnCommitmentBS>
    <dealIdentifier></dealIdentifier>
    <dealId></dealId>
    <modelId></modelId>
    <inquiryModeFlag></inquiryModeFlag>
    <pricingcmtmntdtls>
        <entityId></entityId>
        <entityType></entityType>
        <commitmentDetails>
            <priceItemCode></priceItemCode>
            <priceItemDescription></priceItemDescription>
            <parameterDetails>
                <parameterCode></parameterCode>
                <parameterValue></parameterValue>
            </parameterDetails>
            <SQIDetails>
                <serviceQuantityIdentifier></serviceQuantityIdentifier>
                <sqiValue></sqiValue>
                <sqiTypeFlg></sqiTypeFlg>
                <actionFlag></actionFlag>
            </SQIDetails>
        </commitmentDetails>
    </pricingcmtmntdtls>
</C1-DealPriceAsgnCommitmentBS>

```

Related Topics

For more information on...	See...
Deal commitments add request and response tags in the XML format	Deal Commitments Add Request and Response - Tags in the XML Format on page 3886
Sample deal commitments add request and response in the XML format	Sample Deal Commitments Add Request and Response in the XML Format on page 3902

Deal Commitments Add Response in the XML Format

The following code snippet illustrates how the tags are nested while receiving the deal commitments add response in the XML Format.

```
<C1-DealPriceAsgnCommitmentBS>
  <dealIdentifier></dealIdentifier>
  <dealId></dealId>
  <modelId></modelId>
  <pricingcmtmntdtls>
    <entityId></entityId>
    <entityType></entityType>
    <commitmentDetails>
      <priceItemCode></priceItemCode>
      <priceItemDescription></priceItemDescription>
      <parameterDetails>
        <parameterCode></parameterCode>
        <parameterValue></parameterValue>
      </parameterDetails>
      <SQIDetails>
        <serviceQuantityIdentifier></serviceQuantityIdentifier>
        <sqiValue></sqiValue>
        <sqiTypeFlg></sqiTypeFlg>
        <actionFlag></actionFlag>
      </SQIDetails>
    </commitmentDetails>
  </pricingcmtmntdtls>
</C1-DealPriceAsgnCommitmentBS>
```

Related Topics

For more information on...	See...
Deal commitments add request and response tags in the XML format	Deal Commitments Add Request and Response - Tags in the XML Format on page 3886
Sample deal commitments add request and response in the XML format	Sample Deal Commitments Add Request and Response in the XML Format on page 3902

Deal Commitments Update Request in the XML Format

The following code snippet illustrates how the tags should be nested while sending the deal commitments update request in the XML format.

```
<C1-DealPriceAsgnCommitmentBS>
  <dealIdentifier></dealIdentifier>
  <dealId></dealId>
  <modelId></modelId>
  <inquiryModeFlag></inquiryModeFlag>
  <pricingcmtmntdtls>
    <entityId></entityId>
    <entityType></entityType>
    <commitmentDetails>
      <priceItemCode></priceItemCode>
      <priceItemDescription></priceItemDescription>
```



```

    <parameterDetails>
      <parameterCode></parameterCode>
      <parameterValue></parameterValue>
    </parameterDetails>
  </SQIDetails>
  <serviceQuantityIdentifier></serviceQuantityIdentifier>
  <sqiValue></sqiValue>
  <sqiTypeFlg></sqiTypeFlg>
  <actionFlag></actionFlag>
</SQIDetails>
</commitmentDetails>
</pricingcmtmndtcls>
</C1-DealPriceAsgnCommitmentBS>

```

Related Topics

For more information on...	See...
Deal commitments update request and response tags in the XML format	Deal Commitments Update Request and Response - Tags in the XML Format on page 3889
Sample deal commitments update request and response in the XML format	Sample Deal Commitments Update Request and Response in the XML Format on page 3903

Deal Commitments Update Response in the XML Format

The following code snippet illustrates how the tags are nested while receiving the deal commitments update response in the XML Format.

```

<C1-DealPriceAsgnCommitmentBS>
  <dealIdentifier></dealIdentifier>
  <dealId></dealId>
  <modelId></modelId>
  <pricingcmtmndtcls>
    <entityId></entityId>
    <entityType></entityType>
    <commitmentDetails>
      <priceItemCode></priceItemCode>
      <priceItemDescription></priceItemDescription>
      <parameterDetails>
        <parameterCode></parameterCode>
        <parameterValue></parameterValue>
      </parameterDetails>
      <SQIDetails>
        <serviceQuantityIdentifier></serviceQuantityIdentifier>
        <sqiValue></sqiValue>
        <sqiTypeFlg></sqiTypeFlg>
        <actionFlag></actionFlag>
      </SQIDetails>
    </commitmentDetails>
  </pricingcmtmndtcls>
</C1-DealPriceAsgnCommitmentBS>

```

Related Topics

For more information on...	See...
Deal commitments update request and response tags in the XML format	Deal Commitments Update Request and Response - Tags in the XML Format on page 3889
Sample deal commitments update request and response in the XML format	Sample Deal Commitments Update Request and Response in the XML Format on page 3903

Deal Price Assignment Override Request and Response - Tags in the XML Format

Note: We recommend you to refer the topics [Deal Price Assignment Override Request in the XML Format](#) on page 3840 and [Deal Price Assignment Override Response in the XML Format](#) on page 3841 in parallel while understanding the below mentioned tags. This will help you to understand how the tags are nested in the XML format.

Before calling the **C1-DealPriceAsgnCommitmentBS** business service through an inbound web service, you need to ensure that the deal price assignment override request contains the following tags:

Tag Name	Tag Description	Mandatory (Yes or No)
dealIdentifier	Used to specify the deal which is created using a particular identifier whose price assignments you want to override.	Yes (Conditional)
	Note: If you specify the dealIdentifier tag, you need not specify the dealId and the modelId tags.	Note: This data is required if you do not specify the dealId and modelId tags.
dealId	Used to specify the deal whose price assignments you want to override.	Yes (Conditional)
	Note: If you specify the dealId tag, you need not specify the dealIdentifier and the modelId tags. If the deal has multiple versions, then, you should specify the modelId tag instead of the dealId tag.	Note: This data is required if you do not specify the dealIdentifier and modelId tags.
modelId	Used to specify the deal version whose price assignments you want to override.	Yes (Conditional)
	Note: If you specify the modelId tag, you need not specify the dealIdentifier and the dealId tags.	Note: This data is required if you do not specify the dealIdentifier and dealId tags.
inquiryModeFlag	Used to indicate whether you want to override the price assignments or the commitments of the price item. The valid value is: <ul style="list-style-type: none"> • PRIC 	Yes
pricingcmtmntdtls	Used to specify the price assignment and commitment details for the entities (i.e. existing or prospect person or account) of the deal.	Yes
entityId	Used to specify the entity (i.e. existing or prospect person or account) whose price assignments you want to override.	Yes

Tag Name	Tag Description	Mandatory (Yes or No)
	<p>Note:</p> <p>If you specify the entityType tag, you need to specify the entityId tag.</p> <p>The entityId should belong to the modelId.</p>	
entityType	<p>Used to indicate the type of the entity (i.e. existing or prospect person or account) whose price assignments you want to override. The valid values are:</p> <ul style="list-style-type: none"> • ACCT • PERS <p>Note: If you specify the entityId tag, you need to specify the entityType tag.</p>	Yes
pricingdtls	Used to specify the price assignment details for the entity (i.e. existing or prospect person or account).	Yes
priceAsgnId	<p>Used to specify the identification value of the price assignment whose details you want to override.</p> <p>Note: The priceAsgnId should belong to the entityId.</p>	Yes
actionFlag	<p>Used to indicate that you want to create request to override the price assignment of the entity (i.e. existing or prospect person or account) of the deal. The valid value is:</p> <ul style="list-style-type: none"> • OVRD 	Yes
priceItemCode	Used to specify the price item whose price assignment you want to override for the entity (i.e. existing or prospect person or account) of the deal.	Yes
priceStatusFlag	<p>Used to indicate the current status of the price item price assignment. The valid value is:</p> <ul style="list-style-type: none"> • PRPD <p>Note: You can override a price assignment of a price item only when it is in the PRPD status.</p>	Yes
priceCurrencyCode	Used to indicate the currency in which the price assignment is defined for the price item.	Yes
rateSchedule	Used to indicate the rate schedule using which the price assignment is defined for the price item.	Yes

Tag Name	Tag Description	Mandatory (Yes or No)
startDate	Used to specify the date from when the price assignment of the price item is effective for the entity (i.e. existing or prospect person or account).	Yes
endDate	Used to specify the date till when the price assignment of the price item is effective for the entity (i.e. existing or prospect person or account).	No
isEligible	Used to indicate whether you want to define the eligibility criteria for the price assignment. The valid values are: <ul style="list-style-type: none"> • FALSE • TRUE 	No
paTypeFlag	Used to indicate the type of price assignment. The valid values are: <ul style="list-style-type: none"> • POST • PPIN • PPPR • RGLR 	Yes
printfZero	Used to indicate whether zero pricing should be displayed or not. The valid values are: <ul style="list-style-type: none"> • Y • N 	Yes
priceasgnchar	Used to specify a list of characteristics for the price assignment.	No
characteristicType	Used to indicate the characteristic type.	Yes (Conditional)
	Note: You must specify a characteristic type which is associated with the division to which the price item belongs.	Note: This data is required while defining a characteristic for the price assignment.
effectiveDate	Used to specify the date from when the characteristic is effective for price assignment.	Yes (Conditional)
		Note: This data is required while defining a characteristic for the price assignment.
characteristicValue	Used to specify the value for the characteristic type.	Yes (Conditional)
		Note: This data is required while defining a characteristic for the price assignment.
priceasgnparm	Used to specify a list of price item parameters which are used along with the price item for determining the price assignment.	No

Tag Name	Tag Description	Mandatory (Yes or No)
priceParmCode	Used to indicate the pricing parameter which is associated with the price item.	Yes (Conditional)
	Note: If you specify the priceParmVal tag, you need to specify the priceParmCode tag.	Note: This data is required while specifying the price assignment parameters for the price item.
priceParmVal	Used to indicate the predefined pricing parameter value which is used for the price assignment.	Yes (Conditional)
	Note: If you specify the priceParmCode tag, you need to specify the priceParmVal tag.	Note: This data is required while specifying the price assignment parameters for the price item.
txnDailyRatingCrt	Used to indicate how and when the transaction legs mapped to the price item are rated. The valid values are: <ul style="list-style-type: none"> • DNRT • AGTR • RITA • RITX 	Yes
ignoreSw	Used to indicate whether transaction mapped to price item pricing are considered for billing or not. The valid values are: <ul style="list-style-type: none"> • Y • N 	No
doNotAggSw	Used to indicate whether aggregation is required while rating the transactions mapped to the price item pricing before billing. The valid values are: <ul style="list-style-type: none"> • Y • N 	No
scheduleCode	Used to indicate the transaction aggregation cycle. The valid values are: <ul style="list-style-type: none"> • DAILY • WEEKLY • MONTHLY • QUARTERLY • YEARLY 	Yes
priceCompDetails	Used to specify the price component details of the rate component defined for the price item price assignment.	No
priceCompTier	Used to specify the tiering criteria of the price component.	No

Tag Name	Tag Description	Mandatory (Yes or No)
toVal	Used to specify the upper limit of the pricing range.	Yes (Conditional) Note: This data is required while specifying the tiering criteria of the price component.
fromVal	Used to specify the lower limit of the pricing range.	Yes (Conditional) Note: This data is required while specifying the tiering criteria of the price component.
priceCriteria	Used to indicate the tiering criterion which is used in the tiering range.	Yes (Conditional) Note: This data is required while specifying the tiering criteria of the price component.
tieSeqNum	Used to indicate the tiering sequence number.	Yes (Conditional) Note: This data is required while specifying the tiering criteria of the price component.
priceparm	Used to specify a list of parameters based on which the price items total usage is considered for determining the rate. Note: You should specify a value in this tag only when the Multi Price Parameter option type of the Multi Parameter Based Pricing (C1_PPARM_FLG) feature configuration is set to True .	No
priceParmCode	Used to indicate the parameter which is associated with the tiering criteria.	Yes (Conditional) Note: This data is required while specifying the parameters for the tiering criteria of the price component.
parameterVal	Used to specify the value for the parameter which is associated with the tiering criteria.	Yes (Conditional) Note: This data is required while specifying the parameters for the tiering criteria of the price component.
priceCompElig	Used to specify the pricing eligibility criteria for the price component.	No

Tag Name	Tag Description	Mandatory (Yes or No)
	Note: You can specify the eligibility criteria for the price component only when the value in the isEligible tag is set to TRUE .	
rhsPriceParmCd	Used to specify the parameter against which you want to compare the parameter (on the left hand side).	Yes (Conditional) Note: This data is required while specifying the pricing eligibility criteria of the price component.
rhsPriceParmVal	Used to specify the parameter value against which you want to compare the parameter (on the left hand side).	Yes (Conditional) Note: This data is required while specifying the pricing eligibility criteria of the price component.
lhsPriceParmCd	Used to specify the left hand side parameter which you want to use along with the price item for price determination.	Yes (Conditional) Note: This data is required while specifying the pricing eligibility criteria of the price component.
rhsPriceParmTypeFlg	Used to indicate whether the parameter (on the left hand side) is compared against another parameter (on the right hand side) or directly against a parameter value. The valid values are: <ul style="list-style-type: none"> PARAMETER - Used to indicate that the parameter (on the left hand side) is compared against another parameter (on the right hand side). VALUE - Used to indicate that the parameter (on the left hand side) is compared against a parameter value. 	Yes (Conditional) Note: This data is required while specifying the pricing eligibility criteria of the price component.
isInsufficientFlag	Used to indicate what should happen when the data is insufficient. The valid values are: <ul style="list-style-type: none"> COND - Used to indicate that the condition with the consecutive sequence number is executed. RLFS - Used to indicate that the action specified in the Rule False Action field is executed. RLTR - Used to indicate that the action specified in the Rule True Action field is executed. 	Yes (Conditional) Note: This data is required while specifying the pricing eligibility criteria of the price component.
isFalseFlag	Used to indicate what should happen when the condition is false (not satisfied). The valid values are:	Yes (Conditional) Note: This data is required while specifying the pricing eligibility criteria of the price component.

Tag Name	Tag Description	Mandatory (Yes or No)
	<ul style="list-style-type: none"> • COND - Used to indicate that the condition with the consecutive sequence number is executed. • RLFS - Used to indicate that the action specified in the Rule False Action field is executed. • RLTR - Used to indicate that the action specified in the Rule True Action field is executed. 	
isTrueFlag	<p>Used to indicate what should happen when the condition is true (satisfied). The valid values are:</p> <ul style="list-style-type: none"> • COND - Used to indicate that the condition with the consecutive sequence number is executed. • RLFS - Used to indicate that the action specified in the Rule False Action field is executed. • RLTR - Used to indicate that the action specified in the Rule True Action field is executed. 	<p>Yes (Conditional)</p> <p>Note: This data is required while specifying the pricing eligibility criteria of the price component.</p>
operator	<p>Used to indicate the relational operator used to define the relation between the parameter name and the parameter value. The valid values are:</p> <ul style="list-style-type: none"> • < • <= • <> • = • > • >= • BETWEEN • IN • LIKE • NOT IN 	<p>Yes (Conditional)</p> <p>Note: This data is required while specifying the pricing eligibility criteria of the price component.</p>
sequenceNumber	Used to specify the order in which the pricing eligibility criteria is executed in the rule.	<p>Yes (Conditional)</p> <p>Note: This data is required while specifying the pricing eligibility criteria of the price component.</p>
priceCompSequenceNo	Used to specify the sequence number of the price component.	Yes
priceCompDesc	Used to specify the description for the price component.	No

Tag Name	Tag Description	Mandatory (Yes or No)
valueAmt	Used to specify the rate for the price component.	Yes
priceComponentDisplay	Used to indicate whether the price component is displayed in the bill. The valid values are: <ul style="list-style-type: none"> • TRUE • FALSE 	Yes
rcMapId	Used to specify the identification value of the rate component for the price component.	Yes
tieredFlag	Used to specify the tiering type used for the price component. The valid values are: <ul style="list-style-type: none"> • FLAT • STEP • THRESHOLD 	Yes

Once the deal price assignment is overridden, all the details of deal price assignment are listed in the above mentioned tags along with the following tags:

Tag Name	Tag Description
dealId	Displays the identification value of the deal whose price assignments you have overridden.
	Note: The value in this tag appears when you specify the dealIdentifier or the modelId tag while creating the override request.
modelId	Displays the deal version whose price assignments you have overridden.
	Note: The value in this tag appears when you specify the dealIdentifier or the dealId tag while creating the override request.
entityIdentifierValue	Indicates the identifier using which the entity (i.e. existing or prospect person or account) is created in the system.
entityIdentifierType	Indicates the identifier type using which the entity (i.e. existing or prospect person or account) is created in the system.
entityDivision	Indicates the division to which the entity (i.e. existing or prospect person or account) belongs.
priceItemDescription	Displays the description of the price item.
hierarchyDetails	Displays the hierarchy to which the price item belongs.
assignmentLevel	Indicates the level at which the pricing is defined for the price item. The valid values are: <ul style="list-style-type: none"> • ACPI • CUPI • PCPI
priceCompId	Displays the identification value of the price component.

Note:

Only **RM** (Relationship Manager) can create the deal price assignment override request.

You can override only the inherited price assignments and not the agreed price assignments.

On processing the request, the system creates an agreed pricing for the entity of the deal in the **Proposed** status.

Related Topics

For more information on...	See...
Sample deal price assignment override request and response in the XML format	Sample Deal Price Assignment Override Request and Response in the XML Format on page 3891

Deal Price Assignment Update Request and Response - Tags in the XML Format

Note: We recommend you to refer the topics [Deal Price Assignment Update Request in the XML Format](#) on page 3843 and [Deal Price Assignment Update Response in the XML Format](#) on page 3844 in parallel while understanding the below mentioned tags. This will help you to understand how the tags are nested in the XML format.

Before calling the **C1-DealPriceAsgnCommitmentBS** business service through an inbound web service, you need to ensure that the deal price assignment update request contains the following tags:

Tag Name	Tag Description	Mandatory (Yes or No)
dealIdentifier	Used to specify the deal which is created using a particular identifier whose price assignments you want to update.	Yes (Conditional)
	Note: If you specify the dealIdentifier tag, you need not specify the dealId and the modelId tags.	Note: This data is required if you do not specify the dealId and modelId tags.
dealId	Used to specify the deal whose price assignments you want to update.	Yes (Conditional)
	Note: If you specify the dealId tag, you need not specify the dealIdentifier and the modelId tags. If the deal has multiple versions, then, you should specify the modelId tag instead of the dealId tag.	Note: This data is required if you do not specify the dealIdentifier and modelId tags.
modelId	Used to specify the deal version whose price assignments you want to update.	Yes (Conditional)
	Note: If you specify the modelId tag, you need not specify the dealIdentifier and the dealId tags.	Note: This data is required if you do not specify the dealIdentifier and dealId tags.
inquiryModeFlag	Used to indicate whether you want to update the price assignments or the commitments of the price item. The valid value is:	Yes

Tag Name	Tag Description	Mandatory (Yes or No)
	<ul style="list-style-type: none"> PRIC 	
pricingcmtmndtcls	Used to specify the price assignment and commitment details for the entities (i.e. existing or prospect person or account) of the deal.	Yes
entityId	<p>Used to specify the entity (i.e. existing or prospect person or account) whose price assignments you want to update.</p> <p>Note: If you specify the entityType tag, you need to specify the entityId tag. The entityId should belong to the modelId.</p>	Yes
entityType	<p>Used to indicate the type of the entity (i.e. existing or prospect person or account) whose price assignments you want to update. The valid values are:</p> <ul style="list-style-type: none"> ACCT PERS <p>Note: If you specify the entityId tag, you need to specify the entityType tag.</p>	Yes
pricingdtcls	Used to specify the price assignment details for the entity (i.e. existing or prospect person or account).	Yes
priceAsgnId	<p>Used to specify the identification value of the price assignment whose details you want to update.</p> <p>Note: The priceAsgnId should belong to the entityId.</p>	Yes
actionFlag	<p>Used to indicate that you want to create request to update the price assignment of the entity (i.e. existing or prospect person or account) of the deal. The valid value is:</p> <ul style="list-style-type: none"> UPD 	Yes
priceItemCode	Used to specify the price item whose price assignment you want to update for the entity (i.e. existing or prospect person or account) of the deal.	Yes
priceStatusFlag	<p>Used to indicate the current status of the price item price assignment. The valid value is:</p> <ul style="list-style-type: none"> PRPD 	Yes

Tag Name	Tag Description	Mandatory (Yes or No)
	Note: You can update a price assignment of a price item only when it is in the PRPD status.	
priceCurrencyCode	Used to indicate the currency in which the price assignment is defined for the price item.	Yes
rateSchedule	Used to indicate the rate schedule using which the price assignment is defined for the price item.	Yes
startDate	Used to specify the date from when the price assignment of the price item is effective for the entity (i.e. existing or prospect person or account).	Yes
endDate	Used to specify the date till when the price assignment of the price item is effective for the entity (i.e. existing or prospect person or account).	No
isEligible	Used to indicate whether you want to define the eligibility criteria for the price assignment. The valid values are: <ul style="list-style-type: none"> • FALSE • TRUE 	No
paTypeFlag	Used to indicate the type of price assignment. The valid values are: <ul style="list-style-type: none"> • POST • PPIN • PPPR • RGLR 	Yes
printIfZero	Used to indicate whether zero pricing should be displayed or not. The valid values are: <ul style="list-style-type: none"> • Y • N 	Yes
priceasgnchar	Used to specify a list of characteristics for the price assignment.	No
characteristicType	Used to indicate the characteristic type.	Yes (Conditional)
	Note: You must specify a characteristic type which is associated with the division to which the price item belongs.	Note: This data is required while defining a characteristic for the price assignment.
effectiveDate	Used to specify the date from when the characteristic is effective for price assignment.	Yes (Conditional)
		Note: This data is required while defining a characteristic for the price assignment.

Tag Name	Tag Description	Mandatory (Yes or No)
characteristicValue	Used to specify the value for the characteristic type.	Yes (Conditional)
		Note: This data is required while defining a characteristic for the price assignment.
priceasgnparm	Used to specify a list of price item parameters which are used along with the price item for determining the price assignment.	No
priceParmCode	Used to indicate the pricing parameter which is associated with the price item.	Yes (Conditional)
	Note: If you specify the priceParmVal tag, you need to specify the priceParmCode tag.	Note: This data is required while specifying the price assignment parameters for the price item.
priceParmVal	Used to indicate the predefined pricing parameter value which is used for the price assignment.	Yes (Conditional)
	Note: If you specify the priceParmCode tag, you need to specify the priceParmVal tag.	Note: This data is required while specifying the price assignment parameters for the price item.
txnDailyRatingCrt	Used to indicate how and when the transaction legs mapped to the price item are rated. The valid values are: <ul style="list-style-type: none"> • DNRT • AGTR • RITA • RITX 	Yes
ignoreSw	Used to indicate whether transaction mapped to price item pricing are considered for billing or not. The valid values are: <ul style="list-style-type: none"> • Y • N 	No
doNotAggSw	Used to indicate whether aggregation is required while rating the transactions mapped to the price item pricing before billing. The valid values are: <ul style="list-style-type: none"> • Y • N 	No
scheduleCode	Used to indicate the transaction aggregation cycle. The valid values are: <ul style="list-style-type: none"> • DAILY • WEEKLY • MONTHLY 	Yes

Tag Name	Tag Description	Mandatory (Yes or No)
	<ul style="list-style-type: none"> • QUARTERLY • YEARLY 	
priceCompDetails	Used to specify the price component details of the rate component defined for the price item price assignment.	No
priceCompTier	Used to specify the tiering criteria of the price component.	No
toVal	Used to specify the upper limit of the pricing range.	Yes (Conditional)
		Note: This data is required while specifying the tiering criteria of the price component.
fromVal	Used to specify the lower limit of the pricing range.	Yes (Conditional)
		Note: This data is required while specifying the tiering criteria of the price component.
priceCriteria	Used to indicate the tiering criterion which is used in the tiering range.	Yes (Conditional)
		Note: This data is required while specifying the tiering criteria of the price component.
tieSeqNum	Used to indicate the tiering sequence number.	Yes (Conditional)
		Note: This data is required while specifying the tiering criteria of the price component.
priceparm	Used to specify a list of parameters based on which the price items total usage is considered for determining the rate.	No
	Note: You should specify a value in this tag only when the Multi Price Parameter option type of the Multi Parameter Based Pricing (C1_PPARM_FLG) feature configuration is set to True .	
priceParmCode	Used to indicate the parameter which is associated with the tiering criteria.	Yes (Conditional)
		Note: This data is required while specifying the parameters for the tiering criteria of the price component.
parameterVal	Used to specify the value for the parameter which is associated with the tiering criteria.	Yes (Conditional)

Tag Name	Tag Description	Mandatory (Yes or No)
		Note: This data is required while specifying the parameters for the tiering criteria of the price component.
priceCompElig	Used to specify the pricing eligibility criteria for the price component. Note: You can specify the eligibility criteria for the price component only when the value in the isEligible tag is set to TRUE .	No
rhsPriceParmCd	Used to specify the parameter against which you want to compare the parameter (on the left hand side).	Yes (Conditional) Note: This data is required while specifying the pricing eligibility criteria of the price component.
rhsPriceParmVal	Used to specify the parameter value against which you want to compare the parameter (on the left hand side).	Yes (Conditional) Note: This data is required while specifying the pricing eligibility criteria of the price component.
lhsPriceParmCd	Used to specify the left hand side parameter which you want to use along with the price item for price determination.	Yes (Conditional) Note: This data is required while specifying the pricing eligibility criteria of the price component.
rhsPriceParmTypeFlg	Used to indicate whether the parameter (on the left hand side) is compared against another parameter (on the right hand side) or directly against a parameter value. The valid values are: <ul style="list-style-type: none"> PARAMETER - Used to indicate that the parameter (on the left hand side) is compared against another parameter (on the right hand side). VALUE - Used to indicate that the parameter (on the left hand side) is compared against a parameter value. 	Yes (Conditional) Note: This data is required while specifying the pricing eligibility criteria of the price component.
isInsufficientFlag	Used to indicate what should happen when the data is insufficient. The valid values are: <ul style="list-style-type: none"> COND - Used to indicate that the condition with the consecutive sequence number is executed. RLFS - Used to indicate that the action specified in the Rule False Action field is executed. 	Yes (Conditional) Note: This data is required while specifying the pricing eligibility criteria of the price component.

Tag Name	Tag Description	Mandatory (Yes or No)
	<ul style="list-style-type: none"> • RLTR - Used to indicate that the action specified in the Rule True Action field is executed. 	
isFalseFlag	<p>Used to indicate what should happen when the condition is false (not satisfied). The valid values are:</p> <ul style="list-style-type: none"> • COND - Used to indicate that the condition with the consecutive sequence number is executed. • RLFS - Used to indicate that the action specified in the Rule False Action field is executed. • RLTR - Used to indicate that the action specified in the Rule True Action field is executed. 	<p>Yes (Conditional)</p> <p>Note: This data is required while specifying the pricing eligibility criteria of the price component.</p>
isTrueFlag	<p>Used to indicate what should happen when the condition is true (satisfied). The valid values are:</p> <ul style="list-style-type: none"> • COND - Used to indicate that the condition with the consecutive sequence number is executed. • RLFS - Used to indicate that the action specified in the Rule False Action field is executed. • RLTR - Used to indicate that the action specified in the Rule True Action field is executed. 	<p>Yes (Conditional)</p> <p>Note: This data is required while specifying the pricing eligibility criteria of the price component.</p>
operator	<p>Used to indicate the relational operator used to define the relation between the parameter name and the parameter value. The valid values are:</p> <ul style="list-style-type: none"> • < • <= • <> • = • > • >= • BETWEEN • IN • LIKE • NOT IN 	<p>Yes (Conditional)</p> <p>Note: This data is required while specifying the pricing eligibility criteria of the price component.</p>
sequenceNumber	<p>Used to specify the order in which the pricing eligibility criteria is executed in the rule.</p>	<p>Yes (Conditional)</p>

Tag Name	Tag Description	Mandatory (Yes or No)
		Note: This data is required while specifying the pricing eligibility criteria of the price component.
priceCompSequenceNo	Used to specify the sequence number of the price component.	Yes
priceCompDesc	Used to specify the description for the price component.	No
valueAmt	Used to specify the rate for the price component.	Yes
priceComponentDisplay	Used to indicate whether the price component is displayed in the bill. The valid values are: <ul style="list-style-type: none"> • TRUE • FALSE 	Yes
rcMapId	Used to specify the identification value of the rate component for the price component.	Yes
tieredFlag	Used to specify the tiering type used for the price component. The valid values are: <ul style="list-style-type: none"> • FLAT • STEP • THRESHOLD 	Yes

Once the deal price assignment is updated, all the details of deal price assignment are listed in the above mentioned tags along with the following tags:

Tag Name	Tag Description
dealId	Displays the identification value of the deal whose price assignments you have updated. Note: The value in this tag appears when you specify the dealIdentifier or the modelId tag while creating the update request.
modelId	Displays the identification value of the deal version whose price assignments you have updated. Note: The value in this tag appears when you specify the dealIdentifier or the dealId tag while creating the update request.
entityIdentifierValue	Indicates the identifier using which the entity (i.e. existing or prospect person or account) is created in the system.
entityIdentifierType	Indicates the identifier type using which the entity (i.e. existing or prospect person or account) is created in the system.
entityDivision	Indicates the division to which the entity (i.e. existing or prospect person or account) belongs.
priceItemDescription	Displays the description of the price item.

Tag Name	Tag Description
hierarchyDetails	Displays the hierarchy to which the price item belongs.
assignmentLevel	Indicates the level at which the pricing is defined for the price item. The valid values are: <ul style="list-style-type: none"> • ACPI • CUPI • PCPI
priceCompId	Displays the identification value of the price component.

Note:

Only **RM** (Relationship Manager) can create the deal price assignment update request.

You can update only the agreed price assignments and not the inherited price assignments.

On processing the request, the system creates an agreed pricing for the entity of the deal in the **Proposed** status.

When you create a request to update a price assignment, the system replaces the price assignment data instead of editing it. Therefore, you should provide all details of the price assignment including the data that you want to change.

Related Topics

For more information on...	See...
Sample deal price assignment update request and response in the XML format	Sample Deal Price Assignment Update Request and Response in the XML Format on page 3894

Deal Price Assignment Recommend Request and Response - Tags in the XML Format

Note: We recommend you to refer the topics [Deal Price Assignment Recommend Request in the XML Format](#) on page 3845 and [Deal Price Assignment Recommend Response in the XML Format](#) on page 3847 in parallel while understanding the below mentioned tags. This will help you to understand how the tags are nested in the XML format.

Before calling the **C1-DealPriceAsgnCommitmentBS** business service through an inbound web service, you need to ensure that the deal price assignment recommend request contains the following tags:

Tag Name	Tag Description	Mandatory (Yes or No)
dealIdentifier	Used to specify the deal which is created using a particular identifier whose price assignments you want to recommend.	Yes (Conditional)
	Note: If you specify the dealIdentifier tag, you need not specify the dealId and the modelId tags.	Note: This data is required if you do not specify the dealId and modelId tags.
dealId	Used to specify the deal whose price assignments you want to recommend.	Yes (Conditional)
		Note: This data is required if you do not specify the dealIdentifier and modelId tags.

Tag Name	Tag Description	Mandatory (Yes or No)
	<p>Note:</p> <p>If you specify the dealId tag, you need not specify the dealIdentifier and the modelId tags.</p> <p>If the deal has multiple versions, then, you should specify the modelId tag instead of the dealId tag.</p>	
modelId	<p>Used to specify the deal version whose price assignments you want to recommend.</p> <p>Note: If you specify the modelId tag, you need not specify the dealIdentifier and the dealId tags.</p>	<p>Yes (Conditional)</p> <p>Note: This data is required if you do not specify the dealIdentifier and dealId tags.</p>
inquiryModeFlag	<p>Used to indicate whether you want to recommend the price assignments or the commitments of the price item. The valid value is:</p> <ul style="list-style-type: none"> • PRIC 	Yes
pricingcmtmntdtls	Used to specify the price assignment and commitment details for the entities (i.e. existing or prospect person or account) of the deal.	Yes
entityId	<p>Used to specify the entity (i.e. existing or prospect person or account) whose price assignments you want to recommend.</p> <p>Note:</p> <p>If you specify the entityType tag, you need to specify the entityId tag.</p> <p>The entityId should belong to the modelId.</p>	Yes
entityType	<p>Used to indicate the type of the entity (i.e. existing or prospect person or account) whose price assignments you want to recommend. The valid values are:</p> <ul style="list-style-type: none"> • ACCT • PERS <p>Note: If you specify the entityId tag, you need to specify the entityType tag.</p>	Yes
pricingdtls	Used to specify the price assignment details for the entity (i.e. existing or prospect person or account).	Yes

Tag Name	Tag Description	Mandatory (Yes or No)
priceAsgnId	Used to specify the identification value of the price assignment whose details you want to recommend.	Yes
	Note: The priceAsgnId should belong to the entityId .	
actionFlag	Used to indicate that you want to create request to recommend the price assignment of the entity (i.e. existing or prospect person or account) of the deal. The valid value is: <ul style="list-style-type: none"> RECM 	Yes
priceItemCode	Used to specify the price item whose price assignment you want to recommend for the entity (i.e. existing or prospect person or account) of the deal.	Yes
priceStatusFlag	Used to indicate the current status of the price item price assignment. The valid value is: <ul style="list-style-type: none"> RECM 	Yes
	Note: You can recommend a price assignment of a price item only when it is in the RECM status.	
priceCurrencyCode	Used to indicate the currency in which the price assignment is defined for the price item.	Yes
rateSchedule	Used to indicate the rate schedule using which the price assignment is defined for the price item.	Yes
startDate	Used to specify the date from when the price assignment of the price item is effective for the entity (i.e. existing or prospect person or account).	Yes
endDate	Used to specify the date till when the price assignment of the price item is effective for the entity (i.e. existing or prospect person or account).	No
isEligible	Used to indicate whether you want to define the eligibility criteria for the price assignment. The valid values are: <ul style="list-style-type: none"> FALSE TRUE 	No
paTypeFlag	Used to indicate the type of price assignment. The valid values are: <ul style="list-style-type: none"> POST PPIN 	Yes

Tag Name	Tag Description	Mandatory (Yes or No)
	<ul style="list-style-type: none"> • PPPR • RGLR 	
printlnZero	Used to indicate whether zero pricing should be displayed or not. The valid values are: <ul style="list-style-type: none"> • Y • N 	Yes
priceasgnchar	Used to specify a list of characteristics for the price assignment.	No
characteristicType	Used to indicate the characteristic type.	Yes (Conditional)
	Note: You must specify a characteristic type which is associated with the division to which the price item belongs.	Note: This data is required while defining a characteristic for the price assignment.
effectiveDate	Used to specify the date from when the characteristic is effective for price assignment.	Yes (Conditional)
		Note: This data is required while defining a characteristic for the price assignment.
characteristicValue	Used to specify the value for the characteristic type.	Yes (Conditional)
		Note: This data is required while defining a characteristic for the price assignment.
priceasgnparm	Used to specify a list of price item parameters which are used along with the price item for determining the price assignment.	No
priceParmCode	Used to indicate the pricing parameter which is associated with the price item.	Yes (Conditional)
	Note: If you specify the priceParmVal tag, you need to specify the priceParmCode tag.	Note: This data is required while specifying the price assignment parameters for the price item.
priceParmVal	Used to indicate the predefined pricing parameter value which is used for the price assignment.	Yes (Conditional)
	Note: If you specify the priceParmCode tag, you need to specify the priceParmVal tag.	Note: This data is required while specifying the price assignment parameters for the price item.
txnDailyRatingCrt	Used to indicate how and when the transaction legs mapped to the price item are rated. The valid values are: <ul style="list-style-type: none"> • DNRT • AGTR • RITA 	Yes

Tag Name	Tag Description	Mandatory (Yes or No)
	<ul style="list-style-type: none"> RITX 	
ignoreSw	<p>Used to indicate whether transaction mapped to price item pricing are considered for billing or not. The valid values are:</p> <ul style="list-style-type: none"> Y N 	No
doNotAggSw	<p>Used to indicate whether aggregation is required while rating the transactions mapped to the price item pricing before billing. The valid values are:</p> <ul style="list-style-type: none"> Y N 	No
scheduleCode	<p>Used to indicate the transaction aggregation cycle. The valid values are:</p> <ul style="list-style-type: none"> DAILY WEEKLY MONTHLY QUARTERLY YEARLY 	Yes
priceCompDetails	Used to specify the price component details of the rate component defined for the price item price assignment.	No
priceCompTier	Used to specify the tiering criteria of the price component.	No
toVal	Used to specify the upper limit of the pricing range.	Yes (Conditional) Note: This data is required while specifying the tiering criteria of the price component.
fromVal	Used to specify the lower limit of the pricing range.	Yes (Conditional) Note: This data is required while specifying the tiering criteria of the price component.
priceCriteria	Used to indicate the tiering criterion which is used in the tiering range.	Yes (Conditional) Note: This data is required while specifying the tiering criteria of the price component.
tieSeqNum	Used to indicate the tiering sequence number.	Yes (Conditional)

Tag Name	Tag Description	Mandatory (Yes or No)
		Note: This data is required while specifying the tiering criteria of the price component.
priceparm	Used to specify a list of parameters based on which the price items total usage is considered for determining the rate. Note: You should specify a value in this tag only when the Multi Price Parameter option type of the Multi Parameter Based Pricing (C1_PPARM_FLG) feature configuration is set to True .	No
priceParmCode	Used to indicate the parameter which is associated with the tiering criteria.	Yes (Conditional) Note: This data is required while specifying the parameters for the tiering criteria of the price component.
parameterVal	Used to specify the value for the parameter which is associated with the tiering criteria.	Yes (Conditional) Note: This data is required while specifying the parameters for the tiering criteria of the price component.
priceCompElig	Used to specify the pricing eligibility criteria for the price component. Note: You can specify the eligibility criteria for the price component only when the value in the isEligible tag is set to TRUE .	No
rhsPriceParmCd	Used to specify the parameter against which you want to compare the parameter (on the left hand side).	Yes (Conditional) Note: This data is required while specifying the pricing eligibility criteria of the price component.
rhsPriceParmVal	Used to specify the parameter value against which you want to compare the parameter (on the left hand side).	Yes (Conditional) Note: This data is required while specifying the pricing eligibility criteria of the price component.
lhsPriceParmCd	Used to specify the left hand side parameter which you want to use along with the price item for price determination.	Yes (Conditional) Note: This data is required while specifying the pricing eligibility criteria of the price component.

Tag Name	Tag Description	Mandatory (Yes or No)
rhsPriceParmTypeFlg	<p>Used to indicate whether the parameter (on the left hand side) is compared against another parameter (on the right hand side) or directly against a parameter value. The valid values are:</p> <ul style="list-style-type: none"> • PARAMETER - Used to indicate that the parameter (on the left hand side) is compared against another parameter (on the right hand side). • VALUE - Used to indicate that the parameter (on the left hand side) is compared against a parameter value. 	<p>Yes (Conditional)</p> <p>Note: This data is required while specifying the pricing eligibility criteria of the price component.</p>
isInsufficientFlag	<p>Used to indicate what should happen when the data is insufficient. The valid values are:</p> <ul style="list-style-type: none"> • COND - Used to indicate that the condition with the consecutive sequence number is executed. • RLFS - Used to indicate that the action specified in the Rule False Action field is executed. • RLTR - Used to indicate that the action specified in the Rule True Action field is executed. 	<p>Yes (Conditional)</p> <p>Note: This data is required while specifying the pricing eligibility criteria of the price component.</p>
isFalseFlag	<p>Used to indicate what should happen when the condition is false (not satisfied). The valid values are:</p> <ul style="list-style-type: none"> • COND - Used to indicate that the condition with the consecutive sequence number is executed. • RLFS - Used to indicate that the action specified in the Rule False Action field is executed. • RLTR - Used to indicate that the action specified in the Rule True Action field is executed. 	<p>Yes (Conditional)</p> <p>Note: This data is required while specifying the pricing eligibility criteria of the price component.</p>
isTrueFlag	<p>Used to indicate what should happen when the condition is true (satisfied). The valid values are:</p> <ul style="list-style-type: none"> • COND - Used to indicate that the condition with the consecutive sequence number is executed. • RLFS - Used to indicate that the action specified in the Rule False Action field is executed. • RLTR - Used to indicate that the action specified in the Rule True Action field is executed. 	<p>Yes (Conditional)</p> <p>Note: This data is required while specifying the pricing eligibility criteria of the price component.</p>

Tag Name	Tag Description	Mandatory (Yes or No)
operator	Used to indicate the relational operator used to define the relation between the parameter name and the parameter value. The valid values are: <ul style="list-style-type: none"> • < • <= • <> • = • > • >= • BETWEEN • IN • LIKE • NOT IN 	Yes (Conditional) Note: This data is required while specifying the pricing eligibility criteria of the price component.
sequenceNumber	Used to specify the order in which the pricing eligibility criteria is executed in the rule.	Yes (Conditional) Note: This data is required while specifying the pricing eligibility criteria of the price component.
priceCompSequenceNo	Used to specify the sequence number of the price component.	Yes
priceCompDesc	Used to specify the description for the price component.	No
valueAmt	Used to specify the rate for the price component.	Yes
priceComponentDisplay	Used to indicate whether the price component is displayed in the bill. The valid values are: <ul style="list-style-type: none"> • TRUE • FALSE 	Yes
rcMapId	Used to specify the identification value of the rate component for the price component.	Yes
tieredFlag	Used to specify the tiering type used for the price component. The valid values are: <ul style="list-style-type: none"> • FLAT • STEP • THRESHOLD 	Yes

Once the deal price assignment is recommended, all the details of deal price assignment are listed in the above mentioned tags along with the following tags:

Tag Name	Tag Description
dealId	Displays the identification value of the deal for which you have recommended the price assignments.
	Note: The value in this tag appears when you specify the dealIdentifier or the modelId tag while creating the recommend request.
modelId	Displays the identification value of the deal version for which you have recommended the price assignments.
	Note: The value in this tag appears when you specify the dealIdentifier or the dealId tag while creating the recommend request.
entityIdentifierValue	Indicates the identifier using which the entity (i.e. existing or prospect person or account) is created in the system.
entityIdentifierType	Indicates the identifier type using which the entity (i.e. existing or prospect person or account) is created in the system.
entityDivision	Indicates the division to which the entity (i.e. existing or prospect person or account) belongs.
priceItemDescription	Displays the description of the price item.
hierarchyDetails	Displays the hierarchy to which the price item belongs.
assignmentLevel	Indicates the level at which the pricing is defined for the price item. The valid values are: <ul style="list-style-type: none"> • ACPI • CUPI • PCPI
priceCompId	Displays the identification value of the price component.

Note:

Only **RM** (Relationship Manager) can create the deal price assignment recommend request.

You can recommend only the agreed price assignments and not the inherited price assignments.

On processing the request, the system creates an agreed pricing for the entity of the deal in the **Recommended** status.

When you create a request to recommend a price assignment, the system replaces the price assignment data instead of editing it. Therefore, you should provide all details of the price assignment including the data that you want to change.

Related Topics

For more information on...	See...
Sample deal price assignment recommend request and response in the XML format	Sample Deal Price Assignment Recommend Request and Response in the XML Format on page 3897

Deal Price Assignment Delete Request and Response - Tags in the XML Format

Note: We recommend you to refer the topics [Deal Price Assignment Delete Request in the XML Format](#) on page 3848 and [Deal Price Assignment Delete Response in the XML Format](#) on page 3849 in parallel while understanding the below mentioned tags. This will help you to understand how the tags are nested in the XML format.

Before calling the **C1-DealPriceAsgnCommitmentBS** business service through an inbound web service, you need to ensure that the deal price assignment delete request contains the following tags:

Tag Name	Tag Description	Mandatory (Yes or No)
dealIdentifier	Used to specify the deal which is created using a particular identifier whose price assignment you want to delete. Note: If you specify the dealIdentifier tag, you need not specify the dealId and the modelId tags.	Yes (Conditional) Note: This data is required if you do not specify the dealId and modelId tags.
dealId	Used to specify the deal whose price assignment you want to delete. Note: If you specify the dealId tag, you need not specify the dealIdentifier and the modelId tags. If the deal has multiple versions, then, you should specify the modelId tag instead of the dealId tag.	Yes (Conditional) Note: This data is required if you do not specify the dealIdentifier and modelId tags.
modelId	Used to specify the deal version whose price assignment you want to delete. Note: If you specify the modelId tag, you need not specify the dealIdentifier and the dealId tags.	Yes (Conditional) Note: This data is required if you do not specify the dealIdentifier and dealId tags.
inquiryModeFlag	Used to indicate whether you want to delete the price assignment or the commitments of the price item. The valid value is: • PRIC	Yes
pricingcmtmntdtls	Used to specify the price assignment and commitment details for the entities (i.e. existing or prospect person or account) of the deal.	Yes
entityId	Used to specify the entity (i.e. existing or prospect person or account) whose price assignment you want to delete. Note: If you specify the entityType tag, you need to specify the entityId tag. The entityId should belong to the modelId .	Yes
entityType	Used to indicate the type of the entity (i.e. existing or prospect person or account) whose price assignment you want to delete. The valid values are:	Yes

Tag Name	Tag Description	Mandatory (Yes or No)
	<ul style="list-style-type: none"> ACCT PERS <p>Note: If you specify the entityId tag, you need to specify the entityType tag.</p>	
pricingdtls	Used to specify the price assignment details for the entity (i.e. existing or prospect person or account).	Yes
priceAsgnId	Used to specify the identification value of the price assignment whose details you want to delete.	Yes
	Note: The priceAsgnId should belong to the entityId .	
actionFlag	Used to indicate that you want to create request to delete the price assignment of the entity (i.e. existing or prospect person or account) of the deal. The valid value is: <ul style="list-style-type: none"> DEL 	Yes

Once the deal price assignment is deleted, all the details of deal price assignment are listed in the above mentioned tags along with the following tag:

Tag Name	Tag Description
isEligible	Indicates the eligibility criteria of the deleted price assignment. The valid values are: <ul style="list-style-type: none"> FALSE TRUE

Note:

Only **RM** (Relationship Manager) can delete the price assignment which is in the **Proposed** status. Whereas, only the **PM** (Product Manager) can delete the price assignment which is in the **Recommended** status.

You cannot delete a price list price assignment.

You cannot delete the same price assignment twice.

Related Topics

For more information on...	See...
Sample deal price assignment delete request and response in the XML format	Sample Deal Price Assignment Delete Request and Response in the XML Format on page 3899

Deal Price Assignment and Commitments View Request and Response - Tags in the XML Format

Note: We recommend you to refer the topics [Deal Price Assignment and Commitments View Request in the XML Format](#) on page 3849 and [Deal Price Assignment and Commitments View Response in the XML Format](#) on page 3849 in parallel while understanding the below mentioned tags. This will help you to understand how the tags are nested in the XML format.

Before calling the **C1-DealPriceAsgnCommitmentBS** business service through an inbound web service, you need to ensure that the deal price assignment and commitments view request contains the following tags:

Tag Name	Tag Description	Mandatory (Yes or No)
dealIdentifier	<p>Used to specify the deal which is created using a particular identifier whose price assignments and commitments you want to view.</p> <p>Note: If you specify the dealIdentifier tag, you need not specify the dealId and the modelId tags. If the deal has multiple versions, then, you should specify the modelId tag instead of the dealIdentifier tag.</p>	<p>Yes (Conditional)</p> <p>Note: This data is required if you do not specify the dealId and modelId tags.</p>
dealId	<p>Used to specify the deal whose price assignments and commitments you want to view.</p> <p>Note: If you specify the dealId tag, you need not specify the dealIdentifier and the modelId tags. If the deal has multiple versions, then, you should specify the modelId tag instead of the dealId tag.</p>	<p>Yes (Conditional)</p> <p>Note: This data is required if you do not specify the dealIdentifier and modelId tags.</p>
modelId	<p>Used to specify the deal version whose price assignments and commitments you want to view.</p> <p>Note: If you specify the modelId tag, you need not specify the dealIdentifier and the dealId tags.</p>	<p>Yes (Conditional)</p> <p>Note: This data is required if you do not specify the dealIdentifier and dealId tags.</p>
actionflag	<p>Used to indicate that you want to create request to view the price assignment and commitments of the entities in the customer hierarchy of the deal. The valid value is:</p> <ul style="list-style-type: none"> • READ 	Yes
inquiryModeFlag	<p>Used to indicate that you want to view the price assignments and commitments of the entities in the customer hierarchy of the deal. The valid value is:</p> <ul style="list-style-type: none"> • BOTH 	Yes

Once the deal price assignment and commitments view request is created, all the details of the deal price assignment and commitments are listed in the above mentioned tags along with the following tags:

Tag Name	Tag Description
pricingcmntmtdtls	Displays the price assignment and commitment details of the entity in the customer hierarchy of the deal.
entityId	Displays the entity whose price assignment and commitment details you are viewing.
entityType	Indicates the type of the entity whose price assignment and commitment details you are viewing. The valid values are: <ul style="list-style-type: none"> • ACCT • PERS
entityIdentifierValue	Displays the value of the identifier type using which the entity is created in the system.
entityIdentifierType	Indicates the identifier type using which the entity is created in the system.
entityDivision	Indicates the division to which the entity belongs.
pricingdtls	Displays the price assignment details of the entity in the customer hierarchy of the deal.
priceAsgnId	Displays the identification value of the price assignment for the entity whose price assignment details you are viewing.
priceItemCode	Displays the price item whose price assignment details you are viewing.
priceItemDescription	Displays the description of the price item.
hierarchyDetails	Displays the root level and/or non-root level hierarchy entity to which the price item belongs.
priceStatusFlag	Indicates the current status of the price assignment.
priceCurrencyCode	Indicates the currency in which the price assignment is defined for the price item.
rateSchedule	Indicates the rate schedule using which the price assignment is defined for the price item.
startDate	Displays the date from when the price assignment of the price item is effective for the entity.
endDate	Displays the date till when the price assignment of the price item is effective for the entity.
isEligible	Indicates whether the eligibility criteria for the price assignment is defined or not. The valid values are: <ul style="list-style-type: none"> • FALSE • TRUE
assignmentLevel	Indicates the level at which the pricing is defined for the price item. The valid values are: <ul style="list-style-type: none"> • ACPI • CUPI • PCPI
paTypeFlag	Indicates the type of price assignment. The valid values are:

Tag Name	Tag Description
	<ul style="list-style-type: none"> • POST • PPIN • PPPR • RGLR
printIfZero	Indicates whether zero pricing is displayed or not. The valid values are: <ul style="list-style-type: none"> • Y • N
priceasgnchar	Displays a list of characteristics defined for the price assignment.
characteristicType	Indicates the characteristic type.
effectiveDate	Displays the date from when the characteristic is effective for price assignment.
characteristicValue	Displays the value of the characteristic type.
priceasgnparm	Displays the list of price item parameters which are used along with the price item for determining the price assignment.
priceParmCode	Indicates the pricing parameter which is associated with the price item.
priceParmVal	Indicates the predefined pricing parameter value which is used for the price assignment.
txnDailyRatingCrt	Indicates how and when the transaction legs mapped to the price item are rated. The valid values are: <ul style="list-style-type: none"> • DNRT • AGTR • RITA • RITX
ignoreSw	Indicates whether transaction mapped to price item pricing are considered for billing or not. The valid values are: <ul style="list-style-type: none"> • Y • N
doNotAggSw	Indicates whether aggregation is required while rating the transactions mapped to the price item pricing before billing or not. The valid values are: <ul style="list-style-type: none"> • Y • N
scheduleCode	Indicates the transaction aggregation cycle. The valid values are: <ul style="list-style-type: none"> • DAILY • WEEKLY • MONTHLY • QUARTERLY • YEARLY

Tag Name	Tag Description
priceCompDetails	Displays the price component details of the rate component defined for the price item price assignment.
priceCompTier	Displays the tiering criteria of the price component.
toVal	Displays the upper limit of the pricing range.
fromVal	Displays the lower limit of the pricing range.
priceCriteria	Indicates the tiering criterion which is used in the tiering range.
tieSeqNum	Indicates the tiering sequence number.
priceparm	<p>Displays the list of parameters based on which the price items total usage is considered for determining the rate.</p> <p>Note: The value in this tag appears only when the Multi Price Parameter option type of the Multi Parameter Based Pricing (C1_PPARM_FLG) feature configuration is set to True.</p>
priceParmCode	Indicates the parameter which is associated with the tiering criteria.
parameterVal	Displays the value for the parameter which is associated with the tiering criteria.
priceCompElig	<p>Displays the pricing eligibility criteria defined for the price component.</p> <p>Note: The value in this tag appears only when the isEligible tag is set to TRUE and the eligibility criteria is defined for the price component.</p>
rhsPriceParmCd	Displays the parameter against which you want to compare the parameter (on the left hand side).
rhsPriceParmVal	Displays the parameter value against which you want to compare the parameter (on the left hand side).
lhsPriceParmCd	Displays the left hand side parameter which you want to use along with the price item for price determination.
rhsPriceParmTypeFlg	<p>Indicates whether the parameter (on the left hand side) is compared against another parameter (on the right hand side) or directly against a parameter value. The valid values are:</p> <ul style="list-style-type: none"> • PARAMETER - Indicates that the parameter (on the left hand side) is compared against another parameter (on the right hand side). • VALUE - Indicates that the parameter (on the left hand side) is compared against a parameter value.
isInsufficientFlag	<p>Indicates what should happen when the data is insufficient. The valid values are:</p> <ul style="list-style-type: none"> • COND - Indicates that the condition with the consecutive sequence number is executed. • RLFS - Indicates that the action specified in the Rule False Action field is executed. • RLTR - Indicates that the action specified in the Rule True Action field is executed.
isFalseFlag	Indicates what should happen when the condition is false (not satisfied). The valid values are:

Tag Name	Tag Description
	<ul style="list-style-type: none"> • COND - Indicates that the condition with the consecutive sequence number is executed. • RLFS - Indicates that the action specified in the Rule False Action field is executed. • RLTR - Indicates that the action specified in the Rule True Action field is executed.
isTrueFlag	<p>Indicates what should happen when the condition is true (satisfied). The valid values are:</p> <ul style="list-style-type: none"> • COND - Indicates that the condition with the consecutive sequence number is executed. • RLFS - Indicates that the action specified in the Rule False Action field is executed. • RLTR - Indicates that the action specified in the Rule True Action field is executed.
operator	<p>Indicates the relational operator used to define the relation between the parameter name and the parameter value. The valid values are:</p> <ul style="list-style-type: none"> • < • <= • <> • = • > • >= • BETWEEN • IN • LIKE • NOT IN
sequenceNumber	Displays the order in which the pricing eligibility criteria is executed in the rule.
priceCompSequenceNo	Displays the sequence number of the price component.
priceCompId	Displays the identification value of the price component.
priceCompDesc	Displays the description for the price component.
valueAmt	Displays the rate of the price component.
priceComponentDisplay	<p>Indicates whether the price component is displayed in the bill or not. The valid values are:</p> <ul style="list-style-type: none"> • TRUE • FALSE
rcMapId	Displays the identification value of the rate component for the price component.
tieredFlag	<p>Displays the tiering type used for the price component. The valid values are:</p> <ul style="list-style-type: none"> • FLAT

Tag Name	Tag Description
	<ul style="list-style-type: none"> STEP THRESHOLD
commitmentDetails	Displays the price item commitment details for the entity (i.e. existing or prospect person or account).
priceItemCode	Displays the price item whose commitment details you are viewing.
priceItemDescription	Displays the description of the price item.
parameterDetails	Displays the list of parameters based on which the effective pricing is defined for the price item.
parameterCode	Displays the parameter based on which the effective pricing is defined for the price item.
parameterValue	Displays the value of the parameter.
SQIDetails	Displays the service quantity identifier details of the price item.
serviceQuantityIdentifier	Displays the service quantity identifier associated with the price item.
sqiValue	Displays the SQI value for the price item and parameter combination that you want to use for calculating the price item pricing.
sqiTypeFlg	Indicates the status of the service quantity identifier details for calculating the price item pricing.

Related Topics

For more information on...	See...
Sample deal price assignment and commitments view request and response in the XML format	Sample Deal Price Assignment and Commitments View Request and Response in the XML Format on page 3900

Deal Commitments Add Request and Response - Tags in the XML Format

Note: We recommend you to refer the topics [Deal Commitments Add Request in the XML Format](#) on page 3851 and [Deal Commitments Add Response in the XML Format](#) on page 3852 in parallel while understanding the below mentioned tags. This will help you to understand how the tags are nested in the XML format.

Before calling the **C1-DealPriceAsgnCommitmentBS** business service through an inbound web service, you need to ensure that the deal commitments add request contains the following tags:

Tag Name	Tag Description	Mandatory (Yes or No)
dealIdentifier	Used to specify the deal which is created using a particular identifier whose commitments you want to add.	Yes (Conditional)
	Note: If you specify the dealIdentifier tag, you need not specify the dealId and the modelId tags.	Note: This data is required if you do not specify the dealId and modelId tags.
dealId	Used to specify the deal for which you want to add commitments.	Yes (Conditional)

Tag Name	Tag Description	Mandatory (Yes or No)
	<p>Note:</p> <p>If you specify the dealId tag, you need not specify the dealIdentifier and the modelId tags.</p> <p>If the deal has multiple versions, then, you should specify the modelId tag instead of the dealId tag.</p>	<p>Note: This data is required if you do not specify the dealIdentifier and modelId tags.</p>
modelId	<p>Used to specify the deal version for which you want to add commitments.</p> <p>Note: If you specify the modelId tag, you need not specify the dealIdentifier and the dealId tags.</p>	<p>Yes (Conditional)</p> <p>Note: This data is required if you do not specify the dealIdentifier and dealId tags.</p>
inquiryModeFlag	<p>Used to indicate whether you want to add price assignments or commitments of the price item for the deal. The valid value is:</p> <ul style="list-style-type: none"> • COMT 	Yes
pricingcmtmntdttl	Used to specify the price assignment and commitment details for the entities (i.e. existing or prospect person or account) of the deal.	Yes
entityId	<p>Used to specify the entity (i.e. existing or prospect person or account) whose price items commitments you want to add.</p> <p>Note:</p> <p>If you specify the entityType tag, you need to specify the entityId tag.</p> <p>The entityId should belong to the modelId.</p>	Yes
entityType	<p>Used to indicate the type of the entity (i.e. existing or prospect person or account) whose price items commitments you want to add. The valid values are:</p> <ul style="list-style-type: none"> • ACCT • PERS <p>Note: If you specify the entityId tag, you need to specify the entityType tag.</p>	Yes
commitmentDetails	Used to specify the price item commitment details for the entity (i.e. existing or prospect person or account).	Yes
priceItemCode	Used to specify the price item whose commitments you want to add for the entity (i.e.	Yes

Tag Name	Tag Description	Mandatory (Yes or No)
	existing or prospect person or account) of the deal.	
priceItemDescription	Used to specify the description of the price item.	No
parameterDetails	Used to specify the parameters based on which the effective pricing is defined for the price item.	Yes
parameterCode	Used to specify the parameter.	Yes
parameterValue	Used to specify the value of the parameter.	Yes
SQIDetails	Used to specify the service quantity identifier details of the price item.	Yes
serviceQuantityIdentifier	Used to specify the service quantity identifier associated with the price item.	Yes
sqiValue	Used to specify the SQI value for the price item and parameter combination that you want to use for calculating the price item pricing.	Yes
sqiTypeFlg	Used to indicate the status of the service quantity identifier details for calculating the price item pricing. The valid value is: <ul style="list-style-type: none"> • PRPD 	Yes
actionFlag	Used to specify that you want to create request to add commitments for the deal. The valid value is: <ul style="list-style-type: none"> • ADD 	Yes

Once the deal commitments are added, all the details of deal commitments are listed in the above mentioned tags along with the following tags:

Tag Name	Tag Description
dealId	Displays the identification value of the deal for which you have added the commitments. Note: The value in this tag appears when you specify the dealIdentifier or the modelId tag while creating the add request.
modelId	Displays the identification value of the deal for which you have added the commitments. Note: The value in this tag appears when you specify the dealIdentifier or the dealId tag while creating the add request.

Note:

Only **RM** (Relationship Manager) can create the deal commitments add request.

You can add commitments for a price item only when the price item and the parameter combination is valid.

Related Topics

For more information on...	See...
Sample deal commitments add request and response in the XML format	Sample Deal Commitments Add Request and Response in the XML Format on page 3902

Deal Commitments Update Request and Response - Tags in the XML Format

Note: We recommend you to refer the topics [Deal Commitments Update Request in the XML Format](#) on page 3852 and [Deal Commitments Update Response in the XML Format](#) on page 3853 in parallel while understanding the below mentioned tags. This will help you to understand how the tags are nested in the XML format.

Before calling the **C1-DealPriceAsgnCommitmentBS** business service through an inbound web service, you need to ensure that the deal commitments update request contains the following tags:

Tag Name	Tag Description	Mandatory (Yes or No)
dealIdentifier	Used to specify the deal which is created using a particular identifier whose commitments you want to update. Note: If you specify the dealIdentifier tag, you need not specify the dealId and the modelId tags.	Yes (Conditional) Note: This data is required if you do not specify the dealId and modelId tags.
dealId	Used to specify the deal whose commitments you want to update. Note: If you specify the dealId tag, you need not specify the dealIdentifier and the modelId tags. If the deal has multiple versions, then, you should specify the modelId tag instead of the dealId tag.	Yes (Conditional) Note: This data is required if you do not specify the dealIdentifier and modelId tags.
modelId	Used to specify the deal version whose commitments you want to update. Note: If you specify the modelId tag, you need not specify the dealIdentifier and the dealId tags.	Yes (Conditional) Note: This data is required if you do not specify the dealIdentifier and dealId tags.
inquiryModeFlag	Used to indicate whether you want to update the price assignments or the commitments of the price item for the deal. The valid value is: • COMT	Yes
pricingcmtmndtcls	Used to specify the price assignment and commitment details for the entities (i.e. existing or prospect person or account) of the deal.	Yes
entityId	Used to specify the entity (i.e. existing or prospect person or account) whose price items commitments you want to update.	Yes

Tag Name	Tag Description	Mandatory (Yes or No)
	<p>Note:</p> <p>If you specify the entityType tag, you need to specify the entityId tag.</p> <p>The entityId should belong to the modelId.</p>	
entityType	<p>Used to indicate the type of the entity (i.e. existing or prospect person or account) whose price items commitments you want to update. The valid values are:</p> <ul style="list-style-type: none"> • ACCT • PERS <p>Note: If you specify the entityId tag, you need to specify the entityType tag.</p>	Yes
commitmentDetails	Used to specify the price item commitment details for the entity (i.e. existing or prospect person or account).	Yes
priceItemCode	Used to specify the price item whose commitments you want to update for the entity (i.e. existing or prospect person or account) of the deal.	Yes
priceItemDescription	Used to specify the description of the price item.	No
parameterDetails	Used to specify the parameters based on which the effective pricing is defined for the price item.	Yes
parameterCode	Used to specify the parameter.	Yes
parameterValue	Used to specify the value of the parameter.	Yes
SQIDetails	Used to specify the service quantity identifier details of the price item.	Yes
serviceQuantityIdentifier	Used to specify the service quantity identifier associated with the price item.	Yes
sqiValue	Used to specify the SQI value for the price item and parameter combination that you want to update for calculating the price item pricing.	Yes
sqiTypeFlg	Used to indicate the status of the service quantity identifier details for calculating the price item pricing. The valid value is: <ul style="list-style-type: none"> • PRPD 	Yes
actionFlag	Used to specify that you want to create request to update commitments for the deal. The valid value is: <ul style="list-style-type: none"> • UPD 	Yes

Once the deal commitments are updated, all the details of deal commitments are listed in the above mentioned tags along with the following tags:

Tag Name	Tag Description
dealId	Displays the identification value of the deal for which you have added the commitments. Note: The value in this tag appears when you specify the dealIdentifier or the modelId tag while creating the update request.
modelId	Displays the identification value of the deal for which you have added the commitments. Note: The value in this tag appears when you specify the dealIdentifier or the dealId tag while creating the update request.

Note:

Only **RM** (Relationship Manager) can create the deal commitments update request.

You can update commitments for a price item only when the price item and the parameter combination is valid.

Related Topics

For more information on...	See...
Sample deal commitments update request and response in the XML format	Sample Deal Commitments Update Request and Response in the XML Format on page 3903

Sample Deal Price Assignment Override Request and Response in the XML Format

Using the below example, you can override the price assignment.

Sample Price Assignment Override Request in the XML Format

```
<C1-DealPriceAsgnCommitmentBS>
  <modelId>9490517725</modelId>
  <inquiryModeFlag>PRIC</inquiryModeFlag>
  <pricingcmtdtls>
    <entityId>2762026417</entityId>
    <entityType>PERS</entityType>
  </pricingcmtdtls>
  <pricingdtls>
    <priceAsgnId>6810091985</priceAsgnId>
    <actionFlag>OVRD</actionFlag>
    <priceItemCode>DEAL_MULTIPARAM1</priceItemCode>
    <priceStatusFlag>PRPD</priceStatusFlag>
    <priceCurrencyCode>USD</priceCurrencyCode>
    <rateSchedule>BK-THRES</rateSchedule>
    <startDate>2022-02-13</startDate>
    <endDate>2023-02-12</endDate>
    <isEligible>>true</isEligible>
    <paTypeFlag>RGLR</paTypeFlag>
    <printIfZero>Y</printIfZero>
  </pricingdtls>
  <priceasgnchar>
    <characteristicType>DEALID</characteristicType>
    <effectiveDate>2022-04-05</effectiveDate>
    <characteristicValue>2520094042</characteristicValue>
  </priceasgnchar>
  <priceasgnchar>
    <characteristicType>C2CLTYPE</characteristicType>
```

```

        <effectiveDate>2022-04-05</effectiveDate>
        <characteristicValue>2520094042</characteristicValue>
    </priceasgnchar>
    <priceasgnparm>
        <priceParmCode>COUNTRY</priceParmCode>
        <priceParmVal>BHARAT</priceParmVal>
    </priceasgnparm>
    <txnDailyRatingCrt>DNRT</txnDailyRatingCrt>
    <ignoreSw>N</ignoreSw>
    <doNotAggSw>N</doNotAggSw>
    <scheduleCode>MONTHLY</scheduleCode>
    <pricecompdtls>
        <priceCompTier>
            <toVal>100</toVal>
            <fromVal>1</fromVal>
            <priceCriteria>BK-NBR</priceCriteria>
            <tieSeqNum>10</tieSeqNum>
            <priceparm>
                <parmCodeType>STATE</parmCodeType>
                <priceParmCode>MAHARASHTRA</priceParmCode>
            </priceparm>
        </priceCompTier>
        <priceCompElg>
            <rhsPriceParmCd>ACCESSGRP</rhsPriceParmCd>
            <rhsPriceParmVal>System Default</rhsPriceParmVal>
            <lhsPriceParmCd>AGEBASED</lhsPriceParmCd>
            <rhsPriceParmTypeFlg>PRM</rhsPriceParmTypeFlg>
            <isInsufficientFlag>RLFS</isInsufficientFlag>
            <isFalseFlag>RLFS</isFalseFlag>
            <isTrueFlag>RLTR</isTrueFlag>
            <operator>=</operator>
            <sequenceNumber>0</sequenceNumber>
        </priceCompElg>
        <priceCompSequenceNo>20</priceCompSequenceNo>
        <priceCompDesc>No of transaction</priceCompDesc>
        <valueAmt>45</valueAmt>
        <priceComponentDisplay>true</priceComponentDisplay>
        <rcMapId>3999784532</rcMapId>
        <tieredFlag>THRS</tieredFlag>
    </pricecompdtls>
</pricingdtls>
</pricingcmtmtdtls>
</C1-DealPriceAsgnCommitmentBS>

```

Note: If you do not want to enter the data in the list tags (i.e. tags where the type is set to list), you should not include them in the request. Adding empty list tags will give erroneous results.

Sample Price Assignment Override Response in the XML Format

```

<C1-DealPriceAsgnCommitmentBS>
    <dealIdentifier>RuleBUGFixing22</dealIdentifier>
    <dealId>2510739370</dealId>
    <modelId>9490517725</modelId>
    <pricingcmtmtdtls>
        <entityId>2762026417</entityId>
        <entityType>PERS</entityType>
        <entityIdentifierValue>123-12-1234</entityIdentifierValue>
        <entityIdentifierType>Social security number</entityIdentifierType>
        <entityDivision>930-California</entityDivision>
    </pricingdtls>
        <priceAsgnId>6810091985</priceAsgnId>
        <actionFlag>OVRD</actionFlag>
        <priceItemCode>DEAL_MULTIPARAM1</priceItemCode>

```



```

<priceItemDescription>Deal_MultiParam</priceItemDescription>
<hierarchyDetails>RECMAVR,RECMAVR</hierarchyDetails>
<priceStatusFlag>PRPD</priceStatusFlag>
<priceCurrencyCode>USD</priceCurrencyCode>
<rateSchedule>BK-THRES</rateSchedule>
<startDate>2022-02-13</startDate>
<endDate>2023-02-12</endDate>
<isEligible>>true</isEligible>
<assignmentLevel>CUPI</assignmentLevel>
<paTypeFlag>RGLR</paTypeFlag>
<printIfZero>Y</printIfZero>
<priceasgnchar>
  <characteristicType>DEALID</characteristicType>
  <effectiveDate>2022-04-05</effectiveDate>
  <characteristicValue>2520094042</characteristicValue>
</priceasgnchar>
<priceasgnchar>
  <characteristicType>C2CLTYPE</characteristicType>
  <effectiveDate>2022-04-05</effectiveDate>
  <characteristicValue>2520094042</characteristicValue>
</priceasgnchar>
<priceasgnparm>
  <priceParmCode>COUNTRY</priceParmCode>
  <priceParmVal>BHARAT</priceParmVal>
</priceasgnparm>
<txnDailyRatingCrt>DNRT</txnDailyRatingCrt>
<ignoreSw>N</ignoreSw>
<doNotAggSw>N</doNotAggSw>
<scheduleCode>MONTHLY</scheduleCode>
<pricecompdtls>
  <priceCompTier>
    <priceCompSequenceNo>20</priceCompSequenceNo>
    <toVal>100</toVal>
    <fromVal>1</fromVal>
    <priceCriteria>BK-NBR</priceCriteria>
    <tieSeqNum>10</tieSeqNum>
    <priceparm>
      <parmCodeType>STATE</parmCodeType>
      <priceParmCode>MAHARASHTRA</priceParmCode>
    </priceparm>
  </priceCompTier>
  <priceCompElg>
    <rhsPriceParmCd>ACCESSGRP</rhsPriceParmCd>
    <rhsPriceParmVal>System Default</rhsPriceParmVal>
    <lhsPriceParmCd>AGEBASED</lhsPriceParmCd>
    <rhsPriceParmTypeFlg>PRM</rhsPriceParmTypeFlg>
    <isInsufficientFlag>RLFS</isInsufficientFlag>
    <isFalseFlag>RLFS</isFalseFlag>
    <isTrueFlag>RLTR</isTrueFlag>
    <operator>=</operator>
    <sequenceNumber>0</sequenceNumber>
  </priceCompElg>
  <priceCompSequenceNo>20</priceCompSequenceNo>
  <priceCompId>2341932341</priceCompId>
  <priceCompDesc>No of transaction</priceCompDesc>
  <valueAmt>45.000000000000000000</valueAmt>
  <priceComponentDisplay>true</priceComponentDisplay>
  <rcMapId>3999784532</rcMapId>
  <tieredFlag>THRS</tieredFlag>
</pricecompdtls>
</pricingDetails>
</pricingcmtmtdtls>
</C1-DealPriceAsgnCommitmentBS>

```

Note: We have given the above request and response samples to illustrate how the tags should be nested while sending a deal price assignment override request from the external system. However, you should not seamlessly use this request sample in your environment because the required pre-requisite data may not be available in your environment. In such case, the system will give erroneous results.

Related Topics

For more information on...	See...
Deal price assignment override request and response tags in the XML format	Deal Price Assignment Override Request and Response - Tags in the XML Format on page 3854

Sample Deal Price Assignment Update Request and Response in the XML Format

Using the below example, you can update the price assignment.

Sample Price Assignment Update Request in the XML Format

```
<C1-DealPriceAsgnCommitmentBS>
  <modelId>4215246178</modelId>
  <inquiryModeFlag>PRIC</inquiryModeFlag>
  <pricingcmtdtls>
    <entityId>7829433453</entityId>
    <entityType>PERS</entityType>
    <pricingdtls>
      <priceAsgnId>8250010306</priceAsgnId>
      <actionFlag>UPD</actionFlag>
      <priceItemCode>PI_028</priceItemCode>
      <priceStatusFlag>PRPD</priceStatusFlag>
      <priceCurrencyCode>USD</priceCurrencyCode>
      <rateSchedule>DM-RT01</rateSchedule>
      <startDate>2022-02-13</startDate>
      <endDate>2023-02-12</endDate>
      <isEligible>>true</isEligible>
      <paTypeFlag>RGLR</paTypeFlag>
      <printIfZero>Y</printIfZero>
      <priceasgnchar>
        <characteristicType>DEALID</characteristicType>
        <effectiveDate>2022-04-05</effectiveDate>
        <characteristicValue>2520094042</characteristicValue>
      </priceasgnchar>
      <priceasgnchar>
        <characteristicType>C2CLTYPE</characteristicType>
        <effectiveDate>2022-04-05</effectiveDate>
        <characteristicValue>2520094042</characteristicValue>
      </priceasgnchar>
      <priceasgnparm>
        <priceParmCode>DM_CURRENCY</priceParmCode>
        <priceParmVal>INR</priceParmVal>
      </priceasgnparm>
      <priceasgnparm>
        <priceParmCode>DM_TYPE</priceParmCode>
        <priceParmVal>BT</priceParmVal>
      </priceasgnparm>
      <txnDailyRatingCrt>DNRT</txnDailyRatingCrt>
      <ignoreSw>N</ignoreSw>
      <doNotAggSw>Y</doNotAggSw>
      <scheduleCode>MONTHLY</scheduleCode>
    </pricingdtls>
    <pricecompdtls>
      <priceCompTier>
        <toVal>100</toVal>
        <fromVal>1</fromVal>
        <priceCriteria>BK-NBR</priceCriteria>
      </priceCompTier>
    </pricecompdtls>
  </pricingcmtdtls>
</C1-DealPriceAsgnCommitmentBS>
```

```

        <tieSeqNum>10</tieSeqNum>
        <priceparm>
            <parmCodeType>STATE</parmCodeType>
            <priceParmCode>MAHARASHTRA</priceParmCode>
        </priceparm>
    </priceCompTier>
</priceCompElg>
    <rhsPriceParmCd>ACCESSGRP</rhsPriceParmCd>
    <rhsPriceParmVal>System Default</rhsPriceParmVal>
    <lhsPriceParmCd>AGEBASED</lhsPriceParmCd>
    <rhsPriceParmTypeFlg>PRM</rhsPriceParmTypeFlg>
    <isInsufficientFlag>RLFS</isInsufficientFlag>
    <isFalseFlag>RLFS</isFalseFlag>
    <isTrueFlag>RLTR</isTrueFlag>
    <operator>=</operator>
    <sequenceNumber>0</sequenceNumber>
</priceCompElg>
<priceCompSequenceNo>10</priceCompSequenceNo>
<priceCompDesc>No of transaction</priceCompDesc>
<valueAmt>1.5</valueAmt>
<priceComponentDisplay>>true</priceComponentDisplay>
<rcMapId>1705351562</rcMapId>
<tieredFlag>THRS</tieredFlag>
</pricecompdtls>
</pricingdtls>
</pricingcmtmtdtls>
</Cl-DealPriceAsgnCommitmentBS>

```

Note: If you do not want to enter the data in the list tags (i.e. tags where the type is set to list), you should not include them in the request. Adding empty list tags will give erroneous results.

Sample Price Assignment Update Response in the XML Format

```

<Cl-DealPriceAsgnCommitmentBS>
    <dealIdentifier>DEAL_EPER_PRIC_N_COMT_001_V1</dealIdentifier>
    <dealId>6478126328</dealId>
    <modelId>4215246178</modelId>
    <pricingcmtmtdtls>
        <entityId>7829433453</entityId>
        <entityType>PERS</entityType>
        <entityIdentifierValue>123-12-1234</entityIdentifierValue>
        <entityIdentifierType>Social security number</entityIdentifierType>
        <entityDivision>930-California</entityDivision>
    </pricingdtls>
    <priceAsgnId>8250010306</priceAsgnId>
    <actionFlag>UPD</actionFlag>
    <priceItemCode>PI_028</priceItemCode>
    <priceItemDescription>V8-Cheque Collections</priceItemDescription>
    <hierarchyDetails>CORPORATE BANKING, REPORTING /SWIFT</
hierarchyDetails>
    <priceStatusFlag>PRPD</priceStatusFlag>
    <priceCurrencyCode>USD</priceCurrencyCode>
    <rateSchedule>DM-RT01</rateSchedule>
    <startDate>2022-02-13</startDate>
    <endDate>2023-02-12</endDate>
    <isEligible>true</isEligible>
    <assignmentLevel>Customer Agreed</assignmentLevel>
    <paTypeFlag>RGLR</paTypeFlag>
    <printIfZero>Y</printIfZero>
    <priceasgnchar>
        <characteristicType>DEALID</characteristicType>
        <effectiveDate>2022-04-05</effectiveDate>
        <characteristicValue>2520094042</characteristicValue>

```

```

</priceasgnchar>
<priceasgnchar>
  <characteristicType>C2CLTYPE</characteristicType>
  <effectiveDate>2022-04-05</effectiveDate>
  <characteristicValue>2520094042</characteristicValue>
</priceasgnchar>
<priceasgnparm>
  <priceParmCode>DM_CURRENCY</priceParmCode>
  <priceParmVal>INR</priceParmVal>
</priceasgnparm>
<priceasgnparm>
  <priceParmCode>DM_TYPE</priceParmCode>
  <priceParmVal>BT</priceParmVal>
</priceasgnparm>
<txnDailyRatingCrt>DNRT</txnDailyRatingCrt>
<ignoreSw>N</ignoreSw>
<doNotAggSw>Y</doNotAggSw>
<scheduleCode>MONTHLY</scheduleCode>
<pricecompdtls>
  <priceCompTier>
    <priceCompSequenceNo>20</priceCompSequenceNo>
    <toVal>100</toVal>
    <fromVal>1</fromVal>
    <priceCriteria>BK-NBR</priceCriteria>
    <tieSeqNum>10</tieSeqNum>
    <priceparm>
      <parmCodeType>STATE</parmCodeType>
      <priceParmCode>MAHARASHTRA</priceParmCode>
    </priceparm>
  </priceCompTier>
  <priceCompElg>
    <rhsPriceParmCd>ACCESSGRP</rhsPriceParmCd>
    <rhsPriceParmVal>System Default</rhsPriceParmVal>
    <lhsPriceParmCd>AGEBASED</lhsPriceParmCd>
    <rhsPriceParmTypeFlg>PRM</rhsPriceParmTypeFlg>
    <isInsufficientFlag>RLFS</isInsufficientFlag>
    <isFalseFlag>RLFS</isFalseFlag>
    <isTrueFlag>RLTR</isTrueFlag>
    <operator>=</operator>
    <sequenceNumber>0</sequenceNumber>
  </priceCompElg>
  <priceCompSequenceNo>10</priceCompSequenceNo>
  <priceCompId>8258025006</priceCompId>
  <priceCompDesc>No of transaction</priceCompDesc>
  <valueAmt>1.5000000000000000</valueAmt>
  <priceComponentDisplay>true</priceComponentDisplay>
  <rcMapId>1705351562</rcMapId>
  <tieredFlag>THRS</tieredFlag>
</pricecompdtls>
</pricingDetails>
</pricingcmtmntdtls>
</C1-DealPriceAsgnCommitmentBS>

```

Note: We have given the above request and response samples to illustrate how the tags should be nested while sending a deal price assignment override request from the external system. However, you should not seamlessly use this request sample in your environment because the required pre-requisite data may not be available in your environment. In such case, the system will give erroneous results.

Related Topics

For more information on...	See...
Deal price assignment update request and response tags in the XML format	Deal Price Assignment Update Request and Response - Tags in the XML Format on page 3862

Sample Deal Price Assignment Recommend Request and Response in the XML Format

Using the below example, you can recommend the price assignment.

Sample Price Assignment Recommend Request in the XML Format

```
<C1-DealPriceAsgnCommitmentBS>
  <modelId>8459821555</modelId>
  <inquiryModeFlag>PRIC</inquiryModeFlag>
  <pricingcmntmtdtls>
    <entityId>9902789911</entityId>
    <entityType>PERS</entityType>
    <pricingdtls>
      <priceAsgnId>5410009242</priceAsgnId>
      <actionFlag>RECM</actionFlag>
      <priceItemCode>PI_025</priceItemCode>
      <priceStatusFlag>RECM</priceStatusFlag>
      <priceCurrencyCode>USD</priceCurrencyCode>
      <rateSchedule>DM-NBRTH</rateSchedule>
      <startDate>2022-02-13</startDate>
      <endDate>2023-02-12</endDate>
      <isEligible>true</isEligible>
      <paTypeFlag>RGLR</paTypeFlag>
      <printIfZero>Y</printIfZero>
      <priceasgnchar>
        <characteristicType>DEALID</characteristicType>
        <effectiveDate>2022-04-05</effectiveDate>
        <characteristicValue>2520094042</characteristicValue>
      </priceasgnchar>
      <priceasgnchar>
        <characteristicType>C2CLTYPE</characteristicType>
        <effectiveDate>2022-04-05</effectiveDate>
        <characteristicValue>2520094042</characteristicValue>
      </priceasgnchar>
      <priceasgnparm>
        <priceParmCode>COUNTRY</priceParmCode>
        <priceParmVal>BHARAT</priceParmVal>
      </priceasgnparm>
      <txnDailyRatingCrt>DNRT</txnDailyRatingCrt>
      <ignoreSw>N</ignoreSw>
      <doNotAggSw>N</doNotAggSw>
      <scheduleCode>MONTHLY</scheduleCode>
      <pricecompdtls>
        <priceCompTier>
          <toVal>1000.00</toVal>
          <fromVal>0.00</fromVal>
          <priceCriteria>NBRTRAN</priceCriteria>
          <tieSeqNum>10</tieSeqNum>
          <priceparm>
            <parmCodeType>STATE</parmCodeType>
            <priceParmCode>MAHARASHTRA</priceParmCode>
          </priceparm>
        </priceCompTier>
        <priceCompElg>
          <rhsPriceParmCd>ACCESSGRP</rhsPriceParmCd>
          <rhsPriceParmVal>System Default</rhsPriceParmVal>
          <lhsPriceParmCd>AGEBASED</lhsPriceParmCd>
          <rhsPriceParmTypeFlg>PRM</rhsPriceParmTypeFlg>
        </priceCompElg>
      </pricecompdtls>
    </pricingdtls>
  </pricingcmntmtdtls>
</C1-DealPriceAsgnCommitmentBS>
```

```

        <isInsufficientFlag>RLFS</isInsufficientFlag>
        <isFalseFlag>RLFS</isFalseFlag>
        <isTrueFlag>RLTR</isTrueFlag>
        <operator>=</operator>
        <sequenceNumber>0</sequenceNumber>
    </priceCompElg>
    <priceCompSequenceNo>100</priceCompSequenceNo>
    <priceCompDesc>Threshold price per transaction</priceCompDesc>
    <valueAmt>12.95</valueAmt>
    <priceComponentDisplay>true</priceComponentDisplay>
    <rcMapId>1109655113</rcMapId>
    <tieredFlag>THRS</tieredFlag>
</pricecompdtls>
</pricingdtls>
</pricingcmtmtdtls>
</Cl-DealPriceAsgnCommitmentBS>

```

Note: If you do not want to enter the data in the list tags (i.e. tags where the type is set to list), you should not include them in the request. Adding empty list tags will give erroneous results.

Sample Price Assignment Recommend Response in the XML Format

```

<Cl-DealPriceAsgnCommitmentBS>
  <dealIdentifier>DEAL_EPER_PRIC_N_COMT_001_V1</dealIdentifier>
  <dealId>5888357415</dealId>
  <modelId>8459821555</modelId>
  <pricingcmtmtdtls>
    <entityId>9902789911</entityId>
    <entityType>PERS</entityType>
    <entityIdentifierValue>Reg_BK_PRSP_PSEL_API_001</entityIdentifierValue>
    <entityIdentifierType>COREG</entityIdentifierType>
    <entityDivision>IND</entityDivision>
  </pricingdtls>
    <priceAsgnId>9380016094</priceAsgnId>
    <actionFlag>RECM</actionFlag>
    <priceItemCode>PI_025</priceItemCode>
    <priceItemDescription>V5-Domestic Funds Transfer Fee</
  </priceItemDescription>
    <hierarchyDetails>CORPORATE BANKING, PAYMENT SERVICES</
  </hierarchyDetails>
    <priceStatusFlag>RECM</priceStatusFlag>
    <priceCurrencyCode>USD</priceCurrencyCode>
    <rateSchedule>DM-NBRTH</rateSchedule>
    <startDate>2022-02-13</startDate>
    <endDate>2023-02-12</endDate>
    <isEligible>true</isEligible>
    <assignmentLevel>Customer Price List</assignmentLevel>
    <paTypeFlag>RGLR</paTypeFlag>
    <printIfZero>Y</printIfZero>
    <priceasgnchar>
      <characteristicType>DEALID</characteristicType>
      <effectiveDate>2022-04-05</effectiveDate>
      <characteristicValue>2520094042</characteristicValue>
    </priceasgnchar>
    <priceasgnchar>
      <characteristicType>C2CLTYPE</characteristicType>
      <effectiveDate>2022-04-05</effectiveDate>
      <characteristicValue>2520094042</characteristicValue>
    </priceasgnchar>
    <priceasgnparm>
      <priceParmCode>COUNTRY</priceParmCode>
      <priceParmVal>BHARAT</priceParmVal>
    </priceasgnparm>

```

```

<txnDailyRatingCrt>DNRT</txnDailyRatingCrt>
<ignoreSw>N</ignoreSw>
<doNotAggSw>N</doNotAggSw>
<scheduleCode>MONTHLY</scheduleCode>
<pricecompdtls>
  <priceCompTier>
    <toVal>1000.00</toVal>
    <fromVal>0.00</fromVal>
    <priceCriteria>NBRTRAN</priceCriteria>
    <tieSeqNum>10</tieSeqNum>
    <priceparm>
      <parmCodeType>STATE</parmCodeType>
      <priceParmCode>MAHARASHTRA</priceParmCode>
    </priceparm>
  </priceCompTier>
</priceCompElg>
  <rhsPriceParmCd>ACCESSGRP</rhsPriceParmCd>
  <rhsPriceParmVal>System Default</rhsPriceParmVal>
  <lhsPriceParmCd>AGEBASED</lhsPriceParmCd>
  <rhsPriceParmTypeFlg>PRM</rhsPriceParmTypeFlg>
  <isInsufficientFlag>RLFS</isInsufficientFlag>
  <isFalseFlag>RLFS</isFalseFlag>
  <isTrueFlag>RLTR</isTrueFlag>
  <operator>=</operator>
  <sequenceNumber>0</sequenceNumber>
</priceCompElg>
<priceCompSequenceNo>100</priceCompSequenceNo>
<priceCompId>5417400010</priceCompId>
<priceCompDesc>Threshold price per transaction</priceCompDesc>
<valueAmt>12.950000000000000000</valueAmt>
<priceComponentDisplay>true</priceComponentDisplay>
<rcMapId>1109655113</rcMapId>
<tieredFlag>THRS</tieredFlag>
</pricecompdtls>
</pricingDetails>
</pricingcmtmtdtls>
</C1-DealPriceAsgnCommitmentBS>

```

Note: We have given the above request and response samples to illustrate how the tags should be nested while sending a deal price assignment recommend request from the external system. However, you should not seamlessly use this request sample in your environment because the required pre-requisite data may not be available in your environment. In such case, the system will give erroneous results.

Related Topics

For more information on...	See...
Deal price assignment recommend request and response tags in the XML format	Deal Price Assignment Recommend Request and Response - Tags in the XML Format on page 3870

Sample Deal Price Assignment Delete Request and Response in the XML Format

Using the below example, you can delete the price assignment.

Sample Price Assignment Delete Request in the XML Format

```

<C1-DealPriceAsgnCommitmentBS>
  <modelId>3980725631</modelId>
  <inquiryModeFlag>PRIC</inquiryModeFlag>
  <pricingcmtmtdtls>
    <entityId>8785458200</entityId>
    <entityType>PERS</entityType>
  </pricingdtls>

```

```

        <priceAsgnId>9760032341</priceAsgnId>
        <actionFlag>DEL</actionFlag>
    </pricingdtls>
</pricingcmtmtdtls>
</C1-DealPriceAsgnCommitmentBS>

```

Note: If you do not want to enter the data in the list tags (i.e. tags where the type is set to list), you should not include them in the request. Adding empty list tags will give erroneous results.

Sample Price Assignment Delete Response in the XML Format

```

<C1-DealPriceAsgnCommitmentBS>
  <dealId>2485190495</dealId>
  <modelId>3980725631</modelId>
  <pricingcmtmtdtls>
    <entityId>8785458200</entityId>
    <entityType>PERS</entityType>
    <pricingdtls>
      <priceAsgnId>9760032341</priceAsgnId>
      <actionFlag>DEL</actionFlag>
      <isEligible>>false</isEligible>
    </pricingDetails>
  </pricingcmtmtdtls>
</C1-DealPriceAsgnCommitmentBS>

```

Note: We have given the above request and response samples to illustrate how the tags should be nested while sending a deal price assignment delete request from the external system. However, you should not seamlessly use this request sample in your environment because the required pre-requisite data may not be available in your environment. In such case, the system will give erroneous results.

Related Topics

For more information on...	See...
Deal price assignment delete request and response tags in the XML format	Deal Price Assignment Delete Request and Response - Tags in the XML Format on page 3878

Sample Deal Price Assignment and Commitments View Request and Response in the XML Format

Using the below example, you can view the price assignment and commitments.

Sample Deal Price Assignment and Commitments View Request in the XML Format

```

<C1-DealPriceAsgnCommitmentBS>
  <modelId>9490517725</modelId>
  <inquiryModeFlag>BOTH</inquiryModeFlag>
  <actionFlag>READ</actionFlag>
</C1-DealPriceAsgnCommitmentBS>

```

Sample Deal Price Assignment and Commitments View Response in the XML Format

```

<C1-DealPriceAsgnCommitmentBS>
  <dealId>2510739370</dealId>
  <modelId>9490517725</modelId>
  <actionFlag>READ</actionFlag>
  <pricingcmtmtdtls>
    <entityId>2762026417</entityId>
    <entityType>PERS</entityType>
    <entityIdentifierValue>123-12-1234</entityIdentifierValue>
    <entityIdentifierType>Social security number</entityIdentifierType>
    <entityDivision>930-California</entityDivision>
  </pricingdtls>

```



```

<priceAsgnId>6810091985</priceAsgnId>
<priceItemCode>DEAL_PRERANA3</priceItemCode>
<priceItemDescription>DealPrerana3</priceItemDescription>
<hierarchyDetails>RECM AVR,RECM AVR</hierarchyDetails>
<priceStatusFlag>PRPD</priceStatusFlag>
<priceCurrencyCode>USD</priceCurrencyCode>
<rateSchedule>BK-THRES</rateSchedule>
<startDate>2022-02-13</startDate>
<endDate>2023-02-12</endDate>
<isEligible>true</isEligible>
<assignmentLevel>CUPI</assignmentLevel>
<paTypeFlag>RGLR</paTypeFlag>
<printIfZero>Y</printIfZero>
<priceasgnchar>
  <characteristicType>DEALID</characteristicType>
  <effectiveDate>2022-04-05</effectiveDate>
  <characteristicValue>2520094042</characteristicValue>
</priceasgnchar>
<priceasgnchar>
  <characteristicType>C2CLTYPE</characteristicType>
  <effectiveDate>2022-04-05</effectiveDate>
  <characteristicValue>2520094042</characteristicValue>
</priceasgnchar>
<priceasgnparm>
  <priceParmCode>COUNTRY</priceParmCode>
  <priceParmVal>IND</priceParmVal>
</priceasgnparm>
<txnDailyRatingCrt>DNRT</txnDailyRatingCrt>
<ignoreSw>N</ignoreSw>
<doNotAggSw>N</doNotAggSw>
<scheduleCode>MONTHLY</scheduleCode>
<pricecompdtls>
  <priceCompTier>
    <toVal>100</toVal>
    <fromVal>1</fromVal>
    <priceCriteria>BK-NBR</priceCriteria>
    <tieSeqNum>10</tieSeqNum>
    <priceparm>
      <parmCodeType>STATE</parmCodeType>
      <priceParmCode>MAHARASHTRA</priceParmCode>
    </priceparm>
  </priceCompTier>
  <priceCompElg>
    <rhsPriceParmCd>ACCESSGRP</rhsPriceParmCd>
    <rhsPriceParmVal>System Default</rhsPriceParmVal>
    <lhsPriceParmCd>AGEBASED</lhsPriceParmCd>
    <rhsPriceParmTypeFlg>PRM</rhsPriceParmTypeFlg>
    <isInsufficientFlag>RLFS</isInsufficientFlag>
    <isFalseFlag>RLFS</isFalseFlag>
    <isTrueFlag>RLTR</isTrueFlag>
    <operator>=</operator>
    <sequenceNumber>0</sequenceNumber>
  </priceCompElg>
  <priceCompSequenceNo>20</priceCompSequenceNo>
  <priceCompId>2341932341</priceCompId>
  <priceCompDesc>No of transaction</priceCompDesc>
  <valueAmt>45.000000000000000000</valueAmt>
  <priceComponentDisplay>true</priceComponentDisplay>
  <rcMapId>3999784532</rcMapId>
  <tieredFlag>THRS</tieredFlag>
</pricecompdtls>
</pricingDetails>
<commitmentDetails>
  <priceItemCode>DEAL_PRERANA3</priceItemCode>

```

```

    <priceItemDescription>DealPrerana3</priceItemDescription>
    <parameterDetails>
      <parameterCode>COUNTRY</parameterCode>
      <parameterValue>IND</parameterValue>
    </parameterDetails>
    <SQIDetails>
      <serviceQuantityIdentifier>BK-NBR</serviceQuantityIdentifier>
      <sqiValue>12.000000000000000000</sqiValue>
      <sqiTypeFlg>PRPD</sqiTypeFlg>
    </SQIDetails>
  </commitmentDetails>
</pricingcmtmtdtls>
</C1-DealPriceAsgnCommitmentBS>

```

Note: We have given the above request and response samples to illustrate how the tags should be nested while sending a deal price assignment and commitments view request from the external system. However, you should not seamlessly use this request sample in your environment because the required pre-requisite data may not be available in your environment. In such case, the system will give erroneous results.

Related Topics

For more information on...	See...
Deal price assignment and commitments view request and response tags in the XML format	Deal Price Assignment and Commitments View Request and Response - Tags in the XML Format on page 3880

Sample Deal Commitments Add Request and Response in the XML Format

Using the below example, you can add commitments for the deal.

Sample Deal Commitments Add Request in the XML Format

```

<C1-DealPriceAsgnCommitmentBS>
  <modelId>8447774739</modelId>
  <inquiryModeFlag>COMT</inquiryModeFlag>
  <pricingcmtmtdtls>
    <entityId>2797545007</entityId>
    <entityType>PERS</entityType>
    <commitmentDetails>
      <priceItemCode>DEAL_PRERANA3</priceItemCode>
      <priceItemDescription>DealPrerana3</priceItemDescription>
      <parameterDetails>
        <parameterCode>COUNTRY</parameterCode>
        <parameterValue>IND</parameterValue>
      </parameterDetails>
      <SQIDetails>
        <serviceQuantityIdentifier>BK-NBR</serviceQuantityIdentifier>
        <sqiValue>12.000000000000000000</sqiValue>
        <sqiTypeFlg>PRPD</sqiTypeFlg>
        <actionFlag>ADD</actionFlag>
      </SQIDetails>
    </commitmentDetails>
  </pricingcmtmtdtls>
</C1-DealPriceAsgnCommitmentBS>

```

Note: If you do not want to enter the data in the list tags (i.e. tags where the type is set to list), you should not include them in the request. Adding empty list tags will give erroneous results.

Sample Deal Commitments Add Response in the XML Format

```

<C1-DealPriceAsgnCommitmentBS>
  <dealID>5593158511</dealID>
  <modelId>8447774739</modelId>

```

```

<pricngcmtmndtcls>
  <entityId>2797545007</entityId>
  <entityType>PERS</entityType>
  <commitmentDetails>
    <priceItemCode>DEAL_PRERANA3</priceItemCode>
    <priceItemDescription>DealPrerana3</priceItemDescription>
    <parameterDetails>
      <parameterCode>COUNTRY</parameterCode>
      <parameterValue>IND</parameterValue>
    </parameterDetails>
    <SQIDetails>
      <serviceQuantityIdentifier>BK-NBR</serviceQuantityIdentifier>
      <sqiValue>12.000000000000000000</sqiValue>
      <sqiTypeFlg>PRPD</sqiTypeFlg>
      <actionFlag>ADD</actionFlag>
    </SQIDetails>
  </commitmentDetails>
</pricngcmtmndtcls>
</C1-DealPriceAsgnCommitmentBS>

```

Note: We have given the above request and response samples to illustrate how the tags should be nested while sending deal commitments add request from the external system. However, you should not seamlessly use this request sample in your environment because the required pre-requisite data may not be available in your environment. In such case, the system will give erroneous results.

Related Topics

For more information on...	See...
Deal commitments add request and response tags in the XML format	Deal Commitments Add Request and Response - Tags in the XML Format on page 3886

Sample Deal Commitments Update Request and Response in the XML Format

Using the below example, you can update the deal commitments.

Sample Deal Commitments Update Request in the XML Format

```

<C1-DealPriceAsgnCommitmentBS>
  <dealID>5593158511</dealID>
  <inquiryModeFlag>COMT</inquiryModeFlag>
  <pricngcmtmndtcls>
    <entityId>2797545007</entityId>
    <entityType>PERS</entityType>
    <commitmentDetails>
      <priceItemCode>DEAL_PRERANA3</priceItemCode>
      <priceItemDescription>DealPrerana3</priceItemDescription>
      <parameterDetails>
        <parameterCode>COUNTRY</parameterCode>
        <parameterValue>IND</parameterValue>
      </parameterDetails>
      <SQIDetails>
        <serviceQuantityIdentifier>BK-NBR</serviceQuantityIdentifier>
        <sqiValue>12.000000000000000000</sqiValue>
        <sqiTypeFlg>PRPD</sqiTypeFlg>
        <actionFlag>UPD</actionFlag>
      </SQIDetails>
    </commitmentDetails>
  </pricngcmtmndtcls>
</C1-DealPriceAsgnCommitmentBS>

```

Note: If you do not want to enter the data in the list tags (i.e. tags where the type is set to list), you should not include them in the request. Adding empty list tags will give erroneous results.

Sample Deal Commitments Update Response in the XML Format

```
<C1-DealPriceAsgnCommitmentBS>
  <dealID>5593158511</dealID>
  <modelId>8447774739</modelId>
  <pricingcmtmndtcls>
    <entityId>2797545007</entityId>
    <entityType>PERS</entityType>
    <commitmentDetails>
      <priceItemCode>DEAL_PRERANA3</priceItemCode>
      <priceItemDescription>DealPrerana3</priceItemDescription>
      <parameterDetails>
        <parameterCode>COUNTRY</parameterCode>
        <parameterValue>IND</parameterValue>
      </parameterDetails>
      <SQIDetails>
        <serviceQuantityIdentifier>BK-NBR</serviceQuantityIdentifier>
        <sqiValue>12.000000000000000000</sqiValue>
        <sqiTypeFlg>PRPD</sqiTypeFlg>
        <actionFlag>UPD</actionFlag>
      </SQIDetails>
    </commitmentDetails>
  </pricingcmtmndtcls>
</C1-DealPriceAsgnCommitmentBS>
```

Note: We have given the above request and response samples to illustrate how the tags should be nested while sending deal commitments update request from the external system. However, you should not seamlessly use this request sample in your environment because the required pre-requisite data may not be available in your environment. In such case, the system will give erroneous results.

Related Topics

For more information on...	See...
Deal commitments update request and response tags in the XML format	Deal Commitments Update Request and Response - Tags in the XML Format on page 3889

Deal Price Assignment Override Request in the JSON Format

The following code snippet illustrates how the attribute/value pairs should be structured while sending the deal price assignment override request in the JSON Format.

```
{
  "C1-DealPriceAsgnCommitmentBS"
  {
    "dealIdentifier" : "",
    "dealId" : "",
    "modelId" : "",
    "inquiryModeflag" : "",
    "pricingcmtmndtcls"
    {
      "entityId" : "",
      "entityType" : "",
      "pricingdtcls"
      {
        "priceAsgnId" : "",
        "actionFlag" : "",
        "priceItemCode" : "",
```

For more information on...	See...
Deal price assignment override request and response attribute/value pairs in the JSON format	Deal Price Assignment Override Request and Response - Attribute/Value Pairs in the JSON Format on page 3920
Sample deal price assignment override request and response in the JSON format	Sample Deal Price Assignment Override Request and Response in the JSON Format on page 3958

Deal Price Assignment Override Response in the JSON Format

The following code snippet illustrates how the attribute/value pairs are structured while receiving the deal price assignment override response in the JSON Format.

```
{
  "Cl-DealPriceAsgnCommitmentBS"
  {
    "dealIdentifier" : "",
    "dealId" : "",
    "modelId" : "",
    "inquiryModeflag" : "",
    "pricingcmtmtdtls"
    {
      "entityId" : "",
      "entityType" : "",
      "entityIdentifierValue" : "",
      "entityIdentifierType" : "",
      "entityDivision" : "",
      "pricingdtls"
      {
        "priceAsgnId" : "",
        "actionFlag" : "",
        "priceItemCode" : "",
        "priceItemDescription" : "",
        "hierarchyDetails" : "",
        "priceStatusFlag" : "",
        "priceCurrencyCode" : "",
        "rateSchedule" : "",
        "startDate" : "",
        "endDate" : "",
        "isEligible" : "",
        "assignmentLevel" : "",
        "paTypeFlag" : "",
        "printIfZero" : "",
        "priceasgnchar"
        {
          "characteristicType" : "",
          "effectiveDate" : "",
          "characteristicValue" : "",
        }
      }
      "priceasgnparm"
      {
        "priceParmCode" : "",
        "priceParmVal" : "",
      }
      "txnDailyRatingCrt" : "",
      "ignoreSw" : "",
      "doNotAggSw" : "",
      "scheduleCode" : "",
      "pricecompdtls"
      {
        "priceCompTier"
      }
    }
  }
}
```

```

        "toVal" : "",
        "fromVal" : "",
        "priceCriteria" : "",
        "tieSeqNum" : "",
        "priceparm" : "",
        {
            "parmCodeType" : "",
            "priceParmCode" : "",
        }
    "priceCompElg"
    {
        "rhsPriceParmCd" : "",
        "rhsPriceParmVal" : "",
        "lhsPriceParmCd" : "",
        "rhsPriceParmTypeFlg" : "",
        "isInsufficientFlag" : "",
        "isFalseFlag" : "",
        "isTrueFlag" : "",
        "operator" : "",
        "sequenceNumber" : "",
    }
    "priceCompSequenceNo" : "",
    "priceCompId" : "",
    "priceCompDesc" : "",
    "valueAmt" : "",
    "priceComponentDisplay" : "",
    "rcMapId" : "",
    "tieredFlag" : ""
    }
    }
    }
}

```

Related Topics

For more information on...	See...
Deal price assignment override request and response attribute/value pairs in the JSON format	Deal Price Assignment Override Request and Response - Attribute/Value Pairs in the JSON Format on page 3920
Sample deal price assignment override request and response in the JSON format	Sample Deal Price Assignment Override Request and Response in the JSON Format on page 3958

Deal Price Assignment Update Request in the JSON Format

The following code snippet illustrates how the attribute/value pairs should be structured while sending the deal price assignment update request in the JSON Format.

```

{
  "C1-DealPriceAsgnCommitmentBS"
  {
    "dealIdentifier" : "",
    "dealId" : "",
    "modelId" : "",
    "inquiryModelflag" : "",
    "pricingcmntmntdtls"
    {
      "entityId" : "",
      "entityType" : "",
      "pricingdtls"
      {

```

For more information on...	See...
Deal price assignment update request and response attribute/value pairs in the JSON format	Deal Price Assignment Update Request and Response - Attribute/Value Pairs in the JSON Format on page 3928
Sample deal price assignment update request and response in the JSON format	Sample Deal Price Assignment Update Request and Response in the JSON Format on page 3961

Deal Price Assignment Update Response in the JSON Format

The following code snippet illustrates how the attribute/value pairs are structured while receiving the deal price assignment override response in the JSON Format.

```
{
  "Cl-DealPriceAsgnCommitmentBS"
  {
    "dealIdentifier" : "",
    "dealId" : "",
    "modelId" : "",
    "inquiryModeflag" : "",
    "pricingcmtmntdtls"
    {
      "entityId" : "",
      "entityType" : "",
      "entityIdentifierValue" : "",
      "entityIdentifierType" : "",
      "entityDivision" : "",
      "pricingdtls"
      {
        "priceAsgnId" : "",
        "actionFlag" : "",
        "priceItemCode" : "",
        "priceItemDescription" : "",
        "hierarchyDetails" : "",
        "priceStatusFlag" : "",
        "priceCurrencyCode" : "",
        "rateSchedule" : "",
        "startDate" : "",
        "endDate" : "",
        "isEligible" : "",
        "assignmentLevel" : "",
        "paTypeFlag" : "",
        "printIfZero" : "",
        "priceasgnchar"
        {
          "characteristicType" : "",
          "effectiveDate" : "",
          "characteristicValue" : ""
        }
      }
      "priceasgnparm"
      {
        "priceParmCode" : "",
        "priceParmVal" : ""
      }
      "txnDailyRatingCrt" : "",
      "ignoreSw" : "",
      "doNotAggSw" : "",
      "scheduleCode" : "",
      "pricecompdtls"
      {
        "priceCompTier"
        {
```

```

        "toVal" : "",
        "fromVal" : "",
        "priceCriteria" : "",
        "tieSeqNum" : "",
        "priceparm" : "",
        {
            "parmCodeType" : "",
            "priceParmCode" : "",
        }
    "priceCompElg"
    {
        "rhsPriceParmCd" : "",
        "rhsPriceParmVal" : "",
        "lhsPriceParmCd" : "",
        "rhsPriceParmTypeFlg" : "",
        "isInsufficientFlag" : "",
        "isFalseFlag" : "",
        "isTrueFlag" : "",
        "operator" : "",
        "sequenceNumber" : "",
    }
    "priceCompSequenceNo" : "",
    "priceCompId" : "",
    "priceCompDesc" : "",
    "valueAmt" : "",
    "priceComponentDisplay" : "",
    "rcMapId" : "",
    "tieredFlag" : ""
    }
    }
    }
}

```

Related Topics

For more information on...	See...
Deal price assignment update request and response attribute/value pairs in the JSON format	Deal Price Assignment Update Request and Response - Attribute/Value Pairs in the JSON Format on page 3928
Sample deal price assignment update request and response in the JSON format	Sample Deal Price Assignment Update Request and Response in the JSON Format on page 3961

Deal Price Assignment Recommend Request in the JSON Format

The following code snippet illustrates how the tags should be nested while sending the deal price assignment override request in the JSON Format.

```

{
  "C1-DealPriceAsgnCommitmentBS"
  {
    "dealIdentifier" : "",
    "dealId" : "",
    "modelId" : "",
    "inquiryModelflag" : "",
    "pricingcmntmtdtls"
    {
      "entityId" : "",
      "entityType" : "",
      "pricingdtls"
      {

```

For more information on...	See...
Deal price assignment recommend request and response tags in the JSON format	Deal Price Assignment Recommend Request and Response - Attribute/Value Pairs in the JSON Format on page 3936
Sample deal price assignment recommend request and response in the JSON format	Sample Deal Price Assignment Recommend Request and Response in the JSON Format on page 3964

Deal Price Assignment Recommend Response in the JSON Format

The following code snippet illustrates how the tags are nested while receiving the deal price assignment override response in the JSON Format.

```
{
  "C1-DealPriceAsgnCommitmentBS"
  {
    "dealIdentifier" : "",
    "dealId" : "",
    "modelId" : "",
    "inquiryModeflag" : "",
    "pricingcmtmtdtls"
    {
      "entityId" : "",
      "entityType" : "",
      "entityIdentifierValue" : "",
      "entityIdentifierType" : "",
      "entityDivision" : "",
      "pricingdtls"
      {
        "priceAsgnId" : "",
        "actionFlag" : "",
        "priceItemCode" : "",
        "priceItemDescription" : "",
        "hierarchyDetails" : "",
        "priceStatusFlag" : "",
        "priceCurrencyCode" : "",
        "rateSchedule" : "",
        "startDate" : "",
        "endDate" : "",
        "isEligible" : "",
        "assignmentLevel" : "",
        "paTypeFlag" : "",
        "printIfZero" : "",
        "priceasgnchar"
        {
          "characteristicType" : "",
          "effectiveDate" : "",
          "characteristicValue" : "",
        }
      }
      "priceasgnparm"
      {
        "priceParmCode" : "",
        "priceParmVal" : "",
      }
      "txnDailyRatingCrt" : "",
      "ignoreSw" : "",
      "doNotAggSw" : "",
      "scheduleCode" : "",
      "pricecompdtls"
      {
        "priceCompTier"
      }
    }
  }
}
```

```

        "toVal" : "",
        "fromVal" : "",
        "priceCriteria" : "",
        "tieSeqNum" : "",
        "priceparm" : "",
        {
            "parmCodeType" : "",
            "priceParmCode" : "",
        }
    "priceCompElg"
    {
        "rhsPriceParmCd" : "",
        "rhsPriceParmVal" : "",
        "lhsPriceParmCd" : "",
        "rhsPriceParmTypeFlg" : "",
        "isInsufficientFlag" : "",
        "isFalseFlag" : "",
        "isTrueFlag" : "",
        "operator" : "",
        "sequenceNumber" : "",
    }
    "priceCompSequenceNo" : "",
    "priceCompId" : "",
    "priceCompDesc" : "",
    "valueAmt" : "",
    "priceComponentDisplay" : "",
    "rcMapId" : "",
    "tieredFlag" : ""
    }
    }
}

```

Related Topics

For more information on...	See...
Deal price assignment recommend request and response tags in the JSON format	Deal Price Assignment Recommend Request and Response - Attribute/Value Pairs in the JSON Format on page 3936
Sample deal price assignment recommend request and response in the JSON format	Sample Deal Price Assignment Recommend Request and Response in the JSON Format on page 3964

Deal Price Assignment Delete Request in the JSON Format

The following code snippet illustrates how the tags should be nested while sending the deal price assignment delete request in the JSON Format.

```

{
    "C1-DealPriceAsgnCommitmentBS"
    {
        "dealIdentifier" : "",
        "dealId" : "",
        "modelId" : "",
        "inquiryModeflag" : "",
        "pricingcmtmntdtls"
        {
            "entityId" : "",
            "entityType" : "",
            "pricingdtls"
            {

```

```

        "priceAsgnId" : "",
        "actionFlag" : "",
    }
}
}
}

```

Related Topics

For more information on...	See...
Deal price assignment delete request and response tags in the JSON format	Deal Price Assignment Delete Request and Response - Attribute/Value Pairs in the JSON Format on page 3945
Sample deal price assignment delete request and response in the JSON format	Sample Deal Price Assignment Delete Request and Response in the JSON Format on page 3967

Deal Price Assignment Delete Response in the JSON Format

The following code snippet illustrates how the tags are nested while receiving the deal price assignment delete response in the JSON Format.

```

{
  "C1-DealPriceAsgnCommitmentBS"
  {
    "dealIdentifier" : "",
    "dealId" : "",
    "modelId" : "",
    "inquiryModeflag" : "",
    "pricingcmntmtdtls"
    {
      "entityId" : "",
      "entityType" : "",
      "pricingdtls"
      {
        "priceAsgnId" : "",
        "actionFlag" : "",
        "isEligible" : "",
      }
    }
  }
}

```

Related Topics

For more information on...	See...
Deal price assignment delete request and response tags in the JSON format	Deal Price Assignment Delete Request and Response - Attribute/Value Pairs in the JSON Format on page 3945
Sample deal price assignment delete request and response in the JSON format	Sample Deal Price Assignment Delete Request and Response in the JSON Format on page 3967

Deal Price Assignment and Commitments View Request in the JSON Format

The following code snippet illustrates how the tags should be nested while sending the deal price assignment and commitments view request in the JSON Format.

```

{
  "C1-DealPriceAsgnCommitmentBS"
  {

```

```

    "dealIdentifier" : "",
    "dealId" : "",
    "modelId" : "",
    "actionflag" : "",
    "inquiryModeflag" : "",
  }
}

```

Related Topics

For more information on...	See...
Deal price assignment and commitments view request and response attribute/value pairs in the JSON format	Deal Price Assignment and Commitments View Request and Response - Attribute/Value Pairs in the JSON Format on page 3947
Sample deal price assignment and commitments view request and response in the JSON Format	Sample Deal Price Assignment and Commitments View Request and Response in the JSON Format on page 3968

Deal Price Assignment and Commitments View Response in the JSON Format

The following code snippet illustrates how the tags are nested while receiving the deal price assignment and commitments view response in the JSON Format.

```

{
  "C1-DealPriceAsgnCommitmentBS"
  {
    "dealIdentifier" : "",
    "dealId" : "",
    "modelId" : "",
    "inquiryModeflag" : "",
    "actionflag" : "",
    "pricingcmtmtdtls"
    {
      "entityId" : "",
      "entityType" : "",
      "entityIdentifierValue" : "",
      "entityIdentifierType" : "",
      "entityDivision" : "",
      "pricingdtls"
      {
        "priceAsgnId" : "",
        "priceItemCode" : "",
        "priceItemDescription" : "",
        "hierarchyDetails" : "",
        "priceStatusFlag" : "",
        "priceCurrencyCode" : "",
        "rateSchedule" : "",
        "startDate" : "",
        "endDate" : "",
        "isEligible" : "",
        "assignmentLevel" : "",
        "paTypeFlag" : "",
        "printIfZero" : "",
        "priceasgnchar"
        {
          "characteristicType" : "",
          "effectiveDate" : "",
          "characteristicValue" : "",
        }
      }
      "priceasgnparm"
      {

```

```

        "priceParmCode" : "",
        "priceParmVal" : "",
    }
    "txnDailyRatingCrt" : "",
    "ignoreSw" : "",
    "doNotAggSw" : "",
    "scheduleCode" : "",
    "pricecompdtls"
    {
        "priceCompTier"
        {
            "toVal" : "",
            "fromVal" : "",
            "priceCriteria" : "",
            "tieSeqNum" : "",
            "priceparm" : "",
            {
                "parmCodeType" : "",
                "priceParmCode" : ""
            }
        }
        "priceCompElg"
        {
            "rhsPriceParmCd" : "",
            "rhsPriceParmVal" : "",
            "lhsPriceParmCd" : "",
            "rhsPriceParmTypeFlg" : "",
            "isInsufficientFlag" : "",
            "isFalseFlag" : "",
            "isTrueFlag" : "",
            "operator" : "",
            "sequenceNumber" : "",
        }
        "priceCompSequenceNo" : "",
        "priceCompId" : "",
        "description" : "",
        "valueAmt" : "",
        "priceComponentDisplay" : "",
        "rcMapId" : "",
        "tieredFlag" : "",
        {
    "commitmentDetails"
    {
        "priceItemCode" : "",
        "priceItemDescription" : "",
        "parameterDetails"
        {
            "parameterCode" : "",
            "parameterValue" : "",
        }
        "SQIDetails"
        {
            "serviceQuantityIdentifier" : "",
            "sqiValue" : "",
            "sqiTypeFlg" : "",
        }
    }
    }
    }
}

```

Related Topics

For more information on...	See...
Deal price assignment and commitments view request and response attribute/value pairs in the JSON format	Deal Price Assignment and Commitments View Request and Response - Attribute/Value Pairs in the JSON Format on page 3947
Sample deal price assignment and commitments view request and response in the JSON Format	Sample Deal Price Assignment and Commitments View Request and Response in the JSON Format on page 3968

Deal Commitments Add Request in the JSON Format

The following code snippet illustrates how the attribute/value pairs should be structured while sending the deal commitments add request in the JSON Format.

```
{
  "Cl-DealPriceAsgnCommitmentBS"
  {
    "dealIdentifier" : "",
    "dealId" : "",
    "modelId" : "",
    "inquiryModeflag" : "",
    "pricingcmtmntdtls"
    {
      "entityId" : "",
      "entityType" : "",
      "commitmentDetails"
      {
        "priceItemCode" : "",
        "priceItemDescription" : "",
        "parameterDetails"
        {
          "parameterCode" : "",
          "parameterValue" : "",
        }
      }
      "SQIDetails"
      {
        "serviceQuantityIdentifier" : "",
        "sqiValue" : "",
        "sqiTypeFlg" : "",
        "actionFlag" : "",
      }
    }
  }
}
```

Related Topics

For more information on...	See...
Deal commitments add request and response attribute/value pairs in the JSON format	Deal Commitments Add Request and Response - Attribute/Value Pairs in the JSON Format on page 3953
Sample deal commitments add request and response in the JSON format	Sample Deal Commitments Add Request and Response in the JSON Format on page 3970

Deal Commitments Add Response in the JSON Format

The following code snippet illustrates how the attribute/value pairs are structured while receiving the deal commitments add response in the JSON Format.

```

{
  "Cl-DealPriceAsgnCommitmentBS"
  {
    "dealIdentifier" : "",
    "dealId" : "",
    "modelId" : "",
    "pricingcmtmtdtls"
    {
      "entityId" : "",
      "entityType" : "",
      "commitmentDetails"
      {
        "priceItemCode" : "",
        "priceItemDescription" : "",
        "parameterDetails"
        {
          "parameterCode" : "",
          "parameterValue" : "",
        }
      }
      "SQIDetails"
      {
        "serviceQuantityIdentifier" : "",
        "sqiValue" : "",
        "sqiTypeFlg" : "",
        "actionFlag" : "",
      }
    }
  }
}

```

Related Topics

For more information on...	See...
Deal commitments add request and response attribute/value pairs in the JSON format	Deal Commitments Add Request and Response - Attribute/Value Pairs in the JSON Format on page 3953
Sample deal commitments add request and response in the JSON format	Sample Deal Commitments Add Request and Response in the JSON Format on page 3970

Deal Commitments Update Request in the JSON Format

The following code snippet illustrates how the attribute/value pairs should be structured while sending the deal commitments update request in the JSON Format.

```

{
  "Cl-DealPriceAsgnCommitmentBS"
  {
    "dealIdentifier" : "",
    "dealId" : "",
    "modelId" : "",
    "inquiryModeflag" : "",
    "pricingcmtmtdtls"
    {
      "entityId" : "",
      "entityType" : "",
      "commitmentDetails"
      {
        "priceItemCode" : "",
        "priceItemDescription" : "",
        "parameterDetails"

```

```

    {
      "parameterCode" : "",
      "parameterValue" : "",
    }
    "SQIDetails"
    {
      "serviceQuantityIdentifier" : "",
      "sqiValue" : "",
      "sqiTypeFlg"
      "actionFlag"
    }
  }
}

```

Related Topics

For more information on...	See...
Deal commitments update request and response attribute/value pairs in the JSON format	Deal Commitments Update Request and Response - Attribute/Value Pairs in the JSON Format on page 3955
Sample deal commitments update request and response in the JSON format	Sample Deal Commitments Update Request and Response in the JSON Format on page 3971

Deal Commitments Update Response in the JSON Format

The following code snippet illustrates how the attribute/value pairs are structured while receiving the deal commitments update response in the JSON Format.

```

{
  "Cl-DealPriceAsgnCommitmentBS"
  {
    "dealIdentifier" : "",
    "dealId" : "",
    "modelId" : "",
    "pricingcmtmtdtls"
    {
      "entityId" : "",
      "entityType" : "",
      "commitmentDetails"
      {
        "priceItemCode" : "",
        "priceItemDescription" : "",
        "parameterDetails"
        {
          "parameterCode" : "",
          "parameterValue" : "",
        }
        "SQIDetails"
        {
          "serviceQuantityIdentifier" : "",
          "sqiValue" : "",
          "sqiTypeFlg"
          "actionFlag"
        }
      }
    }
  }
}

```

Related Topics

For more information on...	See...
Deal commitments update request and response attribute/value pairs in the JSON format	Deal Commitments Update Request and Response - Attribute/Value Pairs in the JSON Format on page 3955
Sample deal commitments update request and response in the JSON format	Sample Deal Commitments Update Request and Response in the JSON Format on page 3971

Deal Price Assignment Override Request and Response - Attribute/Value Pairs in the JSON Format

Note: We recommend you to refer the topics [Deal Price Assignment Override Request in the JSON Format](#) on page 3904 and [Deal Price Assignment Override Response in the JSON Format](#) on page 3906 in parallel while understanding the below mentioned attributes. This will help you to understand how the attributes are nested in the JSON format.

Before calling the **C1-DealPriceAsgnCommitmentBS** business service through an inbound web service, you need to ensure that the deal price assignment override request contains the following attributes:

Attribute Name	Attribute Description	Mandatory (Yes or No)
dealIdentifier	Used to specify the deal which is created using a particular identifier whose price assignments you want to override. Note: If you specify the dealIdentifier attribute, you need not specify the dealId and the modelId attributes.	Yes (Conditional) Note: This data is required if you do not specify the dealId and modelId attributes.
dealId	Used to specify the deal whose price assignments you want to override. Note: If you specify the dealId attribute, you need not specify the dealIdentifier and the modelId attributes. If the deal has multiple versions, then, you should specify the modelId attribute instead of the dealId attribute.	Yes (Conditional) Note: This data is required if you do not specify the dealIdentifier and modelId attributes.
modelId	Used to specify the deal version whose price assignments you want to override. Note: If you specify the modelId attribute, you need not specify the dealIdentifier and the dealId attributes.	Yes (Conditional) Note: This data is required if you do not specify the dealIdentifier and dealId attributes.
inquiryModeFlag	Used to indicate whether you want to override the price assignments or the commitments of the price item. The valid value is: • PRIC	Yes

Attribute Name	Attribute Description	Mandatory (Yes or No)
pricingcmtmntdtls	Used to specify the price assignment and commitment details for the entities (i.e. existing or prospect person or account) of the deal.	Yes
entityId	Used to specify the entity (i.e. existing or prospect person or account) whose price assignments you want to override. Note: If you specify the entityType attribute, you need to specify the entityId attribute. The entityId should belong to the modelId .	Yes
entityType	Used to indicate the type of the entity (i.e. existing or prospect person or account) whose price assignments you want to override. The valid values are: <ul style="list-style-type: none"> • ACCT • PERS Note: If you specify the entityId attribute, you need to specify the entityType attribute.	Yes
pricingdtls	Used to specify the price assignment details for the entity (i.e. existing or prospect person or account).	Yes
priceAsgnId	Used to specify the identification value of the price assignment whose details you want to override. Note: The priceAsgnId should belong to the entityId .	Yes
actionFlag	Used to indicate that you want to create request to override the price assignment of the entity (i.e. existing or prospect person or account) of the deal. The valid value is: <ul style="list-style-type: none"> • OVRD 	Yes
priceItemCode	Used to specify the price item whose price assignment you want to override for the entity (i.e. existing or prospect person or account) of the deal.	Yes
priceStatusFlag	Used to indicate the current status of the price item price assignment. The valid value is: <ul style="list-style-type: none"> • PRPD Note: You can override a price assignment of a price item only when it is in the PRPD status.	Yes

Attribute Name	Attribute Description	Mandatory (Yes or No)
priceCurrencyCode	Used to indicate the currency in which the price assignment is defined for the price item.	Yes
rateSchedule	Used to indicate the rate schedule using which the price assignment is defined for the price item.	Yes
startDate	Used to specify the date from when the price assignment of the price item is effective for the entity (i.e. existing or prospect person or account).	Yes
endDate	Used to specify the date till when the price assignment of the price item is effective for the entity (i.e. existing or prospect person or account).	No
isEligible	Used to indicate whether you want to define the eligibility criteria for the price assignment. The valid values are: <ul style="list-style-type: none"> • FALSE • TRUE 	No
paTypeFlag	Used to indicate the type of price assignment. The valid values are: <ul style="list-style-type: none"> • POST • PPIN • PPPR • RGLR 	Yes
printIfZero	Used to indicate whether zero pricing should be displayed or not. The valid values are: <ul style="list-style-type: none"> • Y • N 	Yes
priceasgnchar	Used to specify a list of characteristics for the price assignment.	No
characteristicType	Used to indicate the characteristic type.	Yes (Conditional)
	Note: You must specify a characteristic type which is associated with the division to which the price item belongs.	Note: This data is required while defining a characteristic for the price assignment.
effectiveDate	Used to specify the date from when the characteristic is effective for price assignment.	Yes (Conditional)
		Note: This data is required while defining a characteristic for the price assignment.
characteristicValue	Used to specify the value for the characteristic type.	Yes (Conditional)

Attribute Name	Attribute Description	Mandatory (Yes or No)
		Note: This data is required while defining a characteristic for the price assignment.
priceasgnparm	Used to specify a list of price item parameters which are used along with the price item for determining the price assignment.	No
priceParmCode	Used to indicate the pricing parameter which is associated with the price item. Note: If you specify the priceParmVal attribute, you need to specify the priceParmCode attribute.	Yes (Conditional) Note: This data is required while specifying the price assignment parameters for the price item.
priceParmVal	Used to indicate the predefined pricing parameter value which is used for the price assignment. Note: If you specify the priceParmCode attribute, you need to specify the priceParmVal attribute.	Yes (Conditional) Note: This data is required while specifying the price assignment parameters for the price item.
txnDailyRatingCrt	Used to indicate how and when the transaction legs mapped to the price item are rated. The valid values are: <ul style="list-style-type: none"> • DNRT • AGTR • RITA • RITX 	Yes
ignoreSw	Used to indicate whether transaction mapped to price item pricing are considered for billing or not. The valid values are: <ul style="list-style-type: none"> • Y • N 	No
doNotAggSw	Used to indicate whether aggregation is required while rating the transactions mapped to the price item pricing before billing. The valid values are: <ul style="list-style-type: none"> • Y • N 	No
scheduleCode	Used to indicate the transaction aggregation cycle. The valid values are: <ul style="list-style-type: none"> • DAILY • WEEKLY • MONTHLY 	Yes

Attribute Name	Attribute Description	Mandatory (Yes or No)
	<ul style="list-style-type: none"> • QUARTERLY • YEARLY 	
priceCompDetails	Used to specify the price component details of the rate component defined for the price item price assignment.	No
priceCompTier	Used to specify the tiering criteria of the price component.	No
toVal	Used to specify the upper limit of the pricing range.	Yes (Conditional) Note: This data is required while specifying the tiering criteria of the price component.
fromVal	Used to specify the lower limit of the pricing range.	Yes (Conditional) Note: This data is required while specifying the tiering criteria of the price component.
priceCriteria	Used to indicate the tiering criterion which is used in the tiering range.	Yes (Conditional) Note: This data is required while specifying the tiering criteria of the price component.
tieSeqNum	Used to indicate the tiering sequence number.	Yes (Conditional) Note: This data is required while specifying the tiering criteria of the price component.
priceparm	Used to specify a list of parameters based on which the price items total usage is considered for determining the rate. Note: You should specify a value in this attribute only when the Multi Price Parameter Based Pricing (C1_PPARM_FLG) feature configuration is set to True .	No
priceParmCode	Used to indicate the parameter which is associated with the tiering criteria.	Yes (Conditional) Note: This data is required while specifying the parameters for the tiering criteria of the price component.
parameterVal	Used to specify the value for the parameter which is associated with the tiering criteria.	Yes (Conditional)

Attribute Name	Attribute Description	Mandatory (Yes or No)
		<p>Note: This data is required while specifying the parameters for the tiering criteria of the price component.</p>
priceCompElig	<p>Used to specify the pricing eligibility criteria for the price component.</p> <p>Note: You can specify the eligibility criteria for the price component only when the value in the isEligible attribute is set to TRUE.</p>	No
rhsPriceParmCd	<p>Used to specify the parameter against which you want to compare the parameter (on the left hand side).</p>	<p>Yes (Conditional)</p> <p>Note: This data is required while specifying the pricing eligibility criteria of the price component.</p>
rhsPriceParmVal	<p>Used to specify the parameter value against which you want to compare the parameter (on the left hand side).</p>	<p>Yes (Conditional)</p> <p>Note: This data is required while specifying the pricing eligibility criteria of the price component.</p>
lhsPriceParmCd	<p>Used to specify the left hand side parameter which you want to use along with the price item for price determination.</p>	<p>Yes (Conditional)</p> <p>Note: This data is required while specifying the pricing eligibility criteria of the price component.</p>
rhsPriceParmTypeFlg	<p>Used to indicate whether the parameter (on the left hand side) is compared against another parameter (on the right hand side) or directly against a parameter value. The valid values are:</p> <ul style="list-style-type: none"> • PARAMETER - Used to indicate that the parameter (on the left hand side) is compared against another parameter (on the right hand side). • VALUE - Used to indicate that the parameter (on the left hand side) is compared against a parameter value. 	<p>Yes (Conditional)</p> <p>Note: This data is required while specifying the pricing eligibility criteria of the price component.</p>
isInsufficientFlag	<p>Used to indicate what should happen when the data is insufficient. The valid values are:</p> <ul style="list-style-type: none"> • COND - Used to indicate that the condition with the consecutive sequence number is executed. • RLFS - Used to indicate that the action specified in the Rule False Action field is executed. 	<p>Yes (Conditional)</p> <p>Note: This data is required while specifying the pricing eligibility criteria of the price component.</p>

Attribute Name	Attribute Description	Mandatory (Yes or No)
	<ul style="list-style-type: none"> • RLTR - Used to indicate that the action specified in the Rule True Action field is executed. 	
isFalseFlag	<p>Used to indicate what should happen when the condition is false (not satisfied). The valid values are:</p> <ul style="list-style-type: none"> • COND - Used to indicate that the condition with the consecutive sequence number is executed. • RLFS - Used to indicate that the action specified in the Rule False Action field is executed. • RLTR - Used to indicate that the action specified in the Rule True Action field is executed. 	<p>Yes (Conditional)</p> <p>Note: This data is required while specifying the pricing eligibility criteria of the price component.</p>
isTrueFlag	<p>Used to indicate what should happen when the condition is true (satisfied). The valid values are:</p> <ul style="list-style-type: none"> • COND - Used to indicate that the condition with the consecutive sequence number is executed. • RLFS - Used to indicate that the action specified in the Rule False Action field is executed. • RLTR - Used to indicate that the action specified in the Rule True Action field is executed. 	<p>Yes (Conditional)</p> <p>Note: This data is required while specifying the pricing eligibility criteria of the price component.</p>
operator	<p>Used to indicate the relational operator used to define the relation between the parameter name and the parameter value. The valid values are:</p> <ul style="list-style-type: none"> • < • <= • <> • = • > • >= • BETWEEN • IN • LIKE • NOT IN 	<p>Yes (Conditional)</p> <p>Note: This data is required while specifying the pricing eligibility criteria of the price component.</p>
sequenceNumber	<p>Used to specify the order in which the pricing eligibility criteria is executed in the rule.</p>	<p>Yes (Conditional)</p>

Attribute Name	Attribute Description	Mandatory (Yes or No)
		Note: This data is required while specifying the pricing eligibility criteria of the price component.
priceCompSequenceNo	Used to specify the sequence number of the price component.	Yes
priceCompDesc	Used to specify the description for the price component.	No
valueAmt	Used to specify the rate for the price component.	Yes
priceComponentDisplay	Used to indicate whether the price component is displayed in the bill. The valid values are: <ul style="list-style-type: none"> TRUE FALSE 	Yes
rcMapId	Used to specify the identification value of the rate component for the price component.	Yes
tieredFlag	Used to specify the tiering type used for the price component. The valid values are: <ul style="list-style-type: none"> FLAT STEP THRESHOLD 	Yes

Once the deal price assignment is overridden, all the details of deal price assignment are listed in the above mentioned attributes along with the following attributes:

Attribute Name	Attribute Description
dealId	Displays the identification value of the deal whose price assignments you have overridden. Note: The value in this attribute appears when you specify the dealIdentifier or the modelId attribute while creating the override request.
modelId	Displays the deal version whose price assignments you have overridden. Note: The value in this attribute appears when you specify the dealIdentifier or the dealId attribute while creating the override request.
entityIdentifierValue	Indicates the identifier using which the entity (i.e. existing or prospect person or account) is created in the system.
entityIdentifierType	Indicates the identifier type using which the entity (i.e. existing or prospect person or account) is created in the system.
entityDivision	Indicates the division to which the entity (i.e. existing or prospect person or account) belongs.
priceItemDescription	Displays the description of the price item.
hierarchyDetails	Displays the hierarchy to which the price item belongs.

Attribute Name	Attribute Description
assignmentLevel	Indicates the level at which the pricing is defined for the price item. The valid values are: <ul style="list-style-type: none"> • ACPI • CUPI • PCPI
priceCompId	Displays the identification value of the price component.

Note:

Only **RM** (Relationship Manager) can create the deal price assignment override request.

You can override only the inherited price assignments and not the agreed price assignments.

On processing the request, the system creates an agreed pricing for the entity of the deal in the **Proposed** status.

Related Topics

For more information on...	See...
Sample deal price assignment override request and response in the JSON format	Sample Deal Price Assignment Override Request and Response in the JSON Format on page 3958

Deal Price Assignment Update Request and Response - Attribute/Value Pairs in the JSON Format

Note: We recommend you to refer the topics [Deal Price Assignment Update Request in the JSON Format](#) on page 3907 and [Deal Price Assignment Update Response in the JSON Format](#) on page 3909 in parallel while understanding the below mentioned attributes. This will help you to understand how the attributes are nested in the JSON format.

Before calling the **C1-DealPriceAsgnCommitmentBS** business service through an inbound web service, you need to ensure that the deal price assignment update request contains the following attributes:

Attribute Name	Attribute Description	Mandatory (Yes or No)
dealIdentifier	Used to specify the deal which is created using a particular identifier whose price assignments you want to update.	Yes (Conditional)
	Note: If you specify the dealIdentifier attribute, you need not specify the dealId and the modelId attributes.	Note: This data is required if you do not specify the dealId and modelId attributes.
dealId	Used to specify the deal whose price assignments you want to update.	Yes (Conditional)
		Note: This data is required if you do not specify the dealIdentifier and modelId attributes.

Attribute Name	Attribute Description	Mandatory (Yes or No)
	<p>Note:</p> <p>If you specify the dealId attribute, you need not specify the dealIdentifier and the modelId attributes.</p> <p>If the deal has multiple versions, then, you should specify the modelId attribute instead of the dealId attribute.</p>	
modelId	<p>Used to specify the deal version whose price assignments you want to update.</p> <p>Note: If you specify the modelId attribute, you need not specify the dealIdentifier and the dealId attributes.</p>	<p>Yes (Conditional)</p> <p>Note: This data is required if you do not specify the dealIdentifier and dealId attributes.</p>
inquiryModeFlag	<p>Used to indicate whether you want to update the price assignments or the commitments of the price item. The valid value is:</p> <ul style="list-style-type: none"> • PRIC 	Yes
pricingcmtdtcls	Used to specify the price assignment and commitment details for the entities (i.e. existing or prospect person or account) of the deal.	Yes
entityId	<p>Used to specify the entity (i.e. existing or prospect person or account) whose price assignments you want to update.</p> <p>Note:</p> <p>If you specify the entityType attribute, you need to specify the entityId attribute.</p> <p>The entityId should belong to the modelId.</p>	Yes
entityType	<p>Used to indicate the type of the entity (i.e. existing or prospect person or account) whose price assignments you want to update. The valid values are:</p> <ul style="list-style-type: none"> • ACCT • PERS <p>Note: If you specify the entityId attribute, you need to specify the entityType attribute.</p>	Yes
pricingdtcls	Used to specify the price assignment details for the entity (i.e. existing or prospect person or account).	Yes
priceAsgnId	Used to specify the identification value of the price assignment whose details you want to update.	Yes

Attribute Name	Attribute Description	Mandatory (Yes or No)
	Note: The priceAsgnId should belong to the entityId .	
actionFlag	Used to indicate that you want to create request to update the price assignment of the entity (i.e. existing or prospect person or account) of the deal. The valid value is: <ul style="list-style-type: none"> • UPD 	Yes
priceItemCode	Used to specify the price item whose price assignment you want to update for the entity (i.e. existing or prospect person or account) of the deal.	Yes
priceStatusFlag	Used to indicate the current status of the price item price assignment. The valid value is: <ul style="list-style-type: none"> • PRPD Note: You can update a price assignment of a price item only when it is in the PRPD status.	Yes
priceCurrencyCode	Used to indicate the currency in which the price assignment is defined for the price item.	Yes
rateSchedule	Used to indicate the rate schedule using which the price assignment is defined for the price item.	Yes
startDate	Used to specify the date from when the price assignment of the price item is effective for the entity (i.e. existing or prospect person or account).	Yes
endDate	Used to specify the date till when the price assignment of the price item is effective for the entity (i.e. existing or prospect person or account).	No
isEligible	Used to indicate whether you want to define the eligibility criteria for the price assignment. The valid values are: <ul style="list-style-type: none"> • FALSE • TRUE 	No
paTypeFlag	Used to indicate the type of price assignment. The valid values are: <ul style="list-style-type: none"> • POST • PPIN • PPPR • RGLR 	Yes
printIfZero	Used to indicate whether zero pricing should be displayed or not. The valid values are:	Yes

Attribute Name	Attribute Description	Mandatory (Yes or No)
	<ul style="list-style-type: none"> • Y • N 	
priceasgnchar	Used to specify a list of characteristics for the price assignment.	No
characteristicType	Used to indicate the characteristic type.	Yes (Conditional)
	Note: You must specify a characteristic type which is associated with the division to which the price item belongs.	Note: This data is required while defining a characteristic for the price assignment.
effectiveDate	Used to specify the date from when the characteristic is effective for price assignment.	Yes (Conditional)
		Note: This data is required while defining a characteristic for the price assignment.
characteristicValue	Used to specify the value for the characteristic type.	Yes (Conditional)
		Note: This data is required while defining a characteristic for the price assignment.
priceasgnparm	Used to specify a list of price item parameters which are used along with the price item for determining the price assignment.	No
priceParmCode	Used to indicate the pricing parameter which is associated with the price item.	Yes (Conditional)
	Note: If you specify the priceParmVal attribute, you need to specify the priceParmCode attribute.	Note: This data is required while specifying the price assignment parameters for the price item.
priceParmVal	Used to indicate the predefined pricing parameter value which is used for the price assignment.	Yes (Conditional)
	Note: If you specify the priceParmCode attribute, you need to specify the priceParmVal attribute.	Note: This data is required while specifying the price assignment parameters for the price item.
txnDailyRatingCrt	<p>Used to indicate how and when the transaction legs mapped to the price item are rated. The valid values are:</p> <ul style="list-style-type: none"> • DNRT • AGTR • RITA • RITX 	Yes

Attribute Name	Attribute Description	Mandatory (Yes or No)
ignoreSw	Used to indicate whether transaction mapped to price item pricing are considered for billing or not. The valid values are: <ul style="list-style-type: none"> • Y • N 	No
doNotAggSw	Used to indicate whether aggregation is required while rating the transactions mapped to the price item pricing before billing. The valid values are: <ul style="list-style-type: none"> • Y • N 	No
scheduleCode	Used to indicate the transaction aggregation cycle. The valid values are: <ul style="list-style-type: none"> • DAILY • WEEKLY • MONTHLY • QUARTERLY • YEARLY 	Yes
priceCompDetails	Used to specify the price component details of the rate component defined for the price item price assignment.	No
priceCompTier	Used to specify the tiering criteria of the price component.	No
toVal	Used to specify the upper limit of the pricing range.	Yes (Conditional) Note: This data is required while specifying the tiering criteria of the price component.
fromVal	Used to specify the lower limit of the pricing range.	Yes (Conditional) Note: This data is required while specifying the tiering criteria of the price component.
priceCriteria	Used to indicate the tiering criterion which is used in the tiering range.	Yes (Conditional) Note: This data is required while specifying the tiering criteria of the price component.
tieSeqNum	Used to indicate the tiering sequence number.	Yes (Conditional)

Attribute Name	Attribute Description	Mandatory (Yes or No)
		<p>Note: This data is required while specifying the tiering criteria of the price component.</p>
priceparm	<p>Used to specify a list of parameters based on which the price items total usage is considered for determining the rate.</p> <p>Note: You should specify a value in this attribute only when the Multi Price Parameter Based Pricing (C1_PPARM_FLG) feature configuration is set to True.</p>	No
priceParmCode	Used to indicate the parameter which is associated with the tiering criteria.	<p>Yes (Conditional)</p> <p>Note: This data is required while specifying the parameters for the tiering criteria of the price component.</p>
parameterVal	Used to specify the value for the parameter which is associated with the tiering criteria.	<p>Yes (Conditional)</p> <p>Note: This data is required while specifying the parameters for the tiering criteria of the price component.</p>
priceCompElig	<p>Used to specify the pricing eligibility criteria for the price component.</p> <p>Note: You can specify the eligibility criteria for the price component only when the value in the isEligible attribute is set to TRUE.</p>	No
rhsPriceParmCd	Used to specify the parameter against which you want to compare the parameter (on the left hand side).	<p>Yes (Conditional)</p> <p>Note: This data is required while specifying the pricing eligibility criteria of the price component.</p>
rhsPriceParmVal	Used to specify the parameter value against which you want to compare the parameter (on the left hand side).	<p>Yes (Conditional)</p> <p>Note: This data is required while specifying the pricing eligibility criteria of the price component.</p>
lhsPriceParmCd	Used to specify the left hand side parameter which you want to use along with the price item for price determination.	<p>Yes (Conditional)</p> <p>Note: This data is required while specifying the pricing eligibility criteria of the price component.</p>

Attribute Name	Attribute Description	Mandatory (Yes or No)
rhsPriceParmTypeFlg	<p>Used to indicate whether the parameter (on the left hand side) is compared against another parameter (on the right hand side) or directly against a parameter value. The valid values are:</p> <ul style="list-style-type: none"> • PARAMETER - Used to indicate that the parameter (on the left hand side) is compared against another parameter (on the right hand side). • VALUE - Used to indicate that the parameter (on the left hand side) is compared against a parameter value. 	<p>Yes (Conditional)</p> <p>Note: This data is required while specifying the pricing eligibility criteria of the price component.</p>
isInsufficientFlag	<p>Used to indicate what should happen when the data is insufficient. The valid values are:</p> <ul style="list-style-type: none"> • COND - Used to indicate that the condition with the consecutive sequence number is executed. • RLFS - Used to indicate that the action specified in the Rule False Action field is executed. • RLTR - Used to indicate that the action specified in the Rule True Action field is executed. 	<p>Yes (Conditional)</p> <p>Note: This data is required while specifying the pricing eligibility criteria of the price component.</p>
isFalseFlag	<p>Used to indicate what should happen when the condition is false (not satisfied). The valid values are:</p> <ul style="list-style-type: none"> • COND - Used to indicate that the condition with the consecutive sequence number is executed. • RLFS - Used to indicate that the action specified in the Rule False Action field is executed. • RLTR - Used to indicate that the action specified in the Rule True Action field is executed. 	<p>Yes (Conditional)</p> <p>Note: This data is required while specifying the pricing eligibility criteria of the price component.</p>
isTrueFlag	<p>Used to indicate what should happen when the condition is true (satisfied). The valid values are:</p> <ul style="list-style-type: none"> • COND - Used to indicate that the condition with the consecutive sequence number is executed. • RLFS - Used to indicate that the action specified in the Rule False Action field is executed. • RLTR - Used to indicate that the action specified in the Rule True Action field is executed. 	<p>Yes (Conditional)</p> <p>Note: This data is required while specifying the pricing eligibility criteria of the price component.</p>

Attribute Name	Attribute Description	Mandatory (Yes or No)
operator	Used to indicate the relational operator used to define the relation between the parameter name and the parameter value. The valid values are: <ul style="list-style-type: none"> • < • <= • <> • = • > • >= • BETWEEN • IN • LIKE • NOT IN 	Yes (Conditional) Note: This data is required while specifying the pricing eligibility criteria of the price component.
sequenceNumber	Used to specify the order in which the pricing eligibility criteria is executed in the rule.	Yes (Conditional) Note: This data is required while specifying the pricing eligibility criteria of the price component.
priceCompSequenceNo	Used to specify the sequence number of the price component.	Yes
priceCompDesc	Used to specify the description for the price component.	No
valueAmt	Used to specify the rate for the price component.	Yes
priceComponentDisplay	Used to indicate whether the price component is displayed in the bill. The valid values are: <ul style="list-style-type: none"> • TRUE • FALSE 	Yes
rcMapId	Used to specify the identification value of the rate component for the price component.	Yes
tieredFlag	Used to specify the tiering type used for the price component. The valid values are: <ul style="list-style-type: none"> • FLAT • STEP • THRESHOLD 	Yes

Once the deal price assignment is updated, all the details of deal price assignment are listed in the above mentioned attributes along with the following attributes:

Attribute Name	Attribute Description
dealId	Displays the identification value of the deal whose price assignments you have updated.
	Note: The value in this attribute appears when you specify the dealIdentifier or the modelId attribute while creating the update request.
modelId	Displays the identification value of the deal version whose price assignments you have updated.
	Note: The value in this attribute appears when you specify the dealIdentifier or the dealId attribute while creating the update request.
entityIdentifierValue	Indicates the identifier using which the entity (i.e. existing or prospect person or account) is created in the system.
entityIdentifierType	Indicates the identifier type using which the entity (i.e. existing or prospect person or account) is created in the system.
entityDivision	Indicates the division to which the entity (i.e. existing or prospect person or account) belongs.
priceItemDescription	Displays the description of the price item.
hierarchyDetails	Displays the hierarchy to which the price item belongs.
assignmentLevel	Indicates the level at which the pricing is defined for the price item. The valid values are: <ul style="list-style-type: none"> • ACPI • CUPI • PCPI
priceCompId	Displays the identification value of the price component.

Note:

Only **RM** (Relationship Manager) can create the deal price assignment update request.

You can update only the agreed price assignments and not the inherited price assignments.

On processing the request, the system creates an agreed pricing for the entity of the deal in the **Proposed** status.

When you create a request to update a price assignment, the system replaces the price assignment data instead of editing it. Therefore, you should provide all details of the price assignment including the data that you want to change.

Related Topics

For more information on...	See...
Sample deal price assignment update request and response in the JSON format	Sample Deal Price Assignment Update Request and Response in the JSON Format on page 3961

Deal Price Assignment Recommend Request and Response - Attribute/Value Pairs in the JSON Format

Note: We recommend you to refer the topics [Deal Price Assignment Recommend Request in the JSON Format](#) on page 3910 and [Deal Price Assignment Recommend Response in the JSON Format](#) on page 3912 in parallel while understanding the below mentioned attributes. This will help you to understand how the attributes are nested in the JSON format.

Before calling the **C1-DealPriceAsgnCommitmentBS** business service through an inbound web service, you need to ensure that the deal price assignment recommend request contains the following attributes:

Attribute Name	Attribute Description	Mandatory (Yes or No)
dealIdentifier	Used to specify the deal which is created using a particular identifier whose price assignments you want to recommend.	Yes (Conditional)
	Note: If you specify the dealIdentifier attribute, you need not specify the dealId and the modelId attributes.	Note: This data is required if you do not specify the dealId and modelId attributes.
dealId	Used to specify the deal whose price assignments you want to recommend.	Yes (Conditional)
	Note: If you specify the dealId attribute, you need not specify the dealIdentifier and the modelId attributes. If the deal has multiple versions, then, you should specify the modelId attribute instead of the dealId attribute.	Note: This data is required if you do not specify the dealIdentifier and modelId attributes.
modelId	Used to specify the deal version whose price assignments you want to recommend.	Yes (Conditional)
	Note: If you specify the modelId attribute, you need not specify the dealIdentifier and the dealId attributes.	Note: This data is required if you do not specify the dealIdentifier and dealId attributes.
inquiryModeFlag	Used to indicate whether you want to recommend the price assignments or the commitments of the price item. The valid value is: <ul style="list-style-type: none"> • PRIC 	Yes
pricingcmtmntdttls	Used to specify the price assignment and commitment details for the entities (i.e. existing or prospect person or account) of the deal.	Yes
entityId	Used to specify the entity (i.e. existing or prospect person or account) whose price assignments you want to recommend.	Yes

Attribute Name	Attribute Description	Mandatory (Yes or No)
	<p>Note:</p> <p>If you specify the entityType attribute, you need to specify the entityId attribute.</p> <p>The entityId should belong to the modelId.</p>	
entityType	<p>Used to indicate the type of the entity (i.e. existing or prospect person or account) whose price assignments you want to recommend. The valid values are:</p> <ul style="list-style-type: none"> • ACCT • PERS <p>Note: If you specify the entityId attribute, you need to specify the entityType attribute.</p>	Yes
pricingdtls	Used to specify the price assignment details for the entity (i.e. existing or prospect person or account).	Yes
priceAsgnId	<p>Used to specify the identification value of the price assignment whose details you want to recommend.</p> <p>Note: The priceAsgnId should belong to the entityId.</p>	Yes
actionFlag	<p>Used to indicate that you want to create request to recommend the price assignment of the entity (i.e. existing or prospect person or account) of the deal. The valid value is:</p> <ul style="list-style-type: none"> • RECM 	Yes
priceItemCode	Used to specify the price item whose price assignment you want to recommend for the entity (i.e. existing or prospect person or account) of the deal.	Yes
priceStatusFlag	<p>Used to indicate the current status of the price item price assignment. The valid value is:</p> <ul style="list-style-type: none"> • RECM <p>Note: You can recommend a price assignment of a price item only when it is in the RECM status.</p>	Yes
priceCurrencyCode	Used to indicate the currency in which the price assignment is defined for the price item.	Yes
rateSchedule	Used to indicate the rate schedule using which the price assignment is defined for the price item.	Yes

Attribute Name	Attribute Description	Mandatory (Yes or No)
startDate	Used to specify the date from when the price assignment of the price item is effective for the entity (i.e. existing or prospect person or account).	Yes
endDate	Used to specify the date till when the price assignment of the price item is effective for the entity (i.e. existing or prospect person or account).	No
isEligible	Used to indicate whether you want to define the eligibility criteria for the price assignment. The valid values are: <ul style="list-style-type: none"> • FALSE • TRUE 	No
paTypeFlag	Used to indicate the type of price assignment. The valid values are: <ul style="list-style-type: none"> • POST • PPIN • PPPR • RGLR 	Yes
printfZero	Used to indicate whether zero pricing should be displayed or not. The valid values are: <ul style="list-style-type: none"> • Y • N 	Yes
priceasgnchar	Used to specify a list of characteristics for the price assignment.	No
characteristicType	Used to indicate the characteristic type.	Yes (Conditional)
	Note: You must specify a characteristic type which is associated with the division to which the price item belongs.	Note: This data is required while defining a characteristic for the price assignment.
effectiveDate	Used to specify the date from when the characteristic is effective for price assignment.	Yes (Conditional)
		Note: This data is required while defining a characteristic for the price assignment.
characteristicValue	Used to specify the value for the characteristic type.	Yes (Conditional)
		Note: This data is required while defining a characteristic for the price assignment.
priceasgnparm	Used to specify a list of price item parameters which are used along with the price item for determining the price assignment.	No

Attribute Name	Attribute Description	Mandatory (Yes or No)
priceParmCode	Used to indicate the pricing parameter which is associated with the price item.	Yes (Conditional)
	Note: If you specify the priceParmVal attribute, you need to specify the priceParmCode attribute.	Note: This data is required while specifying the price assignment parameters for the price item.
priceParmVal	Used to indicate the predefined pricing parameter value which is used for the price assignment.	Yes (Conditional)
	Note: If you specify the priceParmCode attribute, you need to specify the priceParmVal attribute.	Note: This data is required while specifying the price assignment parameters for the price item.
txnDailyRatingCrt	Used to indicate how and when the transaction legs mapped to the price item are rated. The valid values are: <ul style="list-style-type: none"> • DNRT • AGTR • RITA • RITX 	Yes
ignoreSw	Used to indicate whether transaction mapped to price item pricing are considered for billing or not. The valid values are: <ul style="list-style-type: none"> • Y • N 	No
doNotAggSw	Used to indicate whether aggregation is required while rating the transactions mapped to the price item pricing before billing. The valid values are: <ul style="list-style-type: none"> • Y • N 	No
scheduleCode	Used to indicate the transaction aggregation cycle. The valid values are: <ul style="list-style-type: none"> • DAILY • WEEKLY • MONTHLY • QUARTERLY • YEARLY 	Yes
priceCompDetails	Used to specify the price component details of the rate component defined for the price item price assignment.	No

Attribute Name	Attribute Description	Mandatory (Yes or No)
priceCompTier	Used to specify the tiering criteria of the price component.	No
toVal	Used to specify the upper limit of the pricing range.	Yes (Conditional) Note: This data is required while specifying the tiering criteria of the price component.
fromVal	Used to specify the lower limit of the pricing range.	Yes (Conditional) Note: This data is required while specifying the tiering criteria of the price component.
priceCriteria	Used to indicate the tiering criterion which is used in the tiering range.	Yes (Conditional) Note: This data is required while specifying the tiering criteria of the price component.
tieSeqNum	Used to indicate the tiering sequence number.	Yes (Conditional) Note: This data is required while specifying the tiering criteria of the price component.
priceparm	Used to specify a list of parameters based on which the price items total usage is considered for determining the rate. Note: You should specify a value in this attribute only when the Multi Price Parameter Based Pricing (C1_PPARM_FLG) feature configuration is set to True .	No
priceParmCode	Used to indicate the parameter which is associated with the tiering criteria.	Yes (Conditional) Note: This data is required while specifying the parameters for the tiering criteria of the price component.
parameterVal	Used to specify the value for the parameter which is associated with the tiering criteria.	Yes (Conditional) Note: This data is required while specifying the parameters for the tiering criteria of the price component.
priceCompElig	Used to specify the pricing eligibility criteria for the price component.	No

Attribute Name	Attribute Description	Mandatory (Yes or No)
	Note: You can specify the eligibility criteria for the price component only when the value in the isEligible attribute is set to TRUE .	
rhsPriceParmCd	Used to specify the parameter against which you want to compare the parameter (on the left hand side).	Yes (Conditional) Note: This data is required while specifying the pricing eligibility criteria of the price component.
rhsPriceParmVal	Used to specify the parameter value against which you want to compare the parameter (on the left hand side).	Yes (Conditional) Note: This data is required while specifying the pricing eligibility criteria of the price component.
lhsPriceParmCd	Used to specify the left hand side parameter which you want to use along with the price item for price determination.	Yes (Conditional) Note: This data is required while specifying the pricing eligibility criteria of the price component.
rhsPriceParmTypeFlg	Used to indicate whether the parameter (on the left hand side) is compared against another parameter (on the right hand side) or directly against a parameter value. The valid values are: <ul style="list-style-type: none"> • PARAMETER - Used to indicate that the parameter (on the left hand side) is compared against another parameter (on the right hand side). • VALUE - Used to indicate that the parameter (on the left hand side) is compared against a parameter value. 	Yes (Conditional) Note: This data is required while specifying the pricing eligibility criteria of the price component.
isInsufficientFlag	Used to indicate what should happen when the data is insufficient. The valid values are: <ul style="list-style-type: none"> • COND - Used to indicate that the condition with the consecutive sequence number is executed. • RLFS - Used to indicate that the action specified in the Rule False Action field is executed. • RLTR - Used to indicate that the action specified in the Rule True Action field is executed. 	Yes (Conditional) Note: This data is required while specifying the pricing eligibility criteria of the price component.
isFalseFlag	Used to indicate what should happen when the condition is false (not satisfied). The valid values are:	Yes (Conditional) Note: This data is required while specifying the pricing eligibility criteria of the price component.

Attribute Name	Attribute Description	Mandatory (Yes or No)
	<ul style="list-style-type: none"> • COND - Used to indicate that the condition with the consecutive sequence number is executed. • RLFS - Used to indicate that the action specified in the Rule False Action field is executed. • RLTR - Used to indicate that the action specified in the Rule True Action field is executed. 	
isTrueFlag	<p>Used to indicate what should happen when the condition is true (satisfied). The valid values are:</p> <ul style="list-style-type: none"> • COND - Used to indicate that the condition with the consecutive sequence number is executed. • RLFS - Used to indicate that the action specified in the Rule False Action field is executed. • RLTR - Used to indicate that the action specified in the Rule True Action field is executed. 	<p>Yes (Conditional)</p> <p>Note: This data is required while specifying the pricing eligibility criteria of the price component.</p>
operator	<p>Used to indicate the relational operator used to define the relation between the parameter name and the parameter value. The valid values are:</p> <ul style="list-style-type: none"> • < • <= • <> • = • > • >= • BETWEEN • IN • LIKE • NOT IN 	<p>Yes (Conditional)</p> <p>Note: This data is required while specifying the pricing eligibility criteria of the price component.</p>
sequenceNumber	<p>Used to specify the order in which the pricing eligibility criteria is executed in the rule.</p>	<p>Yes (Conditional)</p> <p>Note: This data is required while specifying the pricing eligibility criteria of the price component.</p>
priceCompSequenceNo	<p>Used to specify the sequence number of the price component.</p>	<p>Yes</p>
priceCompDesc	<p>Used to specify the description for the price component.</p>	<p>No</p>

Attribute Name	Attribute Description	Mandatory (Yes or No)
valueAmt	Used to specify the rate for the price component.	Yes
priceComponentDisplay	Used to indicate whether the price component is displayed in the bill. The valid values are: <ul style="list-style-type: none"> TRUE FALSE 	Yes
rcMapId	Used to specify the identification value of the rate component for the price component.	Yes
tieredFlag	Used to specify the tiering type used for the price component. The valid values are: <ul style="list-style-type: none"> FLAT STEP THRESHOLD 	Yes

Once the deal price assignment is recommended, all the details of deal price assignment are listed in the above mentioned attributes along with the following attributes:

Attribute Name	Attribute Description
dealId	Displays the identification value of the deal for which you have recommended the price assignments.
	Note: The value in this attribute appears when you specify the dealIdentifier or the modelId attribute while creating the recommend request.
modelId	Displays the identification value of the deal version for which you have recommended the price assignments.
	Note: The value in this attribute appears when you specify the dealIdentifier or the dealId attribute while creating the recommend request.
entityIdentifierValue	Indicates the identifier using which the entity (i.e. existing or prospect person or account) is created in the system.
entityIdentifierType	Indicates the identifier type using which the entity (i.e. existing or prospect person or account) is created in the system.
entityDivision	Indicates the division to which the entity (i.e. existing or prospect person or account) belongs.
priceItemDescription	Displays the description of the price item.
hierarchyDetails	Displays the hierarchy to which the price item belongs.
assignmentLevel	Indicates the level at which the pricing is defined for the price item. The valid values are: <ul style="list-style-type: none"> ACPI CUPI PCPI

Attribute Name	Attribute Description
priceCompId	Displays the identification value of the price component.

Note:

Only **RM** (Relationship Manager) can create the deal price assignment recommend request.

You can recommend only the agreed price assignments and not the inherited price assignments.

On processing the request, the system creates an agreed pricing for the entity of the deal in the **Recommended** status.

When you create a request to recommend a price assignment, the system replaces the price assignment data instead of editing it. Therefore, you should provide all details of the price assignment including the data that you want to change.

Related Topics

For more information on...	See...
Sample deal price assignment recommend request and response in the JSON format	Sample Deal Price Assignment Recommend Request and Response in the JSON Format on page 3964

Deal Price Assignment Delete Request and Response - Attribute/Value Pairs in the JSON Format

Note: We recommend you to refer the topics [Deal Price Assignment Delete Request in the JSON Format](#) on page 3913 and [Deal Price Assignment Delete Response in the JSON Format](#) on page 3914 in parallel while understanding the below mentioned attributes. This will help you to understand how the attributes are nested in the JSON format.

Before calling the **C1-DealPriceAsgnCommitmentBS** business service through an inbound web service, you need to ensure that the deal price assignment delete request contains the following attributes:

Attribute Name	Attribute Description	Mandatory (Yes or No)
dealIdentifier	Used to specify the deal which is created using a particular identifier whose price assignment you want to delete.	Yes (Conditional)
	Note: If you specify the dealIdentifier attribute, you need not specify the dealId and the modelId attributes.	Note: This data is required if you do not specify the dealId and modelId attributes.
dealId	Used to specify the deal whose price assignment you want to delete.	Yes (Conditional)
	Note: If you specify the dealId attribute, you need not specify the dealIdentifier and the modelId attributes. If the deal has multiple versions, then, you should specify the modelId attribute instead of the dealId attribute.	Note: This data is required if you do not specify the dealIdentifier and modelId attributes.
modelId	Used to specify the deal version whose price assignment you want to delete.	Yes (Conditional)

Attribute Name	Attribute Description	Mandatory (Yes or No)
	<p>Note: If you specify the modelId attribute, you need not specify the dealIdentifier and the dealId attributes.</p>	<p>Note: This data is required if you do not specify the dealIdentifier and dealId attributes.</p>
inquiryModeFlag	<p>Used to indicate whether you want to delete the price assignment or the commitments of the price item. The valid value is:</p> <ul style="list-style-type: none"> • PRIC 	Yes
pricingcmtmtdtls	Used to specify the price assignment and commitment details for the entities (i.e. existing or prospect person or account) of the deal.	Yes
entityId	<p>Used to specify the entity (i.e. existing or prospect person or account) whose price assignment you want to delete.</p> <p>Note: If you specify the entityType attribute, you need to specify the entityId attribute. The entityId should belong to the modelId.</p>	Yes
entityType	<p>Used to indicate the type of the entity (i.e. existing or prospect person or account) whose price assignment you want to delete. The valid values are:</p> <ul style="list-style-type: none"> • ACCT • PERS <p>Note: If you specify the entityId attribute, you need to specify the entityType attribute.</p>	Yes
pricingdtls	Used to specify the price assignment details for the entity (i.e. existing or prospect person or account).	Yes
priceAsgnId	<p>Used to specify the identification value of the price assignment whose details you want to delete.</p> <p>Note: The priceAsgnId should belong to the entityId.</p>	Yes
actionFlag	<p>Used to indicate that you want to create request to delete the price assignment of the entity (i.e. existing or prospect person or account) of the deal. The valid value is:</p> <ul style="list-style-type: none"> • DEL 	Yes

Once the deal price assignment is deleted, all the details of deal price assignment are listed in the above mentioned attributes along with the following attribute:

Attribute Name	Attribute Description
isEligible	Indicates the eligibility criteria of the deleted price assignment. The valid values are: <ul style="list-style-type: none"> FALSE TRUE

Note:

Only **RM** (Relationship Manager) can delete the price assignment which is in the **Proposed** status. Whereas, only the **PM** (Product Manager) can delete the price assignment which is in the **Recommended** status.

You cannot delete a price list price assignment.

You cannot delete the same price assignment twice.

Related Topics

For more information on...	See...
Sample deal price assignment delete request and response in the JSON format	Sample Deal Price Assignment Delete Request and Response in the JSON Format on page 3967

Deal Price Assignment and Commitments View Request and Response - Attribute/Value Pairs in the JSON Format

Note: We recommend you to refer the topics [Deal Price Assignment and Commitments View Request in the JSON Format](#) on page 3914 and [Deal Price Assignment and Commitments View Response in the JSON Format](#) on page 3915 in parallel while understanding the below mentioned attributes. This will help you to understand how the attributes are nested in the XML format.

Before calling the **C1-DealPriceAsgnCommitmentBS** business service through an inbound web service, you need to ensure that the deal price assignment and commitments view request contains the following attributes:

Attribute Name	Attribute Description	Mandatory (Yes or No)
dealIdentifier	Used to specify the deal which is created using a particular identifier whose price assignments and commitments you want to view.	Yes (Conditional)
	<p>Note:</p> <p>If you specify the dealIdentifier attribute, you need not specify the dealId and the modelId attributes.</p> <p>If the deal has multiple versions, then, you should specify the modelId attribute instead of the dealIdentifier attribute.</p>	<p>Note: This data is required if you do not specify the dealId and modelId attributes.</p>
dealId	Used to specify the deal whose price assignments and commitments you want to view.	Yes (Conditional)
		<p>Note: This data is required if you do not specify the dealIdentifier and modelId attributes.</p>

Attribute Name	Attribute Description	Mandatory (Yes or No)
	<p>Note:</p> <p>If you specify the dealId attribute, you need not specify the dealIdentifier and the modelId attributes.</p> <p>If the deal has multiple versions, then, you should specify the modelId attribute instead of the dealId attribute.</p>	
modelId	<p>Used to specify the deal version whose price assignments and commitments you want to view.</p> <p>Note: If you specify the modelId attribute, you need not specify the dealIdentifier and the dealId attributes.</p>	<p>Yes (Conditional)</p> <p>Note: This data is required if you do not specify the dealIdentifier and dealId attributes.</p>
actionflag	<p>Used to indicate that you want to create request to view the price assignment and commitments of the entities in the customer hierarchy of the deal. The valid value is:</p> <ul style="list-style-type: none"> • READ 	Yes
inquiryModeFlag	<p>Used to indicate that you want to view the price assignments and commitments of the entities in the customer hierarchy of the deal. The valid value is:</p> <ul style="list-style-type: none"> • BOTH 	Yes

Once the deal price assignment and commitments view request is created, all the details of the deal price assignment and commitments are listed in the above mentioned attributes along with the following attributes:

Attribute Name	Attribute Description
pricingcmtmntdtls	Displays the price assignment and commitment details of the entity in the customer hierarchy of the deal.
entityId	Displays the entity whose price assignment and commitment details you are viewing.
entityType	<p>Indicates the type of the entity whose price assignment and commitment details you are viewing. The valid values are:</p> <ul style="list-style-type: none"> • ACCT • PERS
entityIdentifierValue	Indicates the value of the identifier type using which the entity is created in the system.
entityIdentifierType	Indicates the identifier type using which the entity is created in the system.
entityDivision	Indicates the division to which the entity belongs.
pricingdtls	Displays the price assignment details of the entity in the customer hierarchy of the deal.

Attribute Name	Attribute Description
priceAsgnId	Displays the identification value of the price assignment for the entity whose price assignment details you are viewing.
priceItemCode	Displays the price item whose price assignment details you are viewing.
priceItemDescription	Displays the description of the price item.
hierarchyDetails	Displays the root level and/or non-root level hierarchy entity to which the price item belongs.
priceStatusFlag	Indicates the current status of the price assignment.
priceCurrencyCode	Indicates the currency in which the price assignment is defined for the price item.
rateSchedule	Indicates the rate schedule using which the price assignment is defined for the price item.
startDate	Displays the date from when the price assignment of the price item is effective for the entity.
endDate	Displays the date till when the price assignment of the price item is effective for the entity.
isEligible	Indicates whether the eligibility criteria for the price assignment is defined or not. The valid values are: <ul style="list-style-type: none"> • FALSE • TRUE
assignmentLevel	Indicates the level at which the pricing is defined for the price item. The valid values are: <ul style="list-style-type: none"> • ACPI • CUPI • PCPI
paTypeFlag	Indicates the type of price assignment. The valid values are: <ul style="list-style-type: none"> • POST • PPIN • PPPR • RGLR
printIfZero	Indicates whether zero pricing is displayed or not. The valid values are: <ul style="list-style-type: none"> • Y • N
priceasgnchar	Displays a list of characteristics defined for the price assignment.
characteristicType	Indicates the characteristic type.
effectiveDate	Displays the date from when the characteristic is effective for price assignment.
characteristicValue	Displays the value of the characteristic type.
priceasgnparm	Displays the list of price item parameters which are used along with the price item for determining the price assignment.

Attribute Name	Attribute Description
priceParmCode	Indicates the pricing parameter which is associated with the price item.
priceParmVal	Indicates the predefined pricing parameter value which is used for the price assignment.
txnDailyRatingCrt	Indicates how and when the transaction legs mapped to the price item are rated. The valid values are: <ul style="list-style-type: none"> • DNRT • AGTR • RITA • RITX
ignoreSw	Indicates whether transaction mapped to price item pricing are considered for billing or not. The valid values are: <ul style="list-style-type: none"> • Y • N
doNotAggSw	Indicates whether aggregation is required while rating the transactions mapped to the price item pricing before billing. The valid values are: <ul style="list-style-type: none"> • Y • N
scheduleCode	Indicates the transaction aggregation cycle. The valid values are: <ul style="list-style-type: none"> • DAILY • WEEKLY • MONTHLY • QUARTERLY • YEARLY
priceCompDetails	Displays the price component details of the rate component defined for the price item price assignment.
priceCompTier	Displays the tiering criteria of the price component.
toVal	Displays the upper limit of the pricing range.
fromVal	Displays the lower limit of the pricing range.
priceCriteria	Indicates the tiering criterion which is used in the tiering range.
tieSeqNum	Indicates the tiering sequence number.
priceparm	Displays the list of parameters based on which the price items total usage is considered for determining the rate. <p>Note: The value in this attribute appears only when the Multi Price Parameter option type of the Multi Parameter Based Pricing (C1_PPARM_FLG) feature configuration is set to True.</p>
priceParmCode	Indicates the parameter which is associated with the tiering criteria.
parameterVal	Displays the value for the parameter which is associated with the tiering criteria.

Attribute Name	Attribute Description
priceCompElig	Displays the pricing eligibility criteria defined for the price component.
	Note: The value in this attribute appears only when the isEligible attribute is set to TRUE and the eligibility criteria is defined for the price component.
rhsPriceParmCd	Displays the parameter against which you want to compare the parameter (on the left hand side).
rhsPriceParmVal	Displays the parameter value against which you want to compare the parameter (on the left hand side).
lhsPriceParmCd	Displays the left hand side parameter which you want to use along with the price item for price determination.
rhsPriceParmTypeFlg	<p>Indicates whether the parameter (on the left hand side) is compared against another parameter (on the right hand side) or directly against a parameter value. The valid values are:</p> <ul style="list-style-type: none"> • PARAMETER - Indicates that the parameter (on the left hand side) is compared against another parameter (on the right hand side). • VALUE - Indicates that the parameter (on the left hand side) is compared against a parameter value.
isInsufficientFlag	<p>Indicates what should happen when the data is insufficient. The valid values are:</p> <ul style="list-style-type: none"> • COND - Indicates that the condition with the consecutive sequence number is executed. • RLFS - Indicates that the action specified in the Rule False Action field is executed. • RLTR - Indicates that the action specified in the Rule True Action field is executed.
isFalseFlag	<p>Indicates what should happen when the condition is false (not satisfied). The valid values are:</p> <ul style="list-style-type: none"> • COND - Indicates that the condition with the consecutive sequence number is executed. • RLFS - Indicates that the action specified in the Rule False Action field is executed. • RLTR - Indicates that the action specified in the Rule True Action field is executed.
isTrueFlag	<p>Indicates what should happen when the condition is true (satisfied). The valid values are:</p> <ul style="list-style-type: none"> • COND - Indicates that the condition with the consecutive sequence number is executed. • RLFS - Indicates that the action specified in the Rule False Action field is executed. • RLTR - Indicates that the action specified in the Rule True Action field is executed.
operator	Indicates the relational operator used to define the relation between the parameter name and the parameter value. The valid values are:

Attribute Name	Attribute Description
	<ul style="list-style-type: none"> • < • <= • <> • = • > • >= • BETWEEN • IN • LIKE • NOT IN
sequenceNumber	Displays the order in which the pricing eligibility criteria is executed in the rule.
priceCompSequenceNo	Displays the sequence number of the price component.
priceCompId	Displays the identification value of the price component.
priceCompDesc	Displays the description for the price component.
valueAmt	Displays the rate of the price component.
priceComponentDisplay	Indicates whether the price component is displayed in the bill or not. The valid values are: <ul style="list-style-type: none"> • TRUE • FALSE
rcMapId	Displays the identification value of the rate component for the price component.
tieredFlag	Displays the tiering type used for the price component. The valid values are: <ul style="list-style-type: none"> • FLAT • STEP • THRESHOLD
commitmentDetails	Displays the price item commitment details for the entity (i.e. existing or prospect person or account).
priceItemCode	Displays the price item whose commitment details you are viewing.
priceItemDescription	Displays the description of the price item.
parameterDetails	Displays the list of parameters based on which the effective pricing is defined for the price item.
parameterCode	Displays the parameter based on which the effective pricing is defined for the price item..
parameterValue	Displays the value of the parameter.
SQIDetails	Displays the service quantity identifier details of the price item.
serviceQuantityIdentifier	Displays the service quantity identifier associated with the price item.

Attribute Name	Attribute Description
sqiValue	Displays the SQI value for the price item and parameter combination that you want to use for calculating the price item pricing.
sqiTypeFlg	Indicates the status of the service quantity identifier details for calculating the price item pricing.

Related Topics

For more information on...	See...
Sample deal price assignment and commitments view request and response in the JSON format	Sample Deal Price Assignment and Commitments View Request and Response in the JSON Format on page 3968

Deal Commitments Add Request and Response - Attribute/Value Pairs in the JSON Format

Note: We recommend you to refer the topics [Deal Commitments Add Request in the JSON Format](#) on page 3917 and [Deal Commitments Add Response in the JSON Format](#) on page 3917 in parallel while understanding the below mentioned attributes. This will help you to understand how the attributes are nested in the JSON format.

Before calling the **C1-DealPriceAsgnCommitmentBS** business service through an inbound web service, you need to ensure that the deal commitments add request contains the following attributes:

Attribute Name	Attribute Description	Mandatory (Yes or No)
dealIdentifier	Used to specify the deal which is created using a particular identifier whose commitments you want to add.	Yes (Conditional)
	Note: If you specify the dealIdentifier attribute, you need not specify the dealId and the modelId attributes.	Note: This data is required if you do not specify the dealId and modelId attributes.
dealId	Used to specify the deal for which you want to add commitments.	Yes (Conditional)
	Note: If you specify the dealId attribute, you need not specify the dealIdentifier and the modelId attributes. If the deal has multiple versions, then, you should specify the modelId attribute instead of the dealId attribute.	Note: This data is required if you do not specify the dealIdentifier and modelId attributes.
modelId	Used to specify the deal version for which you want to add commitments.	Yes (Conditional)
	Note: If you specify the modelId attribute, you need not specify the dealIdentifier and the dealId attributes.	Note: This data is required if you do not specify the dealIdentifier and dealId attributes.
inquiryModeFlag	Used to indicate whether you want to add price assignments or commitments of the price item for the deal. The valid value is:	Yes

Attribute Name	Attribute Description	Mandatory (Yes or No)
	<ul style="list-style-type: none"> • COMT 	
pricingcmtmntdttl	Used to specify the price assignment and commitment details for the entities (i.e. existing or prospect person or account) of the deal.	Yes
entityId	<p>Used to specify the entity (i.e. existing or prospect person or account) whose price items commitments you want to add.</p> <p>Note: If you specify the entityType attribute, you need to specify the entityId attribute. The entityId should belong to the modelId.</p>	Yes
entityType	<p>Used to indicate the type of the entity (i.e. existing or prospect person or account) whose price items commitments you want to add. The valid values are:</p> <ul style="list-style-type: none"> • ACCT • PERS <p>Note: If you specify the entityId attribute, you need to specify the entityType attribute.</p>	Yes
commitmentDetails	Used to specify the price item commitment details for the entity (i.e. existing or prospect person or account).	Yes
priceItemCode	Used to specify the price item whose commitments you want to add for the entity (i.e. existing or prospect person or account) of the deal.	Yes
priceItemDescription	Used to specify the description of the price item.	No
parameterDetails	Used to specify the parameters based on which the effective pricing is defined for the price item.	Yes
parameterCode	Used to specify the parameter.	Yes
parameterValue	Used to specify the value of the parameter.	Yes
SQIDetails	Used to specify the service quantity identifier details of the price item.	Yes
serviceQuantityIdentifier	Used to specify the service quantity identifier associated with the price item.	Yes
sqiValue	Used to specify the SQI value for the price item and parameter combination that you want to use for calculating the price item pricing.	Yes

Attribute Name	Attribute Description	Mandatory (Yes or No)
sqiTypeFlg	Used to indicate the status of the service quantity identifier details for calculating the price item pricing. The valid value is: <ul style="list-style-type: none"> PRPD 	Yes
actionFlag	Used to specify that you want to create request to add commitments for the deal. The valid value is: <ul style="list-style-type: none"> ADD 	Yes

Once the deal commitments are added, all the details of deal commitments are listed in the above mentioned attributes along with the following attributes:

Attribute Name	Attribute Description
dealId	Displays the identification value of the deal for which you have added the commitments. Note: The value in this attribute appears when you specify the dealIdentifier or the modelId attribute while creating the add request.
modelId	Displays the identification value of the deal for which you have added the commitments. Note: The value in this attribute appears when you specify the dealIdentifier or the dealId attribute while creating the add request.

Note:

Only **RM** (Relationship Manager) can create the deal commitments add request.

You can add commitments for a price item only when the price item and the parameter combination is valid.

Related Topics

For more information on...	See...
Sample deal commitments add request and response in the JSON format	Sample Deal Commitments Add Request and Response in the JSON Format on page 3970

Deal Commitments Update Request and Response - Attribute/Value Pairs in the JSON Format

Note: We recommend you to refer the topics [Deal Commitments Update Request in the JSON Format](#) on page 3918 and [Deal Commitments Update Response in the JSON Format](#) on page 3919 in parallel while understanding the below mentioned attributes. This will help you to understand how the attributes are nested in the XML format.

Before calling the **C1-DealPriceAsgnCommitmentBS** business service through an inbound web service, you need to ensure that the deal commitments update request contains the following attributes:

Attribute Name	Attribute Description	Mandatory (Yes or No)
dealIdentifier	Used to specify the deal which is created using a particular identifier whose commitments you want to update.	Yes (Conditional)
	Note: If you specify the dealIdentifier attribute, you need not specify the dealId and the modelId attributes.	Note: This data is required if you do not specify the dealId and modelId attributes.
dealId	Used to specify the deal whose commitments you want to update.	Yes (Conditional)
	Note: If you specify the dealId attribute, you need not specify the dealIdentifier and the modelId attributes. If the deal has multiple versions, then, you should specify the modelId attribute instead of the dealId attribute.	Note: This data is required if you do not specify the dealIdentifier and modelId attributes.
modelId	Used to specify the deal version whose commitments you want to update.	Yes (Conditional)
	Note: If you specify the modelId attribute, you need not specify the dealIdentifier and the dealId attributes.	Note: This data is required if you do not specify the dealIdentifier and dealId attributes.
inquiryModeFlag	Used to indicate whether you want to update the price assignments or the commitments of the price item for the deal. The valid value is: <ul style="list-style-type: none"> • COMT 	Yes
pricingcmtmntdtls	Used to specify the price assignment and commitment details for the entities (i.e. existing or prospect person or account) of the deal.	Yes
entityId	Used to specify the entity (i.e. existing or prospect person or account) whose price items commitments you want to update.	Yes
	Note: If you specify the entityType attribute, you need to specify the entityId attribute. The entityId should belong to the modelId .	
entityType	Used to indicate the type of the entity (i.e. existing or prospect person or account) whose price items commitments you want to update. The valid values are: <ul style="list-style-type: none"> • ACCT • PERS 	Yes

Attribute Name	Attribute Description	Mandatory (Yes or No)
	Note: If you specify the entityId attribute, you need to specify the entityType attribute.	
commitmentDetails	Used to specify the price item commitment details for the entity (i.e. existing or prospect person or account).	Yes
priceItemCode	Used to specify the price item whose commitments you want to update for the entity (i.e. existing or prospect person or account) of the deal.	Yes
priceItemDescription	Used to specify the description of the price item.	No
parameterDetails	Used to specify the parameters based on which the effective pricing is defined for the price item.	Yes
parameterCode	Used to specify the parameter.	Yes
parameterValue	Used to specify the value of the parameter.	Yes
SQIDetails	Used to specify the service quantity identifier details of the price item.	Yes
serviceQuantityIdentifier	Used to specify the service quantity identifier associated with the price item.	Yes
sqiValue	Used to specify the SQI value for the price item and parameter combination that you want to update for calculating the price item pricing.	Yes
sqiTypeFlg	Used to indicate the status of the service quantity identifier details for calculating the price item pricing. The valid value is: <ul style="list-style-type: none"> • PRPD 	Yes
actionFlag	Used to specify that you want to create request to update commitments for the deal. The valid value is: <ul style="list-style-type: none"> • UPD 	Yes

Once the deal commitments are updated, all the details of deal commitments are listed in the above mentioned attributes along with the following attributes:

Attribute Name	Attribute Description
dealId	Displays the identification value of the deal for which you have added the commitments. <p>Note: The value in this attribute appears when you specify the dealIdentifier or the modelId attribute while creating the update request.</p>
modelId	Displays the identification value of the deal for which you have added the commitments.

Attribute Name	Attribute Description
	Note: The value in this attribute appears when you specify the dealIdentifier or the dealId attribute while creating the update request.

Note:

Only **RM** (Relationship Manager) can create the deal commitments update request.

You can update commitments for a price item only when the price item and the parameter combination is valid.

Related Topics

For more information on...	See...
Sample deal commitments update request and response in the JSON format	Sample Deal Commitments Update Request and Response in the JSON Format on page 3971

Sample Deal Price Assignment Override Request and Response in the JSON Format

Using the below example, you can override the price assignment.

Sample Price Assignment Override Request in the JSON Format

```
{
  "C1-DealPriceAsgnCommitmentBS"
  {
    "dealIdentifier" : "RuleBUGFixing22",
    "inquiryModeflag" : "PRIC",
    "pricingcmtmntdtls"
    {
      "entityId" : "2762026417",
      "entityType" : "PERS",
      "pricingdtls"
      {
        "priceAsgnId" : "6810091985",
        "actionFlag" : "OVRD",
        "priceItemCode" : "DEAL_MULTIPARAM1",
        "priceStatusFlag" : "PRPD",
        "priceCurrencyCode" : "USD",
        "rateSchedule" : "BK-THRES",
        "startDate" : "2022-02-13",
        "endDate" : "2023-02-12",
        "isEligible" : "true",
        "paTypeFlag" : "RGLR",
        "printIfZero" : "Y",
        "priceasgnchar"
        {
          "characteristicType" : "DEALID",
          "effectiveDate" : "2022-04-05",
          "characteristicValue" : "2520094042",
          {
            "characteristicType" : "C2CLTYPE",
            "effectiveDate" : "2022-04-05",
            "characteristicValue" : "2520094042",
          }
        }
      }
    }
  }
  "priceasgnparm"
  {
    "priceParmCode" : "COUNTRY",
    "priceParmVal" : "BHARAT",
  }
}
```



```

"actionFlag" : "OVRD",
"priceItemCode" : "DEAL_MULTIPARAM1",
"priceItemDescription" : "Deal_MultiParam",
"hierarchyDetails" : "RECM AVR,RECM AVR",
"priceStatusFlag" : "PRPD",
"priceCurrencyCode" : "USD",
"rateSchedule" : "BK-THRES",
"startDate" : "2022-02-13",
"endDate" : "2023-02-12",
"isEligible" : "true",
"assignmentLevel" : "CUPI",
"paTypeFlag" : "RGLR",
"printIfZero" : "Y",
"priceasgnchar"
{
  "characteristicType" : "DEALID",
  "effectiveDate" : "2022-04-05",
  "characteristicValue" : "2520094042",
"priceasgnchar"
{
  "characteristicType" : "C2CLTYPE",
  "effectiveDate" : "2022-04-05",
  "characteristicValue" : "2520094042",
}
}
"priceasgnparm"
{
  "priceParmCode" : "COUNTRY",
  "priceParmVal" : "BHARAT",
}
"txnDailyRatingCrt" : "DNRT",
"ignoreSw" : "N",
"doNotAggSw" : "N",
"scheduleCode" : "MONTHLY",
"pricecompdtls"
{
  "priceCompTier"
  {
    "priceCompSequenceNo" : "20",
    "toVal" : "100",
    "fromVal" : "1",
    "priceCriteria" : "BK-NBR",
    "tieSeqNum" : "10",
    "priceparm" : "",
    {
      "parmCodeType" : "STATE",
      "priceParmCode" : "MAHARASHTRA",
    }
  }
"priceCompElg"
{
  "rhsPriceParmCd" : "ACCESSGRP",
  "rhsPriceParmVal" : "System Default",
  "lhsPriceParmCd" : "AGEBASED",
  "rhsPriceParmTypeFlg" : "PRM",
  "isInsufficientFlag" : "RLFS",
  "isFalseFlag" : "RLFS",
  "isTrueFlag" : "RLTR",
  "operator" : "=",
  "sequenceNumber" : "0",
}
"priceCompSequenceNo" : "20",
"priceCompId" : "2341932341",
"priceCompDesc" : "No of transaction",
"valueAmt" : "45.000000000000000000",
"priceComponentDisplay" : "true",

```



```

"priceAsgnId" : "6810091985",
"actionFlag" : "UPD",
"priceItemCode" : "DEAL_MULTIPARAM1",
"priceItemDescription" : "Deal_MultiParam",
"hierarchyDetails" : "RECMAVR,RECMAVR",
"priceStatusFlag" : "PRPD",
"priceCurrencyCode" : "USD",
"rateSchedule" : "BK-THRES",
"startDate" : "2022-02-13",
"endDate" : "2023-02-12",
"isEligible" : "true",
"assignmentLevel" : "CUPI",
"paTypeFlag" : "RGLR",
"printIfZero" : "Y",
"priceasgnchar"
{
  "characteristicType" : "DEALID",
  "effectiveDate" : "2022-04-05",
  "characteristicValue" : "2520094042",
"priceasgnchar"
{
  "characteristicType" : "C2CLTYPE",
  "effectiveDate" : "2022-04-05",
  "characteristicValue" : "2520094042",
}
}
"priceasgnparm"
{
  "priceParmCode" : "COUNTRY",
  "priceParmVal" : "BHARAT",
}
"txnDailyRatingCrt" : "DNRT",
"ignoreSw" : "N",
"doNotAggSw" : "N",
"scheduleCode" : "MONTHLY",
"pricecompdtls"
{
  "priceCompTier"
  {
    "priceCompSequenceNo" : "20",
    "toVal" : "100",
    "fromVal" : "1",
    "priceCriteria" : "BK-NBR",
    "tieSeqNum" : "10",
    "priceparm" : "",
    {
      "parmCodeType" : "STATE",
      "priceParmCode" : "MAHARASHTRA",
    }
  }
  "priceCompElg"
  {
    "rhsPriceParmCd" : "ACCESSGRP",
    "rhsPriceParmVal" : "System Default",
    "lhsPriceParmCd" : "AGEBASED",
    "rhsPriceParmTypeFlg" : "PRM",
    "isInsufficientFlag" : "RLFS",
    "isFalseFlag" : "RLFS",
    "isTrueFlag" : "RLTR",
    "operator" : "=",
    "sequenceNumber" : "0",
  }
  "priceCompSequenceNo" : "20",
  "priceCompId" : "2341932341",
  "priceCompDesc" : "No of transaction",
  "valueAmt" : "45.000000000000000000",

```



```

    {
      "priceParmCode" : "COUNTRY",
      "priceParmVal" : "BHARAT",
    }
    "txndailyRatingCrt" : "DNRT",
    "ignoreSw" : "N",
    "doNotAggSw" : "N",
    "scheduleCode" : "MONTHLY",
    "pricecompdtls"
    {
      "priceCompTier"
      {
        "toVal" : "1000.00",
        "fromVal" : "0.00",
        "priceCriteria" : "NBRTRAN",
        "tieSeqNum" : "10",
        "priceparm" : "",
        {
          "parmCodeType" : "STATE",
          "priceParmCode" : "MAHARASHTRA",
        }
      }
      "priceCompElg"
      {
        "rhsPriceParmCd" : "ACCESSGRP",
        "rhsPriceParmVal" : "System Default",
        "lhsPriceParmCd" : "AGEBASED",
        "rhsPriceParmTypeFlg" : "PRM",
        "isInsufficientFlag" : "RLFS",
        "isFalseFlag" : "RLFS",
        "isTrueFlag" : "RLTR",
        "operator" : "=",
        "sequenceNumber" : "0",
      }
      "priceCompSequenceNo" : "100",
      "priceCompDesc" : "Threshold price per transaction",
      "valueAmt" : "12.95",
      "priceComponentDisplay" : "true",
      "rcMapId" : "1109655113",
      "tieredFlag" : "THRS",
    }
  }
}

```

Note: If you do not want to enter the data in the list attributes (i.e. attributes where the type is set to list), you should not include them in the request. Adding empty list attributes will give erroneous results.

Sample Price Assignment Recommend Response in the JSON Format

```

{
  "Cl-DealPriceAsgnCommitmentBS"
  {
    "dealIdentifier" : "DEAL_EPER_PRIC_N_COMT_001_V1",
    "dealId" : "5888357415",
    "modelId" : "8459821555",
    "pricingcmtmtdtls"
    {
      "entityId" : "9902789911",
      "entityType" : "PERS",
      "entityIdentifierValue" : "Reg_BK_PRSP_PSEL_API_001",
      "entityIdentifierType" : "COREG",
    }
  }
}

```

```

"entityDivision" : "IND",
"pricingdtls"
{
  "priceAsgnId" : "9380016094",
  "actionFlag" : "RECM",
  "priceItemCode" : "PI_025",
  "priceItemDescription" : "V5-Domestic Funds Transfer Fee",
  "hierarchyDetails" : "CORPORATE BANKING, PAYMENT SERVICES",
  "priceStatusFlag" : "RECM",
  "priceCurrencyCode" : "USD",
  "rateSchedule" : "DM-NBRTH",
  "startDate" : "2022-02-13",
  "endDate" : "2023-02-12",
  "isEligible" : "true",
  "assignmentLevel" : "Customer Price List",
  "paTypeFlag" : "RGLR",
  "printIfZero" : "Y",
  "priceasgnchar"
  {
    "characteristicType" : "DEALID",
    "effectiveDate" : "2022-04-05",
    "characteristicValue" : "2520094042",
  }
  "priceasgnchar"
  {
    "characteristicType" : "C2CLTYPE",
    "effectiveDate" : "2022-04-05",
    "characteristicValue" : "2520094042",
  }
  "priceasgnparm"
  {
    "priceParmCode" : "COUNTRY",
    "priceParmVal" : "BHARAT",
  }
  "txnDailyRatingCrt" : "DNRT",
  "ignoreSw" : "N",
  "doNotAggSw" : "N",
  "scheduleCode" : "MONTHLY",
  "pricecompdtls"
  {
    "priceCompTier"
    {
      "toVal" : "1000.00",
      "fromVal" : "0.00",
      "priceCriteria" : "NBRTRAN",
      "tieSeqNum" : "10",
      "priceparm" : "",
      {
        "parmCodeType" : "STATE",
        "priceParmCode" : "MAHARASHTRA",
      }
    }
    "priceCompElg"
    {
      "rhsPriceParmCd" : "ACCESSGRP",
      "rhsPriceParmVal" : "System Default",
      "lhsPriceParmCd" : "AGEBASED",
      "rhsPriceParmTypeFlg" : "PRM",
      "isInsufficientFlag" : "RLFS",
      "isFalseFlag" : "RLFS",
      "isTrueFlag" : "RLTR",
      "operator" : "=",
      "sequenceNumber" : "0",
    }
    "priceCompSequenceNo" : "100",
    "priceCompId" : "5417400010",
  }
}

```



```

    "pricingdtls"
    {
      "priceAsgnId" : "9760032341",
      "actionFlag"  : "DEL",
      "isEligible"  : "false",
    }
  }
}

```

Note: We have given the above request and response samples to illustrate how the attribute value pairs should be structured while sending a deal price assignment delete request from the external system. However, you should not seamlessly use this request sample in your environment because the required pre-requisite data may not be available in your environment. In such case, the system will give erroneous results.

Related Topics

For more information on...	See...
Deal price assignment delete request and response attribute/value pairs in the JSON format	Deal Price Assignment Delete Request and Response - Attribute/Value Pairs in the JSON Format on page 3945

Sample Deal Price Assignment and Commitments View Request and Response in the JSON Format

Using the below example, you can view the price assignment and commitments.

Sample Deal Price Assignment and Commitments View Request in the JSON Format

```

{
  "C1-DealPriceAsgnCommitmentBS"
  {
    "modelId" : "9490517725",
    "inquiryModeflag" : "BOTH",
    "actionflag" : "READ",
  }
}

```

Sample Deal Price Assignment and Commitments View Response in the JSON Format

```

{
  "C1-DealPriceAsgnCommitmentBS"
  {
    "dealIdentifier" : "RuleBUGFixing22",
    "dealId" : "2510739370",
    "modelId" : "9490517725",
    "pricingcmntmtdtls"
    {
      "entityId" : "2762026417",
      "entityType" : "PERS",
      "entityIdentifierValue" : "123-12-1234",
      "entityIdentifierType" : "Social security number",
      "entityDivision" : "930-California",
      "pricingdtls"
      {
        "priceAsgnId" : "6810091985",
        "priceItemCode" : "DEAL_PRERANA3",
        "priceItemDescription" : "DealPrerana3",
        "hierarchyDetails" : "RECM AVR,RECM AVR",
        "priceStatusFlag" : "PRPD",
        "priceCurrencyCode" : "USD",
      }
    }
  }
}

```

```

"rateSchedule" : "BK-THRES",
"startDate" : "2022-02-13",
"endDate" : "2023-02-12",
"isEligible" : "true",
"assignmentLevel" : "CUPI",
"paTypeFlag" : "RGLR",
"printIfZero" : "Y",
"priceasgnchar"
{
  "characteristicType" : "DEALID",
  "effectiveDate" : "2022-04-05",
  "characteristicValue" : "2520094042",
"priceasgnchar"
{
  "characteristicType" : "C2CLTYPE",
  "effectiveDate" : "2022-04-05",
  "characteristicValue" : "2520094042",
}
"priceasgnparm"
{
  "priceParmCode" : "COUNTRY",
  "priceParmVal" : "IND",
}
"txnDailyRatingCrt" : "DNRT",
"ignoreSw" : "N",
"doNotAggSw" : "N",
"scheduleCode" : "MONTHLY",
"pricecompdtls"
{
  "priceCompTier"
  {
    "priceCompSequenceNo" : "20",
    "toVal" : "100",
    "fromVal" : "1",
    "priceCriteria" : "BK-NBR",
    "tieSeqNum" : "10",
    "priceparm" : "",
    {
      "parmCodeType" : "STATE",
      "priceParmCode" : "MAHARASHTRA",
    }
  }
  "priceCompElg"
  {
    "rhsPriceParmCd" : "ACCESSGRP",
    "rhsPriceParmVal" : "System Default",
    "lhsPriceParmCd" : "AGEBASED",
    "rhsPriceParmTypeFlg" : "PRM",
    "isInsufficientFlag" : "RLFS",
    "isFalseFlag" : "RLFS",
    "isTrueFlag" : "RLTR",
    "operator" : "=",
    "sequenceNumber" : "0",
  }
  "priceCompSequenceNo" : "20",
  "priceCompId" : "2341932341",
  "priceCompDesc" : "No of transaction",
  "valueAmt" : "45.000000000000000000",
  "priceComponentDisplay" : "true",
  "rcMapId" : "3999784532",
  "tieredFlag" : "THRS",
}
}
"commitmentDetails"
{
  "priceItemCode" : "DEAL_PRERANA3",

```

```

    "priceItemDescription" : "DealPrerana3",
    "parameterDetails"
    {
        "parameterCode" : "COUNTRY",
        "parameterValue" : "IND",
    }
    "SQIDetails"
    {
        "serviceQuantityIdentifier" : "BK-NBR",
        "sqiValue" : "12.000000000000000000",
        "sqiTypeFlg" : "PRPD",
    }
    }
}
}
}

```

Note: We have given the above request and response samples to illustrate how the attribute value pairs should be structured while sending deal price assignment and commitments view request from the external system. However, you should not seamlessly use this request sample in your environment because the required pre-requisite data may not be available in your environment. In such case, the system will give erroneous results.

Related Topics

For more information on...	See...
Deal price assignment and commitments view request and response attribute/value pairs in the JSON format	Deal Price Assignment and Commitments View Request and Response - Attribute/Value Pairs in the JSON Format on page 3947

Sample Deal Commitments Add Request and Response in the JSON Format

Using the below example, you can add commitments for the deal.

Sample Deal Commitments Add Request in the JSON Format

```

{
  "Cl-DealPriceAsgnCommitmentBS"
  {
    "modelId" : "8447774739",
    "inquiryModeflag" : "COMT",
    "pricingcmntmntdcls"
    {
      "entityId" : "2797545007",
      "entityType" : "PERS",
      "commitmentDetails"
      {
        "priceItemCode" : "DEAL_PRERANA3",
        "priceItemDescription" : "DealPrerana3",
        "parameterDetails"
        {
          "parameterCode" : "COUNTRY",
          "parameterValue" : "IND",
        }
        "SQIDetails"
        {
          "serviceQuantityIdentifier" : "BK-NBR",
          "sqiValue" : "12.000000000000000000",
          "sqiTypeFlg" : "PRPD",
          "actionFlag" : "ADD",
        }
      }
    }
  }
}

```

```

    }
  }
}

```

Note: If you do not want to enter the data in the list attributes (i.e. attributes where the type is set to list), you should not include them in the request. Adding empty list attributes will give erroneous results.

Sample Deal Commitments Add Response in the JSON Format

```

{
  "Cl-DealPriceAsgnCommitmentBS"
  {
    "dealId" : "5593158511",
    "modelId" : "8447774739",
    "pricingcmtmtdtls"
    {
      "entityId" : "2797545007",
      "entityType" : "PERS",
      "commitmentDetails"
      {
        "priceItemCode" : "DEAL_PRERANA3",
        "priceItemDescription" : "DealPrerana3",
        "parameterDetails"
        {
          "parameterCode" : "COUNTRY",
          "parameterValue" : "IND",
        }
      }
      "SQIDetails"
      {
        "serviceQuantityIdentifier" : "BK-NBR",
        "sqiValue" : "12.000000000000000000",
        "sqiTypeFlg" : "PRPD",
        "actionFlag" : "ADD",
      }
    }
  }
}

```

Note: We have given the above request and response samples to illustrate how the attribute value pairs should be structured while sending deal commitments add request from the external system. However, you should not seamlessly use this request sample in your environment because the required pre-requisite data may not be available in your environment. In such case, the system will give erroneous results.

Related Topics

For more information on...	See...
Deal commitments add request and response attribute/value pairs in the JSON format	Deal Commitments Add Request and Response - Attribute/Value Pairs in the JSON Format on page 3953

Sample Deal Commitments Update Request and Response in the JSON Format

Using the below example, you can update the deal commitments.

Sample Deal Commitments Update Request in the JSON Format

```

{
  "Cl-DealPriceAsgnCommitmentBS"
  {
    "dealId" : "5593158511",

```

```

    "inquiryModeflag" : "COMT",
    "pricingcmtmtdtls"
    {
        "entityId" : "2797545007",
        "entityType" : "PERS",
        "commitmentDetails"
        {
            "priceItemCode" : "DEAL_PRERANA3",
            "priceItemDescription" : "DealPrerana3",
            "parameterDetails"
            {
                "parameterCode" : "COUNTRY",
                "parameterValue" : "IND",
            }
            "SQIDetails"
            {
                "serviceQuantityIdentifier" : "BK-NBR",
                "sqiValue" : "12.000000000000000000",
                "sqiTypeFlg" : "PRPD",
                "actionFlag" : "UPD",
            }
        }
    }
}

```

Note: If you do not want to enter the data in the list attributes (i.e. attributes where the type is set to list), you should not include them in the request. Adding empty list attributes will give erroneous results.

Sample Deal Commitments Update Response in the JSON Format

```

{
  "C1-DealPriceAsgnCommitmentBS"
  {
    "dealId" : "5593158511",
    "modelId" : "8447774739",
    "pricingcmtmtdtls"
    {
      "entityId" : "2797545007",
      "entityType" : "PERS",
      "commitmentDetails"
      {
        "priceItemCode" : "DEAL_PRERANA3",
        "priceItemDescription" : "DealPrerana3",
        "parameterDetails"
        {
          "parameterCode" : "COUNTRY",
          "parameterValue" : "IND",
        }
        "SQIDetails"
        {
          "serviceQuantityIdentifier" : "BK-NBR",
          "sqiValue" : "12.000000000000000000",
          "sqiTypeFlg" : "PRPD",
          "actionFlag" : "UPD",
        }
      }
    }
  }
}

```

Note: We have given the above request and response samples to illustrate how the attribute value pairs should be structured while sending deal commitments update request from the external system. However, you should not seamlessly use this request sample in your environment because the required pre-requisite data may not be available in your environment. In such case, the system will give erroneous results.

Related Topics

For more information on...	See...
Deal commitments update request and response attribute/value pairs in the JSON format	Deal Commitments Update Request and Response - Attribute/Value Pairs in the JSON Format on page 3955

Deal Creation, Modification, and View through Inbound Web Service

Oracle Revenue Management and Billing enables you to create and edit a deal through a web service. At a time, you can create or edit only one deal version of a deal. It also enables you to view the details of a deal version through a web service. You can send a request from the external system to do the following through an inbound web service:

- Create a deal with or without using a reference and/or a deal template
- Edit the details of a deal version
- View the details of a deal version
- Add a new deal version to a deal
- Simulate a deal version
- Send a deal version for approval
- Approve a deal version
- Return a deal version to the submitter
- Finalize a deal version
- Accept or reject a deal version
- View the price items assigned to the existing customer or account for which the deal is created
- Select the price items for which you want to inherit, override, or edit pricing and add commitments in the deal version

At a time, you can send a request for any one of the above activities. We have shipped the following two inbound web services in this release:

- **C1-CreateDealService** - This is a SOAP based web service. You can use this web service when you want to send the above requests with respect to deal in the XML format.
- **C1-DealServiceREST** - This is a REST based web service. You can use this web service when you want to send the above requests with respect to deal in the XML or JSON format.

Both these inbound web services call the **C1-DealCreationUpdateIWS** business service. This business service is used to do the following:

- **Create a deal with or without using a reference and/or a deal template** - While creating a deal, you can specify the following details:
 - Entity (i.e. existing or prospect customer or account) for which you want to create the deal
 - Details of the customer, main customer (in case of account), or prospect, such as customer segment, customer tier, division, etc.
 - Basic details of the deal, such as simulation type, review frequency, deal and deal version description, price selection date, usage period, etc.

- Template details in case you want to create the deal using a deal template
- Characteristics and terms and conditions for the deal
- Recommended products for the deal
- Whether you want to refer another entity or deal for pricing and commitments

To add a deal through the web service, you must set the action flag to **ADD**. On processing the request, the system creates the deal and its deal version in the **PSML** or **DHRC** status.

- **Edit the details of a deal version** - While editing a deal version of a deal, you need to:
 - Specify the deal version ID or deal ID or deal identifier to determine the deal version that you want to edit
 - Set the action flag to **UPD**

During the update operation, the system replaces the deal version data instead of editing it. Therefore, you should provide all details of the deal version including the data that you want to change.

- **View the details of a deal version** - While viewing the details of a deal version, you need to:
 - Specify the deal version ID or deal ID or deal identifier to determine the deal version whose details you want to view
 - Set the action flag to **READ**

On processing the request, the system displays the details of the deal and its deal version.

- **Add a new deal version to a deal** – While adding a deal version to a deal, you need to:
 - Specify the deal version ID or deal ID or deal identifier to determine the deal in which you want to add the version
 - Specify the description for the deal version
 - Specify the method using which you want to create the deal version
 - Set the action flag to **ADD** and the operation flag to **CRDV**

On processing the request, the system creates the deal version in the **PSML** or **DHRC** status.

- **Simulate a deal version** - While simulating a deal version of a deal, you need to:
 - Specify the deal version ID or deal ID or deal identifier to determine the deal version that you want to simulate
 - Set the action flag to **UPD** and the operation flag to **SMLD**

On processing the request, the status of the deal version is changed to **SMLD** or **DSML**. If the deal version is in the **SMLD** status, the system displays the deal level financial summary, division level financial summary (if any), and product level financial summary (if any) along with the hierarchy level simulation details.

- **Send a deal version for approval** - While sending a deal version for approval, you need to:
 - Specify the deal version ID or deal ID or deal identifier to determine the deal version that you want to send for approval
 - Set the action flag to **UPD** and the operation flag to **SNDP**

On processing the request, the system sends the deal version to the deal approval hierarchy. If the product and/or division level approval is required for the deal, the system sends the deal version to the product and/or division approval hierarchy before it goes to the deal approval hierarchy.

- **Approve a deal version** - While approving a deal version, you need to:
 - Specify the deal version ID or deal ID or deal identifier to determine the deal version that you want to approve
 - Set the action flag to **UPD** and the operation flag to **APPR**

On processing the request, the system either approves the deal version or sends the deal to the next level in the approval hierarchy. Only the approver at the respective level in the product, division, or deal approval hierarchy can approve the deal version of the deal.

- **Return the deal version to the submitter** - While requesting the submitter to resubmit the deal version for approval, you need to:
 - Specify the deal version ID or deal ID or deal identifier to determine the deal version that you want to return to the submitter
 - Set the action flag to **UPD** and the operation flag to **RETN**

On processing the request, the deal is resubmitted to the submitter to incorporate the changes requested by the approver.

- **Finalize a deal version** - While finalizing a deal version, you need to:
 - Specify the deal version ID or deal ID or deal identifier to determine the deal version that you want to finalize
 - Set the action flag to **UPD** and the operation flag to **FNAL**

On processing the request, the deal is finalized and its status is changed to **FNAL**.

- **Accept a deal version** - While accepting a deal version, you need to:
 - Specify the deal version ID or deal ID or deal identifier to determine the deal version that you want to review
 - Set the action flag to **UPD** and the operation flag to **ACPT**
 - Specify the start date from when the deal version will be effective and end date (if it is a contracted deal) till when the deal version will be effective

On processing the request, the status of the deal is changed to **ACPT**.

- **Reject a deal version** - While rejecting a deal version, you need to:
 - Specify the deal version ID or deal ID or deal identifier to determine the deal version that you want to review
 - Set the action flag to **UPD** and the operation flag to **REJC**
 - Reason why you want to reject the deal version

On processing the request, the status of the deal is changed to **REJC**.

- **Discard a deal version** - While discarding a deal version, you need to:
 - Specify the deal version ID or deal ID or deal identifier to determine the deal that you want to discard
 - Set the action flag to **UPD** and the operation flag to **DSCR**

On processing the request, the status of the deal is changed to **DSCR**.

- **View the price items assigned to the customer or account for which the deal is created** - While viewing the price items assigned to the existing entity for which the deal is created, you need to:
 - Specify the deal version ID or deal ID or deal identifier to determine the deal whose details you want to view
 - Set the action flag to **READ** and the operation flag to **PSEL**

On processing the request, the system lists all price items which are currently assigned to the entity using the respective pricing parameters. It also indicates whether any price item and pricing parameters combination is available in the deal version at the moment for defining the proposed pricing and commitments.

- **Select the price items for which you want to inherit, override, or edit pricing and add commitments in the deal version** – While selecting the price items in a deal version, you need to:
 - Specify the deal version ID or deal ID or deal identifier to determine the deal version which you want to edit
 - Set the action flag to **UPD** and the operation flag to **PSEL**
 - Set the **Include** flag of the price item and pricing parameters combination to **true**

On processing the request, the system enables you to define proposed pricing and commitments for the selected price item and pricing parameters combination.

If both the deal version and deal ID or deal identifier are given in the request, the system considers the deal version. However, if only the deal ID or deal identifier is given in the request, the system derives the deal version. Note that an error occurs when the given deal has multiple deal versions. For more information about the Deal Management functionality, refer to *Oracle Revenue Management and Billing Banking User Guide*.

Deal Creation Request in the XML Format

The following code snippet illustrates how the tags should be nested while receiving the deal creation request in the XML Format.

```
<Cl-DealCreationUpdateIWS>
  <actionFlag></actionFlag>
  <dealDetails>
    <dealEntityDetails>
      <personIdentifierType></personIdentifierType>
      <personIdentifier></personIdentifier>
      <personId></personId>
      <accountIdentifierType></accountIdentifierType>
      <accountIdentifier></accountIdentifier>
      <accountId></accountId>
      <prsPerIdentifierType></prsPerIdentifierType>
      <prsPerIdentifier></prsPerIdentifier>
      <prospectPersonId></prospectPersonId>
      <division></division>
    </dealEntityDetails>
    <dealIdentifier></dealIdentifier>
    <dealEntityType></dealEntityType>
    <customerSegment></customerSegment>
    <customerTier></customerTier>
    <division></division>
    <accessGrp></accessGrp>
    <contractedDealFlag></contractedDealFlag>
    <currency></currency>
    <dealTypeCode></dealTypeCode>
    <startDate></startDate>
    <endDate></endDate>
    <simulationTypeFlag></simulationTypeFlag>
    <reviewFrequency></reviewFrequency>
    <dealDescription></dealDescription>
    <dealVersionDescription></dealVersionDescription>
    <dealFrequency></dealFrequency>
    <skipReferenceFlag></skipReferenceFlag>
    <priceSelectionDate></priceSelectionDate>
    <usagePeriod></usagePeriod>
    <includeHierarchyFlag></includeHierarchyFlag>
    <status></status>
    <dealVersionStatus></dealVersionStatus>
    <templateFlag></templateFlag>
  </dealDetails>
  <templateReferenceDetails>
    <templateDealId></templateDealId>
    <templateDealIdentifier></templateDealIdentifier>
    <templateModelId></templateModelId>
    <copyBasicDetailsFlag></copyBasicDetailsFlag>
    <copyPricingFlag></copyPricingFlag>
    <copyUsageFlag></copyUsageFlag>
  </templateReferenceDetails>
  <dealCharacteristics>
    <characteristicType></characteristicType>
    <effectiveDate></effectiveDate>
```

```

    <characteristicValue></characteristicValue>
  </dealCharacteristics>
  <dealTermsAndConditionsDetails>
    <termsAndConditionsList>
      <description></description>
      <termsAndCondition></termsAndCondition>
      <termsAndConditionText></termsAndConditionText>
    </termsAndConditionsList>
    <adhocTermsAndCondition></adhocTermsAndCondition>
  </dealTermsAndConditionsDetails>
  <productDetailsList>
    <productCode></productCode>
  </productDetailsList>
  <referenceDetails>
    <referenceTypeFlg></referenceTypeFlg>
    <refPersonIdentifierType></refPersonIdentifierType>
    <refPersonIdentifier></refPersonIdentifier>
    <referPersonId></referPersonId>
    <refAccountIdentifierType></refAccountIdentifierType>
    <refAccountIdentifier></refAccountIdentifier>
    <referAccountId></referAccountId>
    <referDealIdentifier></referDealIdentifier>
    <referenceDealId></referenceDealId>
    <referenceModelId></referenceModelId>
    <referUsageSw></referUsageSw>
    <referPriceSw></referPriceSw>
    <includeChildHierarchy></includeChildHierarchy>
  </referenceDetails>
</C1-DealCreationUpdateIWS>

```

Related Topics

For more information on...	See...
Deal creation request and response tags in the XML format	Deal Creation Request and Response - Tags in the XML Format on page 3989
Sample deal creation request and response in the XML format	Sample Deal Creation Request and Response in the XML Format on page 4045

Deal Creation Response in the XML Format

The following code snippet illustrates how the tags should be nested while sending the deal creation response in the XML Format.

```

<C1-DealCreationUpdateIWS>
  <actionFlag></actionFlag>
  <dealresponse>
    <message></message>
  </dealresponse>
  <dealDetails>
    <dealEntityDetails>
      <personIdentifierType></personIdentifierType>
      <personIdentifier></personIdentifier>
      <personId></personId>
      <accountIdentifierType></accountIdentifierType>
      <accountIdentifier></accountIdentifier>
      <accountId></accountId>
      <prsPerIdentifierType></prsPerIdentifierType>
      <prsPerIdentifier></prsPerIdentifier>
      <prospectPersonId></prospectPersonId>
      <division></division>
    </dealEntityDetails>
  </dealDetails>
</C1-DealCreationUpdateIWS>

```

```

    <dealIdentifier></dealIdentifier>
    <dealInformation></dealInformation>
    <dealId></dealId>
    <modelId></modelId>
    <dealEntityType></dealEntityType>
    <customerSegment></customerSegment>
    <customerTier></customerTier>
    <division></division>
    <accessGrp></accessGrp>
    <dealEntityId></dealEntityId>
    <contractedDealFlag></contractedDealFlag>
    <currency></currency>
    <dealTypeCode></dealTypeCode>
    <startDate></startDate>
    <endDate></endDate>
    <simulationTypeFlag></simulationTypeFlag>
    <reviewFrequency></reviewFrequency>
    <dealDescription></dealDescription>
    <longDescription></longDescription>
    <dealVersionDescription></dealVersionDescription>
    <dealFrequency></dealFrequency>
    <skipReferenceFlag></skipReferenceFlag>
    <priceSelectionDate></priceSelectionDate>
    <usagePeriod></usagePeriod>
    <includeHierarchyFlag></includeHierarchyFlag>
    <status></status>
    <dealVersionStatus></dealVersionStatus>
    <templateFlag></templateFlag>
  </dealDetails>
  <templateReferenceDetails>
    <templateDealId></templateDealId>
    <templateDealIdentifier></templateDealIdentifier>
    <templateModelId></templateModelId>
    <copyBasicDetailsFlag></copyBasicDetailsFlag>
    <copyPricingFlag></copyPricingFlag>
    <copyUsageFlag></copyUsageFlag>
  </templateReferenceDetails>
  <dealCharacteristics>
    <characteristicType></characteristicType>
    <effectiveDate></effectiveDate>
    <characteristicValue></characteristicValue>
  </dealCharacteristics>
  <dealTermsAndConditionsDetails>
    <termsAndConditionsList>
      <description></description>
      <termsAndCondition></termsAndCondition>
      <termsAndConditionText></termsAndConditionText>
    </termsAndConditionsList>
    <adhocTermsAndCondition></adhocTermsAndCondition>
  </dealTermsAndConditionsDetails>
  <productDetailsList>
    <productCode></productCode>
  </productDetailsList>
  <referenceDetails>
    <referenceTypeFlg></referenceTypeFlg>
    <refPersonIdentifierType></refPersonIdentifierType>
    <refPersonIdentifier></refPersonIdentifier>
    <referPersonId></referPersonId>
    <refAccountIdentifierType></refAccountIdentifierType>
    <refAccountIdentifier></refAccountIdentifier>
    <referAccountId></referAccountId>
    <referDealIdentifier></referDealIdentifier>
    <referenceDealId></referenceDealId>
    <referenceModelId></referenceModelId>
  </referenceDetails>

```

```

    <referUsageSw></referUsageSw>
    <referPriceSw></referPriceSw>
    <includeChildHierarchy></includeChildHierarchy>
    <division></division>
  </referenceDetails>
</Cl-DealCreationUpdateIWS>

```

Related Topics

For more information on...	See...
Deal creation request and response tags in the XML format	Deal Creation Request and Response - Tags in the XML Format on page 3989
Sample deal creation request and response in the XML format	Sample Deal Creation Request and Response in the XML Format on page 4045

Deal Update Request in the XML Format

The following code snippet illustrates how the tags should be nested while sending the deal update request in the XML format:

```

<Cl-DealCreationUpdateIWS>
  <actionFlag></actionFlag>
  <dealOperation>
    <operationFlag></operationFlag>
    <dealIdentifier></dealIdentifier>
    <dealId></dealId>
    <modelId></modelId>
    <dealAcceptEffStartDate></dealAcceptEffStartDate>
    <dealAcceptEffEndDate></dealAcceptEffEndDate>
    <comments></comments>
    <rejectReasonCode></rejectReasonCode>
  </dealOperation>
  <priceItemGroupSelection>
    <priceItemSelectionList>
      <priceItemCode></priceItemCode>
      <priceItemInfo></priceItemInfo>
      <parameterInfo></parameterInfo>
      <assignmentLevel></assignmentLevel>
      <priceAssignmentId></priceAssignmentId>
      <hierarchyDetails></hierarchyDetails>
      <includeFlag></includeFlag>
    </priceItemSelectionList>
  </priceItemGroupSelection>
  <dealDetails>
    <dealEntityDetails>
      <personIdentifierType></personIdentifierType>
      <personIdentifier></personIdentifier>
      <personId></personId>
      <accountIdentifierType></accountIdentifierType>
      <accountIdentifier></accountIdentifier>
      <accountId></accountId>
      <prsPerIdentifierType></prsPerIdentifierType>
      <prsPerIdentifier></prsPerIdentifier>
      <prospectPersonId></prospectPersonId>
      <division></division>
    </dealEntityDetails>
    <dealIdentifier></dealIdentifier>
    <dealInformation></dealInformation>
    <dealEntityType></dealEntityType>
    <customerSegment></customerSegment>
    <customerTier></customerTier>
  </dealDetails>
</Cl-DealCreationUpdateIWS>

```

```

    <division></division>
    <accessGrp></accessGrp>
    <dealEntityId></dealEntityId>
    <contractedDealFlag></contractedDealFlag>
    <currency></currency>
    <dealTypeCode></dealTypeCode>
    <startDate></startDate>
    <endDate></endDate>
    <simulationTypeFlag></simulationTypeFlag>
    <reviewFrequency></reviewFrequency>
    <dealDescription></dealDescription>
    <dealVersionDescription></dealVersionDescription>
    <dealFrequency></dealFrequency>
    <skipReferenceFlag></skipReferenceFlag>
    <priceSelectionDate></priceSelectionDate>
    <usagePeriod></usagePeriod>
    <includeHierarchyFlag></includeHierarchyFlag>
    <status></status>
    <dealVersionStatus></dealVersionStatus>
    <templateFlag></templateFlag>
  </dealDetails>
  <templateReferenceDetails>
    <templateDealId></templateDealId>
    <templateDealIdentifier></templateDealIdentifier>
    <templateModelId></templateModelId>
    <copyBasicDetailsFlag></copyBasicDetailsFlag>
    <copyPricingFlag></copyPricingFlag>
    <copyUsageFlag></copyUsageFlag>
  </templateReferenceDetails>
  <dealCharacteristics>
    <characteristicType></characteristicType>
    <effectiveDate></effectiveDate>
    <characteristicValue></characteristicValue>
  </dealCharacteristics>
  <dealTermsAndConditionsDetails>
    <termsAndConditionsList>
      <description></description>
      <termsAndCondition></termsAndCondition>
      <termsAndConditionText></termsAndConditionText>
    </termsAndConditionsList>
    <adhocTermsAndCondition></adhocTermsAndCondition>
  </dealTermsAndConditionsDetails>
  <productDetailsList>
    <productCode></productCode>
  </productDetailsList>
  <referenceDetails>
    <referenceTypeFlg></referenceTypeFlg>
    <refPersonIdentifierType></refPersonIdentifierType>
    <refPersonIdentifier></refPersonIdentifier>
    <referPersonId></referPersonId>
    <refAccountIdentifierType></refAccountIdentifierType>
    <refAccountIdentifier></refAccountIdentifier>
    <referAccountId></referAccountId>
    <referDealIdentifier></referDealIdentifier>
    <referenceDealId></referenceDealId>
    <referenceModelId></referenceModelId>
    <referUsageSw></referUsageSw>
    <referPriceSw></referPriceSw>
    <includeChildHierarchy></includeChildHierarchy>
    <division></division>
  </referenceDetails>
</C1-DealCreationUpdateIWS>

```

Related Topics

For more information on...	See...
Deal update request and response tags in the XML format	Deal Update Request and Response - Tags in the XML Format on page 4010
Sample deal update request and response in the XML format	Sample Deal Update Request and Response in the XML Format on page 4049
Sample deal version creation request and response in the XML format	Sample Deal Version Creation Request and Response in the XML Format on page 4051
Sample deal simulation request and response in the XML format	Sample Deal Simulation Request and Response in the XML Format on page 4052
Sample deal submission for approval request and response in the XML format	Sample Deal Submission for Approval Request and Response in the XML Format on page 4056
Sample deal approval request and response in the XML format	Sample Deal Approval Request and Response in the XML Format on page 4058
Sample deal return to submitter request and response in the XML format	Sample Deal Return to Submitter Request and Response in the XML Format on page 4060
Sample deal finalization request and response in the XML format	Sample Deal Finalization Request and Response in the XML Format on page 4061
Sample deal acceptance request and response in the XML format	Sample Deal Acceptance Request and Response in the XML Format on page 4063
Sample deal rejection request and response in the XML format	Sample Deal Rejection Request and Response in the XML Format on page 4064
Sample price item selection request and response in the XML format	Sample Price Item Selection Request and Response in the XML Format on page 4070

Deal Update Response in the XML Format

The following code snippet illustrates how the tags should be nested while receiving the deal response in the XML format:

```
<Cl-DealCreationUpdateIWS>
  <actionFlag></actionFlag>
  <dealResponse>
    <message></message>
  </dealResponse>
  <dealOperation>
    <operationFlag></operationFlag>
    <dealIdentifier></dealIdentifier>
    <dealId></dealId>
    <modelId></modelId>
    <dealAcceptEffStartDate></dealAcceptEffStartDate>
    <dealAcceptEffEndDate></dealAcceptEffEndDate>
    <comments></comments>
    <rejectReasonCode></rejectReasonCode>
    <dealVersionDescription></dealVersionDescription>
    <dealVersionCreationFlag></dealVersionCreationFlag>
  </dealOperation>
  <priceItemGroupSelection>
    <priceItemSelectionList>
      <priceItemCode></priceItemCode>
      <priceItemInfo></priceItemInfo>
      <parameterInfo></parameterInfo>
      <assignmentLevel></assignmentLevel>
    </priceItemSelectionList>
  </priceItemGroupSelection>
</Cl-DealCreationUpdateIWS>
```

```

        <priceAssignmentId></priceAssignmentId>
        <hierarchyDetails></hierarchyDetails>
        <includeFlag></includeFlag>
    </priceItemSelectionList>
</priceItemGroupSelection>
<dealDetails>
    <dealEntityDetails>
        <personIdentifierType></personIdentifierType>
        <personIdentifier></personIdentifier>
        <personId></personId>
        <accountIdentifierType></accountIdentifierType>
        <accountIdentifier></accountIdentifier>
        <accountId></accountId>
        <prsPerIdentifierType></prsPerIdentifierType>
        <prsPerIdentifier></prsPerIdentifier>
        <prospectPersonId></prospectPersonId>
        <division></division>
    </dealEntityDetails>
    <dealIdentifier></dealIdentifier>
    <dealInformation></dealInformation>
    <dealId></dealId>
    <modelId></modelId>
    <dealEntityType></dealEntityType>
    <customerSegment></customerSegment>
    <customerTier></customerTier>
    <division></division>
    <accessGrp></accessGrp>
    <dealEntityId></dealEntityId>
    <contractedDealFlag></contractedDealFlag>
    <currency></currency>
    <dealTypeCode></dealTypeCode>
    <startDate></startDate>
    <endDate></endDate>
    <simulationTypeFlag></simulationTypeFlag>
    <reviewFrequency></reviewFrequency>
    <dealDescription></dealDescription>
    <longDescription></longDescription>
    <dealVersionDescription></dealVersionDescription>
    <dealFrequency></dealFrequency>
    <skipReferenceFlag></skipReferenceFlag>
    <priceSelectionDate></priceSelectionDate>
    <usagePeriod></usagePeriod>
    <includeHierarchyFlag></includeHierarchyFlag>
    <status></status>
    <dealVersionStatus></dealVersionStatus>
    <templateFlag></templateFlag>
    <createdDate></createdDate>
    <acceptanceDate></acceptanceDate>
    <finalizedDate></finalizedDate>
    <effectiveStartDate></effectiveStartDate>
    <effectiveEndDate></effectiveEndDate>
    <reviewedDate></reviewedDate>
</dealDetails>
<templateReferenceDetails>
    <templateDealId></templateDealId>
    <templateDealIdentifier></templateDealIdentifier>
    <templateModelId></templateModelId>
    <copyBasicDetailsFlag></copyBasicDetailsFlag>
    <copyPricingFlag></copyPricingFlag>
    <copyUsageFlag></copyUsageFlag>
</templateReferenceDetails>
<dealCharacteristics>
    <characteristicType></characteristicType>
    <effectiveDate></effectiveDate>

```

```

    <characteristicValue></characteristicValue>
  </dealCharacteristics>
  <dealTermsAndConditionsDetails>
    <termsAndConditionsList>
      <description></description>
      <termsAndCondition></termsAndCondition>
      <termsAndConditionText></termsAndConditionText>
    </termsAndConditionsList>
    <adhocTermsAndCondition></adhocTermsAndCondition>
  </dealTermsAndConditionsDetails>
  <productDetailsList>
    <productCode></productCode>
  </productDetailsList>
  <referenceDetails>
    <referenceTypeFlg></referenceTypeFlg>
    <refPersonIdentifierType></refPersonIdentifierType>
    <refPersonIdentifier></refPersonIdentifier>
    <referPersonId></referPersonId>
    <refAccountIdentifierType></refAccountIdentifierType>
    <refAccountIdentifier></refAccountIdentifier>
    <referAccountId></referAccountId>
    <referDealIdentifier></referDealIdentifier>
    <referenceDealId></referenceDealId>
    <referenceModelId></referenceModelId>
    <referUsageSw></referUsageSw>
    <referPriceSw></referPriceSw>
    <includeChildHierarchy></includeChildHierarchy>
    <division></division>
  </referenceDetails>
  <dealSimulationDetails>
    <dealfinancialsummarylist>
      <approvalStatus></approvalStatus>
      <originalDealFinanciencialSummary>
        <revenue></revenue>
        <cost></cost>
        <profit></profit>
        <profitabilityPercentage></profitabilityPercentage>
      </originalDealFinanciencialSummary>
      <proposedDealFinanciencialSummary>
        <revenue></revenue>
        <cost></cost>
        <profit></profit>
        <profitabilityPercentage></profitabilityPercentage>
      </proposedDealFinanciencialSummary>
      <recommenedDealFinanciencialSummary>
        <revenue></revenue>
        <profit></profit>
        <profitabilityPercentage></profitabilityPercentage>
      </recommenedDealFinanciencialSummary>
      <profitVariationPercentage></profitVariationPercentage>
    </dealfinancialsummarylist>
    <divisionFinancialSummaryDetails>
      <division></division>
      <approvalStatus></approvalStatus>
      <originalDivisionFinanciencialSummary>
        <revenue></revenue>
        <cost></cost>
        <profit></profit>
        <profitabilityPercentage></profitabilityPercentage>
      </originalDivisionFinanciencialSummary>
      <proposedDivisionFinanciencialSummary>
        <revenue></revenue>
        <cost></cost>
        <profit></profit>
    </proposedDivisionFinanciencialSummary>
  </divisionFinancialSummaryDetails>

```

```

        <profitabilityPercentage></profitabilityPercentage>
    </proposedDivisionFinancialSummary>
    <recommendedDealFinancialSummary>
        <revenue></revenue>
        <profit></profit>
        <profitabilityPercentage></profitabilityPercentage>
    </recommendedDealFinancialSummary>
    <profitVariationPercentage></profitVariationPercentage>
</divisionFinancialSummaryDetails>
<productFinancialSummaryDetails>
    <approvalStatus></approvalStatus>
    <product></product>
    <division></division>
    <originalProductFinancialSummary>
        <revenue></revenue>
        <cost></cost>
        <profit></profit>
        <profitabilityPercentage></profitabilityPercentage>
    </originalProductFinancialSummary>
    <proposedProductDivisionFinancialSummary>
        <revenue></revenue>
        <cost></cost>
        <profit></profit>
        <profitabilityPercentage></profitabilityPercentage>
    </proposedProductDivisionFinancialSummary>
    <recommendedDealFinancialSummary>
        <revenue></revenue>
        <profit></profit>
        <profitabilityPercentage></profitabilityPercentage>
    </recommendedDealFinancialSummary>
    <profitVariationPercentage></profitVariationPercentage>
</productFinancialSummaryDetails>
</dealSimulationDetails>
<hierarchySimulationDetails>
    <hierarchyDetails>
        <entityType></entityType>
        <entityId></entityId>
        <parentEntityId></parentEntityId>
        <status></status>
        <revenueVariation></revenueVariation>
        <proposedRevenue></proposedRevenue>
        <proposedCost></proposedCost>
        <originalRevenue></originalRevenue>
        <originalCost></originalCost>
    </hierarchyDetails>
</hierarchySimulationDetails>
</C1-DealCreationUpdateIWS>

```

Related Topics

For more information on...	See...
Deal update request and response tags in the XML format	Deal Update Request and Response - Tags in the XML Format on page 4010
Sample deal update request and response in the XML format	Sample Deal Update Request and Response in the XML Format on page 4049
Sample deal version creation request and response in the XML format	Sample Deal Version Creation Request and Response in the XML Format on page 4051
Sample deal simulation request and response in the XML format	Sample Deal Simulation Request and Response in the XML Format on page 4052

For more information on...	See...
Sample deal submission for approval request and response in the XML format	Sample Deal Submission for Approval Request and Response in the XML Format on page 4056
Sample deal approval request and response in the XML format	Sample Deal Approval Request and Response in the XML Format on page 4058
Sample deal return to submitter request and response in the XML format	Sample Deal Return to Submitter Request and Response in the XML Format on page 4060
Sample deal finalization request and response in the XML format	Sample Deal Finalization Request and Response in the XML Format on page 4061
Sample deal acceptance request and response in the XML format	Sample Deal Acceptance Request and Response in the XML Format on page 4063
Sample deal rejection request and response in the XML format	Sample Deal Rejection Request and Response in the XML Format on page 4064
Sample price item selection request and response in the XML format	Sample Price Item Selection Request and Response in the XML Format on page 4070

Deal View Request in the XML Format

The following code snippet illustrates how the tags should be nested while receiving the deal view request in the XML format:

```
<C1-DealCreationUpdateIWS>
  <actionFlag></actionFlag>
  <dealOperation>
    <operationFlag></operationFlag>
    <dealIdentifier></dealIdentifier>
    <dealId></dealId>
    <modelId></modelId>
  </dealOperation>
  <dealDetails>
    <dealIdentifier></dealIdentifier>
    <dealId></dealId>
    <modelId></modelId>
  </dealDetails>
</C1-DealCreationUpdateIWS>
```

Related Topics

For more information on...	See...
Deal view request and response - tags in the XML format	Deal View Request and Response - Tags in the XML Format on page 4032
Sample deal view request and response in the XML format	Sample Deal View Request and Response in the XML Format on page 4047
Sample price item selection view request and response in the XML format	Sample Price Item Selection View Request and Response in the XML Format on page 4068

Deal View Response in the XML Format

The following code snippet illustrates how the tags should be nested while sending the deal view response in the XML Format.

```
<C1-DealCreationUpdateIWS>
  <actionFlag></actionFlag>
```

```

<dealOperation>
  <operationFlag></operationFlag>
  <dealIdentifier></dealIdentifier>
  <dealId></dealId>
  <modelId></modelId>
  <dealAcceptEffStartDate></dealAcceptEffStartDate>
  <dealAcceptEffEndDate></dealAcceptEffEndDate>
  <comments></comments>
  <rejectReasonCode></rejectReasonCode>
</dealOperation>
<priceItemGroupSelection>
  <priceItemSelectionList>
    <priceItemCode></priceItemCode>
    <priceItemInfo></priceItemInfo>
    <parameterInfo></parameterInfo>
    <assignmentLevel></assignmentLevel>
    <priceAssignmentId></priceAssignmentId>
    <hierarchyDetails></hierarchyDetails>
    <includeFlag></includeFlag>
  </priceItemSelectionList>
</priceItemGroupSelection>
<dealDetails>
  <dealEntityDetails>
    <personIdentifierType></personIdentifierType>
    <personIdentifier></personIdentifier>
    <personId></personId>
    <accountIdentifierType></accountIdentifierType>
    <accountIdentifier></accountIdentifier>
    <accountId></accountId>
    <prsPerIdentifierType></prsPerIdentifierType>
    <prsPerIdentifier></prsPerIdentifier>
    <prospectPersonId></prospectPersonId>
    <division></division>
  </dealEntityDetails>
  <dealIdentifier></dealIdentifier>
  <dealInformation></dealInformation>
  <dealId></dealId>
  <modelId></modelId>
  <dealEntityType></dealEntityType>
  <customerSegment></customerSegment>
  <customerTier></customerTier>
  <division></division>
  <accessGrp></accessGrp>
  <dealEntityId></dealEntityId>
  <contractedDealFlag></contractedDealFlag>
  <currency></currency>
  <dealTypeCode></dealTypeCode>
  <startDate></startDate>
  <endDate></endDate>
  <simulationTypeFlag></simulationTypeFlag>
  <reviewFrequency></reviewFrequency>
  <dealDescription></dealDescription>
  <longDescription></longDescription>
  <dealVersionDescription></dealVersionDescription>
  <dealFrequency></dealFrequency>
  <skipReferenceFlag></skipReferenceFlag>
  <priceSelectionDate></priceSelectionDate>
  <usagePeriod></usagePeriod>
  <includeHierarchyFlag></includeHierarchyFlag>
  <status></status>
  <dealVersionStatus></dealVersionStatus>
  <templateFlag></templateFlag>
  <createdDate></createdDate>
  <acceptanceDate></acceptanceDate>

```

```

    <finalizedDate></finalizedDate>
    <effectiveStartDate></effectiveStartDate>
    <effectiveEndDate></effectiveEndDate>
    <reviewedDate></reviewedDate>
  </dealDetails>
  <templateReferenceDetails>
    <templateDealId></templateDealId>
    <templateDealIdentifier></templateDealIdentifier>
    <templateModelId></templateModelId>
    <copyBasicDetailsFlag></copyBasicDetailsFlag>
    <copyPricingFlag></copyPricingFlag>
    <copyUsageFlag></copyUsageFlag>
  </templateReferenceDetails>
  <dealCharacteristics>
    <characteristicType></characteristicType>
    <effectiveDate></effectiveDate>
    <characteristicValue></characteristicValue>
  </dealCharacteristics>
  <dealTermsAndConditionsDetails>
    <termsAndConditionsList>
      <description></description>
      <termsAndCondition></termsAndCondition>
      <termsAndConditionText></termsAndConditionText>
    </termsAndConditionsList>
    <adhocTermsAndCondition></adhocTermsAndCondition>
  </dealTermsAndConditionsDetails>
  <productDetailsList>
    <productCode></productCode>
  </productDetailsList>
  <referenceDetails>
    <referenceTypeFlg></referenceTypeFlg>
    <refPersonIdentifierType></refPersonIdentifierType>
    <refPersonIdentifier></refPersonIdentifier>
    <referPersonId></referPersonId>
    <refAccountIdentifierType></refAccountIdentifierType>
    <refAccountIdentifier></refAccountIdentifier>
    <referAccountId></referAccountId>
    <referDealIdentifier></referDealIdentifier>
    <referenceDealId></referenceDealId>
    <referenceModelId></referenceModelId>
    <referUsageSw></referUsageSw>
    <referPriceSw></referPriceSw>
    <includeChildHierarchy></includeChildHierarchy>
    <division></division>
  </referenceDetails>
  <dealSimulationDetails>
    <dealfinancialsummarylist>
      <approvalStatus></approvalStatus>
      <originalDealFinanciencialSummary>
        <revenue></revenue>
        <cost></cost>
        <profit></profit>
        <profitabilityPercentage></profitabilityPercentage>
      </originalDealFinanciencialSummary>
      <proposedDealFinanciencialSummary>
        <revenue></revenue>
        <cost></cost>
        <profit></profit>
        <profitabilityPercentage></profitabilityPercentage>
      </proposedDealFinanciencialSummary>
      <recommenedDealFinanciencialSummary>
        <revenue></revenue>
        <profit></profit>
        <profitabilityPercentage></profitabilityPercentage>
    </dealfinancialsummarylist>
  </dealSimulationDetails>

```

```

        </recommendedDealFinancialSummary>
        <profitVariationPercentage></profitVariationPercentage>
    </dealFinancialSummaryList>
    <divisionFinancialSummaryDetails>
        <division></division>
        <approvalStatus></approvalStatus>
        <originalDivisionFinancialSummary>
            <revenue></revenue>
            <cost></cost>
            <profit></profit>
            <profitabilityPercentage></profitabilityPercentage>
        </originalDivisionFinancialSummary>
        <proposedDivisionFinancialSummary>
            <revenue></revenue>
            <cost></cost>
            <profit></profit>
            <profitabilityPercentage></profitabilityPercentage>
        </proposedDivisionFinancialSummary>
        <recommendedDealFinancialSummary>
            <revenue></revenue>
            <profit></profit>
            <profitabilityPercentage></profitabilityPercentage>
        </recommendedDealFinancialSummary>
        <profitVariationPercentage></profitVariationPercentage>
    </divisionFinancialSummaryDetails>
    <productFinancialSummaryDetails>
        <approvalStatus></approvalStatus>
        <product></product>
        <division></division>
        <originalProductFinancialSummary>
            <revenue></revenue>
            <cost></cost>
            <profit></profit>
            <profitabilityPercentage></profitabilityPercentage>
        </originalProductFinancialSummary>
        <proposedProductDivisionFinancialSummary>
            <revenue></revenue>
            <cost></cost>
            <profit></profit>
            <profitabilityPercentage></profitabilityPercentage>
        </proposedProductDivisionFinancialSummary>
        <recommendedDealFinancialSummary>
            <revenue></revenue>
            <profit></profit>
            <profitabilityPercentage></profitabilityPercentage>
        </recommendedDealFinancialSummary>
        <profitVariationPercentage></profitVariationPercentage>
    </productFinancialSummaryDetails>
</dealSimulationDetails>
<hierarchySimulationDetails>
    <hierarchyDetails>
        <entityType></entityType>
        <entityId></entityId>
        <parentEntityId></parentEntityId>
        <status></status>
        <revenueVariation></revenueVariation>
        <proposedRevenue></proposedRevenue>
        <proposedCost></proposedCost>
        <originalRevenue></originalRevenue>
        <originalCost></originalCost>
    </hierarchyDetails>
</hierarchySimulationDetails>
</C1-DealCreationUpdateIWS>

```

Related Topics

For more information on...	See...
Deal view request and response - tags in the XML format	Deal View Request and Response - Tags in the XML Format on page 4032
Sample deal view request and response in the XML format	Sample Deal View Request and Response in the XML Format on page 4047
Sample price item selection view request and response in the XML format	Sample Price Item Selection View Request and Response in the XML Format on page 4068

Deal Creation Request and Response - Tags in the XML Format

Note: We recommend you to refer the topics [Deal Creation Request in the XML Format](#) on page 3976 and [Deal Creation Response in the XML Format](#) on page 3977 in parallel while understanding the below mentioned tags. This will help you to understand how the tags are nested in the XML format.

Before calling the **C1-DealCreationUpdateIWS** business service through an inbound web service, you need to ensure that the deal creation request contains the following tags:

Tag Name	Tag Description	Mandatory (Yes or No)
actionFlag	Used to indicate that you want to create a deal for an entity (i.e. existing person, account, or prospect person) in the system. The valid value is: <ul style="list-style-type: none"> ADD <p>Note: If you do not specify the value in this tag, by default, the system considers it as an ADD action.</p>	Yes
dealDetails	Used to specify basic information about the deal.	Yes
dealEntityDetails	Used to specify basic information about the entity (i.e. existing person, account, or prospect person) for which you want to create a deal.	Yes
personIdentifierType	Used to indicate the identifier type using which the person is created in the system. <p>Note:</p> <p>If you specify the personIdentifier tag, you need to specify the personIdentifierType tag.</p> <p>If you specify the personIdentifier tag and do not specify the personIdentifierType tag, the system will throw an error message indicating that the person identifier type field is missing.</p> <p>If you specify the personIdentifierType tag, you need not specify the personId tag.</p>	Yes (Conditional) <p>Note: This data is required while creating a deal for an existing person i.e. when the value of the dealEntityType tag is set to EPER.</p>
personIdentifier	Used to specify the value for the person identifier type.	Yes (Conditional)

Tag Name	Tag Description	Mandatory (Yes or No)
	<p>Note:</p> <p>If you specify the personIdentifierType tag, you need to specify the personIdentifier tag.</p> <p>If you specify the personIdentifierType tag and do not specify the personIdentifier tag, the system will throw an error message indicating that the person identifier field is missing.</p> <p>If you specify the personIdentifier tag, you need not specify the personId tag.</p>	<p>Note: This data is required while creating a deal for an existing person i.e. when the value of the dealEntityType tag is set to EPER.</p>
personId	<p>Used to specify the existing person for whom you want to create a deal in the system.</p> <p>Note:</p> <p>If you specify the personId tag, you need not specify the personIdentifierType and the personIdentifier tags.</p> <p>If the personId tag is not valid, the system will throw an error message indicating that the person ID is invalid.</p> <p>Based on the specified value in the personId tag, the system fetches the values of the person's division, accessGrp, customerSegment, and customerTier tags.</p>	<p>Yes (Conditional)</p> <p>Note: This data is required while creating a deal for an existing person i.e. when the value of the dealEntityType tag is set to EPER.</p>
accountIdentifierType	<p>Used to indicate the identifier type using which the account is created in the system.</p> <p>Note:</p> <p>If you specify the accountIdentifier tag, you need to specify the accountIdentifierType tag.</p> <p>If you specify the accountIdentifier tag and do not specify the accountIdentifierType tag, the system will throw an error message indicating that the account identifier type field is missing.</p> <p>If you specify the accountIdentifierType tag, you need not specify the accountId tag.</p>	<p>Yes (Conditional)</p> <p>Note: This data is required while creating a deal for an existing account i.e. when the value of the dealEntityType tag is set to EACC.</p>
accountIdentifier	<p>Used to specify the value for the account identifier type.</p>	<p>Yes (Conditional)</p> <p>Note: This data is required while creating a deal for an existing account i.e. when the value of the dealEntityType tag is set to EACC.</p>

Tag Name	Tag Description	Mandatory (Yes or No)
	<p>Note:</p> <p>If you specify the accountIdentifierType tag, you need to specify the accountIdentifier tag.</p> <p>If you specify the accountIdentifierType tag and do not specify the accountIdentifier tag, the system will throw an error message indicating that the account identifier field is missing.</p> <p>If you specify the accountIdentifier tag, you need not specify the accountId tag.</p>	
accountId	<p>Used to specify the existing account for which you want to create a deal in the system.</p> <p>Note:</p> <p>If you specify the accountId tag, you need not specify the accountIdentifierType and the accountIdentifier tags.</p> <p>If the accountId tag is not valid, the system will throw an error message indicating that the account ID is invalid.</p> <p>Based on the specified value in the accountId tag, the system fetches the account's main person ID and further fetches the values of the division, accessGrp, customerSegment, and customerTier tags.</p>	<p>Yes (Conditional)</p> <p>Note: This data is required while creating a deal for an existing account i.e. when the value of the dealEntityType tag is set to EACC.</p>
prsPerIdentifierType	<p>Used to indicate the identifier type using which the prospect person is created in the system.</p> <p>Note:</p> <p>If you specify the prsPerIdentifier tag, you need to specify the prsPerIdentifierType tag.</p> <p>If you specify the prsPerIdentifier tag and do not specify the prsPerIdentifierType tag, the system will throw an error message indicating that the prospect person identifier type field is missing.</p> <p>If you specify the prsPerIdentifierType tag, you need not specify the prospectPersonId tag.</p>	<p>Yes (Conditional)</p> <p>Note: This data is required while creating a deal for a prospect person i.e. when the value of the dealEntityType tag is set to PRSP.</p>
prsPerIdentifier	Used to specify the value for the prospect person identifier type.	Yes (Conditional)

Tag Name	Tag Description	Mandatory (Yes or No)
	<p>Note:</p> <p>If you specify the prsPerIdentifierType tag, you need to specify the prsPerIdentifier tag.</p> <p>If you specify the prsPerIdentifierType tag and do not specify the prsPerIdentifier tag, the system will throw an error message indicating that the prospect person identifier field is missing.</p> <p>If you specify the prsPerIdentifier tag, you need not specify the prospectPersonId tag.</p>	<p>Note: This data is required while creating a deal for a prospect person i.e. when the value of the dealEntityType tag is set to PRSP.</p>
prospectPersonId	<p>Used to specify the prospect person for whom you want to create a deal in the system.</p> <p>Note:</p> <p>If you specify the prospectPersonId tag, you need not specify the prsPerIdentifierType and the prsPerIdentifier tags.</p> <p>If the prospectPersonId tag is not valid, the system will throw an error message indicating that the prospect person ID is invalid.</p> <p>Based on the specified value in the prospectPersonId tag, the system fetches the values of prospect person's division, accessGrp, customerSegment, and customerTier tags.</p>	<p>Yes (Conditional)</p> <p>Note: This data is required while creating a deal for a prospect person i.e. when the value of the dealEntityType tag is set to PRSP.</p>
division	<p>Used to indicate the division to which the entity (i.e. existing person, account, or prospect person) belongs.</p> <p>Note:</p> <p>You must specify a division which is already defined in the system.</p> <p>If you do not specify the division tag while specifying the identifier type and identifier of the entity (i.e. existing customer, account, or prospect customer), the system throws an error message indicating that the division is mandatory when identifier type and identifier is provided.</p>	<p>Yes (Conditional)</p> <p>Note: This data is required while creating a deal for an entity (i.e. existing customer, account, or prospect customer) by specifying the entity's identifier type and identifier.</p>
dealIdentifier	Used to specify the primary identifier using which you want to create the deal in the system.	Yes

Tag Name	Tag Description	Mandatory (Yes or No)
	<p>Note:</p> <p>You should ensure that every deal has a unique deal identifier.</p> <p>An error message appears when you save a deal with a deal identifier which is already used while creating a deal.</p>	
dealEntityType	<p>Used to indicate the type of entity for which you want to create a deal. The valid values are:</p> <ul style="list-style-type: none"> • EPER - Used to indicate that you want to create deal for an existing person. <p>Note:</p> <p>If you specify the dealEntityType tag as EPER, you must specify either the personId tag or the personIdentifierType, personIdentifier, and division tags.</p> <p>If you do not specify the personId tag, the system will validate the combination of the values provided in the personIdentifierType, personIdentifier, and division tags. If the combination is valid, the system will derive the person ID and continue the deal creation process. Whereas, if the combination is invalid, the system will throw an error message indicating that the person is not found.</p> <ul style="list-style-type: none"> • EACC - Used to indicate that you want to create deal for an existing account. 	Yes

Tag Name	Tag Description	Mandatory (Yes or No)
	<p>Note:</p> <p>If you specify the dealEntityType tag as EACC, you must specify either the accountId tag or the accountIdentifierType, accountIdentifier, and division tags.</p> <p>If you do not specify the accountId tag, the system will validate the combination of the values provided in the accountIdentifierType, accountIdentifier, and division tags. If the combination is valid, the system will derive the account's main person ID and continue the deal creation process. Whereas, if the combination is invalid, the system will throw an error message indicating that the account is not found.</p> <ul style="list-style-type: none"> • PRSP - Used to indicate that you want to create deal for a prospect person. <p>Note:</p> <p>If you specify the dealEntityType tag as PRSP, you must specify either the prospectPersonId tag or the prsPerIdentifierType, prsPerIdentifier, and division tags.</p> <p>If you do not specify the prospectPersonId tag, the system will validate the combination of the values provided in the prsPerIdentifierType, prsPerIdentifier, and division tags. If the combination is valid, the system will derive the prospect person ID and continue the deal creation process. Whereas, if the combination is invalid, the system will throw an error message indicating that the prospect person is not found.</p> <p>Note: If you do not specify the value of the dealEntityType tag, the system will throw an error message indicating that the Deal Entity Type Flag field is missing.</p>	
contractedDealFlag	Used to indicate that the change in the price item pricing from the price list does not affect the price item pricing offered in the deal created for the entity (i.e. existing person, account, or prospect person). The valid values are:	Yes

Tag Name	Tag Description	Mandatory (Yes or No)
	<ul style="list-style-type: none"> true false 	
currency	<p>Used to specify the currency in which you want to calculate the deal level, division level, or product level financial summary and profitability of the deal.</p> <p>Note: You can specify only those currencies which are already defined in the system.</p>	Yes
dealTypeCode	<p>Used to specify the deal type using which you want to create the deal in the system.</p> <p>Note:</p> <p>If you specify a value in the dealTypeCode tag, the customer segment, customer tier, and division of the specified deal type is validated against the customerSegment, customerTier, and division tags specified in the deal creation request using the GETDEALTYPE business service.</p> <p>If the deal type is validated successfully, the system will continue the deal creation process. Whereas, if the deal type is invalid, the system will throw an error message indicating that the deal type is invalid.</p>	Yes
startDate	<p>Used to specify the date from when the deal is effective for the entity (i.e. existing person, account, or prospect person).</p> <p>Note: This date is also used as the effective start date for the proposed price list assignment and start date for the proposed product enrollment.</p>	Yes
endDate	<p>Used to specify the date till when the deal is effective for the entity (i.e. existing person, account, or prospect person).</p>	No
simulationTypeFlag	<p>Used to indicate the simulation type using which you want to analyze the cost, revenue, and profitability of the deal. The valid values are:</p> <ul style="list-style-type: none"> CUST ACCT DEAL 	Yes
reviewFrequency	<p>Used to specify the timely monitoring of the deal usage as per the commitments made by the customer. The valid values are:</p>	No

Tag Name	Tag Description	Mandatory (Yes or No)
	<ul style="list-style-type: none"> • 6 - Used to indicate that you want to monitor the deal usage biannually. • 12 - Used to indicate that you want to monitor the deal usage annually. • 24 - Used to indicate that you want to monitor the deal usage in every two years. 	
dealDescription	Used to specify the description for the deal.	No
dealVersionDescription	Used to specify the description for the deal version.	No
dealFrequency	<p>Used to indicate the duration in which you want to simulate the deal for calculating the financial summary and profitability of the deal. The valid values are:</p> <ul style="list-style-type: none"> • 1 - Used to indicate that you want to simulate the deal every month • 3 - Used to indicate that you want to simulate the deal quarterly • 6 - Used to indicate that you want to simulate the deal biannually • 12 - Used to indicate that you want to simulate the deal annually 	Yes
skipReferenceFlag	<p>Used to specify whether you want to use a deal which is already created in the system as a reference for copying the pricing and commitments in the deal or not. The valid values are:</p> <ul style="list-style-type: none"> • true • false <p>Note:</p> <p>If you do not specify a value in the skipReferenceFlag tag, by default, the system considers it as false.</p> <p>If you specify the value in the skipReferenceFlag tag as false, you need to specify the reference deal details. The system will then copy the reference deal details using the C1-ReferePriceVolumeAdd business service.</p>	No
priceSelectionDate	Used to specify the date from when the price lists, pricing assignments, and product enrollments are effective for simulation.	Yes
usagePeriod	Used to indicate the period for which you want to aggregate the deal data to determine the scope of the deal. The valid values are:	Yes

Tag Name	Tag Description	Mandatory (Yes or No)
	<ul style="list-style-type: none"> • 1 - Used to indicate that you want to aggregate the deal data every month • 3 - Used to indicate that you want to aggregate the deal data quarterly • 6 - Used to indicate that you want to aggregate the deal data biannually • 12 - Used to indicate that you want to aggregate the deal data annually 	
includeHierarchyFlag	<p>Used to indicate whether you want to include the child persons, grandchild persons, and their accounts in the customer hierarchy while creating a deal. The valid values are:</p> <ul style="list-style-type: none"> • true • false <p>Note:</p> <p>If you do not specify a value in the includeHierarchyFlag tag, by default, the system considers it as false.</p> <p>You can specify the value in the includeHierarchyFlag tag as true only when the dealEntityType tag is set to EPER and the simulationTypeFlag tag is set to CUST.</p> <p>You cannot specify the value in the includeHierarchyFlag as false when the value in the dealEntityType tag is set to PRSP and the simulationTypeFlag tag is set to CUST. In such case, the system will throw an error message indicating that you must set the include hierarchy flag to true when deal entity type is PRSP and simulation type is CUST.</p>	<p>Yes (Conditional)</p> <p>Note: This data is required while specifying the deal details to create a deal for an existing or prospect person.</p>
templateFlag	<p>Use to indicate whether you want the deal to be used as a template while searching references for other deals. The valid values are:</p> <ul style="list-style-type: none"> • true • false 	No

Tag Name	Tag Description	Mandatory (Yes or No)
	<p>Note:</p> <p>Users who belong to the user group which has the Change access mode provided for the C1-DEALTEMPLATE application service can create the deal templates in the system.</p> <p>If you specify the value in the templateFlag tag as true and you do not belong to the user group which has the Change access mode provided for the C1-DEALTEMPLATE application service, the system will throw an error message indicating that you do not have security rights to create a deal template.</p>	
templateReferenceDetails	<p>Used to specify the template deal details which you want to use for creating a deal for the entity (i.e. existing person, account, or prospect person).</p> <p>Note: Template deal information such as, Deal type, Price Selection Date, End Date, Simulation Type, Currency, Include Hierarchy, Contracted deal, Review Frequency, Deal Frequency, Skip Reference, Usage Period, Deal Description and Deal Version Description are copied when you use a template deal as a reference to create a deal for an entity (i.e. existing person, account, or prospect person).</p>	No
templateDealId	<p>Used to specify the template deal which you want to use for creating a deal for the entity (i.e. existing person, account, or prospect person).</p> <p>Note:</p> <p>If you specify the templateDealId tag, you need not specify the templateDealIdentifier and templateModelId tags.</p> <p>If the specified template deal has multiple versions, the system will throw an error message indicating that multiple deal versions exist for the deal ID in the system. In such case, you need to specify the templateModelId tag of the template deal instead of the templateDealId tag.</p> <p>If the value specified in the templateDealId tag is invalid, the system will throw an error message indicating that the deal template is invalid.</p>	<p>Yes (Conditional)</p> <p>Note: This data is required while specifying the template deal as a reference to create a deal for an entity (i.e. existing person, account, or prospect person).</p>

Tag Name	Tag Description	Mandatory (Yes or No)
templateDealIdentifier	<p>Used to specify the primary identifier using which the template deal is created in the system.</p> <p>Note:</p> <p>If you specify the templateDealIdentifier tag, you need not specify the templateDealId and templateModelId tags.</p> <p>If the specified template deal has multiple versions, the system will throw an error message indicating that multiple deal versions exist for the deal identifier in the system. In such case, you need to specify the templateModelId tag of the template deal instead of the templateDealIdentifier tag.</p> <p>If the value specified in the templateDealIdentifier tag is invalid, the system will throw an error message indicating that the deal template is invalid.</p>	<p>Yes (Conditional)</p> <p>Note: This data is required while specifying the template deal as a reference to create a deal for an entity (i.e. existing person, account, or prospect person).</p>
templateModelId	<p>Used to specify the deal version which you want to use as a template for creating a deal for the entity (i.e. existing person, account, or prospect person).</p> <p>Note:</p> <p>If you specify the templateModelId tag, you need not specify the templateDealId and templateDealIdentifier tags.</p> <p>If the value specified in the templateModelId tag is invalid, the system will throw an error message indicating that the deal template is invalid.</p>	<p>Yes (Conditional)</p> <p>Note: This data is required while specifying the template deal as a reference to create a deal for an entity (i.e. existing person, account, or prospect person).</p>
copyBasicDetailsFlag	<p>Used to indicate whether you want to copy the basic details from the template deal to the deal which you want to create for the entity (i.e. existing person, account, or prospect person). The valid values are:</p> <ul style="list-style-type: none"> • true • false 	<p>Yes (Conditional)</p> <p>Note: This data is required while specifying the template deal as a reference to create a deal for an entity (i.e. existing person, account, or prospect person).</p>

Tag Name	Tag Description	Mandatory (Yes or No)
	<p>Note:</p> <p>If you specify the values in the copyPricingFlag and copyUsageFlag tags as false, you need to specify the value in the copyBasicDetailsFlag as true.</p> <p>Details such as, Deal Information, Deal Products, Deal Terms and Conditions and Deal Characteristics are copied from the template deal when you specify the copyBasicDetailsFlag as true.</p> <p>The Deal Information copied from the template deal gets overridden by the Deal Information specified by the user while creating a deal through the inbound web service.</p>	
copyPricingFlag	<p>Used to indicate whether you want to copy the price list assignments and price assignments from the template deal to the deal which you want to create for the entity (i.e. existing person, account, or prospect person). The valid values are:</p> <ul style="list-style-type: none"> • true • false <p>Note: If you specify the values in the copyBasicDetailsFlag and copyUsageFlag tags as false, you need to specify the value in the copyPricingFlag as true.</p>	<p>Yes (Conditional)</p> <p>Note: This data is required while specifying the template deal as a reference to create a deal for an entity (i.e. existing person, account, or prospect person).</p>
copyUsageFlag	<p>Used to indicate whether you want to copy commitments from the SQI-based billable charges from the template deal to the deal which you want to create for the entity (i.e. existing person, account, or prospect person). The valid values are:</p> <ul style="list-style-type: none"> • true • false <p>Note: If you specify the values in the copyBasicDetailsFlag and copyPricingFlag tags as false, you need to specify the value in the copyUsageFlag as true.</p>	<p>Yes (Conditional)</p> <p>Note: This data is required while specifying the template deal as a reference to create a deal for an entity (i.e. existing person, account, or prospect person).</p>
dealCharacteristics	Used to specify a list of characteristics for the deal.	No

Tag Name	Tag Description	Mandatory (Yes or No)
	<p>Note: If you create a deal using a template deal as a reference, the characteristics specified in the dealCharacteristics tag will be added with the template deal characteristics.</p>	
characteristicType	<p>Used to indicate the characteristic type.</p> <p>Note: You can specify only those characteristic types where the characteristic entity is set to Deal. If the Characteristic Type of the template deal matches with the value specified in the characteristicType tag, the system will override the template deal Characteristic Type.</p>	<p>Yes (Conditional)</p> <p>Note: This data is required while specifying a characteristic for the deal.</p>
effectiveDate	<p>Used to specify the date from when the characteristic is effective for the deal.</p>	<p>Yes (Conditional)</p> <p>Note: This data is required while specifying a characteristic for the deal.</p>
characteristicValue	<p>Used to specify the value for the characteristic type.</p>	<p>Yes (Conditional)</p> <p>Note: This data is required while specifying a characteristic for the deal.</p>
dealTermsAndConditionsDetails	<p>Used to specify a list of terms and conditions which you want to associate with the deal.</p> <p>Note: If you create a deal using a template deal as a reference, the deal terms and conditions specified in the dealTermsAndConditionsDetails tag will be added with the template deal terms and conditions.</p>	No
termsAndConditionsList	<p>Used to specify the terms and conditions of the deal.</p>	No
description	<p>Used to specify the description of the terms and conditions.</p> <p>Note: If the value specified in the description tag is not valid, the system will throw an error message indicating that the terms and conditions is invalid.</p>	<p>Yes (Conditional)</p> <p>Note: This data is required while associating terms and conditions with a deal.</p>
termsAndCondition	<p>Used to specify the term and condition which you want to associate with the deal.</p>	Yes (Conditional)

Tag Name	Tag Description	Mandatory (Yes or No)
	<p>Note: If the value specified in the termsAndCondition tag is not valid, the system will throw an error message indicating that the terms and conditions is invalid.</p>	<p>Note: This data is required while associating terms and conditions with a deal.</p>
termsAndConditionText	Used to specify additional information about the term and condition.	No
adhocTermsAndCondition	Used to specify the adhoc terms and conditions which you want to associate with the deal.	No
productDetailsList	<p>Used to recommend a list of products for the deal.</p> <p>Note: If you create a deal using a template deal as a reference, the deal products specified in the productDetailsList tag will be added with the template deal recommended products.</p>	No
productCode	Used to specify the product which you want to recommend for the deal.	<p>Yes (Conditional)</p> <p>Note: This data is required while recommending a product for the deal.</p>
referenceDetails	Used to specify the details of the reference deal using which you want to create the deal for the entity (i.e. existing person, account, or prospect person).	<p>Yes (Conditional)</p> <p>Note: This data is required while specifying the reference deal to create a deal for an entity (i.e. existing person, account, or prospect person).</p>
referenceTypeFlg	<p>Used to indicate the type of the reference deal using which you want to create the deal for the entity (i.e. existing person, account, or prospect person). The valid values are:</p> <ul style="list-style-type: none"> RPER - Used to indicate that you want to use the deal of a person as a reference to create the deal for the existing person or the prospect person. <p>Note:</p> <p>If you specify the skipReferenceFlag tag as false and the dealEntityType tag as EPER or PRSP, you need to ensure that the referenceTypeFlg tag is set to either RPER or RDEL.</p> <p>If you specify the referenceTypeFlg tag as RPER, you must specify the values in either the referPersonId tag or refPersonIdentifierType, refPersonIdentifier, and division tags.</p>	<p>Yes (Conditional)</p> <p>Note: This data is required while specifying the reference deal to create a deal for an entity (i.e. existing person, account, or prospect person).</p>

Tag Name	Tag Description	Mandatory (Yes or No)
	<ul style="list-style-type: none"> RACC - Used to indicate that you want to use the deal of an account as a reference to create the deal for the existing account. <div data-bbox="634 317 1084 730" style="border: 1px solid black; padding: 5px; margin: 5px 0;"> <p>Note:</p> <p>If you specify the skipReferenceFlag tag as false and the dealEntityType tag as EACC, you need to ensure that the referenceTypeFlg tag is set to either RACC or RDEL.</p> <p>If you specify the referenceTypeFlg tag as RACC, you must specify the values in either the referAccountId tag or refAccountIdentifierType, refAccountIdentifier, and division tags.</p> </div> RDEL - Used to indicate that you want to use an existing deal as a reference to create the deal for the existing person, account or prospect person. <div data-bbox="634 894 1084 1073" style="border: 1px solid black; padding: 5px; margin: 5px 0;"> <p>Note: If you specify the referenceTypeFlg tag as RDEL, you must specify the values in either the referenceDealId, referDealIdentifier, or referenceModelId tag.</p> </div> <div data-bbox="574 1094 1084 1272" style="border: 1px solid black; padding: 5px; margin: 5px 0;"> <p>Note: If you do not specify the value of the referenceTypeFlg tag and the skipReferenceFlag is set as false, the system will throw an error message indicating that the Reference Type Flag field is missing.</p> </div>	
refPersonIdentifierType	<p>Used to specify the identifier type of the person using which the reference deal is created in the system.</p> <div data-bbox="574 1409 1084 1871" style="border: 1px solid black; padding: 5px; margin: 5px 0;"> <p>Note:</p> <p>If you specify the refPersonIdentifier tag, you need to specify the refPersonIdentifierType tag.</p> <p>If you specify the refPersonIdentifier tag and do not specify the refPersonIdentifierType tag, the system will throw an error message indicating that the person identifier type in the reference section is missing.</p> <p>If you specify the refPersonIdentifierType tag, you need not specify the referPersonId tag.</p> </div>	<p>Yes (Conditional)</p> <div data-bbox="1099 1346 1466 1482" style="border: 1px solid black; padding: 5px; margin: 5px 0;"> <p>Note: This data is required while specifying the reference deal to create a deal for an existing or prospect person.</p> </div>

Tag Name	Tag Description	Mandatory (Yes or No)
refPersonIdentifier	<p>Used to specify the value of the reference person identifier type.</p> <p>Note:</p> <p>If you specify the refPersonIdentifierType tag, you need to specify the refPersonIdentifier tag.</p> <p>If you specify the refPersonIdentifierType tag and do not specify the refPersonIdentifier tag, the system will throw an error message indicating that the person identifier in the reference section is missing.</p> <p>If you specify the refPersonIdentifier tag, you need not specify the referPersonId tag.</p>	<p>Yes (Conditional)</p> <p>Note: This data is required while specifying the reference deal to create a deal for an existing or prospect person.</p>
referPersonId	<p>Used to specify the person for whom the reference deal is created.</p> <p>Note:</p> <p>If you specify the referPersonId tag, you need not specify the refPersonIdentifierType and the refPersonIdentifier tags.</p> <p>If the referPersonId tag is not valid, the system will throw an error message indicating that the referred person is invalid.</p> <p>Based on the specified value in the referPersonId tag, the system fetches the reference deal details for the deal creation process.</p>	<p>Yes (Conditional)</p> <p>Note: This data is required while specifying the reference deal to create a deal for an existing or prospect person.</p>
refAccountIdentifierType	<p>Used to specify the identifier type of the account using which the reference deal is created in the system.</p> <p>Note:</p> <p>If you specify the refAccountIdentifier tag, you need to specify the refAccountIdentifierType tag.</p> <p>If you specify the refAccountIdentifier tag and do not specify the refAccountIdentifierType tag, the system will throw an error message indicating that the account identifier type in the reference section is missing.</p> <p>If you specify the refAccountIdentifierType tag, you need not specify the referAccountId tag.</p>	<p>Yes (Conditional)</p> <p>Note: This data is required while specifying the reference deal to create a deal for an existing account.</p>

Tag Name	Tag Description	Mandatory (Yes or No)
refAccountIdentifier	<p>Used to specify the value of the reference account identifier type.</p> <p>Note:</p> <p>If you specify the refAccountIdentifierType tag, you need to specify the refAccountIdentifier tag.</p> <p>If you specify the refAccountIdentifierType tag and do not specify the refAccountIdentifier tag, the system will throw an error message indicating that the account identifier in the reference section is missing.</p> <p>If you specify the refAccountIdentifier tag, you need not specify the referAccountId tag.</p>	<p>Yes (Conditional)</p> <p>Note: This data is required while specifying the reference deal to create a deal for an existing account.</p>
referAccountId	<p>Used to specify the account for which the reference deal is created.</p> <p>Note:</p> <p>If you specify the referAccountId tag, you need not specify the refAccountIdentifierType and the refAccountIdentifier tags.</p> <p>If the referAccountId tag is not valid, the system will throw an error message indicating that the referred account is invalid.</p> <p>Based on the specified value in the referAccountId tag, the system fetches the reference deal details for the deal creation process.</p>	<p>Yes (Conditional)</p> <p>Note: This data is required while specifying the reference deal to create a deal for an existing account.</p>
referDealIdentifier	<p>Used to specify the primary identifier using which the reference deal is created in the system.</p>	<p>Yes (Conditional)</p> <p>Note: This data is required while specifying the reference deal to create a deal for an existing person, account, or a prospect person.</p>

Tag Name	Tag Description	Mandatory (Yes or No)
	<p>Note:</p> <p>If you specify the referDealIdentifier tag, you need not specify the referenceDealId and referenceModelId tags.</p> <p>You need to ensure that the Simulation Type of the reference deal matches with the value specified in the simulationTypeFlag tag of the deal which you are creating. If the value does not match, the system will throw an error message indicating that the system is unable to derive a reference deal using the given deal identifier.</p> <p>Also, you cannot use a deal whose status is Draft, Discarded, Hierarchy Creation Deferred, and Inactive as a reference for creating a deal. If the status of the reference deal is invalid, the system will throw an error message indicating that the system is unable to derive a reference deal using the given deal identifier.</p> <p>If the specified reference deal has multiple versions, the system will throw an error message indicating that multiple deal versions exist for the deal in the system. In such case, you need to specify the referenceModelId tag of the reference deal instead of the referDealIdentifier tag.</p>	
referenceDealId	Used to specify the existing deal which you want to use as a reference.	Yes (Conditional) <div style="border: 1px solid black; padding: 5px; margin-top: 5px;"> <p>Note: This data is required while specifying the reference deal to create a deal for an existing person, account, or a prospect person.</p> </div>

Tag Name	Tag Description	Mandatory (Yes or No)
	<p>Note:</p> <p>If you specify the referenceDealId tag, you need not specify the referDealIdentifier and referenceModelId tags.</p> <p>You need to ensure that the Simulation Type of the reference deal matches with the value specified in the simulationTypeFlag tag of the deal which you are creating. If the value does not match, the system will throw an error message indicating that the system is unable to derive a reference deal using the given deal ID.</p> <p>Also, you cannot use a deal whose status is Draft, Discarded, Hierarchy Creation Deferred, and Inactive as a reference for creating a deal. If the status of the reference deal is invalid, the system will throw an error message indicating that the system is unable to derive a reference deal using the given deal ID.</p> <p>If the specified reference deal has multiple versions, the system will throw an error message indicating that multiple deal versions exist for the deal in the system. In such case, you need to specify the referenceModelId tag of the reference deal instead of the referenceDealId tag.</p>	
referenceModelId	Used to specify the deal version which you want to use as a reference.	Yes (Conditional) <div style="border: 1px solid black; padding: 5px; margin-top: 5px;"> <p>Note: This data is required while specifying the reference deal to create a deal for an existing person, account, or a prospect person.</p> </div>

Tag Name	Tag Description	Mandatory (Yes or No)
	<p>Note:</p> <p>You need to specify the referenceModelId if the reference deal has multiple deal versions.</p> <p>If you specify the referenceModelId tag, you need not specify the referDealIdentifier and referenceDealId tags.</p> <p>You need to ensure that the Simulation Type of the reference deal version matches with the value specified in the simulationTypeFlag tag of the deal which you are creating. If the value does not match, the system will throw an error message indicating that the system is unable to derive a reference deal using the given deal version ID.</p> <p>Also, you cannot use a deal version whose status is Draft, Discarded, Hierarchy Creation Deferred, and Inactive as a reference for creating a deal. If the status of the reference deal version is invalid, the system will throw an error message indicating that the system is unable to derive a reference deal using the given deal version ID.</p>	
referUsageSw	<p>Used to indicate whether you want to copy commitments from the SQL-based billable charges of the reference deal. The valid values are:</p> <ul style="list-style-type: none"> • true • false <p>Note:</p> <p>If you do not specify a value in the referUsageSw tag, by default, the system considers it as false.</p> <p>You should specify values in either referUsageSw or referPriceSw tag or both.</p>	<p>Yes (Conditional)</p> <p>Note: This data is required while specifying the reference deal to create a deal for an existing person, account, or a prospect person.</p>
referPriceSw	<p>Used to indicate whether you want to copy the price list assignments and price assignments of the reference deal. The valid values are:</p> <ul style="list-style-type: none"> • true • false 	<p>Yes (Conditional)</p> <p>Note: This data is required while specifying the reference deal to create a deal for an existing person, account, or a prospect person.</p>

Tag Name	Tag Description	Mandatory (Yes or No)
	<p>Note:</p> <p>If you do not specify a value in the referPriceSw tag, by default, the system considers it as false.</p> <p>You should specify values in either referUsageSw or referPriceSw tag or both.</p>	
includeChildHierarchy	<p>Used to indicate whether you want to include the child persons, grandchild persons, and their accounts of the reference deal while creating the deal for an existing or prospect person. The valid values are:</p> <ul style="list-style-type: none"> • true • false <p>Note:</p> <p>By default, the system considers all child and grandchild persons and their accounts in the customer hierarchy while specifying a reference deal for an existing person irrespective of the values provided in the includeChildHierarchy tag.</p>	<p>Yes (Conditional)</p> <p>Note: This data is required while specifying the reference deal to create a deal for an existing person.</p>
division	<p>Used to specify the division to which the reference person belongs.</p>	<p>Yes (Conditional)</p> <p>Note: This data is required while creating a deal for an entity (i.e. existing customer, account, or prospect customer) by specifying the reference deal identifier type and identifier.</p>

Once the deal is created, all the details of deal are listed in the above mentioned tags along with the following tags:

Tag Name	Tag Description
dealResponse	Displays whether the deal creation request is successfully processed or not.
message	Displays the message generated for the deal response.
dealInformation	Displays the concatenated string of information about the deal separated by a comma (,).
dealId	Displays the identification value of the deal.
modelId	Displays the identification value of the deal version.
customerSegment	Indicates the business component to which the entity (i.e. existing person, account, or prospect person) belongs.
customerTier	Indicates the customer tier of the customer segment to which the entity (i.e. existing person, account, or prospect person) belongs.

Tag Name	Tag Description
division	Indicates the division to which the entity (i.e. existing person, account, or prospect person) belongs.
accessGrp	Indicates the user group who can view and edit the details of the entity (i.e. existing person, account, or prospect person).
dealEntityId	Displays the entity (i.e. existing person, account, or prospect person) for which the deal is created.
createdDate	Displays the date when the deal is created in the system.
status	Displays the current status of the deal.
dealVersionStatus	Displays the current status of the deal version.

Related Topics

For more information on...	See...
Sample deal creation request and response in the XML format	Sample Deal Creation Request and Response in the XML Format on page 4045

Deal Update Request and Response - Tags in the XML Format

Note: We recommend you to refer the topics [Deal Update Request in the XML Format](#) on page 3979 and [Deal Update Response in the XML Format](#) on page 3981 in parallel while understanding the below mentioned tags. This will help you to understand how the tags are nested in the XML format.

Before calling the **C1-DealCreationUpdateIWS** business service through an inbound web service, you need to ensure that the deal update request contains the following tags:

Tag Name	Tag Description	Mandatory (Yes or No)
actionFlag	Used to indicate that you want to create request to update a deal. The valid value is: <ul style="list-style-type: none"> UPD <p>Note: If you do not specify the value in the actionFlag tag, by default, the system considers it as an ADD action. The RM (i.e. Relationship Manager) can update a deal only when it is in the DRAF, PSML, PFAP, SMLD, DSML, or RFAP status.</p>	Yes
dealOperation	Used to specify the operation that you want to perform while updating the deal.	No
operationFlag	Used to specify the operation that you want to perform on the deal while creating the update request. The valid values are: <ul style="list-style-type: none"> APPR ACPT REJC 	Yes (Conditional)

Tag Name	Tag Description	Mandatory (Yes or No)
	<ul style="list-style-type: none">• FNAL• SMLD• SNDP• RETN• PSEL• CRDV• DSCR <div style="border: 1px solid black; padding: 5px; margin-top: 10px;">Note: You cannot specify the operationFlag tag as DSCR if the status of the deal version is FORC, PROR, REJC, FNAL, or ACPT.</div>	

Tag Name	Tag Description	Mandatory (Yes or No)
	<p>Note:</p> <p>If you specify the value of actionFlag tag as UPD and operationFlag tag as SMLD, then, the deal version gets simulate.</p> <p>If you specify the value of actionFlag tag as UPD and operationFlag tag as SNDP, then, the deal version is send for the approval.</p> <p>If you specify the value of actionFlag tag as UPD and operationFlag tag as APPR, then, the deal version is approved or sent to next level in the approval hierarchy.</p> <p>If you specify the value of actionFlag tag as UPD and operationFlag tag as RETN, then, the submitter is requested to resubmit the deal version for the approval.</p> <p>If you specify the value of actionFlag tag as UPD and operationFlag tag as FNAL, then, the deal version gets finalized.</p> <p>If you specify the value of actionFlag tag as UPD and operationFlag tag as ACPT, then, the deal version is accepted.</p> <p>If you specify the value of actionFlag tag as UPD and operationFlag tag as REJC, then, the deal version is rejected.</p> <p>If you specify the value of actionFlag tag as UPD and operationFlag tag as DSCR, then, the deal version is discarded.</p> <p>To select the price item for which you want to inherit, override, or edit pricing and commitments in the deal version you need to set the value of actionFlag tag as UPD and operationFlag tag as PSEL, and includeFlag of price item and pricing parameter as true.</p> <p>If you specify the value of actionFlag tag as UPD and operationFlag tag as APPR, SNDP or RETN, then, the system will check the value of dealIdentifier and dealId.</p> <p>If you specify the value of dealId as blank and specify the value of dealIdentifier then the system will fetch dealId and modelId.</p> <p>If you specify the value of actionFlag tag as UPD and operationFlag tag as FNAL or REJC, then, the system will check value of dealIdentifier and dealId.</p> <p>If you specify the value of dealId as blank and specify the value of dealIdentifier then the system will fetch dealId.</p>	

Tag Name	Tag Description	Mandatory (Yes or No)
dealIdentifier	Used to specify the deal identifier using which you want to update the deal in the system.	Yes (Conditional)
	Note: You cannot update the value specified in the dealIdentifier tag if the status of the deal is PSML .	Note: This data is required if the do not specify value of dealId tag.
dealId	Used to specify the deal for which you want to create the update request.	Yes (Conditional)
		Note: This data is required if the do not specify value of dealIdentifier tag.
modelId	Used to specify the deal version for which you want to create the update request.	Yes (Conditional)
		Note: This data is required if the value of operation flag is APPR and multiple deal version exists in the system.
dealAcceptEffStartDate	Used to specify the date from when the deal is effective for the existing or prospect person or account.	Yes (Conditional)
		Note: This data is required if the value of operationFlag is set to ACPT .
dealAcceptEffEndDate	Used to specify the date till when the deal is effective for the existing or prospect person or account.	Yes (Conditional)
		Note: This data is required if the value of operationFlag is set to ACPT .
comments	Used to specify the information about accepting or rejecting the deal.	Yes (Conditional)
		Note: This data is required if the value of operationFlag is set to REJC .
rejectReasonCode	Used to specify the reason why you want to reject the deal in the system.	Yes (Conditional)
		Note: This data is required if the value of operation flag is set to REJC .
dealVersionDescription	Used to specify the deal version description.	No
dealVersionCreationFlag	Used to indicate the method using which you want to create a new deal version. The valid values are: <ul style="list-style-type: none"> CVOC - Used to indicate that you want to copy the customer hierarchy without the pricing and commitment details from the current deal version to the new deal version. 	No

Tag Name	Tag Description	Mandatory (Yes or No)
	<ul style="list-style-type: none"> CVWC - Used to indicate that you want to copy the customer hierarchy and pricing and commitment details from the current deal version to the new deal version. FLHR - Used to indicate that you want to derive the latest customer hierarchy from the system. <div style="border: 1px solid black; padding: 5px; margin-top: 10px;"> <p>Note:</p> <p>In this case, you will have to select the price items, assign the required price lists to the entities, override or edit the required proposed pricing, and add commitments from scratch in the new deal version.</p> <p>Also, the system will include all the prospect persons and accounts associated with the customer in the customer hierarchy of the deal version.</p> </div>	
priceItemGroupSelection	Used to specify the details of price item group selection.	No
priceItemSelectionList	Used to specify a list of price item selection.	No
priceItemCode	Used to specify the price item code which is associated with the deal that you want to update.	Yes (Conditional)
		Note: This data is required while updating the price item associated with the deal.
priceItemInfo	Used to specify the information of the price item that you want to update.	Yes (Conditional)
		Note: This data is required while updating the price item associated with the deal.
parameterInfo	Used to specify the information of the parameters which are associated with the price item.	Yes (Conditional)
		Note: This data is required while updating the price item associated with the deal.
assignmentLevel	Used to indicate the level at which the price item pricing is defined in the person hierarchy.	Yes (Conditional)
		Note: This data is required while updating the price item associated with the deal.
hierarchyDetails	Used to specify the details of the person hierarchy.	Yes (Conditional)

Tag Name	Tag Description	Mandatory (Yes or No)
		Note: This data is required while updating the price item associated with the deal.
includeFlag	Used to indicate the flag value of the price item pricing. The valid value are: <ul style="list-style-type: none"> true false 	Yes (Conditional) Note: This data is required while updating the price item associated with the deal.
	Note: You have to set the includeFlag of the price item and pricing as true .	
dealDetails	Used to specify the details for a deal.	No
dealEntityDetails	Used to specify the details of the entity for which you want to update the deal.	No
personIdentifierType	Used to indicate the identifier type of the existing person based on which you want to update the deal.	Yes (Conditional) Note: This data is required if you specify the personIdentifier tag.
personIdentifier	Used to specify the existing person identifier.	Yes (Conditional) Note: This data is required if you specify the personIdentifierType tag.
personId	Used to specify the existing person whose deal you want to update.	Yes (Conditional) Note: This data is required if you specify the personIdentifier tag.
accountIdentifierType	Used to indicate the identifier type of the existing person account based on which you want to update the deal.	Yes (Conditional) Note: This data is required if you specify the accountIdentifier tag.
accountIdentifier	Used to specify the existing person account identifier.	Yes (Conditional) Note: This data is required if you specify the accountIdentifierType tag.
accountId	Used to specify the existing person account whose deal you want to update.	Yes (Conditional) Note: This data is required if you do not specify the accountIdentifier tag.
prsPerIdentifierType	Used to indicate the identifier type of the prospect person based on which you want to update the deal.	Yes (Conditional)

Tag Name	Tag Description	Mandatory (Yes or No)
		Note: This data is required if you specify the prsPerIdentifier tag.
prsPerIdentifier	Used to specify the prospect person identifier.	Yes (Conditional) Note: This data is required if you specify the prsPerIdentifierType tag.
prospectPersonId	Used to specify the prospect person whose deal you want to update.	Yes (Conditional) Note: This data is required if you do not specify the prsPerIdentifier tag.
division	Used to indicate the division to which the person belongs.	Yes (Conditional) Note: This data is required if you specify the personIdentifier and personIdentifierType tags.
dealIdentifier	Used to specify the deal identifier for which you want to update the deal.	Yes (Conditional) Note: This data is required if you do not specify the dealId or dealversionId tag.
dealInformation	Used to specify the information about the deal which you want to update for the entity.	Yes
dealId	Used to specify the deal for which you want to create the update request.	Yes (Conditional) Note: This data is required if you do not specify the dealIdentifier or dealversionId tag.
modelId	Used to specify the model for which you want to create the update request.	Yes (Conditional)
dealEntityType	Used to indicate the entity type of the entity (i.e. existing person, account, or prospect person) whose deal details you want to update. The valid values are: <ul style="list-style-type: none"> • EPER - Used to indicate that you want to update deal of an existing person. 	Yes

Tag Name	Tag Description	Mandatory (Yes or No)
	<p>Note:</p> <p>If you specify the dealEntityType tag as EPER, you must specify either the personId tag or the personIdentifierType, personIdentifier, and division tags.</p> <p>If you do not specify the personId tag, the system will validate the combination of the values provided in the personIdentifierType, personIdentifier, and division tags. If the combination is valid, the system will derive the person ID and continue the deal update process. Whereas, if the combination is invalid, the system will throw an error message indicating that the person is not found.</p> <ul style="list-style-type: none"> • EACC - Used to indicate that you want to update deal of an existing account. <p>Note:</p> <p>If you specify the dealEntityType tag as EACC, you must specify either the accountId tag or the accountIdentifierType, accountIdentifier, and division tags.</p> <p>If you do not specify the accountId tag, the system will validate the combination of the values provided in the accountIdentifierType, accountIdentifier, and division tags. If the combination is valid, the system will derive the account's main person ID and continue the deal update process. Whereas, if the combination is invalid, the system will throw an error message indicating that the account is not found.</p> <ul style="list-style-type: none"> • PRSP - Used to indicate that you want to update deal of a prospect person. 	

Tag Name	Tag Description	Mandatory (Yes or No)
	<p>Note:</p> <p>If you specify the dealEntityType tag as PRSP, you must specify either the prospectPersonId tag or the prsPerIdentifierType, prsPerIdentifier, and division tags.</p> <p>If you do not specify the prospectPersonId tag, the system will validate the combination of the values provided in the prsPerIdentifierType, prsPerIdentifier, and division tags. If the combination is valid, the system will derive the prospect person ID and continue the deal update process. Whereas, if the combination is invalid, the system will throw an error message indicating that the prospect person is not found.</p> <p>Note:</p> <p>If you do not specify the value of the dealEntityType tag, the system will throw an error message indicating that the Deal Entity Type Flag field is missing.</p> <p>You cannot update the value specified in the dealEntityType tag if the status of the deal is DRAF.</p>	
customerSegment	<p>Used to specify the business component to which the entity (i.e. the existing person or account, prospect person) belongs.</p> <p>Note: You cannot update the value specified in the customerSegment tag if the status of the deal is DRAF or PSML.</p>	No
customerTier	<p>Used to specify the customer tier of the customer segment to which the entity (i.e. existing person, account, or prospect person) belongs.</p> <p>Note: You cannot update the value specified in the customerTier tag if the status of the deal is DRAF or PSML.</p>	No
division	Used to specify the division to which the entity (i.e. existing person, account, or prospect person) belongs.	No

Tag Name	Tag Description	Mandatory (Yes or No)
	<p>Note:</p> <p>You must specify a division which is already defined in the system.</p> <p>You cannot update the value specified in the division tag if the status of the deal is DRAF or PSML.</p>	
accessGrp	<p>Used to indicate the user group who can view and edit the details of the entity (i.e. existing person, account, or prospect person).</p> <p>Note:</p> <p>The value specified in the accessGrp tag should be associated with the division to which the entity belongs.</p> <p>You cannot update the value specified in the accessGrp tag if the status of the deal is DRAF or PSML.</p>	No
dealEntityId	Used to specify the entity (i.e. existing person, account, or prospect person) whose deal details you want to update.	No
contractedDealFlag	<p>Used to indicate that the change in the price item pricing from the price list does not affect the price item pricing offered in the deal created for the entity (i.e. existing person, account, or prospect person). The valid values are:</p> <ul style="list-style-type: none"> • true • false <p>Note: You cannot update the value specified in the contractedDealFlag tag if the status of the deal is PSML.</p>	No
currency	<p>Used to specify the currency in which you want to calculate the deal level, division level, or product level financial summary and profitability of the deal.</p> <p>Note:</p> <p>You can specify only those currencies which are already defined in the system.</p> <p>You cannot update the value specified in the currency tag if the status of the deal is PSML.</p>	No
dealTypeCode	Used to specify the deal type using which you want to create request to update the deal in the system.	No

Tag Name	Tag Description	Mandatory (Yes or No)
	Note: You cannot update the value specified in the dealTypeCode tag if the status of the deal is PSML .	
startDate	Used to specify the date from when the deal is effective for the entity (i.e. existing person, account, or prospect person). Note: This date is also used as the effective start date for the proposed price list assignment and start date for the proposed product enrollment. You cannot update the value specified in the startDate tag if the status of the deal is PSML .	No
endDate	Used to specify the date till when the deal is effective for the entity (i.e. existing person, account, or prospect person). Note: You cannot update the value specified in the endDate tag if the status of the deal is PSML .	No
simulationTypeFlag	Used to indicate the simulation type using which you want to analyze the cost, revenue, and profitability of the deal. The valid values are: <ul style="list-style-type: none"> • CUST • ACCT • DEAL Note: You cannot update the value specified in the simulationTypeFlag tag if the status of the deal is PSML .	Yes
reviewFrequency	Used to indicate the timely monitoring of the deal usage as per the commitments made by the customer.	No
dealDescription	Used to specify the description for the deal.	No
dealVersionDescription	Used to specify the description for the deal version.	No
dealFrequency	Used to indicate the duration in which you want to simulate the deal for calculating the financial summary and profitability of the deal. <ul style="list-style-type: none"> • Biannually • Monthly • Quarterly 	Yes

Tag Name	Tag Description	Mandatory (Yes or No)
	<ul style="list-style-type: none"> Yearly 	
skipReferenceFlag	<p>Used to indicate whether you want to use a deal which is already created in the system as a reference for copying the pricing and commitments in the deal or not. The valid values are:</p> <ul style="list-style-type: none"> true false <p>Note: By default, the value is set to false.</p>	No
priceSelectionDate	Used to specify the date from when the price lists, pricing assignments, and product enrollments are effective for simulation.	Yes
usagePeriod	<p>Used to indicate the period for which you want to aggregate the deal data to determine the scope of the deal. The valid values are:</p> <ul style="list-style-type: none"> biannually monthly quarterly yearly 	Yes
includeHierarchyFlag	<p>Used to indicate whether you want to include the child persons, grandchild persons, and their accounts in the customer hierarchy while updating the deal. The valid values are:</p> <ul style="list-style-type: none"> true false <p>Note:</p> <p>If the entity is prospect person, then you have specify the value of includeHierarchyFlag to true.</p> <p>If you specify the value of includeHierarchyFlag tag as true and dealEntityType is set as ACCT or DEAL, then, the system will throw an error.</p> <p>If you specify the value of includeHierarchyFlag tag as false and dealEntityType as PRSP, then, the system will throw an error.</p>	Yes (Conditional)
status	<p>Used to indicate the current status of the deal. The valid values are:</p> <ul style="list-style-type: none"> DRAFT PSML 	

Tag Name	Tag Description	Mandatory (Yes or No)
	<ul style="list-style-type: none"> • PFAP • SMLD • DSML • RFAP <p>Note:</p> <p>If you specify the value of the deal status as DRFT, then, you cannot update the details of dealEntityType, customerSegment, customerTier, accessGrp, division, and templatedeal else the system will throw an error.</p> <p>If you specify the value of the deal status as PSML, then, you cannot update the details of startDate, createdDate, contractedDealFlag, dealIdentifier, templateDealId, dealTypeCode, dealEntityCode, status, customerTier, customerSegment, accessGrp, division, currency, SimulationTypeFlag, priceSelectionDate, dealFrequency, usagePeriod, templateFlag, skipReferenceFlag or includeHierarchyFlag else the system will throw an error.</p> <p>If you specify the value of the deal status as PFAP, SMLD, DSML or RFAP then, you cannot update the details of dealInformation and dealCharacteristics.</p> <p>If the deal status is set as DRFT, PSML, PFAP, SMLD, DSML or RFAP then, the termsAndCondition can be updated only one who creates the deal, else the system will throw an error.</p> <p>If the deal is approved, then, you cannot update the dealInformation, dealCharacteristics, termsAndCondition, and dealProduct else the system will throw an error.</p>	
dealVersionStatus	Used to indicate the current status of the deal version (model).	No
templateFlag	<p>Use to indicate whether you want the deal to be used as a template while updating the other deals.</p> <ul style="list-style-type: none"> • true • false <p>Note: The system will check whether the user has access to update the template deal.</p>	Yes (Conditional)

Tag Name	Tag Description	Mandatory (Yes or No)
templateReferenceDetails	Used to specify the details of the template reference of the deal.	No
templateDealId	Used to specify the particular deal whose details you want to use as a template for other deals. Note: If you do not specify the templateDealIdentifier or templateModelId tags, you need to specify the templateDealId tag. If you specify the values of templateDealId , templateDealIdentifier , and templateModelId tags and the value for copyUsageFlag , copyBasicDetailsFlag , and copyPricingFlag tags is set as false , then, the system will throw an error. The value of copyUsageFlag , copyBasicDetailsFlag , or copyPricingFlag tag should be set to true . If you specify templateDealIdentifier or templateDealId tag and there are multiple deal versions then the system will throw an error. If the value of templateDealIdentifier or templateDealId tag is not found in the system then it will throw an error.	Yes (Conditional) Note: This data is required while specifying the template deal.
templateDealIdentifier	Used to specify the deal identifier whose details you want to use as a template for other deals. Note: If you do not specify the templateDealId or templateModelId tag, you need to specify the templateDealIdentifier tag.	Yes (Conditional) Note: This data is required while specifying the template deal.
templateModelId	Used to specify the template deal version whose details you want to use as a template for other deals. Note: If you do not specify the templateDealId or templateDealIdentifier tag, you need to specify the templateModelId tag.	Yes (Conditional) Note: This data is required while specifying the template deal.
copyBasicDetailsFlag	Used to indicate whether you want to use basic details of the deal to update a deal. The valid values are: <ul style="list-style-type: none">• true• false	Yes (Conditional) Note: This data is required while specifying the template deal.

Tag Name	Tag Description	Mandatory (Yes or No)
	Note: If you specify the templateDealId or templateDealIdentifier or templateModelId tags, you need to set the value of the copyBasicDetailsFlag tag.	
copyPricingFlag	Used to indicate whether you want to use pricing details of the deal to update a deal. The valid values are: <ul style="list-style-type: none"> • true • false Note: If you specify the value for templateDealId or templateDealIdentifier or templateModelId tags, you need to set the value of the copyPricingFlag tag.	Yes (Conditional) Note: This data is required while specifying the template deal.
copyUsageFlag	Used to indicate whether you want to use usage details of the deal to update a deal. The valid values are: <ul style="list-style-type: none"> • true • false Note: If you specify the value for templateDealId or templateDealIdentifier or templateModelId tags, you need to set the value of the copyUsageFlag tag. If the templateDealId , templateDealIdentifier , and templateModelId is entered with copyUsageFlag value as true , then system will copy the dealinformation , dealproducts , dealTermsAndConditionsDetails , and dealCharacteristics from the deal. If you specify the value for dealinformation tag, then, it overrides the value of the template dealinformation . If you specify the value for dealCharacteristics , dealTermsAndConditionsDetails , and dealproducts , then, it will add the value along with template dealCharacteristics , dealTermsAndConditionsDetails , and dealproducts .	Yes (Conditional) Note: This data is required while specifying the template deal.
dealCharacteristics	Used to specify a list of characteristics of the deal.	No
characteristicType	Used to indicate the characteristic type.	Yes (Conditional)

Tag Name	Tag Description	Mandatory (Yes or No)
		Note: This data is required while defining a characteristic for the deal.
effectiveDate	Used to specify the date from when the characteristic is effective for the deal.	Yes (Conditional) Note: This data is required while defining a characteristic for the deal.
characteristicValue	Used to specify the value for the characteristic type.	Yes (Conditional) Note: This data is required while defining a characteristic for the deal.
dealTermsAndConditionsDetails	Used to specify the details of the terms and conditions of the deal.	No
termsAndConditionsList	Used to specify a list of the terms and conditions of the deal.	No
description	Used to specify the description of the terms and conditions of the deal.	No
termsAndCondition	Used to indicate the terms and conditions which you want to associate with the deal. Note: If you do not specify the value in the termsAndCondition tag, then, the system will throw an error.	Yes (Conditional) Note: This field is required while associating terms and conditions with a deal.
termsAndConditionText	Used to specify the description of terms and conditions for the deal.	Yes (Conditional) Note: This field is required while associating terms and conditions with a deal.
adhocTermsAndCondition	Used to indicate the adhoc terms and conditions which you want to associate with the deal.	No
productDetailsList	Used to specify a list of product details of the deal.	No
productCode	Used to specify the product code.	No
referenceDetails	Used to specify the details of the deal that you want to use as reference to update the deal.	No
referenceTypeFlg	Used to indicate the reference type of the deal that you want to use as reference to update the deal for the entity. The valid value is: <ul style="list-style-type: none"> • RPER • RACC • RDEL 	Yes (Conditional) Note: This data is required while specifying the reference deal.

Tag Name	Tag Description	Mandatory (Yes or No)
	Note: If you specify the value in the skipReferenceFlag as false , then, you need to specify the value in the referenceTypeFlg tag.	
refPersonIdentifierType	Used to specify the reference person identifier type based on which you want to update the deal for the entity. Note: If you specify the value in the referenceTypeFlg tag as RPER , then, you need to specify the refPersonIdentifierType tag.	Yes (Conditional) Note: This data is required while specifying the reference deal of the person.
refPersonIdentifier	Used to specify the value of the reference person identifier type. Note: If you specify the value in the referenceTypeFlg tag as RPER , then, you need to specify the refPersonIdentifier tag.	Yes (Conditional) Note: This data is required while specifying the reference deal of the person.
referPersonId	Used to specify the reference person using which you want to update the deal. Note: If you specify the value in the referenceTypeFlg tag as RPER , then, you need to specify the referPersonId tag.	Yes (Conditional) Note: This data is required while specifying the reference deal of the person.
refAccountIdentifierType	Used to specify the reference account identifier type based on which you want to update the deal for the entity. Note: If you specify the value in the referenceTypeFlg tag as RACC , then, you need to specify the refAccountIdentifierType tag.	Yes (Conditional) Note: This data is required while specifying the reference deal of the person account.
refAccountIdentifier	Used to specify the value of the reference account identifier type. Note: If you specify the value in the referenceTypeFlg tag as RACC , then, you need to specify the refAccountIdentifier tag.	Yes (Conditional) Note: This data is required while specifying the reference deal of the person account.
referAccountId	Used to specify the reference account using which you want to update the deal. Note: If you specify the value in the referenceTypeFlg tag as RACC , then, you need to specify the referAccountId tag.	Yes (Conditional) Note: This data is required while specifying the reference deal of the person account.
referDealIdentifier	Used to specify the value of the reference deal identifier type.	Yes (Conditional)

Tag Name	Tag Description	Mandatory (Yes or No)
	<p>Note: If you specify the value in the referenceTypeFlg tag as RDEL, then, you need to specify the referDealIdentifier tag.</p>	<p>Note: This data is required while specifying the reference deal.</p>
referenceDealId	<p>Used to specify the reference deal using which you want to update the deal.</p> <p>Note: If you specify the value in the referenceTypeFlg tag as RDEL, then, you need to specify the referenceDealId tag. If you do not specify the value in the referenceDealId, referDealIdentifier, and referenceModelId tags, then, the system will throw an error. If you specify the values in the referenceDealId, referDealIdentifier, and referenceModelId tags, then, the system will check whether the values are valid or not.</p>	<p>Yes (Conditional)</p> <p>Note: This data is required while specifying the reference deal.</p>
referenceModelId	<p>Used to specify the reference deal version using which you want to update the deal.</p> <p>Note: If you specify the value in the referenceTypeFlg tag as RDEL, then, you need to specify the referenceModelId tag.</p>	<p>Yes (Conditional)</p> <p>Note: This data is required while specifying the reference deal.</p>
referUsageSw	<p>Used to indicate whether you want to use reference usage details to update the deal.</p> <ul style="list-style-type: none"> • true • false <p>Note: By default, the value is set to false. You need to specify the value of either referUsageSw or referPriceSw as true.</p>	<p>Yes (Conditional)</p> <p>Note: This data is required while specifying the reference deal.</p>
referPriceSw	<p>Used to indicate whether you want to use reference pricing details to update the deal.</p> <ul style="list-style-type: none"> • true • false <p>Note: By default, the value is set to false. You need to specify the value of either referUsageSw or referPriceSw as true.</p>	<p>Yes (Conditional)</p> <p>Note: This data is required while specifying the reference deal.</p>

Tag Name	Tag Description	Mandatory (Yes or No)
includeChildHierarchy	Used to indicate whether you want to add child hierarchy in the deal of the person. <ul style="list-style-type: none"> true false 	Yes (Conditional)
	Note: By default, the value is set to false .	
division		

Once the deal is updated, all the details of deal are listed in the above mentioned tags along with the following:

Tag Name	Tag Description
dealResponse	Indicates whether the deal update request is successfully processed or not.
message	Displays the message of successful deal update.
dealId	Displays the deal ID.
modelId	Displays the model ID.
createdDate	Displays the date when the deal is created.
acceptanceDate	Displays the date when the deal is accepted.
finalizedDate	Displays the date when the deal is finalized.
effectiveStartDate	Displays the date from when the deal is effective.
effectiveEndDate	Displays the date till when the deal is effective.
reviewedDate	Displays the date when the deal is reviewed.
dealSimulationDetails	Displays the simulation details of the deal.
dealfinancialsummarylist	Displays a list of the financial summary at the deal level.
approvalStatus	Indicates the current approval status of the financial summary at the deal level. <ul style="list-style-type: none"> APPR EROR INIT UNAP
originalDealFinancialSummary	Displays the summary of the original financial summary at the deal level.
revenue	Displays the original revenue generated from the price item pricing and price assignments at the deal level.
cost	Displays the original cost calculated at the deal level.
profit	Displays the original profit in deal currency generated from the price item pricing and price assignments at the deal level. It is calculated using the following formula: Profit = Revenue – Cost
profitabilityPercentage	Displays the original profit created in percentage at the deal level from the price item pricing and price assignments. It is calculated using the following formula: Profitability Percentage = (Revenue – Cost)*100/ Revenue

Tag Name	Tag Description
proposedDealFinancialSummary	Displays the summary of the proposed financial at the deal level.
revenue	Displays the proposed revenue generated from the price item pricing and price assignments at the deal level.
cost	Displays the proposed cost calculated at the deal level.
profit	Displays the proposed profit in deal currency generated from the price item pricing and price assignments at the deal level. It is calculated using the following formula: Profit = Revenue – Cost
profitabilityPercentage	Displays the proposed profit created in percentage at the deal level from the price item pricing and price assignments. It is calculated using the following formula: Profitability Percentage= (Revenue – Cost)*100/ Revenue
recommendedDealFinancialSummary	Displays the summary of the recommended financial at the deal level.
revenue	Displays the recommended revenue generated from the price item pricing and price assignments at the deal level.
profit	Displays the recommended profit in deal currency generated from the price item pricing and price assignments at the deal level. It is calculated using the following formula: Profit = Revenue – Cost
profitabilityPercentage	Displays the recommended profit created in percentage at the deal level from the price item pricing and price assignments. It is calculated using the following formula: Profitability Percentage = (Revenue – Cost)*100/ Revenue
profitVariationPercentage	Displays the difference between the original profit and proposed profit in percentage at the recommend deal level from the price item pricing and price assignments.
divisionFinancialSummaryDetails	Displays the summary details of the financial at the division level.
division	Displays the division associated with the deal.
approvalStatus	Indicates the current approval status of the financial summary at the division level. <ul style="list-style-type: none"> • APPR • EROR • INIT • UNAP
originalDivisionFinancialSummary	Displays the summary of the original financial at the division level.
revenue	Displays the original revenue generated from the price item pricing and price assignments at the division level.
cost	Displays the original cost calculated at the division level.
profit	Displays the original profit in deal currency generated from the price item pricing and price assignments at the division level. It is calculated using the following formula: Profit = Revenue – Cost

Tag Name	Tag Description
profitabilityPercentage	Displays the original profit created in percentage at the division level from the price item pricing and price assignments. It is calculated using the following formula: Profitability Percentage = (Revenue – Cost)*100/ Revenue
proposedDivisionFinancialSummary	Displays the summary of the proposed financial at the division level.
revenue	Displays the proposed revenue generated from the price item pricing and price assignments at the division level.
cost	Displays the proposed cost calculated at the proposed level.
profit	Displays the proposed profit in deal currency generated from the price item pricing and price assignments at the division level. It is calculated using the following formula: Profit = Revenue – Cost
profitabilityPercentage	Displays the proposed profit created in percentage at the division level from the price item pricing and price assignments. It is calculated using the following formula: Profitability Percentage = (Revenue – Cost)*100/ Revenue
recommendedDealFinancialSummary	Displays the summary of the recommended financial at the deal level.
revenue	Displays the recommended revenue generated from the price item pricing and price assignments at the deal level.
cost	Displays the recommended cost calculated at the deal level.
profit	Displays the recommended profit in deal currency generated from the price item pricing and price assignments at the deal level. It is calculated using the following formula: Profit = Revenue – Cost
profitabilityPercentage	Displays the recommended profit created in percentage at the deal level from the price item pricing and price assignments. It is calculated using the following formula: Profitability Percentage= (Revenue – Cost)*100/ Revenue
profitVariationPercentage	Displays the difference between the recommended profit and proposed profit in percentage. at the division level from the price item pricing and price assignments.
productFinancialSummaryDetails	Displays the summary details of the financial at the product level.
approvalStatus	Indicates the current approval status of the financial summary at the product level. <ul style="list-style-type: none"> • APPR • EROR • INIT • UNAP
product	Displays the product.
division	Indicates the division for which the product financial summary is displayed.
originalProductFinancialSummary	Displays the summary of the original financial at the product level.

Tag Name	Tag Description
revenue	Displays the original revenue generated from the price item pricing and price assignments at the product level.
cost	Displays the original cost calculated at the product level.
profit	Displays the original profit in deal currency generated from the price item pricing and price assignments at the product level. It is calculated using the following formula: Profit = Revenue – Cost
profitabilityPercentage	Displays the original profit created in percentage at the product level from the price item pricing and price assignments. It is calculated using the following formula: Profitability Percentage = (Revenue – Cost)*100/ Revenue
proposedProductDivisionFinancialSummary	Displays the summary of the financial at the proposed product division level.
revenue	Displays the revenue generated from the price item pricing and price assignments at the proposed product division level.
cost	Displays the cost calculated at the proposed product division level.
profit	Displays the profit in deal currency generated from the price item pricing and price assignments at the proposed product division level. It is calculated using the following formula: Profit = Revenue – Cost
profitabilityPercentage	Displays the profit created in percentage at the proposed product division level from the price item pricing and price assignments. It is calculated using the following formula: Profitability Percentage= (Revenue – Cost)*100/ Revenue
recommendedDealFinancialSummary	Displays the summary of the financial at the recommend deal level.
revenue	Displays the revenue generated from the price item pricing and price assignments at the recommend deal level.
cost	Displays the cost calculated at the recommend deal level.
profit	Displays the profit in deal currency generated from the price item pricing and price assignments at the recommend deal division level. It is calculated using the following formula: Profit = Revenue – Cost
profitabilityPercentage	Displays the profit created in percentage at the recommend deal level from the price item pricing and price assignments. It is calculated using the following formula: Profitability Percentage= (Revenue – Cost)*100/ Revenue
profitVariationPercentage	Displays the difference between the original profit and proposed profit in percentage. at the recommend deal level from the price item pricing and price assignments.
hierarchySimulationDetails	Displays the details of the hierarchy simulation.
entityType	Displays the entity type.
entityId	Displays the entity Id of the child.

Tag Name	Tag Description
parentEntityId	Displays the entity Id of the parent.
status	Indicates the status of the deal.
revenueVariation	Displays the average revenue generated from a person or account.
proposedRevenue	Displays the revenue generated from the proposed price item pricing and commitments.
proposedCost	Displays the overall cost of the proposed price item based on the usage.
originalRevenue	Displays the revenue generated through the original price item pricing and commitments.
originalCost	Displays the overall cost of the original price item based on the usage.

Related Topics

For more information on...	See...
Sample deal update request and response in the XML format	Sample Deal Update Request and Response in the XML Format on page 4049
Sample deal version creation request and response in the XML format	Sample Deal Version Creation Request and Response in the XML Format on page 4051
Sample deal simulation request and response in the XML format	Sample Deal Simulation Request and Response in the XML Format on page 4052
Sample deal submission for approval request and response in the XML format	Sample Deal Submission for Approval Request and Response in the XML Format on page 4056
Sample deal approval request and response in the XML format	Sample Deal Approval Request and Response in the XML Format on page 4058
Sample deal return to submitter request and response in the XML format	Sample Deal Return to Submitter Request and Response in the XML Format on page 4060
Sample deal finalization request and response in the XML format	Sample Deal Finalization Request and Response in the XML Format on page 4061
Sample deal acceptance request and response in the XML format	Sample Deal Acceptance Request and Response in the XML Format on page 4063
Sample deal rejection request and response in the XML format	Sample Deal Rejection Request and Response in the XML Format on page 4064
Sample deal discard request and response in the XML format	Sample Deal Discard Request and Response in the XML Format on page 4067
Sample price item selection request and response in the XML format	Sample Price Item Selection Request and Response in the XML Format on page 4070

Deal View Request and Response - Tags in the XML Format

Note: We recommend you to refer the topics [Deal View Request in the XML Format](#) on page 3985 and [Deal View Response in the XML Format](#) on page 3985 in parallel while understanding the below mentioned tags. This will help you to understand how the tags are nested in the XML format.

Before calling the **C1-DealCreationUpdateIWS** business service through an inbound web service, you need to ensure that the deal view request contains the following tags:

Tag Name	Tag Description	Mandatory (Yes or No)
actionFlag	Used to indicate that you want to create request to view the deal details of an entity (i.e. existing person, account, or prospect person). The valid value is: <ul style="list-style-type: none"> • READ 	Yes
	Note: If you do not specify the value in this tag, by default, the system considers it as an ADD action.	
dealOperation	Used to specify the operation that you want to perform while viewing the deal details.	No
	Note: You need to specify the dealOperation tag only when you want to view the price items using which the deal is simulated.	
operationFlag	Used to indicate that you want to create request to view the price items offered in the deal. The valid value is: <ul style="list-style-type: none"> • PSEL 	Yes (Conditional)
		Note: This data is required for viewing the price items offered in the deal.
dealIdentifier	Used to specify the primary identifier using which the deal is created in the system.	Yes (Conditional)
	Note: If you specify the dealIdentifier tag, you need not specify the dealId or the modelId tags. If the deal has multiple versions, then, you should specify the modelId tag instead of the dealIdentifier tag.	Note: This data is required for viewing the price items offered in the deal.
dealId	Used to specify the deal whose price items you want to view.	Yes (Conditional)
	Note: If you specify the dealId tag, you need not specify the dealIdentifier or the modelId tags. If the deal has multiple versions, then, you should specify the modelId tag instead of the dealId tag.	Note: This data is required for viewing the price items offered in the deal.
modelId	Used to specify the deal version whose price items you want to view.	Yes (Conditional)
	Note: If you specify the modelId tag, you need not specify the dealIdentifier or the dealId tags.	Note: This data is required for viewing the price items offered in the deal.

Tag Name	Tag Description	Mandatory (Yes or No)
dealDetails	Used to specify the details of the deal.	No
	Note: You need to specify the dealDetails tag only when you want to view the deal details other than the price items offered in the deal (i.e. when you do not specify the dealOperation tag).	
dealIdentifier	Used to specify the primary identifier using which the deal is created in the system.	Yes (Conditional)
	Note: If you specify the dealIdentifier tag, you need not specify the dealId or the modelId tags. If the deal has multiple versions, then, you should specify the modelId tag instead of the dealIdentifier tag.	Note: This data is required for viewing the deal details except the price items offered in the deal.
dealId	Used to specify the deal whose details you want to view.	Yes (Conditional)
	Note: If you specify the dealId tag, you need not specify the dealIdentifier or the modelId tags. If the deal has multiple versions, then, you should specify the modelId tag instead of the dealId tag.	Note: This data is required for viewing the deal details except the price items offered in the deal.
modelId	Used to specify the deal version whose details you want to view.	Yes (Conditional)
	Note: If you specify the modelId tag, you need not specify the dealIdentifier or the dealId tags.	Note: This data is required for viewing the deal details except the price items offered in the deal.

Once the deal view request is created, all the details of deal are listed in the above mentioned tags along with the following tags:

Tag Name	Tag Description
dealResponse	Indicates whether the deal view request is successfully processed or not.
message	Displays the message generated for the deal response.
dealAcceptEffStartDate	Displays the date when the deal is accepted in the system.
	Note: The data in this tag appears only when the deal is accepted in the system.
dealAcceptEffEndDate	Displays the date till when you can finalize the deal in the system.

Tag Name	Tag Description
	Note: The data in this tag appears only when the deal is accepted in the system and awaiting finalization.
comments	Displays information about deal acceptance or rejection.
rejectReasonCode	Displays the reason why the deal is rejected in the system.
dealVersionDescription	Displays description of the deal version created for the deal.
dealVersionCreationFlag	Indicates the information using which the deal version is created. The valid values are: <ul style="list-style-type: none"> • CVOC - Indicates that the deal version is created without copying the changes done in the current deal. • CVWC - Indicates that the deal version is created by copying the changes done in the current deal. • FLHR - Indicates that the deal version is created by using the latest hierarchy of the entity from the system for which the current deal is created.
priceItemGroupSelection	Displays the list of price items offered in the deal. <p>Note: The data in this tag appears only when you are viewing the price items offered in the deal (i.e. when the value in the operationFlag tag is set to PSEL).</p>
priceItemSelectionList	Displays information about the price item offered in the deal. <p>Note: The data in this tag appears only when you are viewing the price items offered in the deal (i.e. when the value in the operationFlag tag is set to PSEL).</p>
priceItemCode	Displays the price item. <p>Note: The data in this tag appears only when you are viewing the price items offered in the deal (i.e. when the value in the operationFlag tag is set to PSEL).</p>
priceItemInfo	Displays the concatenated string of information about the price item. <p>Note: The data in this tag appears only when you are viewing the price items offered in the deal (i.e. when the value in the operationFlag tag is set to PSEL).</p>
parameterInfo	Displays the parameters using which the pricing is defined for the price item. <p>Note: The data in this tag appears only when you are viewing the price items offered in the deal (i.e. when the value in the operationFlag tag is set to PSEL).</p>
assignmentLevel	Indicates the level at which the price item pricing is defined in the entity (i.e. exiting person, account, or prospect person) hierarchy. The valid values are: <ul style="list-style-type: none"> • Account Agreed - Indicates price item pricing is agreed for the account. • Account Price List - Indicates price item pricing is defined in the price list which is assigned to the account. • Account Inherited Price List - Indicates price item pricing is inherited from the parent price list hierarchy defined for the price list which is assigned to the account.

Tag Name	Tag Description
	<ul style="list-style-type: none"> • Customer Agreed - Indicates price item pricing is agreed for the main customer in the customer hierarchy. • Customer Price List - Indicates price item pricing is defined in the price list which is assigned to the main customer. • Default Price List - Indicates price item pricing defined in the price list is available in the default price list. • Global Price List - Indicates price item pricing defined in the price list is available in the global price list. • Customer Inherited Price List - Indicates price item pricing is inherited from the parent price list hierarchy defined for the price list which is assigned to the main customer. • Parent Customer Agreed - Indicates price item pricing is agreed for the parent customer in the customer hierarchy. • Parent Customer Price List - Indicates price item pricing is defined in the price list which is assigned to the parent customer. • Parent Customer Inherited Price List - Indicates price item pricing is inherited from the parent price list hierarchy defined for the price list which is assigned to the parent customer. • Product Default Price List - Indicates product defined in the price list is available in the default price list. <p>Note: The data in this tag appears only when you are viewing the price items offered in the deal (i.e. when the value in the operationFlag tag is set to PSEL).</p>
hierarchyDetails	<p>Displays the root level and/or non-root level hierarchy entities to which the price item belongs.</p> <p>Note: The data in this tag appears only when you are viewing the price items offered in the deal (i.e. when the value in the operationFlag tag is set to PSEL).</p>
includeFlag	<p>Indicates whether the price item is included in the deal for simulation. The valid values are:</p> <ul style="list-style-type: none"> • true • false <p>Note: The data in this tag appears only when you are viewing the price items offered in the deal (i.e. when the value in the operationFlag tag is set to PSEL).</p>
dealEntityDetails	<p>Displays basic information about the entity (i.e. existing person, account, or prospect person) for which the deal is created in the system.</p>
personIdentifierType	<p>Indicates the identifier type using which the person is created in the system.</p> <p>Note: The value in this tag appears only when the value specified in the dealEntityType tag is EPER.</p>
personIdentifier	<p>Displays the value of the person identifier type.</p>

Tag Name	Tag Description
	Note: The value in this tag appears only when the value specified in the dealEntityType tag is EPER .
personId	Displays the existing person for whom the deal is created in the system. Note: The value in this tag appears only when the value specified in the dealEntityType tag is EPER .
accountIdentifierType	Indicates the identifier type using which the account is created in the system. Note: The value in this tag appears only when the value specified in the dealEntityType tag is EACC .
accountIdentifier	Displays the value of the account identifier type. Note: The value in this tag appears only when the value specified in the dealEntityType tag is EACC .
accountId	Displays the existing account for which the deal is created in the system. Note: The value in this tag appears only when the value specified in the dealEntityType tag is EACC .
prsPerIdentifierType	Indicates the identifier type using which the prospect person is created in the system. Note: The value in this tag appears only when the value specified in the dealEntityType tag is PRSP .
prsPerIdentifier	Displays the value of the prospect person identifier type. Note: The value in this tag appears only when the value specified in the dealEntityType tag is PRSP .
prospectPersonId	Displays the prospect person for whom the deal is created in the system. Note: The value in this tag appears only when the value specified in the dealEntityType tag is PRSP .
division	Indicates the division to which the entity (i.e. existing person, account, or prospect person) belongs.
dealInformation	Displays the concatenated string of information about the deal separated by a comma (,).
modelId	Displays the identification value of the deal version.
dealEntityType	Indicates the type of entity for which the deal is created in the system. The valid values are: <ul style="list-style-type: none"> • EPER - Indicates that the deal is created for an existing person. • EACC - Indicates that the deal is created for an existing account. • PRSP - Indicates that the deal is created for a prospect person.
customerSegment	Indicates the business component to which the entity (i.e. existing person, account, or prospect person) belongs.

Tag Name	Tag Description
customerTier	Indicates the customer tier of the customer segment to which the entity (i.e. existing person, account, or prospect person) belongs.
division	Indicates the division to which the entity (i.e. existing person, account, or prospect person) belongs.
accessGrp	Indicates the user group who can view and edit the details of the entity (i.e. existing person, account, or prospect person).
contractedDealFlag	Indicates whether the change in the price item pricing from the price list affects the price item pricing offered in the deal created for the entity (i.e. existing person, account, or prospect person) or not. The valid values are: <ul style="list-style-type: none"> • true • false
currency	Indicates the currency in which you want to calculate the deal level, division level, or product level financial summary and profitability of the deal.
dealTypeCode	Indicates the deal type using which the deal is created in the system.
startDate	Displays the date from when the deal is effective for the entity (i.e. existing person, account, or prospect person).
endDate	Displays the date till when the deal is effective for the entity (i.e. existing person, account, or prospect person).
simulationTypeFlag	Indicates the simulation type using which you want to analyze the cost, revenue, and profitability of the deal. The valid values are: <ul style="list-style-type: none"> • CUST • ACCT • DEAL
reviewFrequency	Indicates the timely monitoring of the deal usage as per the commitments made by the customer. The valid values are: <ul style="list-style-type: none"> • 6 - Used to indicate that you want to monitor the deal usage biannually. • 12 - Used to indicate that you want to monitor the deal usage annually. • 24 - Used to indicate that you want to monitor the deal usage in every two years.
dealDescription	Displays the description for the deal.
dealVersionDescription	Displays the description for the deal version.
dealFrequency	Indicates the duration in which you want to simulate the deal for calculating the financial summary and profitability of the deal. The valid values are: <ul style="list-style-type: none"> • 1 - Used to indicate that you want to simulate the deal every month • 3 - Used to indicate that you want to simulate the deal quarterly • 6 - Used to indicate that you want to simulate the deal biannually • 12 - Used to indicate that you want to simulate the deal annually
skipReferenceFlag	Indicates whether the deal is created by referring the pricing and commitments of a deal which is already created in the system. The valid values are:

Tag Name	Tag Description
	<ul style="list-style-type: none"> • true • false
priceSelectionDate	Displays the date from when the price lists, pricing assignments, and product enrollments are effective for simulation.
usagePeriod	<p>Indicates the period for which you want to aggregate the deal data to determine the scope of the deal. The valid values are:</p> <ul style="list-style-type: none"> • 1 - Used to indicate that you want to aggregate the deal data every month • 3 - Used to indicate that you want to aggregate the deal data quarterly • 6 - Used to indicate that you want to aggregate the deal data biannually • 12 - Used to indicate that you want to aggregate the deal data annually
includeHierarchyFlag	<p>Indicates whether the child persons, grandchild persons, and their accounts in the customer hierarchy are included in the deal or not. The valid values are:</p> <ul style="list-style-type: none"> • true • false
templateFlag	<p>Indicates whether the deal is used as a template while searching references for other deals. The valid values are:</p> <ul style="list-style-type: none"> • true • false
templateReferenceDetails	Displays the details of the template deal which is used as a reference for creating the deal.
templateDealId	Displays the particular template deal which is used for creating the deal.
templateDealIdentifier	Displays the primary identifier using which the template deal is created in the system.
templateModelId	Displays the particular template deal version which is used for creating the deal.
copyBasicDetailsFlag	<p>Indicates whether the basic details from the template deal are copied to create the deal or not. The valid values are:</p> <ul style="list-style-type: none"> • true • false
copyPricingFlag	<p>Indicates whether the price list assignments and price assignments from the template deal are copied to create the deal or not. The valid values are:</p> <ul style="list-style-type: none"> • true • false
copyUsageFlag	<p>Indicates whether the commitments from the SQI-based billable charges from the template deal are copied to create the deal or not. The valid values are:</p> <ul style="list-style-type: none"> • true • false
dealCharacteristics	Displays the list of characteristics of the deal.
characteristicType	Indicates the characteristic type.

Tag Name	Tag Description
effectiveDate	Displays the date from when the characteristic is effective for the deal.
characteristicValue	Displays the value of the characteristic type.
dealTermsAndConditionsDetails	Displays the list of terms and conditions that are associated with the deal.
termsAndConditionsList	Displays the terms and conditions of the deal.
description	Displays the description of the terms and conditions.
termsAndCondition	Indicates the term and condition which is associated with the deal.
termsAndConditionText	Displays additional information about the term and condition.
adhocTermsAndCondition	Displays the adhoc terms and conditions associated with the deal.
productDetailsList	Displays the list of products recommended for the deal.
productCode	Displays the product which is recommended for the deal.
referenceDetails	Displays the details of the reference deal using which the deal is created in the system.
referenceTypeFlg	<p>Indicates the type of the reference deal using which the deal is created in the system. The valid values are:</p> <ul style="list-style-type: none"> • RPER - Indicates that the deal is created by using the deal of an existing person as a reference. • RACC - Indicates that the deal is created by using the deal of an existing account as a reference. • RDEL - Indicates that the deal is created by using an existing deal as a reference.
refPersonIdentifierType	<p>Displays the identifier type of the person using which the reference deal is created in the system.</p> <p>Note: The value in this tag appears only when the value specified in the referenceTypeFlg tag is RPER.</p>
refPersonIdentifier	<p>Displays the value of the reference person identifier type.</p> <p>Note: The value in this tag appears only when the value specified in the referenceTypeFlg tag is RPER.</p>
referPersonId	<p>Displays the person for whom the reference deal is created.</p> <p>Note: The value in this tag appears only when the value specified in the referenceTypeFlg tag is RPER.</p>
refAccountIdentifierType	<p>Displays the identifier type of the account using which the reference deal is created in the system.</p> <p>Note: The value in this tag appears only when the value specified in the referenceTypeFlg tag is RACC.</p>
refAccountIdentifier	<p>Displays the value of the reference account identifier type.</p> <p>Note: The value in this tag appears only when the value specified in the referenceTypeFlg tag is RACC.</p>

Tag Name	Tag Description
referAccountId	<p>Display the account for which the reference deal is created.</p> <p>Note: The value in this tag appears only when the value specified in the referenceTypeFlg tag is RACC.</p>
referDealIdentifier	<p>Displays the primary identifier using which the reference deal is created in the system.</p> <p>Note: The value in this tag appears only when the value specified in the referenceTypeFlg tag is RDEL.</p>
referenceDealId	<p>Displays the existing deal which is used as a reference to create the deal.</p> <p>Note: The value in this tag appears only when the value specified in the referenceTypeFlg tag is RDEL.</p>
referenceModelId	<p>Displays the existing deal version which is used as a reference to create the deal.</p> <p>Note: The value in this tag appears only when the value specified in the referenceTypeFlg tag is RDEL.</p>
referUsageSw	<p>Indicates whether the commitments from the SQI-based billable charges of the reference deal is copied to create the deal. The valid values are:</p> <ul style="list-style-type: none"> • true • false
referPriceSw	<p>Indicates whether the price list assignments and price assignments of the reference deal is copied to create the deal. The valid values are:</p> <ul style="list-style-type: none"> • true • false
includeChildHierarchy	<p>Indicates whether the child persons, grandchild persons, and their accounts of the reference deal is included while creating the deal. The valid values are:</p> <ul style="list-style-type: none"> • true • false
dealSimulationDetails	<p>Displays the deal level, division level, and product level simulation details of the deal.</p>
dealfinancialsummarylist	<p>Displays information about the financial summary at the deal level.</p>
approvalStatus	<p>Indicates the current approval status of the financial summary at the deal level.</p> <ul style="list-style-type: none"> • APPR • EROR • INIT • UNAP
originalDealFinancialSummary	<p>Displays information about the financial summary at the deal level which is calculated using the original price list assignments and price assignments.</p>

Tag Name	Tag Description
revenue	Displays the revenue generated at the deal level from the original price list assignments and price assignments.
cost	Displays the cost calculated at the deal level from the original price list assignments and price assignments.
profit	Displays the profit in deal currency generated from the original price list assignments and price assignments at the deal level.
profitabilityPercentage	Displays the profit generated in percentage (%) from the original price list assignments and price assignments at the deal level.
proposedDealFinancialSummary	Displays information about the financial summary at the deal level which is calculated using the proposed price list assignments and price assignments.
revenue	Displays the revenue generated at the deal level from the proposed price list assignments and price assignments.
cost	Displays the cost calculated at the deal level from the proposed price list assignments and price assignments.
profit	Displays the profit in deal currency generated from the proposed price list assignments and price assignments at the deal level.
profitabilityPercentage	Displays the profit generated in percentage (%) from the proposed price list assignments and price assignments at the deal level.
recommendedDealFinancialSummary	Displays information about the financial summary at the deal level which is calculated using the recommended price list assignments and price assignments.
revenue	Displays the revenue generated at the deal level from the recommended price list assignments and price assignments.
profit	Displays the profit in deal currency generated from the recommended price list assignments and price assignments at the deal level.
profitabilityPercentage	Displays the profit in deal currency generated from the recommended price list assignments and price assignments at the deal level.
profitVariationPercentage	Displays the difference in the original and the proposed profits at the deal level in percentage (%).
divisionFinancialSummaryDetail	Displays information about the financial summary at the division level.
division	Indicates the division for which the financial summary is displayed.
approvalStatus	Indicates the current approval status of the financial summary at the division level. <ul style="list-style-type: none"> • APPR • EROR • INIT • UNAP
originalDivisionFinancialSummary	Displays information about the financial summary at the division level which is calculated using the original price list assignments and price assignments.
revenue	Displays the revenue generated at the division level from the original price list assignments and price assignments.
cost	Displays the cost calculated at the division level from the original price list assignments and price assignments.

Tag Name	Tag Description
profit	Displays the profit in deal currency generated from the original price list assignments and price assignments at the division level.
profitabilityPercentage	Displays the profit generated in percentage (%) from the original price list assignments and price assignments at the division level.
proposedDivisionFinancialSummary	Displays information about the financial summary at the division level which is calculated using the proposed price list assignments and price assignments.
revenue	Displays the revenue generated at the division level from the proposed price list assignments and price assignments.
cost	Displays the cost calculated at the division level from the proposed price list assignments and price assignments.
profit	Displays the profit in deal currency generated from the proposed price list assignments and price assignments at the division level.
profitabilityPercentage	Displays the profit generated in percentage (%) from the proposed price list assignments and price assignments at the division level.
recommendedDealFinancialSummary	Displays information about the financial summary at the division level which is calculated using the recommended price list assignments and price assignments.
revenue	Displays the revenue generated at the division level from the recommended price list assignments and price assignments.
cost	Displays the cost calculated at the division level from the recommended price list assignments and price assignments.
profit	Displays the profit in deal currency generated from the recommended price list assignments and price assignments at the division level.
profitabilityPercentage	Displays the profit generated in percentage (%) from the recommended price list assignments and price assignments at the division level.
profitVariationPercentage	Displays the difference in the original and the proposed profits at the division level in percentage (%).
productFinancialSummaryDetail	Displays information about the financial summary at the product level.
approvalStatus	Indicates the current approval status of the financial summary at the product level. <ul style="list-style-type: none"> • APPR • EROR • INIT • UNAP
product	Indicates the product for which the financial summary is displayed.
division	Indicates the division for which the product financial summary is displayed.
originalProductFinancialSummary	Displays information about the financial summary at the product level which is calculated using the original price list assignments and price assignments.
revenue	Displays the revenue generated at the product level from the original price list assignments and price assignments.
cost	Displays the cost calculated at the product level from the original price list assignments and price assignments.

Tag Name	Tag Description
profit	Displays the profit in deal currency generated from the original price list assignments and price assignments at the product level.
profitabilityPercentage	Displays the profit generated in percentage (%) from the original price list assignments and price assignments at the product level.
proposedProductDivisionFinancialSummary	Displays information about the financial summary at the product level which is calculated using the proposed price list assignments and price assignments for a particular division.
revenue	Displays the revenue generated at the product level from the proposed price list assignments and price assignments.
cost	Displays the cost calculated at the product level from the proposed price list assignments and price assignments.
profit	Displays the profit in deal currency generated from the proposed price list assignments and price assignments at the product level.
profitabilityPercentage	Displays the profit generated in percentage (%) from the proposed price list assignments and price assignments at the product level.
recommendedDealFinancialSummary	Displays information about the financial summary at the product level which is calculated using the recommended price list assignments and price assignments.
revenue	Displays the revenue generated at the product level from the recommended price list assignments and price assignments.
cost	Displays the cost calculated at the product level from the recommended price list assignments and price assignments.
profit	Displays the profit in deal currency generated from the recommended price list assignments and price assignments at the product level.
profitabilityPercentage	Displays the profit generated in percentage (%) from the recommended price list assignments and price assignments at the product level.
profitVariationPercentage	Displays the difference in the original and the proposed profits at the product level in percentage (%).
hierarchySimulationDetails	Displays information about the financial summary at the entity level in the customer hierarchy.
entityType	Displays the type of the entity for which the financial summary is displayed.
entityId	Displays the entity (i.e. person or account) in the customer hierarchy for which the financial summary is displayed.
parentEntityId	Displays the parent person to whom the entity (i.e. person or account) belongs in the customer hierarchy.
status	Indicates the approval status of the price assignments for the respective entity (i.e. person or account).
revenueVariation	Displays the difference in the original and the proposed revenues at the entity level in percentage (%).
proposedRevenue	Displays the revenue generated at the entity level from the proposed price list assignments and price assignments.
proposedCost	Displays the cost calculated at the entity level from the proposed price list assignments and price assignments.

Tag Name	Tag Description
originalRevenue	Displays the revenue generated at the entity level from the original price list assignments and price assignments.
originalCost	Displays the cost calculated at the entity level from the proposed price list assignments and price assignments.

Related Topics

For more information on...	See...
Sample deal view request and response in the XML format	Sample Deal View Request and Response in the XML Format on page 4047
Sample price item selection view request and response in the XML format	Sample Price Item Selection View Request and Response in the XML Format on page 4068

Sample Deal Creation Request and Response in the XML Format

Using the below example, you can create the deal for 0074771343 person.

Sample Deal Creation Request in the XML Format

```
<C1-DealCreationUpdateIWS>
  <actionFlag>ADD</actionFlag>
  <dealDetails>
    <dealEntityDetails>
      <personId>0074771343</personId>
    </dealEntityDetails>
    <dealIdentifier>EXISTINGPER1</dealIdentifier>
    <dealEntityType>EPER</dealEntityType>
    <contractedDealFlag>>false</contractedDealFlag>
    <currency>USD</currency>
    <dealTypeCode>APRTESENEW</dealTypeCode>
    <startDate>2022-02-26</startDate>
    <simulationTypeFlag>CUST</simulationTypeFlag>
    <reviewFrequency>6</reviewFrequency>
    <dealDescription>deal descript</dealDescription>
    <dealVersionDescription>version desc</dealVersionDescription>
    <dealFrequency>12</dealFrequency>
    <skipReferenceFlag>>true</skipReferenceFlag>
    <priceSelectionDate>2022-02-22</priceSelectionDate>
    <usagePeriod>12</usagePeriod>
    <includeHierarchyFlag>>true</includeHierarchyFlag>
    <templateFlag>>false</templateFlag>
  </dealDetails>
  <dealCharacteristics>
    <characteristicType>ZZ-DLCHR</characteristicType>
    <effectiveDate>2021-06-01</effectiveDate>
    <characteristicValue>7266725883</characteristicValue>
  </dealCharacteristics>
  <dealTermsAndConditionsDetails>
    <termsAndConditionsList>
      <termsAndCondition>TEST SPE CR</termsAndCondition>
      <termsAndConditionText>new tc</termsAndConditionText>
    </termsAndConditionsList>
    <termsAndConditionsList>
      <termsAndCondition>TEST_TC8</termsAndCondition>
      <termsAndConditionText>Test changedaaaa</termsAndConditionText>
    </termsAndConditionsList>
    <adhocTermsAndCondition>DOCH DESC</adhocTermsAndCondition>
  </dealTermsAndConditionsDetails>
```

```

<productDetailsList>
  <productCode>AUT_MPD1_BUSS1</productCode>
</productDetailsList>
<productDetailsList>
  <productCode>AUT_MPD_930_TECH</productCode>
</productDetailsList>
<productDetailsList>
  <productCode>AUT_MPD_CA_TECH</productCode>
</productDetailsList>
<productDetailsList>
  <productCode>RTEST_BPTECT</productCode>
</productDetailsList>
</C1-DealCreationUpdateIWS>

```

Note: If you do not want to enter the data in the list tags (i.e. tags where the type is set to list), you should not include them in the request. Adding empty list tags will give erroneous results.

Sample Deal Creation Response in the XML Format

```

<C1-DealCreationUpdateIWS>
  <actionFlag>UPD</actionFlag>
  <dealresponse>
    <message>Deal Created Successfully.</message>
  </dealresponse>
  <dealDetails>
    <dealEntityDetails>
      <personId>0074771343</personId>
    </dealEntityDetails>
    <dealIdentifier>EXISTINGPER1</dealIdentifier>
    <dealInformation>8896302706,Prod,Prerana,02-26-2022,United States
    Dollars,Contracted Deal-No,(1),EXISTINGPER1 ,deal descript,930-California
    Branch, , ,Aparna RM only,Pending Simulation,Customer,System Default,Template-
    No,BKADMIN ,02-26-2022, , ,Biannually,Yearly, , , ,Skip Reference-
    Yes,Account,0074771343,Yearly, , ,02-22-2022, ,Skip Questionnaire-Yes, ,Include
    Hierarchy-Yes</dealInformation>
    <dealId>8896302706</dealId>
    <modelId>0662805484</modelId>
    <dealEntityType>EPER</dealEntityType>
    <customerSegment></customerSegment>
    <customerTier></customerTier>
    <division>930</division>
    <accessGrp>***</accessGrp>
    <dealEntityId>0074771343</dealEntityId>
    <contractedDealFlag>>false</contractedDealFlag>
    <currency>USD</currency>
    <dealTypeCode>APRTESENEW</dealTypeCode>
    <startDate>2022-02-26</startDate>
    <simulationTypeFlag>CUST</simulationTypeFlag>
    <reviewFrequency>6</reviewFrequency>
    <dealDescription>deal descript</dealDescription>
    <dealVersionDescription>version desc</dealVersionDescription>
    <dealFrequency>12</dealFrequency>
    <skipReferenceFlag>>true</skipReferenceFlag>
    <priceSelectionDate>2022-02-22</priceSelectionDate>
    <usagePeriod>12</usagePeriod>
    <includeHierarchyFlag>>true</includeHierarchyFlag>
    <status>PSML</status>
    <templateFlag>>false</templateFlag>
  </dealDetails>
  <templateReferenceDetails>
    <copyBasicDetailsFlag>>false</copyBasicDetailsFlag>
    <copyPricingFlag>>false</copyPricingFlag>
    <copyUsageFlag>>false</copyUsageFlag>

```

```

</templateReferenceDetails>
<dealCharacteristics>
  <characteristicType>ZZ-DLCHR</characteristicType>
  <effectiveDate>2021-06-01</effectiveDate>
  <characteristicValue>7266725883</characteristicValue>
</dealCharacteristics>
<dealTermsAndConditionsDetails>
  <termsAndConditionsList>
    <termsAndCondition>TEST SPE CR</termsAndCondition>
    <termsAndConditionText>new tc</termsAndConditionText>
  </termsAndConditionsList>
  <termsAndConditionsList>
    <termsAndCondition>TEST_TC8</termsAndCondition>
    <termsAndConditionText>Test changedaaaa</termsAndConditionText>
  </termsAndConditionsList>
  <adhocTermsAndCondition>DOCH DESC</adhocTermsAndCondition>
</dealTermsAndConditionsDetails>
<productDetailsList>
  <productCode>AUT_MPD1_BUSS1</productCode>
</productDetailsList>
<productDetailsList>
  <productCode>AUT_MPD_930_TECH</productCode>
</productDetailsList>
<productDetailsList>
  <productCode>AUT_MPD_CA_TECH</productCode>
</productDetailsList>
<productDetailsList>
  <productCode>RTEST_BPTECT</productCode>
</productDetailsList>
<referenceDetails>
  <referUsageSw>false</referUsageSw>
  <referPriceSw>false</referPriceSw>
</referenceDetails>
</C1-DealCreationUpdateIWS>

```

Note: We have given the above request and response samples to illustrate how the tags should be nested while sending a deal creation request from the external system. However, you should not seamlessly use this request sample in your environment because the required pre-requisite data may not be available in your environment. In such case, the system will give erroneous results.

Related Topics

For more information on...	See...
Deal creation request and response - tags in the XML format	Deal Creation Request and Response - Tags in the XML Format on page 3989

Sample Deal View Request and Response in the XML Format

Using the below example, you can view the deal 8896302706.

Sample Deal View Request in the XML Format

```

<C1-DealCreationUpdateIWS>
  <actionFlag>READ</actionFlag>
  <dealDetails>
    <dealId>8896302706</dealId>
  </dealDetails>
</C1-DealCreationUpdateIWS>

```

Sample Deal View Response in the XML Format

```

<C1-DealCreationUpdateIWS>

```

```

<actionFlag>READ</actionFlag>
<dealDetails>
  <dealIdentifier>EXISTINGPER1</dealIdentifier>
    <dealInformation>8896302706,Prod,Prerana,02-26-2022,United States
Dollars,Contracted Deal-No,(1),EXISTINGPER1 ,deal descript,930-California
Branch, , ,Aparna RM only,Pending Simulation,Customer,System Default,Template-
No,BKADMIN ,02-26-2022, , ,Biannually,Yearly, , , ,Skip Reference-
Yes,Account,0074771343,Yearly, , ,02-22-2022, ,Skip Questionnaire-Yes, ,Include
Hierarchy-Yes</dealInformation>
  <dealId>8896302706</dealId>
  <modelId>0662805484</modelId>
  <dealEntityType>EPER</dealEntityType>
  <customerSegment>COMM</customerSegment>
  <customerTier>T</customerTier>
  <division>930</division>
  <accessGrp>***</accessGrp>
  <dealEntityId>0074771343</dealEntityId>
  <contractedDealFlag>>false</contractedDealFlag>
  <currency>USD</currency>
  <dealTypeCode>APRTESENEW</dealTypeCode>
  <startDate>2022-02-26</startDate>
  <endDate>2023-03-09</endDate>
  <simulationTypeFlag>CUST</simulationTypeFlag>
  <reviewFrequency>6</reviewFrequency>
  <dealDescription>Deal Description</dealDescription>
  <longDescription>Deal Description</longDescription>
  <dealVersionDescription>Version Description</dealVersionDescription>
  <dealFrequency>12</dealFrequency>
  <skipReferenceFlag>>true</skipReferenceFlag>
  <priceSelectionDate>2022-02-22</priceSelectionDate>
  <usagePeriod>12</usagePeriod>
  <includeHierarchyFlag>>true</includeHierarchyFlag>
  <status>PSML</status>
  <templateFlag>>false</templateFlag>
  <createdDate>2022-02-26</createdDate>
</dealDetails>
<templateReferenceDetails>
  <copyBasicDetailsFlag>>false</copyBasicDetailsFlag>
  <copyPricingFlag>>false</copyPricingFlag>
  <copyUsageFlag>>false</copyUsageFlag>
</templateReferenceDetails>
<dealCharacteristics>
  <characteristicType>ZZ-DLCHR</characteristicType>
  <effectiveDate>2021-06-01</effectiveDate>
  <characteristicValue>7266725883</characteristicValue>
</dealCharacteristics>
<dealTermsAndConditionsDetails>
  <termsAndConditionsList>
    <description>Test Terms</description>
    <termsAndCondition>TEST_TC8</termsAndCondition>
    <termsAndConditionText>Test changed</termsAndConditionText>
  </termsAndConditionsList>
  <adhocTermsAndCondition>DOCH DESC</adhocTermsAndCondition>
</dealTermsAndConditionsDetails>
<productDetailsList>
  <productCode>AUT_MPD1_BUSS1</productCode>
</productDetailsList>
<productDetailsList>
  <productCode>AUT_MPD_930_TECH</productCode>
</productDetailsList>
<productDetailsList>
  <productCode>AUT_MPD_CA_TECH</productCode>
</productDetailsList>
<productDetailsList>
  <productCode>AUT_MPD_CA_TECH</productCode>
</productDetailsList>
</productDetailsList>

```

```

    <productCode>RTEST_BPTECT</productCode>
  </productDetailsList>
  <referenceDetails>
    <referUsageSw>>false</referUsageSw>
    <referPriceSw>>false</referPriceSw>
  </referenceDetails>
</C1-DealCreationUpdateIWS>

```

Note: We have given the above request and response samples to illustrate how the tags should be nested while sending a deal view request from the external system. However, you should not seamlessly use this request sample in your environment because the required pre-requisite data may not be available in your environment. In such case, the system will give erroneous results.

Related Topics

For more information on...	See...
Deal view request and response - tags in the XML format	Deal View Request and Response - Tags in the XML Format on page 4032

Sample Deal Update Request and Response in the XML Format

Using the below example, you can update the deal 4524551669.

Sample Deal Update Request in the XML Format

```

<C1-DealCreationUpdateIWS>
  <actionFlag>UPD</actionFlag>
  <dealDetails>
    <dealIdentifier>DEALPRS2022PER23</dealIdentifier>
    <dealInformation>4524551669,CITI BANK,CORP,03-09-2022,United States
Dollars,Contracted Deal-No,(1),DEALPRS2022PER23</dealInformation>
    <dealID>4524551669</dealID>
    <modelId>9202703256</modelId>
    <dealEntityType>PRSP</dealEntityType>
    <customerSegment>COMM</customerSegment>
    <customerTier>T</customerTier>
    <division>930</division>
    <accessGrp>***</accessGrp>
    <dealEntityId>0218803513</dealEntityId>
    <contractedDealFlag>>false</contractedDealFlag>
    <currency>USD</currency>
    <dealTypeCode>ANRMONLY</dealTypeCode>
    <startDate>2022-03-09</startDate>
    <endDate>2023-03-09</endDate>
    <simulationTypeFlag>CUST</simulationTypeFlag>
    <dealDescription>Deal Description update</dealDescription>
    <dealVersionDescription>Deal version description update</
dealVersionDescription>
    <dealFrequency>1</dealFrequency>
    <skipReferenceFlag>>true</skipReferenceFlag>
    <priceSelectionDate>2022-03-09</priceSelectionDate>
    <usagePeriod>1</usagePeriod>
    <includeHierarchyFlag>>true</includeHierarchyFlag>
    <status>PSML</status>
    <templateFlag>>false</templateFlag>
    <createdDate>2022-03-09</createdDate>
  </dealDetails>
  <templateReferenceDetails>
    <copyBasicDetailsFlag>>false</copyBasicDetailsFlag>
    <copyPricingFlag>>false</copyPricingFlag>
    <copyUsageFlag>>false</copyUsageFlag>
  </templateReferenceDetails>

```

```

<dealCharacteristics>
  <characteristicType>ABC</characteristicType>
  <effectiveDate>2021-03-09</effectiveDate>
  <characteristicValue>5881231767</characteristicValue>
</dealCharacteristics>
<dealTermsAndConditionsDetails>
  <termsAndConditionsList>
    <description>T&C 1 Desc</description>
    <termsAndCondition>T&C 1</termsAndCondition>
    <termsAndConditionText>Adhoc Text</termsAndConditionText>
  </termsAndConditionsList>
  <adhocTermsAndCondition>Adhoc Description</adhocTermsAndCondition>
</dealTermsAndConditionsDetails>
<productDetailsList>
  <productCode>IMA_BP1</productCode>
  <productCode>IMA_BP2</productCode>
</productDetailsList>
<referenceDetails>
  <referUsageSw>>false</referUsageSw>
  <referPriceSw>>false</referPriceSw>
  <includeChildHierarchy>>false</includeChildHierarchy>
</referenceDetails>
</C1-DealCreationUpdateIWS>

```

Note: If you do not want to enter the data in the list tags (i.e. tags where the type is set to list), you should not include them in the request. Adding empty list tags will give erroneous results.

Sample Deal Update Response in the XML Format

```

<C1-DealCreationUpdateIWS>
  <actionFlag>UPD</actionFlag>
  <dealResponse>
    <message>Deal Updated Successfully</message>
  </dealResponse>
  <dealDetails>
    <dealIdentifier>DEALPRS2022PER23</dealIdentifier>
    <dealInformation>4524551669,CITI BANK,CORP,03-09-2022,United States
    Dollars,Contracted Deal-No,(1),DEALPRS2022PER23</dealInformation>
    <dealId>4524551669</dealId>
    <modelId>9202703256</modelId>
    <dealEntityType>PRSP</dealEntityType>
    <customerSegment>COMM</customerSegment>
    <customerTier>T</customerTier>
    <division>930</division>
    <accessGrp>***</accessGrp>
    <dealEntityId>0218803513</dealEntityId>
    <contractedDealFlag>>false</contractedDealFlag>
    <currency>USD</currency>
    <dealTypeCode>ANRMONLY</dealTypeCode>
    <startDate>2022-03-09</startDate>
    <endDate>2023-03-09</endDate>
    <simulationTypeFlag>CUST</simulationTypeFlag>
    <dealDescription>Deal Description update</dealDescription>
    <longDescription>Deal description update</longDescription>
    <dealVersionDescription>Deal version description update</
dealVersionDescription>
    <dealFrequency>1</dealFrequency>
    <skipReferenceFlag>>true</skipReferenceFlag>
    <priceSelectionDate>2022-03-09</priceSelectionDate>
    <usagePeriod>1</usagePeriod>
    <includeHierarchyFlag>>true</includeHierarchyFlag>
    <status>PSML</status>
    <templateFlag>>false</templateFlag>

```

```

    <createdDate>2022-03-09</createdDate>
  </dealDetails>
  <templateReferenceDetails>
    <copyBasicDetailsFlag>>false</copyBasicDetailsFlag>
    <copyPricingFlag>>false</copyPricingFlag>
    <copyUsageFlag>>false</copyUsageFlag>
  </templateReferenceDetails>
  <dealCharacteristics>
    <characteristicType>ABC</characteristicType>
    <effectiveDate>2021-03-09</effectiveDate>
    <characteristicValue>5881231767</characteristicValue>
  </dealCharacteristics>
  <dealTermsAndConditionsDetails>
    <termsAndConditionsList>
      <description>T&C 1 Desc</description>
      <termsAndCondition>T&C 1</termsAndCondition>
      <termsAndConditionText>Adhoc Text</termsAndConditionText>
    </termsAndConditionsList>
    <adhocTermsAndCondition>Adhoc Description</adhocTermsAndCondition>
  </dealTermsAndConditionsDetails>
  <productDetailsList>
    <productCode>IMA_BP1</productCode>
    <productCode>IMA_BP2</productCode>
  </productDetailsList>
  <referenceDetails>
    <referUsageSw>>false</referUsageSw>
    <referPriceSw>>false</referPriceSw>
    <includeChildHierarchy>>false</includeChildHierarchy>
  </referenceDetails>
</C1-DealCreationUpdateIWS>

```

Note: We have given the above request and response samples to illustrate how the tags should be nested while sending a deal update request from the external system. However, you should not seamlessly use this request sample in your environment because the required pre-requisite data may not be available in your environment. In such case, the system will give erroneous results.

Related Topics

For more information on...	See...
Deal update request and response tags in the XML format	Deal Update Request and Response - Tags in the XML Format on page 4010

Sample Deal Version Creation Request and Response in the XML Format

Using the below example, you can create the deal version of the deal 6287907587.

Sample Deal Version Creation Request in the XML Format

```

<C1-DealCreationUpdateIWS>
  <actionFlag>ADD</actionFlag>
  <dealOperation>
    <operationFlag>CRDV</operationFlag>
    <dealId>9953437478</dealId>
    <modelId>7404912267</modelId>
    <dealVersionDescription>Version 2</dealVersionDescription>
    <dealVersionCreationFlag>FLHR</dealVersionCreationFlag>
  </dealOperation>
</C1-DealCreationUpdateIWS>

```

Note: If you do not want to enter the data in the list tags (i.e. tags where the type is set to list), you should not include them in the request. Adding empty list tags will give erroneous results.

Sample Deal Version Creation Response in the XML Format

```

<C1-DealCreationUpdateIWS>
  <actionFlag>ADD</actionFlag>
  <dealResponse>
    <message>Deal Version created successfully.</message>
  </dealResponse>
  <dealOperation>
    <operationFlag>CRDV</operationFlag>
    <dealId>9953437478</dealId>
    <modelId>7404912267</modelId>
    <dealVersionDescription>Version 2</dealVersionDescription>
    <dealVersionCreationFlag>FLHR</dealVersionCreationFlag>
  </dealOperation>
  <dealDetails>
    <dealId>9953437478</dealId>
    <modelId>8149209383</modelId>
    <contractedDealFlag>false</contractedDealFlag>
    <simulationTypeFlag>false</simulationTypeFlag>
    <includeHierarchyFlag>false</includeHierarchyFlag>
    <dealVersionStatus>PSML</dealVersionStatus>
    <templateFlag>false</templateFlag>
  </dealDetails>
  <templateReferenceDetails>
    <copyBasicDetailsFlag>false</copyBasicDetailsFlag>
    <copyPricingFlag>false</copyPricingFlag>
    <copyUsageFlag>false</copyUsageFlag>
  </templateReferenceDetails>
  <referenceDetails>
    <referUsageSw>false</referUsageSw>
    <referPriceSw>false</referPriceSw>
    <includeChildHierarchy>false</includeChildHierarchy>
  </referenceDetails>
</C1-DealCreationUpdateIWS>

```

Note: We have given the above request and response samples to illustrate how the tags should be nested while sending a deal version creation request from the external system. However, you should not seamlessly use this request sample in your environment because the required pre-requisite data may not be available in your environment. In such case, the system will give erroneous results.

Related Topics

For more information on...	See...
Deal update request and response tags in the XML format	Deal Update Request and Response - Tags in the XML Format on page 4010

Sample Deal Simulation Request and Response in the XML Format

Using the below example, you can simulate the deal 1359491858.

Sample Deal Simulation Request in the XML Format

```

<C1-DealCreationUpdateIWS>
  <actionFlag>UPD</actionFlag>
  <dealOperation>
    <operationFlag>SMLD</operationFlag>
    <dealId>1359491858</dealId>
    <modelId>8154562108</modelId>
  </dealOperation>
</C1-DealCreationUpdateIWS>

```

Sample Deal Simulation Response in the XML Format

```

<C1-DealCreationUpdateIWS>
  <actionFlag>UPD</actionFlag>
  <dealResponse>
    <message>Deal Simulated Successfully</message>
  </dealResponse>
  <dealOperation>
    <operationFlag>SMLD</operationFlag>
    <dealId>1359491858</dealId>
    <modelId>8154562108</modelId>
  </dealOperation>
  <dealDetails>
    <dealEntityDetails>
      <personIdentifierType></personIdentifierType>
      <personIdentifier></personIdentifier>
      <personId></personId>
      <accountIdentifierType></accountIdentifierType>
      <accountIdentifier></accountIdentifier>
      <accountId></accountId>
      <prsPerIdentifierType></prsPerIdentifierType>
      <prsPerIdentifier></prsPerIdentifier>
      <prospectPersonId></prospectPersonId>
      <division></division>
    </dealEntityDetails>
    <dealIdentifier></dealIdentifier>
    <dealInformation></dealInformation>
    <dealId></dealId>
    <modelId></modelId>
    <dealEntityType></dealEntityType>
    <customerSegment></customerSegment>
    <customerTier></customerTier>
    <division></division>
    <accessGrp></accessGrp>
    <dealEntityId></dealEntityId>
    <contractedDealFlag>>false</contractedDealFlag>
    <currency></currency>
    <dealTypeCode></dealTypeCode>
    <startDate></startDate>
    <endDate></endDate>
    <simulationTypeFlag></simulationTypeFlag>
    <reviewFrequency></reviewFrequency>
    <dealDescription></dealDescription>
    <longDescription></longDescription>
    <dealVersionDescription></dealVersionDescription>
    <dealFrequency></dealFrequency>
    <skipReferenceFlag>>false</skipReferenceFlag>
    <priceSelectionDate></priceSelectionDate>
    <usagePeriod></usagePeriod>
    <includeHierarchyFlag>>false</includeHierarchyFlag>
    <status>SMLD</status>
    <dealVersionStatus>SMLD</dealVersionStatus>
    <templateFlag>>false</templateFlag>
    <createdDate></createdDate>
    <acceptanceDate></acceptanceDate>
    <finalizedDate></finalizedDate>
    <effectiveStartDate></effectiveStartDate>
    <effectiveEndDate></effectiveEndDate>
    <reviewedDate></reviewedDate>
  </dealDetails>
  <templateReferenceDetails>
    <templateDealId></templateDealId>
    <templateDealIdentifier></templateDealIdentifier>
    <templateModelId></templateModelId>
  </templateReferenceDetails>

```

```

    <copyBasicDetailsFlag>>false</copyBasicDetailsFlag>
    <copyPricingFlag>>false</copyPricingFlag>
    <copyUsageFlag>>false</copyUsageFlag>
  </templateReferenceDetails>
  <dealCharacteristics>
    <characteristicType></characteristicType>
    <effectiveDate></effectiveDate>
    <characteristicValue></characteristicValue>
  </dealCharacteristics>
  <dealTermsAndConditionsDetails>
    <termsAndConditionsList>
      <description></description>
      <termsAndCondition></termsAndCondition>
      <termsAndConditionText></termsAndConditionText>
    </termsAndConditionsList>
    <adhocTermsAndCondition></adhocTermsAndCondition>
  </dealTermsAndConditionsDetails>
  <productDetailsList>
    <productCode></productCode>
  </productDetailsList>
  <referenceDetails>
    <referenceTypeFlg></referenceTypeFlg>
    <refPersonIdentifierType></refPersonIdentifierType>
    <refPersonIdentifier></refPersonIdentifier>
    <referPersonId></referPersonId>
    <refAccountIdentifierType></refAccountIdentifierType>
    <refAccountIdentifier></refAccountIdentifier>
    <referAccountId></referAccountId>
    <referDealIdentifier></referDealIdentifier>
    <referenceDealId></referenceDealId>
    <referenceModelId></referenceModelId>
    <referUsageSw>>false</referUsageSw>
    <referPriceSw>>false</referPriceSw>
    <includeChildHierarchy>>false</includeChildHierarchy>
    <division></division>
  </referenceDetails>
  <dealSimulationDetails>
    <dealfinancialsummarylist>
      <approvalStatus></approvalStatus>
      <originalDealFinancialSummary>
        <revenue>$0.00</revenue>
        <cost>$0.00</cost>
        <profit>$0.00</profit>
        <profitabilityPercentage>$0.00</profitabilityPercentage>
      </originalDealFinancialSummary>
      <proposedDealFinancialSummary>
        <revenue>$1,250.00</revenue>
        <cost>$50.00</cost>
        <profit>$1,200.00</profit>
        <profitabilityPercentage>96.00</profitabilityPercentage>
      </proposedDealFinancialSummary>
      <recommenedDealFinancialSummary>
        <revenue></revenue>
        <profit></profit>
        <profitabilityPercentage></profitabilityPercentage>
      </recommenedDealFinancialSummary>
      <profitVariationPercentage></profitVariationPercentage>
    </dealfinancialsummarylist>
    <divisionFinancialSummaryDetails>
      <division></division>
      <approvalStatus></approvalStatus>
      <originalDivisionFinancialSummary>
        <revenue></revenue>
        <cost></cost>

```

```

        <profit></profit>
        <profitabilityPercentage></profitabilityPercentage>
    </originalDivisionFinancialSummary>
    <proposedDivisionFinancialSummary>
        <revenue></revenue>
        <cost></cost>
        <profit></profit>
        <profitabilityPercentage></profitabilityPercentage>
    </proposedDivisionFinancialSummary>
    <recommendedDealFinancialSummary>
        <revenue></revenue>
        <profit></profit>
        <profitabilityPercentage></profitabilityPercentage>
    </recommendedDealFinancialSummary>
    <profitVariationPercentage></profitVariationPercentage>
</divisionFinancialSummaryDetails>
<productFinancialSummaryDetails>
    <approvalStatus></approvalStatus>
    <product></product>
    <division></division>
    <originalProductFinancialSummary>
        <revenue></revenue>
        <cost></cost>
        <profit></profit>
        <profitabilityPercentage></profitabilityPercentage>
    </originalProductFinancialSummary>
    <proposedProductDivisionFinancialSummary>
        <revenue></revenue>
        <cost></cost>
        <profit></profit>
        <profitabilityPercentage></profitabilityPercentage>
    </proposedProductDivisionFinancialSummary>
    <recommendedDealFinancialSummary>
        <revenue></revenue>
        <profit></profit>
        <profitabilityPercentage></profitabilityPercentage>
    </recommendedDealFinancialSummary>
    <profitVariationPercentage></profitVariationPercentage>
</productFinancialSummaryDetails>
</dealSimulationDetails>
<hierarchySimulationDetails>
    <hierarchyDetails>
        <entityType>PERS</entityType>
        <entityId>3865913714</entityId>
        <status>Unapproved</status>
        <revenueVariation>0.00</revenueVariation>
        <proposedRevenue>$1,250.00</proposedRevenue>
        <proposedCost>$50.00</proposedCost>
        <originalRevenue>$0.00</originalRevenue>
        <originalCost>$0.00</originalCost>
    </hierarchyDetails>
    <hierarchyDetails>
        <entityType>ACCT</entityType>
        <entityId>2564512509</entityId>
        <parentEntityId>3865913714</parentEntityId>
        <status>Unapproved</status>
        <revenueVariation>0.00</revenueVariation>
        <proposedRevenue>$1,250.00</proposedRevenue>
        <proposedCost>$50.00</proposedCost>
        <originalRevenue>$0.00</originalRevenue>
        <originalCost>$0.00</originalCost>
    </hierarchyDetails>
    <hierarchyDetails>
        <entityType>PERS</entityType>

```

```

    <entityId>3863028908</entityId>
    <parentEntityId>3865913714</parentEntityId>
    <status>Unapproved</status>
    <revenueVariation>0.00</revenueVariation>
    <proposedRevenue>$0.00</proposedRevenue>
    <proposedCost>$0.00</proposedCost>
    <originalRevenue>$0.00</originalRevenue>
    <originalCost>$0.00</originalCost>
  </hierarchyDetails>
  <hierarchyDetails>
    <entityType>PERS</entityType>
    <entityId>1483750392</entityId>
    <parentEntityId>3863028908</parentEntityId>
    <status>Unapproved</status>
    <revenueVariation>0.00</revenueVariation>
    <proposedRevenue>$0.00</proposedRevenue>
    <proposedCost>$0.00</proposedCost>
    <originalRevenue>$0.00</originalRevenue>
    <originalCost>$0.00</originalCost>
  </hierarchyDetails>
</hierarchySimulationDetails>
</C1-DealCreationUpdateIWS>

```

Note: We have given the above request and response samples to illustrate how the tags should be nested while sending a deal simulation request from the external system. However, you should not seamlessly use this request sample in your environment because the required pre-requisite data may not be available in your environment. In such case, the system will give erroneous results.

Related Topics

For more information on...	See...
Deal update request and response tags in the XML format	Deal Update Request and Response - Tags in the XML Format on page 4010

Sample Deal Submission for Approval Request and Response in the XML Format

Using the below example, you can submit the deal 0174339883 for approval.

Sample Deal Simulation for Approval Request in the XML Format

```

<C1-DealCreationUpdateIWS>
  <actionFlag>UPD</actionFlag>
  <dealOperation>
    <operationFlag>SNDP</operationFlag>
    <dealId>0174339883</dealId>
  </dealOperation>
</C1-DealCreationUpdateIWS>

```

Sample Deal Simulation for Approval Response in the XML Format

```

<C1-DealCreationUpdateIWS>
  <actionFlag>UPD</actionFlag>
  <dealResponse>
    <message>Deal Submitted for Approval Successfully</message>
  </dealResponse>
  <dealOperation>
    <operationFlag>SNDP</operationFlag>
    <dealId>0174339883</dealId>
  </dealOperation>
  <dealDetails>
    <dealIdentifier></dealIdentifier>
    <dealInformation></dealInformation>
  </dealDetails>
</C1-DealCreationUpdateIWS>

```

```

<dealId></dealId>
<modelId></modelId>
<dealEntityType></dealEntityType>
<customerSegment></customerSegment>
<customerTier></customerTier>
<division></division>
<accessGrp></accessGrp>
<dealEntityId></dealEntityId>
<contractedDealFlag>>false</contractedDealFlag>
<currency></currency>
<dealTypeCode></dealTypeCode>
<startDate></startDate>
<endDate></endDate>
<simulationTypeFlag></simulationTypeFlag>
<reviewFrequency></reviewFrequency>
<dealDescription></dealDescription>
<longDescription></longDescription>
<dealVersionDescription></dealVersionDescription>
<dealFrequency></dealFrequency>
<skipReferenceFlag>>false</skipReferenceFlag>
<priceSelectionDate></priceSelectionDate>
<usagePeriod></usagePeriod>
<includeHierarchyFlag>>false</includeHierarchyFlag>
<status></status>
<dealVersionStatus></dealVersionStatus>
<templateFlag>>false</templateFlag>
<createdDate></createdDate>
<acceptanceDate></acceptanceDate>
<finalizedDate></finalizedDate>
<effectiveStartDate></effectiveStartDate>
<effectiveEndDate></effectiveEndDate>
<reviewedDate></reviewedDate>
</dealDetails>
<templateReferenceDetails>
  <templateDealId></templateDealId>
  <templateDealIdentifier></templateDealIdentifier>
  <templateModelId></templateModelId>
  <copyBasicDetailsFlag>>false</copyBasicDetailsFlag>
  <copyPricingFlag>>false</copyPricingFlag>
  <copyUsageFlag>>false</copyUsageFlag>
</templateReferenceDetails>
<referenceDetails>
  <referenceTypeFlg></referenceTypeFlg>
  <refPersonIdentifierType></refPersonIdentifierType>
  <refPersonIdentifier></refPersonIdentifier>
  <referPersonId></referPersonId>
  <refAccountIdentifierType></refAccountIdentifierType>
  <refAccountIdentifier></refAccountIdentifier>
  <referAccountId></referAccountId>
  <referDealIdentifier></referDealIdentifier>
  <referenceDealId></referenceDealId>
  <referenceModelId></referenceModelId>
  <referUsageSw>>false</referUsageSw>
  <referPriceSw>>false</referPriceSw>
  <includeChildHierarchy></includeChildHierarchy>
  <division></division>
</referenceDetails>
</C1-DealCreationUpdateIWS>

```

Note: We have given the above request and response samples to illustrate how the tags should be nested while sending a deal submission approval request from the external system. However, you should not seamlessly use this request sample in your environment because the required pre-requisite data may not be available in your environment. In such case, the system will give erroneous results.

Related Topics

For more information on...	See...
Deal update request and response tags in the XML format	Deal Update Request and Response - Tags in the XML Format on page 4010

Sample Deal Approval Request and Response in the XML Format

Using the below example, you can approve the deal 0174339883.

Sample Deal Approval Request in the XML Format

```
<C1-DealCreationUpdateIWS>
  <actionFlag>UPD</actionFlag>
  <dealOperation>
    <operationFlag>APPR</operationFlag>
    <dealId>0174339883</dealId>
  </dealOperation>
</C1-DealCreationUpdateIWS>
```

Sample Deal Approval Response in the XML Format

```
<C1-DealCreationUpdateIWS>
  <actionFlag>UPD</actionFlag>
  <dealResponse>
    <message>Deal Approved Successfully</message>
  </dealResponse>
  <dealOperation>
    <operationFlag>APPR</operationFlag>
    <dealId>0174339883</dealId>
  </dealOperation>
  <dealDetails>
    <dealIdentifier></dealIdentifier>
    <dealInformation></dealInformation>
    <dealId></dealId>
    <modelId></modelId>
    <dealEntityType></dealEntityType>
    <customerSegment></customerSegment>
    <customerTier></customerTier>
    <division></division>
    <accessGrp></accessGrp>
    <dealEntityId></dealEntityId>
    <contractedDealFlag>false</contractedDealFlag>
    <currency></currency>
    <dealTypeCode></dealTypeCode>
    <startDate></startDate>
    <endDate></endDate>
    <simulationTypeFlag></simulationTypeFlag>
    <reviewFrequency></reviewFrequency>
    <dealDescription></dealDescription>
    <longDescription></longDescription>
    <dealVersionDescription></dealVersionDescription>
    <dealFrequency></dealFrequency>
    <skipReferenceFlag>false</skipReferenceFlag>
    <priceSelectionDate></priceSelectionDate>
    <usagePeriod></usagePeriod>
    <includeHierarchyFlag>false</includeHierarchyFlag>
```

```

    <status></status>
    <dealVersionStatus></dealVersionStatus>
    <templateFlag>>false</templateFlag>
    <createdDate></createdDate>
    <acceptanceDate></acceptanceDate>
    <finalizedDate></finalizedDate>
    <effectiveStartDate></effectiveStartDate>
    <effectiveEndDate></effectiveEndDate>
    <reviewedDate></reviewedDate>
  </dealDetails>
  <templateReferenceDetails>
    <templateDealId></templateDealId>
    <templateDealIdentifier></templateDealIdentifier>
    <templateModelId></templateModelId>
    <copyBasicDetailsFlag>>false</copyBasicDetailsFlag>
    <copyPricingFlag>>false</copyPricingFlag>
    <copyUsageFlag>>false</copyUsageFlag>
  </templateReferenceDetails>
  <dealCharacteristics>
    <characteristicType></characteristicType>
    <effectiveDate></effectiveDate>
    <characteristicValue></characteristicValue>
  </dealCharacteristics>
  <dealTermsAndConditionsDetails>
    <termsAndConditionsList>
      <description></description>
      <termsAndCondition></termsAndCondition>
      <termsAndConditionText></termsAndConditionText>
    </termsAndConditionsList>
    <adhocTermsAndCondition></adhocTermsAndCondition>
  </dealTermsAndConditionsDetails>
  <productDetailsList>
    <productCode></productCode>
  </productDetailsList>
  <referenceDetails>
    <referenceTypeFlg></referenceTypeFlg>
    <refPersonIdentifierType></refPersonIdentifierType>
    <refPersonIdentifier></refPersonIdentifier>
    <referPersonId></referPersonId>
    <refAccountIdentifierType></refAccountIdentifierType>
    <refAccountIdentifier></refAccountIdentifier>
    <referAccountId></referAccountId>
    <referDealIdentifier></referDealIdentifier>
    <referenceDealId></referenceDealId>
    <referenceModelId></referenceModelId>
    <referUsageSw>>false</referUsageSw>
    <referPriceSw>>false</referPriceSw>
    <includeChildHierarchy></includeChildHierarchy>
    <division></division>
  </referenceDetails>
</C1-DealCreationUpdateIWS>

```

Note: We have given the above request and response samples to illustrate how the tags should be nested while sending a deal approval request from the external system. However, you should not seamlessly use this request sample in your environment because the required pre-requisite data may not be available in your environment. In such case, the system will give erroneous results.

Related Topics

For more information on...	See...
Deal update request and response tags in the XML format	Deal Update Request and Response - Tags in the XML Format on page 4010

Sample Deal Return to Submitter Request and Response in the XML Format

Using the below example, you can return to submit the deal 0786194281.

Sample Deal Return Submitter Request in the XML Format

```
<C1-DealCreationUpdateIWS>
  <actionFlag>UPD</actionFlag>
  <dealOperation>
    <operationFlag>RETN</operationFlag>
    <dealId>0786194281</dealId>
    <modelId>9319862860</modelId>
    <comments>insufficient sqi</comments>
    <rejectReasonCode>R04</rejectReasonCode>
  </dealOperation>
</C1-DealCreationUpdateIWS>
```

Sample Deal Return Submitter Response in the XML Format

```
<C1-DealCreationUpdateIWS>
  <actionFlag>UPD</actionFlag>
  <dealResponse>
    <message>Deal Returned to Submitter Successfully /message>
  </dealResponse>
  <dealOperation>
    <operationFlag>RETN</operationFlag>
    <dealId>0786194281</dealId>
    <modelId>9319862860</modelId>
    <comments>insufficient sqi</comments>
    <rejectReasonCode>R04</rejectReasonCode>
  </dealOperation>
  <dealDetails>
    <dealIdentifier></dealIdentifier>
    <dealInformation></dealInformation>
    <dealId></dealId>
    <modelId></modelId>
    <dealEntityType></dealEntityType>
    <customerSegment></customerSegment>
    <customerTier></customerTier>
    <division></division>
    <accessGrp></accessGrp>
    <dealEntityId></dealEntityId>
    <contractedDealFlag>>false</contractedDealFlag>
    <currency></currency>
    <dealTypeCode></dealTypeCode>
    <startDate></startDate>
    <endDate></endDate>
    <simulationTypeFlag></simulationTypeFlag>
    <reviewFrequency></reviewFrequency>
    <dealDescription></dealDescription>
    <longDescription></longDescription>
    <dealVersionDescription></dealVersionDescription>
    <dealFrequency></dealFrequency>
    <skipReferenceFlag>>false</skipReferenceFlag>
    <priceSelectionDate></priceSelectionDate>
    <usagePeriod></usagePeriod>
    <includeHierarchyFlag>>false</includeHierarchyFlag>
    <status></status>
    <dealVersionStatus></dealVersionStatus>
```



```

    <templateFlag>>false</templateFlag>
    <createdDate></createdDate>
    <acceptanceDate></acceptanceDate>
    <finalizedDate></finalizedDate>
    <effectiveStartDate></effectiveStartDate>
    <effectiveEndDate></effectiveEndDate>
    <reviewedDate></reviewedDate>
  </dealDetails>
  <templateReferenceDetails>
    <templateDealId></templateDealId>
    <templateDealIdentifier></templateDealIdentifier>
    <templateModelId></templateModelId>
    <copyBasicDetailsFlag>>false</copyBasicDetailsFlag>
    <copyPricingFlag>>false</copyPricingFlag>
    <copyUsageFlag>>false</copyUsageFlag>
  </templateReferenceDetails>
  <referenceDetails>
    <referenceTypeFlg></referenceTypeFlg>
    <refPersonIdentifierType></refPersonIdentifierType>
    <refPersonIdentifier></refPersonIdentifier>
    <referPersonId></referPersonId>
    <refAccountIdentifierType></refAccountIdentifierType>
    <refAccountIdentifier></refAccountIdentifier>
    <referAccountId></referAccountId>
    <referDealIdentifier></referDealIdentifier>
    <referenceDealId></referenceDealId>
    <referenceModelId></referenceModelId>
    <referUsageSw>>false</referUsageSw>
    <referPriceSw>>false</referPriceSw>
    <includeChildHierarchy>>false</includeChildHierarchy>
    <division></division>
  </referenceDetails>
</C1-DealCreationUpdateIWS>

```

Note: We have given the above request and response samples to illustrate how the tags should be nested while sending a deal return to submitter request from the external system. However, you should not seamlessly use this request sample in your environment because the required pre-requisite data may not be available in your environment. In such case, the system will give erroneous results.

Related Topics

For more information on...	See...
Deal update request and response tags in the XML format	Deal Update Request and Response - Tags in the XML Format on page 4010

Sample Deal Finalization Request and Response in the XML Format

Using the below example, you can finalize the deal 0174339883.

Sample Deal Finalization Request in the XML Format

```

<C1-DealCreationUpdateIWS>
  <actionFlag>UPD</actionFlag>
  <dealOperation>
    <operationFlag>FNAL</operationFlag>
    <dealId>0174339883</dealId>
  </dealOperation>
</C1-DealCreationUpdateIWS>

```

Sample Deal Finalization Response in the XML Format

```

<C1-DealCreationUpdateIWS>

```

```

<actionFlag>UPD</actionFlag>
<dealResponse>
  <message>Deal Finalized Successfully</message>
</dealResponse>
<dealOperation>
  <operationFlag>FNAL</operationFlag>
  <dealId>0174339883</dealId>
</dealOperation>
<dealDetails>
  <dealIdentifier></dealIdentifier>
  <dealInformation></dealInformation>
  <dealId></dealId>
  <modelId></modelId>
  <dealEntityType></dealEntityType>
  <customerSegment></customerSegment>
  <customerTier></customerTier>
  <division></division>
  <accessGrp></accessGrp>
  <dealEntityId></dealEntityId>
  <contractedDealFlag>>false</contractedDealFlag>
  <currency></currency>
  <dealTypeCode></dealTypeCode>
  <startDate></startDate>
  <endDate></endDate>
  <simulationTypeFlag></simulationTypeFlag>
  <reviewFrequency></reviewFrequency>
  <dealDescription></dealDescription>
  <longDescription></longDescription>
  <dealVersionDescription></dealVersionDescription>
  <dealFrequency></dealFrequency>
  <skipReferenceFlag>>false</skipReferenceFlag>
  <priceSelectionDate></priceSelectionDate>
  <usagePeriod></usagePeriod>
  <includeHierarchyFlag>>false</includeHierarchyFlag>
  <status></status>
  <dealVersionStatus></dealVersionStatus>
  <templateFlag>>false</templateFlag>
  <createdDate></createdDate>
  <acceptanceDate></acceptanceDate>
  <finalizedDate></finalizedDate>
  <effectiveStartDate></effectiveStartDate>
  <effectiveEndDate></effectiveEndDate>
  <reviewedDate></reviewedDate>
</dealDetails>
<templateReferenceDetails>
  <templateDealId></templateDealId>
  <templateDealIdentifier></templateDealIdentifier>
  <templateModelId></templateModelId>
  <copyBasicDetailsFlag>>false</copyBasicDetailsFlag>
  <copyPricingFlag>>false</copyPricingFlag>
  <copyUsageFlag>>false</copyUsageFlag>
</templateReferenceDetails>
<referenceDetails>
  <referenceTypeFlg></referenceTypeFlg>
  <refPersonIdentifierType></refPersonIdentifierType>
  <refPersonIdentifier></refPersonIdentifier>
  <referPersonId></referPersonId>
  <refAccountIdentifierType></refAccountIdentifierType>
  <refAccountIdentifier></refAccountIdentifier>
  <referAccountId></referAccountId>
  <referDealIdentifier></referDealIdentifier>
  <referenceDealId></referenceDealId>
  <referenceModelId></referenceModelId>
  <referUsageSw>>false</referUsageSw>

```

```

    <referPriceSw>>false</referPriceSw>
    <includeChildHierarchy></includeChildHierarchy>
    <division></division>
  </referenceDetails>
</Cl-DealCreationUpdateIWS>

```

Note: We have given the above request and response samples to illustrate how the tags should be nested while sending a deal finalization request from the external system. However, you should not seamlessly use this request sample in your environment because the required pre-requisite data may not be available in your environment. In such case, the system will give erroneous results.

Related Topics

For more information on...	See...
Deal update request and response tags in the XML format	Deal Update Request and Response - Tags in the XML Format on page 4010

Sample Deal Acceptance Request and Response in the XML Format

Using the below example, you can accept the deal 0174339883.

Sample Deal Acceptance Request in the XML Format

```

<Cl-DealCreationUpdateIWS>
  <actionFlag>UPD</actionFlag>
  <dealOperation>
    <operationFlag>ACPT</operationFlag>
    <dealId>0174339883</dealId>
    <dealAcceptEffStartDate>2022-03-04</dealAcceptEffStartDate>
    <dealAcceptEffEndDate>2023-03-04</dealAcceptEffEndDate>
    <comments>accept deal</comments>
  </dealOperation>
</Cl-DealCreationUpdateIWS>

```

Sample Deal Acceptance Response in the XML Format

```

<Cl-DealCreationUpdateIWS>
  <actionFlag>UPD</actionFlag>
  <dealResponse>
    <message>Deal Accepted Successfully.</message>
  </dealResponse>
  <dealOperation>
    <operationFlag>ACPT</operationFlag>
    <dealId>0174339883</dealId>
    <dealAcceptEffStartDate>2022-03-04</dealAcceptEffStartDate>
    <dealAcceptEffEndDate>2023-03-04</dealAcceptEffEndDate>
    <comments>accept deal</comments>
  </dealOperation>
  <dealDetails>
    <dealIdentifier></dealIdentifier>
    <dealInformation></dealInformation>
    <dealId></dealId>
    <modelId></modelId>
    <dealEntityType></dealEntityType>
    <customerSegment></customerSegment>
    <customerTier></customerTier>
    <division></division>
    <accessGrp></accessGrp>
    <dealEntityId></dealEntityId>
    <contractedDealFlag>false</contractedDealFlag>
    <currency></currency>
    <dealTypeCode></dealTypeCode>
  </dealDetails>
</Cl-DealCreationUpdateIWS>

```

```

<startDate></startDate>
<endDate></endDate>
<simulationTypeFlag></simulationTypeFlag>
<reviewFrequency></reviewFrequency>
<dealDescription></dealDescription>
<longDescription></longDescription>
<dealVersionDescription></dealVersionDescription>
<dealFrequency></dealFrequency>
<skipReferenceFlag>>false</skipReferenceFlag>
<priceSelectionDate></priceSelectionDate>
<usagePeriod></usagePeriod>
<includeHierarchyFlag>>false</includeHierarchyFlag>
<status></status>
<dealVersionStatus></dealVersionStatus>
<templateFlag>>false</templateFlag>
<createdDate></createdDate>
<acceptanceDate></acceptanceDate>
<finalizedDate></finalizedDate>
<effectiveStartDate></effectiveStartDate>
<effectiveEndDate></effectiveEndDate>
<reviewedDate></reviewedDate>
</dealDetails>
<templateReferenceDetails>
  <templateDealId></templateDealId>
  <templateDealIdentifier></templateDealIdentifier>
  <templateModelId></templateModelId>
  <copyBasicDetailsFlag>>false</copyBasicDetailsFlag>
  <copyPricingFlag>>false</copyPricingFlag>
  <copyUsageFlag>>false</copyUsageFlag>
</templateReferenceDetails>
<referenceDetails>
  <referenceTypeFlg></referenceTypeFlg>
  <refPersonIdentifierType></refPersonIdentifierType>
  <refPersonIdentifier></refPersonIdentifier>
  <referPersonId></referPersonId>
  <refAccountIdentifierType></refAccountIdentifierType>
  <refAccountIdentifier></refAccountIdentifier>
  <referAccountId></referAccountId>
  <referDealIdentifier></referDealIdentifier>
  <referenceDealId></referenceDealId>
  <referenceModelId></referenceModelId>
  <referUsageSw>>false</referUsageSw>
  <referPriceSw>>false</referPriceSw>
  <includeChildHierarchy></includeChildHierarchy>
  <division></division>
</referenceDetails>
</C1-DealCreationUpdateIWS>

```

Note: We have given the above request and response samples to illustrate how the tags should be nested while sending a deal acceptance request from the external system. However, you should not seamlessly use this request sample in your environment because the required pre-requisite data may not be available in your environment. In such case, the system will give erroneous results.

Related Topics

For more information on...	See...
Deal update request and response tags in the XML format	Deal Update Request and Response - Tags in the XML Format on page 4010

Sample Deal Rejection Request and Response in the XML Format

Using the below example, you can reject the deal 0174339883.

Sample Deal Rejection Request in the XML Format

```
<C1-DealCreationUpdateIWS>
  <actionFlag>UPD</actionFlag>
  <dealOperation>
    <operationFlag>REJC</operationFlag>
    <dealId>0174339883</dealId>
    <comments>reject</comments>
    <rejectReasonCode>DLPFLW</rejectReasonCode>
  </dealOperation>
</C1-DealCreationUpdateIWS>
```

Sample Deal Rejection Response in the XML Format

```
<C1-DealCreationUpdateIWS>
  <actionFlag>UPD</actionFlag>
  <dealResponse>
    <message>Deal Rejected Successfully.</message>
  </dealResponse>
  <dealOperation>
    <operationFlag>REJC</operationFlag>
    <dealIdentifier></dealIdentifier>
    <dealId>0174339883</dealId>
    <modelId></modelId>
    <dealAcceptEffStartDate>2022-03-04</dealAcceptEffStartDate>
    <dealAcceptEffEndDate></dealAcceptEffEndDate>
    <comments></comments>
    <rejectReasonCode></rejectReasonCode>
    <dealVersionDescription></dealVersionDescription>
    <dealVersionCreationFlag></dealVersionCreationFlag>
  </dealOperation>
  <priceItemGroupSelection>
    <priceItemSelectionList>
      <priceItemCode></priceItemCode>
      <priceItemInfo></priceItemInfo>
      <parameterInfo></parameterInfo>
      <assignmentLevel></assignmentLevel>
      <priceAssignmentId></priceAssignmentId>
      <hierarchyDetails></hierarchyDetails>
      <includeFlag></includeFlag>
    </priceItemSelectionList>
  </priceItemGroupSelection>
  <dealDetails>
    <dealEntityDetails>
      <personIdentifierType></personIdentifierType>
      <personIdentifier></personIdentifier>
      <personId></personId>
      <accountIdentifierType></accountIdentifierType>
      <accountIdentifier></accountIdentifier>
      <accountId></accountId>
      <prsPerIdentifierType></prsPerIdentifierType>
      <prsPerIdentifier></prsPerIdentifier>
      <prospectPersonId></prospectPersonId>
      <division></division>
    </dealEntityDetails>
    <dealIdentifier></dealIdentifier>
    <dealInformation></dealInformation>
    <dealId></dealId>
    <modelId></modelId>
    <dealEntityType></dealEntityType>
    <customerSegment></customerSegment>
    <customerTier></customerTier>
```

```

<division></division>
<accessGrp></accessGrp>
<dealEntityId></dealEntityId>
<contractedDealFlag></contractedDealFlag>
<currency></currency>
<dealTypeCode></dealTypeCode>
<startDate></startDate>
<endDate></endDate>
<simulationTypeFlag></simulationTypeFlag>
<reviewFrequency></reviewFrequency>
<dealDescription></dealDescription>
<longDescription></longDescription>
<dealVersionDescription></dealVersionDescription>
<dealFrequency></dealFrequency>
<skipReferenceFlag></skipReferenceFlag>
<priceSelectionDate></priceSelectionDate>
<usagePeriod></usagePeriod>
<includeHierarchyFlag></includeHierarchyFlag>
<status></status>
<dealVersionStatus></dealVersionStatus>
<templateFlag></templateFlag>
<createdDate></createdDate>
<acceptanceDate></acceptanceDate>
<finalizedDate></finalizedDate>
<effectiveStartDate></effectiveStartDate>
<effectiveEndDate></effectiveEndDate>
<reviewedDate></reviewedDate>
</dealDetails>
<templateReferenceDetails>
  <templateDealId></templateDealId>
  <templateDealIdentifier></templateDealIdentifier>
  <templateModelId></templateModelId>
  <copyBasicDetailsFlag></copyBasicDetailsFlag>
  <copyPricingFlag></copyPricingFlag>
  <copyUsageFlag></copyUsageFlag>
</templateReferenceDetails>
<dealCharacteristics>
  <characteristicType></characteristicType>
  <effectiveDate></effectiveDate>
  <characteristicValue></characteristicValue>
</dealCharacteristics>
<dealTermsAndConditionsDetails>
  <termsAndConditionsList>
    <description></description>
    <termsAndCondition></termsAndCondition>
    <termsAndConditionText></termsAndConditionText>
  </termsAndConditionsList>
  <adhocTermsAndCondition></adhocTermsAndCondition>
</dealTermsAndConditionsDetails>
<productDetailsList>
  <productCode></productCode>
</productDetailsList>
<referenceDetails>
  <referenceTypeFlg></referenceTypeFlg>
  <refPersonIdentifierType></refPersonIdentifierType>
  <refPersonIdentifier></refPersonIdentifier>
  <referPersonId></referPersonId>
  <refAccountIdentifierType></refAccountIdentifierType>
  <refAccountIdentifier></refAccountIdentifier>
  <referAccountId></referAccountId>
  <referDealIdentifier></referDealIdentifier>
  <referenceDealId></referenceDealId>
  <referenceModelId></referenceModelId>
  <referUsageSw></referUsageSw>

```

```

    <referPriceSw></referPriceSw>
    <includeChildHierarchy></includeChildHierarchy>
    <division></division>
  </referenceDetails>
</Cl-DealCreationUpdateIWS>

```

Note: We have given the above request and response samples to illustrate how the tags should be nested while sending a deal rejection request from the external system. However, you should not seamlessly use this request sample in your environment because the required pre-requisite data may not be available in your environment. In such case, the system will give erroneous results.

Related Topics

For more information on...	See...
Deal update request and response tags in the XML format	Deal Update Request and Response - Tags in the XML Format on page 4010

Sample Deal Discard Request and Response in the XML Format

Using the below example, you can discard the deal version 9319862860.

Sample Deal Discard Request in the XML Format

```

<Cl-DealCreationUpdateIWS>
  <actionFlag>UPD</actionFlag>
  <dealOperation>
    <operationFlag>DSCR</operationFlag>
    <dealId>0786194281</dealId>
    <modelId>9319862860</modelId>
  </dealOperation>
</Cl-DealCreationUpdateIWS>

```

Sample Deal Discard Response in the XML Format

```

<Cl-DealCreationUpdateIWS>
  <actionFlag>UPD</actionFlag>
  <dealResponse>
    <message>Deal Discarded Successfully</message>
  </dealResponse>
  <dealOperation>
    <operationFlag>DSCR</operationFlag>
    <dealId>0786194281</dealId>
    <modelId>9319862860</modelId>
  </dealOperation>
  <dealDetails>
    <dealIdentifier></dealIdentifier>
    <dealInformation></dealInformation>
    <dealId></dealId>
    <modelId></modelId>
    <dealEntityType></dealEntityType>
    <customerSegment></customerSegment>
    <customerTier></customerTier>
    <division></division>
    <accessGrp></accessGrp>
    <dealEntityId></dealEntityId>
    <contractedDealFlag>false</contractedDealFlag>
    <currency></currency>
    <dealTypeCode></dealTypeCode>
    <startDate></startDate>
    <endDate></endDate>
    <simulationTypeFlag></simulationTypeFlag>
    <reviewFrequency></reviewFrequency>
  </dealDetails>
</Cl-DealCreationUpdateIWS>

```

```

<dealDescription></dealDescription>
<longDescription></longDescription>
<dealVersionDescription></dealVersionDescription>
<dealFrequency></dealFrequency>
<skipReferenceFlag>>false</skipReferenceFlag>
<priceSelectionDate></priceSelectionDate>
<usagePeriod></usagePeriod>
<includeHierarchyFlag>>false</includeHierarchyFlag>
<status></status>
<dealVersionStatus></dealVersionStatus>
<templateFlag>>false</templateFlag>
<createdDate></createdDate>
<acceptanceDate></acceptanceDate>
<finalizedDate></finalizedDate>
<effectiveStartDate></effectiveStartDate>
<effectiveEndDate></effectiveEndDate>
<reviewedDate></reviewedDate>
</dealDetails>
<templateReferenceDetails>
  <templateDealId></templateDealId>
  <templateDealIdentifier></templateDealIdentifier>
  <templateModelId></templateModelId>
  <copyBasicDetailsFlag>>false</copyBasicDetailsFlag>
  <copyPricingFlag>>false</copyPricingFlag>
  <copyUsageFlag>>false</copyUsageFlag>
</templateReferenceDetails>
<referenceDetails>
  <referenceTypeFlg></referenceTypeFlg>
  <refPersonIdentifierType></refPersonIdentifierType>
  <refPersonIdentifier></refPersonIdentifier>
  <referPersonId></referPersonId>
  <refAccountIdentifierType></refAccountIdentifierType>
  <refAccountIdentifier></refAccountIdentifier>
  <referAccountId></referAccountId>
  <referDealIdentifier></referDealIdentifier>
  <referenceDealId></referenceDealId>
  <referenceModelId></referenceModelId>
  <referUsageSw>>false</referUsageSw>
  <referPriceSw>>false</referPriceSw>
  <includeChildHierarchy>>false</includeChildHierarchy>
  <division></division>
</referenceDetails>
</C1-DealCreationUpdateIWS>

```

Note: We have given the above request and response samples to illustrate how the tags should be nested while sending a deal discard request from the external system. However, you should not seamlessly use this request sample in your environment because the required pre-requisite data may not be available in your environment. In such case, the system will give erroneous results.

Related Topics

For more information on...	See...
Deal update request and response tags in the XML format	Deal Update Request and Response - Tags in the XML Format on page 4010

Sample Price Item Selection View Request and Response in the XML Format

Using the below example, you can view the deal 8896302706.

Sample Deal View Request in the XML Format

```
<C1-DealCreationUpdateIWS>
```



```

    <actionFlag>READ</actionFlag>
    <dealOperation>
      <operationFlag>PSEL</operationFlag>
      <dealId>6287907587</dealId>
    </dealOperation>
  </Cl-DealCreationUpdateIWS>

```

Sample Deal View Response in the XML Format

```

<Cl-DealCreationUpdateIWS>
  <actionFlag>READ</actionFlag>
  <dealOperation>
    <operationFlag>PSEL</operationFlag>
    <dealId>6287907587</dealId>
  </dealOperation>
  <priceItemGroupSelection>
    <priceItemSelectionList>
      <priceItemCode>ACH</priceItemCode>
      <priceItemInfo>ACH, Automated Clearing House</priceItemInfo>
      <parameterInfo></parameterInfo>
      <assignmentLevel>Global Price List</assignmentLevel>
      <priceAssignmentId></priceAssignmentId>
      <hierarchyDetails></hierarchyDetails>
      <includeFlag>>false</includeFlag>
    </priceItemSelectionList>
  </priceItemGroupSelection>
  <dealDetails>
    <dealIdentifier></dealIdentifier>
    <dealInformation></dealInformation>
    <dealId>6287907587</dealId>
    <modelId>5765155419</modelId>
    <dealEntityType></dealEntityType>
    <customerSegment></customerSegment>
    <customerTier></customerTier>
    <division></division>
    <accessGrp></accessGrp>
    <dealEntityId></dealEntityId>
    <contractedDealFlag>>false</contractedDealFlag>
    <currency></currency>
    <dealTypeCode></dealTypeCode>
    <startDate></startDate>
    <endDate></endDate>
    <simulationTypeFlag></simulationTypeFlag>
    <reviewFrequency></reviewFrequency>
    <dealDescription></dealDescription>
    <longDescription></longDescription>
    <dealVersionDescription></dealVersionDescription>
    <dealFrequency></dealFrequency>
    <skipReferenceFlag>>false</skipReferenceFlag>
    <priceSelectionDate></priceSelectionDate>
    <usagePeriod></usagePeriod>
    <includeHierarchyFlag>>false</includeHierarchyFlag>
    <status></status>
    <dealVersionStatus></dealVersionStatus>
    <templateFlag>>false</templateFlag>
    <createdDate></createdDate>
    <acceptanceDate></acceptanceDate>
    <finalizedDate></finalizedDate>
    <effectiveStartDate></effectiveStartDate>
    <effectiveEndDate></effectiveEndDate>
    <reviewedDate></reviewedDate>
  </dealDetails>
  <templateReferenceDetails>
    <templateDealId></templateDealId>

```

```

<templateDealIdentifier></templateDealIdentifier>
<templateModelId></templateModelId>
<copyBasicDetailsFlag>>false</copyBasicDetailsFlag>
<copyPricingFlag>>false</copyPricingFlag>
<copyUsageFlag>>false</copyUsageFlag>
</templateReferenceDetails>
<referenceDetails>
  <referenceTypeFlg></referenceTypeFlg>
  <refPersonIdentifierType></refPersonIdentifierType>
  <refPersonIdentifier></refPersonIdentifier>
  <referPersonId></referPersonId>
  <refAccountIdentifierType></refAccountIdentifierType>
  <refAccountIdentifier></refAccountIdentifier>
  <referAccountId></referAccountId>
  <referDealIdentifier></referDealIdentifier>
  <referenceDealId></referenceDealId>
  <referenceModelId></referenceModelId>
  <referUsageSw>>false</referUsageSw>
  <referPriceSw>>false</referPriceSw>
  <includeChildHierarchy>>false</includeChildHierarchy>
  <division></division>
</referenceDetails>
</C1-DealCreationUpdateIWS>

```

Related Topics

For more information on...	See...
Deal view request and response - tags in the XML format	Deal View Request and Response - Tags in the XML Format on page 4032

Sample Price Item Selection Request and Response in the XML Format

Using the below example, you can select price item for the deal 6287907587.

Sample Price Item Selection Request in the XML Format

```

<C1-DealCreationUpdateIWS>
  <actionFlag>UPD</actionFlag>
  <dealOperation>
    <operationFlag>PSEL</operationFlag>
    <dealId>6287907587</dealId>
  </dealOperation>
  <priceItemGroupSelection>
    <priceItemSelectionList>
      <priceItemCode>ACH</priceItemCode>
      <priceItemInfo>ACH, Automated Clearing House</priceItemInfo>
      <parameterInfo></parameterInfo>
      <assignmentLevel>Global Price List</assignmentLevel>
      <priceAssignmentId>4040864221</priceAssignmentId>
      <hierarchyDetails></hierarchyDetails>
      <includeFlag>>true</includeFlag>
    </priceItemSelectionList>
  </priceItemGroupSelection>
</C1-DealCreationUpdateIWS>

```

Sample Price Item Selection Response in the XML Format

```

<C1-DealCreationUpdateIWS>
  <actionFlag>UPD</actionFlag>
  <dealResponse>
    <message></message>
  </dealResponse>
  <dealOperation>

```

```

    <operationFlag>PSEL</operationFlag>
    <dealId>6287907587</dealId>
  </dealOperation>
  <priceItemGroupSelection>
    <priceItemSelectionList>
      <priceItemCode>ACH</priceItemCode>
      <priceItemInfo>ACH,Automated Clearing House</priceItemInfo>
      <parameterInfo></parameterInfo>
      <assignmentLevel>Global Price List</assignmentLevel>
      <priceAssignmentId></priceAssignmentId>
      <hierarchyDetails></hierarchyDetails>
      <includeFlag>true</includeFlag>
    </priceItemSelectionList>
  </priceItemGroupSelection>
  <dealDetails>
    <dealEntityDetails>
      <personIdentifierType></personIdentifierType>
      <personIdentifier></personIdentifier>
      <personId></personId>
      <accountIdentifierType></accountIdentifierType>
      <accountIdentifier></accountIdentifier>
      <accountId></accountId>
      <prsPerIdentifierType></prsPerIdentifierType>
      <prsPerIdentifier></prsPerIdentifier>
      <prospectPersonId></prospectPersonId>
      <division></division>
    </dealEntityDetails>
    <dealIdentifier></dealIdentifier>
    <dealInformation></dealInformation>
    <dealId>6287907587</dealId>
    <modelId>5765155419</modelId>
    <dealEntityType></dealEntityType>
    <customerSegment></customerSegment>
    <customerTier></customerTier>
    <division></division>
    <accessGrp></accessGrp>
    <dealEntityId></dealEntityId>
    <contractedDealFlag>false</contractedDealFlag>
    <currency></currency>
    <dealTypeCode></dealTypeCode>
    <startDate></startDate>
    <endDate></endDate>
    <simulationTypeFlag></simulationTypeFlag>
    <reviewFrequency></reviewFrequency>
    <dealDescription></dealDescription>
    <longDescription></longDescription>
    <dealVersionDescription></dealVersionDescription>
    <dealFrequency></dealFrequency>
    <skipReferenceFlag>false</skipReferenceFlag>
    <priceSelectionDate></priceSelectionDate>
    <usagePeriod></usagePeriod>
    <includeHierarchyFlag>false</includeHierarchyFlag>
    <status></status>
    <dealVersionStatus></dealVersionStatus>
    <templateFlag>false</templateFlag>
    <createdDate></createdDate>
    <acceptanceDate></acceptanceDate>
    <finalizedDate></finalizedDate>
    <effectiveStartDate></effectiveStartDate>
    <effectiveEndDate></effectiveEndDate>
    <reviewedDate></reviewedDate>
  </dealDetails>
  <templateReferenceDetails>
    <templateDealId></templateDealId>

```

```

    <templateDealIdentifier></templateDealIdentifier>
    <templateModelId></templateModelId>
    <copyBasicDetailsFlag>>false</copyBasicDetailsFlag>
    <copyPricingFlag>>false</copyPricingFlag>
    <copyUsageFlag>>false</copyUsageFlag>
  </templateReferenceDetails>
  <dealCharacteristics>
    <characteristicType></characteristicType>
    <effectiveDate></effectiveDate>
    <characteristicValue></characteristicValue>
  </dealCharacteristics>
  <dealTermsAndConditionsDetails>
    <termsAndConditionsList>
      <description></description>
      <termsAndCondition></termsAndCondition>
      <termsAndConditionText></termsAndConditionText>
    </termsAndConditionsList>
    <adhocTermsAndCondition></adhocTermsAndCondition>
  </dealTermsAndConditionsDetails>
  <productDetailsList>
    <productCode></productCode>
  </productDetailsList>
  <referenceDetails>
    <referenceTypeFlg></referenceTypeFlg>
    <refPersonIdentifierType></refPersonIdentifierType>
    <refPersonIdentifier></refPersonIdentifier>
    <referPersonId></referPersonId>
    <refAccountIdentifierType></refAccountIdentifierType>
    <refAccountIdentifier></refAccountIdentifier>
    <referAccountId></referAccountId>
    <referDealIdentifier></referDealIdentifier>
    <referenceDealId></referenceDealId>
    <referenceModelId></referenceModelId>
    <referUsageSw>>false</referUsageSw>
    <referPriceSw>>false</referPriceSw>
    <includeChildHierarchy>>false</includeChildHierarchy>
    <division></division>
  </referenceDetails>
</C1-DealCreationUpdateIWS>

```

Note: We have given the above request and response samples to illustrate how the tags should be nested while sending a price item selection request from the external system. However, you should not seamlessly use this request sample in your environment because the required pre-requisite data may not be available in your environment. In such case, the system will give erroneous results.

Related Topics

For more information on...	See...
Deal update request and response tags in the XML format	Deal Update Request and Response - Tags in the XML Format on page 4010

Deal Creation Request in the JSON Format

The following code snippet illustrates how the attribute/value pairs should be structured while receiving the deal creation request in the JSON Format.

```

{
  "C1-DealCreationUpdateIWS" :
  {
    "actionFlag" : "",
    "dealDetails"
  }
}

```

```

{
  "dealEntityDetails"
  {
    "personIdentifierType" : "",
    "personIdentifier" : "",
    "personId" : "",
    "accountIdentifierType" : "",
    "accountIdentifier" : "",
    "accountId" : "",
    "prsPerIdentifierType" : "",
    "prsPerIdentifier" : "",
    "prospectPersonId" : "",
    "division" : "",
  }
  "dealIdentifier" : "",
  "dealEntityType" : "",
  "customerSegment" : "",
  "customerTier" : "",
  "division" : "",
  "accessGrp" : "",
  "contractedDealFlag" : "",
  "currency" : "",
  "dealTypeCode" : "",
  "startDate" : "",
  "endDate" : "",
  "simulationTypeFlag" : "",
  "reviewFrequency" : "",
  "dealDescription" : "",
  "dealVersionDescription" : "",
  "dealFrequency" : "",
  "skipReferenceFlag" : "",
  "priceSelectionDate" : "",
  "usagePeriod" : "",
  "includeHierarchyFlag" : "",
  "status" : "",
  "dealVersionStatus" : "",
  "templateFlag" : "",
}
"templateReferenceDetails"
{
  "templateDealId" : "",
  "templateDealIdentifier" : "",
  "templateModelId" : "",
  "copyBasicDetailsFlag" : "",
  "copyPricingFlag" : "",
  "copyUsageFlag" : "",
}
"dealCharacteristics"
{
  "characteristicType" : "",
  "effectiveDate" : "",
  "characteristicValue" : "",
}
"dealTermsAndConditionsDetails"
{
  "termsAndConditionsList"
  {
    "description mapField" : "",
    "termsAndCondition" : "",
    "termsAndConditionText" : "",
  }
  "adhocTermsAndCondition" : "",
}
"productDetailsList"

```

```

    {
      "productCode" : "",
    }
    "referenceDetails"
    {
      "referenceTypeFlg" : "",
      "refPersonIdentifierType" : "",
      "refPersonIdentifier" : "",
      "referPersonId" : "",
      "refAccountIdentifierType" : "",
      "refAccountIdentifier" : "",
      "referAccountId" : "",
      "referDealIdentifier" : "",
      "referenceDealId" : "",
      "referenceModelId" : "",
      "referUsageSw" : "",
      "referPriceSw" : "",
      "includeChildHierarchy" : "",
    }
  }
}

```

Related Topics

For more information on...	See...
Deal creation request and response attribute/value pairs in the JSON format	Deal Creation Request and Response - Attribute Value Pairs in the JSON Format on page 4087
Sample deal creation request and response in the JSON format	Sample Deal Creation Request and Response in the JSON Format on page 4141

Deal Creation Response in the JSON Format

The following code snippet illustrates how the attribute/value pairs should be structured while sending the deal creation response in the JSON Format.

```

{
  "Cl-DealCreationUpdateIWS" :
  {
    "actionFlag" : "",
    "dealDetails"
    {
      "dealEntityDetails"
      {
        "personIdentifierType" : "",
        "personIdentifier" : "",
        "personId" : "",
        "accountIdentifierType" : "",
        "accountIdentifier" : "",
        "accountId" : "",
        "prsPerIdentifierType" : "",
        "prsPerIdentifier" : "",
        "prospectPersonId" : "",
        "division" : "",
      }
      "dealIdentifier" : "",
      "dealInformation" : "",
      "dealId" : "",
      "modelId" : "",
      "dealEntityType" : "",
      "customerSegment" : "",
      "customerTier" : "",
    }
  }
}

```

```

    "division" : "",
    "accessGrp" : "",
    "dealEntityId" : "",
    "contractedDealFlag" : "",
    "currency" : "",
    "dealTypeCode" : "",
    "startDate" : "",
    "endDate" : "",
    "simulationTypeFlag" : "",
    "reviewFrequency" : "",
    "dealDescription" : "",
    "longDescription" : "",
    "dealVersionDescription" : "",
    "dealFrequency" : "",
    "skipReferenceFlag" : "",
    "priceSelectionDate" : "",
    "usagePeriod" : "",
    "includeHierarchyFlag" : "",
    "status" : "",
    "dealVersionStatus" : "",
    "templateFlag" : "",
  }
  "templateReferenceDetails"
  {
    "templateDealId" : "",
    "templateDealIdentifier" : "",
    "templateModelId" : "",
    "copyBasicDetailsFlag" : "",
    "copyPricingFlag" : "",
    "copyUsageFlag" : "",
  }
  "dealCharacteristics"
  {
    "characteristicType" : "",
    "effectiveDate" : "",
    "characteristicValue" : "",
  }
  "dealTermsAndConditionsDetails"
  {
    "termsAndConditionsList"
    {
      "description mapField="DESCR"/>
      "termsAndCondition fkRef="TERMNCON" mapField="TC_TYPE_CD"/>
      "termsAndConditionText mapField="LONG_DESC"/>
    }
    "adhocTermsAndCondition" : "",
  }
  "productDetailsList"
  {
    "productCode" : "",
  }
  "referenceDetails"
  {
    "referenceTypeFlg" : "",
    "refPersonIdentifierType" : "",
    "refPersonIdentifier" : "",
    "referPersonId" : "",
    "refAccountIdentifierType" : "",
    "refAccountIdentifier" : "",
    "referAccountId" : "",
    "referDealIdentifier" : "",
    "referenceDealId" : "",
    "referenceModelId" : "",
    "referUsageSw" : "",
  }

```

```

    "referPriceSw" : "",
    "includeChildHierarchy" : "",
    "division" : "",
  }
}
}

```

Related Topics

For more information on...	See...
Deal creation request and response attribute/value pairs in the JSON format	Deal Creation Request and Response - Attribute Value Pairs in the JSON Format on page 4087
Sample deal creation request and response in the JSON format	Sample Deal Creation Request and Response in the JSON Format on page 4141

Deal Update Request in the JSON Format

The following code snippet illustrates how the tags should be nested while sending the deal update request in the JSON format:

```

{
  "C1-DealCreationUpdateIWS" :
  {
    "actionFlag" : "",
    "dealOperation"
    {
      "operationFlag" : "",
      "dealIdentifier" : "",
      "dealId" : "",
      "modelId" : "",
      "dealAcceptEffStartDate" : "",
      "dealAcceptEffEndDate" : "",
      "comments" : "",
      "rejectReasonCode" : "",
    }
    "priceItemGroupSelection"
    {
      "priceItemSelectionList"
      {
        "priceItemCode" : "",
        "priceItemInfo" : "",
        "parameterInfo" : "",
        "assignmentLevel" : "",
        "priceAssignmentId" : "",
        "hierarchyDetails" : "",
        "includeFlag" : "",
      }
    }
  }
  "dealDetails"
  {
    "dealEntityDetails"
    {
      "personIdentifierType" : "",
      "personIdentifier" : "",
      "personId" : "",
      "accountIdentifierType" : "",
      "accountIdentifier" : "",
      "accountId" : "",
      "prsPerIdentifierType" : "",
      "prsPerIdentifier" : "",
      "prospectPersonId" : "",
    }
  }
}

```



```

        "division" : "",
    }
    "dealIdentifier" : "",
    "dealInformation" : "",
    "dealId" : "",
    "modelId" : ""
    "dealEntityType" : "",
    "customerSegment" : "",
    "customerTier" : "",
    "division" : "",
    "accessGrp" : "",
    "dealEntityId" : "",
    "contractedDealFlag" : "",
    "currency" : "",
    "dealTypeCode" : "",
    "startDate" : "",
    "endDate" : "",
    "simulationTypeFlag" : "",
    "reviewFrequency" : "",
    "dealDescription" : "",
    "dealVersionDescription" : "",
    "dealFrequency" : "",
    "skipReferenceFlag" : "",
    "priceSelectionDate" : "",
    "usagePeriod" : "",
    "includeHierarchyFlag" : "",
    "status" : "",
    "dealVersionStatus" : "",
    "templateFlag" : "",
}
"templateReferenceDetails"
{
    "templateDealId" : "",
    "templateDealIdentifier" : "",
    "templateModelId" : "",
    "copyBasicDetailsFlag" : "",
    "copyPricingFlag" : "",
    "copyUsageFlag" : "",
}
"dealCharacteristics"
{
    "characteristicType" : "",
    "effectiveDate" : "",
    "characteristicValue" : "",
}
"dealTermsAndConditionsDetails"
{
    "termsAndConditionsList"
    {
        "description mapField="DESCR"/>
        "termsAndCondition fkRef="TERMNCON" mapField="TC_TYPE_CD"/>
        "termsAndConditionText mapField="LONG_DESC"/>
    }
    "adhocTermsAndCondition" : "",
}
"productDetailsList"
{
    "productCode" : "",
}
"referenceDetails"
{
    "referenceTypeFlg" : "",
    "refPersonIdentifierType" : "",
    "refPersonIdentifier" : "",
}

```

```

    "referPersonId" : "",
    "refAccountIdentifierType" : "",
    "refAccountIdentifier" : "",
    "referAccountId" : "",
    "referDealIdentifier" : "",
    "referenceDealId" : "",
    "referenceModelId" : "",
    "referUsageSw" : "",
    "referPriceSw" : "",
    "includeChildHierarchy" : "",
    "division" : "",
  }
}

```

Related Topics

For more information on...	See...
Deal update request and response - attribute/value pairs in the JSON format	Deal View Request and Response - Attribute/Value Pairs in the JSON Format on page 4128
Sample deal update request and response in the JSON format	Sample Deal Update Request and Response in the JSON Format on page 4145
Sample deal version creation request and response in the JSON format	Sample Deal Version Creation Request and Response in the JSON Format on page 4148
Sample deal simulation request and response in the JSON format	Sample Deal Simulation Request and Response in the JSON Format on page 4150
Sample deal submission for approval request and response in the JSON format	Sample Deal Submission for Approval Request and Response in the JSON Format on page 4154
Sample deal approval request and response in the JSON format	Sample Deal Approval Request and Response in the JSON Format on page 4156
Sample deal return to submitter request and response in the JSON format	Sample Deal Return to Submitter Request and Response in the JSON Format on page 4158
Sample deal finalization request and response in the JSON format	Sample Deal Finalization Request and Response in the JSON Format on page 4160
Sample deal acceptance request and response in the JSON format	Sample Deal Acceptance Request and Response in the JSON Format on page 4162
Sample deal rejection request and response in the JSON format	Sample Deal Rejection Request and Response in the JSON Format on page 4164
Sample price item selection request and response in the JSON format	Sample Price Item Selection Request and Response in the JSON Format on page 4169

Deal Update Response in the JSON Format

The following code snippet illustrates how the tags should be nested while sending the deal update response in the JSON format:

```

{
  "Cl-DealCreationUpdateIWS" :
  {
    "actionFlag" : "",
    "dealResponse"
    {
      "message" : "",
    }
  }
}

```

```

}
"dealOperation"
{
  "operationFlag" : "",
  "dealIdentifier" : "",
  "dealId" : "",
  "modelId" : "",
  "dealAcceptEffStartDate" : "",
  "dealAcceptEffEndDate" : "",
  "comments" : "",
  "rejectReasonCode" : "",
}
"priceItemGroupSelection"
{
  "priceItemSelectionList"
  {
    "priceItemCode" : "",
    "priceItemInfo" : "",
    "parameterInfo" : "",
    "assignmentLevel" : "",
    "priceAssignmentId" : "",
    "hierarchyDetails" : "",
    "includeFlag" : "",
  }
}
"dealDetails"
{
  "dealEntityDetails"
  {
    "personIdentifierType" : "",
    "personIdentifier" : "",
    "personId" : "",
    "accountIdentifierType" : "",
    "accountIdentifier" : "",
    "accountId" : "",
    "prsPerIdentifierType" : "",
    "prsPerIdentifier" : "",
    "prospectPersonId" : "",
    "division" : "",
  }
  "dealIdentifier" : "",
  "dealInformation" : "",
  "dealId" : "",
  "modelId" : "",
  "dealEntityType" : "",
  "customerSegment" : "",
  "customerTier" : "",
  "division" : "",
  "accessGrp" : "",
  "dealEntityId" : "",
  "contractedDealFlag" : "",
  "currency" : "",
  "dealTypeCode" : "",
  "startDate" : "",
  "endDate" : "",
  "simulationTypeFlag" : "",
  "reviewFrequency" : "",
  "dealDescription" : "",
  "longDescription" : "",
  "dealVersionDescription" : "",
  "dealFrequency" : "",
  "skipReferenceFlag" : "",
  "priceSelectionDate" : "",
  "usagePeriod" : "",
}

```

```

    "includeHierarchyFlag" : "",
    "status" : "",
    "dealVersionStatus" : "",
    "templateFlag" : "",
    "createdDate" : "",
    "acceptanceDate" : "",
    "finalizedDate" : "",
    "effectiveStartDate" : "",
    "effectiveEndDate" : "",
    "reviewedDate" : "",
  }
  "templateReferenceDetails"
  {
    "templateDealId" : "",
    "templateDealIdentifier" : "",
    "templateModelId" : "",
    "copyBasicDetailsFlag" : "",
    "copyPricingFlag" : "",
    "copyUsageFlag" : "",
  }
  "dealCharacteristics"
  {
    "characteristicType" : "",
    "effectiveDate" : "",
    "characteristicValue" : "",
  }
  "dealTermsAndConditionsDetails"
  {
    "termsAndConditionsList"
    {
      "description mapField="DESCR"/>
      "termsAndCondition fkRef="TERMNCON" mapField="TC_TYPE_CD"/>
      "termsAndConditionText mapField="LONG_DESC"/>
    }
    "adhocTermsAndCondition" : "",
  }
  "productDetailsList"
  {
    "productCode" : "",
  }
  "referenceDetails"
  {
    "referenceTypeFlg" : "",
    "refPersonIdentifierType" : "",
    "refPersonIdentifier" : "",
    "referPersonId" : "",
    "refAccountIdentifierType" : "",
    "refAccountIdentifier" : "",
    "referAccountId" : "",
    "referDealIdentifier" : "",
    "referenceDealId" : "",
    "referenceModelId" : "",
    "referUsageSw" : "",
    "referPriceSw" : "",
    "includeChildHierarchy" : "",
    "division" : "",
  }
  "dealSimulationDetails"
  {
    "dealfinancialsummarylist"
    {
      "approvalStatus" : "",
    }
    "originalDealFinancialSummary"

```

```

    {
      "revenue" : "",
      "cost" : "",
      "profit" : "",
      "profitabilityPercentage" : "",
    }
    "proposedDealFinanciencialSummary"
  {
    "revenue" : "",
    "cost" : "",
    "profit" : "",
    "profitabilityPercentage" : "",
  }
  "recommenedDealFinanciencialSummary"
  {
    "revenue" : "",
    "profit" : "",
    "profitabilityPercentage" : "",
  }
  "profitVariationPercentage" : "",
}
"divisionFinancialSummaryDetails"
{
  "division" : "",
  "approvalStatus" : "",
  "originalDivisionFinanciencialSummary"
  {
    "revenue" : "",
    "cost" : "",
    "profit" : "",
    "profitabilityPercentage" : "",
  }
  "proposedDivisionFinanciencialSummary"
  {
    "revenue" : "",
    "cost" : "",
    "profit" : "",
    "profitabilityPercentage" : "",
  }
  "recommenedDealFinanciencialSummary"
  {
    "revenue" : "",
    "profit" : "",
    "profitabilityPercentage" : "",
  }
  "profitVariationPercentage" : "",
}
"productFinancialSummaryDetails"
{
  "approvalStatus" : "",
  "product" : "",
  "division" : "",
  "originalProductFinanciencialSummary"
  {
    "revenue" : "",
    "cost" : "",
    "profit" : "",
    "profitabilityPercentage" : "",
  }
  "proposedProductDivisionFinanciencialSummary"
  {
    "revenue" : "",
    "cost" : "",
    "profit" : "",
  }
}

```

For more information on...	See...
Sample price item selection request and response in the JSON format	Sample Price Item Selection Request and Response in the JSON Format on page 4169

Deal View Request in the JSON Format

The following code snippet illustrates how the attributes should be structured while sending the deal view request in the JSON format:

```
{
  "C1-DealCreationUpdateIWS":
  {
    "actionFlag" : "",
    "dealOperation"
    {
      "operationFlag" : "",
      "dealIdentifier" : "",
      "dealId" : "",
      "modelId" : "",
    }
    "dealDetails":
    {
      "dealIdentifier" : "",
      "dealId" : "",
      "modelId" : "",
    }
  }
}
```

Related Topics

For more information on...	See...
Deal view request and response - attribute/value pairs in the JSON format	Deal View Request and Response - Attribute/Value Pairs in the JSON Format on page 4128
Sample deal view request and response in the JSON format	Sample Deal View Request Response in JSON Format on page 4143
Sample price item selection view request and response in the JSON format	Sample Price Item Selection View Request and Response in the JSON Format on page 4167

Deal View Request in the JSON Format

The following code snippet illustrates how the attributes should be structured while sending the deal view request in the JSON format:

```
{
  "C1-DealCreationUpdateIWS":
  {
    "actionFlag" : "",
    "dealOperation"
    {
      "operationFlag" : "",
      "dealIdentifier" : "",
      "dealId" : "",
      "modelId" : "",
      "dealAcceptEffStartDate" : "",
      "dealAcceptEffEndDate" : "",
      "comments" : "",
      "rejectReasonCode" : "",
    }
  }
}
```

```

}
"priceItemGroupSelection"
{
  "priceItemSelectionList"
  {
    "priceItemCode" : "",
    "priceItemInfo" : "",
    "parameterInfo" : "",
    "assignmentLevel" : "",
    "priceAssignmentId" : "",
    "hierarchyDetails" : "",
    "includeFlag" : "",
  }
}
"dealDetails"
{
  "dealEntityDetails"
  {
    "personIdentifierType" : "",
    "personIdentifier" : "",
    "personId" : "",
    "accountIdentifierType" : "",
    "accountIdentifier" : "",
    "accountId" : "",
    "prsPerIdentifierType" : "",
    "prsPerIdentifier" : "",
    "prospectPersonId" : "",
    "division" : "",
  }
  "dealIdentifier" : "",
  "dealInformation" : "",
  "dealId" : "",
  "modelId" : "",
  "dealEntityType" : "",
  "customerSegment" : "",
  "customerTier" : "",
  "division" : "",
  "accessGrp" : "",
  "dealEntityId" : "",
  "contractedDealFlag" : "",
  "currency" : "",
  "dealTypeCode" : "",
  "startDate" : "",
  "endDate" : "",
  "simulationTypeFlag" : "",
  "reviewFrequency" : "",
  "dealDescription" : "",
  "longDescription" : "",
  "dealVersionDescription" : "",
  "dealFrequency" : "",
  "skipReferenceFlag" : "",
  "priceSelectionDate" : "",
  "usagePeriod" : "",
  "includeHierarchyFlag" : "",
  "status" : "",
  "dealVersionStatus" : "",
  "templateFlag" : "",
  "createdDate" : "",
  "acceptanceDate" : "",
  "finalizedDate" : "",
  "effectiveStartDate" : "",
  "effectiveEndDate" : "",
  "reviewedDate" : "",
}
}

```



```

"templateReferenceDetails"
{
  "templateDealId" : "",
  "templateDealIdentifier" : "",
  "templateModelId" : "",
  "copyBasicDetailsFlag" : "",
  "copyPricingFlag" : "",
  "copyUsageFlag" : "",
}
"dealCharacteristics"
{
  "characteristicType" : "",
  "effectiveDate" : "",
  "characteristicValue" : "",
}
"dealTermsAndConditionsDetails"
{
  "termsAndConditionsList"
  {
    "description mapField="DESCR"/>
    "termsAndCondition fkRef="TERMNCON" mapField="TC_TYPE_CD"/>
    "termsAndConditionText mapField="LONG_DESC"/>
  }
  "adhocTermsAndCondition" : "",
}
"productDetailsList"
{
  "productCode" : "",
}
"referenceDetails"
{
  "referenceTypeFlg" : "",
  "refPersonIdentifierType" : "",
  "refPersonIdentifier" : "",
  "referPersonId" : "",
  "refAccountIdentifierType" : "",
  "refAccountIdentifier" : "",
  "referAccountId" : "",
  "referDealIdentifier" : "",
  "referenceDealId" : "",
  "referenceModelId" : "",
  "referUsageSw" : "",
  "referPriceSw" : "",
  "includeChildHierarchy" : "",
  "division" : "",
}
"dealSimulationDetails"
{
  "dealfinancialsummarylist"
  {
    "approvalStatus" : "",
  }
  "originalDealFinanciancialSummary"
  {
    "revenue" : "",
    "cost" : "",
    "profit" : "",
    "profitabilityPercentage" : "",
  }
  "proposedDealFinanciancialSummary"
  {
    "revenue" : "",
    "cost" : "",
    "profit" : "",
  }
}

```

```

        "profitabilityPercentage" : "",
    }
    "recommenedDealFinanciencialSummary"
    {
        "revenue" : "",
        "profit" : "",
        "profitabilityPercentage" : "",
    }
    "profitVariationPercentage" : "",
}
"divisionFinancialSummaryDetails"
{
    "division" : "",
    "approvalStatus" : "",
    "originalDivisionFinanciencialSummary"
    {
        "revenue" : "",
        "cost" : "",
        "profit" : "",
        "profitabilityPercentage" : "",
    }
    "proposedDivisionFinanciencialSummary"
    {
        "revenue" : "",
        "cost" : "",
        "profit" : "",
        "profitabilityPercentage" : "",
    }
    "recommenedDealFinanciencialSummary"
    {
        "revenue" : "",
        "profit" : "",
        "profitabilityPercentage" : "",
    }
    "profitVariationPercentage" : "",
}
"productFinancialSummaryDetails"
{
    "approvalStatus" : "",
    "product" : "",
    "division" : "",
    "originalProductFinanciencialSummary"
    {
        "revenue" : "",
        "cost" : "",
        "profit" : "",
        "profitabilityPercentage" : "",
    }
    "proposedProductDivisionFinanciencialSummary"
    {
        "revenue" : "",
        "cost" : "",
        "profit" : "",
        "profitabilityPercentage" : "",
    }
    "recommenedDealFinanciencialSummary"
    {
        "revenue" : "",
        "profit" : "",
        "profitabilityPercentage" : "",
    }
    "profitVariationPercentage" : "",
}
}
}

```

```

    "hierarchySimulationDetails"
    {
        "hierarchyDetails"
        {
            "entityType" : "",
            "entityId" : "",
            "parentEntityId" : "",
            "status" : "",
            "revenueVariation" : "",
            "proposedRevenue" : "",
            "proposedCost" : "",
            "originalRevenue" : "",
            "originalCost" : ""
        }
    }
}

```

Related Topics

For more information on...	See...
Deal view request and response - attribute/value pairs in the JSON format	Deal View Request and Response - Attribute/Value Pairs in the JSON Format on page 4128
Sample deal view request and response in the JSON format	Sample Deal View Request Response in JSON Format on page 4143
Sample price item selection view request and response in the JSON format	Sample Price Item Selection View Request and Response in the JSON Format on page 4167

Deal Creation Request and Response - Attribute Value Pairs in the JSON Format

Note: We recommend you to refer the topics [Deal Creation Request in the JSON Format](#) on page 4072 and [Deal Creation Response in the JSON Format](#) on page 4074 in parallel while understanding the below mentioned attributes. This will help you to understand how the attributes are structured in the JSON format.

Before calling the **C1-DealCreationUpdateIWS** business service through an inbound web service, you need to ensure that the deal creation request contains the following attributes:

Attribute Name	Attribute Description	Mandatory (Yes or No)
actionFlag	Used to indicate that you want to create a deal for an entity (i.e. existing person, account, or prospect person) in the system. The valid value is: <ul style="list-style-type: none"> ADD <p>Note: If you do not specify the value in this attribute, by default, the system considers it as an ADD action.</p>	Yes
dealDetails	Used to specify basic information about the deal.	Yes
dealEntityDetails	Used to specify basic information about the entity (i.e. existing person, account, or prospect person) for which you want to create a deal.	Yes

Attribute Name	Attribute Description	Mandatory (Yes or No)
personIdentifierType	Used to indicate the identifier type using which the person is created in the system.	Yes (Conditional)
	<p>Note:</p> <p>If you specify the personIdentifier attribute, you need to specify the personIdentifierType attribute.</p> <p>If you specify the personIdentifier attribute and do not specify the personIdentifierType attribute, the system will throw an error message indicating that the person identifier type field is missing.</p> <p>If you specify the personIdentifierType attribute, you need not specify the personId attribute.</p>	<p>Note: This data is required while creating a deal for an existing person i.e. when the value of the dealEntityType attribute is set to EPER.</p>
personIdentifier	Used to specify the value for the person identifier type.	Yes (Conditional)
	<p>Note:</p> <p>If you specify the personIdentifierType attribute, you need to specify the personIdentifier attribute.</p> <p>If you specify the personIdentifierType attribute and do not specify the personIdentifier attribute, the system will throw an error message indicating that the person identifier field is missing.</p> <p>If you specify the personIdentifier attribute, you need not specify the personId attribute.</p>	<p>Note: This data is required while creating a deal for an existing person i.e. when the value of the dealEntityType attribute is set to EPER.</p>
personId	Used to specify the existing person for whom you want to create a deal in the system.	Yes (Conditional)
	<p>Note:</p> <p>If you specify the personId attribute, you need not specify the personIdentifierType and the personIdentifier attributes.</p> <p>If the personId attribute is not valid, the system will throw an error message indicating that the person ID is invalid.</p> <p>Based on the specified value in the personId attribute, the system fetches the values of the person's division, accessGrp, customerSegment, and customerTier attributes.</p>	<p>Note: This data is required while creating a deal for an existing person i.e. when the value of the dealEntityType attribute is set to EPER.</p>

Attribute Name	Attribute Description	Mandatory (Yes or No)
accountIdentifierType	<p>Used to indicate the identifier type using which the account is created in the system.</p> <p>Note:</p> <p>If you specify the accountIdentifier attribute, you need to specify the accountIdentifierType attribute.</p> <p>If you specify the accountIdentifier attribute and do not specify the accountIdentifierType attribute, the system will throw an error message indicating that the account identifier type field is missing.</p> <p>If you specify the accountIdentifierType attribute, you need not specify the accountId attribute.</p>	<p>Yes (Conditional)</p> <p>Note: This data is required while creating a deal for an existing account i.e. when the value of the dealEntityType attribute is set to EACC.</p>
accountIdentifier	<p>Used to specify the value for the account identifier type.</p> <p>Note:</p> <p>If you specify the accountIdentifierType attribute, you need to specify the accountIdentifier attribute.</p> <p>If you specify the accountIdentifierType attribute and do not specify the accountIdentifier attribute, the system will throw an error message indicating that the account identifier field is missing.</p> <p>If you specify the accountIdentifier attribute, you need not specify the accountId attribute.</p>	<p>Yes (Conditional)</p> <p>Note: This data is required while creating a deal for an existing account i.e. when the value of the dealEntityType attribute is set to EACC.</p>
accountId	<p>Used to specify the existing account for which you want to create a deal in the system.</p> <p>Note:</p> <p>If you specify the accountId attribute, you need not specify the accountIdentifierType and the accountIdentifier attributes.</p> <p>If the accountId attribute is not valid, the system will throw an error message indicating that the account ID is invalid.</p> <p>Based on the specified value in the accountId attribute, the system fetches the account's main person ID and further fetches the values of the division, accessGrp, customerSegment, and customerTier attributes.</p>	<p>Yes (Conditional)</p> <p>Note: This data is required while creating a deal for an existing account i.e. when the value of the dealEntityType attribute is set to EACC.</p>

Attribute Name	Attribute Description	Mandatory (Yes or No)
prsPerIdentifierType	<p>Used to indicate the identifier type using which the prospect person is created in the system.</p> <p>Note:</p> <p>If you specify the prsPerIdentifier attribute, you need to specify the prsPerIdentifierType attribute.</p> <p>If you specify the prsPerIdentifier attribute and do not specify the prsPerIdentifierType attribute, the system will throw an error message indicating that the prospect person identifier type field is missing.</p> <p>If you specify the prsPerIdentifierType attribute, you need not specify the prospectPersonId attribute.</p>	<p>Yes (Conditional)</p> <p>Note: This data is required while creating a deal for a prospect person i.e. when the value of the dealEntityType attribute is set to PRSP.</p>
prsPerIdentifier	<p>Used to specify the value for the prospect person identifier type.</p> <p>Note:</p> <p>If you specify the prsPerIdentifierType attribute, you need to specify the prsPerIdentifier attribute.</p> <p>If you specify the prsPerIdentifierType attribute and do not specify the prsPerIdentifier attribute, the system will throw an error message indicating that the prospect person identifier field is missing.</p> <p>If you specify the prsPerIdentifier attribute, you need not specify the prospectPersonId attribute.</p>	<p>Yes (Conditional)</p> <p>Note: This data is required while creating a deal for a prospect person i.e. when the value of the dealEntityType attribute is set to PRSP.</p>
prospectPersonId	<p>Used to specify the prospect person for whom you want to create a deal in the system.</p> <p>Note:</p> <p>If you specify the prospectPersonId attribute, you need not specify the prsPerIdentifierType and the prsPerIdentifier attributes.</p> <p>If the prospectPersonId attribute is not valid, the system will throw an error message indicating that the prospect person ID is invalid.</p> <p>Based on the specified value in the prospectPersonId attribute, the system fetches the values of prospect person's division, accessGrp, customerSegment, and customerTier attributes.</p>	<p>Yes (Conditional)</p> <p>Note: This data is required while creating a deal for a prospect person i.e. when the value of the dealEntityType attribute is set to PRSP.</p>

Attribute Name	Attribute Description	Mandatory (Yes or No)
division	<p>Used to indicate the division to which the entity (i.e. existing person, account, or prospect person) belongs.</p> <p>Note: You must specify a division which is already defined in the system.</p> <p>If you do not specify the division attribute while specifying the identifier type and identifier of the entity (i.e. existing customer, account, or prospect customer), the system throws an error message indicating that the division is mandatory when identifier type and identifier is provided.</p>	<p>Yes (Conditional)</p> <p>Note: This data is required while creating a deal for an entity (i.e. existing customer, account, or prospect customer) by specifying the entity's identifier type and identifier.</p>
dealIdentifier	<p>Used to specify the primary identifier using which you want to create the deal in the system.</p> <p>Note: You should ensure that every deal has a unique deal identifier.</p> <p>An error message appears when you save a deal with a deal identifier which is already used while creating a deal.</p>	Yes
dealEntityType	<p>Used to indicate the type of entity for which you want to create a deal. The valid values are:</p> <ul style="list-style-type: none"> • EPER - Used to indicate that you want to create deal for an existing person. <p>Note: If you specify the dealEntityType attribute as EPER, you must specify either the personId attribute or the personIdentifierType, personIdentifier, and division attributes.</p> <p>If you do not specify the personId attribute, the system will validate the combination of the values provided in the personIdentifierType, personIdentifier, and division attributes. If the combination is valid, the system will derive the person ID and continue the deal creation process. Whereas, if the combination is invalid, the system will throw an error message indicating that the person is not found.</p> <ul style="list-style-type: none"> • EACC - Used to indicate that you want to create deal for an existing account. 	Yes

Attribute Name	Attribute Description	Mandatory (Yes or No)
	<p>Note:</p> <p>If you specify the dealEntityType attribute as EACC, you must specify either the accountId attribute or the accountIdentifierType, accountIdentifier, and division attributes.</p> <p>If you do not specify the accountId attribute, the system will validate the combination of the values provided in the accountIdentifierType, accountIdentifier, and division attributes. If the combination is valid, the system will derive the account's main person ID and continue the deal creation process. Whereas, if the combination is invalid, the system will throw an error message indicating that the account is not found.</p> <ul style="list-style-type: none"> • PRSP - Used to indicate that you want to create deal for a prospect person. <p>Note:</p> <p>If you specify the dealEntityType attribute as PRSP, you must specify either the prospectPersonId attribute or the prsPerIdentifierType, prsPerIdentifier, and division attributes.</p> <p>If you do not specify the prospectPersonId attribute, the system will validate the combination of the values provided in the prsPerIdentifierType, prsPerIdentifier, and division attributes. If the combination is valid, the system will derive the prospect person ID and continue the deal creation process. Whereas, if the combination is invalid, the system will throw an error message indicating that the prospect person is not found.</p> <p>Note: If you do not specify the value of the dealEntityType attribute, the system will throw an error message indicating that the Deal Entity Type Flag field is missing.</p>	
contractedDealFlag	Used to indicate that the change in the price item pricing from the price list does not affect the price item pricing offered in the deal created	Yes

Attribute Name	Attribute Description	Mandatory (Yes or No)
	for the entity (i.e. existing person, account, or prospect person). The valid values are: <ul style="list-style-type: none"> • true • false 	
currency	Used to specify the currency in which you want to calculate the deal level, division level, or product level financial summary and profitability of the deal. Note: You can specify only those currencies which are already defined in the system.	Yes
dealTypeCode	Used to specify the deal type using which you want to create the deal in the system. Note: If you specify a value in the dealTypeCode attribute, the customer segment, customer tier, and division of the specified deal type is validated against the customerSegment , customerTier , and division attributes specified in the deal creation request using the GETDEALTYPE business service. If the deal type is validated successfully, the system will continue the deal creation process. Whereas, if the deal type is invalid, the system will throw an error message indicating that the deal type is invalid.	Yes
startDate	Used to specify the date from when the deal is effective for the entity (i.e. existing person, account, or prospect person). Note: This date is also used as the effective start date for the proposed price list assignment and start date for the proposed product enrollment.	Yes
endDate	Used to specify the date till when the deal is effective for the entity (i.e. existing person, account, or prospect person).	No
simulationTypeFlag	Used to indicate the simulation type using which you want to analyze the cost, revenue, and profitability of the deal. The valid values are: <ul style="list-style-type: none"> • CUST • ACCT • DEAL 	Yes

Attribute Name	Attribute Description	Mandatory (Yes or No)
reviewFrequency	<p>Used to specify the timely monitoring of the deal usage as per the commitments made by the customer. The valid values are:</p> <ul style="list-style-type: none"> • 6 - Used to indicate that you want to monitor the deal usage biannually • 12 - Used to indicate that you want to monitor the deal usage annually • 24 - Used to indicate that you want to monitor the deal usage in every two years 	No
dealDescription	Used to specify the description for the deal.	No
dealVersionDescription	Used to specify the description for the deal version.	No
dealFrequency	<p>Used to indicate the duration in which you want to simulate the deal for calculating the financial summary and profitability of the deal. The valid values are:</p> <ul style="list-style-type: none"> • 1 - Used to indicate that you want to simulate the deal every month • 3 - Used to indicate that you want to simulate the deal quarterly • 6 - Used to indicate that you want to simulate the deal biannually • 12 - Used to indicate that you want to simulate the deal annually 	Yes
skipReferenceFlag	<p>Used to specify whether you want to use a deal which is already created in the system as a reference for copying the pricing and commitments in the deal or not. The valid values are:</p> <ul style="list-style-type: none"> • true • false <div style="border: 1px solid black; padding: 5px; margin-top: 10px;"> <p>Note:</p> <p>If you do not specify a value in the skipReferenceFlag attribute, by default, the system considers it as false.</p> <p>If you specify the value in the skipReferenceFlag attribute as false, you need to specify the reference deal details. The system will then copy the reference deal details using the C1-ReferePriceVolumeAdd business service.</p> </div>	No

Attribute Name	Attribute Description	Mandatory (Yes or No)
priceSelectionDate	Used to specify the date from when the price lists, pricing assignments, and product enrollments are effective for simulation.	Yes
usagePeriod	<p>Used to indicate the period for which you want to aggregate the deal data to determine the scope of the deal. The valid values are:</p> <ul style="list-style-type: none"> • 1 - Used to indicate that you want to aggregate the deal data every month • 3 - Used to indicate that you want to aggregate the deal data quarterly • 6 - Used to indicate that you want to aggregate the deal data biannually • 12 - Used to indicate that you want to aggregate the deal data annually 	Yes
includeHierarchyFlag	<p>Used to indicate whether you want to include the child persons, grandchild persons, and their accounts in the customer hierarchy while creating a deal. The valid values are:</p> <ul style="list-style-type: none"> • true • false <p>Note: If you do not specify a value in the includeHierarchyFlag attribute, by default, the system considers it as false.</p> <p>You can specify the value in the includeHierarchyFlag attribute as true only when the dealEntityType attribute is set to EPER and the simulationTypeFlag attribute is set to CUST.</p> <p>You cannot specify the value in the includeHierarchyFlag as false when the value in the dealEntityType attribute is set to PRSP and the simulationTypeFlag attribute is set to CUST. In such case, the system will throw an error message indicating that you must set the include hierarchy flag to true when deal entity type is PRSP and simulation type is CUST.</p>	<p>Yes (Conditional)</p> <p>Note: This data is required while specifying the deal details to create a deal for an existing or prospect person.</p>
templateFlag	<p>Use to indicate whether you want the deal to be used as a template while searching references for other deals. The valid values are:</p> <ul style="list-style-type: none"> • true • false 	No

Attribute Name	Attribute Description	Mandatory (Yes or No)
	<p>Note:</p> <p>Users who belong to the user group which has the Change access mode provided for the C1-DEALTEMPLATE application service can create the deal templates in the system.</p> <p>If you specify the value in the templateFlag attribute as true and you do not belong to the user group which has the Change access mode provided for the C1-DEALTEMPLATE application service, the system will throw an error message indicating that you do not have security rights to create a deal template.</p>	
templateReferenceDetails	<p>Used to specify the template deal details which you want to use for creating a deal for the entity (i.e. existing person, account, or prospect person).</p> <p>Note: Template deal information such as, Deal type, Price Selection Date, End Date, Simulation Type, Currency, Include Hierarchy, Contracted deal, Review Frequency, Deal Frequency, Skip Reference, Usage Period, Deal Description and Deal Version Description are copied when you use a template deal as a reference to create a deal for an entity (i.e. existing person, account, or prospect person).</p>	No
templateDealId	<p>Used to specify the template deal which you want to use for creating a deal for the entity (i.e. existing person, account, or prospect person).</p> <p>Note:</p> <p>If you specify the templateDealId attribute, you need not specify the templateDealIdentifier and templateModelId attributes.</p> <p>If the specified template deal has multiple versions, the system will throw an error message indicating that multiple deal versions exist for the deal ID in the system. In such case, you need to specify the templateModelId attribute of the template deal instead of the templateDealId attribute.</p> <p>If the value specified in the templateDealId attribute is invalid, the system will throw an error message indicating that the deal template is invalid.</p>	<p>Yes (Conditional)</p> <p>Note: This data is required while specifying the template deal as a reference to create a deal for an entity (i.e. existing person, account, or prospect person).</p>

Attribute Name	Attribute Description	Mandatory (Yes or No)
templateDealIdentifier	<p>Used to specify the primary identifier using which the template deal is created in the system.</p> <p>Note:</p> <p>If you specify the templateDealIdentifier attribute, you need not specify the templateDealId and templateModelId attributes.</p> <p>If the specified template deal has multiple versions, the system will throw an error message indicating that multiple deal versions exist for the deal identifier in the system. In such case, you need to specify the templateModelId attribute of the template deal instead of the templateDealIdentifier attribute.</p> <p>If the value specified in the templateDealIdentifier attribute is invalid, the system will throw an error message indicating that the deal template is invalid.</p>	<p>Yes (Conditional)</p> <p>Note: This data is required while specifying the template deal as a reference to create a deal for an entity (i.e. existing person, account, or prospect person).</p>
templateModelId	<p>Used to specify the deal version which you want to use as a template for creating a deal for the entity (i.e. existing person, account, or prospect person).</p> <p>Note:</p> <p>If you specify the templateModelId attribute, you need not specify the templateDealId and templateDealIdentifier attributes.</p> <p>If the value specified in the templateModelId attribute is invalid, the system will throw an error message indicating that the deal template is invalid.</p>	<p>Yes (Conditional)</p> <p>Note: This data is required while specifying the template deal as a reference to create a deal for an entity (i.e. existing person, account, or prospect person).</p>
copyBasicDetailsFlag	<p>Used to indicate whether you want to copy the basic details from the template deal to the deal which you want to create for the entity (i.e. existing person, account, or prospect person). The valid values are:</p> <ul style="list-style-type: none"> • true • false 	<p>Yes (Conditional)</p> <p>Note: This data is required while specifying the template deal as a reference to create a deal for an entity (i.e. existing person, account, or prospect person).</p>

Attribute Name	Attribute Description	Mandatory (Yes or No)
	<p>Note:</p> <p>If you specify the values in the copyPricingFlag and copyUsageFlag attributes as false, you need to specify the value in the copyBasicDetailsFlag as true.</p> <p>Details such as, Deal Information, Deal Products, Deal Terms and Conditions and Deal Characteristics are copied from the template deal when you specify the copyBasicDetailsFlag as true.</p> <p>The Deal Information copied from the template deal gets overridden by the Deal Information specified by the user while creating a deal through the inbound web service.</p>	
copyPricingFlag	<p>Used to indicate whether you want to copy the price list assignments and price assignments from the template deal to the deal which you want to create for the entity (i.e. existing person, account, or prospect person). The valid values are:</p> <ul style="list-style-type: none"> • true • false <p>Note: If you specify the values in the copyBasicDetailsFlag and copyUsageFlag attributes as false, you need to specify the value in the copyPricingFlag as true.</p>	<p>Yes (Conditional)</p> <p>Note: This data is required while specifying the template deal as a reference to create a deal for an entity (i.e. existing person, account, or prospect person).</p>
copyUsageFlag	<p>Used to indicate whether you want to copy commitments from the SQI-based billable charges from the template deal to the deal which you want to create for the entity (i.e. existing person, account, or prospect person). The valid values are:</p> <ul style="list-style-type: none"> • true • false <p>Note: If you specify the values in the copyBasicDetailsFlag and copyPricingFlag attributes as false, you need to specify the value in the copyUsageFlag as true.</p>	<p>Yes (Conditional)</p> <p>Note: This data is required while specifying the template deal as a reference to create a deal for an entity (i.e. existing person, account, or prospect person).</p>
dealCharacteristics	Used to specify a list of characteristics for the deal.	No

Attribute Name	Attribute Description	Mandatory (Yes or No)
	<p>Note: If you create a deal using a template deal as a reference, the characteristics specified in the dealCharacteristics attribute will be added with the template deal characteristics.</p>	
characteristicType	<p>Used to indicate the characteristic type.</p> <p>Note: You can specify only those characteristic types where the characteristic entity is set to Deal. If the Characteristic Type of the template deal matches with the value specified in the characteristicType attribute, the system will override the template deal Characteristic Type.</p>	<p>Yes (Conditional)</p> <p>Note: This data is required while specifying a characteristic for the deal.</p>
effectiveDate	<p>Used to specify the date from when the characteristic is effective for the deal.</p>	<p>Yes (Conditional)</p> <p>Note: This data is required while specifying a characteristic for the deal.</p>
characteristicValue	<p>Used to specify the value for the characteristic type.</p>	<p>Yes (Conditional)</p> <p>Note: This data is required while specifying a characteristic for the deal.</p>
dealTermsAndConditionsDetails	<p>Used to specify a list of terms and conditions which you want to associate with the deal.</p> <p>Note: If you create a deal using a template deal as a reference, the deal terms and conditions specified in the dealTermsAndConditionsDetails attribute will be added with the template deal terms and conditions.</p>	<p>No</p>
termsAndConditionsList	<p>Used to specify the terms and conditions of the deal.</p>	<p>No</p>
description	<p>Used to specify the description of the terms and conditions.</p> <p>Note: If the value specified in the description attribute is not valid, the system will throw an error message indicating that the terms and conditions is invalid.</p>	<p>Yes (Conditional)</p> <p>Note: This data is required while associating terms and conditions with a deal.</p>
termsAndCondition	<p>Used to specify the terms and conditions which you want to associate with the deal.</p>	<p>Yes (Conditional)</p>

Attribute Name	Attribute Description	Mandatory (Yes or No)
	<p>Note: If the value specified in the termsAndCondition attribute is not valid, the system will throw an error message indicating that the terms and conditions is invalid.</p>	<p>Note: This data is required while associating terms and conditions with a deal.</p>
termsAndConditionText	Used to specify additional information about the terms and conditions.	No
adhocTermsAndCondition	Used to specify the adhoc terms and conditions which you want to associate with the deal.	No
productDetailsList	<p>Used to recommend a list of products for the deal.</p> <p>Note: If you create a deal using a template deal as a reference, the deal products specified in the productDetailsList attribute will be added with the template deal recommended products.</p>	No
productCode	Used to specify the product which you want to recommend for the deal.	<p>Yes (Conditional)</p> <p>Note: This data is required while recommending a product for the deal.</p>
referenceDetails	Used to specify the details of the reference deal using which you want to create the deal for the entity (i.e. existing person, account, or prospect person).	<p>Yes (Conditional)</p> <p>Note: This data is required while specifying the reference deal to create a deal for an entity (i.e. existing person, account, or prospect person).</p>
referenceTypeFlg	<p>Used to indicate the type of the reference deal using which you want to create the deal for the entity (i.e. existing person, account, or prospect person). The valid values are:</p> <ul style="list-style-type: none"> • RPER - Used to indicate that you want to use the deal of a person as a reference to create the deal for the existing person or the prospect person. 	<p>Yes (Conditional)</p> <p>Note: This data is required while specifying the reference deal to create a deal for an entity (i.e. existing person, account, or prospect person).</p>

Attribute Name	Attribute Description	Mandatory (Yes or No)
	<p>Note:</p> <p>If you specify the skipReferenceFlag attribute as false and the dealEntityType attribute as EPER or PRSP, you need to ensure that the referenceTypeFlg attribute is set to either RPER or RDEL.</p> <p>If you specify the referenceTypeFlg attribute as RPER, you must specify the values in either the referPersonId attribute or refPersonIdentifierType, refPersonIdentifier, and division attributes.</p> <ul style="list-style-type: none"> • RACC - Used to indicate that you want to use the deal of an account as a reference to create the deal for the existing account. <p>Note:</p> <p>If you specify the skipReferenceFlag attribute as false and the dealEntityType attribute as EACC, you need to ensure that the referenceTypeFlg attribute is set to either RACC or RDEL.</p> <p>If you specify the referenceTypeFlg attribute as RACC, you must specify the values in either the referAccountId attribute or refAccountIdentifierType, refAccountIdentifier, and division attributes.</p> <ul style="list-style-type: none"> • RDEL - Used to indicate that you want to use an existing deal as a reference to create the deal for the existing person, account or prospect person. <p>Note: If you specify the referenceTypeFlg attribute as RDEL, you must specify the values in either the referenceDealId, referDealIdentifier, or referenceModelId attribute.</p> <p>Note: If you do not specify the value of the referenceTypeFlg attribute and the skipReferenceFlag is set as false, the system will throw an error message indicating that the Reference Type Flag field is missing.</p>	
refPersonIdentifierType	Used to specify the identifier type of the person using which the reference deal is created in the system.	Yes (Conditional)

Attribute Name	Attribute Description	Mandatory (Yes or No)
	<p>Note:</p> <p>If you specify the refPersonIdentifier attribute, you need to specify the refPersonIdentifierType attribute.</p> <p>If you specify the refPersonIdentifier attribute and do not specify the refPersonIdentifierType attribute, the system will throw an error message indicating that the person identifier type in the reference section is missing.</p> <p>If you specify the refPersonIdentifierType attribute, you need not specify the referPersonId attribute.</p>	<p>Note: This data is required while specifying the reference deal to create a deal for an existing or prospect person.</p>
refPersonIdentifier	<p>Used to specify the value of the reference person identifier type.</p> <p>Note:</p> <p>If you specify the refPersonIdentifierType attribute, you need to specify the refPersonIdentifier attribute.</p> <p>If you specify the refPersonIdentifierType attribute and do not specify the refPersonIdentifier attribute, the system will throw an error message indicating that the person identifier in the reference section is missing.</p> <p>If you specify the refPersonIdentifier attribute, you need not specify the referPersonId attribute.</p>	<p>Yes (Conditional)</p> <p>Note: This data is required while specifying the reference deal to create a deal for an existing or prospect person.</p>
referPersonId	<p>Used to specify the person for whom the reference deal is created.</p> <p>Note:</p> <p>If you specify the referPersonId attribute, you need not specify the refPersonIdentifierType and the refPersonIdentifier attributes.</p> <p>If the referPersonId attribute is not valid, the system will throw an error message indicating that the referred person is invalid.</p> <p>Based on the specified value in the referPersonId attribute, the system fetches the reference deal details for the deal creation process.</p>	<p>Yes (Conditional)</p> <p>Note: This data is required while specifying the reference deal to create a deal for an existing or prospect person.</p>

Attribute Name	Attribute Description	Mandatory (Yes or No)
refAccountIdentifierType	<p>Used to specify the identifier type of the account using which the reference deal is created in the system.</p> <p>Note: If you specify the refAccountIdentifier attribute, you need to specify the refAccountIdentifierType attribute.</p> <p>If you specify the refAccountIdentifier attribute and do not specify the refAccountIdentifierType attribute, the system will throw an error message indicating that the account identifier type in the reference section is missing.</p> <p>If you specify the refAccountIdentifierType attribute, you need not specify the referAccountId attribute.</p>	<p>Yes (Conditional)</p> <p>Note: This data is required while specifying the reference deal to create a deal for an existing account.</p>
refAccountIdentifier	<p>Used to specify the value of the reference account identifier type.</p> <p>Note: If you specify the refAccountIdentifierType attribute, you need to specify the refAccountIdentifier attribute.</p> <p>If you specify the refAccountIdentifierType attribute and do not specify the refAccountIdentifier attribute, the system will throw an error message indicating that the account identifier in the reference section is missing.</p> <p>If you specify the refAccountIdentifier attribute, you need not specify the referAccountId attribute.</p>	<p>Yes (Conditional)</p> <p>Note: This data is required while specifying the reference deal to create a deal for an existing account.</p>
referAccountId	<p>Used to specify the account for which the reference deal is created.</p>	<p>Yes (Conditional)</p> <p>Note: This data is required while specifying the reference deal to create a deal for an existing account.</p>

Attribute Name	Attribute Description	Mandatory (Yes or No)
	<p>Note:</p> <p>If you specify the referAccountId attribute, you need not specify the refAccountIdentifierType and the refAccountIdentifier attributes.</p> <p>If the referAccountId attribute is not valid, the system will throw an error message indicating that the referred account is invalid.</p> <p>Based on the specified value in the referAccountId attribute, the system fetches the reference deal details for the deal creation process.</p>	
referDealIdentifier	<p>Used to specify the primary identifier using which the reference deal is created in the system.</p> <p>Note:</p> <p>If you specify the referDealIdentifier attribute, you need not specify the referenceDealId and referenceModelId attributes.</p> <p>You need to ensure that the Simulation Type of the reference deal matches with the value specified in the simulationTypeFlag attribute of the deal which you are creating. If the value does not match, the system will throw an error message indicating that the system is unable to derive a reference deal using the given deal identifier.</p> <p>Also, you cannot use a deal whose status is Draft, Discarded, Hierarchy Creation, Deferred, and Inactive as a reference for creating a deal. If the status of the reference deal is invalid, the system will throw an error message indicating that the system is unable to derive a reference deal using the given deal identifier.</p> <p>If the specified reference deal has multiple versions, the system will throw an error message indicating that multiple deal versions exist for the deal in the system. In such case, you need to specify the referenceModelId attribute of the reference deal instead of the referDealIdentifier attribute.</p>	<p>Yes (Conditional)</p> <p>Note: This data is required while specifying the reference deal to create a deal for an existing person, account, or a prospect person.</p>
referenceDealId	Used to specify the deal which you want to use as a reference.	Yes (Conditional)

Attribute Name	Attribute Description	Mandatory (Yes or No)
	<p>Note:</p> <p>If you specify the referenceDealId attribute, you need not specify the referDealIdentifier and referenceModelId attributes.</p> <p>You need to ensure that the Simulation Type of the reference deal matches with the value specified in the simulationTypeFlag attribute of the deal which you are creating. If the value does not match, the system will throw an error message indicating that the system is unable to derive a reference deal using the given deal ID.</p> <p>Also, you cannot use a deal whose status is Draft, Discarded, Hierarchy Creation Deferred, and Inactive as a reference for creating a deal. If the status of the reference deal is invalid, the system will throw an error message indicating that the system is unable to derive a reference deal using the given deal ID.</p> <p>If the specified reference deal has multiple versions, the system will throw an error message indicating that multiple deal versions exist for the deal in the system. In such case, you need to specify the referenceModelId attribute of the reference deal instead of the referenceDealId attribute.</p>	<p>Note: This data is required while specifying the reference deal to create a deal for an existing person, account, or a prospect person.</p>
referenceModelId	Used to specify the deal version which you want to use as a reference.	<p>Yes (Conditional)</p> <p>Note: This data is required while specifying the reference deal to create a deal for an existing person, account, or a prospect person.</p>

Attribute Name	Attribute Description	Mandatory (Yes or No)
	<p>Note:</p> <p>You need to specify the referenceModelId if the reference deal has multiple deal versions.</p> <p>If you specify the referenceModelId attribute, you need not specify the referDealIdentifier and referenceDealId attributes.</p> <p>You need to ensure that the Simulation Type of the reference deal version matches with the value specified in the simulationTypeFlag attribute of the deal which you are creating. If the value does not match, the system will throw an error message indicating that the system is unable to derive a reference deal using the given deal version ID.</p> <p>Also, you cannot use a deal version whose status is Draft, Discarded, Hierarchy Creation Deferred, and Inactive as a reference for creating a deal. If the status of the reference deal version is invalid, the system will throw an error message indicating that the system is unable to derive a reference deal using the given deal version ID.</p>	
referUsageSw	<p>Used to indicate whether you want to copy commitments from the SQI-based billable charges of the reference deal. The valid values are:</p> <ul style="list-style-type: none"> • true • false <p>Note:</p> <p>If you do not specify a value in the referUsageSw attribute, by default, the system considers it as false.</p> <p>You should specify values in either referUsageSw or referPriceSw attribute or both.</p>	<p>Yes (Conditional)</p> <p>Note: This data is required while specifying the reference deal to create a deal for an existing person, account, or a prospect person.</p>
referPriceSw	<p>Used to indicate whether you want to copy the price list assignments and price assignments of the reference deal. The valid values are:</p> <ul style="list-style-type: none"> • true • false 	<p>Yes (Conditional)</p> <p>Note: This data is required while specifying the reference deal to create a deal for an existing person, account, or a prospect person.</p>

Attribute Name	Attribute Description	Mandatory (Yes or No)
	<p>Note:</p> <p>If you do not specify a value in the referPriceSw attribute, by default, the system considers it as false.</p> <p>You should specify values in either referUsageSw or referPriceSw attribute or both.</p>	
includeChildHierarchy	<p>Used to indicate whether you want to include the child persons, grandchild persons, and their accounts of the reference deal while creating the deal for an existing or prospect person. The valid values are:</p> <ul style="list-style-type: none"> • true • false <p>Note:</p> <p>By default, the system considers all child and grandchild persons and their accounts in the customer hierarchy while specifying a reference deal for an existing person irrespective of the values provided in the includeChildHierarchy attribute.</p>	<p>Yes (Conditional)</p> <p>Note: This data is required while specifying the reference deal to create a deal for an existing person.</p>
division	<p>Used to specify the division to which the reference person belongs.</p>	<p>Yes (Conditional)</p> <p>Note: This data is required while creating a deal for an entity (i.e. existing customer, account, or prospect customer) by specifying the reference deal identifier type and identifier.</p>

Once the deal is created, all the details of deal are listed in the above mentioned attributes along with the following attributes:

Attribute Name	Attribute Description
dealResponse	Displays whether the deal creation request is successfully processed or not.
message	Displays the message generated for the deal response.
dealInformation	Displays the concatenated string of information about the deal separated by a comma (,).
dealId	Displays the identification value of the deal.
modelId	Displays the identification value of the deal version.
customerSegment	Indicates the business component to which the entity (i.e. existing person, account, or prospect person) belongs.

Attribute Name	Attribute Description
customerTier	Indicates the customer tier of the customer segment to which the entity (i.e. existing person, account, or prospect person) belongs.
division	Indicates the division to which the entity (i.e. existing person, account, or prospect person) belongs.
accessGrp	Indicate the user group who can view and edit the details of the entity (i.e. existing person, account, or prospect person).
dealEntityId	Displays the entity (i.e. existing person, account, or prospect person) for which the deal is created.
createdDate	Displays the date when the deal is created in the system.
status	Displays the current status of the deal.
dealVersionStatus	Displays the current status of the deal version.

Related Topics

For more information on...	See...
Sample deal creation request and response in the JSON format	Sample Deal Creation Request and Response in the JSON Format on page 4141

Deal Update Request and Response - Attribute/Value Pairs in the JSON Format

Note: We recommend you to refer the topics [Deal Update Request in the JSON Format](#) on page 4076 and [Deal Update Response in the JSON Format](#) on page 4078 in parallel while understanding the below mentioned attributes. This will help you to understand how the attributes are structured in the JSON format.

Before calling the **C1-DealCreationUpdateIWS** business service through an inbound web service, you need to ensure that the deal update request contains the following attributes:

Attribute Name	Attribute Description	Mandatory (Yes or No)
actionFlag	Used to indicate that you want to create request to update a deal. The valid value is: <ul style="list-style-type: none"> UPD <p>Note: If you do not specify the value in this attribute, by default, the system considers it as an ADD action.</p>	Yes
dealOperation	Used to specify the details of the deal operation.	No
operationFlag	Used to indicate that you want to create request that which operation you want to perform on a deal. The valid values are: <ul style="list-style-type: none"> APPR ACPT REJC FNAL SMLD 	Yes (Conditional)

Attribute Name	Attribute Description	Mandatory (Yes or No)
	<ul style="list-style-type: none">• SNDP• RETN• PSEL• CRDV• DSCR <div data-bbox="599 443 1084 583" style="border: 1px solid black; padding: 5px;"><p>Note: You cannot specify the operationFlag attribute as DSCR if the status of the deal version is FORC, PROR, REJC, FNAL, or ACPT.</p></div>	

Attribute Name	Attribute Description	Mandatory (Yes or No)
	<p>Note:</p> <p>If you specify the value of actionFlag attribute as UPD and operationFlag attribute as SMLD, then, the deal version gets simulate.</p> <p>If you specify the value of actionFlag attribute as UPD and operationFlag attribute as SNDP, then, the deal version is send for the approval.</p> <p>If you specify the value of actionFlag attribute as UPD and operationFlag attribute as APPR, then, the deal version is approved or send to next level in the approval hierarchy.</p> <p>If you specify the value of actionFlag attribute as UPD and operationFlag attribute as RETN, then, the submitter is requested to resubmit the deal version for the approval.</p> <p>If you specify the value of actionFlag attribute as UPD and operationFlag attribute as FNAL, then, the deal version gets finalized.</p> <p>If you specify the value of actionFlag attribute as UPD and operationFlag attribute as ACPT, then, the deal version is accepted.</p> <p>If you specify the value of actionFlag attribute as UPD and operationFlag attribute as REJC, then, the deal version is rejected.</p> <p>If you specify the value of actionFlag attribute as UPD and operationFlag attribute as DSCR, then, the deal version is discarded.</p> <p>To select the price item for which you want to inherit, override, or edit pricing and commitments in the deal version you need to set the value of actionFlag attribute as UPD and operationFlag attribute as PSEL, and includeFlag of price item and pricing parameter as true.</p> <p>If you specify the value of actionFlag attribute as UPD and operationFlag attribute as APPR, SNDP or RETN, then, the system will check the value of dealIdentifier and dealId.</p> <p>If you specify the value of dealId as blank and specify the value of dealIdentifier then the system will fetch dealId and modelId.</p> <p>If you specify the value of actionFlag attribute as UPD and operationFlag attribute as FNAL or REJC, then, the system will check value of dealIdentifier and dealId.</p> <p>If you specify the value of dealId as blank and specify the value of dealIdentifier then the system will fetch dealId.</p> <p>If you specify the value of actionFlag is UPD and operationFlag as APPR, SNDP, RETN, FNAL, ACPT, or REJC, then, the system will throw an error as multiple deal version exist for dealIdentifier or dealId.</p>	

Attribute Name	Attribute Description	Mandatory (Yes or No)
dealIdentifier	Used to specify the deal identifier using which you want to update the deal in the system.	Yes (Conditional) Note: This data is required if the do not specify value of dealId attribute.
dealId	Used to specify the deal for which you want to create the update request.	Yes (Conditional) Note: This data is required if the do not specify value of dealIdentifiertag .
modelId	Used to specify the deal version for which you want to create the update request.	Yes (Conditional) Note: This data is required if the value of operation flag is APPR and multiple deal version exists in the system.
dealAcceptEffStartDate	Used to specify the date from when the deal is effective for the existing or prospect person or account.	Yes (Conditional) Note: This data is required if the value of operationFlag is set to ACPT .
dealAcceptEffEndDate	Used to specify the date till when the deal is effective for the existing or prospect person or account.	Yes (Conditional) Note: This data is required if the value of operationFlag is set to ACPT .
comments	Used to specify the information about accepting or rejecting the deal.	Yes (Conditional) Note: This data is required if the value of operationFlag is set to REJC .
rejectReasonCode	Used to specify the deal rejectReasonCode which you want to reject.	Yes (Conditional) Note: This data is required if the value of operation flag is set to REJC .
dealVersionDescription	Used to specify the deal version description.	No
dealVersionCreationFlag	Used to indicate the method using which you want to create a new deal version. The valid values are: <ul style="list-style-type: none"> CVOC - Used to indicate that you want to copy the customer hierarchy without the pricing and commitment details from the current deal version to the new deal version. CVWC - Used to indicate that you want to copy the customer hierarchy and pricing and 	No

Attribute Name	Attribute Description	Mandatory (Yes or No)
	<p>commitment details from the current deal version to the new deal version.</p> <ul style="list-style-type: none"> • FLHR - Used to indicate that you want to derive the latest customer hierarchy from the system. <div style="border: 1px solid black; padding: 5px; margin-top: 10px;"> <p>Note:</p> <p>In this case, you will have to select the price items, assign the required price lists to the entities, override or edit the required proposed pricing, and add commitments from scratch in the new deal version.</p> <p>Also, the system will include all the prospect persons and accounts associated with the customer in the customer hierarchy of the deal version.</p> </div>	
priceItemGroupSelection	Used to specify the details of price item group selection.	No
priceItemSelectionList	Used to specify a list of price item selection.	No
priceItemCode	Used to specify the price item code which is associated with the deal that you want to update.	<p>Yes (Conditional)</p> <div style="border: 1px solid black; padding: 5px; margin-top: 5px;"> <p>Note: This data is required while updating the price item associated with the deal.</p> </div>
priceItemInfo	Used to specify the information of the price item that you want to update.	<p>Yes (Conditional)</p> <div style="border: 1px solid black; padding: 5px; margin-top: 5px;"> <p>Note: This data is required while updating the price item associated with the deal.</p> </div>
parameterInfo	Used to specify the information of the parameters which are associated with the price item.	<p>Yes (Conditional)</p> <div style="border: 1px solid black; padding: 5px; margin-top: 5px;"> <p>Note: This data is required while updating the price item associated with the deal.</p> </div>
assignmentLevel	Used to indicate the level at which the price item pricing is defined in the person hierarchy.	<p>Yes (Conditional)</p> <div style="border: 1px solid black; padding: 5px; margin-top: 5px;"> <p>Note: This data is required while updating the price item associated with the deal.</p> </div>
hierarchyDetails	Used to specify the details of the person hierarchy.	<p>Yes (Conditional)</p> <div style="border: 1px solid black; padding: 5px; margin-top: 5px;"> <p>Note: This data is required while updating the price item associated with the deal.</p> </div>

Attribute Name	Attribute Description	Mandatory (Yes or No)
includeFlag	Used to indicate the flag value of the price item pricing. The valid value are: <ul style="list-style-type: none"> true false 	Yes (Conditional)
		Note: This data is required while updating the price item associated with the deal.
		Note: You have to set the includeFlag of the price item and pricing as true .
dealDetails	Used to specify the details for a deal.	No
dealEntityDetails	Used to specify the details of the entity for which you want to update the deal.	No
personIdentifierType	Used to indicate the identifier type of the existing person based on which you want to update the deal.	Yes (Conditional)
		Note: This data is required if you specify the personIdentifier attribute.
personIdentifier	Used to specify the existing person identifier.	Yes (Conditional)
		Note: This data is required if you specify the personIdentifierType attribute.
personId	Used to specify the existing person whose deal you want to update.	Yes (Conditional)
		Note: This data is required if you specify the personIdentifier attribute.
accountIdentifierType	Used to indicate the identifier type of the existing person account based on which you want to update the deal.	Yes (Conditional)
		Note: This data is required if you specify the accountIdentifier attribute.
accountIdentifier	Used to specify the existing person account identifier.	Yes (Conditional)
		Note: This data is required if you specify the accountIdentifierType attribute.
accountId	Used to specify the existing person account whose deal you want to update.	Yes (Conditional)
		Note: This data is required if you do not specify the accountIdentifier attribute.
prsPerIdentifierType	Used to indicate the identifier type of the prospect person based on which you want to update the deal.	Yes (Conditional)

Attribute Name	Attribute Description	Mandatory (Yes or No)
		Note: This data is required if you specify the prsPerIdentifier attribute.
prsPerIdentifier	Used to specify the prospect person identifier.	Yes (Conditional) Note: This data is required if you specify the prsPerIdentifierType attribute.
prospectPersonId	Used to specify the prospect person whose deal you want to update.	Yes (Conditional) Note: This data is required if you do not specify the prsPerIdentifier attribute.
division	Used to indicate the division to which the person belongs.	Yes (Conditional) Note: This data is required if you specify the personIdentifier and personIdentifierType attributes.
dealIdentifier	Used to specify the deal identifier for which you want to update the deal.	Yes (Conditional) Note: This data is required if you do not specify the dealId or dealversionId attribute.
dealInformation	Used to specify the information about the deal which you want to update for the entity.	Yes
dealId	Used to specify the deal for which you want to create the update request.	Yes (Conditional) Note: This data is required if you do not specify the dealIdentifier or dealversionId attribute.
modelId	Used to specify the model for which you want to create the update request.	No
dealEntityType	Used to indicate the deal entity type for which you want to update the deal. <ul style="list-style-type: none"> • EPER • EACC • PRSP 	Yes

Attribute Name	Attribute Description	Mandatory (Yes or No)
	<p>Note:</p> <p>If you specify the value of this attribute as EPER, then, you must specify the values for the personId, personIdentifierType, personIdentifier, and division attributes.</p> <p>If you specify the value of this attribute as EPER, then, the system will fetch the details of accessGrp, division, customerSegment, and customerTier from the existing person.</p> <p>If you specify the value of this attribute as EACC, then, you must specify the values for the accountId, accountIdentifierType, accountIdentifier, and division attributes.</p> <p>If you specify the value of this attribute as EACC, then, the system will fetch the details of main personId from existing person's account and division, accessGrp, customerSegment, and customerTier from the existing person.</p> <p>If you specify the value of this attribute as PRSP, then, you must specify the values for the prospectPersonId, prsPerIdentifierType, prsPerIdentifier, and division attributes.</p> <p>If you specify the value of this attribute as PRSP, then, the system will fetch the details of the accessGrp, division, customerSegment and customerTier from the prospect person.</p>	
customerSegment	<p>Used to indicate the business component to which the entity (i.e. the existing person or account, prospect person) belongs. The valid values are:</p> <ul style="list-style-type: none"> • COMM • CORP • SME 	No
customerTier	Used to indicate the customer tier to which the entity (i.e. the existing person or account, prospect person) belongs.	No
division	<p>Used to indicate the division to which the entity (i.e. the existing person or account, prospect person) is associated.</p> <p>Note:</p> <p>You must specify a division which is already defined in the system.</p>	Yes
accessGrp	Used to indicate the user groups who can view and edit the details of the entity.	Yes

Attribute Name	Attribute Description	Mandatory (Yes or No)
	Note: You must specify an accessGrp which is associated with the division to which the entity belongs.	
dealEntityId	Used to specify the deal entity Id whose details you want to update.	
contractedDealFlag	Used to indicate that the change in the price item pricing from the price list does not affect the price item pricing offered in the deal created for an existing person, account or prospect person. <ul style="list-style-type: none"> • true • false 	Yes
currency	Used to specify the currency in which you want to calculate the deal or division specific financial summary and profitability of the deal.	Yes
dealTypeCode	Used to indicate the deal type using which you want to create request to update the deal in the system.	Yes
startDate	Used to specify the date from when the deal is effective for the entity (i.e. the person, account, or prospect person).	Yes
endDate	Used to specify the date till when the deal is effective for the entity (i.e. the person, account, or prospect person).	No
simulationTypeFlag	Used to indicate the simulation type using which you want to analyze the cost, revenue, and profitability of the deal. The valid values are: <ul style="list-style-type: none"> • CUST • ACCT • DEAL 	Yes
reviewFrequency	Used to indicate the timely monitoring of the deal usage as per the commitments made by the customer.	No
dealDescription	Used to specify the description for the deal.	No
dealVersionDescription	Used to specify the description for the deal version.	No
dealFrequency	Used to indicate the duration in which you want to simulate the deal for calculating the financial summary and profitability of the deal. <ul style="list-style-type: none"> • Biannually • Monthly • Quarterly • Yearly 	Yes

Attribute Name	Attribute Description	Mandatory (Yes or No)
skipReferenceFlag	<p>Used to indicate whether you want to use a deal which is already created in the system as a reference for copying the pricing and commitments in the deal or not. The valid values are:</p> <ul style="list-style-type: none"> • true • false <p>Note: By default, the value is set to false.</p>	No
priceSelectionDate	Used to specify the date from when the price lists, pricing assignments, and product enrollments are effective for simulation.	Yes
usagePeriod	<p>Used to indicate the period for which you want to aggregate the deal data to determine the scope of the deal. The valid values are:</p> <ul style="list-style-type: none"> • biannually • monthly • quarterly • yearly 	Yes
includeHierarchyFlag	<p>Used to indicate whether you want to include the child persons, grandchild persons, and their accounts in the customer hierarchy while updating the deal. The valid values are:</p> <ul style="list-style-type: none"> • true • false <p>Note:</p> <p>If the entity is prospect person, then you have specify the value of includeHierarchyFlag to true.</p> <p>If you specify the value of includeHierarchyFlag attribute as true and dealEntityType is set as ACCT or DEAL, then, the system will throw an error.</p> <p>If you specify the value of includeHierarchyFlag attribute as false and dealEntityType as PRSP, then, the system will throw an error.</p>	Yes (Conditional)
status	<p>Used to indicate the current status of the deal. The valid values are:</p> <ul style="list-style-type: none"> • DRAFT • PSML • PFAP • SMLD 	

Attribute Name	Attribute Description	Mandatory (Yes or No)
	<ul style="list-style-type: none"> • DSML • RFAP <p>Note:</p> <p>You can update the deal only if the value of deal status is set as DRFT, PSML, PFAP, SMLD, DSML or RFAP.</p> <p>If you specify the value of the deal status as DRFT, then, you cannot update the details of dealEntityType, customerSegment, customerTier, accessGrp, division, and templatedeal else the system will throw an error.</p> <p>If you specify the value of the deal status as PSML, then, you cannot update the details of startDate, createdDate , contractedDealFlag, dealIdentifier, templateDealId, dealTypeCode, dealEntityCode, status, customerTier, customerSegment, accessGrp, division, currency, SimulationTypeFlag, priceSelectionDate, dealFrequency, usagePeriod, templateFlag, skipReferenceFlag or includeHierarchyFlag else the system will throw an error.</p> <p>If you specify the value of the deal status as PFAP, SMLD, DSML or RFAP then, you cannot update the details of dealInformation and dealCharacteristics.</p> <p>If the deal status is set as DRFT, PSML, PFAP, SMLD, DSML or RFAP then, the termsAndCondition can be updated only one who creates the deal, else the system will throw an error.</p> <p>If the deal is approved, then, you cannot update the dealInformation, dealCharacteristics, termsAndCondition, and dealProduct else the system will throw an error.</p>	
dealVersionStatus	Used to indicate the current status of the deal version(model).	No
templateFlag	<p>Use to indicate whether you want the deal to be used as a template while updating the other deals.</p> <ul style="list-style-type: none"> • true • false <p>Note: The system will check whether the user has access to update the template deal.</p>	Yes (Conditional)
templateReferenceDetails	Used to specify the details of the template reference of the deal.	No

Attribute Name	Attribute Description	Mandatory (Yes or No)
templateDealId	Used to specify the particular deal whose details you want to use as a template for other deals.	Yes (Conditional)
	<p>Note:</p> <p>If you do not specify the templateDealIdentifier or templateModelId attributes, you need to specify the templateDealId attribute.</p> <p>If you specify the values of templateDealId, templateDealIdentifier, and templateModelId attributes and the value for copyUsageFlag, copyBasicDetailsFlag, and copyPricingFlag attributes is set as false, then, the system will throw an error. The value of copyUsageFlag, copyBasicDetailsFlag, or copyPricingFlag attribute should be set to true.</p> <p>If you specify templateDealIdentifier or templateDealId attribute and there are multiple deal versions then the system will throw an error.</p> <p>If the value of templateDealIdentifier or templateDealId attribute is not found in the system then it will throw an error.</p>	<p>Note: This data is required while specifying the template deal.</p>
templateDealIdentifier	Used to specify the deal identifier whose details you want to use as a template for other deals.	Yes (Conditional)
	<p>Note: If you do not specify the templateDealId or templateModelId attribute, you need to specify the templateDealIdentifier attribute.</p>	<p>Note: This data is required while specifying the template deal.</p>
templateModelId	Used to specify the template deal version whose details you want to use as a template for other deals.	Yes (Conditional)
	<p>Note: If you do not specify the templateDealId or templateDealIdentifier attribute, you need to specify the templateModelId attribute.</p>	<p>Note: This data is required while specifying the template deal.</p>
copyBasicDetailsFlag	<p>Used to indicate whether you want to use basic details of the deal to update a deal. The valid values are:</p> <ul style="list-style-type: none"> • true • false 	Yes (Conditional)
	<p>Note: If you specify the templateDealId or templateDealIdentifier or templateModelId attributes, you need to set the value of the copyBasicDetailsFlag attribute.</p>	<p>Note: This data is required while specifying the template deal.</p>
copyPricingFlag	Used to indicate whether you want to use pricing details of the deal to update a deal. The valid values are:	Yes (Conditional)

Attribute Name	Attribute Description	Mandatory (Yes or No)
	<ul style="list-style-type: none"> • true • false <p>Note: If you specify the value for templateDealId or templateDealIdentifier or templateModelId attributes, you need to set the value of the copyPricingFlag attribute.</p>	<p>Note: This data is required while specifying the template deal.</p>
copyUsageFlag	<p>Used to indicate whether you want to use usage details of the deal to update a deal. The valid values are:</p> <ul style="list-style-type: none"> • true • false <p>Note:</p> <p>If you specify the value for templateDealId or templateDealIdentifier or templateModelId attributes, you need to set the value of the copyUsageFlag attribute.</p> <p>If the templateDealId, templateDealIdentifier, and templateModelId is entered with copyUsageFlag value as true, then system will copy the dealinformation, dealproducts, dealTermsAndConditionsDetails, and dealCharacteristics from the deal.</p> <p>If you specify the value for dealinformation attribute, then, it overrides the value of the template dealinformation .</p> <p>If you specify the value for dealCharacteristics, dealTermsAndConditionsDetails, and dealproducts, then, it will add the value along with template dealCharacteristics, dealTermsAndConditionsDetails, and dealproducts.</p>	<p>Yes (Conditional)</p> <p>Note: This data is required while specifying the template deal.</p>
dealCharacteristics	Used to specify a list of characteristics of the deal.	No
characteristicType	Used to indicate the characteristic type.	<p>Yes (Conditional)</p> <p>Note: This data is required while defining a characteristic for the deal.</p>
effectiveDate	Used to specify the date from when the characteristic is effective for the deal.	<p>Yes (Conditional)</p> <p>Note: This data is required while defining a characteristic for the deal.</p>
characteristicValue	Used to specify the value for the characteristic type.	Yes (Conditional)

Attribute Name	Attribute Description	Mandatory (Yes or No)
		Note: This data is required while defining a characteristic for the deal.
dealTermsAndConditionsDetails	Used to specify the details of the terms and conditions of the deal.	No
termsAndConditionsList	Used to specify a list of the terms and conditions of the deal.	No
description	Used to specify the description of the terms and conditions of the deal.	No
termsAndCondition	Used to indicate the terms and conditions which you want to associate with the deal.	Yes (Conditional)
	Note: If you do not specify the value in the termsAndCondition attribute, then, the system will throw an error.	Note: This field is required while associating terms and conditions with a deal.
termsAndConditionText	Used to specify the description of terms and conditions for the deal.	Yes (Conditional)
		Note: This field is required while associating terms and conditions with a deal.
adhocTermsAndCondition	Used to indicate the adhoc terms and conditions which you want to associate with the deal.	No
productDetailsList	Used to specify a list of product details of the deal.	No
productCode	Used to specify the product code.	No
referenceDetails	Used to specify the details of the deal that you want to use as reference to update the deal.	No
referenceTypeFlg	Used to indicate the reference type of the deal that you want to use as reference to update the deal for the entity. The valid value is: <ul style="list-style-type: none"> • RPER • RACC • RDEL 	Yes (Conditional)
	Note: If you specify the value in the skipReferenceFlag as false , then, you need to specify the value in the referenceTypeFlg attribute.	Note: This data is required while specifying the reference deal.
refPersonIdentifierType	Used to specify the reference person identifier type based on which you want to update the deal for the entity.	Yes (Conditional)
		Note: This data is required while specifying the reference deal of the person.

Attribute Name	Attribute Description	Mandatory (Yes or No)
	<p>Note: If you specify the value in the referenceTypeFlg attribute as RPER, then, you need to specify the refPersonIdentifierType attribute.</p>	
refPersonIdentifier	<p>Used to specify the value of the reference person identifier type.</p> <p>Note: If you specify the value in the referenceTypeFlg attribute as RPER, then, you need to specify the refPersonIdentifier attribute.</p>	<p>Yes (Conditional)</p> <p>Note: This data is required while specifying the reference deal of the person.</p>
referPersonId	<p>Used to specify the reference person using which you want to update the deal.</p> <p>Note: If you specify the value in the referenceTypeFlg attribute as RPER, then, you need to specify the referPersonId attribute.</p>	<p>Yes (Conditional)</p> <p>Note: This data is required while specifying the reference deal of the person.</p>
refAccountIdentifierType	<p>Used to specify the reference account identifier type based on which you want to update the deal for the entity.</p> <p>Note: If you specify the value in the referenceTypeFlg attribute as RACC, then, you need to specify the refAccountIdentifierType attribute.</p>	<p>Yes (Conditional)</p> <p>Note: This data is required while specifying the reference deal of the person account.</p>
refAccountIdentifier	<p>Used to specify the value of the reference account identifier type.</p> <p>Note: If you specify the value in the referenceTypeFlg attribute as RACC, then, you need to specify the refAccountIdentifier attribute.</p>	<p>Yes (Conditional)</p> <p>Note: This data is required while specifying the reference deal of the person account.</p>
referAccountId	<p>Used to specify the reference account using which you want to update the deal.</p> <p>Note: If you specify the value in the referenceTypeFlg attribute as RACC, then, you need to specify the referAccountId attribute.</p>	<p>Yes (Conditional)</p> <p>Note: This data is required while specifying the reference deal of the person account.</p>
referDealIdentifier	<p>Used to specify the value of the reference deal identifier type.</p> <p>Note: If you specify the value in the referenceTypeFlg attribute as RDEL, then, you need to specify the referDealIdentifier attribute.</p>	<p>Yes (Conditional)</p> <p>Note: This data is required while specifying the reference deal.</p>
referenceDealId	<p>Used to specify the reference deal using which you want to update the deal.</p>	<p>Yes (Conditional)</p> <p>Note: This data is required while specifying the reference deal.</p>

Attribute Name	Attribute Description	Mandatory (Yes or No)
	<p>Note:</p> <p>If you specify the value in the referenceTypeFlg attribute as RDEL, then, you need to specify the referenceDealId attribute.</p> <p>If you do not specify the value in the referenceDealId, referDealIdentifier, and referenceModelId attributes, then, the system will throw an error.</p> <p>If you specify the values in the referenceDealId, referDealIdentifier, and referenceModelId attributes, then, the system will check whether the values are valid or not.</p>	
referenceModelId	<p>Used to specify the reference deal version using which you want to update the deal.</p> <p>Note: If you specify the value in the referenceTypeFlg attribute as RDEL, then, you need to specify the referenceModelId attribute.</p>	<p>Yes (Conditional)</p> <p>Note: This data is required while specifying the reference deal.</p>
referUsageSw	<p>Used to indicate whether you want to use reference usage details to update the deal.</p> <ul style="list-style-type: none"> • true • false <p>Note:</p> <p>By default, the value is set to false.</p> <p>You need to specify the value of either referUsageSw or referPriceSw as true.</p>	<p>Yes (Conditional)</p> <p>Note: This data is required while specifying the reference deal.</p>
referPriceSw	<p>Used to indicate whether you want to use reference pricing details to update the deal.</p> <ul style="list-style-type: none"> • true • false <p>Note:</p> <p>By default, the value is set to false.</p> <p>You need to specify the value of either referUsageSw or referPriceSw as true.</p>	<p>Yes (Conditional)</p> <p>Note: This data is required while specifying the reference deal.</p>
includeChildHierarchy	<p>Used to indicate whether you want to add child hierarchy in the deal of the person.</p> <ul style="list-style-type: none"> • true • false 	<p>Yes (Conditional)</p>

Attribute Name	Attribute Description	Mandatory (Yes or No)
	Note: By default, the value is set to false .	
division		

Once the deal is updated, all the details of deal are listed in the above mentioned attributes along with the following:

Attribute Name	Attribute Description
dealResponse	Indicates whether the deal update request is successfully processed or not.
message	Displays the message of successful deal update.
dealId	Displays the deal ID.
modelId	Displays the model ID.
createdDate	Displays the date when the deal is created.
acceptanceDate	Displays the date when the deal is accepted.
finalizedDate	Displays the date when the deal is finalized.
effectiveStartDate	Displays the date from when the deal is effective.
effectiveEndDate	Displays the date till when the deal is effective.
reviewedDate	Displays the date when the deal is reviewed.
dealSimulationDetails	Displays the simulation details of the deal.
dealFinancialSummaryId	Displays a list of the financial summary at the deal level.
approvalStatus	Indicates the current approval status of the financial summary at the deal level. <ul style="list-style-type: none"> • APPR • EROR • INIT • UNAP
originalDealFinancialSummaryId	Displays the summary of the original financial summary at the deal level.
revenue	Displays the original revenue generated from the price item pricing and price assignments at the deal level.
cost	Displays the original cost calculated at the deal level.
profit	Displays the original profit in deal currency generated from the price item pricing and price assignments at the deal level. It is calculated using the following formula: Profit = Revenue – Cost
profitabilityPercentage	Displays the original profit created in percentage at the deal level from the price item pricing and price assignments. It is calculated using the following formula: Profitability Percentage = (Revenue – Cost)*100/ Revenue
proposedDealFinancialSummaryId	Displays the summary of the proposed financial at the deal level.
revenue	Displays the proposed revenue generated from the price item pricing and price assignments at the deal level.
cost	Displays the proposed cost calculated at the deal level.

Attribute Name	Attribute Description
profit	Displays the proposed profit in deal currency generated from the price item pricing and price assignments at the deal level. It is calculated using the following formula: Profit = Revenue – Cost
profitabilityPercentage	Displays the proposed profit created in percentage at the deal level from the price item pricing and price assignments. It is calculated using the following formula: Profitability Percentage= (Revenue – Cost)*100/ Revenue
recommendedDealFinancialSummary	Displays the summary of the recommended financial at the deal level.
revenue	Displays the recommended revenue generated from the price item pricing and price assignments at the deal level.
profit	Displays the recommended profit in deal currency generated from the price item pricing and price assignments at the deal level. It is calculated using the following formula: Profit = Revenue – Cost
profitabilityPercentage	Displays the recommended profit created in percentage at the deal level from the price item pricing and price assignments. It is calculated using the following formula: Profitability Percentage = (Revenue – Cost)*100/ Revenue
profitVariationPercentage	Displays the difference between the original profit and proposed profit in percentage at the recommend deal level from the price item pricing and price assignments.
divisionFinancialSummary	Displays the summary details of the financial at the division level.
division	Displays the division associated with the deal.
approvalStatus	Indicates the current approval status of the financial summary at the division level. <ul style="list-style-type: none"> • APPR • EROR • INIT • UNAP
originalDivisionFinancialSummary	Displays the summary of the original financial at the division level.
revenue	Displays the original revenue generated from the price item pricing and price assignments at the division level.
cost	Displays the original cost calculated at the division level.
profit	Displays the original profit in deal currency generated from the price item pricing and price assignments at the division level. It is calculated using the following formula: Profit = Revenue – Cost
profitabilityPercentage	Displays the original profit created in percentage at the division level from the price item pricing and price assignments. It is calculated using the following formula: Profitability Percentage = (Revenue – Cost)*100/ Revenue
proposedDivisionFinancialSummary	Displays the summary of the proposed financial at the division level.
revenue	Displays the proposed revenue generated from the price item pricing and price assignments at the division level.

Attribute Name	Attribute Description
cost	Displays the proposed cost calculated at the proposed level.
profit	Displays the proposed profit in deal currency generated from the price item pricing and price assignments at the division level. It is calculated using the following formula: Profit = Revenue – Cost
profitabilityPercentage	Displays the proposed profit created in percentage at the division level from the price item pricing and price assignments. It is calculated using the following formula: Profitability Percentage = (Revenue – Cost)*100/ Revenue
recommendedDealFinancialSummary	Displays the summary of the recommended financial at the deal level.
revenue	Displays the recommended revenue generated from the price item pricing and price assignments at the deal level.
cost	Displays the recommended cost calculated at the deal level.
profit	Displays the recommended profit in deal currency generated from the price item pricing and price assignments at the deal level. It is calculated using the following formula: Profit = Revenue – Cost
profitabilityPercentage	Displays the recommended profit created in percentage at the deal level from the price item pricing and price assignments. It is calculated using the following formula: Profitability Percentage= (Revenue – Cost)*100/ Revenue
profitVariationPercentage	Displays the difference between the recommended profit and proposed profit in percentage. at the division level from the price item pricing and price assignments.
productFinancialSummary	Displays the summary details of the financial at the product level.
approvalStatus	Indicates the current approval status of the financial summary at the product level. <ul style="list-style-type: none"> • APPR • EROR • INIT • UNAP
product	Displays the product.
division	Indicates the division for which the product financial summary is displayed.
originalProductFinancialSummary	Displays the summary of the original financial at the product level.
revenue	Displays the original revenue generated from the price item pricing and price assignments at the product level.
cost	Displays the original cost calculated at the product level.
profit	Displays the original profit in deal currency generated from the price item pricing and price assignments at the product level. It is calculated using the following formula: Profit = Revenue – Cost
profitabilityPercentage	Displays the original profit created in percentage at the product level from the price item pricing and price assignments. It is calculated using the following formula: Profitability Percentage = (Revenue – Cost)*100/ Revenue

Attribute Name	Attribute Description
proposedProductDivisionFinancialSummary	Displays the summary of the financial at the proposed product division level.
revenue	Displays the revenue generated from the price item pricing and price assignments at the proposed product division level.
cost	Displays the cost calculated at the proposed product division level.
profit	Displays the profit in deal currency generated from the price item pricing and price assignments at the proposed product division level. It is calculated using the following formula: Profit = Revenue – Cost
profitabilityPercentage	Displays the profit created in percentage at the proposed product division level from the price item pricing and price assignments. It is calculated using the following formula: Profitability Percentage= (Revenue – Cost)* 100/ Revenue
recommendedDealFinancialSummary	Displays the summary of the financial at the recommend deal level.
revenue	Displays the revenue generated from the price item pricing and price assignments at the recommend deal level.
cost	Displays the cost calculated at the recommend deal level.
profit	Displays the profit in deal currency generated from the price item pricing and price assignments at the recommend deal division level. It is calculated using the following formula: Profit = Revenue – Cost
profitabilityPercentage	Displays the profit created in percentage at the recommend deal level from the price item pricing and price assignments. It is calculated using the following formula: Profitability Percentage= (Revenue – Cost)* 100/ Revenue
profitVariationPercentage	Displays the difference between the original profit and proposed profit in percentage. at the recommend deal level from the price item pricing and price assignments.
hierarchySimulationDetails	Displays the details of the hierarchy simulation.
entityType	Displays the entity type.
entityId	Displays the entity Id of the child.
parentEntityId	Displays the entity Id of the parent.
status	Indicates the status of the deal.
revenueVariation	Displays the average revenue generated from a person or account.
proposedRevenue	Displays the revenue generated from the proposed price item pricing and commitments.
proposedCost	Displays the overall cost of the proposed price item based on the usage.
originalRevenue	Displays the revenue generated through the original price item pricing and commitments.
originalCost	Displays the overall cost of the original price item based on the usage.

Related Topics

For more information on...	See...
Sample deal update request and response in the JSON format	Sample Deal Update Request and Response in the JSON Format on page 4145

For more information on...	See...
Sample deal version creation request and response in the JSON format	Sample Deal Version Creation Request and Response in the JSON Format on page 4148
Sample deal simulation request and response in the JSON format	Sample Deal Simulation Request and Response in the JSON Format on page 4150
Sample deal submission for approval request and response in the JSON format	Sample Deal Submission for Approval Request and Response in the JSON Format on page 4154
Sample deal approval request and response in the JSON format	Sample Deal Approval Request and Response in the JSON Format on page 4156
Sample deal return to submitter request and response in the JSON format	Sample Deal Return to Submitter Request and Response in the JSON Format on page 4158
Sample deal finalization request and response in the JSON format	Sample Deal Finalization Request and Response in the JSON Format on page 4160
Sample deal acceptance request and response in the JSON format	Sample Deal Acceptance Request and Response in the JSON Format on page 4162
Sample deal rejection request and response in the JSON format	Sample Deal Rejection Request and Response in the JSON Format on page 4164
Sample deal discard request and response in the JSON format	Sample Deal Discard Request and Response in the JSON Format on page 4165
Sample price item selection request and response in the JSON format	Sample Price Item Selection Request and Response in the JSON Format on page 4169

Deal View Request and Response - Attribute/Value Pairs in the JSON Format

Note: We recommend you to refer the topics [Deal View Request in the JSON Format](#) on page 4083 and [Deal View Request in the JSON Format](#) on page 4083 in parallel while understanding the below mentioned attributes. This will help you to understand how the attributes are structured in the JSON format.

Before calling the **C1-DealCreationUpdateIWS** business service through an inbound web service, you need to ensure that the deal view request contains the following attributes:

Attribute Name	Attribute Description	Mandatory (Yes or No)
actionFlag	Used to indicate that you want to create request to view the deal details of an entity (i.e. existing person, account, or prospect person). The valid value is: <ul style="list-style-type: none"> • READ 	Yes
	Note: If you do not specify the value in this attribute, by default, the system considers it as an ADD action.	
dealOperation	Used to specify the operation that you want to perform while viewing the deal details.	No
	Note: You need to specify the dealOperation attribute only when you want to view the price items using which the deal is simulated.	

Attribute Name	Attribute Description	Mandatory (Yes or No)
operationFlag	<p>Used to indicate that you want to create request to view the price items offered in the deal. The valid value is:</p> <ul style="list-style-type: none"> • PSEL 	<p>Yes (Conditional)</p> <p>Note: This data is required for viewing the price items offered in the deal.</p>
dealIdentifier	<p>Used to specify the primary identifier using which the deal is created in the system.</p> <p>Note: If you specify the dealIdentifier attribute, you need not specify the dealId or the modelId tags. If the deal has multiple versions, then, you should specify the modelId attribute instead of the dealIdentifier attribute.</p>	<p>Yes (Conditional)</p> <p>Note: This data is required for viewing the price items offered in the deal.</p>
dealId	<p>Used to specify the deal whose price items you want to view.</p> <p>Note: If you specify the dealId attribute, you need not specify the dealIdentifier or the modelId tags. If the deal has multiple versions, then, you should specify the modelId attribute instead of the dealId attribute.</p>	<p>Yes (Conditional)</p> <p>Note: This data is required for viewing the price items offered in the deal.</p>
modelId	<p>Used to specify the deal version whose price items you want to view.</p> <p>Note: If you specify the modelId attribute, you need not specify the dealIdentifier or the dealId tags.</p>	<p>Yes (Conditional)</p> <p>Note: This data is required for viewing the price items offered in the deal.</p>
dealDetails	<p>Used to specify the details of the deal.</p> <p>Note: You need to specify the dealDetails attribute only when you want to view the deal details other than the price items offered in the deal (i.e. when you do not specify the dealOperation attribute).</p>	<p>No</p>
dealIdentifier	<p>Used to specify the primary identifier using which the deal is created in the system.</p>	<p>Yes (Conditional)</p> <p>Note: This data is required for viewing the deal details except the price items offered in the deal.</p>

Attribute Name	Attribute Description	Mandatory (Yes or No)
	<p>Note:</p> <p>If you specify the dealIdentifier attribute, you need not specify the dealId or the modelId tags.</p> <p>If the deal has multiple versions, then, you should specify the modelId attribute instead of the dealIdentifier attribute.</p>	
dealId	<p>Used to specify the deal whose details you want to view.</p> <p>Note:</p> <p>If you specify the dealId attribute, you need not specify the dealIdentifier or the modelId tags.</p> <p>If the deal has multiple versions, then, you should specify the modelId attribute instead of the dealId attribute.</p>	<p>Yes (Conditional)</p> <p>Note: This data is required for viewing the deal details except the price items offered in the deal.</p>
modelId	<p>Used to specify the deal version whose details you want to view.</p> <p>Note:</p> <p>If you specify the modelId attribute, you need not specify the dealIdentifier or the dealId tags.</p>	<p>Yes (Conditional)</p> <p>Note: This data is required for viewing the deal details except the price items offered in the deal.</p>

Once the deal view request is created, all the details of deal are listed in the above mentioned attributes along with the following attributes:

Attribute Name	Attribute Description
dealResponse	Indicates whether the deal view request is successfully processed or not.
message	Displays the message generated for the deal response.
dealAcceptEffStartDate	<p>Displays the date when the deal is accepted in the system.</p> <p>Note: The data in this attribute appears only when the deal is accepted in the system.</p>
dealAcceptEffEndDate	<p>Displays the date till when you can finalize the deal in the system.</p> <p>Note: The data in this attribute appears only when the deal is accepted in the system and awaiting finalization.</p>
comments	Displays information about deal acceptance or rejection.
rejectReasonCode	Displays the reason why the deal is rejected in the system.
dealVersionDescription	Displays description of the deal version created for the deal.
dealVersionCreationFlag	Indicates the information using which the deal version is created. The valid values are:

Attribute Name	Attribute Description
	<ul style="list-style-type: none"> • CVOC - Indicates that the deal version is created without copying the changes done in the current deal. • CVWC - Indicates that the deal version is created by copying the changes done in the current deal. • FLHR - Indicates that the deal version is created by using the latest hierarchy of the entity from the system for which the current deal is created.
priceItemGroupSelection	<p>Displays the list of price items offered in the deal.</p> <p>Note: The data in this attribute appears only when you are viewing the price items offered in the deal (i.e. when the value in the operationFlag attribute is set to PSEL).</p>
priceItemSelectionList	<p>Displays information about the price item offered in the deal.</p> <p>Note: The data in this attribute appears only when you are viewing the price items offered in the deal (i.e. when the value in the operationFlag attribute is set to PSEL).</p>
priceItemCode	<p>Displays the price item.</p> <p>Note: The data in this attribute appears only when you are viewing the price items offered in the deal (i.e. when the value in the operationFlag attribute is set to PSEL).</p>
priceItemInfo	<p>Displays the concatenated string of information about the price item.</p> <p>Note: The data in this attribute appears only when you are viewing the price items offered in the deal (i.e. when the value in the operationFlag attribute is set to PSEL).</p>
parameterInfo	<p>Displays the parameters using which the pricing is defined for the price item.</p> <p>Note: The data in this attribute appears only when you are viewing the price items offered in the deal (i.e. when the value in the operationFlag attribute is set to PSEL).</p>
assignmentLevel	<p>Indicates the level at which the price item pricing is defined in the entity (i.e. exiting person, account, or prospect person) hierarchy. The valid values are:</p> <ul style="list-style-type: none"> • Account Agreed - Indicates price item pricing is agreed for the account. • Account Price List - Indicates price item pricing is defined in the price list which is assigned to the account. • Account Inherited Price List - Indicates price item pricing is inherited from the parent price list hierarchy defined for the price list which is assigned to the account. • Customer Agreed - Indicates price item pricing is agreed for the main customer in the customer hierarchy. • Customer Price List - Indicates price item pricing is defined in the price list which is assigned to the main customer. • Default Price List - Indicates price item pricing defined in the price list is available in the default price list. • Global Price List - Indicates price item pricing defined in the price list is available in the global price list.

Attribute Name	Attribute Description
	<ul style="list-style-type: none"> • Customer Inherited Price List - Indicates price item pricing is inherited from the parent price list hierarchy defined for the price list which is assigned to the main customer. • Parent Customer Agreed - Indicates price item pricing is agreed for the parent customer in the customer hierarchy. • Parent Customer Price List - Indicates price item pricing is defined in the price list which is assigned to the parent customer. • Parent Customer Inherited Price List - Indicates price item pricing is inherited from the parent price list hierarchy defined for the price list which is assigned to the parent customer. • Product Default Price List - Indicates product defined in the price list is available in the default price list. <p>Note: The data in this attribute appears only when you are viewing the price items offered in the deal (i.e. when the value in the operationFlag attribute is set to PSEL).</p>
hierarchyDetails	<p>Displays the root level and/or non-root level hierarchy entities to which the price item belongs.</p> <p>Note: The data in this attribute appears only when you are viewing the price items offered in the deal (i.e. when the value in the operationFlag attribute is set to PSEL).</p>
includeFlag	<p>Indicates whether the price item is included in the deal for simulation. The valid values are:</p> <ul style="list-style-type: none"> • true • false <p>Note: The data in this attribute appears only when you are viewing the price items offered in the deal (i.e. when the value in the operationFlag attribute is set to PSEL).</p>
dealEntityDetails	<p>Displays basic information about the entity (i.e. existing person, account, or prospect person) for which the deal is created in the system.</p>
personIdentifierType	<p>Indicates the identifier type using which the person is created in the system.</p> <p>Note: The value in this attribute appears only when the value specified in the dealEntityType attribute is EPER.</p>
personIdentifier	<p>Displays the value of the person identifier type.</p> <p>Note: The value in this attribute appears only when the value specified in the dealEntityType attribute is EPER.</p>
personId	<p>Displays the existing person for whom the deal is created in the system.</p> <p>Note: The value in this attribute appears only when the value specified in the dealEntityType attribute is EPER.</p>
accountIdentifierType	<p>Indicates the identifier type using which the account is created in the system.</p>

Attribute Name	Attribute Description
	Note: The value in this attribute appears only when the value specified in the dealEntityType attribute is EACC .
accountIdentifier	Displays the value of the account identifier type. Note: The value in this attribute appears only when the value specified in the dealEntityType attribute is EACC .
accountId	Displays the existing account for which the deal is created in the system. Note: The value in this attribute appears only when the value specified in the dealEntityType attribute is EACC .
prsPerIdentifierType	Indicates the identifier type using which the prospect person is created in the system. Note: The value in this attribute appears only when the value specified in the dealEntityType attribute is PRSP .
prsPerIdentifier	Displays the value of the prospect person identifier type. Note: The value in this attribute appears only when the value specified in the dealEntityType attribute is PRSP .
prospectPersonId	Displays the prospect person for whom the deal is created in the system. Note: The value in this attribute appears only when the value specified in the dealEntityType attribute is PRSP .
division	Indicates the division to which the entity (i.e. existing person, account, or prospect person) belongs.
dealInformation	Displays the concatenated string of information about the deal separated by a comma (,).
modelId	Displays the identification value of the deal version.
dealEntityType	Indicates the type of entity for which the deal is created in the system. The valid values are: <ul style="list-style-type: none"> • EPER - Indicates that the deal is created for an existing person. • EACC - Indicates that the deal is created for an existing account. • PRSP - Indicates that the deal is created for a prospect person.
customerSegment	Indicates the business component to which the entity (i.e. existing person, account, or prospect person) belongs.
customerTier	Indicates the customer tier of the customer segment to which the entity (i.e. existing person, account, or prospect person) belongs.
division	Indicates the division to which the entity (i.e. existing person, account, or prospect person) belongs.
accessGrp	Indicates the user group who can view and edit the details of the entity (i.e. existing person, account, or prospect person).

Attribute Name	Attribute Description
contractedDealFlag	Indicates whether the change in the price item pricing from the price list affects the price item pricing offered in the deal created for the entity (i.e. existing person, account, or prospect person) or not. The valid values are: <ul style="list-style-type: none"> • true • false
currency	Indicates the currency in which you want to calculate the deal level, division level, or product level financial summary and profitability of the deal.
dealTypeCode	Indicates the deal type using which the deal is created in the system.
startDate	Displays the date from when the deal is effective for the entity (i.e. existing person, account, or prospect person).
endDate	Displays the date till when the deal is effective for the entity (i.e. existing person, account, or prospect person).
simulationTypeFlag	Indicates the simulation type using which you want to analyze the cost, revenue, and profitability of the deal. The valid values are: <ul style="list-style-type: none"> • CUST • ACCT • DEAL
reviewFrequency	Indicates the timely monitoring of the deal usage as per the commitments made by the customer. The valid values are: <ul style="list-style-type: none"> • 6 - Used to indicate that you want to monitor the deal usage biannually. • 12 - Used to indicate that you want to monitor the deal usage annually. • 24 - Used to indicate that you want to monitor the deal usage in every two years.
dealDescription	Displays the description for the deal.
dealVersionDescription	Displays the description for the deal version.
dealFrequency	Indicates the duration in which you want to simulate the deal for calculating the financial summary and profitability of the deal. The valid values are: <ul style="list-style-type: none"> • 1 - Used to indicate that you want to simulate the deal every month • 3 - Used to indicate that you want to simulate the deal quarterly • 6 - Used to indicate that you want to simulate the deal biannually • 12 - Used to indicate that you want to simulate the deal annually
skipReferenceFlag	Indicates whether the deal is created by referring the pricing and commitments of a deal which is already created in the system. The valid values are: <ul style="list-style-type: none"> • true • false
priceSelectionDate	Displays the date from when the price lists, pricing assignments, and product enrollments are effective for simulation.
usagePeriod	Indicates the period for which you want to aggregate the deal data to determine the scope of the deal. The valid values are:

Attribute Name	Attribute Description
	<ul style="list-style-type: none"> • 1 - Used to indicate that you want to aggregate the deal data every month • 3 - Used to indicate that you want to aggregate the deal data quarterly • 6 - Used to indicate that you want to aggregate the deal data biannually • 12 - Used to indicate that you want to aggregate the deal data annually
includeHierarchyFlag	<p>Indicates whether the child persons, grandchild persons, and their accounts in the customer hierarchy are included in the deal or not. The valid values are:</p> <ul style="list-style-type: none"> • true • false
templateFlag	<p>Indicates whether the deal is used as a template while searching references for other deals. The valid values are:</p> <ul style="list-style-type: none"> • true • false
templateReferenceDetails	<p>Displays the details of the template deal which is used as a reference for creating the deal.</p>
templateDealId	<p>Displays the particular template deal which is used for creating the deal.</p>
templateDealIdentifier	<p>Displays the primary identifier using which the template deal is created in the system.</p>
templateModelId	<p>Displays the particular template deal version which is used for creating the deal.</p>
copyBasicDetailsFlag	<p>Indicates whether the basic details from the template deal are copied to create the deal or not. The valid values are:</p> <ul style="list-style-type: none"> • true • false
copyPricingFlag	<p>Indicates whether the price list assignments and price assignments from the template deal are copied to create the deal or not. The valid values are:</p> <ul style="list-style-type: none"> • true • false
copyUsageFlag	<p>Indicates whether the commitments from the SQI-based billable charges from the template deal are copied to create the deal or not. The valid values are:</p> <ul style="list-style-type: none"> • true • false
dealCharacteristics	<p>Displays the list of characteristics of the deal.</p>
characteristicType	<p>Indicates the characteristic type.</p>
effectiveDate	<p>Displays the date from when the characteristic is effective for the deal.</p>
characteristicValue	<p>Displays the value of the characteristic type.</p>
dealTermsAndConditionsDetails	<p>Displays the list of terms and conditions that are associated with the deal.</p>
termsAndConditionsList	<p>Displays the terms and conditions of the deal.</p>
description	<p>Displays the description of the terms and conditions.</p>

Attribute Name	Attribute Description
termsAndCondition	Indicates the term and condition which is associated with the deal.
termsAndConditionText	Displays additional information about the term and condition.
adhocTermsAndCondition	Displays the adhoc terms and conditions associated with the deal.
productDetailsList	Displays the list of products recommended for the deal.
productCode	Displays the product which is recommended for the deal.
referenceDetails	Displays the details of the reference deal using which the deal is created in the system.
referenceTypeFlg	Indicates the type of the reference deal using which the deal is created in the system. The valid values are: <ul style="list-style-type: none"> • RPER - Indicates that the deal is created by using the deal of an existing person as a reference. • RACC - Indicates that the deal is created by using the deal of an existing account as a reference. • RDEL - Indicates that the deal is created by using an existing deal as a reference.
refPersonIdentifierType	Displays the identifier type of the person using which the reference deal is created in the system. Note: The value in this attribute appears only when the value specified in the referenceTypeFlg attribute is RPER .
refPersonIdentifier	Displays the value of the reference person identifier type. Note: The value in this attribute appears only when the value specified in the referenceTypeFlg attribute is RPER .
referPersonId	Displays the person for whom the reference deal is created. Note: The value in this attribute appears only when the value specified in the referenceTypeFlg attribute is RPER .
refAccountIdentifierType	Displays the identifier type of the account using which the reference deal is created in the system. Note: The value in this attribute appears only when the value specified in the referenceTypeFlg attribute is RACC .
refAccountIdentifier	Displays the value of the reference account identifier type. Note: The value in this attribute appears only when the value specified in the referenceTypeFlg attribute is RACC .
referAccountId	Display the account for which the reference deal is created. Note: The value in this attribute appears only when the value specified in the referenceTypeFlg attribute is RACC .
referDealIdentifier	Displays the primary identifier using which the reference deal is created in the system.

Attribute Name	Attribute Description
	Note: The value in this attribute appears only when the value specified in the referenceTypeFlg attribute is RDEL .
referenceDealId	Displays the existing deal which is used as a reference to create the deal. Note: The value in this attribute appears only when the value specified in the referenceTypeFlg attribute is RDEL .
referenceModelId	Displays the existing deal version which is used as a reference to create the deal. Note: The value in this attribute appears only when the value specified in the referenceTypeFlg attribute is RDEL .
referUsageSw	Indicates whether the commitments from the SQI-based billable charges of the reference deal is copied to create the deal. The valid values are: <ul style="list-style-type: none"> • true • false
referPriceSw	Indicates whether the price list assignments and price assignments of the reference deal is copied to create the deal. The valid values are: <ul style="list-style-type: none"> • true • false
includeChildHierarchy	Indicates whether the child persons, grandchild persons, and their accounts of the reference deal is included while creating the deal. The valid values are: <ul style="list-style-type: none"> • true • false
dealSimulationDetails	Displays the deal level, division level, and product level simulation details of the deal.
dealfinancialsummarylist	Displays information about the financial summary at the deal level.
approvalStatus	Indicates the current approval status of the financial summary at the deal level. <ul style="list-style-type: none"> • APPR • EROR • INIT • UNAP
originalDealFinancialSummary	Displays information about the financial summary at the deal level which is calculated using the original price list assignments and price assignments.
revenue	Displays the revenue generated at the deal level from the original price list assignments and price assignments.
cost	Displays the cost calculated at the deal level from the original price list assignments and price assignments.
profit	Displays the profit in deal currency generated from the original price list assignments and price assignments at the deal level.

Attribute Name	Attribute Description
profitabilityPercentage	Displays the profit generated in percentage (%) from the original price list assignments and price assignments at the deal level.
proposedDealFinancialSummary	Displays information about the financial summary at the deal level which is calculated using the proposed price list assignments and price assignments.
revenue	Displays the revenue generated at the deal level from the proposed price list assignments and price assignments.
cost	Displays the cost calculated at the deal level from the proposed price list assignments and price assignments.
profit	Displays the profit in deal currency generated from the proposed price list assignments and price assignments at the deal level.
profitabilityPercentage	Displays the profit generated in percentage (%) from the proposed price list assignments and price assignments at the deal level.
recommendedDealFinancialSummary	Displays information about the financial summary at the deal level which is calculated using the recommended price list assignments and price assignments.
revenue	Displays the revenue generated at the deal level from the recommended price list assignments and price assignments.
profit	Displays the cost calculated at the deal level from the recommended price list assignments and price assignments.
profitabilityPercentage	Displays the profit in deal currency generated from the recommended price list assignments and price assignments at the deal level.
profitVariationPercentage	Displays the difference in the original and the proposed profits at the deal level in percentage (%).
divisionFinancialSummaryDetail	Displays information about the financial summary at the division level.
division	Indicates the division for which the financial summary is displayed.
approvalStatus	Indicates the current approval status of the financial summary at the division level. <ul style="list-style-type: none"> • APPR • EROR • INIT • UNAP
originalDivisionFinancialSummary	Displays information about the financial summary at the division level which is calculated using the original price list assignments and price assignments.
revenue	Displays the revenue generated at the division level from the original price list assignments and price assignments.
cost	Displays the cost calculated at the division level from the original price list assignments and price assignments.
profit	Displays the profit in deal currency generated from the original price list assignments and price assignments at the division level.
profitabilityPercentage	Displays the profit generated in percentage (%) from the original price list assignments and price assignments at the division level.
proposedDivisionFinancialSummary	Displays information about the financial summary at the division level which is calculated using the proposed price list assignments and price assignments.

Attribute Name	Attribute Description
revenue	Displays the revenue generated at the division level from the proposed price list assignments and price assignments.
cost	Displays the cost calculated at the division level from the proposed price list assignments and price assignments.
profit	Displays the profit in deal currency generated from the proposed price list assignments and price assignments at the division level.
profitabilityPercentage	Displays the profit generated in percentage (%) from the proposed price list assignments and price assignments at the division level.
recommendedDealFinancialSummary	Displays information about the financial summary at the division level which is calculated using the recommended price list assignments and price assignments.
revenue	Displays the revenue generated at the division level from the recommended price list assignments and price assignments.
cost	Displays the cost calculated at the division level from the recommended price list assignments and price assignments.
profit	Displays the profit in deal currency generated from the recommended price list assignments and price assignments at the division level.
profitabilityPercentage	Displays the profit generated in percentage (%) from the recommended price list assignments and price assignments at the division level.
profitVariationPercentage	Displays the difference in the original and the proposed profits at the division level in percentage (%).
productFinancialSummaryDetail	Displays information about the financial summary at the product level.
approvalStatus	Indicates the current approval status of the financial summary at the product level. <ul style="list-style-type: none"> • APPR • EROR • INIT • UNAP
product	Indicates the product for which the financial summary is displayed.
division	Indicates the division for which the product financial summary is displayed.
originalProductFinancialSummary	Displays information about the financial summary at the product level which is calculated using the original price list assignments and price assignments.
revenue	Displays the revenue generated at the product level from the original price list assignments and price assignments.
cost	Displays the cost calculated at the product level from the original price list assignments and price assignments.
profit	Displays the profit in deal currency generated from the original price list assignments and price assignments at the product level.
profitabilityPercentage	Displays the profit generated in percentage (%) from the original price list assignments and price assignments at the product level.
proposedProductDivisionFinancialSummary	Displays information about the financial summary at the product level which is calculated using the proposed price list assignments and price assignments for a particular division.

Attribute Name	Attribute Description
revenue	Displays the revenue generated at the product level from the proposed price list assignments and price assignments.
cost	Displays the cost calculated at the product level from the proposed price list assignments and price assignments.
profit	Displays the profit in deal currency generated from the proposed price list assignments and price assignments at the product level.
profitabilityPercentage	Displays the profit generated in percentage (%) from the proposed price list assignments and price assignments at the product level.
recommendedDealFinancialSummary	Displays information about the financial summary at the product level which is calculated using the recommended price list assignments and price assignments.
revenue	Displays the revenue generated at the product level from the recommended price list assignments and price assignments.
cost	Displays the cost calculated at the product level from the recommended price list assignments and price assignments.
profit	Displays the profit in deal currency generated from the recommended price list assignments and price assignments at the product level.
profitabilityPercentage	Displays the profit generated in percentage (%) from the recommended price list assignments and price assignments at the product level.
profitVariationPercentage	Displays the difference in the original and the proposed profits at the product level in percentage (%).
hierarchySimulationDetails	Displays information about the financial summary at the entity level in the customer hierarchy.
entityType	Displays the type of the entity for which the financial summary is displayed.
entityId	Displays the entity (i.e. person or account) in the customer hierarchy for which the financial summary is displayed.
parentEntityId	Displays the parent person to whom the entity (i.e. person or account) belongs in the customer hierarchy.
status	Indicates the approval status of the price assignments for the respective entity (i.e. person or account).
revenueVariation	Displays the difference in the original and the proposed revenues at the entity level in percentage (%).
proposedRevenue	Displays the revenue generated at the entity level from the proposed price list assignments and price assignments.
proposedCost	Displays the cost calculated at the entity level from the proposed price list assignments and price assignments.
originalRevenue	Displays the revenue generated at the entity level from the original price list assignments and price assignments.
originalCost	Displays the cost calculated at the entity level from the proposed price list assignments and price assignments.

Related Topics

For more information on...	See...
Sample deal view request and response in the JSON format	Sample Deal View Request Response in JSON Format on page 4143
Sample price item selection view request and response in the JSON format	Sample Price Item Selection View Request and Response in the JSON Format on page 4167

Sample Deal Creation Request and Response in the JSON Format

Using the below example, you can create the deal for 0074771343 person.

Sample Deal Creation Request in the JSON Format

```
{
  "C1-DealCreationUpdateIWS":
  {
    "actionFlag" : "ADD",
    "dealDetails"
    {
      "dealEntityDetails"
      {
        "personId" : "0074771343",
      }
      "dealIdentifier" : "EXISTINGPER1",
      "dealEntityType" : "EPER",
      "contractedDealFlag" : "false",
      "currency" : "USD",
      "dealTypeCode" : "APRTESENEW",
      "startDate" : "2022-02-26",
      "simulationTypeFlag" : "CUST",
      "reviewFrequency" : "6",
      "dealDescription" : "deal descript",
      "dealVersionDescription" : "version desc",
      "dealFrequency" : "12",
      "skipReferenceFlag" : "true",
      "priceSelectionDate" : "2022-02-22",
      "usagePeriod" : "12",
      "includeHierarchyFlag" : "true",
      "templateFlag" : "false",
    }
    "dealCharacteristics"
    {
      "characteristicType" : "ZZ-DLCHR",
      "effectiveDate" : "2021-06-01",
      "characteristicValue" : "7266725883",
    }
    "dealTermsAndConditionsDetails"
    {
      "termsAndConditionsList"
      {
        "description mapField" : "",
        "termsAndCondition" : "TEST SPE CR",
        "termsAndConditionText" : "new tc",
      }
      {
        "termsAndCondition" : "TEST_TC8",
        "termsAndConditionText" : "Test changedaaaa",
      }
    }
    "adhocTermsAndCondition" : "DOCH DESC",
  }
  "productDetailsList"
  {
```

```

    "productCode" : "AUT_MPD1_BUSS1" ,
  }
  {
    "productCode" : "AUT_MPD_930_TECH" ,
  }
  {
    "productCode" : "AUT_MPD_CA_TECH" ,
  }
  {
    "productCode" : "RTEST_BPTECT" ,
  }
}

```

Note: If you do not want to enter the data in the list attributes (i.e. attributes where the type is set to list), you should not include them in the request. Adding empty list attributes will give erroneous results.

Sample Deal Creation Response in the JSON Format

```

{
  "C1-DealCreationUpdateIWS" :
  {
    "actionFlag" : "UPD" ,
    "dealresponse"
    {
      "message" : "Deal Created Successfully." ,
    }
    "dealDetails"
    {
      "dealEntityDetails"
      {
        "personId" : "0074771343" ,
      }
      "dealIdentifier" : "EXISTINGPER1" ,
      "dealInformation" : "8896302706,Prod,Prerana,02-26-2022,United
States Dollars,Contracted Deal-No,(1),EXISTINGPER1 ,deal descript,930-
California Branch, , ,Aparna RM only,Pending Simulation,Customer,System
Default,Template-No,BKADMIN ,02-26-2022, , ,Biannually,Yearly, , ,Skip
Reference-Yes,Account,0074771343,Yearly, , ,02-22-2022, ,Skip Questionaire-
Yes, ,Include Hierarchy-Yes" ,
      "dealId" : "8896302706" ,
      "modelId" : "0662805484" ,
      "dealEntityType" : "EPER" ,
      "customerSegment" : "" ,
      "customerTier" : "" ,
      "division" : "930" ,
      "accessGrp" : "****" ,
      "dealEntityId" : "0074771343" ,
      "contractedDealFlag" : "false" ,
      "currency" : "USD" ,
      "dealTypeCode" : "APRTESENEW" ,
      "startDate" : "2022-02-26" ,
      "simulationTypeFlag" : "CUST" ,
      "reviewFrequency" : "6" ,
      "dealDescription" : "deal descript" ,
      "dealVersionDescription" : "version desc" ,
      "dealFrequency" : "12" ,
      "skipReferenceFlag" : "true" ,
      "priceSelectionDate" : "2022-02-22" ,
      "usagePeriod" : "12" ,
      "includeHierarchyFlag" : "true" ,
      "status" : "PSML" ,
      "templateFlag" : "false" ,
    }
  }
}

```

```

}
"templateReferenceDetails"
{
  "copyBasicDetailsFlag" : "false",
  "copyPricingFlag" : "false",
  "copyUsageFlag" : "false",
}
"dealCharacteristics"
{
  "characteristicType" : "ZZ-DLCHR",
  "effectiveDate" : "2021-06-01",
  "characteristicValue" : "7266725883",
}
"dealTermsAndConditionsDetails"
{
  "termsAndConditionsList"
  {
    "description" : "",
    "termsAndCondition" : "TEST SPE CR",
    "termsAndConditionText" : "new tc",
  }
  {
    "description" : "",
    "termsAndCondition" : "TEST_TC8",
    "termsAndConditionText" : "Test changedaaaa",
  }
  "adhocTermsAndCondition" : "DOCH DESC",
}
"productDetailsList"
{
  "productCode" : "AUT_MPD1_BUSS1",
}
{
  "productCode" : "AUT_MPD_930_TECH",
}
{
  "productCode" : "AUT_MPD_CA_TECH",
}
{
  "productCode" : "RTEST_BPTECT",
}
"referenceDetails"
{
  "referUsageSw" : "false",
  "referPriceSw" : "false",
}
}
}

```

Note: We have given the above request and response samples to illustrate how the attribute value pairs should be structured while sending a deal creation request from the external system. However, you should not seamlessly use this request sample in your environment because the required pre-requisite data may not be available in your environment. In such case, the system will give erroneous results.

Related Topics

For more information on...	See...
Deal creation request and response attribute/value pairs in the JSON format	Deal Creation Request and Response - Attribute Value Pairs in the JSON Format on page 4087

Sample Deal View Request Response in JSON Format

Using the below example, you can view the deal 4524551669.

Sample Deal View Request in the JSON Format

```
{
  "Cl-DealCreationUpdateIWS" :
  {
    "actionFlag" : "READ",
    "dealDetails" :
    {
      "dealId" : "4524551669",
    }
  }
}
```

Sample Deal View Response in the JSON Format

```
{
  "Cl-DealCreationUpdateIWS" :
  {
    "actionFlag" : "READ",
    "dealDetails"
    {
      "dealIdentifier" : "DEALPRS2022PER23",
      "dealInformation" : "4524551669,CITI BANK,CORP,03-09-2022,United
States Dollars,Contracted Deal-No,(1),DEALPRS2022PER23",
      "dealId" : "4524551669",
      "modelId" : "9202703256",
      "dealEntityType" : "PRSP",
      "customerSegment" : "COMM",
      "customerTier" : "T",
      "division" : "930",
      "accessGrp" : "****",
      "dealEntityId" : "0218803513",
      "contractedDealFlag" : "false",
      "currency" : "USD",
      "dealTypeCode" : "ANRMONLY",
      "startDate" : "2022-03-09",
      "endDate" : "2023-03-09",
      "simulationTypeFlag" : "CUST",
      "reviewFrequency" : "1",
      "dealDescription" : "Deal Description",
      "longDescription" : "Deal Description",
      "dealVersionDescription" : "Deal Version Description",
      "dealFrequency" : "1",
      "skipReferenceFlag" : "true",
      "priceSelectionDate" : "2022-03-09",
      "usagePeriod" : "1",
      "includeHierarchyFlag" : "true",
      "status" : "PSML",
      "templateFlag" : "false",
      "createdDate" : "2022-03-09",
    }
    "templateReferenceDetails"
    {
      "copyBasicDetailsFlag" : "false",
      "copyPricingFlag" : "false",
      "copyUsageFlag" : "false",
    }
    "dealCharacteristics"
    {
      "characteristicType" : "ABC",
      "effectiveDate" : "2021-03-09",
    }
  }
}
```

```

    "characteristicValue" : "5881231767",
  }
  "dealTermsAndConditionsDetails"
  {
    "termsAndConditionsList"
    {
      "description" : "Terms and conditions description"
      "termsAndCondition" : "Terms and conditions 1"
      "termsAndConditionText" : "Terms and conditions description"
    }
    "adhocTermsAndCondition" : "Adhoc Description",
  }
  "productDetailsList"
  {
    "productCode" : "IMA_BP1",
  }
  "referenceDetails"
  {
    "referUsageSw" : "false",
    "referPriceSw" : "false",
    "includeChildHierarchy" : "false",
  }
}

```

Note: We have given the above request and response samples to illustrate how the attribute value pairs should be structured while sending a deal view request from the external system. However, you should not seamlessly use this request sample in your environment because the required pre-requisite data may not be available in your environment. In such case, the system will give erroneous results.

Related Topics

For more information on...	See...
Deal view request and response attribute/value pairs in the JSON format	Deal View Request and Response - Attribute/Value Pairs in the JSON Format on page 4128

Sample Deal Update Request and Response in the JSON Format

Using the below example, you can update the deal 4524551669.

Sample Deal Update Request in the JSON Format

```

{
  "C1-DealCreationUpdateIWS" :
  {
    "actionFlag" : "UPD",
    "dealDetails"
    {
      "dealIdentifier" : "DEALPRS2022PER23",
      "dealInformation" : "4524551669,CITI BANK,CORP,03-09-2022,United States Dollars,Contracted Deal-No,(1),DEALPRS2022PER23",
      "dealId" : "4524551669"
      "modelId" : "9202703256"
      "dealEntityType" : "PRSP",
      "customerSegment" : "COMM",
      "customerTier" : "T",
      "division" : "930",
      "accessGrp" : "****",
      "dealEntityId" : "0218803513",
      "contractedDealFlag" : "false",
      "currency" : "USD",
      "dealTypeCode" : "ANRMONLY",
    }
  }
}

```

```

    "startDate" : "2022-03-09",
    "endDate" : "2023-03-09",
    "simulationTypeFlag" : "CUST",
    "dealDescription" : "Deal Description update",
    "dealVersionDescription" : "Deal version description update",
    "dealFrequency" : "1",
    "skipReferenceFlag" : "true",
    "priceSelectionDate" : "2022-03-09",
    "usagePeriod" : "1",
    "includeHierarchyFlag" : "true",
    "status" : "PSML",
    "dealVersionStatus" : "",
    "templateFlag" : "false",
    "createdDate" : "2022-03-09"
  }
  "templateReferenceDetails"
  {
    "copyBasicDetailsFlag" : "false",
    "copyPricingFlag" : "false",
    "copyUsageFlag" : "false",
  }
  "dealCharacteristics"
  {
    "characteristicType" : "ABC",
    "effectiveDate" : "2021-03-09",
    "characteristicValue" : "5881231767",
  }
  "dealTermsAndConditionsDetails"
  {
    "termsAndConditionsList"
    {
      "description" : "T&C 1 Desc"
      "termsAndCondition" : "T&C 1"
      "termsAndConditionText" : "Adhoc Text"
    }
    "adhocTermsAndCondition" : "Adhoc Description",
  }
  "productDetailsList"
  {
    "productCode" : "IMA_BP1",
  }
  "productDetailsList"
  {
    "productCode" : "IMA_BP2",
  }
  "referenceDetails"
  {
    "referUsageSw" : "false",
    "referPriceSw" : "false",
    "includeChildHierarchy" : "false",
  }
}

```

Note: If you do not want to enter the data in the list attributes (i.e. attributes where the type is set to list), you should not include them in the request. Adding empty list attributes will give erroneous results.

Sample Deal Update Response in the JSON Format

```

{
  "C1-DealCreationUpdateIWS" :
  {
    "actionFlag" : "UPD",
  }
}

```

```

"dealResponse"
{
  message : "Deal Updated Successfully",
}
"dealDetails"
{
  "dealIdentifier" : "DEALPRS2022PER23",
  "dealInformation" : "4524551669,CITI BANK,CORP,03-09-2022,United
States Dollars,Contracted Deal-No,(1),DEALPRS2022PER23",
  "dealId" : "4524551669",
  "modelId" : "9202703256",
  "dealEntityType" : "PRSP",
  "customerSegment" : "COMM",
  "customerTier" : "T",
  "division" : "930",
  "accessGrp" : "****",
  "dealEntityId" : "0218803513",
  "contractedDealFlag" : "false",
  "currency" : "USD",
  "dealTypeCode" : "ANRMONLY",
  "startDate" : "2022-03-09",
  "endDate" : "2023-03-09",
  "simulationTypeFlag" : "CUST",
  "dealDescription" : "Deal Description update",
  "longDescription" : "Deal description update",
  "dealVersionDescription" : "Deal version description update",
  "dealFrequency" : "1",
  "skipReferenceFlag" : "true",
  "priceSelectionDate" : "2022-03-09",
  "usagePeriod" : "1",
  "includeHierarchyFlag" : "true",
  "status" : "PSML",
  "templateFlag" : "false",
  "createdDate" : "2022-03-09",
}
"templateReferenceDetails"
{
  "copyBasicDetailsFlag" : "false",
  "copyPricingFlag" : "false",
  "copyUsageFlag" : "false",
}
"dealCharacteristics"
{
  "characteristicType" : "ABC",
  "effectiveDate" : "2021-03-09",
  "characteristicValue" : "5881231767",
}
"dealTermsAndConditionsDetails"
{
  "termsAndConditionsList"
  {
    "description" : "T&C 1 Desc"
    "termsAndCondition" : "T&C 1"
    "termsAndConditionText" : "Adhoc Text"
  }
  "adhocTermsAndCondition" : "Adhoc Description",
}
"productDetailsList"
{
  "productCode" : "IMA_BP1",
}
{
  "productCode" : "IMA_BP2",
}

```

```

    "referenceDetails"
    {
        "referUsageSw" : "false",
        "referPriceSw" : "false",
        "includeChildHierarchy" : "false",
    }
}

```

Note: We have given the above request and response samples to illustrate how the attribute value pairs should be structured while sending a deal update request from the external system. However, you should not seamlessly use this request sample in your environment because the required pre-requisite data may not be available in your environment. In such case, the system will give erroneous results.

Related Topics

For more information on...	See...
Deal update request and response attribute/value pairs in the JSON format	Deal Update Request and Response - Attribute/Value Pairs in the JSON Format on page 4108

Sample Deal Version Creation Request and Response in the JSON Format

Using the below example, you can create deal version for the deal 6287907587.

Sample Deal Version Creation Request in the JSON Format

```

{
  "Cl-DealCreationUpdateIWS" :
  {
    "actionFlag" : "ADD",
    "dealOperation"
    {
      "operationFlag" : "CRDV",
      "dealId" : "6287907587",
      "modelId" : "5765155419",
      "dealVersionDescription" : "Version 2",
      "dealVersionCreationFlag" : "FLHR",
    }
  }
}

```

Note: If you do not want to enter the data in the list attributes (i.e. attributes where the type is set to list), you should not include them in the request. Adding empty list attributes will give erroneous results.

Sample Deal Version Creation Response in the JSON Format

```

{
  "Cl-DealCreationUpdateIWS" :
  {
    "actionFlag" : "ADD",
    "dealResponse"
    {
      "message" : "Deal Version created successfully.",
    }
    "dealOperation"
    {
      "operationFlag" : "CRDV",
      "dealIdentifier" : "",
      "dealId" : "6287907587",
      "modelId" : "5765155419",
      "dealVersionDescription" : "Version 2",
      "dealVersionCreationFlag" : "FLHR",
    }
  }
}

```



```

}
"dealDetails"
{
  "dealId" : "9953437478",
  "modelId" : "8149209383",
  "dealEntityType" : "",
  "customerSegment" : "",
  "customerTier" : "",
  "division" : "",
  "accessGrp" : "",
  "dealEntityId" : "",
  "contractedDealFlag" : "false",
  "currency" : "",
  "dealTypeCode" : "",
  "startDate" : "",
  "endDate" : "",
  "simulationTypeFlag" : "false",
  "reviewFrequency" : "",
  "dealDescription" : "",
  "longDescription" : "",
  "dealVersionDescription" : "",
  "dealFrequency" : "",
  "skipReferenceFlag" : "",
  "priceSelectionDate" : "",
  "usagePeriod" : "",
  "includeHierarchyFlag" : "false",
  "status" : "",
  "dealVersionStatus" : "PSML",
  "templateFlag" : "false",
  "createdDate" : "",
  "acceptanceDate" : "",
  "finalizedDate" : "",
  "effectiveStartDate" : "",
  "effectiveEndDate" : "",
  "reviewedDate" : "",
}
"templateReferenceDetails"
{
  "templateDealId" : "",
  "templateDealIdentifier" : "",
  "templateModelId" : "",
  "copyBasicDetailsFlag" : "false",
  "copyPricingFlag" : "false",
  "copyUsageFlag" : "false",
}
"referenceDetails"
{
  "referenceTypeFlg" : "",
  "refPersonIdentifierType" : "",
  "refPersonIdentifier" : "",
  "referPersonId" : "",
  "refAccountIdentifierType" : "",
  "refAccountIdentifier" : "",
  "referAccountId" : "",
  "referDealIdentifier" : "",
  "referenceDealId" : "",
  "referenceModelId" : "",
  "referUsageSw" : "false",
  "referPriceSw" : "false",
  "includeChildHierarchy" : "false",
  "division" : "",
}
}
}

```

Note: We have given the above request and response samples to illustrate how the attribute value pairs should be structured while sending a deal version creation request from the external system. However, you should not seamlessly use this request sample in your environment because the required pre-requisite data may not be available in your environment. In such case, the system will give erroneous results.

Related Topics

For more information on...	See...
Deal update request and response attribute/value pairs in the JSON format	Deal Update Request and Response - Attribute/Value Pairs in the JSON Format on page 4108

Sample Deal Simulation Request and Response in the JSON Format

Using the below example, you can simulate the deal 1359491858.

Sample Deal Simulation Request in the JSON Format

```
{
  "C1-DealCreationUpdateIWS" :
  {
    "actionFlag" : "UPD",
    "dealOperation"
    {
      "operationFlag" : "SMLD",
      "dealId" : "1359491858",
      "modelId" : "8154562108",
    }
  }
}
```

Sample Deal Simulation Response in the JSON Format

```
{
  "C1-DealCreationUpdateIWS" :
  {
    "actionFlag" : "UPD",
    "dealResponse"
    {
      "message" : "Deal Simulated Successfully",
    }
    "dealOperation"
    {
      "operationFlag" : "SMLD",
      "dealId" : "1359491858",
      "modelId" : "8154562108",
    }
    "dealDetails"
    {
      "dealEntityDetails"
      {
        "personIdentifierType" : "",
        "personIdentifier" : "",
        "personId" : "",
        "accountIdentifierType" : "",
        "accountIdentifier" : "",
        "accountId" : "",
        "prsPerIdentifierType" : "",
        "prsPerIdentifier" : "",
        "prospectPersonId" : "",
        "division" : "",
      }
      "dealIdentifier" : "",
    }
  }
}
```

```

    "dealInformation" : "",
    "dealId" : "",
    "modelId" : "",
    "dealEntityType" : "",
    "customerSegment" : "",
    "customerTier" : "",
    "division" : "",
    "accessGrp" : "",
    "dealEntityId" : "",
    "contractedDealFlag" : "false",
    "currency" : "",
    "dealTypeCode" : "",
    "startDate" : "",
    "endDate" : "",
    "simulationTypeFlag" : "",
    "reviewFrequency" : "",
    "dealDescription" : "",
    "longDescription" : "",
    "dealVersionDescription" : "",
    "dealFrequency" : "",
    "skipReferenceFlag" : "",
    "priceSelectionDate" : "",
    "usagePeriod" : "",
    "includeHierarchyFlag" : "false",
    "status" : "SMLD",
    "dealVersionStatus" : "SMLD",
    "templateFlag" : "false",
    "createdDate" : "",
    "acceptanceDate" : "",
    "finalizedDate" : "",
    "effectiveStartDate" : "",
    "effectiveEndDate" : "",
    "reviewedDate" : "",
  }
  "templateReferenceDetails"
  {
    "templateDealId" : "",
    "templateDealIdentifier" : "",
    "templateModelId" : "",
    "copyBasicDetailsFlag" : "false",
    "copyPricingFlag" : "false",
    "copyUsageFlag" : "false",
  }
  "dealCharacteristics"
  {
    "characteristicType" : "",
    "effectiveDate" : "",
    "characteristicValue" : "",
  }
  "dealTermsAndConditionsDetails"
  {
    "termsAndConditionsList"
    {
      "description" : ""
      "termsAndCondition" : ""
      "termsAndConditionText" : ""
    }
    "adhocTermsAndCondition" : "",
  }
  "productDetailsList"
  {
    "productCode" : "",
  }
  "referenceDetails"

```

```

{
  "referenceTypeFlg" : "",
  "refPersonIdentifierType" : "",
  "refPersonIdentifier" : "",
  "referPersonId" : "",
  "refAccountIdentifierType" : "",
  "refAccountIdentifier" : "",
  "referAccountId" : "",
  "referDealIdentifier" : "",
  "referenceDealId" : "",
  "referenceModelId" : "",
  "referUsageSw" : "false",
  "referPriceSw" : "false",
  "includeChildHierarchy" : "false",
  "division" : ""
}
"dealSimulationDetails"
{
  "dealfinancialsummarylist"
  {
    "approvalStatus" : "",
  }
  "originalDealFinanciencialSummary"
  {
    "revenue" : "$0.00",
    "cost" : "$0.00",
    "profit" : "$0.00",
    "profitabilityPercentage" : "$0.00",
  }
  "proposedDealFinanciencialSummary"
  {
    "revenue" : "$1,250.00",
    "cost" : "$50.00",
    "profit" : "$1,200.00",
    "profitabilityPercentage" : "96.00",
  }
  "recommenedDealFinanciencialSummary"
  {
    "revenue" : "",
    "profit" : "",
    "profitabilityPercentage" : "",
  }
  "profitVariationPercentage" : "",
}
"divisionFinancialSummaryDetails"
{
  "division" : "",
  "approvalStatus" : "",
  "originalDivisionFinanciencialSummary"
  {
    "revenue" : "",
    "cost" : "",
    "profit" : "",
    "profitabilityPercentage" : "",
  }
  "proposedDivisionFinanciencialSummary"
  {
    "revenue" : "",
    "cost" : "",
    "profit" : "",
    "profitabilityPercentage" : "",
  }
  "recommenedDealFinanciencialSummary"
  {

```

```

        "revenue" : "",
        "profit" : "",
        "profitabilityPercentage" : "",
    }
    "profitVariationPercentage" : "",
}
"productFinancialSummaryDetails"
{
    "approvalStatus" : "",
    "product" : "",
    "division" : "",
    "originalProductFinancialSummary"
    {
        "revenue" : "",
        "cost" : "",
        "profit" : "",
        "profitabilityPercentage" : "",
    }
    "proposedProductDivisionFinancialSummary"
    {
        "revenue" : "",
        "cost" : "",
        "profit" : "",
        "profitabilityPercentage" : "",
    }
    "recommendedDealFinancialSummary"
    {
        "revenue" : "",
        "profit" : "",
        "profitabilityPercentage" : "",
    }
    "profitVariationPercentage" : "",
}
}
"hierarchySimulationDetails"
{
    "hierarchyDetails"
    {
        "entityType" : "PERS",
        "entityId" : "3865913714",
        "parentEntityId" : "",
        "status" : "Unapproved",
        "revenueVariation" : "0.00",
        "proposedRevenue" : "$1,250.00",
        "proposedCost" : "$50.00",
        "originalRevenue" : "$0.00",
        "originalCost" : "$0.00",
    }
    "hierarchyDetails"
    {
        "entityType" : "ACCT",
        "entityId" : "2564512509",
        "parentEntityId" : "3865913714",
        "status" : "Unapproved",
        "revenueVariation" : "0.00",
        "proposedRevenue" : "$1,250.00",
        "proposedCost" : "$50.00",
        "originalRevenue" : "$0.00",
        "originalCost" : "$0.00",
    }
    "hierarchyDetails"
    {
        "entityType" : "PERS",
        "entityId" : "3863028908",

```

```

        "parentEntityId" : "3865913714",
        "status" : "Unapproved",
        "revenueVariation" : "0.00",
        "proposedRevenue" : "$0.00",
        "proposedCost" : "$0.00",
        "originalRevenue" : "$0.00",
        "originalCost" : "$0.00",
    }
    "hierarchyDetails"
    {
        "entityType" : "PERS",
        "entityId" : "1483750392",
        "parentEntityId" : "3863028908",
        "status" : "Unapproved",
        "revenueVariation" : "0.00",
        "proposedRevenue" : "$0.00",
        "proposedCost" : "$0.00",
        "originalRevenue" : "$0.00",
        "originalCost" : "$0.00",
    }
}
}
}
}

```

Note: We have given the above request and response samples to illustrate how the attribute value pairs should be structured while sending a deal simulation request from the external system. However, you should not seamlessly use this request sample in your environment because the required pre-requisite data may not be available in your environment. In such case, the system will give erroneous results.

Related Topics

For more information on...	See...
Deal update request and response attribute/value pairs in the JSON format	Deal Update Request and Response - Attribute/Value Pairs in the JSON Format on page 4108

Sample Deal Submission for Approval Request and Response in the JSON Format

Using the below example, you can submit the deal 0174339883 for approval.

Sample Deal Simulation for Approval Request in the JSON Format

```

{
  "C1-DealCreationUpdateIWS" :
  {
    "actionFlag" : "UPD",
    "dealOperation"
    {
      "operationFlag" : "SNDP",
      "dealId" : "0174339883",
    }
  }
}

```

Sample Deal Simulation for Approval Response in the JSON Format

```

{
  "C1-DealCreationUpdateIWS" :
  {
    "actionFlag" : "UPD",
    "dealResponse"
    {
      message : "Deal Submitted for Approval Successfully.",
    }
  }
}

```

```

}
"dealOperation"
{
  "operationFlag" : "SNDP",
  "dealId" : "0174339883",
}
"dealDetails"
{
  "dealIdentifier" : "",
  "dealInformation" : "",
  "dealId" : "",
  "modelId" : "",
  "dealEntityType" : "",
  "customerSegment" : "",
  "customerTier" : "",
  "division" : "",
  "accessGrp" : "",
  "dealEntityId" : "",
  "contractedDealFlag" : "false",
  "currency" : "",
  "dealTypeCode" : "",
  "startDate" : "",
  "endDate" : "",
  "simulationTypeFlag" : "",
  "reviewFrequency" : "",
  "dealDescription" : "",
  "longDescription" : "",
  "dealVersionDescription" : "",
  "dealFrequency" : "",
  "skipReferenceFlag" : "false",
  "priceSelectionDate" : "",
  "usagePeriod" : "",
  "includeHierarchyFlag" : "false",
  "status" : "",
  "dealVersionStatus" : "",
  "templateFlag" : "",
  "createdDate" : "",
  "acceptanceDate" : "",
  "finalizedDate" : "",
  "effectiveStartDate" : "",
  "effectiveEndDate" : "",
  "reviewedDate" : "",
}
"templateReferenceDetails"
{
  "templateDealId" : "",
  "templateDealIdentifier" : "",
  "templateModelId" : "",
  "copyBasicDetailsFlag" : "false",
  "copyPricingFlag" : "false",
  "copyUsageFlag" : "false",
}
"referenceDetails"
{
  "referenceTypeFlg" : "",
  "refPersonIdentifierType" : "",
  "refPersonIdentifier" : "",
  "referPersonId" : "",
  "refAccountIdentifierType" : "",
  "refAccountIdentifier" : "",
  "referAccountId" : "",
  "referDealIdentifier" : "",
  "referenceDealId" : "",
  "referenceModelId" : "",

```

```

        "referUsageSw" : "false",
        "referPriceSw" : "false",
        "includeChildHierarchy" : "",
        "division" : "",
    }
}
}

```

Note: We have given the above request and response samples to illustrate how the attribute value pairs should be structured while sending a deal submission for approval request from the external system. However, you should not seamlessly use this request sample in your environment because the required pre-requisite data may not be available in your environment. In such case, the system will give erroneous results.

Related Topics

For more information on...	See...
Deal update request and response attribute/value pairs in the JSON format	Deal Update Request and Response - Attribute/Value Pairs in the JSON Format on page 4108

Sample Deal Approval Request and Response in the JSON Format

Using the below example, you can approve the deal 0174339883.

Sample Deal Approval Request in the JSON Format

```

{
  "C1-DealCreationUpdateIWS" :
  {
    "actionFlag" : "UPD",
    "dealOperation"
    {
      "operationFlag" : "APPR",
      "dealId" : "0174339883",
    }
  }
}

```

Sample Deal Approval Response in the JSON Format

```

{
  "C1-DealCreationUpdateIWS" :
  {
    "actionFlag" : "UPD",
    "dealResponse"
    {
      message : "Deal Approved Successfully",
    }
    "dealOperation"
    {
      "operationFlag" : "APPR",
      "dealId" : "0174339883",
    }
  }
  "dealDetails"
  {
    "dealEntityDetails"
    "dealIdentifier" : "",
    "dealInformation" : "",
    "dealId" : "",
    "modelId" : "",
    "dealEntityType" : "",
    "customerSegment" : "",
    "customerTier" : "",
  }
}

```



```

    "division" : "",
    "accessGrp" : "",
    "dealEntityId" : "",
    "contractedDealFlag" : "false",
    "currency" : "",
    "dealTypeCode" : "",
    "startDate" : "",
    "endDate" : "",
    "simulationTypeFlag" : "",
    "reviewFrequency" : "",
    "dealDescription" : "",
    "longDescription" : "",
    "dealVersionDescription" : "",
    "dealFrequency" : "",
    "skipReferenceFlag" : "false",
    "priceSelectionDate" : "",
    "usagePeriod" : "",
    "includeHierarchyFlag" : "false",
    "status" : "",
    "dealVersionStatus" : "",
    "templateFlag" : "false",
    "createdDate" : "",
    "acceptanceDate" : "",
    "finalizedDate" : "",
    "effectiveStartDate" : "",
    "effectiveEndDate" : "",
    "reviewedDate" : "",
  }
  "templateReferenceDetails"
  {
    "templateDealId" : "",
    "templateDealIdentifier" : "",
    "templateModelId" : "",
    "copyBasicDetailsFlag" : "false",
    "copyPricingFlag" : "false",
    "copyUsageFlag" : "false",
  }
  "dealCharacteristics"
  {
    "characteristicType" : "",
    "effectiveDate" : "",
    "characteristicValue" : "",
  }
  "dealTermsAndConditionsDetails"
  {
    "termsAndConditionsList"
    {
      "description mapField="DESCR"/>
      "termsAndCondition fkRef="TERMNCON" mapField="TC_TYPE_CD"/>
      "termsAndConditionText mapField="LONG_DESC"/>
    }
    "adhocTermsAndCondition" : "",
  }
  "productDetailsList"
  {
    "productCode" : "",
  }
  "referenceDetails"
  {
    "referenceTypeFlg" : "",
    "refPersonIdentifierType" : "",
    "refPersonIdentifier" : "",
    "referPersonId" : "",
    "refAccountIdentifierType" : "",
  }

```

```

        "refAccountIdentifier" : "",
        "referAccountId" : "",
        "referDealIdentifier" : "",
        "referenceDealId" : "",
        "referenceModelId" : "",
        "referUsageSw" : "false",
        "referPriceSw" : "false",
        "includeChildHierarchy" : "",
        "division" : "",
    }
}
}

```

Note: We have given the above request and response samples to illustrate how the attribute value pairs should be structured while sending a deal approval request from the external system. However, you should not seamlessly use this request sample in your environment because the required pre-requisite data may not be available in your environment. In such case, the system will give erroneous results.

Related Topics

For more information on...	See...
Deal update request and response attribute/value pairs in the JSON format	Deal Update Request and Response - Attribute/Value Pairs in the JSON Format on page 4108

Sample Deal Return to Submitter Request and Response in the JSON Format

Using the below example, you can return to submit the deal 0786194281.

Sample Deal Return Submitter Request in the JSON Format

```

{
  "C1-DealCreationUpdateIWS":
  {
    "actionFlag" : "UPD",
    "dealOperation"
    {
      "operationFlag" : "RETN",
      "dealId" : "0786194281",
      "modelId" : "9319862860",
      "comments" : "insufficient sqi"
      "rejectReasonCode" : "R04",
    }
  }
}

```

Sample Deal Return Submitter Response in the JSON Format

```

{
  "C1-DealCreationUpdateIWS":
  {
    "actionFlag" : "UPD",
    "dealResponse"
    {
      message : "Deal Returned to Submitter Successfully",
    }
    "dealOperation"
    {
      "operationFlag" : "RETN",
      "dealIdentifier" : "",
      "dealId" : "0786194281",
      "modelId" : "9319862860",
      "dealAcceptEffStartDate" : "",
    }
  }
}

```

```

    "dealAcceptEffEndDate" : "",
    "comments" : "insufficient sqi",
    "rejectReasonCode" : "R04",
  }
  "dealDetails"
  {
    "dealIdentifier" : "",
    "dealInformation" : "",
    "dealId" : "",
    "modelId" : "",
    "dealEntityType" : "",
    "customerSegment" : "",
    "customerTier" : "",
    "division" : "",
    "accessGrp" : "",
    "dealEntityId" : "",
    "contractedDealFlag" : "false",
    "currency" : "",
    "dealTypeCode" : "",
    "startDate" : "",
    "endDate" : "",
    "simulationTypeFlag" : "",
    "reviewFrequency" : "",
    "dealDescription" : "",
    "longDescription" : "",
    "dealVersionDescription" : "",
    "dealFrequency" : "",
    "skipReferenceFlag" : "false",
    "priceSelectionDate" : "",
    "usagePeriod" : "",
    "includeHierarchyFlag" : "false",
    "status" : "",
    "dealVersionStatus" : "",
    "templateFlag" : "false",
    "createdDate" : "",
    "acceptanceDate" : "",
    "finalizedDate" : "",
    "effectiveStartDate" : "",
    "effectiveEndDate" : "",
    "reviewedDate" : "",
  }
  "templateReferenceDetails"
  {
    "templateDealId" : "",
    "templateDealIdentifier" : "",
    "templateModelId" : "",
    "copyBasicDetailsFlag" : "false",
    "copyPricingFlag" : "false",
    "copyUsageFlag" : "false",
  }
  "referenceDetails"
  {
    "referenceTypeFlg" : "",
    "refPersonIdentifierType" : "",
    "refPersonIdentifier" : "",
    "referPersonId" : "",
    "refAccountIdentifierType" : "",
    "refAccountIdentifier" : "",
    "referAccountId" : "",
    "referDealIdentifier" : "",
    "referenceDealId" : "",
    "referenceModelId" : "",
    "referUsageSw" : "false",
    "referPriceSw" : "false",
  }

```

```

        "includeChildHierarchy" : "false",
        "division" : "",
    }
}

```

Note: We have given the above request and response samples to illustrate how the attribute value pairs should be structured while sending a deal return to submitter request from the external system. However, you should not seamlessly use this request sample in your environment because the required pre-requisite data may not be available in your environment. In such case, the system will give erroneous results.

Related Topics

For more information on...	See...
Deal update request and response attribute/value pairs in the JSON format	Deal Update Request and Response - Attribute/Value Pairs in the JSON Format on page 4108

Sample Deal Finalization Request and Response in the JSON Format

Using the below example, you can finalize the deal 4524551669 whose deal identifier is 0174339883.

Sample Deal Finalization Request in the JSON Format

```

{
  "C1-DealCreationUpdateIWS" :
  {
    "actionFlag" : "UPD",
    "dealOperation"
    {
      "operationFlag" : "FNAL",
      "dealIdentifier" : "DEALPRS2022PER23",
    }
  }
}

```

Sample Deal Finalization Response in the JSON Format

```

{
  "C1-DealCreationUpdateIWS" :
  {
    "actionFlag" : "UPD",
    "dealResponse"
    {
      message : "Deal Finalized Successfully",
    }
    "dealOperation"
    {
      "operationFlag" : "FNAL",
      "dealIdentifier" : "DEALPRS2022PER23",
      "dealId" : "4524551669",
    }
  }
  "priceItemGroupSelection"
  {
    "priceItemSelectionList"
    {
      "priceItemCode" : "",
      "priceItemInfo" : "",
      "parameterInfo" : "",
      "assignmentLevel" : "",
      "priceAssignmentId" : "",
      "hierarchyDetails" : "",
      "includeFlag" : "",
    }
  }
}

```

```

    }
  }
  "dealDetails"
  {
    "dealIdentifier" : "",
    "dealInformation" : "",
    "dealId" : "",
    "modelId" : "",
    "dealEntityType" : "",
    "customerSegment" : "",
    "customerTier" : "",
    "division" : "",
    "accessGrp" : "",
    "dealEntityId" : "",
    "contractedDealFlag" : "false",
    "currency" : "",
    "dealTypeCode" : "",
    "startDate" : "",
    "endDate" : "",
    "simulationTypeFlag" : "",
    "reviewFrequency" : "",
    "dealDescription" : "",
    "longDescription" : "",
    "dealVersionDescription" : "",
    "dealFrequency" : "",
    "skipReferenceFlag" : "false",
    "priceSelectionDate" : "",
    "usagePeriod" : "",
    "includeHierarchyFlag" : "false",
    "status" : "",
    "dealVersionStatus" : "",
    "templateFlag" : "false",
    "createdDate" : "",
    "acceptanceDate" : "",
    "finalizedDate" : "",
    "effectiveStartDate" : "",
    "effectiveEndDate" : "",
    "reviewedDate" : "",
  }
  "templateReferenceDetails"
  {
    "templateDealId" : "",
    "templateDealIdentifier" : "",
    "templateModelId" : "",
    "copyBasicDetailsFlag" : "false",
    "copyPricingFlag" : "false",
    "copyUsageFlag" : "false",
  }
  "referenceDetails"
  {
    "referenceTypeFlg" : "",
    "refPersonIdentifierType" : "",
    "refPersonIdentifier" : "",
    "referPersonId" : "",
    "refAccountIdentifierType" : "",
    "refAccountIdentifier" : "",
    "referAccountId" : "",
    "referDealIdentifier" : "",
    "referenceDealId" : "",
    "referenceModelId" : "",
    "referUsageSw" : "false",
    "referPriceSw" : "false",
    "includeChildHierarchy" : "false",
    "division" : "",
  }

```

```

    }
  }
}

```

Note: We have given the above request and response samples to illustrate how the attribute value pairs should be structured while sending a deal finalize request from the external system. However, you should not seamlessly use this request sample in your environment because the required pre-requisite data may not be available in your environment. In such case, the system will give erroneous results.

Related Topics

For more information on...	See...
Deal update request and response attribute/value pairs in the JSON format	Deal Update Request and Response - Attribute/Value Pairs in the JSON Format on page 4108

Sample Deal Acceptance Request and Response in the JSON Format

Using the below example, you can accept the deal 4524551669 whose deal identifier is DEALPRS2022PER23.

Sample Deal Acceptance Request in the JSON Format

```

{
  "C1-DealCreationUpdateIWS" :
  {
    "actionFlag" : "UPD",
    "dealOperation"
    {
      "operationFlag" : "ACPT",
      "dealIdentifier" : "DEALPRS2022PER23",
      "dealAcceptEffStartDate" : "2022-03-09",
      "comments" : "deal accepted",
    }
  }
}

```

Sample Deal Acceptance Response in the JSON Format

```

{
  "C1-DealCreationUpdateIWS" :
  {
    "actionFlag" : "UPD",
    "dealResponse"
    {
      message : "Deal Accepted Successfully.",
    }
    "dealOperation"
    {
      "operationFlag" : "ACPT",
      "dealIdentifier" : "DEALPRS2022PER23",
      "dealId" : "4524551669",
      "dealAcceptEffStartDate" : "2022-03-09",
      "comments" : "deal accepted",
    }
  }
  "dealDetails"
  {
    "dealIdentifier" : "",
    "dealInformation" : "",
    "dealId" : "",
    "modelId" : "",
    "dealEntityType" : "",
    "customerSegment" : "",
    "customerTier" : "",
  }
}

```

```

    "division" : "",
    "accessGrp" : "",
    "dealEntityId" : "",
    "contractedDealFlag" : "false",
    "currency" : "",
    "dealTypeCode" : "",
    "startDate" : "",
    "endDate" : "",
    "simulationTypeFlag" : "false",
    "reviewFrequency" : "",
    "dealDescription" : "",
    "longDescription" : "",
    "dealVersionDescription" : "",
    "dealFrequency" : "",
    "skipReferenceFlag" : "",
    "priceSelectionDate" : "",
    "usagePeriod" : "",
    "includeHierarchyFlag" : "false",
    "status" : "",
    "dealVersionStatus" : "",
    "templateFlag" : "false",
    "createdDate" : "",
    "acceptanceDate" : "",
    "finalizedDate" : "",
    "effectiveStartDate" : "",
    "effectiveEndDate" : "",
    "reviewedDate" : "",
  }
  "templateReferenceDetails"
  {
    "templateDealId" : "",
    "templateDealIdentifier" : "",
    "templateModelId" : "",
    "copyBasicDetailsFlag" : "false",
    "copyPricingFlag" : "false",
    "copyUsageFlag" : "false",
  }
  "referenceDetails"
  {
    "referenceTypeFlg" : "",
    "refPersonIdentifierType" : "",
    "refPersonIdentifier" : "",
    "referPersonId" : "",
    "refAccountIdentifierType" : "",
    "refAccountIdentifier" : "",
    "referAccountId" : "",
    "referDealIdentifier" : "",
    "referenceDealId" : "",
    "referenceModelId" : "",
    "referUsageSw" : "false",
    "referPriceSw" : "false",
    "includeChildHierarchy" : "false",
    "division" : "",
  }
}

```

Note: We have given the above request and response samples to illustrate how the attribute value pairs should be structured while sending a deal acceptance request from the external system. However, you should not seamlessly use this request sample in your environment because the required pre-requisite data may not be available in your environment. In such case, the system will give erroneous results.

Related Topics

For more information on...	See...
Deal update request and response attribute/value pairs in the JSON format	Deal Update Request and Response - Attribute/Value Pairs in the JSON Format on page 4108

Sample Deal Rejection Request and Response in the JSON Format

Using the below example, you can reject the deal 9271498204 whose deal identifier is DEALPRS202209.

Sample Deal Rejection Request in the JSON Format

```
{
  "Cl-DealCreationUpdateIWS":
  {
    "actionFlag" : "UPD",
    "dealOperation"
    {
      "operationFlag" : "REJC",
      "dealIdentifier" : "DEALPRS202209",
      "comments" : "Deal Rejected",
      "rejectReasonCode" : "DLRTHI",
    }
  }
}
```

Sample Deal Rejection Response in the JSON Format

```
{
  "Cl-DealCreationUpdateIWS":
  {
    "actionFlag" : "UPD",
    "dealResponse"
    {
      "message" : "Deal Rejected Successfully.",
    }
    "dealOperation"
    {
      "operationFlag" : "REJC",
      "dealIdentifier" : "DEALPRS202209",
      "dealId" : "9271498204",
      "comments" : "Deal Rejected",
      "rejectReasonCode" : "DLRTHI",
    }
    "dealDetails"
    {
      "dealIdentifier" : "",
      "dealInformation" : "",
      "dealId" : "",
      "modelId" : "",
      "dealEntityType" : "",
      "customerSegment" : "",
      "customerTier" : "",
      "division" : "",
      "accessGrp" : "",
      "dealEntityId" : "",
      "contractedDealFlag" : "false",
      "currency" : "",
      "dealTypeCode" : "",
      "startDate" : "",
      "endDate" : "",
      "simulationTypeFlag" : "",
      "reviewFrequency" : "",
      "dealDescription" : "",
      "longDescription" : "",
    }
  }
}
```



```

    "dealVersionDescription" : "",
    "dealFrequency" : "",
    "skipReferenceFlag" : "false",
    "priceSelectionDate" : "",
    "usagePeriod" : "",
    "includeHierarchyFlag" : "false",
    "status" : "",
    "dealVersionStatus" : "",
    "templateFlag" : "false",
    "createdDate" : "",
    "acceptanceDate" : "",
    "finalizedDate" : "",
    "effectiveStartDate" : "",
    "effectiveEndDate" : "",
    "reviewedDate" : "",
  }
  "templateReferenceDetails"
  {
    "templateDealId" : "",
    "templateDealIdentifier" : "",
    "templateModelId" : "",
    "copyBasicDetailsFlag" : "false",
    "copyPricingFlag" : "false",
    "copyUsageFlag" : "false",
  }
  "referenceDetails"
  {
    "referenceTypeFlg" : "",
    "refPersonIdentifierType" : "",
    "refPersonIdentifier" : "",
    "referPersonId" : "",
    "refAccountIdentifierType" : "",
    "refAccountIdentifier" : "",
    "referAccountId" : "",
    "referDealIdentifier" : "",
    "referenceDealId" : "",
    "referenceModelId" : "",
    "referUsageSw" : "false",
    "referPriceSw" : "false",
    "includeChildHierarchy" : "false",
    "division" : "",
  }
}
}
}

```

Note: We have given the above request and response samples to illustrate how the attribute value pairs should be structured while sending a deal reject request from the external system. However, you should not seamlessly use this request sample in your environment because the required pre-requisite data may not be available in your environment. In such case, the system will give erroneous results.

Related Topics

For more information on...	See...
Deal update request and response attribute/value pairs in the JSON format	Deal Update Request and Response - Attribute/Value Pairs in the JSON Format on page 4108

Sample Deal Discard Request and Response in the JSON Format

Using the below example, you can discard the deal version 9319862860.

Sample Deal Discard Request in the JSON Format

```
{
  "C1-DealCreationUpdateIWS":
  {
    "actionFlag" : "UPD",
    "dealOperation"
    {
      "operationFlag" : "DSCR",
      "dealId" : "0786194281",
      "modelId" : "9319862860",
    }
  }
}
```

Sample Deal Discard Response in the JSON Format

```
{
  "C1-DealCreationUpdateIWS":
  {
    "actionFlag" : "UPD",
    "dealResponse"
    {
      message : "Deal Discarded Successfully",
    }
    "dealOperation"
    {
      "operationFlag" : "DSCR",
      "dealId" : "0786194281",
      "modelId" : "9319862860",
    }
    "dealDetails"
    {
      "dealIdentifier" : "",
      "dealInformation" : "",
      "dealId" : "",
      "modelId" : "",
      "dealEntityType" : "",
      "customerSegment" : "",
      "customerTier" : "",
      "division" : "",
      "accessGrp" : "",
      "dealEntityId" : "",
      "contractedDealFlag" : "false",
      "currency" : "",
      "dealTypeCode" : "",
      "startDate" : "",
      "endDate" : "",
      "simulationTypeFlag" : "",
      "reviewFrequency" : "",
      "dealDescription" : "",
      "longDescription" : "",
      "dealVersionDescription" : "",
      "dealFrequency" : "",
      "skipReferenceFlag" : "false",
      "priceSelectionDate" : "",
      "usagePeriod" : "",
      "includeHierarchyFlag" : "false",
      "status" : "",
      "dealVersionStatus" : "",
      "templateFlag" : "false",
      "createdDate" : "",
      "acceptanceDate" : "",
      "finalizedDate" : "",
    }
  }
}
```

```

    "effectiveStartDate" : "",
    "effectiveEndDate" : "",
    "reviewedDate" : "",
  }
  "templateReferenceDetails"
  {
    "templateDealId" : "",
    "templateDealIdentifier" : "",
    "templateModelId" : "",
    "copyBasicDetailsFlag" : "false",
    "copyPricingFlag" : "false",
    "copyUsageFlag" : "false",
  }
  "referenceDetails"
  {
    "referenceTypeFlg" : "",
    "refPersonIdentifierType" : "",
    "refPersonIdentifier" : "",
    "referPersonId" : "",
    "refAccountIdentifierType" : "",
    "refAccountIdentifier" : "",
    "referAccountId" : "",
    "referDealIdentifier" : "",
    "referenceDealId" : "",
    "referenceModelId" : "",
    "referUsageSw" : "false",
    "referPriceSw" : "false",
    "includeChildHierarchy" : "false",
    "division" : "",
  }
}
}
}

```

Note: We have given the above request and response samples to illustrate how the attribute value pairs should be structured while sending a deal discard request from the external system. However, you should not seamlessly use this request sample in your environment because the required pre-requisite data may not be available in your environment. In such case, the system will give erroneous results.

Related Topics

For more information on...	See...
Deal update request and response attribute/value pairs in the JSON format	Deal Update Request and Response - Attribute/Value Pairs in the JSON Format on page 4108

Sample Price Item Selection View Request and Response in the JSON Format

Using the below example, you can view the deal 6287907587.

Sample Deal View Request in the JSON Format

```

{
  "C1-DealCreationUpdateIWS" :
  {
    "actionFlag" : "READ",
    "dealOperation"
    {
      "operationFlag" : "PSEL",
      "dealId" : "6287907587",
    }
  }
}

```

Sample Deal View Response in the JSON Format

```

{
  "Cl-DealCreationUpdateIWS":
  {
    "actionFlag" : "READ",
    "dealOperation"
    {
      "operationFlag" : "PSEL",
      "dealId" : "6287907587",
    }
    "priceItemGroupSelection"
    {
      "priceItemSelectionList"
      {
        "priceItemCode" : "ACH",
        "priceItemInfo" : "ACH, Automated Clearing House",
        "parameterInfo" : "",
        "assignmentLevel" : "Global Price List",
        "priceAssignmentId" : "",
        "hierarchyDetails" : "false",
        "includeFlag" : "false",
      }
    }
  }
  "dealDetails"
  {
    "dealIdentifier" : "",
    "dealInformation" : "",
    "dealId" : "6287907587",
    "modelId" : "5765155419",
    "dealEntityType" : "",
    "customerSegment" : "",
    "customerTier" : "",
    "division" : "",
    "accessGrp" : "",
    "dealEntityId" : "",
    "contractedDealFlag" : "false",
    "currency" : "",
    "dealTypeCode" : "",
    "startDate" : "",
    "endDate" : "",
    "simulationTypeFlag" : "",
    "reviewFrequency" : "",
    "dealDescription" : "",
    "longDescription" : "",
    "dealVersionDescription" : "",
    "dealFrequency" : "",
    "skipReferenceFlag" : "false",
    "priceSelectionDate" : "",
    "usagePeriod" : "",
    "includeHierarchyFlag" : "",
    "status" : "",
    "dealVersionStatus" : "",
    "templateFlag" : "false",
    "createdDate" : "",
    "acceptanceDate" : "",
    "finalizedDate" : "",
    "effectiveStartDate" : "",
    "effectiveEndDate" : "",
    "reviewedDate" : ""
  }
  "templateReferenceDetails"
  {
    "templateDealId" : "",
  }
}

```

```

        "templateDealIdentifier" : "",
        "templateModelId" : "",
        "copyBasicDetailsFlag" : "false",
        "copyPricingFlag" : "false",
        "copyUsageFlag" : "false",
    }
    "referenceDetails"
    {
        "referenceTypeFlg" : "",
        "refPersonIdentifierType" : "",
        "refPersonIdentifier" : "",
        "referPersonId" : "",
        "refAccountIdentifierType" : "",
        "refAccountIdentifier" : "",
        "referAccountId" : "",
        "referDealIdentifier" : "",
        "referenceDealId" : "",
        "referenceModelId" : "",
        "referUsageSw" : "false",
        "referPriceSw" : "false",
        "includeChildHierarchy" : "false",
        "division" : "",
    }
}
}
}

```

Note: We have given the above request and response samples to illustrate how the attribute value pairs should be structured while sending a price item selection view request from the external system. However, you should not seamlessly use this request sample in your environment because the required pre-requisite data may not be available in your environment. In such case, the system will give erroneous results.

Related Topics

For more information on...	See...
Deal update request and response attribute/value pairs in the JSON format	Deal Update Request and Response - Attribute/Value Pairs in the JSON Format on page 4108

Sample Price Item Selection Request and Response in the JSON Format

Using the below example, you can select price item for the deal 6287907587.

Sample Price Item Selection Request in the JSON Format

```

{
  "Cl-DealCreationUpdateIWS" :
  {
    "actionFlag" : "UPD",
    "dealOperation"
    {
      "operationFlag" : "PSEL",
      "dealId" : "6287907587",
    }
    "priceItemGroupSelection"
    {
      "priceItemSelectionList"
      {
        "priceItemCode" : "ACH",
        "priceItemInfo" : "ACH, Automated Clearing House",
        "assignmentLevel" : "Global Price List",
        "priceAssignmentId" : "4040864221",
        "includeFlag" : "true",
      }
    }
  }
}

```

```

    }
  }
}

```

Sample Price Item Selection Response in the JSON Format

```

{
  "C1-DealCreationUpdateIWS" :
  {
    "actionFlag" : "UPD",
    "dealResponse"
    {
      "message" : "",
    }
    "dealOperation"
    {
      "operationFlag" : "PSEL",
      "dealId" : "6287907587",
    }
    "priceItemGroupSelection"
    {
      "priceItemSelectionList"
      {
        "priceItemCode" : "ACH",
        "priceItemInfo" : "ACH, Automated Clearing House",
        "assignmentLevel" : "Global Price List",
        "priceAssignmentId" : "4040864221",
        "includeFlag" : "true",
      }
    }
  }
  "dealDetails"
  {
    "dealEntityDetails"
    {
      "personIdentifierType" : "",
      "personIdentifier" : "",
      "personId" : "",
      "accountIdentifierType" : "",
      "accountIdentifier" : "",
      "accountId" : "",
      "prsPerIdentifierType" : "",
      "prsPerIdentifier" : "",
      "prospectPersonId" : "",
      "division" : "",
    }
    "dealIdentifier" : "",
    "dealInformation" : "",
    "dealId" : "6287907587",
    "modelId" : "5765155419",
    "dealEntityType" : "",
    "customerSegment" : "",
    "customerTier" : "",
    "division" : "",
    "accessGrp" : "",
    "dealEntityId" : "",
    "contractedDealFlag" : "false",
    "currency" : "",
    "dealTypeCode" : "",
    "startDate" : "",
    "endDate" : "",
    "simulationTypeFlag" : "",
    "reviewFrequency" : "",
    "dealDescription" : "",
    "longDescription" : "",
  }
}

```

```

        "dealVersionDescription" : "",
        "dealFrequency" : "",
        "skipReferenceFlag" : "false",
        "priceSelectionDate" : "",
        "usagePeriod" : "",
        "includeHierarchyFlag" : "false",
        "status" : "",
        "dealVersionStatus" : "",
        "templateFlag" : "false",
        "createdDate" : "",
        "acceptanceDate" : "",
        "finalizedDate" : "",
        "effectiveStartDate" : "",
        "effectiveEndDate" : "",
        "reviewedDate" : "",
    }
    "templateReferenceDetails"
    {
        "templateDealId" : "",
        "templateDealIdentifier" : "",
        "templateModelId" : "",
        "copyBasicDetailsFlag" : "false",
        "copyPricingFlag" : "false",
        "copyUsageFlag" : "false",
    }
    "referenceDetails"
    {
        "referenceTypeFlg" : "",
        "refPersonIdentifierType" : "",
        "refPersonIdentifier" : "",
        "referPersonId" : "",
        "refAccountIdentifierType" : "",
        "refAccountIdentifier" : "",
        "referAccountId" : "",
        "referDealIdentifier" : "",
        "referenceDealId" : "",
        "referenceModelId" : "",
        "referUsageSw" : "false",
        "referPriceSw" : "false",
        "includeChildHierarchy" : "false",
        "division" : "",
    }
}
}
}

```

Note: We have given the above request and response samples to illustrate how the attribute value pairs should be structured while sending a price item selection request from the external system. However, you should not seamlessly use this request sample in your environment because the required pre-requisite data may not be available in your environment. In such case, the system will give erroneous results.

Related Topics

For more information on...	See...
Deal update request and response attribute/value pairs in the JSON format	Deal Update Request and Response - Attribute/Value Pairs in the JSON Format on page 4108

Deal Extraction through Inbound Web Service

Oracle Revenue Management and Billing enables you to extract the details of a deal through a web service. At a time, you can extract the details of only one deal version of a deal. You can send the extract request from the external system through an inbound web service. We have shipped the following two inbound web services in this release:

- **C1-DealExtract** - This is an SOAP based web service. You can use this web service when you want to send the extract request in the XML format.
- **C1-DealExtractREST** - This is a REST based web service. You can use this web service when you want to send the extract request in the XML or JSON format.

Both these inbound web services call the **C1-DealExtractionWebService** business service. This business service is used to extract the details of a deal version. While extracting the details of a deal version, you need to specify the deal ID, deal version ID, or the deal identifier to determine the deal version whose details you want to view. If both the deal version and deal ID or deal identifier are given in the request, the system considers the deal version. However, if only the deal ID or deal identifier is given in the request, the system derives the deal version. Note that an error occurs when the given deal has multiple deal versions.

On processing the request, the system displays the following:

- Entity for which the deal is created
- Basic details of the deal including its terms and conditions, characteristics, and products
- Template using which the deal is created
- Details of the reference (if any) used in the deal
- Logs of the deal and deal version
- Adhoc cost and revenue details of the deal version
- Pricing and commitment details of each entity in the customer hierarchy
- Deal-specific terms and conditions defined for the price items and hierarchy entities
- Characteristics of different entities in the customer hierarchy
- Characteristics of different price items and hierarchy entities included in the deal

If the deal version is simulated, the system also displays the following information:

- Original, proposed, and recommended deal level financial summary
- Original, proposed, and recommended product level financial summary (if any)
- Original, proposed, and recommended division level financial summary (if any)
- Simulation details of each entity in the customer hierarchy

Deal Extraction Request in the XML Format

The following code snippet illustrates how the tags should be nested while receiving the deal extract request in the XML format:

```
<C1-DealExtractionWebService>
  <dealDetails>
    <dealIdentifier></dealIdentifier>
    <dealId></dealId>
    <modelId></modelId>
  </C1-DealExtractionWebService>
```

Related Topics

For more information on...	See...
Deal extraction request and response tags in the XML format	Deal Extraction Request and Response - Tags in the XML Format on page 4178

For more information on...	See...
Sample deal extraction request and response in the XML format	Sample Deal Extraction Request and Response in the XML Format on page 4194

Deal Extraction Response in the XML Format

The following code snippet illustrates how the tags should be nested while sending the deal extract request in the XML format:

```
<C1-DealExtractionWebService>
  <dealDetails>
    <dealEntityDetails>
      <personIdentifierType></personIdentifierType>
      <personIdentifier></personIdentifier>
      <personId></personId>
      <accountIdentifierType></accountIdentifierType>
      <accountIdentifier></accountIdentifier>
      <accountId></accountId>
      <prsPerIdentifierType></prsPerIdentifierType>
      <prsPerIdentifier></prsPerIdentifier>
      <prospectPersonId></prospectPersonId>
      <division></division>
    </dealEntityDetails>
    <dealIdentifier></dealIdentifier>
    <dealInformation></dealInformation>
    <dealId></dealId>
    <modelId></modelId>
    <dealEntityType></dealEntityType>
    <customerSegment></customerSegment>
    <customerTier></customerTier>
    <division></division>
    <accessGrp></accessGrp>
    <dealEntityId></dealEntityId>
    <contractedDealFlag></contractedDealFlag>
    <currency></currency>
    <dealTypeCode></dealTypeCode>
    <startDate></startDate>
    <endDate></endDate>
    <simulationTypeFlag></simulationTypeFlag>
    <reviewFrequency></reviewFrequency>
    <dealDescription></dealDescription>
    <dealVersionDescription></dealVersionDescription>
    <dealFrequency></dealFrequency>
    <skipReferenceFlag></skipReferenceFlag>
    <priceSelectionDate></priceSelectionDate>
    <usagePeriod></usagePeriod>
    <includeHierarchyFlag></includeHierarchyFlag>
    <status></status>
    <dealVersionStatus></dealVersionStatus>
    <templateFlag></templateFlag>
    <createdDate></createdDate>
    <acceptanceDate></acceptanceDate>
    <finalizedDate></finalizedDate>
    <effectiveStartDate></effectiveStartDate>
    <effectiveEndDate></effectiveEndDate>
    <reviewedDate></reviewedDate>
  </dealDetails>
  <templateReferenceDetails>
    <templateDealId></templateDealId>
    <templateDealIdentifier></templateDealIdentifier>
    <templateModelId></templateModelId>
    <copyBasicDetailsFlag></copyBasicDetailsFlag>
  </templateReferenceDetails>
</C1-DealExtractionWebService>
```

```

    <copyPricingFlag></copyPricingFlag>
    <copyUsageFlag>
  </templateReferenceDetails>
  <dealCharacteristics>
    <effectiveDate></effectiveDate>
    <characteristicType></characteristicType>
    <characteristicValue></characteristicValue>
  </dealCharacteristics>
  <dealTermsAndConditionsDetails>
    <termsAndConditionsList>
      <termsAndCondition></termsAndCondition>
      <description></description>
      <termsAndConditionText></termsAndConditionText>
    </termsAndConditionsList>
  </dealTermsAndConditionsDetails>
  <productDetailsList>
    <productCode></productCode>
  </productDetailsList>
  <referenceDetails>
    <referenceTypeFlg></referenceTypeFlg>
    <refPersonIdentifierType></refPersonIdentifierType>
    <refPersonIdentifier></refPersonIdentifier>
    <referPersonId></referPersonId>
    <refAccountIdentifierType></refAccountIdentifierType>
    <refAccountIdentifier></refAccountIdentifier>
    <referAccountId></referAccountId>
    <referDealIdentifier></referDealIdentifier>
    <referenceDealId></referenceDealId>
    <referenceModelId></referenceModelId>
    <referUsageSw></referUsageSw>
    <referPriceSw></referPriceSw>
    <includeChildHierarchyFlag></includeChildHierarchyFlag>
    <division></division>
  </referenceDetails>
  <dealComments>
    <sequenceNo></sequenceNo>
    <commentsDateTime></commentsDateTime>
    <user></user>
    <dealComments></dealComments>
    <reasonCode></reasonCode>
  </dealComments>
  <modelComments>
    <sequenceNo></sequenceNo>
    <commentsDateTime></commentsDateTime>
    <user></user>
    <modelComments></modelComments>
  </modelComments>
  <adhocRevenueCostDetails>
    <sequence></sequence>
    <revenueTypeFlag><revenueTypeFlag>
    <revenueCostGroupFlag></revenueCostGroupFlag>
    <division></division>
    <currency></currency>
    <amount></amount>
    <priceItem></priceItem>
  </adhocRevenueCostDetails>
  <dealSimulationDetails>
    <dealFinancialSummaryDetails>
      <approvalStatus></approvalStatus>
      <originalDealFinancialSummary>
        <revenue></revenue>
        <cost></cost>
        <profit></profit>
        <profitabilityPercentage></profitabilityPercentage>
      </originalDealFinancialSummary>
    </dealFinancialSummaryDetails>
  </dealSimulationDetails>

```

```

</originalDealFinancialSummary>
<proposedDealFinancialSummary>
  <revenue></revenue>
  <cost></cost>
  <profit></profit>
  <profitabilityPercentage></profitabilityPercentage>
</proposedDealFinancialSummary>
<recommendedDealFinancialSummary>
  <revenue></revenue>
  <profit></profit>
  <profitabilityPercentage></profitabilityPercentage>
</recommendedDealFinancialSummary>
  <profitVariationPercentage></profitVariationPercentage>
<dealFinancialSummaryDetails>
<divisionFinancialSummaryDetails>
  <division></division>
  <approvalStatus></approvalStatus>
  <originalDivisionFinancialSummary>
    <revenue></revenue>
    <cost></cost>
    <profit></profit>
    <profitabilityPercentage></profitabilityPercentage>
  </originalDivisionFinancialSummary>
  <proposedDivisionFinancialSummary>
    <revenue></revenue>
    <cost></cost>
    <profit></profit>
    <profitabilityPercentage></profitabilityPercentage>
  </proposedDivisionFinancialSummary>
  <recommendedDealFinancialSummary>
    <revenue></revenue>
    <profit></profit>
    <profitabilityPercentage></profitabilityPercentage>
  </recommendedDealFinancialSummary>
  <profitVariationPercentage></profitVariationPercentage>
</divisionFinancialSummaryDetails>
<productFinancialSummaryDetails>
  <approvalStatus></approvalStatus>
  <product></product>
  <division></division>
  <originalProductFinancialSummary>
    <revenue></revenue>
    <cost></cost>
    <profit></profit>
    <profitabilityPercentage></profitabilityPercentage>
  </originalProductFinancialSummary>
  <proposedProductDivisionFinancialSummary>
    <revenue></revenue>
    <cost></cost>
    <profit></profit>
    <profitabilityPercentage></profitabilityPercentage>
  </proposedProductDivisionFinancialSummary>
  <recommendedDealFinancialSummary>
    <revenue></revenue>
    <profit></profit>
    <profitabilityPercentage></profitabilityPercentage>
  </recommendedDealFinancialSummary>
  <profitVariationPercentage></profitVariationPercentage>
</productFinancialSummaryDetails>
</dealSimulationDetails>
<hierarchySimulationDetails>
  <hierarchyDetails>
    <entityType></entityType>
    <entityId></entityId>

```

```

    <entityIdentifierType></entityIdentifierType>
    <entityIdentifierValue></entityIdentifierValue>
    <entityDivision></entityDivision>
    <parentEntityId></parentEntityId>
    <parentEntityIdentifierType></parentEntityIdentifierType>
    <parentEntityIdentifierValue></parentEntityIdentifierValue>
    <parentEntityDivision></parentEntityDivision>
    <status></status>
    <revenueVariation></revenueVariation>
    <proposedRevenue></proposedRevenue>
    <proposedCost></proposedCost>
    <originalRevenue></originalRevenue>
    <originalCost></originalCost>
  </hierarchyDetails>
</hierarchySimulationDetails>
<dealPricingAndCommitment>
  <pricingAndCommitmentsDetails>
    <entityId></entityId>
    <entityType></entityType>
    <entityIdentifierType></entityIdentifierType>
    <entityIdentifierValue></entityIdentifierValue>
    <entityDivision></entityDivision>
    <pricingDetails>
      <priceAsgnId></priceAsgnId>
      <priceItemCode></priceItemCode>
      <priceItemDescription></priceItemDescription>
      <hierarchyDetails></hierarchyDetails>
      <cost></cost>
      <revenue></revenue>
      <averagePrice></averagePrice>
      <variation></variation>
      <pricingStatus></pricingStatus>
      <priceCurrencyCode></priceCurrencyCode>
      <rateSchedule></rateSchedule>
      <startDate></startDate>
      <endDate></endDate>
      <isEligible></isEligible>
      <assignmentLevel></assignmentLevel>
      <paTypeFlag></paTypeFlag>
      <printIfZero></printIfZero>
      <priceAssignCharacteristics>
        <characteristicType></characteristicType>
        <effectiveDate></effectiveDate>
        <characteristicValue></characteristicValue>
      </priceAssignCharacteristics>
      <parameterDetails>
        <parameterCode></parameterCode>
        <parameterValue></parameterValue>
      </parameterDetails>
      <txxDailyRatingCrt></txxDailyRatingCrt>
      <ignoreSw></ignoreSw>
      <aggregateSw></aggregateSw>
      <scheduleCode></scheduleCode>
      <priceCompDetails>
        <priceCompId></priceCompId>
        <priceCompDesc></priceCompDesc>
        <valueAmt></valueAmt>
        <displaySw></displaySw>
        <rcMapId></rcMapId>
        <tieredFlag></tieredFlag>
        <priceCompSequenceNo></priceCompSequenceNo>
        <priceCompTier>
          <tierSeqNum></tierSeqNum>
          <priceCriteria></priceCriteria>
        </priceCompTier>
      </priceCompDetails>
    </pricingDetails>
  </pricingAndCommitmentsDetails>
</dealPricingAndCommitment>

```

```

        <lowerLimit></lowerLimit>
        <upperLimit></upperLimit>
        <priceCompParameterDetails>
            <parameterCode></parameterCode>
            <parameterValue></parameterValue>
        </priceCompParameterDetails>
    </priceCompTier>
    <priceCompElig>
        <sequenceNumber></sequenceNumber>
        <lhsPriceParmCd></lhsPriceParmCd>
        <operator></operator>
        <rhsPriceParmTypeFlg></rhsPriceParmTypeFlg>
        <rhsPriceParmCd></rhsPriceParmCd>
        <rhsPriceParmVal></rhsPriceParmVal>
        <isTrueFlag></isTrueFlag>
        <isFalseFlag></isFalseFlag>
        <isInsufficientFlag></isInsufficientFlag>
    </priceCompElig>
</priceCompDetails>
</pricingDetails>
<commitmentDetails>
    <priceItemCode></priceItemCode>
    <priceItemDescription></priceItemDescription>
    <parameterDetails>
        <parameterCode></parameterCode>
        <parameterValue></parameterValue>
    </parameterDetails>
    <SQIDetails>
        <serviceQuantityIdentifier></serviceQuantityIdentifier>
        <sqiValue></sqiValue>
        <sqiTypeFlg></sqiTypeFlg>
    </SQIDetails>
</commitmentDetails>
<termsAndConditionsDetails>
    <priceItemCode></priceItemCode>
    <priceItemDescription></priceItemDescription>
    <priceItemGroupCode></priceItemGroupCode>
    <priceItemGroupCodeDescription></priceItemGroupCodeDescription>
    <parameterDetails>
        <parameterCode></parameterCode>
        <parameterValue></parameterValue>
    </parameterDetails>
    <termsAndConditionsList>
        <termsAndCondition></termsAndCondition>
        <description></description>
        <termsAndConditionText></termsAndConditionText>
    </termsAndConditionsList>
</termsAndConditionsDetails>
</pricingAndCommitmentsDetails>
</dealPricingAndCommitment>
<entitycharacteristics>
    <entityId></entityId>
    <entityType></entityType>
    <entityIdentifierType></entityIdentifierType>
    <entityIdentifierValue></entityIdentifierValue>
    <entityDivision></entityDivision>
    <entityCharacteristicsList>
        <effectiveDate></effectiveDate>
        <characteristicType></characteristicType>
        <characteristicValue></characteristicValue>
    </entityCharacteristicsList>
</entitycharacteristics>
</C1-DealExtractionWebService>

```

Related Topics

For more information on...	See...
Deal extraction request and response tags in the XML format	Deal Extraction Request and Response - Tags in the XML Format on page 4178
Sample deal extraction request and response in the XML format	Sample Deal Extraction Request and Response in the XML Format on page 4194

Deal Extraction Request and Response - Tags in the XML Format

Note: We recommend you to refer the topics [Deal Extraction Request in the XML Format](#) on page 4172 and [Deal Extraction Response in the XML Format](#) on page 4173 in parallel while understanding the below mentioned tags. This will help you to understand how the tags are nested in the XML format.

Before calling the **C1-DealExtractionWebService** business service through an inbound web service, you need to ensure that the deal extraction request contains the following tags:

Tag Name	Tag Description	Mandatory (Yes or No)
dealIdentifier	Used to specify the primary identifier of the deal using which you want to extract the details of the deal.	Yes (Conditional)
	<p>Note:</p> <p>If you specify the dealIdentifier tag, you need not specify the dealId and the modelId tags.</p> <p>If the deal has multiple versions, then, you should specify the modelId tag instead of the dealIdentifier tag.</p>	<p>Note: This data is required if you do not specify the dealId and modelId tags.</p>
dealId	Used to specify the deal ID using which you want to extract the details of the deal.	Yes (Conditional)
	<p>Note:</p> <p>If you specify the dealId tag, you need not specify the dealIdentifier and the modelId tags.</p> <p>If the deal has multiple versions, then, you should specify the modelId tag instead of the dealId tag.</p>	<p>Note: This data is required if you do not specify the dealIdentifier and modelId tags.</p>
modelId	Used to specify the deal version using which you want to extract the details of the deal.	Yes (Conditional)
	<p>Note:</p> <p>If you specify the modelId tag, you need not specify the dealIdentifier and the dealId tags.</p>	<p>Note: This data is required if you do not specify the dealIdentifier and dealId tags.</p>

Once the deal is extracted, all the details of deal are listed in the above mentioned tags along with the following tags:

Tag Name	Tag Description
dealDetails	Displays basic information about the deal.
dealEntityDetails	Displays basic information about the entity (i.e. existing person, account, or prospect person) for which the deal is created in the system.
personIdentifierType	Indicates the identifier type using which the person is created in the system. Note: The value in this tag appears only when the value of the dealEntityType tag is EPER .
personIdentifier	Displays the value of person identifier type. Note: The value in this tag appears only when the value of the dealEntityType tag is EPER .
personId	Displays the existing person for whom the deal created in the system. Note: The value in this tag appears only when the value of the dealEntityType tag is EPER .
accountIdentifierType	Indicates the identifier type using which the account is created in the system. Note: The value in this tag appears only when the value of the dealEntityType tag is EACC .
accountIdentifier	Displays the value of the account identifier type. Note: The value in this tag appears only when the value of the dealEntityType tag is EACC .
accountId	Displays the existing account for which the deal is created in the system. Note: The value in this tag appears only when the value of the dealEntityType tag is EACC .
prsPerIdentifierType	Indicates the identifier type using which the prospect person is created in the system. Note: The value in this tag appears only when the value of the dealEntityType tag is PRSP .
prsPerIdentifier	Displays the value of the prospect person identifier type. Note: The value in this tag appears only when the value of the dealEntityType tag is PRSP .
prospectPersonId	Displays the prospect person for whom the deal is created in the system. Note: The value in this tag appears only when the value of the dealEntityType tag is PRSP .
division	Indicates the division to which the entity (i.e. existing person, account, or prospect person) belongs.

Tag Name	Tag Description
dealInformation	Displays the concatenated string of information about the deal separated by a comma (,).
dealEntityType	Indicates the type of entity for which the deal is created in the system. The valid values are: <ul style="list-style-type: none"> • EPER - Indicates that the deal is created for an existing person. • EACC - Indicates that the deal is created for an existing account. • PRSP - Indicates that the deal is created for a prospect person.
customerSegment	Indicates the business component to which the entity (i.e. existing person, account, or prospect person) belongs.
customerTier	Indicates the customer tier of the customer segment to which the entity (i.e. existing person, account, or prospect person) belongs.
division	Indicates the division to which the deal belongs.
accessGrp	Indicate the user group who can view and edit the details of the deal.
dealEntityId	Displays the entity (i.e. existing person, account, or prospect person) whose deal details you are viewing.
contractedDealFlag	Indicates whether the change in the price item pricing from the price list affects the price item pricing offered in the deal created for the entity (i.e. existing person, account, or prospect person) or not. The valid values are: <ul style="list-style-type: none"> • true • false
currency	Indicates the currency in which the deal level, division level, or product level financial summary and profitability of the deal is calculated.
dealTypeCode	Indicates the deal type using which the deal is created in the system.
startDate	Displays the date from when the deal is effective for the entity (i.e. the existing person, account or prospect person).
endDate	Displays the date till when the deal is effective for the entity (i.e. the existing person, account, or prospect person).
simulationTypeFlag	Indicates the simulation type using which the cost, revenue, and profitability of the deal is analyzed. The valid values are: <ul style="list-style-type: none"> • CUST • ACCT • DEAL
reviewFrequency	Indicates the timely monitoring of the deal usage as per the commitments made by the customer. The valid values are: <ul style="list-style-type: none"> • 6 - Indicates that you want to monitor the deal usage biannually. • 12 - Indicates that you want to monitor the deal usage annually. • 24 - Indicates that you want to monitor the deal usage in every two years.
dealDescription	Displays the description of the deal.
dealVersionDescription	Displays the description of the deal version.

Tag Name	Tag Description
dealFrequency	<p>Indicates the duration in which the financial summary and profitability of the deal is calculated through simulation. The valid values are:</p> <ul style="list-style-type: none"> • 1 - Indicates that you want to simulate the deal every month. • 3 - Indicates that you want to simulate the deal quarterly. • 6 - Indicates that you want to simulate the deal biannually. • 12 - Indicates that you want to simulate the deal annually.
skipReferenceFlag	<p>Indicates whether the deal is created by referring the pricing and commitments of a deal which is already created in the system. The valid values are:</p> <ul style="list-style-type: none"> • true • false
priceSelectionDate	<p>Displays the date from when the price lists, pricing assignments, and product enrollments are effective for simulation.</p>
usagePeriod	<p>Indicates the period for which deal data is aggregated to determine the scope of the deal. The valid values are:</p> <ul style="list-style-type: none"> • 1 - Indicates that you want to aggregate the deal data every month. • 3 - Indicates that you want to aggregate the deal data quarterly. • 6 - Indicates that you want to aggregate the deal data biannually. • 12 - Indicates that you want to aggregate the deal data annually.
includeHierarchyFlag	<p>Indicates whether the child persons, grandchild persons, and their accounts in the customer hierarchy is included in the deal or not. The valid values are:</p> <ul style="list-style-type: none"> • true • false
status	<p>Indicates the current status of the deal.</p>
dealVersionStatus	<p>Indicates the current status of the deal version.</p>
templateFlag	<p>Indicates whether the deal is used as a template while searching references for creating other deals. The valid values are:</p> <ul style="list-style-type: none"> • true • false
createdDate	<p>Displays the date when the deal is created in the system.</p>
acceptanceDate	<p>Displays the date when the deal is accepted in the system after the customer review and acceptance.</p>
	<p>Note: The data in this tag appears only when the deal has reached the Accepted status. If the deal status is Rejected, then the acceptanceDate tag specifies the date when the deal is rejected in the system.</p>
finalizedDate	<p>Displays the date when the deal is finalized in the system.</p>
effectiveStartDate	<p>Displays the date from when the proposed price list assignments, product enrollments and price assignments are effective for the deal.</p>

Tag Name	Tag Description
effectiveEndDate	Displays the date till when the proposed price list assignments, product enrollments and price assignments are effective for the deal.
reviewedDate	Displays the date when the deal usage as per the commitments made by the customer is reviewed in the system.
templateReferenceDetails	Displays the details of the template deal which is used as a reference for creating the deal.
templateDealId	Displays the particular template deal which is used for creating the deal.
templateDealIdentifier	Displays the primary identifier using which the template deal is created in the system.
templateModelId	Displays the particular template deal version which is used for creating the deal.
copyBasicDetailsFlag	Indicates whether the basic details are copied from the template deal to the deal which is created for the entity (i.e. existing person, account, or prospect person) or not. The valid values are: <ul style="list-style-type: none"> • true • false
copyPricingFlag	Indicates whether the price list assignments and price assignments are copied from the template deal to the deal which is created for the entity (i.e. existing person, account, or prospect person) or not. The valid values are: <ul style="list-style-type: none"> • true • false
copyUsageFlag	Indicates whether the commitments from the SQI-based billable charges are copied from the template deal to the deal which is created for the entity (i.e. existing person, account, or prospect person) or not. The valid values are: <ul style="list-style-type: none"> • true • false
dealCharacteristics	Displays the list of characteristics of the deal.
effectiveDate	Displays the date from when the characteristic is effective for the deal.
characteristicType	Indicates the characteristic type.
characteristicValue	Displays the value of the characteristic type.
dealTermsAndConditionsDetails	Displays the list of terms and conditions which are associated with the deal.
termsAndConditionsList	Displays the terms and conditions of the deal.
termsAndCondition	Displays the term and condition which is associated with the deal.
description	Displays the description of the term and condition.
termsAndConditionText	Displays additional information about the term and condition.
productDetailsList	Displays the list of products recommended for the deal.
productCode	Displays the product which is recommended for the deal.
referenceDetails	Displays the details of the reference deal using which the deal is created for the entity (i.e. existing person, account, or prospect person) in the system.

Tag Name	Tag Description
referenceTypeFlg	<p>Indicates the type of the reference deal using which the deal is created for the entity (i.e. existing person, account, or prospect person) in the system. The valid values are:</p> <ul style="list-style-type: none"> • RPER - Indicates that the deal is created by using the deal of an existing person as a reference. • RACC - Indicates that the deal is created by using the deal of an existing account as a reference. • RDEL - Indicates that the deal is created by using an existing deal as a reference.
refPersonIdentifierType	<p>Displays the identifier type of the person using which the reference deal is created in the system.</p> <p>Note: The value in this tag appears only when the value of the referenceTypeFlg tag is RPER.</p>
refPersonIdentifier	<p>Displays the value of the reference person identifier type.</p> <p>Note: The value in this tag appears only when the value of the referenceTypeFlg tag is RPER.</p>
referPersonId	<p>Displays the person for whom the reference deal is created.</p> <p>Note: The value in this tag appears only when the value of the referenceTypeFlg tag is RPER.</p>
refAccountIdentifierType	<p>Displays the identifier type of the account using which the reference deal is created in the system.</p> <p>Note: The value in this tag appears only when the value of the referenceTypeFlg tag is RACC.</p>
refAccountIdentifier	<p>Displays the value of the reference account identifier type.</p> <p>Note: The value in this tag appears only when the value of the referenceTypeFlg tag is RACC.</p>
referAccountId	<p>Display the account for which the reference deal is created.</p> <p>Note: The value in this tag appears only when the value of the referenceTypeFlg tag is RACC.</p>
referDealIdentifier	<p>Displays the primary identifier using which the reference deal is created in the system.</p> <p>Note: The value in this tag appears only when the value of the referenceTypeFlg tag is RDEL.</p>
referenceDealId	<p>Displays the existing deal which is used as a reference to create the deal.</p> <p>Note: The value in this tag appears only when the value of the referenceTypeFlg tag is RDEL.</p>
referenceModelId	<p>Displays the existing deal version which is used as a reference to create the deal.</p>

Tag Name	Tag Description
	Note: The value in this tag appears only when the value of the referenceTypeFlg tag is RDEL .
referUsageSw	Indicates whether the commitments from the SQL-based billable charges of the reference deal is copied to create the deal for the entity (i.e. existing person, account, or prospect person). The valid values are: <ul style="list-style-type: none"> • true • false
referPriceSw	Indicates whether the price list assignments and price assignments of the reference deal is copied to create the deal for the entity (i.e. existing person, account, or prospect person). The valid values are: <ul style="list-style-type: none"> • true • false
includeChildHierarchyFlag	Indicates whether the child persons, grandchild persons, and their accounts of the reference deal is included while creating the deal for the entity (i.e. existing person, account, or prospect person).. The valid values are: <ul style="list-style-type: none"> • true • false
division	Indicates the division to which the reference person belongs.
dealComments	Displays information about the actions performed on the deal.
sequenceNo	Displays the sequence number in which the action is performed on the deal.
commentsDateTime	Displays the date and time when the action is performed on the deal.
user	Displays the user who has performed the action on the deal.
dealComments	Displays the details about the action performed on the deal.
reasonCode	Displays the reason why the action is performed on the deal.
modelcomments	Displays information about the actions performed on the deal version of the deal.
sequenceNo	Displays the sequence number in which the action is performed on the deal version of the deal.
commentsDateTime	Displays the date and time when the action is performed on the deal version of the deal.
user	Displays the user who has performed the action on the deal version of the deal.
modelComments	Displays the details about the action performed on the deal version of the deal.
adhocRevenueCostDetails	Displays information about the adhoc revenue and cost of the deal.
sequence	Displays the sequence number of the adhoc revenue or cost of the deal.
revenueCostGroupFlag	Indicates the group to which the adhoc charge belongs. The valid values are: <ul style="list-style-type: none"> • ADRE - Indicates the charges incurred as the adhoc revenue for the deal. • CUCO - Indicates the charges of the courier services for the deal. • DCOM - Indicates the charges that incurred during deal commissioning.

Tag Name	Tag Description
	<ul style="list-style-type: none"> • PRIL - Indicates the price item specific charges for the deal. • TRCO - Indicates the travel cost.
division	Indicates the division for which the adhoc charge is applicable.
currency	Indicates the currency in which the adhoc charge is specified for the deal.
amount	Displays the amount for the adhoc revenue or cost.
	Note: You can even view the negative value in this tag.
priceItem	Indicates the particular price item for which the adhoc charge is added.
dealSimulationDetails	Displays the deal level, division level, and product level simulation details of the deal.
dealFinancialSummaryDetails	Displays information about the financial summary at the deal level.
approvalStatus	Indicates the current approval status of the financial summary at the deal level. <ul style="list-style-type: none"> • APPR • EROR • INIT • UNAP
originalDealFinancialSummary	Displays information about the financial summary at the deal level which is calculated using the original price list assignments and price assignments.
revenue	Displays the revenue generated at the deal level from the original price list assignments and price assignments.
cost	Displays the cost calculated at the deal level from the original price list assignments and price assignments.
profit	Displays the profit in deal currency generated from the original price list assignments and price assignments at the deal level.
profitabilityPercentage	Displays the profit generated in percentage (%) from the original price list assignments and price assignments at the deal level.
proposedDealFinancialSummary	Displays information about the financial summary at the deal level which is calculated using the proposed price list assignments and price assignments.
revenue	Displays the revenue generated at the deal level from the proposed price list assignments and price assignments.
cost	Displays the cost calculated at the deal level from the proposed price list assignments and price assignments.
profit	Displays the profit in deal currency generated from the proposed price list assignments and price assignments at the deal level.
profitabilityPercentage	Displays the profit generated in percentage (%) from the proposed price list assignments and price assignments at the deal level.
recommendedDealFinancialSummary	Displays information about the financial summary at the deal level which is calculated using the recommended price list assignments and price assignments.
revenue	Displays the revenue generated at the deal level from the recommended price list assignments and price assignments.

Tag Name	Tag Description
profit	Displays the profit in deal currency generated from the recommended price list assignments and price assignments at the deal level.
profitabilityPercentage	Displays the profit in deal currency generated from the recommended price list assignments and price assignments at the deal level.
profitVariationPercentage	Displays the difference in the original and the proposed profits at the deal level in percentage (%).
divisionFinancialSummaryDetails	Displays information about the financial summary at the division level.
division	Indicates the division for which the financial summary is displayed.
approvalStatus	Indicates the current approval status of the financial summary at the division level. <ul style="list-style-type: none"> • APPR • EROR • INIT • UNAP
originalDivisionFinancialSummaryDetails	Displays information about the financial summary at the division level which is calculated using the original price list assignments and price assignments.
revenue	Displays the revenue generated at the division level from the original price list assignments and price assignments.
cost	Displays the cost calculated at the division level from the original price list assignments and price assignments.
profit	Displays the profit in deal currency generated from the original price list assignments and price assignments at the division level.
profitabilityPercentage	Displays the profit generated in percentage (%) from the original price list assignments and price assignments at the division level.
proposedDivisionFinancialSummaryDetails	Displays information about the financial summary at the division level which is calculated using the proposed price list assignments and price assignments.
revenue	Displays the revenue generated at the division level from the proposed price list assignments and price assignments.
cost	Displays the cost calculated at the division level from the proposed price list assignments and price assignments.
profit	Displays the profit in deal currency generated from the proposed price list assignments and price assignments at the division level.
profitabilityPercentage	Displays the profit generated in percentage (%) from the proposed price list assignments and price assignments at the division level.
recommendedDealFinancialSummaryDetails	Displays information about the financial summary at the division level which is calculated using the recommended price list assignments and price assignments.
revenue	Displays the revenue generated at the division level from the recommended price list assignments and price assignments.
profit	Displays the profit in deal currency generated from the recommended price list assignments and price assignments at the division level.
profitabilityPercentage	Displays the profit in deal currency generated from the recommended price list assignments and price assignments at the division level.

Tag Name	Tag Description
profitVariationPercentage	Displays the profit generated in percentage (%) from the recommended price list assignments and price assignments at the division level.
productFinancialSummaryDetail	Displays information about the financial summary at the product level.
approvalStatus	Indicates the current approval status of the financial summary at the product level. <ul style="list-style-type: none"> • APPR • EROR • INIT • UNAP
product	Indicates the product for which the financial summary is displayed.
division	Indicates the division for which the product financial summary is displayed.
originalProductFinancialSummary	Displays information about the financial summary at the product level which is calculated using the original price list assignments and price assignments.
revenue	Displays the revenue generated at the product level from the original price list assignments and price assignments.
cost	Displays the cost calculated at the product level from the original price list assignments and price assignments.
profit	Displays the profit in deal currency generated from the original price list assignments and price assignments at the product level.
profitabilityPercentage	Displays the profit generated in percentage (%) from the original price list assignments and price assignments at the product level.
proposedProductDivisionFinancialSummary	Displays information about the financial summary at the product level which is calculated using the proposed price list assignments and price assignments for a particular division.
revenue	Displays the revenue generated at the product level from the proposed price list assignments and price assignments.
cost	Displays the cost calculated at the product level from the proposed price list assignments and price assignments.
profit	Displays the profit in deal currency generated from the proposed price list assignments and price assignments at the product level.
profitabilityPercentage	Displays the profit generated in percentage (%) from the proposed price list assignments and price assignments at the product level.
recommendedDealFinancialSummary	Displays information about the financial summary at the product level which is calculated using the recommended price list assignments and price assignments.
revenue	Displays the revenue generated at the product level from the recommended price list assignments and price assignments.
profit	Displays the profit in deal currency generated from the recommended price list assignments and price assignments at the product level.
profitabilityPercentage	Displays the profit in deal currency generated from the recommended price list assignments and price assignments at the product level.
profitVariationPercentage	Displays the profit generated in percentage (%) from the recommended price list assignments and price assignments at the product level.

Tag Name	Tag Description
hierarchySimulationDetails	Displays information about the financial summary at the entity level in the customer hierarchy.
hierarchyDetails	Displays the details of the hierarchy.
entityType	Displays the type of the entity for which the financial summary is displayed.
entityId	Displays the entity (i.e. person or account) in the customer hierarchy for which the financial summary is displayed.
entityIdentifierType	Displays the identifier type using which the entity is created in the system.
entityIdentifierValue	Displays the value of the entity identifier type.
entityDivision	Indicates the division to which the entity belongs.
parentEntityId	Displays the parent person to whom the entity (i.e. person or account) belongs in the customer hierarchy.
parentEntityIdentifierType	Displays the identifier type using which the parent entity is created in the system.
parentEntityIdentifierValue	Displays the value of the parent entity identifier type.
parentEntityDivision	Indicates the division to which the parent entity belongs.
status	Indicates the current approval status of the price list assignments and price assignments for the respective entity (i.e. person or account) in the customer hierarchy.
revenueVariation	Displays the average revenue generated from the price assignment and commitments of the price items at the entity (i.e. person or account) level in the customer hierarchy.
proposedRevenue	Displays the revenue generated at the entity (i.e. person or account) level from the proposed price assignment and commitments of the price items.
proposedCost	Displays the cost calculated at the entity (i.e. person or account) level from the proposed price assignment and commitments of the price items.
originalRevenue	Displays the revenue generated at the entity (i.e. person or account) level from the original price assignment and commitments of the price items.
originalCost	Displays the cost calculated at the entity (i.e. person or account) level from the original price assignment and commitments of the price items.
dealPricingAndCommitment	Displays information about the price assignment and commitments of the entities (i.e. person or account) in the customer hierarchy of the deal.
pricingAndCommitmentsDetails	Displays the price assignment and commitment details of the entity (i.e. person or account) in the customer hierarchy of the deal.
entityId	Displays the entity (i.e. person or account) whose price assignment and commitment details you are viewing.
entityType	Indicates the type of the entity whose price assignment and commitment details you are viewing. The valid values are: <ul style="list-style-type: none"> • ACCT • PERS
entityIdentifierType	Indicates the identifier type using which the entity (i.e. person or account) is created in the system.

Tag Name	Tag Description
entityIdentifierValue	Indicates the value of the identifier type using which the entity (i.e. person or account) is created in the system.
entityDivision	Indicates the division to which the entity (i.e. person or account) belongs.
pricingDetails	Displays the price assignment details of the entity (i.e. person or account) in the customer hierarchy of the deal.
priceAsgnId	Displays the identification value of the price assignment for the entity (i.e. person or account) whose price assignment details you are viewing.
priceItemCode	Displays the price item whose price assignment details you are viewing.
priceItemDescription	Displays the description of the price item.
hierarchyDetails	Displays the root level and/or non-root level hierarchy entity to which the price item belongs.
cost	Displays the cost calculated at the price item level from the proposed price assignment and commitments of the price item.
revenue	Displays the revenue generated from the proposed price assignment and commitments of the price item.
averagePrice	Displays the average price of the price item as per the proposed price assignment and commitments of the price item.
variation	Displays the variation between the original and proposed revenue in percentage (%) generated from the price assignment and commitments of the price item.
pricingStatus	Indicates the current approval status of the price assignment of the price item.
priceCurrencyCode	Indicates the currency in which the price assignment is defined for the price item.
rateSchedule	Indicates the rate schedule using which the price assignment is defined for the price item.
startDate	Displays the date from when the price assignment of the price item is effective for the entity (i.e. person or account).
endDate	Displays the date till when the price assignment of the price item is effective for the entity (i.e. person or account).
isEligible	Indicates whether the eligibility criteria for the price assignment is defined or not. The valid values are: <ul style="list-style-type: none"> • FALSE • TRUE
assignmentLevel	Indicates the level at which the pricing is defined for the price item. The valid values are: <ul style="list-style-type: none"> • ACPI • CUPi • PCPI
paTypeFlag	Indicates the type of price assignment. The valid values are: <ul style="list-style-type: none"> • POST • PPIN

Tag Name	Tag Description
	<ul style="list-style-type: none"> • PPPR • RGLR
printIfZero	Indicates whether zero pricing is displayed or not. The valid values are: <ul style="list-style-type: none"> • Y • N
priceAssignCharacteristics	Displays the list of characteristics defined for the price assignment.
characteristicType	Indicates the characteristic type.
effectiveDate	Displays the date from when the characteristic is effective for price assignment.
characteristicValue	Displays the value of the characteristic type.
parameterDetails	Displays the list of price item parameters which are used along with the price item for determining the price assignment.
parameterCode	Indicates the pricing parameter which is associated with the price item.
parameterValue	Indicates the predefined pricing parameter value which is used for the price assignment.
txnDailyRatingCrt	Indicates how and when the transaction legs mapped to the price item are rated. The valid values are: <ul style="list-style-type: none"> • DNRT • AGTR • RITA • RITX
ignoreSw	Indicates whether transaction mapped to price item pricing are considered for billing or not. The valid values are: <ul style="list-style-type: none"> • Y • N
aggregateSw	Indicates whether aggregation is required while rating the transactions mapped to the price item pricing before billing. The valid values are: <ul style="list-style-type: none"> • Y • N
scheduleCode	Indicates the transaction aggregation cycle. The valid values are: <ul style="list-style-type: none"> • DAILY • WEEKLY • MONTHLY • QUARTERLY • YEARLY
priceCompDetails	Displays the price component details of the rate component defined for the price item price assignment.

Tag Name	Tag Description
priceCompId	Displays the identification value of the price component.
priceCompDesc	Displays the description for the price component.
valueAmt	Displays the rate of the price component.
displaySw	Indicates whether the price component is displayed in the bill or not. The valid values are: <ul style="list-style-type: none"> • TRUE • FALSE
rcMapId	Displays the identification value of the rate component for the price component.
tieredFlag	Displays the tiering type used for the price component. The valid values are: <ul style="list-style-type: none"> • FLAT • STEP • THRESHOLD
priceCompSequenceNo	Displays the sequence number of the price component.
priceCompTier	Displays the tiering criteria of the price component.
tierSeqNum	Indicates the tiering sequence number.
priceCriteria	Indicates the tiering criterion which is used in the tiering range.
lowerLimit	Displays the lower limit of the pricing range.
upperLimit	Displays the upper limit of the pricing range.
priceCompParameterDetails	Displays the list of parameters based on which the price items total usage is considered for determining the rate. <p>Note: The value in this tag appears only when the Multi Price Parameter option type of the Multi Parameter Based Pricing (C1_PPARM_FLG) feature configuration is set to True.</p>
parameterCode	Indicates the parameter which is associated with the tiering criteria.
parameterValue	Displays the value for the parameter which is associated with the tiering criteria.
priceCompElig	Displays the pricing eligibility criteria defined for the price component. <p>Note: The value in this tag appears only when the isEligible tag is set to TRUE and the eligibility criteria is defined for the price component.</p>
sequenceNumber	Displays the order in which the pricing eligibility criteria is executed in the rule.
lhsPriceParmCd	Displays the left hand side parameter which you want to use along with the price item for price determination.
operator	Indicates the relational operator used to define the relation between the parameter name and the parameter value. The valid values are: <ul style="list-style-type: none"> • < • <= • <>

Tag Name	Tag Description
	<ul style="list-style-type: none"> • = • > • >= • BETWEEN • IN • LIKE • NOT IN
rhsPriceParmTypeFlg	<p>Indicates whether the parameter (on the left hand side) is compared against another parameter (on the right hand side) or directly against a parameter value.</p> <ul style="list-style-type: none"> • PARAMETER - Indicates that the parameter (on the left hand side) is compared against another parameter (on the right hand side). • VALUE - Indicates that the parameter (on the left hand side) is compared against a parameter value.
rhsPriceParmCd	<p>Displays the parameter against which you have compared the parameter (on the left hand side).</p>
rhsPriceParmVal	<p>Displays the parameter value against which you have compared the parameter (on the left hand side).</p>
isTrueFlag	<p>Indicates what should happen when the condition is true (satisfied). The valid values are:</p> <ul style="list-style-type: none"> • COND - Indicates that the condition with the consecutive sequence number is executed. • RLFS - Indicates that the action specified in the Rule False Action field is executed. • RLTR - Indicates that the action specified in the Rule True Action field is executed.
isFalseFlag	<p>Indicates what should happen when the condition is false (not satisfied). The valid values are:</p> <ul style="list-style-type: none"> • COND - Indicates that the condition with the consecutive sequence number is executed. • RLFS - Indicates that the action specified in the Rule False Action field is executed. • RLTR - Indicates that the action specified in the Rule True Action field is executed.
isInsufficientFlag	<p>Used to indicate what should happen when the data is insufficient. The valid values are:</p> <ul style="list-style-type: none"> • COND - Indicates that the condition with the consecutive sequence number is executed. • RLFS - Indicates that the action specified in the Rule False Action field is executed. • RLTR - Indicates that the action specified in the Rule True Action field is executed.

Tag Name	Tag Description
commitmentDetails	Displays the price items commitment details for the entity (i.e. person or account).
priceItemCode	Displays the price item whose commitment details you are viewing.
priceItemDescription	Displays the description of the price item.
parameterDetails	Displays the list of parameters based on which the effective pricing is defined for the price item.
parameterCode	Displays the parameter based on which the effective pricing is defined for the price item.
parameterValue	Displays the value of the parameter.
SQIDetails	Displays the service quantity identifier details of the price item.
serviceQuantityIdentifier	Displays the service quantity identifier associated with the price item.
sqiValue	Displays the SQI value for the price item and parameter combination that is used for calculating the price item pricing.
sqiTypeFlg	Indicates the status of the service quantity identifier details for calculating the price item pricing.
termsAndConditionsDetails	Displays the list of terms and conditions associated with the deal at the price item level.
priceItemCode	Displays the price item to which the terms and conditions are associated.
priceItemDescription	Displays the description of the price item.
priceItemGroupCode	Displays the root level and/or non-root level hierarchy entity to which the price item belongs.
priceItemGroupCodeDescription	Displays the description of the root level and/or non-root level hierarchy entity to which the price item belongs.
parameterDetails	Displays the list of the parameters using which the price item pricing is defined in the system.
parameterCode	Indicates the parameter which is associated with the price item.
parameterValue	Displays the value of the parameter which is associated with the price item.
termsAndConditionsList	Displays information about the terms and conditions associated with the price item.
termsAndCondition	Indicates the term and condition which is associated with the price item.
description	Displays the description of the term and condition.
termsAndConditionText	Displays additional information of the term and condition.
entitycharacteristics	Displays the list of the characteristics defined for the entities (i.e. person or account) in the deal.
entityId	Displays the identification value of the entity (i.e. person or account) for which the characteristic is defined.
entityType	Indicates the type of the entity. The valid values are: <ul style="list-style-type: none"> • ACCT • PERS

Tag Name	Tag Description
entityIdentifierType	Indicates the identifier type using which the entity (i.e. person or account) is created in the system.
entityIdentifierValue	Displays the value of the identifier type using which the entity (i.e. person or account) is created in the system.
entityDivision	Indicates the division to which the entity (i.e. person or account) belongs.
entityCharacteristicsList	Displays information about the characteristic defined for the entity (i.e. person or account).
effectiveDate	Displays the date from when the characteristic is effective for the entity (i.e. person or account).
characteristicType	Indicates the characteristic type.
characteristicValue	Displays the value of the characteristic type.

Related Topics

For more information on...	See...
Sample deal extraction request and response in the XML format	Sample Deal Extraction Request and Response in the XML Format on page 4194

Sample Deal Extraction Request and Response in the XML Format

Using the below example, you can extract the deal details of 4235832132 deal ID.

Sample Deal Extraction Request in the XML Format

```
<C1-DealExtractionWebService>
  <dealDetails>
    <dealId>4235832132</dealId>
  </C1-DealExtractionWebService>
```

Sample Deal Extraction Response in the XML Format

```
<C1-DealExtractionWebService>
  <dealDetails>
    <dealEntityDetails>
      <personIdentifierType>COREG</personIdentifierType>
      <personIdentifier>Reg_SRP230520220852</personIdentifier>
      <personId>2003447796</personId>
      <division>IND</division>
    </dealEntityDetails>
    <dealIdentifier>Deal_Reg_SRP230520220852_v1</dealIdentifier>
    <dealInformation>4235832132,SRP230520220852,IND,05-23-2022,United
      States,Dollars,Contracted
      (1),Deal_Reg_SRP230520220852_v1,Deal_Reg_SRP190520220205_v1 desc,INDIA
      DIVISION,Tier,,Business banking,Deal type code for Deal
      Approval,Fully Orchestrated,Customer,System Default,Template-Yes,RMBK1
      ,05-23-2022,,05-23-2023,Yearly,Yearly,05-23-2022,05-23-2022,,Skip Reference-
      Yes,Account,2003447796,Yearly,05-23-2022,,05-23-2022,04-23-2023,Skip
      Questionnaire-Yes,,Include Hierarchy-Yes</dealInformation>
    <dealId>4235832132</dealId>
    <modelId>9284270861</modelId>
    <dealEntityType>EPER</dealEntityType>
    <customerSegment>COMM</customerSegment>
    <customerTier>T</customerTier>
    <division>IND</division>
    <accessGrp>***</accessGrp>
```

```

    <dealEntityId>2003447796</dealEntityId>
    <contractedDealFlag>>false</contractedDealFlag>
    <currency>USD</currency>
    <dealTypeCode>DLAPR</dealTypeCode>
    <startDate>2022-05-23</startDate>
    <simulationTypeFlag>CUST</simulationTypeFlag>
    <reviewFrequency>12</reviewFrequency>
    <dealDescription>Deal_Reg_SRP190520220205_v1 desc</dealDescription>
      <dealVersionDescription>Deal_Reg_SRP190520220205_v1 ver</
dealVersionDescription>
    <dealFrequency>12</dealFrequency>
    <skipReferenceFlag>>true</skipReferenceFlag>
    <priceSelectionDate>2022-05-23</priceSelectionDate>
    <usagePeriod>12</usagePeriod>
    <includeHierarchyFlag>>true</includeHierarchyFlag>
    <status>FORC</status>
    <dealVersionStatus>FNAL</dealVersionStatus>
    <templateFlag>>true</templateFlag>
    <createdDate>2022-05-23</createdDate>
    <acceptanceDate>2022-05-23</acceptanceDate>
    <finalizedDate>2022-05-23</finalizedDate>
    <effectiveStartDate>2022-05-23</effectiveStartDate>
    <reviewedDate>2023-05-23</reviewedDate>
  </dealDetails>
  <templateReferenceDetails>
    <copyBasicDetailsFlag>>false</copyBasicDetailsFlag>
    <copyPricingFlag>>false</copyPricingFlag>
    <copyUsageFlag>>false</copyUsageFlag>
  </templateReferenceDetails>
  <dealCharacteristics>
    <effectiveDate>2021-01-01</effectiveDate>
    <characteristicType>PROA</characteristicType>
    <characteristicValue>N</characteristicValue>
  </dealCharacteristics>
  <dealCharacteristics>
    <effectiveDate>2021-01-01</effectiveDate>
    <characteristicType>PROS1</characteristicType>
    <characteristicValue>N</characteristicValue>
  </dealCharacteristics>
  <dealTermsAndConditionsDetails>
    <termsAndConditionsList>
      <termsAndCondition>DEAL_T&C1</termsAndCondition>
      <description>DEAL_T&C1</description>
      <termsAndConditionText>DEAL_T&C1</termsAndConditionText>
    </termsAndConditionsList>
    <termsAndConditionsList>
      <termsAndCondition>DEAL_T&C2</termsAndCondition>
      <description>DEAL_T&C2</description>
      <termsAndConditionText>DEAL_T&C2</termsAndConditionText>
    </termsAndConditionsList>
  </dealTermsAndConditionsDetails>
  <referenceDetails>
    <referUsageSw>>false</referUsageSw>
    <referPriceSw>>false</referPriceSw>
    <includeChildHierarchyFlag>>false</includeChildHierarchyFlag>
  </referenceDetails>
  <dealComments>
    <sequenceNo>2</sequenceNo>
    <commentsDateTime>2022-05-23T12:12:31+10:00</commentsDateTime>
    <user>RMBK1</user>
    <dealComments>deal accepted 6364316717</dealComments>
  </dealComments>
  <dealComments>
    <sequenceNo>1</sequenceNo>

```

```

    <commentsDateTime>2022-05-23T11:42:29+10:00</commentsDateTime>
    <user>PMBK1</user>
    <dealComments>to test weighted commitment</dealComments>
    <reasonCode>RETURN</reasonCode>
  </dealComments>
  <dealSimulationDetails>
    <dealFinancialSummaryDetails>
      <originalDealFinancialSummary>
        <revenue>$3,600.00</revenue>
        <cost>$460.00</cost>
        <profit>$3,140.00</profit>
        <profitabilityPercentage>87.22</profitabilityPercentage>
      </originalDealFinancialSummary>
      <proposedDealFinancialSummary>
        <revenue>$38,862.50</revenue>
        <cost>$1,692.00</cost>
        <profit>$37,170.50</profit>
        <profitabilityPercentage>95.65</profitabilityPercentage>
      </proposedDealFinancialSummary>
    </dealFinancialSummaryDetails>
  </dealSimulationDetails>
  <hierarchySimulationDetails>
    <hierarchyDetails>
      <entityType>PERS</entityType>
      <entityId>2003447796</entityId>
      <entityIdentifierType>COREG</entityIdentifierType>
      <entityIdentifierValue>Reg_SRP230520220852</entityIdentifierValue>
      <entityDivision>IND</entityDivision>
      <status>Approved</status>
      <revenueVariation>979.51</revenueVariation>
      <proposedRevenue>$38,862.50</proposedRevenue>
      <proposedCost>$1,692.00</proposedCost>
      <originalRevenue>$3,600.00</originalRevenue>
      <originalCost>$460.00</originalCost>
    </hierarchyDetails>
    <hierarchyDetails>
      <entityType>ACCT</entityType>
      <entityId>2087243494</entityId>
      <entityIdentifierType>C1_F_ANO</entityIdentifierType>
      <entityIdentifierValue>EAI_SRP230520220852</entityIdentifierValue>
      <entityDivision>IND</entityDivision>
      <parentEntityId>2003447796</parentEntityId>
      <parentEntityIdentifierType>COREG</parentEntityIdentifierType>
      <parentEntityIdentifierValue>Reg_SRP230520220852</
parentEntityIdentifierValue>
      <parentEntityDivision>IND</parentEntityDivision>
      <status>Approved</status>
      <revenueVariation>208.09</revenueVariation>
      <proposedRevenue>$11,091.14</proposedRevenue>
      <proposedCost>$744.76</proposedCost>
      <originalRevenue>$3,600.00</originalRevenue>
      <originalCost>$460.00</originalCost>
    </hierarchyDetails>
    <hierarchyDetails>
      <entityType>ACCT</entityType>
      <entityId>2087243494</entityId>
      <entityIdentifierType>C1_F_ANO</entityIdentifierType>
      <entityIdentifierValue>EAI_SRP230520220852</entityIdentifierValue>
      <entityDivision>IND</entityDivision>
      <parentEntityId>2003447796</parentEntityId>
      <parentEntityIdentifierType>COREG</parentEntityIdentifierType>
      <parentEntityIdentifierValue>Reg_SRP230520220852</
parentEntityIdentifierValue>
      <parentEntityDivision>IND</parentEntityDivision>

```



```

        <status>Approved</status>
        <revenueVariation>208.09</revenueVariation>
        <proposedRevenue>$11,091.14</proposedRevenue>
        <proposedCost>$744.76</proposedCost>
        <originalRevenue>$3,600.00</originalRevenue>
        <originalCost>$460.00</originalCost>
    </hierarchyDetails>
</hierarchySimulationDetails>
<dealPricingAndCommitment>
    <pricingAndCommitmentsDetails>
        <entityId>2070828708</entityId>
        <entityType>PERS</entityType>
        <entityIdentifierType>COREG</entityIdentifierType>
            <entityIdentifierValue>Reg_SRP230520220852_PRSPCH1</
entityIdentifierValue>
        <entityDivision>IND</entityDivision>
    <pricingDetails>
        <priceAsgnId>3520032357</priceAsgnId>
        <priceItemCode>NPI_023</priceItemCode>
        <priceItemDescription>Price Item NPI_023</priceItemDescription>
            <hierarchyDetails>CORPORATE BANKING, ACCOUNT SERVICES</
hierarchyDetails>
        <pricingStatus>ACTV</pricingStatus>
        <priceCurrencyCode>USD</priceCurrencyCode>
        <rateSchedule>DM-RT01</rateSchedule>
        <startDate>2021-01-01</startDate>
        <isEligible>>false</isEligible>
        <assignmentLevel>Parent Customer Price List</assignmentLevel>
        <paTypeFlag>RGLR</paTypeFlag>
        <printIfZero>Y</printIfZero>
        <txnDailyRatingCrt>DNRT</txnDailyRatingCrt>
        <ignoreSw>N</ignoreSw>
        <aggregateSw>Y</aggregateSw>
        <scheduleCode>MONTHLY</scheduleCode>
    <priceCompDetails>
        <priceCompId>3529900005</priceCompId>
        <priceCompDesc>FLAT</priceCompDesc>
        <valueAmt>25.000000000000000000</valueAmt>
        <displaySw>>true</displaySw>
        <rcMapId>1705351562</rcMapId>
        <tieredFlag>FLAT</tieredFlag>
        <priceCompSequenceNo>10</priceCompSequenceNo>
    </priceCompDetails>
</pricingDetails>
    <pricingDetails>
        <priceAsgnId>3520032356</priceAsgnId>
        <priceItemCode>NPI_022</priceItemCode>
        <priceItemDescription>Price Item NPI_022</priceItemDescription>
            <hierarchyDetails>CORPORATE BANKING, ACCOUNT SERVICES</
hierarchyDetails>
        <pricingStatus>ACTV</pricingStatus>
        <priceCurrencyCode>USD</priceCurrencyCode>
        <rateSchedule>DM-RT01</rateSchedule>
        <startDate>2021-01-01</startDate>
        <isEligible>>false</isEligible>
        <assignmentLevel>Parent Customer Price List</assignmentLevel>
        <paTypeFlag>RGLR</paTypeFlag>
        <printIfZero>Y</printIfZero>
        <txnDailyRatingCrt>DNRT</txnDailyRatingCrt>
        <ignoreSw>N</ignoreSw>
        <aggregateSw>Y</aggregateSw>
        <scheduleCode>MONTHLY</scheduleCode>
    <priceCompDetails>
        <priceCompId>3529900005</priceCompId>

```

```

        <priceCompDesc>FLAT</priceCompDesc>
        <valueAmt>25.000000000000000000</valueAmt>
        <displaySw>true</displaySw>
        <rcMapId>1705351562</rcMapId>
        <tieredFlag>FLAT</tieredFlag>
        <priceCompSequenceNo>10</priceCompSequenceNo>
    </pricingDetails>
    <pricingDetails>
        <priceAsgnId>3520032355</priceAsgnId>
        <priceItemCode>NPI_021</priceItemCode>
        <priceItemDescription>Price Item NPI_021</priceItemDescription>
        <hierarchyDetails>CORPORATE BANKING, ACCOUNT SERVICES</
hierarchyDetails>
        <pricingStatus>ACTV</pricingStatus>
        <priceCurrencyCode>USD</priceCurrencyCode>
        <rateSchedule>DM-RT01</rateSchedule>
        <startDate>2021-01-01</startDate>
        <isEligible>>false</isEligible>
        <assignmentLevel>Parent Customer Price List</assignmentLevel>
        <paTypeFlag>RGLR</paTypeFlag>
        <printIfZero>Y</printIfZero>
        <txnDailyRatingCrt>DNRT</txnDailyRatingCrt>
        <ignoreSw>N</ignoreSw>
        <aggregateSw>Y</aggregateSw>
        <scheduleCode>MONTHLY</scheduleCode>
        <priceCompDetails>
            <priceCompId>3529900009</priceCompId>
            <priceCompDesc>FLAT</priceCompDesc>
            <valueAmt>25.000000000000000000</valueAmt>
            <displaySw>true</displaySw>
            <rcMapId>1705351562</rcMapId>
            <tieredFlag>FLAT</tieredFlag>
            <priceCompSequenceNo>10</priceCompSequenceNo>
        </pricingDetails>
        <commitmentDetails>
            <priceItemCode>NPI_021</priceItemCode>
            <priceItemDescription>Price Item NPI_021</priceItemDescription>
            <SQIDetails>
                <serviceQuantityIdentifier>BK-NBR</serviceQuantityIdentifier>
                <sqiValue>2.800000000000000000</sqiValue>
                <sqiTypeFlg>PRPD</sqiTypeFlg>
            </SQIDetails>
        </commitmentDetails>
        <commitmentDetails>
            <priceItemCode>NPI_022</priceItemCode>
            <priceItemDescription>Price Item NPI_022</priceItemDescription>
            <SQIDetails>
                <serviceQuantityIdentifier>BK-NBR</serviceQuantityIdentifier>
                <sqiValue>2.000000000000000000</sqiValue>
                <sqiTypeFlg>PRPD</sqiTypeFlg>
            </SQIDetails>
        </commitmentDetails>
        <commitmentDetails>
            <priceItemCode>NPI_023</priceItemCode>
            <priceItemDescription>Price Item NPI_023</priceItemDescription>
            <SQIDetails>
                <serviceQuantityIdentifier>BK-NBR</serviceQuantityIdentifier>
                <sqiValue>2.000000000000000000</sqiValue>
                <sqiTypeFlg>PRPD</sqiTypeFlg>
            </SQIDetails>
        </commitmentDetails>
    </termsAndConditionsDetails>
    <priceItemCode>PI_021</priceItemCode>
    <priceItemDescription>V1-Account Opening Fee</priceItemDescription>

```

```

    <termsAndConditionsList>
      <termsAndCondition>DEAL_T&C3</termsAndCondition>
      <description>DEAL_T&C3</description>
      <termsAndConditionText>DEAL_T&C3</termsAndConditionText>
    </termsAndConditionsList>
    <termsAndConditionsList>
      <termsAndCondition>DEAL_T&C4</termsAndCondition>
      <description>DEAL_T&C4</description>
      <termsAndConditionText>DEAL_T&C4</termsAndConditionText>
    </termsAndConditionsList>
  </termsAndConditionsDetails>
  <termsAndConditionsDetails>
    <priceItemGroupCode>ACCOUNT SERVICES</priceItemGroupCode>
    <priceItemGroupCodeDescription>Account Services</
priceItemGroupCodeDescription>
    <termsAndConditionsList>
      <termsAndCondition>DEAL_T&C5</termsAndCondition>
      <description>DEAL_T&C5</description>
      <termsAndConditionText>DEAL_T&C5</termsAndConditionText>
    </termsAndConditionsList>
    <termsAndConditionsList>
      <termsAndCondition>DEAL_T&C6</termsAndCondition>
      <description>DEAL_T&C6</description>
      <termsAndConditionText>DEAL_T&C6</termsAndConditionText>
    </termsAndConditionsList>
  </termsAndConditionsDetails>
  <priceItemGroupCode>CORPORATE BANKING</priceItemGroupCode>
  <priceItemGroupCodeDescription>Corporate Banking</
priceItemGroupCodeDescription>
    <termsAndConditionsList>
      <termsAndCondition>DEAL_T&C7</termsAndCondition>
      <description>DEAL_T&C7</description>
      <termsAndConditionText>DEAL_T&C7</termsAndConditionText>
    </termsAndConditionsList>
    <termsAndConditionsList>
      <termsAndCondition>DEAL_T&C8</termsAndCondition>
      <description>DEAL_T&C8</description>
      <termsAndConditionText>DEAL_T&C8</termsAndConditionText>
    </termsAndConditionsList>
  </termsAndConditionsDetails>
</pricingAndCommitmentsDetails>
<pricingAndCommitmentsDetails>
  <entityId>2003447796</entityId>
  <entityType>PERS</entityType>
  <entityIdentifierType>COREG</entityIdentifierType>
  <entityIdentifierValue>Reg_SRP230520220852</entityIdentifierValue>
  <entityDivision>IND</entityDivision>
  <pricingDetails>
    <priceAsgnId>3520032358</priceAsgnId>
    <priceItemCode>NPI_024</priceItemCode>
    <priceItemDescription>Price Item NPI_024</priceItemDescription>
    <hierarchyDetails>CORPORATE BANKING, ACCOUNT SERVICES</
hierarchyDetails>
    <cost>$460.00</cost>
    <revenue>$3,600.00</revenue>
    <averagePrice>$24.00</averagePrice>
    <pricingStatus>ACTV</pricingStatus>
    <priceCurrencyCode>USD</priceCurrencyCode>
    <rateSchedule>DM-RT01</rateSchedule>
    <startDate>2021-01-01</startDate>
    <isEligible>>false</isEligible>
    <assignmentLevel>Customer Price List</assignmentLevel>
    <paTypeFlag>RGLR</paTypeFlag>
    <printIfZero>Y</printIfZero>

```

```

    <txnDailyRatingCrt>DNRT</txnDailyRatingCrt>
    <ignoreSw>N</ignoreSw>
    <aggregateSw>Y</aggregateSw>
    <scheduleCode>MONTHLY</scheduleCode>
    <priceCompDetails>
      <priceCompId>3529900007</priceCompId>
      <priceCompDesc>FLAT</priceCompDesc>
      <valueAmt>25.000000000000000000</valueAmt>
      <displaySw>>true</displaySw>
      <rcMapId>1705351562</rcMapId>
      <tieredFlag>FLAT</tieredFlag>
      <priceCompSequenceNo>10</priceCompSequenceNo>
    </priceCompDetails>
  </pricingDetails>
  <commitmentDetails>
    <priceItemCode>NPI_024</priceItemCode>
    <priceItemDescription>Price Item NPI_024</priceItemDescription>
    <SQIDetails>
      <serviceQuantityIdentifier>BK-NBR</serviceQuantityIdentifier>
      <sqiValue>175.000000000000000000</sqiValue>
      <sqiTypeFlg>PRPD</sqiTypeFlg>
    </SQIDetails>
    <SQIDetails>
      <serviceQuantityIdentifier>BK-NBR</serviceQuantityIdentifier>
      <sqiValue>150.000000000000000000</sqiValue>
      <sqiTypeFlg>ACTV</sqiTypeFlg>
    </SQIDetails>
  </commitmentDetails>
  <termsAndConditionsDetails>
    <priceItemCode>PI_024</priceItemCode>
    <priceItemDescription>V1-Account Opening Fee</priceItemDescription>
    <termsAndConditionsList>
      <termsAndCondition>DEAL_T&C3</termsAndCondition>
      <description>DEAL_T&C3</description>
      <termsAndConditionText>DEAL_T&C3</termsAndConditionText>
    </termsAndConditionsList>
    <termsAndConditionsList>
      <termsAndCondition>DEAL_T&C4</termsAndCondition>
      <description>DEAL_T&C4</description>
      <termsAndConditionText>DEAL_T&C4</termsAndConditionText>
    </termsAndConditionsList>
  </termsAndConditionsDetails>
  <termsAndConditionsDetails>
    <priceItemGroupCode>ACCOUNT SERVICES</priceItemGroupCode>
    <priceItemGroupCodeDescription>Account Services</
priceItemGroupCodeDescription>
    <termsAndConditionsList>
      <termsAndCondition>DEAL_T&C5</termsAndCondition>
      <description>DEAL_T&C5</description>
      <termsAndConditionText>DEAL_T&C5</termsAndConditionText>
    </termsAndConditionsList>
    <termsAndConditionsList>
      <termsAndCondition>DEAL_T&C6</termsAndCondition>
      <description>DEAL_T&C6</description>
      <termsAndConditionText>DEAL_T&C6</termsAndConditionText>
    </termsAndConditionsList>
  </termsAndConditionsDetails>
  <termsAndConditionsDetails>
    <priceItemGroupCode>CORPORATE BANKING</priceItemGroupCode>
    <priceItemGroupCodeDescription>Corporate Banking</
priceItemGroupCodeDescription>
    <termsAndConditionsList>
      <termsAndCondition>DEAL_T&C7</termsAndCondition>
      <description>DEAL_T&C7</description>

```

```

        <termsAndConditionText>DEAL_T&C7</termsAndConditionText>
      </termsAndConditionsList>
    </termsAndConditionsList>
    <termsAndCondition>DEAL_T&C8</termsAndCondition>
    <description>DEAL_T&C8</description>
    <termsAndConditionText>DEAL_T&C8</termsAndConditionText>
  </termsAndConditionsList>
</termsAndConditionsDetails>
</pricingAndCommitmentsDetails>
</dealPricingAndCommitment>
<entitycharacteristics>
  <entityId>NPI_021</entityId>
  <entityType>PRICEITEM</entityType>
  <entityCharacteristicsList>
    <effectiveDate>2015-01-01</effectiveDate>
    <characteristicType>PPSEQ</characteristicType>
    <characteristicValue>10</characteristicValue>
  </entityCharacteristicsList>
</entitycharacteristics>
<entitycharacteristics>
  <entityId>NPI_022</entityId>
  <entityType>PRICEITEM</entityType>
  <entityCharacteristicsList>
    <effectiveDate>2015-01-01</effectiveDate>
    <characteristicType>PPSEQ</characteristicType>
    <characteristicValue>10</characteristicValue>
  </entityCharacteristicsList>
</entitycharacteristics>
<entitycharacteristics>
  <entityId>2087243494</entityId>
  <entityType>ACCT</entityType>
  <entityIdentifierType>C1_F_ANO</entityIdentifierType>
  <entityIdentifierValue>EAI_SRP230520220852</entityIdentifierValue>
  <entityDivision>IND</entityDivision>
  <entityCharacteristicsList>
    <effectiveDate>2021-05-05</effectiveDate>
    <characteristicType>C1_F_ANO</characteristicType>
    <characteristicValue>1298312131</characteristicValue>
  </entityCharacteristicsList>
  <entityCharacteristicsList>
    <effectiveDate>2021-05-05</effectiveDate>
    <characteristicType>C1_F_ATY</characteristicType>
    <characteristicValue>SAVINGS</characteristicValue>
  </entityCharacteristicsList>
  <entityCharacteristicsList>
    <effectiveDate>2021-03-03</effectiveDate>
    <characteristicType>VG_STATE</characteristicType>
    <characteristicValue>MH</characteristicValue>
  </entityCharacteristicsList>
</entitycharacteristics>
<entitycharacteristics>
  <entityId>2003447796</entityId>
  <entityType>PERS</entityType>
  <entityIdentifierType>COREG</entityIdentifierType>
  <entityIdentifierValue>Reg_SRP230520220852</entityIdentifierValue>
  <entityDivision>IND</entityDivision>
  <entityCharacteristicsList>
    <effectiveDate>2022-03-04</effectiveDate>
    <characteristicType>C1-GENDR</characteristicType>
    <characteristicValue>MALE</characteristicValue>
  </entityCharacteristicsList>
  <entityCharacteristicsList>
    <effectiveDate>2022-03-04</effectiveDate>
    <characteristicType>C1_BRTDT</characteristicType>

```

```

        <characteristicValue>1994-03-20</characteristicValue>
    </entityCharacteristicsList>
    <entityCharacteristicsList>
        <effectiveDate>2022-03-04</effectiveDate>
        <characteristicType>PERAGE</characteristicType>
        <characteristicValue>63</characteristicValue>
    </entityCharacteristicsList>
</entitycharacteristics>
<entitycharacteristics>
    <entityId>2070828708</entityId>
    <entityType>PERS</entityType>
    <entityIdentifierType>COREG</entityIdentifierType>
        <entityIdentifierValue>Reg_SRP230520220852_PRSPCH1</
entityIdentifierValue>
    <entityDivision>IND</entityDivision>
    <entityCharacteristicsList>
        <effectiveDate>2022-03-04</effectiveDate>
        <characteristicType>C1-GENDR</characteristicType>
        <characteristicValue>MALE</characteristicValue>
    </entityCharacteristicsList>
    <entityCharacteristicsList>
        <effectiveDate>2022-03-04</effectiveDate>
        <characteristicType>C1_BRTDT</characteristicType>
        <characteristicValue>1994-03-20</characteristicValue>
    </entityCharacteristicsList>
    <entityCharacteristicsList>
        <effectiveDate>2022-03-04</effectiveDate>
        <characteristicType>PERAGE</characteristicType>
        <characteristicValue>63</characteristicValue>
    </entityCharacteristicsList>
</entitycharacteristics>
</C1-DealExtractionWebService>

```

Related Topics

For more information on...	See...
Deal extraction request and response tags in the XML format	Deal Extraction Request and Response - Tags in the XML Format on page 4178

Deal Extraction Request in the JSON Format

The following code snippet illustrates how attribute/value pairs should be structured while sending the deal extraction request in the JSON format:

```

{
  "C1-DealExtractionWebService":
  {
    "dealDetails"
    {
      "dealIdentifier" : "",
      "dealId" : "",
      "modelId" : "",
    }
  }
}

```

Related Topics

For more information on...	See...
Deal extraction request and response attribute/value pairs in the JSON format	Deal Creation Request and Response - Attribute Value Pairs in the JSON Format on page 4087

For more information on...	See...
Sample deal extraction request and response in the JSON format	Sample Deal Extraction Request and Response in the JSON Format on page 4225

Deal Extraction Response in the JSON Format

The following code snippet illustrates how attribute/value pairs should be structured while receiving the deal extraction response in the JSON format:

```
{
  "Cl-DealExtractionWebService":
  {
    "dealDetails":
    {
      "dealEntityDetails":
      {
        "personIdentifierType" : "",
        "personIdentifier" : "",
        "personId" : "",
        "accountIdentifierType" : "",
        "accountIdentifier" : "",
        "accountId" : "",
        "prsPerIdentifierType" : "",
        "prsPerIdentifier" : "",
        "prospectPersonId" : "",
        "division" : ""
      }
      "dealIdentifier" : "",
      "dealInformation" : "",
      "dealId" : "",
      "modelId" : "",
      "dealEntityType" : "",
      "customerSegment" : "",
      "customerTier" : "",
      "division" : "",
      "accessGrp" : "",
      "dealEntityId" : "",
      "contractedDealFlag" : "",
      "currency" : "",
      "dealTypeCode" : "",
      "startDate" : "",
      "endDate" : "",
      "simulationTypeFlag" : "",
      "reviewFrequency" : "",
      "dealDescription" : "",
      "dealVersionDescription" : "",
      "dealFrequency" : "",
      "skipReferenceFlag" : "",
      "priceSelectionDate" : "",
      "usagePeriod" : "",
      "includeHierarchyFlag" : "",
      "status" : "",
      "dealVersionStatus" : "",
      "templateFlag" : "",
      "createdDate" : "",
      "acceptanceDate" : "",
      "finalizedDate" : "",
      "effectiveStartDate" : "",
      "effectiveEndDate" : "",
      "reviewedDate" : "",
    }
    "templateReferenceDetails" :
```

```

{
  "templateDealId" : "",
  "templateDealIdentifier" : "",
  "templateModelId" : "",
  "copyBasicDetailsFlag" : "",
  "copyPricingFlag" : "",
  "copyUsageFlag" : "",
}
"dealCharacteristics" :
{
  "effectiveDate" : "",
  "characteristicType" : "",
  "characteristicValue" : "",
}
"dealTermsAndConditionsDetails" :
{
  "termsAndConditionsList" :
  {
    "termsAndCondition" : "",
    "description" : "",
    "termsAndConditionText" : "",
  }
}
"productDetailsList" :
{
  "productCode" : "",
}
"referenceDetails" :
{
  "referenceTypeFlg" : "",
  "refPersonIdentifierType" : "",
  "refPersonIdentifier" : "",
  "referPersonId" : "",
  "refAccountIdentifierType" : "",
  "refAccountIdentifier" : "",
  "referAccountId" : "",
  "referDealIdentifier" : "",
  "referenceDealId" : "",
  "referenceModelId" : "",
  "referUsageSw" : "",
  "referPriceSw" : "",
  "includeChildHierarchyFlag" : "",
  "division" : "",
}
"dealComments" :
{
  "sequenceNo" : "",
  "commentsDateTime" : "",
  "user" : "",
  "dealComments" : "",
  "reasonCode" : "",
}
"modelComments" :
{
  "sequenceNo" : "",
  "commentsDateTime" : "",
  "user" : "",
  "modelComments" : "",
}
"adhocRevenueCostDetails" :
{
  "sequence" : "",
  "revenueTypeFlag" : "",
  "revenueCostGroupFlag" : "",
}

```



```

        "division" : "",
        "currency" : "",
        "amount" : "",
        "priceItem" : "",
    }
    "dealSimulationDetails" :
    {
        "dealFinancialSummaryDetails" :
        {
            "approvalStatus" : "",
            "originalDealFinancialSummary" :
            {
                "revenue" : "",
                "cost" : "",
                "profit" : "",
                "profitabilityPercentage" : "",
            }
            "proposedDealFinancialSummary" :
            {
                "revenue" : "",
                "cost" : "",
                "profit" : "",
                "profitabilityPercentage" : "",
            }
            "recommendedDealFinancialSummary" :
            {
                "revenue" : "",
                "profit" : "",
                "profitabilityPercentage" : "",
            }
            "profitVariationPercentage" : "",
        }
        "divisionFinancialSummaryDetails" :
        {
            "division" : "",
            "approvalStatus" : "",
            "originalDivisionFinancialSummary" :
            {
                "revenue" : "",
                "cost" : "",
                "profit" : "",
                "profitabilityPercentage" : "",
            }
            "proposedDivisionFinancialSummary" :
            {
                "revenue" : "",
                "cost" : "",
                "profit" : "",
                "profitabilityPercentage" : "",
            }
            "recommendedDealFinancialSummary" :
            {
                "revenue" : "",
                "profit" : "",
                "profitabilityPercentage" : "",
            }
            "profitVariationPercentage" : "",
        }
    }
    "productFinancialSummaryDetails" :
    {
        "approvalStatus" : "",
        "product" : "",
        "division" : "",
        "originalProductFinancialSummary" :

```

```

    {
      "revenue" : "",
      "cost" : "",
      "profit" : "",
      "profitabilityPercentage" : "",
    }
    "proposedProductDivisionFinancialSummary" :
    {
      "revenue" : "",
      "cost" : "",
      "profit" : "",
      "profitabilityPercentage" : "",
    }
    "recommendedDealFinancialSummary" :
    {
      "revenue" : "",
      "profit" : "",
      "profitabilityPercentage" : "",
    }
    "profitVariationPercentage" : "",
  }
}
"hierarchySimulationDetails" :
{
  "hierarchyDetails" :
  {
    "entityType" : "",
    "entityId" : "",
    "entityIdentifierType" : "",
    "entityIdentifierValue" : "",
    "entityDivision" : "",
    "parentEntityId" : "",
    "parentEntityIdentifierType" : "",
    "parentEntityIdentifierValue" : "",
    "parentEntityDivision" : "",
    "status" : "",
    "revenueVariation" : "",
    "proposedRevenue" : "",
    "proposedCost" : "",
    "originalRevenue" : "",
    "originalCost" : "",
  }
}
"dealPricingAndCommitment" :
{
  "pricingAndCommitmentsDetails" :
  {
    "entityId" : "",
    "entityType" : "",
    "entityIdentifierType" : "",
    "entityIdentifierValue" : "",
    "entityDivision" : "",
    "pricingDetails" :
    {
      "priceAsgnId" : "",
      "priceItemCode" : "",
      "priceItemDescription" : "",
      "hierarchyDetails" : "",
      "cost" : "",
      "revenue" : "",
      "averagePrice" : "",
      "variation" : "",
      "pricingStatus" : "",
      "priceCurrencyCode" : "",
    }
  }
}

```

```

"rateSchedule" : "",
"startDate" : "",
"endDate" : "",
"isEligible" : "",
"assignmentLevel" : "",
"paTypeFlag" : "",
"printIfZero" : "",
"priceAssignCharacteristics" :
{
  "characteristicType" : "",
  "effectiveDate" : "",
  "characteristicValue" : "",
}
"parameterDetails" :
{
  "parameterCode" : "",
  "parameterValue" : "",
}
"txnDailyRatingCrt" : "",
"ignoreSw" : "",
"aggregateSw" : "",
"scheduleCode" : "",
"priceCompDetails" :
{
  "priceCompId" : "",
  "priceCompDesc" : "",
  "valueAmt" : "",
  "displaySw" : "",
  "rcMapId" : "",
  "tieredFlag" : "",
  "priceCompSequenceNo" : "",
  "priceCompTier" :
  {
    "tierSeqNum" : "",
    "priceCriteria" : "",
    "lowerLimit" : "",
    "upperLimit" : "",
    "priceCompParameterDetails" :
    {
      "parameterCode" : "",
      "parameterValue" : "",
    }
  }
}
"priceCompElig" :
{
  "sequenceNumber" : "",
  "lhsPriceParmCd" : "",
  "operator" : "",
  "rhsPriceParmTypeFlg" : "",
  "rhsPriceParmCd" : "",
  "rhsPriceParmVal" : "",
  "isTrueFlag" : "",
  "isFalseFlag" : "",
  "isInsufficientFlag" : "",
}
}
}
"commitmentDetails" :
{
  "priceItemCode" : "",
  "priceItemDescription" : "",
  "parameterDetails" :
  {
    "parameterCode" : "",

```

```

        "parameterValue" : "",
    }
    "SQIDetails" :
    {
        "serviceQuantityIdentifier" : "",
        "sqiValue" : "",
        "sqiTypeFlg" : "",
    }
}
"termsAndConditionsDetails" :
{
    "priceItemCode" : "",
    "priceItemDescription" : "",
    "priceItemGroupCode" : "",
    "priceItemGroupCodeDescription" : "",
    "parameterDetails" :
    {
        "parameterCode" : "",
        "parameterValue" : "",
    }
    "termsAndConditionsList" :
    {
        "termsAndCondition" : "",
        "description" : "",
        "termsAndConditionText" : "",
    }
}
}
}
"entitycharacteristics>
{
    "entityId" : "",
    "entityType" : "",
    "entityIdentifierType" : "",
    "entityIdentifierValue" : "",
    "entityDivision" : "",
    "entityCharacteristicsList" :
    {
        "effectiveDate" : "",
        "characteristicType" : "",
        "characteristicValue" : "",
    }
}
}
}

```

Related Topics

For more information on...	See...
Deal extraction request and response attribute/value pairs in the JSON format	Deal Creation Request and Response - Attribute Value Pairs in the JSON Format on page 4087
Sample deal extraction request and response in the JSON format	Sample Deal Extraction Request and Response in the JSON Format on page 4225

Deal Extraction Request and Response - Attribute/Value Pairs in the JSON Format

Note: We recommend you to refer the topics [Deal Extraction Request in the JSON Format](#) on page 4202 and [Deal Extraction Response in the JSON Format](#) on page 4203 in parallel while understanding the below mentioned attributes. This will help you to understand how the attributes are structured in the JSON format.

Before calling the **C1-DealExtractionWebService** business service through an inbound web service, you need to ensure that the deal extract request contains the following attributes:

Attribute Name	Attribute Description	Mandatory (Yes or No)
dealIdentifier	Used to specify the primary identifier of the deal using which you want to extract the details of the deal.	Yes (Conditional)
	<p>Note:</p> <p>If you specify the dealIdentifier attribute, you need not specify the dealId and the modelId attributes.</p> <p>If the deal has multiple versions, then, you should specify the modelId attribute instead of the dealIdentifier attribute.</p>	<p>Note: This data is required if you do not specify the dealId and modelId attributes.</p>
dealId	Used to specify the deal ID using which you want to extract the details of the deal.	Yes (Conditional)
	<p>Note:</p> <p>If you specify the dealId attribute, you need not specify the dealIdentifier and the modelId attributes.</p> <p>If the deal has multiple versions, then, you should specify the modelId attribute instead of the dealId attribute.</p>	<p>Note: This data is required if you do not specify the dealIdentifier and modelId attributes.</p>
modelId	Used to specify the deal version using which you want to extract the details of the deal.	Yes (Conditional)
	<p>Note:</p> <p>If you specify the modelId attribute, you need not specify the dealIdentifier and the dealId attributes.</p>	<p>Note: This data is required if you do not specify the dealIdentifier and dealId attributes.</p>

Once the deal is extracted, all the details of deal are listed in the above mentioned attributes along with the following attributes:

Attribute Name	Attribute Description
dealDetails	Displays basic information about the deal.
dealEntityDetails	Displays basic information about the entity (i.e. existing person, account, or prospect person) for which the deal is created in the system.
personIdentifierType	Indicates the identifier type using which the person is created in the system.
	<p>Note: The value in this attribute appears only when the value of the dealEntityType attribute is EPER.</p>
personIdentifier	Displays the value of person identifier type.

Attribute Name	Attribute Description
	Note: The value in this attribute appears only when the value of the dealEntityType attribute is EPER .
personId	Displays the existing person for whom the deal created in the system. Note: The value in this attribute appears only when the value of the dealEntityType attribute is EPER .
accountIdentifierType	Indicates the identifier type using which the account is created in the system. Note: The value in this attribute appears only when the value of the dealEntityType attribute is EACC .
accountIdentifier	Displays the value of the account identifier type. Note: The value in this attribute appears only when the value of the dealEntityType attribute is EACC .
accountId	Displays the existing account for which the deal is created in the system. Note: The value in this attribute appears only when the value of the dealEntityType attribute is EACC .
prsPerIdentifierType	Indicates the identifier type using which the prospect person is created in the system. Note: The value in this attribute appears only when the value of the dealEntityType attribute is PRSP .
prsPerIdentifier	Displays the value of the prospect person identifier type. Note: The value in this attribute appears only when the value of the dealEntityType attribute is PRSP .
prospectPersonId	Displays the prospect person for whom the deal is created in the system. Note: The value in this attribute appears only when the value of the dealEntityType attribute is PRSP .
division	Indicates the division to which the entity (i.e. existing person, account, or prospect person) belongs.
dealInformation	Displays the concatenated string of information about the deal separated by a comma (,).
dealEntityType	Indicates the type of entity for which the deal is created in the system. The valid values are: <ul style="list-style-type: none"> • EPER - Indicates that the deal is created for an existing person. • EACC - Indicates that the deal is created for an existing account. • PRSP - Indicates that the deal is created for a prospect person.
customerSegment	Indicates the business component to which the entity (i.e. existing person, account, or prospect person) belongs.

Attribute Name	Attribute Description
customerTier	Indicates the customer tier of the customer segment to which the entity (i.e. existing person, account, or prospect person) belongs.
division	Indicates the division to which the deal belongs.
accessGrp	Indicate the user group who can view and edit the details of the deal.
dealEntityId	Displays the entity (i.e. existing person, account, or prospect person) whose deal details you are viewing.
contractedDealFlag	Indicates whether the change in the price item pricing from the price list affects the price item pricing offered in the deal created for the entity (i.e. existing person, account, or prospect person) or not. The valid values are: <ul style="list-style-type: none"> • true • false
currency	Indicates the currency in which the deal level, division level, or product level financial summary and profitability of the deal is calculated.
dealTypeCode	Indicates the deal type using which the deal is created in the system.
startDate	Displays the date from when the deal is effective for the entity (i.e. the existing person, account or prospect person).
endDate	Displays the date till when the deal is effective for the entity (i.e. the existing person, account, or prospect person).
simulationTypeFlag	Indicates the simulation type using which the cost, revenue, and profitability of the deal is analyzed. The valid values are: <ul style="list-style-type: none"> • CUST • ACCT • DEAL
reviewFrequency	Indicates the timely monitoring of the deal usage as per the commitments made by the customer. The valid values are: <ul style="list-style-type: none"> • 6 - Indicates that you want to monitor the deal usage biannually. • 12 - Indicates that you want to monitor the deal usage annually. • 24 - Indicates that you want to monitor the deal usage in every two years.
dealDescription	Displays the description of the deal.
dealVersionDescription	Displays the description of the deal version.
dealFrequency	Indicates the duration in which the financial summary and profitability of the deal is calculated through simulation. The valid values are: <ul style="list-style-type: none"> • 1 - Indicates that you want to simulate the deal every month. • 3 - Indicates that you want to simulate the deal quarterly. • 6 - Indicates that you want to simulate the deal biannually. • 12 - Indicates that you want to simulate the deal annually.
skipReferenceFlag	Indicates whether the deal is created by referring the pricing and commitments of a deal which is already created in the system. The valid values are: <ul style="list-style-type: none"> • true

Attribute Name	Attribute Description
	<ul style="list-style-type: none"> false
priceSelectionDate	Displays the date from when the price lists, pricing assignments, and product enrollments are effective for simulation.
usagePeriod	<p>Indicates the period for which deal data is aggregated to determine the scope of the deal. The valid values are:</p> <ul style="list-style-type: none"> 1 - Indicates that you want to aggregate the deal data every month. 3 - Indicates that you want to aggregate the deal data quarterly. 6 - Indicates that you want to aggregate the deal data biannually. 12 - Indicates that you want to aggregate the deal data annually.
includeHierarchyFlag	<p>Indicates whether the child persons, grandchild persons, and their accounts in the customer hierarchy is included in the deal or not. The valid values are:</p> <ul style="list-style-type: none"> true false
status	Indicates the current status of the deal.
dealVersionStatus	Indicates the current status of the deal version.
templateFlag	<p>Indicates whether the deal is used as a template while searching references for creating other deals. The valid values are:</p> <ul style="list-style-type: none"> true false
createdDate	Displays the date when the deal is created in the system.
acceptanceDate	<p>Displays the date when the deal is accepted in the system after the customer review and acceptance.</p> <p>Note: The data in this attribute appears only when the deal has reached the Accepted status. If the deal status is Rejected, then the acceptanceDate attribute specifies the date when the deal is rejected in the system.</p>
finalizedDate	Displays the date when the deal is finalized in the system.
effectiveStartDate	Displays the date from when the proposed price list assignments, product enrollments and price assignments are effective for the deal.
effectiveEndDate	Displays the date till when the proposed price list assignments, product enrollments and price assignments are effective for the deal.
reviewedDate	Displays the date when the deal usage as per the commitments made by the customer is reviewed in the system.
templateReferenceDetails	Displays the details of the template deal which is used as a reference for creating the deal.
templateDealId	Displays the particular template deal which is used for creating the deal.
templateDealIdentifier	Displays the primary identifier using which the template deal is created in the system.
templateModelId	Displays the particular template deal version which is used for creating the deal.

Attribute Name	Attribute Description
copyBasicDetailsFlag	Indicates whether the basic details are copied from the template deal to the deal which is created for the entity (i.e. existing person, account, or prospect person) or not. The valid values are: <ul style="list-style-type: none"> • true • false
copyPricingFlag	Indicates whether the price list assignments and price assignments are copied from the template deal to the deal which is created for the entity (i.e. existing person, account, or prospect person) or not. The valid values are: <ul style="list-style-type: none"> • true • false
copyUsageFlag	Indicates whether the commitments from the SQL-based billable charges are copied from the template deal to the deal which is created for the entity (i.e. existing person, account, or prospect person) or not. The valid values are: <ul style="list-style-type: none"> • true • false
dealCharacteristics	Displays the list of characteristics of the deal.
effectiveDate	Displays the date from when the characteristic is effective for the deal.
characteristicType	Indicates the characteristic type.
characteristicValue	Displays the value of the characteristic type.
dealTermsAndConditionsDetails	Displays the list of terms and conditions which are associated with the deal.
termsAndConditionsList	Displays the terms and conditions of the deal.
termsAndCondition	Displays the term and condition which is associated with the deal.
description	Displays the description of the term and condition.
termsAndConditionText	Displays additional information about the term and condition.
productDetailsList	Displays the list of products recommended for the deal.
productCode	Displays the product which is recommended for the deal.
referenceDetails	Displays the details of the reference deal using which the deal is created for the entity (i.e. existing person, account, or prospect person) in the system.
referenceTypeFlg	Indicates the type of the reference deal using which the deal is created for the entity (i.e. existing person, account, or prospect person) in the system. The valid values are: <ul style="list-style-type: none"> • RPER - Indicates that the deal is created by using the deal of an existing person as a reference. • RACC - Indicates that the deal is created by using the deal of an existing account as a reference. • RDEL - Indicates that the deal is created by using an existing deal as a reference.
refPersonIdentifierType	Displays the identifier type of the person using which the reference deal is created in the system.

Attribute Name	Attribute Description
	<p>Note: The value in this attribute appears only when the value of the referenceTypeFlg attribute is RPER.</p>
refPersonIdentifier	<p>Displays the value of the reference person identifier type.</p> <p>Note: The value in this attribute appears only when the value of the referenceTypeFlg attribute is RPER.</p>
referPersonId	<p>Displays the person for whom the reference deal is created.</p> <p>Note: The value in this attribute appears only when the value of the referenceTypeFlg attribute is RPER.</p>
refAccountIdentifierType	<p>Displays the identifier type of the account using which the reference deal is created in the system.</p> <p>Note: The value in this attribute appears only when the value of the referenceTypeFlg attribute is RACC.</p>
refAccountIdentifier	<p>Displays the value of the reference account identifier type.</p> <p>Note: The value in this attribute appears only when the value of the referenceTypeFlg attribute is RACC.</p>
referAccountId	<p>Display the account for which the reference deal is created.</p> <p>Note: The value in this attribute appears only when the value of the referenceTypeFlg attribute is RACC.</p>
referDealIdentifier	<p>Displays the primary identifier using which the reference deal is created in the system.</p> <p>Note: The value in this attribute appears only when the value of the referenceTypeFlg attribute is RDEL.</p>
referenceDealId	<p>Displays the existing deal which is used as a reference to create the deal.</p> <p>Note: The value in this attribute appears only when the value of the referenceTypeFlg attribute is RDEL.</p>
referenceModelId	<p>Displays the existing deal version which is used as a reference to create the deal.</p> <p>Note: The value in this attribute appears only when the value of the referenceTypeFlg attribute is RDEL.</p>
referUsageSw	<p>Indicates whether the commitments from the SQI-based billable charges of the reference deal is copied to create the deal for the entity (i.e. existing person, account, or prospect person). The valid values are:</p> <ul style="list-style-type: none"> • true • false

Attribute Name	Attribute Description
referPriceSw	Indicates whether the price list assignments and price assignments of the reference deal is copied to create the deal for the entity (i.e. existing person, account, or prospect person). The valid values are: <ul style="list-style-type: none"> • true • false
includeChildHierarchyFlag	Indicates whether the child persons, grandchild persons, and their accounts of the reference deal is included while creating the deal for the entity (i.e. existing person, account, or prospect person).. The valid values are: <ul style="list-style-type: none"> • true • false
division	Indicates the division to which the reference person belongs.
dealComments	Displays information about the actions performed on the deal.
sequenceNo	Displays the sequence number in which the action is performed on the deal.
commentsDateTime	Displays the date and time when the action is performed on the deal.
user	Displays the user who has performed the action on the deal.
dealComments	Displays the details about the action performed on the deal.
reasonCode	Displays the reason why the action is performed on the deal.
modelcomments	Displays information about the actions performed on the deal version of the deal.
sequenceNo	Displays the sequence number in which the action is performed on the deal version of the deal.
commentsDateTime	Displays the date and time when the action is performed on the deal version of the deal.
user	Displays the user who has performed the action on the deal version of the deal.
modelComments	Displays the details about the action performed on the deal version of the deal.
adhocRevenueCostDetails	Displays information about the adhoc revenue and cost of the deal.
sequence	Displays the sequence number of the adhoc revenue or cost of the deal.
revenueCostGroupFlag	Indicates the group to which the adhoc charge belongs. The valid values are: <ul style="list-style-type: none"> • ADRE - Indicates the charges incurred as the adhoc revenue for the deal. • CUCO - Indicates the charges of the courier services for the deal. • DCOM - Indicates the charges that incurred during deal commissioning. • PRIL - Indicates the price item specific charges for the deal. • TRCO - Indicates the travel cost.
division	Indicates the division for which the adhoc charge is applicable.
currency	Indicates the currency in which the adhoc charge is specified for the deal.
amount	Displays the amount for the adhoc revenue or cost. Note: You can even view the negative value in this attribute.

Attribute Name	Attribute Description
priceItem	Indicates the particular price item for which the adhoc charge is added.
dealSimulationDetails	Displays the deal level, division level, and product level simulation details of the deal.
dealFinancialSummaryDetails	Displays information about the financial summary at the deal level.
approvalStatus	Indicates the current approval status of the financial summary at the deal level. <ul style="list-style-type: none"> • APPR • EROR • INIT • UNAP
originalDealFinancialSummary	Displays information about the financial summary at the deal level which is calculated using the original price list assignments and price assignments.
revenue	Displays the revenue generated at the deal level from the original price list assignments and price assignments.
cost	Displays the cost calculated at the deal level from the original price list assignments and price assignments.
profit	Displays the profit in deal currency generated from the original price list assignments and price assignments at the deal level.
profitabilityPercentage	Displays the profit generated in percentage (%) from the original price list assignments and price assignments at the deal level.
proposedDealFinancialSummary	Displays information about the financial summary at the deal level which is calculated using the proposed price list assignments and price assignments.
revenue	Displays the revenue generated at the deal level from the proposed price list assignments and price assignments.
cost	Displays the cost calculated at the deal level from the proposed price list assignments and price assignments.
profit	Displays the profit in deal currency generated from the proposed price list assignments and price assignments at the deal level.
profitabilityPercentage	Displays the profit generated in percentage (%) from the proposed price list assignments and price assignments at the deal level.
recommendedDealFinancialSummary	Displays information about the financial summary at the deal level which is calculated using the recommended price list assignments and price assignments.
revenue	Displays the revenue generated at the deal level from the recommended price list assignments and price assignments.
profit	Displays the profit in deal currency generated from the recommended price list assignments and price assignments at the deal level.
profitabilityPercentage	Displays the profit in deal currency generated from the recommended price list assignments and price assignments at the deal level.
profitVariationPercentage	Displays the difference in the original and the proposed profits at the deal level in percentage (%).
divisionFinancialSummaryDetails	Displays information about the financial summary at the division level.

Attribute Name	Attribute Description
division	Indicates the division for which the financial summary is displayed.
approvalStatus	Indicates the current approval status of the financial summary at the division level. <ul style="list-style-type: none"> • APPR • EROR • INIT • UNAP
originalDivisionFinancialSummary	Displays information about the financial summary at the division level which is calculated using the original price list assignments and price assignments.
revenue	Displays the revenue generated at the division level from the original price list assignments and price assignments.
cost	Displays the cost calculated at the division level from the original price list assignments and price assignments.
profit	Displays the profit in deal currency generated from the original price list assignments and price assignments at the division level.
profitabilityPercentage	Displays the profit generated in percentage (%) from the original price list assignments and price assignments at the division level.
proposedDivisionFinancialSummary	Displays information about the financial summary at the division level which is calculated using the proposed price list assignments and price assignments.
revenue	Displays the revenue generated at the division level from the proposed price list assignments and price assignments.
cost	Displays the cost calculated at the division level from the proposed price list assignments and price assignments.
profit	Displays the profit in deal currency generated from the proposed price list assignments and price assignments at the division level.
profitabilityPercentage	Displays the profit generated in percentage (%) from the proposed price list assignments and price assignments at the division level.
recommendedDealFinancialSummary	Displays information about the financial summary at the division level which is calculated using the recommended price list assignments and price assignments.
revenue	Displays the revenue generated at the division level from the recommended price list assignments and price assignments.
profit	Displays the profit in deal currency generated from the recommended price list assignments and price assignments at the division level.
profitabilityPercentage	Displays the profit in deal currency generated from the recommended price list assignments and price assignments at the division level.
profitVariationPercentage	Displays the profit generated in percentage (%) from the recommended price list assignments and price assignments at the division level.
productFinancialSummaryDetail	Displays information about the financial summary at the product level.
approvalStatus	Indicates the current approval status of the financial summary at the product level. <ul style="list-style-type: none"> • APPR • EROR

Attribute Name	Attribute Description
	<ul style="list-style-type: none"> INIT UNAP
product	Indicates the product for which the financial summary is displayed.
division	Indicates the division for which the product financial summary is displayed.
originalProductFinancialSummary	Displays information about the financial summary at the product level which is calculated using the original price list assignments and price assignments.
revenue	Displays the revenue generated at the product level from the original price list assignments and price assignments.
cost	Displays the cost calculated at the product level from the original price list assignments and price assignments.
profit	Displays the profit in deal currency generated from the original price list assignments and price assignments at the product level.
profitabilityPercentage	Displays the profit generated in percentage (%) from the original price list assignments and price assignments at the product level.
proposedProductDivisionFinancialSummary	Displays information about the financial summary at the product level which is calculated using the proposed price list assignments and price assignments for a particular division.
revenue	Displays the revenue generated at the product level from the proposed price list assignments and price assignments.
cost	Displays the cost calculated at the product level from the proposed price list assignments and price assignments.
profit	Displays the profit in deal currency generated from the proposed price list assignments and price assignments at the product level.
profitabilityPercentage	Displays the profit generated in percentage (%) from the proposed price list assignments and price assignments at the product level.
recommendedDealFinancialSummary	Displays information about the financial summary at the product level which is calculated using the recommended price list assignments and price assignments.
revenue	Displays the revenue generated at the product level from the recommended price list assignments and price assignments.
profit	Displays the profit in deal currency generated from the recommended price list assignments and price assignments at the product level.
profitabilityPercentage	Displays the profit in deal currency generated from the recommended price list assignments and price assignments at the product level.
profitVariationPercentage	Displays the profit generated in percentage (%) from the recommended price list assignments and price assignments at the product level.
hierarchySimulationDetails	Displays information about the financial summary at the entity level in the customer hierarchy.
hierarchyDetails	Displays the details of the hierarchy.
entityType	Displays the type of the entity for which the financial summary is displayed.
entityId	Displays the entity (i.e. person or account) in the customer hierarchy for which the financial summary is displayed.

Attribute Name	Attribute Description
entityIdentifierTyoe	Displays the identifier type using which the entity is created in the system.
entityIdentifierValue	Displays the value of the entity identifier type.
entityDivision	Indicates the division to which the entity belongs.
parentEntityId	Displays the parent person to whom the entity (i.e. person or account) belongs in the customer hierarchy.
parentEntityIdentifierType	Displays the identifier type using which the parent entity is created in the system.
parentEntityIdentifierValue	Displays the value of the parent entity identifier type.
parentEntityDivision	Indicates the division to which the parent entity belongs.
status	Indicates the current approval status of the price list assignments and price assignments for the respective entity (i.e. person or account) in the customer hierarchy.
revenueVariation	Displays the average revenue generated from the price assignment and commitments of the price items at the entity (i.e. person or account) level in the customer hierarchy.
proposedRevenue	Displays the revenue generated at the entity (i.e. person or account) level from the proposed price assignment and commitments of the price items.
proposedCost	Displays the cost calculated at the entity (i.e. person or account) level from the proposed price assignment and commitments of the price items.
originalRevenue	Displays the revenue generated at the entity (i.e. person or account) level from the original price assignment and commitments of the price items.
originalCost	Displays the cost calculated at the entity (i.e. person or account) level from the original price assignment and commitments of the price items.
dealPricingAndCommitment	Displays information about the price assignment and commitments of the entities (i.e. person or account) in the customer hierarchy of the deal.
pricingAndCommitmentsDetails	Displays the price assignment and commitment details of the entity (i.e. person or account) in the customer hierarchy of the deal.
entityId	Displays the entity (i.e. person or account) whose price assignment and commitment details you are viewing.
entityType	Indicates the type of the entity whose price assignment and commitment details you are viewing. The valid values are: <ul style="list-style-type: none"> • ACCT • PERS
entityIdentifierType	Indicates the identifier type using which the entity (i.e. person or account) is created in the system.
entityIdentifierValue	Indicates the value of the identifier type using which the entity (i.e. person or account) is created in the system.
entityDivision	Indicates the division to which the entity (i.e. person or account) belongs.
pricingDetails	Displays the price assignment details of the entity (i.e. person or account) in the customer hierarchy of the deal.
priceAsgnId	Displays the identification value of the price assignment for the entity (i.e. person or account) whose price assignment details you are viewing.

Attribute Name	Attribute Description
priceItemCode	Displays the price item whose price assignment details you are viewing.
priceItemDescription	Displays the description of the price item.
hierarchyDetails	Displays the root level and/or non-root level hierarchy entity to which the price item belongs.
cost	Displays the cost calculated at the price item level from the proposed price assignment and commitments of the price item.
revenue	Displays the revenue generated from the proposed price assignment and commitments of the price item.
averagePrice	Displays the average price of the price item as per the proposed price assignment and commitments of the price item.
variation	Displays the variation between the original and proposed revenue in percentage (%) generated from the price assignment and commitments of the price item.
pricingStatus	Indicates the current approval status of the price assignment of the price item.
priceCurrencyCode	Indicates the currency in which the price assignment is defined for the price item.
rateSchedule	Indicates the rate schedule using which the price assignment is defined for the price item.
startDate	Displays the date from when the price assignment of the price item is effective for the entity (i.e. person or account).
endDate	Displays the date till when the price assignment of the price item is effective for the entity (i.e. person or account).
isEligible	Indicates whether the eligibility criteria for the price assignment is defined or not. The valid values are: <ul style="list-style-type: none"> • FALSE • TRUE
assignmentLevel	Indicates the level at which the pricing is defined for the price item. The valid values are: <ul style="list-style-type: none"> • ACPI • CUP • PCPI
paTypeFlag	Indicates the type of price assignment. The valid values are: <ul style="list-style-type: none"> • POST • PPIN • PPPR • RGLR
printIfZero	Indicates whether zero pricing is displayed or not. The valid values are: <ul style="list-style-type: none"> • Y • N
priceAssignCharacteristics	Displays the list of characteristics defined for the price assignment.

Attribute Name	Attribute Description
characteristicType	Indicates the characteristic type.
effectiveDate	Displays the date from when the characteristic is effective for price assignment.
characteristicValue	Displays the value of the characteristic type.
parameterDetails	Displays the list of price item parameters which are used along with the price item for determining the price assignment.
parameterCode	Indicates the pricing parameter which is associated with the price item.
parameterValue	Indicates the predefined pricing parameter value which is used for the price assignment.
txnDailyRatingCrt	<p>Indicates how and when the transaction legs mapped to the price item are rated. The valid values are:</p> <ul style="list-style-type: none"> • DNRT • AGTR • RITA • RITX
ignoreSw	<p>Indicates whether transaction mapped to price item pricing are considered for billing or not. The valid values are:</p> <ul style="list-style-type: none"> • Y • N
aggregateSw	<p>Indicates whether aggregation is required while rating the transactions mapped to the price item pricing before billing. The valid values are:</p> <ul style="list-style-type: none"> • Y • N
scheduleCode	<p>Indicates the transaction aggregation cycle. The valid values are:</p> <ul style="list-style-type: none"> • DAILY • WEEKLY • MONTHLY • QUARTERLY • YEARLY
priceCompDetails	Displays the price component details of the rate component defined for the price item price assignment.
priceCompId	Displays the identification value of the price component.
priceCompDesc	Displays the description for the price component.
valueAmt	Displays the rate of the price component.
displaySw	<p>Indicates whether the price component is displayed in the bill or not. The valid values are:</p> <ul style="list-style-type: none"> • TRUE • FALSE

Attribute Name	Attribute Description
rcMapId	Displays the identification value of the rate component for the price component.
tieredFlag	Displays the tiering type used for the price component. The valid values are: <ul style="list-style-type: none"> • FLAT • STEP • THRESHOLD
priceCompSequenceNo	Displays the sequence number of the price component.
priceCompTier	Displays the tiering criteria of the price component.
tierSeqNum	Indicates the tiering sequence number.
priceCriteria	Indicates the tiering criterion which is used in the tiering range.
lowerLimit	Displays the lower limit of the pricing range.
upperLimit	Displays the upper limit of the pricing range.
priceCompParameterDetails	Displays the list of parameters based on which the price items total usage is considered for determining the rate. <p>Note: The value in this attribute appears only when the Multi Price Parameter option type of the Multi Parameter Based Pricing (C1_PPARM_FLG) feature configuration is set to True.</p>
parameterCode	Indicates the parameter which is associated with the tiering criteria.
parameterValue	Displays the value for the parameter which is associated with the tiering criteria.
priceCompElig	Displays the pricing eligibility criteria defined for the price component. <p>Note: The value in this attribute appears only when the isEligible attribute is set to TRUE and the eligibility criteria is defined for the price component.</p>
sequenceNumber	Displays the order in which the pricing eligibility criteria is executed in the rule.
lhsPriceParmCd	Displays the left hand side parameter which you want to use along with the price item for price determination.
operator	Indicates the relational operator used to define the relation between the parameter name and the parameter value. The valid values are: <ul style="list-style-type: none"> • < • <= • <> • = • > • >= • BETWEEN • IN • LIKE • NOT IN

Attribute Name	Attribute Description
rhsPriceParmTypeFlg	<p>Indicates whether the parameter (on the left hand side) is compared against another parameter (on the right hand side) or directly against a parameter value.</p> <ul style="list-style-type: none"> • PARAMETER - Indicates that the parameter (on the left hand side) is compared against another parameter (on the right hand side). • VALUE - Indicates that the parameter (on the left hand side) is compared against a parameter value.
rhsPriceParmCd	Displays the parameter against which you have compared the parameter (on the left hand side).
rhsPriceParmVal	Displays the parameter value against which you have compared the parameter (on the left hand side).
isTrueFlag	<p>Indicates what should happen when the condition is true (satisfied). The valid values are:</p> <ul style="list-style-type: none"> • COND - Indicates that the condition with the consecutive sequence number is executed. • RLFS - Indicates that the action specified in the Rule False Action field is executed. • RLTR - Indicates that the action specified in the Rule True Action field is executed.
isFalseFlag	<p>Indicates what should happen when the condition is false (not satisfied). The valid values are:</p> <ul style="list-style-type: none"> • COND - Indicates that the condition with the consecutive sequence number is executed. • RLFS - Indicates that the action specified in the Rule False Action field is executed. • RLTR - Indicates that the action specified in the Rule True Action field is executed.
isInsufficientFlag	<p>Used to indicate what should happen when the data is insufficient. The valid values are:</p> <ul style="list-style-type: none"> • COND - Indicates that the condition with the consecutive sequence number is executed. • RLFS - Indicates that the action specified in the Rule False Action field is executed. • RLTR - Indicates that the action specified in the Rule True Action field is executed.
commitmentDetails	Displays the price items commitment details for the entity (i.e. person or account).
priceItemCode	Displays the price item whose commitment details you are viewing.
priceItemDescription	Displays the description of the price item.
parameterDetails	Displays the list of parameters based on which the effective pricing is defined for the price item.
parameterCode	Displays the parameter based on which the effective pricing is defined for the price item.

Attribute Name	Attribute Description
parameterValue	Displays the value of the parameter.
SQIDetails	Displays the service quantity identifier details of the price item.
serviceQuantityIdentifier	Displays the service quantity identifier associated with the price item.
sqiValue	Displays the SQI value for the price item and parameter combination that is used for calculating the price item pricing.
sqiTypeFlg	Indicates the status of the service quantity identifier details for calculating the price item pricing.
termsAndConditionsDetails	Displays the list of terms and conditions associated with the deal at the price item level.
priceItemCode	Displays the price item to which the terms and conditions are associated.
priceItemDescription	Displays the description of the price item.
priceItemGroupCode	Displays the root level and/or non-root level hierarchy entity to which the price item belongs.
priceItemGroupCodeDescription	Displays the description of the root level and/or non-root level hierarchy entity to which the price item belongs.
parameterDetails	Displays the list of the parameters using which the price item pricing is defined in the system.
parameterCode	Indicates the parameter which is associated with the price item.
parameterValue	Displays the value of the parameter which is associated with the price item.
termsAndConditionsList	Displays information about the terms and conditions associated with the price item.
termsAndCondition	Indicates the term and condition which is associated with the price item.
description	Displays the description of the term and condition.
termsAndConditionText	Displays additional information of the term and condition.
entitycharacteristics	Displays the list of the characteristics defined for the entities (i.e. person or account) in the deal.
entityId	Displays the identification value of the entity (i.e. person or account) for which the characteristic is defined.
entityType	Indicates the type of the entity. The valid values are: <ul style="list-style-type: none"> • ACCT • PERS
entityIdentifierType	Indicates the identifier type using which the entity (i.e. person or account) is created in the system.
entityIdentifierValue	Displays the value of the identifier type using which the entity (i.e. person or account) is created in the system.
entityDivision	Indicates the division to which the entity (i.e. person or account) belongs.
entityCharacteristicsList	Displays information about the characteristic defined for the entity (i.e. person or account).
effectiveDate	Displays the date from when the characteristic is effective for the entity (i.e. person or account).

Attribute Name	Attribute Description
characteristicType	Indicates the characteristic type.
characteristicValue	Displays the value of the characteristic type.

Related Topics

For more information on...	See...
Sample deal extraction request and response in the JSON format	Sample Deal Extraction Request and Response in the JSON Format on page 4225

Sample Deal Extraction Request and Response in the JSON Format

Using the below example, you can extract the deal details of 4235832132 deal ID.

Sample Deal Extraction Request in the JSON Format

```
{
  "C1-DealExtractionWebService":
  {
    "dealDetails":
    {
      "dealId" : "4235832132",
    }
  }
}
```

Sample Deal Extraction Response in the JSON Format

```
{
  "C1-DealExtractionWebService":
  {
    "dealDetails":
    {
      "dealEntityDetails":
      {
        "personIdentifierType" : "COREG"
        "personIdentifier" : "Reg_SRP230520220852"
        "personId" : "2003447796"
        "division" : "IND"
      }
      "dealIdentifier" : "Deal_Reg_SRP230520220852_v1",

      "dealInformation" : "4235832132,SRP230520220852,IND,05-23-2022,United States
                          Dollars,Contracted
(1),Deal_Reg_SRP230520220852_v1 ,Deal_Reg_SRP190520220205_v1 desc,INDIA
DIVISION,Tier, ,Business banking,Deal type code for Deal
Approval,Fully Orchestrated,Customer,System Default,Template-Yes,RMBK1
,05-23-2022, ,05-23-2023,Yearly,Yearly,05-23-2022,05-23-2022, ,Skip Reference-
Yes,Account,2003447796,Yearly,05-23-2022, ,05-23-2022,04-23-2023,Skip
Questionnaire-Yes, ,Include Hierarchy-Yes",
      "dealId" : "4235832132",
      "modelId" : "9284270861",
      "dealEntityType" : "EPER",
      "customerSegment" : "COMM",
      "customerTier" : "T",
      "division" : "IND",
      "accessGrp" : "****",
      "dealEntityId" : "2003447796",
      "contractedDealFlag" : "false",
      "currency" : "USD",
      "dealTypeCode" : "DLAPR",
    }
  }
}
```

```

    "startDate" : "2022-05-23",
    "simulationTypeFlag" : "CUST",
    "reviewFrequency" : "12",
    "dealDescription" : "Deal_Reg_SRP190520220205_v1 desc",
    "dealVersionDescription" : "Deal_Reg_SRP190520220205_v1 ver",
    "dealFrequency" : "12",
    "skipReferenceFlag" : "true",
    "priceSelectionDate" : "2022-05-23",
    "usagePeriod" : "12",
    "includeHierarchyFlag" : "true",
    "status" : "FORC",
    "dealVersionStatus" : "FNAL",
    "templateFlag" : "true",
    "createdDate" : "2022-05-23",
    "acceptanceDate" : "2022-05-23",
    "finalizedDate" : "2022-05-23",
    "effectiveStartDate" : "2022-05-23",
    "reviewedDate" : "2023-05-23",
  }
  "templateReferenceDetails" :
  {
    "copyBasicDetailsFlag" : "false",
    "copyPricingFlag" : "false",
    "copyUsageFlag" : "false",
  }
  "dealCharacteristics" :
  {
    {
      "effectiveDate" : "2021-01-01",
      "characteristicType" : "PROA",
      "characteristicValue" : "N",
    }
    {
      "effectiveDate" : "2021-01-01",
      "characteristicType" : "PROS1",
      "characteristicValue" : "N",
    }
  }
  "dealTermsAndConditionsDetails" :
  {
    "termsAndConditionsList" :
    {
      "termsAndCondition" : "DEAL_T&C1",
      "description" : "DEAL_T&C1",
      "termsAndConditionText" : "DEAL_T&C1",
    }
    "termsAndConditionsList" :
    {
      "termsAndCondition" : "DEAL_T&C2",
      "description" : "DEAL_T&C2",
      "termsAndConditionText" : "DEAL_T&C2",
    }
  }
  "referenceDetails" :
  {
    "referUsageSw" : "false",
    "referPriceSw" : "false",
    "includeChildHierarchyFlag" : "false",
  }
  "dealComments" :
  {
    {
      "sequenceNo" : "2",
      "commentsDateTime" : "2022-05-23T12:12:31+10:00",
    }
  }

```

```

    "user" : "RMBK1",
    "dealComments" : "deal accepted 6364316717",
  }
  {
    "sequenceNo" : "1",
    "commentsDateTime" : "2022-05-23T11:42:29+10:00",
    "user" : "PMBK1",
    "dealComments" : "to test weighted commitment",
    "reasonCode" : "RETURN",
  }
}
"dealSimulationDetails" :
{
"dealFinancialSummaryDetails" :
{
  "approvalStatus" : "",
  "originalDealFinancialSummary" :
  {
    "revenue" : "$3,600.00",
    "cost" : "$460.00",
    "profit" : "$3,140.00",
    "profitabilityPercentage" : "87.22",
  }
  "proposedDealFinancialSummary" :
  {
    "revenue" : "$38,862.50",
    "cost" : "$1,692.00",
    "profit" : "$37,170.50",
    "profitabilityPercentage" : "95.65",
  }
}
}
}
"hierarchySimulationDetails" :
{
  "hierarchyDetails" :
  {
    "entityType" : "PERS",
    "entityId" : "2003447796",
    "entityIdentifierTyoe" : "COREG",
    "entityIdentifierValue" : "Reg_SRP230520220852",
    "entityDivision" : "IND",
    "status" : "Approved",
    "revenueVariation" : "979.51",
    "proposedRevenue" : "$38,862.50",
    "proposedCost" : "$1,692.00",
    "originalRevenue" : "$3,600.00",
    "originalCost" : "$460.00",
  }
  "hierarchyDetails" :
  {
    "entityType" : "ACCT",
    "entityId" : "2087243494",
    "entityIdentifierTyoe" : "C1_F_ANO",
    "entityIdentifierValue" : "EAI_SRP230520220852",
    "entityDivision" : "IND",
    "parentEntityId" : "2003447796",
    "parentEntityIdentifierType" : "COREG",
    "parentEntityIdentifierValue" : "Reg_SRP230520220852",
    "parentEntityDivision" : "IND",
    "status" : "Approved",
    "revenueVariation" : "208.09",
    "proposedRevenue" : "$11,091.14",
    "proposedCost" : "$744.76",
    "originalRevenue" : "$3,600.00",
  }
}
}
}

```

```

        "originalCost" : "$460.00",
    }
    "hierarchyDetails" :
    {
        "entityType" : "ACCT",
        "entityId" : "2087243494",
        "entityIdentifierTyoe" : "Cl_F_ANO",
        "entityIdentifierValue" : "EAI_SRP230520220852",
        "entityDivision" : "IND",
        "parentEntityId" : "2003447796",
        "parentEntityIdentifierType" : "COREG",
        "parentEntityIdentifierValue" : "Reg_SRP230520220852",
        "parentEntityDivision" : "IND",
        "status" : "Approved",
        "revenueVariation" : "208.09",
        "proposedRevenue" : "$11,091.14",
        "proposedCost" : "$744.76",
        "originalRevenue" : "$3,600.00",
        "originalCost" : "$460.00",
    }
}
"dealPricingAndCommitment" :
{
    "pricingAndCommitmentsDetails" :
    {
        "entityId" : "2070828708",
        "entityType" : "PERS",
        "entityIdentifierTyoe" : "COREG",
        "entityIdentifierValue" : "Reg_SRP230520220852_PRSPCH1",
        "entityDivision" : "IND",
        "pricingDetails" :
        {
            "priceAsgnId" : "3520032357",
            "priceItemCode" : "NPI_023",
            "priceItemDescription" : "Price Item NPI_023",
            "hierarchyDetails" : "CORPORATE BANKING, ACCOUNT SERVICES",
            "pricingStatus" : "ACTV",
            "priceCurrencyCode" : "USD",
            "rateSchedule" : "DM-RT01",
            "startDate" : "2021-01-01",
            "isEligible" : "false",
            "assignmentLevel" : "Parent Customer Price List",
            "paTypeFlag" : "RGLR",
            "printIfZero" : "Y",
            "txnDailyRatingCrt" : "DNRT",
            "ignoreSw" : "N",
            "aggregateSw" : "Y",
            "scheduleCode" : "MONTHLY",
            "priceCompDetails" :
            {
                "priceCompId" : "3529900005",
                "priceCompDesc" : "FLAT",
                "valueAmt" : "25.000000000000000000",
                "displaySw" : "true",
                "rcMapId" : "1705351562",
                "tieredFlag" : "FLAT",
                "priceCompSequenceNo" : "10",
            }
        }
    }
    "pricingDetails" :
    {
        "priceAsgnId" : "3520032356",
        "priceItemCode" : "NPI_022",
    }
}

```



```

"priceItemDescription" : "Price Item NPI_022",
"hierarchyDetails" : "CORPORATE BANKING, ACCOUNT SERVICES",
"pricingStatus" : "ACTV",
"priceCurrencyCode" : "USD",
"rateSchedule" : "DM-RT01",
"startDate" : "2021-01-01",
"isEligible" : "false",
"assignmentLevel" : "Parent Customer Price List",
"paTypeFlag" : "RGLR",
"printIfZero" : "Y",
"txnDailyRatingCrt" : "DNRT",
"ignoreSw" : "N",
"aggregateSw" : "Y",
"scheduleCode" : "MONTHLY",
"priceCompDetails" "
{
  "priceCompId" : "3529900005",
  "priceCompDesc" : "FLAT",
  "valueAmt" : "25.000000000000000000",
  "displaySw" : "true",
  "rcMapId" : "1705351562",
  "tieredFlag" : "FLAT",
  "priceCompSequenceNo" : "10",
}
}
"pricingDetails" :
{
  "priceAsgnId" : "3520032355",
  "priceItemCode" : "NPI_021",
  "priceItemDescription" : "Price Item NPI_021",
  "hierarchyDetails" : "CORPORATE BANKING, ACCOUNT SERVICES",
  "pricingStatus" : "ACTV",
  "priceCurrencyCode" : "USD",
  "rateSchedule" : "DM-RT01",
  "startDate" : "2021-01-01",
  "isEligible" : "false",
  "assignmentLevel" : "Parent Customer Price List",
  "paTypeFlag" : "RGLR",
  "printIfZero" : "Y",
  "txnDailyRatingCrt" : "DNRT",
  "ignoreSw" : "N",
  "aggregateSw" : "Y",
  "scheduleCode" : "MONTHLY",
  "priceCompDetails" "
  {
    "priceCompId" : "3529900009",
    "priceCompDesc" : "FLAT",
    "valueAmt" : "25.000000000000000000",
    "displaySw" : "true",
    "rcMapId" : "1705351562",
    "tieredFlag" : "FLAT",
    "priceCompSequenceNo" : "10",
  }
}
"commitmentDetails" :
{
  "priceItemCode" : "NPI_021",
  "priceItemDescription" : "Price Item NPI_021",
  "parameterDetails" :
  "SQIDetails" :
  {
    "serviceQuantityIdentifier" : "BK-NBR",
    "sqiValue" : "2.800000000000000000",
    "sqiTypeFlg" : "PRPD",
  }
}

```

```

    }
  }
  "commitmentDetails" :
  {
    "priceItemCode" : "NPI_022",
    "priceItemDescription" : "Price Item NPI_022",
    "parameterDetails" :
    "SQIDetails" :
    {
      "serviceQuantityIdentifier" : "BK-NBR",
      "sqiValue" : "2.000000000000000000",
      "sqiTypeFlg" : "PRPD",
    }
  }
  "commitmentDetails" :
  {
    "priceItemCode" : "NPI_023",
    "priceItemDescription" : "Price Item NPI_023",
    "parameterDetails" :
    "SQIDetails" :
    {
      "serviceQuantityIdentifier" : "BK-NBR",
      "sqiValue" : "2.000000000000000000",
      "sqiTypeFlg" : "PRPD",
    }
  }
  "termsAndConditionsDetails" :
  {
    "priceItemCode" : "PI_021",
    "priceItemDescription" : "V1-Account Opening Fee",
    "termsAndConditionsList" :
    {
      "termsAndCondition" : "DEAL_T&C3",
      "description" : "DEAL_T&C3",
      "termsAndConditionText" : "DEAL_T&C3",
    }
    {
      "termsAndCondition" : "DEAL_T&C4",
      "description" : "DEAL_T&C4",
      "termsAndConditionText" : "DEAL_T&C4",
    }
  }
  "priceItemGroupCode" : "ACCOUNT SERVICES",
  "priceItemGroupCodeDescription" : "Account Services",
  "termsAndConditionsList" :
  {
    "termsAndCondition" : "DEAL_T&C5",
    "description" : "DEAL_T&C5",
    "termsAndConditionText" : "DEAL_T&C5",
  }
  {
    "termsAndCondition" : "DEAL_T&C6",
    "description" : "DEAL_T&C6",
    "termsAndConditionText" : "DEAL_T&C6",
  }
  }
  "priceItemGroupCode" : "CORPORATE BANKING",
  "priceItemGroupCodeDescription" : "Corporate Banking",
  "termsAndConditionsList" :
  {
    "termsAndCondition" : "DEAL_T&C7",
    "description" : "DEAL_T&C7",
  }

```

```

        "termsAndConditionText" : "DEAL_T&C7",
      }
    }
    "termsAndCondition" : "DEAL_T&C8",
    "description" : "DEAL_T&C8",
    "termsAndConditionText" : "DEAL_T&C8",
  }
}
{
  "entityId" : "2003447796",
  "entityType" : "PERS",
  "entityIdentifierTyoe" : "COREG",
  "entityIdentifierValue" : "Reg_SRP230520220852",
  "entityDivision" : "IND",
  "pricingDetails" :
  {
    "priceAsgnId" : "3520032358",
    "priceItemCode" : "NPI_024",
    "priceItemDescription" : "Price Item NPI_024",
    "hierarchyDetails" : "CORPORATE BANKING, ACCOUNT SERVICES",
    "cost" : "$460.00",
    "revenue" : "$3,600.00",
    "averagePrice" : "$24.00",
    "pricingStatus" : "ACTV",
    "priceCurrencyCode" : "USD",
    "rateSchedule" : "DM-RT01",
    "startDate" : "2021-01-01",
    "isEligible" : "false",
    "assignmentLevel" : "Customer Price List",
    "paTypeFlag" : "RGLR",
    "printIfZero" : "Y",
    "txnDailyRatingCrt" : "DNRT",
    "ignoreSw" : "N",
    "aggregateSw" : "Y",
    "scheduleCode" : "MONTHLY",
    "priceCompDetails" :
    {
      "priceCompId" : "3529900007",
      "priceCompDesc" : "FLAT",
      "valueAmt" : "25.000000000000000000",
      "displaySw" : "true",
      "rcMapId" : "1705351562",
      "tieredFlag" : "FLAT",
      "priceCompSequenceNo" : "10",
    }
  }
  "commitmentDetails" :
  {
    "priceItemCode" : "NPI_024",
    "priceItemDescription" : "Price Item NPI_024",
    "parameterDetails" :
    "SQIDetails" :
    {
      "serviceQuantityIdentifier" : "BK-NBR",
      "sqiValue" : "175.000000000000000000",
      "sqiTypeFlg" : "PRPD",
    }
    {
      "serviceQuantityIdentifier" : "BK-NBR",
      "sqiValue" : "150.000000000000000000",
      "sqiTypeFlg" : "ACTV",
    }
  }
}

```

```

    "termsAndConditionsDetails" :
    {
      "priceItemCode" : "PI_024",
      "priceItemDescription" : "V1-Account Opening Fee",
      "termsAndConditionsList" :
      {
        "termsAndCondition" : "DEAL_T&C3",
        "description" : "DEAL_T&C3",
        "termsAndConditionText" : "DEAL_T&C3",
      }
      "termsAndCondition" : "DEAL_T&C4",
      "description" : "DEAL_T&C4",
      "termsAndConditionText" : "DEAL_T&C4",
    }
  }
  "priceItemGroupCode" : "ACCOUNT SERVICES",
  "priceItemGroupCodeDescription" : "Account Services",
  "termsAndConditionsList" :
  {
    "termsAndCondition" : "DEAL_T&C5",
    "description" : "DEAL_T&C5",
    "termsAndConditionText" : "DEAL_T&C5",
  }
  {
    "termsAndCondition" : "DEAL_T&C6",
    "description" : "DEAL_T&C6",
    "termsAndConditionText" : "DEAL_T&C6",
  }
}
{
  "priceItemGroupCode" : "CORPORATE BANKING",
  "priceItemGroupCodeDescription" : "Corporate Banking",
  "termsAndConditionsList" :
  {
    "termsAndCondition" : "DEAL_T&C7",
    "description" : "DEAL_T&C7",
    "termsAndConditionText" : "DEAL_T&C7",
  }
  {
    "termsAndCondition" : "DEAL_T&C8",
    "description" : "DEAL_T&C8",
    "termsAndConditionText" : "DEAL_T&C8",
  }
}
}
}
"entitycharacteristics>
{
  "entityId" : "NPI_021",
  "entityType" : "PRICEITEM",
  "entityCharacteristicsList" :
  {
    "effectiveDate" : "2015-01-01",
    "characteristicType" : "PPSEQ",
    "characteristicValue" : "10",
  }
}
{
  "entityId" : "NPI_022",
  "entityType" : "PRICEITEM",
  "entityCharacteristicsList" :
  {

```

```

        "effectiveDate" : "2015-01-01",
        "characteristicType" : "PPSEQ",
        "characteristicValue" : "10",
    }
}
{
    "entityId" : "NPI_022",
    "entityType" : "PRICEITEM",
    "entityIdentifierType" : "C1_F_ANO",
    "entityIdentifierValue" : "EAI_SRP230520220852",
    "entityDivision" : "IND",
    "entityCharacteristicsList" :
    {
        "effectiveDate" : "2021-05-05",
        "characteristicType" : "C1_F_ANO",
        "characteristicValue" : "1298312131",
    }
    "entityCharacteristicsList" :
    {
        "effectiveDate" : "2021-05-05",
        "characteristicType" : "C1_F_ATY",
        "characteristicValue" : "SAVINGS",
    }
    "entityCharacteristicsList" :
    {
        "effectiveDate" : "2021-03-03",
        "characteristicType" : "VG_STATE",
        "characteristicValue" : "MH",
    }
}
{
    "entityId" : "2003447796",
    "entityType" : "PERS",
    "entityIdentifierType" : "COREG",
    "entityIdentifierValue" : "Reg_SRP230520220852",
    "entityDivision" : "IND",
    "entityCharacteristicsList" :
    {
        "effectiveDate" : "2022-03-04",
        "characteristicType" : "C1-GENDR",
        "characteristicValue" : "MALE",
    }
    "entityCharacteristicsList" :
    {
        "effectiveDate" : "2022-03-04",
        "characteristicType" : "C1_BRDT",
        "characteristicValue" : "1994-03-20",
    }
    "entityCharacteristicsList" :
    {
        "effectiveDate" : "2022-03-04",
        "characteristicType" : "PERAGE",
        "characteristicValue" : "63",
    }
}
{
    "entityId" : "2070828708",
    "entityType" : "PERS",
    "entityIdentifierType" : "COREG",
    "entityIdentifierValue" : "Reg_SRP230520220852",
    "entityDivision" : "IND",
    "entityCharacteristicsList" :
    {
        "effectiveDate" : "2022-03-04",
    }
}

```

```

        "characteristicType" : "C1-GENDR",
        "characteristicValue" : "MALE",
    }
    "entityCharacteristicsList" :
    {
        "effectiveDate" : "2022-03-04",
        "characteristicType" : "C1_BRTDT",
        "characteristicValue" : "1994-03-20",
    }
    "entityCharacteristicsList" :
    {
        "effectiveDate" : "2022-03-04",
        "characteristicType" : "PERAGE",
        "characteristicValue" : "63",
    }
    }
}

```

Related Topics

For more information on...	See...
Deal extraction request and response attribute/value pairs in the JSON format	Deal Extraction Request and Response - Attribute/Value Pairs in the JSON Format on page 4208

Chapter 51

Chatbot

Oracle Revenue Management and Billing provides digital assistance to end-users using Oracle Digital Assistant (ODA). You can use the digital assistant, also known as detective Chatbot, to have conversational experiences with ORMB through text, chat, and voice interfaces.

We have introduced a Menu Based Chatbot in this release. As the name suggests, this Chatbot facilitates the user to choose from several options, presented in the form of menus and sub menus. At present, we have the following menu options in the Chatbot:

- **Customer Info** – It enables you to view the details of a customer. On clicking the **Customer Info** menu option, a sub menu appears with the following options:
 - **Customer ID** – Used when you want to view the details of a particular customer. The system then displays the details of the customer in the **Customer 360° Information** screen.
 - **Customer Name** – Used when you want to view the list of customers with a particular name. You can use the wildcard character (%) while specifying the customer name. If there is only one customer whose name matches the specified value, the system displays the details of the customer in the **Customer 360° Information** screen. However, if there are multiple customers whose name matches the specified value, the system displays the list of customers that meet the criteria in the **Customer 360° View** screen.
- **Account Info** - It enables you to view the details of an account. On clicking the **Account Info** menu option, a sub menu appears with the following options:
 - **Account ID** - Used when you want to view the details of a particular account. The system then displays the details of the account in the **Customer 360° Information** screen.
 - **Customer Name** - Used when you want to view the list of accounts where a particular customer is the main customer.

You can use the wildcard character (%) while specifying the customer name. If there is only one account of the customer, the system displays the details of the account in the **Account** screen.

However, if there are multiple accounts of the customer, the system displays the list of accounts that meet the criteria in the **Account Search** window.

- **Account Statement** – Used when you want to view the mini statement (last five transactions) of an account. The system displays the financial transaction details in the **Chatbot** window.
- **Bill Info** – It enables you to view the details of a bill and initiate the bill creation or cancellation process. On clicking the **Bill Info** menu option, a sub menu appears with the following options:
 - **Create Bill** – Used when you want to create a bill for an account. On entering the account ID, the **Bill** screen appears where you can generate a bill for the account.
 - **Latest Bill Details** – Used when you want to view the details of a bill. On clicking the **Latest Bill Details** menu option, a sub menu appears with the following options:
 - **Account ID** – Used when you want to view the latest bill details of a particular account.
 - **Alternate Bill ID** – Used when you want to view the details of a particular bill.
 - **Bill ID** – Used when you want to view the details of a particular bill.
 - **Cancel Bill** – Used when you want to cancel a bill of an account. On entering the bill ID, the **Bill** screen appears where you can cancel the bill of the account.
- **Pricing Info** – It enables you to view the effective or agreed pricing of a customer or an account. It also enables you to view the details of a price list. On clicking the **Pricing Info** menu option, a sub menu appears with the following options:
 - **Customer ID** – Used when you want to view the price assignments of a customer. On entering the customer ID, a sub menu appears with the following options:
 - **Effective Pricing** – Used when you want to view all effective price assignments of the customer.
 - **Agreed Pricing** – Used when you want to view all agreed price assignments of the customer.

The system displays the effective or agreed price assignments of the customer in the **Pricing (Person)** screen.
 - **Account ID** – Used when you want to view the price assignments of an account. On entering the account ID, a sub menu appears with the following options:
 - **Effective Pricing** – Used when you want to view all effective price assignments of the account.
 - **Agreed Pricing** – Used when you want to view all agreed price assignments of the account.

The system displays the effective or agreed price assignments of the account in the **Pricing (Account)** screen.
- **Price List** - Used when you want to view the details of a price list. On entering the price list description, the system displays the details of the price list in the **Price List** screen.

- **Others** - It enables you to view the details of a batch job or DBMS scheduler job. On clicking the **Others** menu option, a sub menu appears with the following options:
 - **Batch Job Status** – Used when you want to view the status of last five batch jobs of a particular batch control. The system displays the batch job details in the **Chatbot** window.
 - **DBMS Job Status** – Used when you want to view the status of a particular DBMS scheduler job. The system displays the scheduler job details in the **Chatbot** window.

To implement and use the **Chatbot** feature, you need to additionally procure the license for Oracle Digital Assistant (ODA). To integrate ODA with ORMB, you need to make some configurations in ODA and ORMB. For more information about configuration, refer the *Oracle Revenue Management and Billing Chatbot Configuration Guide*. And, for more information about how to use the **Chatbot** feature, refer to the *Oracle Revenue Management and Billing Chatbot User Guide*.

Chapter

52

Billing Anomaly Detection with Artificial Intelligence (AI) and Machine Learning (ML)

Topics:

- [Lifecycle of a ML Job](#)
- [Prerequisites](#)
- [ML Jobs](#)
- [Diagnostic Central](#)

Until now, the system enabled you to detect anomalies in the bills before bill completion using the **Bill Tolerance** feature. Now, in addition, Oracle Revenue Management and Billing enables you to use artificial intelligence and machine learning to detect anomalies in the bills and bill segments before the bill completion. The different steps involved in the machine learning process are:

- Data Preparation
- Model Generation
- Data Prediction

These three steps are referred as ML jobs in the system. An ML Job goes through various statuses in its lifecycle. We have shipped the following three batches to execute the above three steps:

- **C1-MLDPR** – This batch is used to extract the historical bills and their bill segments which are later used to create a machine learning training model. It transforms the historical bills and their bill segments into materialized views.

You can specify the extraction date range to fetch the bills and bill segments which are created within that date range. We recommend you to extract the historical data of at least last three years. This batch provides an option to extract the data incrementally. If you want to extract the data incrementally, then you need to set the **Incremental Data** parameter to **Y** and specify the extraction from date and cutoff days. This option should be used when you want to extract historical data from a particular date till the cutoff date (i.e. system date – cutoff days).

Ideally, you should use this option when you want to use a static from date and a dynamic end date each time the batch is executed. However, if you do not want to extract the data incrementally, then you need to set the **Incremental Data** parameter to **N** and specify the extraction date range (i.e. from and to dates). You can extract the historical bills and their bill segments either separately or together. However, if you have voluminous data, we recommend you to extract the historical bills in the first batch run and then extract the historical bill segments in the next batch run.

This batch also enables you to filter the dataset based on the bill cycle and division. It is a single-threaded batch. Ideally, you must execute this batch every three months to refresh the dataset of the machine learning training model.

- **C1-MLMCR** – This batch is used to create a machine learning training model using the historical data extracted through the **C1-MLDPR** batch.

A machine learning training model is a process in which a machine learning (ML) algorithm is fed with sufficient training data to learn and analyze using the dataset. It enables you to process large volumes of data to detect anomalies and test correlations while searching for patterns across the dataset. At present, you can build a model using the following approach:

- **BULTIN** – Used when you want to build a model far ahead in time before the anomaly detection.

Once a machine learning training model is created, it is stored in the database as a database object. This batch is a single-threaded batch. Ideally, you must execute this batch every three months to create a new machine learning training model with the latest dataset.

- **C1-MLPRE** – This batch is used to detect anomalies in the current bills and their bills segments based on the patterns observed in the machine learning training model. At a time, you can either detect anomalies in the bills or their bill segments in a single batch run. You must execute this batch after generating bill segments and bills through the billing batches.

While using AI ML for anomaly detection, you should not enable the **Freeze and Complete** option for the bill cycle. This is because you will then have the option to make the required corrections based on anomaly detection before freezing and completing the bills and their bill segments. A To Do notification is created to summarize anomaly detection for a given batch code, batch number and batch rerun number.

While executing the **C1-MLPRE** batch, you need to specify the bill segment generation or bill completion batch control and its batch run number whose bills or bill segments you want to consider for anomaly detection. You can either specify the batch run number or set the incremental run flag to **true** during the **C1-MLPRE** batch execution. This batch is a multi-threaded batch.

At present, the following data mismatch is considered as anomalies by the machine learning process:

- Data mismatch in the bill segments (i.e. SQI or amount mismatch)
- Data mismatch in the bills (i.e. an additional price item is charged in the current bill, a price item (which is billed earlier) is not charged in the current bill, and bill amount mismatch)

To implement this AI ML feature, the following two screens are introduced in this release:

- **ML Jobs** – Enables you to track the status of different ML jobs.
- **Diagnostics Central** – Enables you to view and close the detected anomalies in the bills and bill segments. After reviewing the anomaly, you can either take any one of the following action:
 - Fix the anomaly in the bill or bill segment and then close the anomaly. In this case, while closing the anomaly, you must set the **Anomaly** field to **Yes** to indicate that it is an anomaly.
 - Ignore the anomaly in the bill or bill segment and then close the anomaly. In this case, while closing the anomaly, you must set the **Anomaly** field to **No** to indicate that it is not an anomaly.

Lifecycle of a ML Job

The following figure graphically indicates how a ML Job moves from one status to another in its lifecycle:

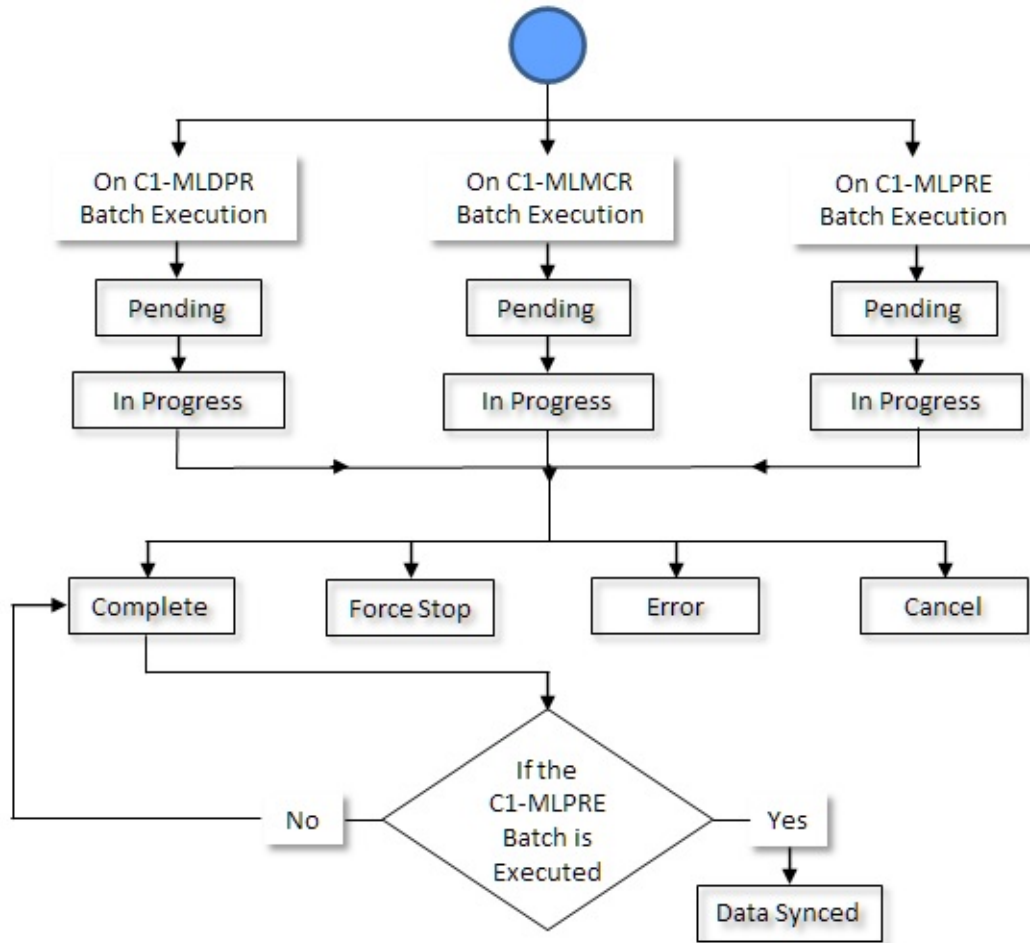

Prerequisites

To setup the billing anomaly detection with artificial intelligence (AI) and machine learning (ML) feature, you need to do the following:

- Create an algorithm using the **C1-ANMLYCHCK** algorithm type and attach it to the **Pre Bill Completion** algorithm spot of the customer class.
- Set the values for following option types in the **C1-PREBSEG** feature configuration:
 - **ML Invocation Logic Enabled**

Related Topics

For more information on...	See...
How to setup the C1-PREBSEG feature configuration	Setting the C1-PREBSEG Feature Configuration on page 4250

ML Jobs

The **ML Jobs** screen allows you to search and track the status of different ML jobs. It contains the following zone:

- [Search ML Job](#) on page 4242

Search ML Job

The **Search ML Job** zone allows you to search for various ML jobs using various search criteria. It contains the following section:

- **Search Criteria** - The Search Criteria section contains the following fields:

Field Name	Field Description	Mandatory (Yes or No)
Created From	Used to search ML jobs which are executed from a particular date onwards.	Yes
Created Until	Used to search ML jobs which are executed till a particular date.	Yes
ML Job Type	Used to search ML jobs which are classified based on the job type. The valid values are: <ul style="list-style-type: none"> • Data Model Creation • Data Prediction • Data Preparation 	No
ML Entity Type	Used to search ML jobs which are created for the specific entity type. The valid values are: <ul style="list-style-type: none"> • All • Bill • Bill Segment 	No
ML Job Status	Used to search ML jobs in a particular status. The valid values are: <ul style="list-style-type: none"> • Canceled • Completed • Data Synchronized • Error • Force Stopped • In Progress • Pending 	No

- **Search Results** - On clicking the **Search** button, the search results appear based on the specified search criteria. The **Search Results** section contains the following columns:

Column Name	Column Description
ML Job Type	Indicates the type using which the ML job is created.
ML Entity Type	Indicates the type of entity using which the ML job is created.
Batch Job Details	Displays the batch job details such as batch description, batch number, and batch rerun number.
Parent Batch Job Details	Displays the parent batch job details such as batch description, batch number, and batch rerun number.
	Note: The data in this column appears only in case of data prediction batches.
ML Job Status	Indicates the status of the ML job.
Creation Date Time	Displays the date and time when the ML job is created.
Job Start Date Time	Displays the date and time when the ML job is started.
Job End Date Time	Displays the date and time when the ML job is ended.

Related Topics

For more information on...	See...
How to search for an ML job	Searching for an ML Job on page 4243

Searching for an ML Job

Procedure

To search for an ML job:

1. Click the **Menu** link in the **Application** toolbar.
A list appears.
2. From the **Main** menu, select **Tools** and then click **ML Jobs**.
The **ML Jobs** screen appears.
3. Enter the search criteria in the **Search ML Jobs** zone.

Note: ORMB search engine supports wildcard search, where you can substitute the percentage (%) symbol as a stand in for any word or letter in a search criteria. You can use the ‘%’ wildcard character in all input fields except the date and ID fields. The ‘%’ wildcard character is suffixed automatically at the end of the partial search criteria. Therefore, you may or may not specify the wildcard character at the end of the partial search criteria. However, you have to prefix the wildcard character manually wherever required.

4. Click **Search**.

A list of ML jobs that meet the search criteria appears in the **Search Results** section.

Related Topics

For more information on...	See...
ML Jobs screen	ML Jobs on page 4242
Search ML Jobs zone	Search ML Job on page 4242

Diagnostic Central

The **Diagnostic Central** screen allows you to search for anomalies in the bills and bill segments. It contains the following zones:

- [Search Anomaly](#) on page 4244
- [Bill Segment Anomalies](#) on page 4247

Search Anomaly

The **Search Anomaly** zone allows you to search for anomalies using various search criteria. It contains the following two sections:

- **Search Criteria** - The **Search Criteria** section contains the following fields:

Field Name	Field Description	Mandatory (Yes or No)
Search By	Used to indicate whether you want to search for an account or bill level anomaly, or bill segment anomaly. The valid values are: <ul style="list-style-type: none"> • Account/Bill Level Anomaly • Bill Segment Level Anomaly 	Yes
	Note: By default, the Account/Bill Level Anomaly option is selected.	
Division	Used to search anomalies which includes bills or bill segments of accounts which belong to a particular division.	No
Anomaly Status	Used to search anomalies with a particular status. The valid values are: <ul style="list-style-type: none"> • Canceled • Closed • Ignored • Open 	No
Account Identifier Type	Used to indicate the account identifier type based on which you want to search for anomalies.	Yes (Conditional)
		Note: If you specify the account identifier as a search criteria, you have to select the account identifier type.
Account Identifier	Used to search the anomalies with a particular identifier.	Yes (Conditional)
		Note: If you specify the account identifier type as a search criteria, you have to enter the account identifier.

Field Name	Field Description	Mandatory (Yes or No)
Account ID	<p>User to search anomalies for a particular account.</p> <p>The Search (🔍) icon appears corresponding to the Account ID field. On clicking the Search icon, the Account Search window appears.</p> <p>On specifying the value for a predefined account, the description of the account appears corresponding to the Account ID field.</p>	No
Trail Bill	<p>Used to search anomalies based on whether the bill is a trial bill. The valid values are:</p> <ul style="list-style-type: none"> • Yes • No 	No
Bill Created From	Used to search anomalies which include accounts or bills, or bill segments which are created from a particular date onwards.	Yes
Bill Created Until	Used to search anomalies which include accounts or bills, or bill segments which are created till a particular date.	Yes
Bill Cycle	Used to search anomalies with a particular bill cycle.	No
Bill ID	<p>Used to search anomalies for a particular bill.</p> <p>The Search (🔍) icon appears corresponding to the Bill ID field. On clicking the Search icon, the Bill Search window appears.</p> <p>On specifying the value for a predefined bill, the description of the account appears corresponding to the Account ID field.</p>	No
Anomaly Category	<p>Used to search anomalies with a particular category. The valid values are:</p> <ul style="list-style-type: none"> • Bill Level Anomaly • Bill Segment Level Anomaly 	No
Anomaly Reason	<p>Used to search anomalies with a particular reason.</p> <p>Note: The list appears when the anomaly category is selected.</p>	No

Note:

You must specify at least one search criterion while searching for an account. One more search criterion is required when you are searching for an account using the division and/or customer class. Similarly, one more search criterion is required when you are searching for an account (associated with the policies) using the policy type and/or source system.

ORMB search engine supports wildcard search, where you can substitute the percentage (%) symbol as a stand in for any word or letter in a search criteria. You can use the '%' wildcard character in all input fields except the date and ID fields. The '%' wildcard character is suffixed automatically at the end of the partial search criteria. Therefore, you may or may not specify the wildcard character at the end of the partial search criteria. However, you have to prefix the wildcard character manually wherever required.

- **Search Results** - On clicking the **Search** button, the search results appear based on the specified search criteria. The **Search Results** section contains the following columns:

Column Name	Column Description
Account Information	Displays the account level information for which the anomaly is detected. In addition, this column has a context menu which helps in navigating to other screens in the application. Note: It has a link. On clicking the link, the Account screen appears where you can view the details of the respective account.
Bill Information	Displays the bill level information for which the anomaly is detected. In addition, this column has a context menu which helps in navigating to other screens in the application. Note: It has a link. On clicking the link, the Bill screen appears where you can view the details of the respective bill.
Bill Date	Displays the date when the bill was generated.
Anomaly Status	Indicates the status of the anomaly. The valid values are: <ul style="list-style-type: none"> • Canceled • Closed • Ignored • Open
Anomaly Reason	Displays the reason that caused the anomaly.
To Do Information	Displays the To Do that got generated when an anomaly was detected. Note: It has a link. On clicking the link, the To Do Entry screen appears where you can view the details of the respective To Do.

In addition, this section contains the following button:

Button Name	Button Description
Close	Used to close a bill level or bill segment level anomaly.

A check box appears corresponding to each account. On selecting the check box, you can close the selected anomaly. You can also select multiple anomalies at the same time. In addition, you can select the check box corresponding to the column header. This allows you to close all the anomalies listed in the respective page.

Note:

Pagination is used to display limited number of records in the **Search Results** section. You can use the navigation links, such as **Previous** and **Next** to navigate between pages.

On clicking the **Broadcast** (📢) icon corresponding to the account information column the **Bill Segment Anomaly** zone appears with the anomalies detected at bill segment level.

You can filter the list using the various search criterias available in the **Filter** area. By default, the **Filter** area is hidden. You can view the **Filter** area by clicking the **Filters** (🔍) icon in the upper right corner of this zone.

Related Topics

For more information on...	See...
How to search for a bill level anomaly	Searching for a Bill Level Anomaly on page 4248
Bill Segment Anomalies zone	Bill Segment Anomalies on page 4247
How to view the details of a bill level anomaly	Viewing the Bill Segment Anomaly Details on page 4248
How to close an anomaly	Closing an Anomaly on page 4249

Bill Segment Anomalies

The **Bill Segment Anomalies** zone displays the bill segment level anomaly details. It contains the following columns:

Column Name	Column Description
Account Information	Displays the account level information for which the anomaly is detected. In addition, this column has a context menu which helps in navigating to other screens in the application. Note: It has a link. On clicking the link, the Account screen appears where you can view the details of the respective account.
Bill Segment ID	Displays the bill segment ID for which the anomaly is detected.
Bill ID	Displays the bill ID of the bill segment.
Bill Date	Displays the date on which the bill was generated.
Anomaly Status	Indicates the status of the anomaly. The valid values are: <ul style="list-style-type: none"> • Cancel • Closed • Ignore • Open

By default, the **Bill Segment Anomalies** zone does not appear in the **Diagnostic Central** screen. It appears when you click the **Broadcast** (📢) icon corresponding to the account information column in the **Search Anomaly** zone.

Related Topics

For more information on...	See...
How to view the details of a bill level anomaly	Viewing the Bill Segment Anomaly Details on page 4248

Searching for a Bill Level Anomaly**Procedure**

To search for a bill level anomaly:

1. Click the **Menu** link in the **Application** toolbar.
A list appears.
2. From the **Main** menu, click **Diagnostic Central**.
The **Diagnostic Central** screen appears.
3. Enter the search criteria in the **Search Anomaly** zone.

Note: ORMB search engine supports wildcard search, where you can substitute the percentage (%) symbol as a stand in for any word or letter in a search criteria. You can use the ‘%’ wildcard character in all input fields except the date and ID fields. The ‘%’ wildcard character is suffixed automatically at the end of the partial search criteria. Therefore, you may or may not specify the wildcard character at the end of the partial search criteria. However, you have to prefix the wildcard character manually wherever required.

4. Click **Search**.

A list of anomalies that meet the search criteria appears in the **Search Results** section.

Related Topics

For more information on...	See...
Diagnostic Central screen	Diagnostic Central on page 4244
Search Anomaly zone	Search Anomaly on page 4244

Viewing the Bill Segment Anomaly Details**Procedure**

To view the bill segment anomaly details:

1. Search for the bill segment level anomaly in the **Diagnostic Central** screen.
2. In the **Search Results** section, click the **Broadcast** (📡) icon corresponding to the bill information whose bill segment anomaly details you want to view.
The **Bill Segment Anomaly** zone appears.
3. View the details of the bill segment anomaly in the **Bill Segment Anomaly** zone.

Related Topics

For more information on...	See...
How to search for a bill segment level anomaly	Searching for a Bill Segment Level Anomaly on page 4249
Diagnostic Central screen	Diagnostic Central on page 4244

For more information on...	See...
Search Anomaly zone	Search Anomaly on page 4244

Searching for a Bill Segment Level Anomaly

Procedure

To search for a bill segment level anomaly:

1. Click the **Menu** link in the **Application** toolbar.

A list appears.

2. From the **Main** menu, click **Diagnostic Central**.

The **Diagnostic Central** screen appears.

3. In the **Search Anomaly** zone, enter the search criteria by selecting **Bill Segment Level Anomaly** option in the **Search By** field.

Note: ORMB search engine supports wildcard search, where you can substitute the percentage (%) symbol as a stand in for any word or letter in a search criteria. You can use the ‘%’ wildcard character in all input fields except the date and ID fields. The ‘%’ wildcard character is suffixed automatically at the end of the partial search criteria. Therefore, you may or may not specify the wildcard character at the end of the partial search criteria. However, you have to prefix the wildcard character manually wherever required.

4. Click **Search**.

A list of bill segment level anomalies that meet the search criteria appears in the **Search Results** section.

Related Topics

For more information on...	See...
Diagnostic Central screen	Diagnostic Central on page 4244
Search Anomaly zone	Search Anomaly on page 4244

Closing an Anomaly

Procedure

To close an anomaly:

1. Search for the bill level or bill segment level anomaly in the **Diagnostic Central** screen.
2. In the **Search Results** section, select an anomaly and then click the **Close** button.

The **Close Anomaly** window appears. It contains the following fields:

Field Name	Field Description
Anomaly	Used to indicate whether the selected entry is an anomaly. The valid values are: <ul style="list-style-type: none"> • No • Yes
Comments	Used to specify additional details for closing the anomaly.

3. Select the appropriate option from the Anomaly field and enter the comments in the respective field.
4. Click **Save**.
5. The status of the anomaly is changed to **Closed**.

Note: If you close an anomaly the system does not automatically complete the respective To Do entry. You have to manually complete the To Do entry. On the other hand, if a To Do is completed before an anomaly is closed, the system changes the anomaly status to **Closed**.

Related Topics

For more information on...	See...
Diagnostic Central screen	Diagnostic Central on page 4244
Search Anomaly zone	Search Anomaly on page 4244

Setting the C1-PREBSEG Feature Configuration

The **C1-PREBSEG** feature configuration enables you to validate the bill segment before generating the bill.

Prerequisites

To set the **C1-PREBSEG** feature configuration, you should have:

- ML invocation logic defined in the application

Procedure

To set the **C1-PREBSEG** feature configuration:

1. Click the **Admin** link in the **Application** toolbar.
A list appears.
2. From the **Admin** menu, select **F** and then click **Feature Configuration**.
A sub-menu appears.
3. Click the **Search** option from the **Feature Configuration** sub-menu.
The **Feature Configuration Query** screen appears.
4. In the **Feature Configuration Search** zone, enter **C1-PREBSEG** in the **Feature Name** field.

Note: ORMB search engine supports wildcard search, where you can substitute the percentage (%) symbol as a stand in for any word or letter in a search criteria. You can use the ‘%’ wildcard character in all input fields except the date and ID fields. The ‘%’ wildcard character is suffixed automatically at the end of the partial search criteria. Therefore, you may or may not specify the wildcard character at the end of the partial search criteria. However, you have to prefix the wildcard character manually wherever required.

5. Click **Search**.
A list of feature configurations that meet the search criteria appears in the search results.
6. In the **Search Results** section, click the link in the **Description** column corresponding to the feature configuration whose details you want to edit.

The **Feature Configuration** screen appears. It contains the following option types:

Option Type	Description	Mandatory (Yes or No)
ML Invocation Logic Enabled	Used to specify whether the ML invocation logic is enabled when the bill segment is generated.	Yes
	Note: If you want to enable the ML invocation logic, specify True else False in the Value field.	

7. Enter the values for the required option types in the **Feature Configuration** screen.
 8. Click the **Save** button in the **Page Title** area.
- The changes made to the feature configuration are saved.

Chapter 53

Automatic Refund

Oracle Revenue Management and Billing enables you to create automatic refunds when a credit bill or a credit adjustment is created or when there is an overpayment. A new algorithm spot named **Immediate Refund Creation** is introduced in the **Division** screen. A new algorithm type named **C1-IMREFCRET** is introduced in this release. You can create an algorithm using the **C1-IMREFCRET** algorithm type and attach it to the **Immediate Refund Creation** algorithm spot of the required divisions.

To implement the automatic refund feature, the following fields are newly introduced in the respective screen:

Screen	Tab	Field Name	Field Description
Account	Main	Immediate Refund	Used to indicate whether you want to process immediate refund for the account.
	Auto Pay	Auto Pay Usage	Used to indicate whether the automatic payment option is available for automatic credit or debit, or for both automatic credit and debit.
Person	Main	Immediate Refund	Used to indicate whether you want to process immediate refund for the person's accounts.
Customer Class	Controls	Immediate Refund	Used to indicate whether you want to process immediate refund for the accounts which belong to the customer class.
Division	Main	Direct Credit Refund	Used to indicate whether you want to process immediate refund for the accounts belonging to the division through the direct credit mode.
		Immediate Refund	Used to indicate whether you want to process immediate refund for the accounts belonging to the division.

Screen	Tab	Field Name	Field Description
			This field is enabled when the Direct Credit Refund or A/P Request Fund option is selected.
		A/P Request Fund	Used to indicate whether you want to process immediate refund for the accounts belonging to the division through the A/P request mode.
Adjustment Type	Main	Refund Option	Used to indicate whether you want to use the adjustment type for creating direct credit refund adjustments or A/P request refund adjustments.
Auto Pay Instruction	Auto Pay	Auto Pay Usage	Used to indicate whether the automatic payment instruction is available for automatic credit or debit, or for both automatic credit and debit.
Auto Pay Route Type	-	Refund Auto Pay Date Calculation Algorithm	Used to calculate the extract date for an automatic refund clearing record in the CI_APAY_CLR_STG table.

Note: While creating a person through a customer registration object, you can also set the immediate refund option for the person. Similarly, while creating an account through a customer registration object, you can also set the immediate refund and auto pay usage options for the account.

Now, when a credit bill is completed, when a credit adjustment is frozen, and when an overpayment is frozen, the system checks whether an algorithm is attached to the **Immediate Refund Creation** algorithm spot of the respective account's division. If an algorithm created using the **C1-IMREFCRET** algorithm type is attached to the **Immediate Refund Creation** algorithm spot of the division, the system checks whether the **Immediate Refund on Credit Bill**, **Immediate Refund on Dispute/Credit Adjustments**, or **Immediate Refund on Overpayment** parameter in the algorithm is set to **Y** depending on whether it is a credit bill, credit adjustment, or overpayment.

If the respective parameter is set to **Y**, the system checks whether the **Immediate Refund** option is selected at either of the following levels – Account, Person, Customer Class, or Division. If so, the system checks whether the **Direct Credit Refund** option of the division is set to **Y** and the automatic payment option for automatic credit or for automatic credit and debit exists for the account. If so, the system creates a refund request using the direct credit

refund request type which is specified in the **C1-IMREFCRET** algorithm. However, if the **Direct Credit Refund** option of the division is set to **N** and the **A/P Request Fund** option of the division is set to **Y**, the system creates a refund request using the A/P request refund request type which is specified in the **C1-IMREFCRET** algorithm. In addition, if the **Direct Credit Refund** option of the division is set to **Y**, the **A/P Request Fund** option of the division is set to **Y**, and the automatic payment option for automatic credit or for automatic credit and debit does not exist for the account, the system creates a refund request using the A/P request refund request type which is specified in the **C1-IMREFCRET** algorithm.

If the **Direct Credit Refund** option of the division is set to **Y**, the **A/P Request Fund** option of the division is set to **N**, and the automatic payment option for automatic credit or for automatic credit and debit does not exist for the account, the system creates a transfer adjustment using the transfer adjustment type which is specified in the **C1-IMREFCRET** algorithm. Also, if the **Direct Credit Refund** option of the division is set to **N** and the **A/P Request Fund** option of the division is set to **N**, the system creates a transfer adjustment using the transfer adjustment type which is specified in the **C1-IMREFCRET** algorithm.

In addition, if the **Immediate Refund** option is not selected at any of the following levels – Account, Person, Customer Class, or Division, the system creates a transfer adjustment using the transfer adjustment type which is specified in the **C1-IMREFCRET** algorithm. Note that these transfer adjustments are created on the excess credit contract of the account. If the excess credit contract is not available for the account, the system creates an excess credit contract for the account using the overpayment contract type which is specified in the **C1-IMREFCRET** algorithm.

The refund requests are created in the **Processed** status. While creating a direct access refund request type, you need to ensure that you specify an adjustment type where the refund option is set to **Direct Credit**. However, while creating an A/P request refund request type, you need to ensure that you specify an adjustment type where the refund option is set to **A/P Payment**. The system will then accordingly create the direct credit or A/P request refund adjustments when the refund request is processed. If the **Adjustment Freeze Switch** parameter in the **C1-IMREFCRET** algorithm is set to **Y**, the transfer and refund adjustments are created in the **Frozen** status.

When a credit bill is canceled for which either the refund adjustments or payments are created, the system does the following:

- Creates the transfer adjustments on the excess credit contract of the account

Note: The system considers the transfer adjustment type and overpayment contract type specified in the **C1-TRNADJEX** algorithm which is attached to the account's customer class.

The **APAYCRET** batch is enhanced to support the new automatic refund process. Now, if the automatic payment amount stamped against a bill is in credit and the auto pay usage flag is set to **Credit** or **Credit and Debit**, the batch creates a refund request against the bill. Here, in addition, if the refund option is set to **Direct Credit** in the respective refund adjustment type, the batch creates a clearing record for the automatic refund in the **CI_ADJ_CLR_STG** table. However, if the refund option is set to **A/P Request** in the respective refund adjustment type, the batch creates an A/P request entry for the automatic refund in the **CI_ADJ_APREQ** table.

Chapter

54

Reporting

Topics:

- [Report Creation Using Apache FOP Framework](#)
- [FOP Reports](#)

Oracle Revenue Management and Billing provides best-in-class enterprise reporting feature which enables its customers to uncover new sights for taking faster and more informed business decisions. The reporting feature is a unique platform which easily integrates with the existing infrastructure and provides reusable design, data elements, and easy access to the application programming interface.

Oracle Revenue Management and Billing Reporting feature provides its customers the following benefits:

- Allows to generate and deliver customized reports to users in various departments and customers on time.
- Allows the implementers to efficiently create and update document templates.
- Supports output in the CSV, JSON, PDF, XML, and XLS formats using custom Formatting Objects Processor (FOP) templates.

Report Creation Using Apache FOP Framework

Oracle Revenue management and Billing allows you to create reports in the CSV, JSON, PDF, XML, and XLS formats using the Apache FOP (Formatting Objects Processor) framework. Apache FOP is an output arrangement which is driven by the XSL formatting object. It is a Java application that reads the XSL formatting object tree conforming to the XSL 1.1 Recommendation (05 December 2006) and then converts it into a document in the required output format. It allows you to preview the output directly on the screen.

To understand more about the framework, refer to the official Apache FOP site at <https://xmlgraphics.apache.org/fop/> or you can also refer GitHub at <https://github.com/apache/fop>.

Prerequisites

To use the Apache FOP reporting feature in ORMB, you should have:

- **C1-REPORTVW** feature configuration set in the application

PDF Generation Using Apache FOP

For generating a PDF from an XML file you need an XSLT stylesheet which converts the XML file to an XSL-FO file. The created XSL-FO file is also an XML file which contains all the formatted objects. The ORMB FOP reporting framework reads the XSL-FO file and formats it to a PDF document.

The process overview of PDF generation from an XML file is shown in the below image:

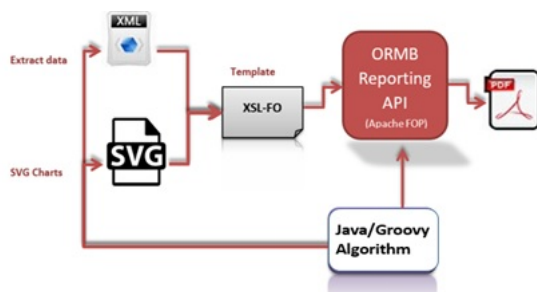

Excel (XLS) Generation Using XSL Transformation

For generating an Excel (XLS) from an XML file you need an XSLT stylesheet which converts the XML file to an XSL file. The created XSL file is also an XML file which contains all the formatted objects. The ORMB reporting framework reads the XSL file and formats it to an Excel (XLS) document.

The process overview of Excel (XLS) generation from an XML file is shown in the below image:

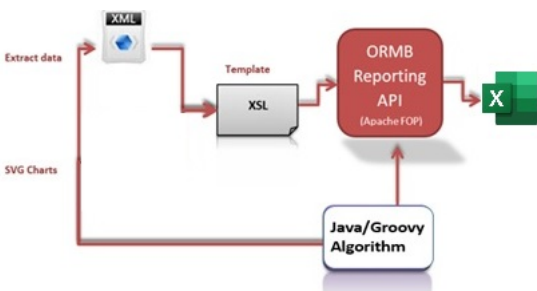

Sample XML Format for FOP Reporting

Using the below example, you can create an XML which contains name and a list of friends with contact numbers:

Sample XML Format for FOP Reporting

```
<?xml version="1.0" encoding="utf-8"?>
<root>
<name>Ryan</name>
<friend>
  <name>David</name>
  <phNo>+1.603.555.0100</phNo>
</friend>
<friend>
  <name>John</name>
  <phNo>+1.603.555.0101</phNo>
</friend>
</root>
```

Note: This is how an XML should be generated with encoded UTF-8 format.

Sample XSL Format for FOP Reporting

Using the below example, you can create an XSL format which renders the table that contains details of friends given in the above sample XML format:

Sample XSL Format for FOP Reporting

```
<?xml version="1.0" encoding="utf-8"?>
<xsl:stylesheet version="1.1"
  xmlns:xsl="http://www.w3.org/1999/XSL/Transform"
  xmlns:fo="http://www.w3.org/1999/XSL/Format"
  exclude-result-prefixes="fo">
<xsl:template match="root">
<fo:root xmlns:fo="http://www.w3.org/1999/XSL/Format">
  <fo:layout-master-set>
    <fo:simple-page-master master-name="my-page">
      <fo:region-body margin="1in"/>
    </fo:simple-page-master>
  </fo:layout-master-set>
  <fo:page-sequence master-reference="my-page">
    <fo:flow flow-name="xsl-region-body">
      <fo:block>Hello, <xsl:value-of select="name" />!</fo:block>
      <fo:block>
        <fo:table>
          <fo:table-body>
            <fo:table-row>
              <fo:table-cell border="solid 1px black" text-align="center" font-weight="bold">
                <fo:block>No.</fo:block>
              </fo:table-cell>
              <fo:table-cell border="solid 1px black" text-align="center" font-weight="bold">
                <fo:block>Name</fo:block>
              </fo:table-cell>
              <fo:table-cell border="solid 1px black" text-align="center" font-weight="bold">
                <fo:block>Phone Number</fo:block>
              </fo:table-cell>
            </fo:table-row>
            <xsl:for-each select="./friend">
              <fo:table-row>
                <fo:table-cell border="solid 1px black" text-align="center">
                  <fo:block>
                    <xsl:value-of select="position()" />
                  </fo:block>
                </fo:table-cell>
                <fo:table-cell border="solid 1px black" text-align="center">
```

```

<fo:block>
  <xsl:value-of select="name" />
</fo:block>
</fo:table-cell>
<fo:table-cell border="solid 1px black" text-align="center">
  <fo:block>
    <xsl:value-of select="phNo" />
  </fo:block>
</fo:table-cell>
</fo:table-row>
</xsl:for-each>
</fo:table-body>
</fo:table>
</fo:block>
</fo:flow>
</fo:page-sequence>
</fo:root>
</xsl:template>
</xsl:stylesheet>

```

Note: For more information on XSL Format, refer below links:

- <https://www.netjstech.com/2015/07/how-to-create-pdf-from-xml-using-apache-fop.html>.
- <https://xmlgraphics.apache.org/fop/>

Create XSL Template for an FOP Report

The XSL template is required to create an FOP report in the PDF or Excel (XLS) format. The XSL template converts the XML file into XSL-FO file. This XSL-FO is further read by the ORMB FOP reporting framework and formats the XSL-FO file into a PDF/Excel (XLS) file.

Note: For more information on XSL Format, refer below links:

- <https://www.netjstech.com/2015/07/how-to-create-pdf-from-xml-using-apache-fop.html>.
- <https://xmlgraphics.apache.org/fop/>

XSL Templates shipped with ORMB

The following XSL templates for the corresponding FOP reports are shipped with ORMB:

XSL Template	FOP Report
FOPAGEBPDF	AgingReport.xml
FOPAGEOPDF	
FOPAGEHCBPDF	AgingReportHC.xml
FOPAGEHCOPDF	
FOPAGEHCBXLS	AgingReportHCExcel.xml
FOPAGEHCOXLS	
RPT_LETTER	AutoPay_Letter.xml
FOPAPAYHBPdf	AutoPayResponseReport.xml

XSL Template	FOP Report
FOPAPAYHOPDF	
FOPAPAYHBXLS	AutoPayResponseReportExcel.xsl
FOPAPAYHOXLS	
PLSM_DETEXL	billExtract_Banking_Individual.xsl
PLSM_SMRYEXL	
FOPBIPAHBPDF	BinderPaymentReport.xsl
FOPBIPAHOPDF	
FOPBIPAHBXLS	BinderPaymentReportExcel.xsl
FOPBIPAHOXLS	
DCMR	Deal_Compare_Exl.xsl
DLDWLD	Deal_Extract_For_Upload.xsl
DEEEXCEL	Deal_Internal_Exl.xsl
DEIEXCEL	
DEIPDF	Deal_Internal_Version2.xsl
DLPRTEXLR	Deal_Profitability_Exl.xsl
DEEPDF	DealExtract_External_Type.xsl
FOPDDROPDF	DirectDebitRejection.xsl
EFPR_EXT_PDF	Effective_Pricing_Extract.xsl
EFPR_EXT_EXL	Effective_Pricing_Extract_Exl.xsl
REP_CODE2	ExpiringCreditCard_Letter.xsl
FOPASLHCBPDF	FOPAggregateStoplossHCReport.xsl
FOPASLHCOPDF	
FOPASLHCBXLS	FOPAggregateStoplossHCReportExcel.xsl
FOPASLHCOXLS	
FOPSSLHCBPDF	FOPSpecificStoplossHCReport.xsl
FOPSSLHCOPDF	
FOPSSLHCBXLS	FOPSpecificStoplossHCReportExcel.xsl
FOPSSLHCOXLS	

XSL Template	FOP Report
FOPHLDBXLS	HoldEntityDetailsReport.xml
FOPHLDOXLS	
FOPPADGHBPDF	PaymentDetailGroupHCReport.xml
FOPPADGHOPDF	
FOPPADGHBXLS	PaymentDetailGroupHCReportExcel.xml
FOPPADGHOXLS	
FOPPADIHBPDI	PaymentDetailHCReport.xml
FOPPADIHOPDI	
FOPPADIHBXLS	PaymentDetailHCReportExcel.xml
FOPPADIHOXLS	
FOPPAYDTBPDF	PaymentDetailReport.xml
FOPPAYDTOPDI	
FOPPASGHBPDF	PaymentSummaryGroupHCReport.xml
FOPPASGHOPDI	
FOPPASGHBXLS	PaymentSummaryGroupHCReportExcel.xml
FOPPASGHOXLS	
FOPPASMHBPDF	PaymentSummaryHCReport.xml
FOPPASMHOPDI	
FOPPASMHBXLS	PaymentSummaryHCReportExcel.xml
FOPPASMHOXLS	
FOPPAYSMBPDF	PaymentSummaryReport.xml
FOPPAYSMPDI	
FOPWRORBPDI	RefundWriteOff.xml
FOPWROROPDI	
FOPWRORBXLS	RefundWriteOffExcel.xml
FOPWROROXLS	
FOPTODOOPDI	ToDoReport.xml
FOPTODOBPDI	

XSL Template	FOP Report
FOPTODOOXLS	ToDoReportExcel.xsl
FOPTODOBXLS	
FOPTRDTBXLS	TransactionRejectionDetailExcel.xsl
FOPTRDTOXLS	
FOPTRSMBXLS	TransactionRejectionSummaryExcel.xsl
FOPTRSMOXLS	
FOPUSROPDF	UserAccessReport.xsl

Create an Algorithm for an FOP Report

Before creating any new custom FOP report an algorithm is created which contains the following content:

- Query for the report
- XML formation code
- Input parameter validation
- Call to report generation algorithm

The algorithm is then associated with the FOP report while defining the FOP report in the application. When the FOP report is generated, the algorithm which is attached to the FOP report does the following:

- Extract data from the system in an XML file
- Present the extracted data in CSV, JSON, PDF, XML, or XLS format using the XSL file associated with the FOP report

The following algorithms for the corresponding FOP reports are shipped with ORMB:

FOP Report	Report Generation Algorithm
FOPADJBXLS	C1_FOPADJUST
FOPADJOXLS	
FOPAGEBPDF	C1_FOPAGING
FOPAGEOPDF	
FOPAGEHCBPDF	C1_FOPAGEHC
FOPAGEHCOPDF	
FOPAGEHCBXLS	C1_FOPAGEHC
FOPAGEHCOXLS	
FOPAPAYHBPDF	C1_FOPAPAY
FOPAPAYHOPDF	
FOPAPAYHBXLS	C1_FOPAPAY

FOP Report	Report Generation Algorithm
FOPAPAYHOXLS	
PLSM_DETEXL	C1-PLDETXCL
PLSM_SMRYEXL	C1-PLSMEXCL
FOPBIPAHBPDF	C1_FOPBIPA
FOPBIPAHOPDF	
FOPBIPAHBXLS	C1_FOPBIPA
FOPBIPAHOXLS	
DCMR	C1-DLCMPRRPT
DLDWLD	C1-DLDWLD
DEEEXCEL	C1-DLEXTEXCL
DEIEXCEL	C1-DLINTEXCL
DEIPDF	C1-DLINTPDF
DLPRTEXLR	C1-DLPRTEXLR
DEEIPDF	C1-DLEXTPDF
FOPDDROPDF	C1_FOPDEBIT
EFPR_EXT_PDF	C1-EFFPRPDF
EFPR_EXT_EXL	C1-EFFPREXL
FOPASLHC BPDF	C1_FOPASLHC
FOPASLHCOPDF	
FOPASLHC BXLS	C1_FOPASLHC
FOPASLHC OXLS	
FOPSSLHC BPDF	C1_FOPSSLHC
FOPSSLHCOPDF	
FOPSSLHC BXLS	C1_FOPSSLHC
FOPSSLHC OXLS	
FOPHLDBXLS	C1_FOPHOLD
FOPHLDOXLS	
FOPPADGH BPDF	C1_FOPPADTGH

FOP Report	Report Generation Algorithm
FOPPADGHOPDF	
FOPPADGHBXLS	C1_FOPPADTGH
FOPPADGHOXLS	
FOPPADIHBPDF	C1_FOPPAYHDT
FOPPADIHOPDF	
FOPPADIHBXLS	C1_FOPPAYHDT
FOPPADIHOXLS	
FOPPAYDTBPDF	C1_FOPPAY
FOPPAYDTPDF	
FOPPASGHBPDF	C1_FOPPAHGSM
FOPPASGHOPDF	
FOPPASGHBXLS	C1_FOPPAHGSM
FOPPASGHOXLS	
FOPPASMHBPDF	C1_FOPPAYHSM
FOPPASMHOPDF	
FOPPASMHBXLS	C1_FOPPAYHSM
FOPPASMHOXLS	
FOPPAYSMBPDF	C1_FOPPAY
FOPPAYSMPDF	
FOPWRORBPDF	C1_FOPRWO
FOPWROROPDF	
FOPWRORBXLS	C1_FOPRWO
FOPWROROXLS	
FOPTODOOPDF	C1_FOPTODO
FOPTODOBPDF	
FOPTODOOXLS	C1_FOPTODO
FOPTODOBXLS	
FOPTRDTBXLS	C1_FOPTXNREG

FOP Report	Report Generation Algorithm
FOPTRDTOXLS	
FOPTRSMBXLS	C1_FOFTXNREG
FOPTRSMOXLS	C1_FOFTXNREG
FOPUSROPDF	C1_FOPUSER

Creating a Message for an FOP Report

Prerequisite

To create a message for an FOP report you should have:

- Error message added in the MessageRepository.java file. For example:

```
public static ServerMessage searchByIsNull()
{
    MessageRepository repo = MessageRepository.getInstance();
    MessageParameters messageParms = new MessageParameters();
    return repo.getMessage(SEARCH_BY_IS_NULL, messageParms);
}
```

- Error code added in the ReportingMessage.java file. For example:

```
public static final int SEARCH_BY_IS_NULL = 2039;
```

Procedure

To create a message for an FOP report:

1. Click the **Admin** link in the **Application** toolbar.
A list appears.
2. From the **Admin** menu, select **M** and then click **Message**.
A sub-menu appears
3. Click the **Add** option from the **Message** sub-menu.

The Select Business Object screen appears. It contains the following field:

Field Name	Field Description	Mandatory (Yes or No)
Message Business Object	Used to indicate that you want to create a message for a business object.	Yes

4. Select **Message** from the **Message Business Object** list.
5. Click **OK**.

The **Message** screen appears. It contains the following fields:

Field Name	Field Description	Mandatory (Yes or No)
Message Category	Used to indicate the category for which you want to create a message. The valid value is: <ul style="list-style-type: none"> • Reports 	Yes

Field Name	Field Description	Mandatory (Yes or No)
Message Number	Used to specify the error code which you have added in the ReportingMessage.java file.	Yes
Message Text	Used to specify the error message.	Yes
Detailed Description	Used to specify additional information about the message.	No

6. Click **Save**.

The message is created.

Calling the ORMB FOP Reporting API

Procedure

To call the ORMB FOP reporting API:

1. You should use the ORMB provided business component to call the below reporting API which generates the FOP reports:
com.splwg.ccb.domain.reportsubmission.FOPReportGenerationComponent_Impl
2. Call the reporting API method in the below format:

```
public String generateReport(String xslTemplateName, String xmlContent, String outputFileName)
```

The parameters for the reporting API method is defined as below:

Parameter Name	Parameter Description
xslTemplateName	Used to pass the XSL-FO/XSL file name. It is given in the below format: <code><name of report>.xsl</code>
xmlContent	Used to pass the XML content generated by the algorithm.
outputFileName	Used to pass the PDF/Excel (XLS) file name that you want to generated. It is given in the below format: <code><name_of_report>.pdf/xls</code>

Setting Master Configuration for Email Notification

Procedure

Email notification is configured for FOP reports which are generated in the batch mode. To set master configuration for email notification:

1. Click the **Admin** link in the **Application** toolbar.
A list appears.
2. From the **Admin** menu, select **M** and then click **Master Configuration**.
The **Master Configuration** screen appears.
3. Search for **Reporting Email Sender Configuration** in the **Master Configuration List** zone.
4. Click the **Add**  icon in the **Action** column corresponding to **Reporting Email Sender Configuration**.

The **Master Configuration** screen appears. It contains the following fields:

Field Name	Field Description	Mandatory (Yes or No)
Master Configuration	Displays the master configuration	Not Applicable
SMTP Host Name	Used to specify the SMTP application to send and receive emails.	Yes
SMTP Port	Used to specify the communication endpoint to transfer email data over SMTP through a network, from one server to another. The valid value is: <ul style="list-style-type: none"> 25 	Yes
Username	Used to specify the username of the user.	Yes
Password	Used to specify the password for the user.	Yes
Secure Sockets Layer	Used to indicate whether you want to transfer the email data securely across a network.	No
Test	Used to configure the sender's and receiver's email ID.	Yes
From Email Address	Used to specify the user's email ID. <div style="border: 1px solid black; padding: 2px; margin-top: 5px;">Note: This field appears only when you select the check box corresponding to the Test field.</div>	Yes
To Recipient Email ID	Used to specify the receiver's email ID. <div style="border: 1px solid black; padding: 2px; margin-top: 5px;">Note: This field appears only when you select the check box corresponding to the Test field.</div>	Yes

5. Enter the required details in the **Master Configuration** screen.
6. Click **Save**.

The master configuration for email notification is set.

Creating a Custom Algorithm for FOP Reports

Prerequisite

To create a custom algorithm for FOP reports you should have:

- The **ReportDataExtractAlgorithmSpot** algorithm spot defined in the application

Procedure

To create a custom algorithm for FOP reports:

1. Log into **Eclipse**.
2. In the navigation pane, right click on the **C1** folder.

A list appears.

- From the list, select **New** and then click **Others**.

The **Select a Wizard** window appears. It contains the following field:

Field Name	Field Description	Mandatory (Yes or No)
Wizard	Used to filter the Algorithm Implementation wizard.	No

Note: You can also navigate to the **Algorithm Implementation** wizard in the **Oracle Utilities** section through the navigation window provided below the **Wizard** field.

- Select **Algorithm Implementation** from the navigation window.
- Click **Next**.

The **New Algorithm Implementation** window appears. It contains the following fields:

Field Name	Field Description	Mandatory (Yes or No)
Source Folder	Displays the source from where the algorithm spot is called. The valid value is: <code>C1/Java</code>	Not Applicable
Package	Used to specify the directory in the source folder where you want the algorithm to appear. The valid value is: <code>com.splwg.ccb.domain.reports</code>	Yes
Name	Used to specify the algorithm that you want to create.	Yes
Soft Parameters	Used to specify parameters for the algorithm.	No
Algorithm Spot Interface	Used to specify the algorithm spot used to create custom data extract in the PDF or XLS format. The valid value is: <code>com.splwg.ccb.domain.reports</code> Note: You can also extract data in the XML, CSV, or JSON formats by calling the <code>CommonUtil_Impl</code> API while generating the respective report.	Yes

- Click **Finish**.

The custom algorithm for FOP report is created.

Configuring the Custom Algorithm from the User Interface

Prerequisites

To configure the custom algorithm from the user interface you should:

- Define custom algorithm JAVA code

- Generate artifacts, do Web Build and start the WebLogic server to bring the ORMB application up and running

Procedure

To configure the custom algorithm from the user interface you should:

- Create an algorithm type and associate it with the custom algorithm java code
 - Create an algorithm and associate it with the algorithm type
1. To create an algorithm type, click the **Admin** link in the **Application** toolbar.
A list appears.
 2. From the **Admin** menu, select **A** and then click **Algorithm Type**.
A sub-menu appears
 3. Click the **Add** option from the **Algorithm Type** sub-menu.

The **Algorithm Type** screen appears. It contains the following fields:

Field Name	Field Description	Mandatory (Yes or No)
Algorithm Type	Used to specify the algorithm type that you want to create in the system.	Yes
Description	Used to specify the description for the algorithm type.	Yes
Detailed Description	Used to specify additional information about the algorithm type	No
Algorithm Entity	Used to indicate the algorithm entity for which you want to create the algorithm type. The valid value is: <ul style="list-style-type: none"> • Report-Data Extract Algorithm 	Yes
Program Type	Used to indicate the program code using which the custom algorithm is created. The valid value is: <ul style="list-style-type: none"> • JAVA 	Yes
Program Name	Used to specify the custom algorithm java code. The valid value is: com.splwg.ccb.domain.reportsubmission.ReportDataExtractAlgor	Yes

In addition, the **Algorithm Type** screen contains the following fields in a grid:

Field Name	Field Description	Mandatory (Yes or No)
Sequence	Used to specify the sequence in which the parameter is considered for the algorithm type.	No
Parameter	Used to specify the parameter using which you want to create the algorithm type.	No
Required	Used to indicate whether the parameter is required or not.	No
Owner	Indicates the user who associated the parameter with the algorithm type.	No

4. Enter the required details in the **Algorithm Type** screen.
5. Click **Save**.
The algorithm type is saved.
6. To create an algorithm, click the **Admin** link in the **Application** toolbar.
A list appears.
7. From the **Admin** menu, select **A** and then click **Algorithm**.
A sub-menu appears
8. Click the **Add** option from the **Algorithm** sub-menu.
The **Algorithm** screen appears. It contains the following fields:

Field Name	Field Description	Mandatory (Yes or No)
Algorithm Code	Used to specify the algorithm that you want to create in the system	Yes
Description	Used to specify the description for the algorithm.	Yes
Algorithm Type	Used to specify the algorithm type to which you want to associate the algorithm.	Yes
Algorithm Type Description	Displays the description of the algorithm type.	Not Applicable
Parameter	Displays the parameter of the algorithm.	Not Applicable
Effective Date	Displays the date from when the algorithm type is effective for the algorithm.	Not Applicable

9. Enter the required details in the **Algorithm** screen.
10. Click **Save**.
The custom algorithm is configured in the user interface.

Report Creation

The **Report Creation** screen allows you to define reports for extracting data of a person and/or its accounts using the Apache FOP framework. It also enables you to view, edit, or delete an existing report. It contains the following zone:

[Report Search](#) on page 4271

Report Search

The **Report Search** zone allows you to search for an existing FOP report using various search criteria. It contains the following two sections:

- **Search Criteria** - The **Search Criteria** section contains the following fields:

Field Name	Field Description	Mandatory (Yes or No)
Report	Used to search for a particular FOP report.	No
Description	Used to search FOP reports with a particular description.	No

Note: You must specify at least one search criterion while searching for an FOP report.

- **Search Results** - On clicking the **Search** button, the search results appear based on the specified search criteria. The **Search Results** section contains the following columns:

Column Name	Column Description
Report	Displays the FOP report.
Description	Displays the description of the FOP report.
Output Format	Indicates the format in which the FOP report is extracted from the system. Note: At present, you can extract an FOP report in PDF, CSV, and XML formats.
Report Type	Indicates the type of information which is extracted using the FOP report. The valid values are: <ul style="list-style-type: none"> • Bill • Custom • Letter
View	On clicking the View button you can view the details of the FOP report.
Edit	On clicking the Edit (✎) icon, the Report Creation screen appears where you can edit the details of the FOP report.
Delete	On clicking the Delete (🗑) icon, you can delete the FOP report.

Note: Pagination is used to display limited number of records in the **Search Results** section. You can use the navigation links, such as **Previous** and **Next** to navigate between pages.

Related Topics

For more information on...	See...
How to search for an FOP report	Searching for an FOP Report on page 4272
How to view the details of an FOP report	Viewing the FOP Report Details on page 4280
How to define an FOP report	Defining an FOP Report on page 4273
How to edit an FOP report	Editing an FOP Report on page 4276
How to delete an FOP report	Deleting an FOP Report on page 4280

Searching for an FOP Report

Procedure

To search for an FOP report:

1. Click the **Admin** link in the **Application** toolbar.
A list appears.
2. From the **Admin** menu, select **R** and then click **Report Creation**.
The **Report Creation** screen appears.
3. Enter the search criteria in the **Report Search** zone.

Note: ORMB search engine supports wildcard search, where you can substitute the percentage (%) symbol as a stand in for any word or letter in a search criteria. You can use the ‘%’ wildcard character in all input fields except the date and ID fields. The ‘%’ wildcard character is suffixed automatically at the end of the partial search criteria. Therefore, you may or may not specify the wildcard character at the end of the partial search criteria. However, you have to prefix the wildcard character manually wherever required.

4. Click **Search**.

A list of FOP reports that meet the search criteria appears in the **Search Results** section.

Related Topics

For more information on...	See...
Report Creation screen	Report Creation on page 4271
Report Search zone	Report Search on page 4271

Defining an FOP Report

Prerequisites

To define an FOP report you should have:

- FOP reporting framework configured in the system
- **C1_FOPONBL** algorithm defined in the system to create FOP reports for bill templates
- Parameters defined for the **C1_FOPONBL** algorithm
- **C1_FOPONBL** algorithm attached to the **Online Bill Display** system event
- **C1_FOPLTRALG** algorithm defined in the system to create FOP reports for letter templates
- Parameters defined for the **C1_FOPLTRALG** algorithm
- **C1_FOPLTRALG** algorithm attached to the **Online Letter Image** system event
- Algorithms defined in the application for creating custom FOP reports

Procedure

To define an FOP report:

1. Click the **Admin** link in the **Application** toolbar.
A list appears.
2. From the **Admin** menu, select **R** and then click **Report Creation**.
The **Report Creation** screen appears.
3. Click the **Add** button available at the upper right corner of the **Report Creation** screen.
The **Report Creation** screen appears. It contains the following fields:

Field Name	Field Description	Mandatory (Yes or No)
Report	Used to specify the FOP report	No
Description	Used to specify the description for the FOP report	No
Output Format	Used to indicate the format in which you want to generate the FOP report. The valid values are: <ul style="list-style-type: none"> • CSV 	Yes

Field Name	Field Description	Mandatory (Yes or No)
	<ul style="list-style-type: none"> • DOCX • JSON • PDF • Web • XLS • XML <p>Note: At present, the system supports extraction of an FOP report in the CSV, JSON, PDF, XML, and XLS formats. You can customize the algorithm to support the extraction of an FOP report in the DOCX and Web formats.</p>	
Script	<p>Used to indicate the script using which the FOP report is extracted in the Web format.</p> <p>Note: This field is enabled only when you select the Web option from the Output Format list.</p>	No
Report Type	<p>Used to indicate the type of information that you want to extract using the FOP report. The valid values are:</p> <ul style="list-style-type: none"> • Bill • Custom • Letter <p>Note: This field is disabled when you select the Web option from the Output Format list.</p>	Yes
Report Template	<p>Used to indicate the template using which the FOP report is uploaded in the system.</p> <p>Note: This field appears only when you select the Bill or Letter option from the Report Type list.</p>	Yes
XSL Template	<p>Used to indicate the XSL template file using which you want to create the FOP report.</p>	Yes

Field Name	Field Description	Mandatory (Yes or No)
	<p>Note:</p> <p>The Upload button appears corresponding to the XSL Template field. On clicking the Upload button, the Upload XSL Template window appears where you can choose the required XSL template.</p> <p>This field is disabled when you select the Web option from the Output Format list.</p>	
Report Generation Algorithm	<p>Used to indicate the algorithm defined for creating a custom FOP report.</p> <p>Note:</p> <p>The Search  icon appears corresponding to the Report Generation Algorithm field. On clicking the Search icon, the Algorithm Code/Description window appears where you can search for the required algorithm.</p> <p>This field is enabled only when you select the Custom option from the Report Type list.</p>	<p>Yes (Conditional)</p> <p>Note: This field is required while creating a custom FOP report.</p>
Reporting Mode	<p>Used to indicate whether you want to generate the FOP report in the batch mode or online mode. The valid values are:</p> <ul style="list-style-type: none"> • Batch • Online 	Yes
Email ID	<p>Used to specify the email ID where you want to send the notification of the FOP report generation.</p> <p>Note: This field is enabled only when you select the Batch option from the Reporting Mode list.</p>	<p>Yes (Conditional)</p> <p>Note: The field is required for generating FOP report in the batch mode.</p>
Subject	<p>Used to specify the text which you want to appear in the subject line of the email.</p> <p>Note: This field is enabled only when you select the Batch option from the Reporting Mode list.</p>	<p>Yes (Conditional)</p> <p>Note: The field is required for generating FOP report in the batch mode.</p>

Field Name	Field Description	Mandatory (Yes or No)
Email Body Content	Used to specify the content which you want to appear in the email body,	Yes (Conditional)
	Note: This field is enabled only when you select the Batch option from the Reporting Mode list.	Note: The field is required for generating FOP report in the batch mode.

In addition, the **Report Creation** screen contains the following columns:

Column Name	Column Description	Mandatory (Yes or No)
Display Sequence	Used to indicate the sequence of the parameter.	No
Report Parameter	Used to indicate the parameter which you want to define while generating the FOP report.	No
	Note: The Search (🔍) icon appears corresponding to the Report Parameter field. On clicking the Search icon, the Field Details window appears where you can search for the required parameter. On specifying the parameter, the description of the parameter appears corresponding to the Report Parameter field.	

Note: The above columns do not appear when you select the **Web** option from the **Output Format** list.

- Enter the required details in the **Report Creation** screen.
- Click **Save**.

The FOP report is defined.

Related Topics

For more information on...	See...
Report Creation screen	Report Creation on page 4271

Editing an FOP Report

Prerequisites

To edit an FOP report you should have:

- FOP report (whose details you want to edit) defined in the application
- Algorithms defined in the application for creating custom FOP reports

Procedure

To edit an FOP report:

- Search for the FOP report in the **Report Search** zone of the **Report Creation** screen.

2. In the **Search Results** section, click the **Edit** (✎) icon in the **Edit** column corresponding to the FOP report whose details you want to edit.

The **Report Creation** screen appears. It contains the following fields:

Field Name	Field Description	Mandatory (Yes or No)
Report	Used to specify the FOP report	Not Applicable
Description	Used to specify the description for the FOP report	No
Output Format	<p>Used to indicate the format in which you want to generate the FOP report. The valid values are:</p> <ul style="list-style-type: none"> • CSV • DOCX • JSON • PDF • Web • XLS • XML <p>Note: At present, the system supports extraction of an FOP report in the CSV, JSON, PDF, XML, and XLS formats. You can customize the algorithm to support the extraction of an FOP report in the DOCX and Web formats.</p>	Yes
Script	<p>Used to indicate the script using which the FOP report is extracted in the Web format.</p> <p>Note: This field is enabled only when you select the Web option from the Output Format list.</p>	No
Report Type	<p>Used to indicate the type of information that you want to extract using the FOP report. The valid values are:</p> <ul style="list-style-type: none"> • Bill • Custom • Letter <p>Note: This field is disabled when you select the Web option from the Output Format list.</p>	Yes

Field Name	Field Description	Mandatory (Yes or No)
Report Template	Used to indicate the template using which the FOP report is uploaded in the system. Note: This field appears only when you select the Bill or Letter option from the Report Type list.	Yes
XSL Template	Used to indicate the XSL template file using which you want to create the FOP report. Note: The Upload button appears corresponding to the XSL Template field. On clicking the Upload button, the Upload XSL Template window appears where you can choose the required XSL template. This field is disabled when you select the Web option from the Output Format list.	Yes
Report Generation Algorithm	Used to indicate the algorithm defined for creating a custom FOP report. Note: The Search  icon appears corresponding to the Report Generation Algorithm field. On clicking the Search icon, the Algorithm Code/Description window appears where you can search for the required algorithm. This field is enabled only when you select the Custom option from the Report Type list.	Yes (Conditional) Note: This field is required while creating a custom FOP report.
Reporting Mode	Used to indicate whether you want to generate the FOP report in the batch mode or online mode. The valid values are: <ul style="list-style-type: none"> • Batch • Online 	Yes
Email ID	Used to specify the email ID where you want to send the notification of the FOP report generation.	Yes (Conditional)

Field Name	Field Description	Mandatory (Yes or No)
	Note: This field is enabled only when you select the Batch option from the Reporting Mode list.	Note: The field is required for generating FOP report in the batch mode.
Subject	Used to specify the text which you want to appear in the subject line of the email. Note: This field is enabled only when you select the Batch option from the Reporting Mode list.	Yes (Conditional) Note: The field is required for generating FOP report in the batch mode.
Email Body Content	Used to specify the content which you want to appear in the email body, Note: This field is enabled only when you select the Batch option from the Reporting Mode list.	Yes (Conditional) Note: The field is required for generating FOP report in the batch mode.

In addition, the **Report Creation** screen contains the following columns:

Column Name	Column Description	Mandatory (Yes or No)
Display Sequence	Used to indicate the sequence of the parameter.	No
Report Parameter	Used to indicate the parameter which you want to define while generating the FOP report. Note: The Search (🔍) icon appears corresponding to the Report Parameter field. On clicking the Search icon, the Field Details window appears where you can search for the required parameter. On specifying the parameter, the description of the parameter appears corresponding to the Report Parameter field.	No

Note: The above columns do not appear when you select the **Web** option from the **Output Format** list.

3. Modify the required details in the **Report Creation** screen.
4. Click **Save**.

The changes made to the FOP report are saved.

Related Topics

For more information on...	See...
How to search for an FOP report	Searching for an FOP Report on page 4272

For more information on...	See...
Report Search zone	Report Search on page 4271
Report Creation screen	Report Creation on page 4271

Deleting an FOP Report

Procedure

To delete an FOP report:

1. Search for the FOP report in the **Report Search** zone of the **Report Creation** screen.
2. In the **Search Results** section, click the **Delete** (🗑️) icon in the **Delete** column corresponding to the FOP report that you want to delete.
A message appears confirming whether you want to delete the FOP report from the system.
3. Click **OK**.
4. The FOP report is deleted.

Related Topics

For more information on...	See...
How to search for an FOP report	Searching for an FOP Report on page 4272
Report Search zone	Report Search on page 4271
Report Creation screen	Report Creation on page 4271

Viewing the FOP Report Details

Prerequisites

To view the FOP report details you should have:

- FOP report (whose details you want to view) defined in the system

Procedure

To view the FOP report details:

1. Search for the FOP report in the **Report Search** zone of the **Report Creation** screen.
2. In the **Search Results** section, click the **View** button in the **View** column corresponding to the FOP report whose details you want to view.
The **Report Details** screen appears.
3. View the details of the FOP report in the **Report Details** screen.

Related Topics

For more information on...	See...
How to search for an FOP report	Searching for an FOP Report on page 4272
Report Search zone	Report Search on page 4271
Report Creation screen	Report Creation on page 4271

Report Audit

The **Report Audit** screen allows you to track the records of the generated FOP reports in the system. It also allows you to do the following:

- Download the FOP reports which are generated successfully in the system
- View the error message of the FOP report which did not generate successfully

The **Report Audit** screen contains the following zone:

[Report Generation List](#) on page 4281

Related Topics

For more information on...	See...
How to downloading an FOP Report	Downloading an FOP Report on page 4281

Report Generation List

The **Report Generation List** zone allows you to view a list of FOP reports which are generated in the system. It contains the following columns:

Column Name	Column Description
Sequence	Displays the sequence of the generated FOP report.
Report ID	Displays the unique identification number which is created automatically by the system for a particular FOP report during report generation process.
Report	Displays the FOP report which is generated in the system.
Created By	Displays the user who has generated the FOP report in the system.
Creation Date Time	Displays the date and time when the FOP report is generated in the system.
Generation Successful	Indicates whether the FOP report generation is successful or not. The valid values are: <ul style="list-style-type: none"> • No • Yes
Message Text	Displays information about the FOP report generation. <div style="border: 1px solid black; padding: 5px; margin-top: 5px;"> <p>Note:</p> <p>If the FOP report generation is successful, then, this column displays the following message:</p> <p>Report Generation Success</p> <p>However, if the FOP report generation is not successful, then, this column displays the reason why the FOP reports is not generated successfully in the system.</p> </div>
Download Report	On clicking the Download link, you can download the FOP report. <div style="border: 1px solid black; padding: 5px; margin-top: 5px;"> <p>Note: The Download link does not appear for FOP reports which are not generated successfully in the system.</p> </div>

Downloading an FOP Report

Prerequisites

To download an FOP report you should have:

- FOP reports generated successfully in the system

Procedure

To download an FOP report:

1. Click the **Admin** link in the **Application** toolbar.

A list appears.

2. From the **Admin** menu, select **R** and then click **Report Audit**.

The **Report Audit** screen appears.

3. Ensure that the **Report Generation List** zone is expanded in the **Report Audit** screen.

4. Click the **Filters** (Y) icon available at the upper right corner of the **Report Generation List** zone.

The **Report** field appears below the report list.

5. Specify the FOP report which you want to download in the **Report** field.

6. Click **Search**.

The specified FOP report is filtered in the **Report Generation List** zone.

7. Click the **Download** link in the **Download** column corresponding to the FOP report that you want to download.

The FOP report is downloaded.

Related Topics

For more information on...	See...
Report Audit screen	Report Audit on page 4280
Report Generation List zone	Report Generation List on page 4281

Report Generation

The **Report Generation** screen allows you to extract the details of an FOP report.

Generating an FOP Report

Prerequisites

To generate an FOP report you should have:

- FOP reports created in the system

Procedure

To generate an FOP report:

1. Click the **Menu** link in the **Application** toolbar.

A list appears.

2. From the **Main** menu, select **Reports** and then click **Report Generation**.

The **Report Generation** screen appears. It contains the following fields:

Field Name	Field Description	Mandatory (Yes or No)
Report	Used to indicate the FOP report that you want to generate.	Yes

Field Name	Field Description	Mandatory (Yes or No)
Description	Displays the description of the FOP report	Not Applicable

In addition, the **Report Generation** screen contains the following columns:

Column Name	Column Description
Display Sequence	Displays the sequence in which the parameter is defined for the FOP report.
Report Parameter	Displays the parameter which is defined for the FOP report.
Report Parameter Value	Used to specify the value of the parameter for generating the FOP report.

3. Select the required FOP report from the **Report** list.
4. Specify the values of the parameters defined for the FOP report in the **Report Parameter** Value column.
5. Click **Generate**.

The FOP report is generated.

Related Topics

For more information on...	See...
Report Generation screen	Report Generation on page 4282

FOP Reports

Oracle Revenue Management and Billing enables you to extract data using the following FOP reports:

- [Adjustment Detail Report](#) on page 4283
- [Entity Hold Detail Report](#) on page 4284
- [Invoice Aging Report](#) on page 4284
- [Payment Detail Report](#) on page 4284
- [Payment Summary Report](#) on page 4285
- [Transaction Rejection Detail Report](#) on page 4285
- [Transaction Rejection Summary Report](#) on page 4285
- [To Do Report](#) on page 4285
- [User Access Report](#) on page 4286
- [Quick Response Code Generation](#) on page 4286

For more information about these FOP reports, refer to *Oracle Revenue Management and Billing FOP Reports Guide*

Adjustment Detail Report

The **Adjustment Detail** report enables you to view the adjustments which are created for persons or accounts, or which are created against bills. While generating the adjustment detail report, you can specify the following parameters – Start Date, End Date, Division, Entity Type, and Entity ID. The start date is mandatory. If you do not specify the end date, the system by default sets it to the system date. For example, if you specify the start date as 01-01-2022 and entity type as Account, the system will extract all adjustments which are created for the accounts from 01-01-2022 till the current date.

You can generate the adjustment detail report from the user interface or through a batch process in the Excel format. We have shipped the following adjustment detail reports in this release:

- **FOPADJBXLS** - Used when you want to generate the adjustment detail report through the **C1-RPTGN** batch in the Excel format.
- **FOPADJOXLS** - Used when you want to generate the adjustment detail report from the user interface in the Excel format.

Entity Hold Detail Report

The **Entity Hold Detail** report enables you to view the entities, such as persons, accounts, or bills for which the business processes, such as bill generation, automatic payment, funding, overdue, or refund, are on hold for a given period. While generating the entity hold detail report, you can specify the following parameters – Start Date, End Date, Division, Hold Entity, Entity ID, Hold Process, and Hold Status. The start date is mandatory. If you do not specify the end date, the system by default sets it to the system date. For example, if you specify the start date as 01-01-2021 and hold entity as Bill, the system will extract all hold requests which are created for the bills from 01-01-2021 till the current date.

You can generate the entity hold detail report from the user interface or through a batch process in the Excel format. We have shipped the following entity hold detail reports in this release:

- **FOPHLDBXLS** - Used when you want to generate the entity hold detail report through the **C1-RPTGN** batch in the Excel format.
- **FOPHLDOXLS** - Used when you want to generate the entity hold detail report from the user interface in the Excel format.

Invoice Aging Report

The **Invoice Aging** report enables you to view the invoices which are due for payment in different age buckets. At a time, it enables you to view the invoice aging data of all customers which belong to a particular division. While generating the invoice aging report, you can specify the following parameters – Start Date, End Date, and Division. The start date and division are mandatory. If you do not specify the end date, the system by default sets it to the system date. While generating the invoice aging report, the system does the currency conversion when the accounts' invoice currency is different from the customer's division currency.

You can generate the invoice aging report from the user interface or through a batch process in the PDF format. We have shipped the following invoice aging reports in this release:

- **FOPAGEBPDF** - Used when you want to generate the invoice aging report through the **C1-RPTGN** batch in the PDF format.
- **FOPAGEOPDF** - Used when you want to generate the invoice aging report from the user interface in the PDF format.

Payment Detail Report

The **Payment Detail** report enables you to view the payment details of an account. At a time, it enables you to view the payments made for the accounts of all customers which belong to a particular division. While generating the payment detail report for the financial services domain, you can specify the following parameters – Division, Start Date, and End Date. The division and start date are mandatory. If you do not specify the end date, the system by default sets it to the system date. The payments are shown in the payment currency.

You can generate the payment detail report from the user interface or through a batch process in the PDF format. We have shipped the following payment detail reports for the financial services domain in this release:

- **FOPPAYDTBPDF** - Used when you want to generate the payment detail report through the **C1-RPTGN** batch in the PDF format.
- **FOPPAYDTPDF** - Used when you want to generate the payment detail report from the user interface in the PDF format.

Payment Summary Report

The **Payment Summary** report enables you to view the total payment made via a tender type. At a time, it enables you to view the total payments made via a tender type for each customer which belongs to a particular division. While generating the payment summary report for the financial services domain, you can specify the following parameters – Division, Start Date, and End Date. The division and start date are mandatory. If you do not specify the end date, the system by default sets it to the system date. The payment total is shown in the customer's division currency. While generating the payment summary report, the system does the currency conversion when the payment currency is different from the customer's division currency.

You can generate the payment summary report from the user interface or through a batch process in the PDF format. We have shipped the following payment summary reports for the financial services domain in this release:

- **FOPPAYSMBPDF** - Used when you want to generate the payment summary report through the **C1-RPTGN** batch in the PDF format.
- **FOPPAYSMPDF** - Used when you want to generate the payment summary report from the user interface in the PDF format.

Transaction Rejection Detail Report

The **Transaction Rejection Detail** report enables you to view the details of the transactions which are in the **Error** or **Ignored** status. At a time, it enables you to view the error and ignored transactions of all accounts which belong to a particular division. While generating the transaction rejection detail report, you can specify the following parameters – Start Date, End Date, Division, and Transaction Header. The start date and division are mandatory. If you do not specify the end date, the system by default sets it to the system date.

You can generate the transaction rejection detail report from the user interface or through a batch process in the Excel format. We have shipped the following transaction rejection detail reports in this release:

- **FOPTRDTBXLS** - Used when you want to generate the transaction rejection detail report through the **C1-RPTGN** batch in the Excel format.
- **FOPTRDTOXLS** - Used when you want to generate the transaction rejection detail report from the user interface in the Excel format.

Transaction Rejection Summary Report

The **Transaction Rejection Summary** report enables you to view the number of transactions mapped to a particular account and price item combination which are in the **Error** or **Ignored** status. At a time, it enables you to view the error and ignored transaction summary of all accounts which belong to a particular division. While generating the transaction rejection summary report, you can specify the following parameters – Start Date, End Date, Division, and Transaction Header. The start date and division are mandatory. If you do not specify the end date, the system by default sets it to the system date.

You can generate the transaction rejection summary report from the user interface or through a batch process in the Excel format. We have shipped the following transaction rejection summary reports in this release:

- **FOPTRSMBXLS** - Used when you want to generate the transaction rejection summary report through the **C1-RPTGN** batch in the Excel format.
- **FOPTRSMOXLS** - Used when you want to generate the transaction rejection summary report from the user interface in the Excel format.

To Do Report

The **To Do** report enables you to view the notifications (i.e. To Dos) assigned to a user and its current status. While generating the To Do report, you can specify the following parameters – Start Date, End Date, To Do Type, To Do Type Description, Assigned User, Created By, Status, Operator, and To Do Age. The start date is mandatory. If you do not specify the end date, the system by default sets it to the system date. For example, if you specify the start date as 06-01-2022 and To Do type as C1-ACCL, the system will extract all To Dos which are created using the C1-ACCL

To Do type from 06-01-2022 till the current date. While filtering the data using the To Do age, you need to specify the operator along with the To Do age. The system supports the following operators: Greater Than (>), Less Than (<), Less Than Equal To (<=), Greater Than Equal To (>=), and Equal To (=). For example, if you specify the start date as 06-01-2022, To Do age as 50, and operator as >, the system will extract all To Dos which are open in the system since more than 50 days.

You can generate the To Do report from the user interface or through a batch process in the PDF format. We have shipped the following To Do reports in this release:

- **FOPTODOBPDF** - Used when you want to generate the To Do report through the **C1-RPTGN** batch in the PDF format.
- **FOPTODOOPDF** - Used when you want to generate the To Do report from the user interface in the PDF format.

User Access Report

The **User Access** report enables you to view the permissions granted to different users for accessing the data. While generating the user access report, you can specify the following parameters – User Group, User Group Description, To Do Role, and To Do Role Description.

You can generate the user access report from the user interface in the PDF format. We have shipped the following user access report in this release:

- **FOPUSROPDF** - Used when you want to generate the user access report from the user interface in the PDF format.

Quick Response Code Generation

A Quick Response (QR) code is a type of matrix barcode (or two-dimensional barcode). A barcode is a machine-readable optical label that can contain information about the item to which it is attached. Oracle Revenue Management and Billing provides a QR code generator using which you can generate a QR code. At the moment, the QR code is only supported for the FOP reports which are generated in the PDF format. You can define dataset for the QR string using which you want to generate the QR code. You can insert a QR code on any page in the Portable Document Format (PDF) file.

To insert a QR code in an FOP report, you need to add QR related code snippets in the respective XSL file. Only then, the system will insert the QR code when you generate the FOP report in the PDF format.

Chapter

55

Invoice Extract in UBL Format

Topics:

- [Prerequisites](#)
- [C1-InvoiceChargeExtract Business Service](#)
- [C1-UBLBILEX Algorithm](#)
- [C1-UBLINVOICEEXTRACT Extract Template](#)
- [UBL Format](#)
- [Field Mapping for UBL Format](#)
- [Sample Invoice Extract in the UBL Format](#)

Oracle Revenue Management and Billing provides the capability to extract the invoices in the Universal Business Language (UBL) format. UBL is a structured XML format which contains all the information but in a defined and fixed structure. The invoice extract in UBL format simplifies the process of sending and receiving invoices internationally through an electronic standard to different e-invoicing systems, thereby reducing the data entry cost and manual data entry errors.

A new algorithm type named **C1-UBLBILEX** is introduced in this release. If you want to extract the invoice in the UBL 2.1 format, you need to attach the **C1-UBLBILEX** algorithm to the **Bill Extract Method** algorithm spot of the required bill route type. In this algorithm, you need to specify the extract template using which you want to extract the invoice data in the UBL format. An out-of-box invoice extract template named **C1-UBLINVOICEEXTRACT** is shipped with the product. You can specify either the out-of-box invoice extract template or a custom invoice extract template in the algorithm parameter. This algorithm will accordingly extract the invoice data using the **C1-InvoiceChargeExtract** business service and present it as per the field mapping defined in the invoice extract template.

On executing the **POSTROUT** batch, the system will invoke the **C1-UBLBILEX** algorithm and extract the invoice data in the UBL format.

Prerequisites

To extract invoice in the UBL format, you need to do the following:

- Define the **C1_STM** feature configuration.
- Define the **C1-InvoiceChargeExtract** business service in the system.
- Define the **C1-UBLINVOICEEXTRACT** extract template in the system and associate it with the **C1-InvoiceChargeExtract** business service.
- Map the required UBL fields with the corresponding fields in the system.
- Define the **C1-UBLBILEX** algorithm using the **C1-UBLBILEX** algorithm type.
- Define the following parameters for **C1-UBLBILEX** algorithm:
 - Extract Folder
 - Dat Folder
 - External System Input String
 - Extract Template Code
- Attach the **C1-UBLBILEX** algorithm with the bill route types using the **POSTROUT** batch control.

C1-InvoiceChargeExtract Business Service

The **C1-InvoiceChargeExtract** business service is used to fetch invoice and invoice line details from the system. Information such as the payer details, invoice details, sender details, receiver details, bill segment details, bill adjustments details, and tax details are extracted using the **C1-InvoiceChargeExtract** business service. These details are further used by the **C1-UBLINVOICEEXTRACT** extract template to extract data in the UBL format.

The above mentioned data is extracted using the below given format:

```
<schema>
  <billId></billId>
  <billDate></billDate>
  <amtDueBeforeTax></amtDueBeforeTax>
  <netAmtDue></netAmtDue>
  <totalInvTaxes></totalInvTaxes>
  <billCurrency></billCurrency>
  <sender>
    <personId></personId>
    <name></name>
    <legalName></legalName>
    <emailAddress></emailAddress>
    <namePrefix></namePrefix>
    <bic></bic>
    <orgOrFi></orgOrFi>
    <orgidType></orgidType>
    <orgidNum></orgidNum>
    <address1></address1>
    <address2></address2>
    <address3></address3>
    <address4></address4>
    <city></city>
    <state></state>
    <postal></postal>
    <country></country>
  </sender>
  <receiver>
```

```

<personId></personId>
<name></name>
<legalName></legalName>
<emailAddress></emailAddress>
<namePrefix></namePrefix>
<bic></bic>
<orgOrFi></orgOrFi>
<orgidType></orgidType>
<orgidNum></orgidNum>
<bban></bban>
<iban></iban>
<acctLvl></acctLvl>
<accountId></accountId>
<taxRegResident></taxRegResident>
<address1></address1>
<address2></address2>
<address3></address3>
<address4></address4>
<city></city>
<state></state>
<postal></postal>
<country></country>
</receiver>
<invoiceDetails>
  <invoicelineDtls>
    <invoiceLine>
      <unitPrice></unitPrice>
      <lineType></lineType>
      <lineNumber></lineNumber>
      <id></id>
      <descr></descr>
      <amount></amount>
      <invoiceQuantity></invoiceQuantity>
    </invoiceLine>
  </invoicelineDtls>
  <taxDtls>
    <regionName></regionName>
    <custTaxId></custTaxId>
    <taxSettleAmt></taxSettleAmt>
    <taxLine>
      <taxIdentityType></taxIdentityType>
      <taxIdentityDescription></taxIdentityDescription>
      <lineNumber></lineNumber>
      <chargeAmount></chargeAmount>
    </taxLine>
  </taxDtls>
</invoiceDetails>
</schema>

```

Related Topics

For more information on...	See...
C1-UBLINVOICEEXTRACT extract template	C1-UBLINVOICEEXTRACT Extract Template on page 4290

C1-UBLBILEX Algorithm

The **C1-UBLBILEX** algorithm is invoked when the **POSTROUT** batch is executed within the ORMB system. It selects the bills attached to the associated bill route types for extraction in the UBL format.

The **C1-UBLBILEX** algorithm contains the following parameters:

Parameter	Description	Mandatory (Yes or No)
Extract Folder	Used to indicate the location where the invoice extract file is saved in the XML format.	Yes
Dat Folder	Used to save the path of the invoice extract file for the external system.	Yes
External System Input String	Used to indicate the location of the path from where the external system will fetch the extracted file in the XML format.	Yes
Extract Template Code	Used to indicate the template using which the invoice is extracted in the UBL format.	Yes

Note: Apart from the above mentioned parameters, few additional contextual parameters such as **accountId**, **acctNbr**, **personId**, and **personIdNbr** are added to the parameter list and passed to the extract utility by the algorithm internally. The user should not specify these parameters while defining the **C1-UBLBILEX** algorithm.

C1-UBLINVOICEEXTRACT Extract Template

The **C1-UBLINVOICEEXTRACT** extract template is used to extract invoice details in the Universal Business Language (UBL) 2.1 XML format. It uses the **C1-InvoiceChargeExtract** business service to fetch the person details, bill segments, adjustments, and tax details with respect to the bills attached to the respective bill route types associated with the **C1-UBLBILEX** algorithm.

The **C1-UBLINVOICEEXTRACT** extract template has the following three types of field mappings:

- Fields Starting with **IN** - Indicates the initial fields which are used as an input to fetch details corresponding to the **C1-InvoiceChargeExtract** business service.
- Fields Starting with **OUT_INV** - Indicates the extracted fields which contains the invoice information.
- Fields Starting with **OUT_INV_LIN** - Indicates the extracted fields which contains the invoice line information.

The **C1-UBLINVOICEEXTRACT** extract template is mapped in the system as shown in the below table:

Extract Template Field Name	Source Xpath	Target Xpath	Parameters/ Default Values
IN_ACCOUNT_ID	-	ubl:Invoice/accountId	PARAM(accountId)
IN_ACCT_NBR	-	ubl:Invoice/acctNbr	PARAM(acctNbr)
IN_BILLID_IC	C1-InvoiceChargeExtract/ billId	Invoice/InvoiceCharge/billId2	PARAM(billId)
IN_PERSON_ID	-	ubl:Invoice/personId	PARAM(personId)
IN_PER_ID_NUM	-	ubl:Invoice/personIdNbr	PARAM(personIdNbr)
OUT_INV_CURRENCY_CODE	C1-InvoiceChargeExtract/ billCurrency	ubl:Invoice/ cbc:DocumentCurrencyCode	-
OUT_INV_CURRENCY_PYBLAMT	C1-InvoiceChargeExtract/ billCurrency	ubl:Invoice/ cac:LegalMonetaryTotal/ cbc:PayableAmount/currency	-
OUT_INV_CUSTADDR1	C1-InvoiceChargeExtract/ receiver/address1	ubl:Invoice/cbc:custAdd1	-

Extract Template Field Name	Source Xpath	Target Xpath	Parameters/ Default Values
OUT_INV_CUSTADDR2	C1-InvoiceChargeExtract/receiver/address2	ubl:Invoice/cbc:custAdd2	-
OUT_INV_CUSTADDR3	C1-InvoiceChargeExtract/receiver/address3	ubl:Invoice/cbc:custAdd3	-
OUT_INV_CUSTCITY	C1-InvoiceChargeExtract/receiver/city	ubl:Invoice/cbc:custCity	-
OUT_INV_CUSTCOUNTRY	C1-InvoiceChargeExtract/receiver/country	ubl:Invoice/cbc:custCountry	-
OUT_INV_CUSTMORNAME	C1-InvoiceChargeExtract/receiver/legalName	ubl:Invoice/cac:AccountingCustomerParty/cac:Party/cac:PartyName/cbc:Name	-
OUT_INV_CUSTPOSTAL	C1-InvoiceChargeExtract/receiver/postal	ubl:Invoice/cbc:custPostal	-
OUT_INV_CUSTSTATE	C1-InvoiceChargeExtract/receiver/state	ubl:Invoice/cbc:custState	-
OUT_INV_ID	-	ubl:Invoice/cbc:ID	SCRIPT([IN_BILLID_IC==" IN_BILLID_IC=="0'], {ERROR(90003,282,IN_BILLID
OUT_INV_INVOICETYPECODE		ubl:Invoice/cbc:InvoiceTypeCode	STANDARD
OUT_INV_ISSUEDT	C1-InvoiceChargeExtract/billDate	ubl:Invoice/cbc:IssueDate	-
OUT_INV_CURRENCY_TAX	C1-InvoiceChargeExtract/billCurrency	ubl:Invoice/cac:TaxTotal/cbc:TaxAmount/currencyID	-
OUT_INV_TAXTOTAL	C1-InvoiceChargeExtract/totalInvTaxes	ubl:Invoice/cac:TaxTotal/cbc:TaxAmount	-
OUT_INV_LIN_AMT	C1-InvoiceChargeExtract/invoicelineDtls/amount	ubl:Invoice/cac:InvoiceLine/cbc:LineExtensionAmount	-
OUT_INV_LIN_CURRENCY_AMOUNT	C1-InvoiceChargeExtract/billCurrency	ubl:Invoice/cac:InvoiceLine/cbc:LineExtensionAmount/currency	-
OUT_INV_LIN_CURRENCY_PRICE	C1-InvoiceChargeExtract/billCurrency	ubl:Invoice/cac:InvoiceLine/cac:Price/cbc:PriceAmount/currency	-
OUT_INV_LIN_ID	C1-InvoiceChargeExtract/invoicelineDtls/lineNumber	ubl:Invoice/cac:InvoiceLine/cbc:ID	-
OUT_INV_LIN_NOTE	C1-InvoiceChargeExtract/invoicelineDtls/descr	ubl:Invoice/cac:InvoiceLine/cbc:Note	-
OUT_INV_LIN_QUANTITY	C1-InvoiceChargeExtract/invoicelineDtls/invoiceQuantity	ubl:Invoice/cac:InvoiceLine/cbc:InvoicedQuantity	-

Extract Template Field Name	Source Xpath	Target Xpath	Parameters/ Default Values
OUT_INV_LIN_UNITPRICE	C1-InvoiceChargeExtract/ invoicelineDtls/unitPrice	ubl:Invoice/cac:InvoiceLine/ cac:Price/cbc:PriceAmount	-
OUT_INV_NAMESPACE	-	ubl:Invoice/xmlns:ap	http:// www.oracle.com/ ap/invoice" xmlns:cac="urn:oasis:names:spec xmlns:cbc="urn:oasis:names:spec xmlns:ext="urn:oasis:names:spec xmlns:ubl="urn:oasis:names:spec
OUT_INV_NETAMTDUE	C1-InvoiceChargeExtract/ netDueAmt	ubl:Invoice/ cac:LegalMonetaryTotal/ cbc:PayableAmount	
OUT_INV_NOTE	C1-InvoiceChargeExtract/ receiver/name	ubl:Invoice/cbc:Note	SCRIPT((OUT_INV_PAYERFULLNAME {'CONCAT(OUT_INV_PAYERFULLNAME " OUT_INV_CUSTADDR1 " " OUT_INV_CUSTADDR2 " " OUT_INV_CUSTADDR3 " " OUT_INV_CUSTCITY " " OUT_INV_CUSTSTATE " " OUT_INV_CUSTPOSTAL " " OUT_INV_CUSTCOUNTRY) ';CONCAT(OUT_INV_CUSTADDR1 " " OUT_INV_CUSTADDR2 " " OUT_INV_CUSTADDR3 " " OUT_INV_CUSTCITY " " OUT_INV_CUSTSTATE " " OUT_INV_CUSTPOSTAL " " OUT_INV_CUSTCOUNTRY) '})
OUT_INV_PAYERFULLNAME	C1-InvoiceChargeExtract/ receiver/name	ubl:Invoice/cbc:payerFullName	-
OUT_INV_SUPPLIERNAME	C1-InvoiceChargeExtract/ sender/legalName	ubl:Invoice/ cac:AccountingSupplierParty/ cac:Party/cac:PartyName/ cbc:Name	-
OUT_INV_VERSIONID	-	ubl:Invoice/cbc:UBLVersionID	2.1

Note:

You should always create a new template or copy the existing template for additional field mapping.

You can use predefined functions/scripts to manipulate and enrich extract fields.

Related Topics

For more information on...	See...
How to map fields for the UBL format	Field Mapping for UBL Format on page 4294

UBL Format

The following code snippet illustrates how the tags are nested while receiving the invoice extract request in the UBL format:

```
<ubl:Invoice>
  <cbc:UBLVersionID></cbc:UBLVersionID>
  <cbc:InvoiceTypeCode></cbc:InvoiceTypeCode>
  <cbc:payerFullName></cbc:payerFullName>
  <cbc:custAdd1></cbc:custAdd1>
  <cbc:custAdd2></cbc:custAdd2>
  <cbc:custAdd3></cbc:custAdd3>
  <cbc:custCity></cbc:custCity>
  <cbc:custCountry></cbc:custCountry>
  <cbc:DocumentCurrencyCode></cbc:DocumentCurrencyCode>
  <cbc:IssueDate></cbc:IssueDate>
  <cbc:ID></cbc:ID>
  <cbc:Note></cbc:Note>
  <cac:AccountingCustomerParty>
    <cac:Party>
      <cac:PartyName>
        <cbc:Name></cbc:Name>
      </cac:PartyName>
    </cac:Party>
  </cac:AccountingCustomerParty>
  <cac:AccountingSupplierParty>
    <cac:Party>
      <cac:PartyName>
        <cbc:Name></cbc:Name>
      </cac:PartyName>
    </cac:Party>
  </cac:AccountingSupplierParty>
  <cac:LegalMonetaryTotal>
    <cbc:PayableAmount currency="USD"></cbc:PayableAmount>
  </cac:LegalMonetaryTotal>
  <cac:TaxTotal>
    <cbc:TaxAmount currencyID="USD"></cbc:TaxAmount>
  </cac:TaxTotal>
  <cac:InvoiceLine>
    <cac:Price>
      <cbc:PriceAmount></cbc:PriceAmount>
    </cac:Price>
    <cbc:ID></cbc:ID>
    <cbc:Note></cbc:Note>
    <cbc:LineExtensionAmount currency="USD"></cbc:LineExtensionAmount>
    <cbc:InvoicedQuantity></cbc:InvoicedQuantity>
  </cac:InvoiceLine>
  <cac:InvoiceLine>
    <cac:Price>
```

```

    <cbc:PriceAmount></cbc:PriceAmount>
  </cac:Price>
  <cbc:ID></cbc:ID>
  <cbc:Note></cbc:Note>
  <cbc:LineExtensionAmount currency="USD"></cbc:LineExtensionAmount>
  <cbc:InvoicedQuantity></cbc:InvoicedQuantity>
</cac:InvoiceLine>
</ubl:Invoice>

```

Related Topics

For more information on...	See...
Sample Invoice Extract in the UBL Format	Sample Invoice Extract in the UBL Format on page 4297

Field Mapping for UBL Format

To extract the data in the UBL format, each tag is mapped to a field as shown in the following table:

UBL Tag Name	XML Tag Name	Table	Field	Comments
ubl:Invoice	-	-	-	-
cbc:UBLVersionID	-	-	OUT_INV_VERSIONID	-
cbc:InvoiceTypeCode	-	-	OUT_INV_INVOICETYPECODE	-
cbc:payerFullName	name	CI_PER_NAME.ENTITY_NAME	OUT_INV_PAYERFULLNAME	Data in this tag is derived from the receivers contact record where the NAME_TYP_FLG is set to PRIM .
cbc:custAdd1	address1	CI_PER.ADDRESS 1	OUT_INV_CUSTADDR1	-
cbc:custAdd2	address2	CI_PER.ADDRESS 2	OUT_INV_CUSTADDR2	-
cbc:custAdd3	address3	CI_PER.ADDRESS 3	OUT_INV_CUSTADDR3	-
cbc:custCity	city	CI_PER.CITY	OUT_INV_CUSTCITY	-
cbc:custCountry	country	CI_PER.COUNTRY	OUT_INV_CUSTCOUNTRY	-
cbc:DocumentCurrencyCode	currency		OUT_INV_CURRENCYCD	-
cbc:IssueDate	billDate	CI_BILL.BILL_DT	OUT_INV_ISSUEDT	-
cbc:ID	-	CI_BILL.BILL_ID	OUT_INV_ID	-

UBL Tag Name	XML Tag Name	Table	Field	Comments
cbc:Note	name	-	OUT_INV_NOTE	The data in this tag is derived from the receivers name and address details.
cac:AccountingCustomerParty		CI_PER_NAME.ENTITY_NAME	-	-
cac:Party	-	-	-	-
cac:PartyName	-	-	-	-
cbc:Name	legalName	CI_PER_NAME.ENTITY_NAME	OUT_INV_CUSTOMER_NAME	The data in this tag is derived from the receivers record where the NAME_TYP_FLG is set to LGAL.
cac:AccountingSupplierParty		CI_PER_NAME.ENTITY_NAME	-	-
cac:Party	-	-	-	-
cac:PartyName	-	-	-	-
cbc:Name	legalName	CI_PER_NAME.ENTITY_NAME	OUT_INV_SUPPLIER_NAME	The data in this tag is derived from the senders record where the NAME_TYP_FLG is set to LGAL.
cac:LegalMonetaryTotal		-	-	-
cbc:PayableAmount	netAmtDue	-	OUT_INV_NETAMTDUE	The data in this tag is derived from the statement extractor.
cac:TaxTotal	-	-	-	-
cbc:TaxAmount	totalInvTaxes	-	OUT_INV_TAXTOTAL	-
currencyID	billCurrency	-	OUT_INV_CURRENCY-TAX	-
cac:InvoiceLine	-	-	-	-

UBL Tag Name	XML Tag Name	Table	Field	Comments
cac:Price	-	-	-	-
cbc:PriceAmount	unitPrice	-	OUT_INV_LIN_UNITPRICE	The data in this tag is derived from the statement extractor.
cbc:ID	lineNumber	-	OUT_INV_LIN_ID	The data in this tag is derived from the statement extractor.
cbc:Note	descr	-	OUT_INV_LIN_NOTE	The data in this tag is derived from the statement extractor.
cbc:LineExtensionAmount	amount	-	OUT_INV_LIN_AMT	The data in this tag is derived from the statement extractor.
cbc:InvoicedQuantity	invoiceQuantity	-	OUT_INV_LIN_QUANTITY	The data in this tag is derived from the statement extractor.
currency	billCurrency	CI_ACCT.CURRENCY	OUT_INV_CURRENCY-PYBLAMT	
cbc:custPostal	postal	CI_PER.POSTAL	OUT_INV_CUSTPOSTAL	
cbc:custState	state	CI_PER.STATE	OUT_INV_CUSTSTATE	
currency	billCurrency	CI_ACCT.CURRENCY	OUT_INV_LIN_CURRENCY_LINEOUTAMT	
xmlns:ap	-	-	OUT_INV_NAMESPACE	
accountId	-	-	IN_ACCOUNT_ID	-
acctNbr	-	-	IN_ACCT_NBR	-
InvoiceCharge	-	-	-	-
billId2	billId	-	IN_BILLID_IC	-
personId	-	-	IN_PERSON_ID	-
personIdNbr	-	-	IN_PER_ID_NUM	-

Related Topics

For more information on...	See...
C1-UBLINVOICEEXTRACT Extract Template	C1-UBLINVOICEEXTRACT Extract Template on page 4290

Sample Invoice Extract in the UBL Format

The below example shows the invoice extract in the UBL format:

```
<ubl:Invoice xmlns:ap="http://www.oracle.com/ap/invoice"

xmlns:ubl="urn:oasis:names:specification:ubl:schema:xsd:Invoice-2">
  <cbc:UBLVersionID>2.1</cbc:UBLVersionID>
  <cbc:InvoiceTypeCode>STANDARD</cbc:InvoiceTypeCode>
  <cbc:payerFullName>Primus Group</cbc:payerFullName>
  <cbc:custAdd1>Primus House</cbc:custAdd1>
  <cbc:custAdd2>105/8</cbc:custAdd2>
  <cbc:custAdd3>Market Street</cbc:custAdd3>
  <cbc:custCity>San Francisco</cbc:custCity>
  <cbc:custCountry>USA</cbc:custCountry>
  <cbc:DocumentCurrencyCode>USD</cbc:DocumentCurrencyCode>
  <cbc:IssueDate>31-10-2022</cbc:IssueDate>
  <cbc:ID>522290826723</cbc:ID>
  <cbc:Note>Primus Group Primus House 105/8 Market Street San Francisco CA 94103
USA</cbc:Note>
  <cac:AccountingCustomerParty>
    <cac:Party>
      <cac:PartyName>
        <cbc:Name>Primus Group Ltd.</cbc:Name>
      </cac:PartyName>
    </cac:Party>
  </cac:AccountingCustomerParty>
  <cac:AccountingSupplierParty>
    <cac:Party>
      <cac:PartyName>
        <cbc:Name>Senate Bank Ltd.</cbc:Name>
      </cac:PartyName>
    </cac:Party>
  </cac:AccountingSupplierParty>
  <cac:LegalMonetaryTotal>
    <cbc:PayableAmount currency="USD">5640.00</cbc:PayableAmount>
  </cac:LegalMonetaryTotal>
  <cac:TaxTotal>
    <cbc:TaxAmount currencyID="USD">440</cbc:TaxAmount>
  </cac:TaxTotal>
  <cac:InvoiceLine>
    <cac:Price>
      <cbc:PriceAmount>11</cbc:PriceAmount>
    </cac:Price>
    <cbc:ID>1</cbc:ID>
    <cbc:Note>Ancillary Service Fees</cbc:Note>
    <cbc:LineExtensionAmount currency="USD">4400.00</cbc:LineExtensionAmount>
    <cbc:InvoicedQuantity>400</cbc:InvoicedQuantity>
  </cac:InvoiceLine>
  <cac:InvoiceLine>
    <cac:Price>
      <cbc:PriceAmount>0</cbc:PriceAmount>
    </cac:Price>
    <cbc:ID>2</cbc:ID>
```

```
<cbc:Note>Adjust bill amt (used when adjusting bill from A/C portals)</
cbc:Note>
  <cbc:LineExtensionAmount currency="USD">800.00</cbc:LineExtensionAmount>
  <cbc:InvoicedQuantity>0</cbc:InvoicedQuantity>
</cac:InvoiceLine>
</ubl:Invoice>
```

Related Topics

For more information on...	See...
C1-InvoiceChargeExtract Business Service	C1-InvoiceChargeExtract Business Service on page 4288

Appendix

A

Most Commonly Used Tasks

Topics:

- [Changing the Layout](#)

This section lists some of the common tasks that are performed while using various functionality in the application.

Changing the Layout

You can change the layout of the zone by:

- [Removing a Column from the Zone](#) on page 4300
- [Adding a Column to the Zone](#) on page 4300
- [Rearranging Columns in the Zone](#) on page 4300

Adding a Column to the Zone

Once you have removed the columns from the zone, you can add them back to the zone. To add a column to the zone:

1. Click the **Column Configuration** () icon in the upper right corner of the zone.

A panel appears at the bottom of the zone with a list of column names.

Note: The column names with the white background in the panel are currently not displayed in the zone.

2. Drag and drop the column name from the panel to the location where you want to add the column in the zone.
The white background of the column name in the panel changes to the grey background indicating that the column is currently displayed in the zone.
3. If you want to add another column name from the panel to the zone, repeat the second step. Click the **Refresh** button, data will be displayed to the columns added in the zone.

Related Topics

For more information on...	See...
How to change the layout of the zone	Changing the Layout on page 4300

Rearranging Columns in the Zone

You can change the order in which the columns are displayed in the zone. To change the position of a column in the zone:

1. Click the column name whose position you want to change in the zone.
2. Drag and drop the column name between the columns where you want to place the selected column.

The position of the column changes in the zone.

Related Topics

For more information on...	See...
How to change the layout of the zone	Changing the Layout on page 4300

Removing a Column from the Zone

To remove a column from the zone:

Click the **Delete** () icon corresponding to the column name that you want to remove from the zone.

The column is removed from the zone and is currently displayed with white background in the panel.

Note: Alternatively you can remove the column from the zone by clicking the Delete (🗑️) icon corresponding to the column name in the panel.

Related Topics

For more information on...	See...
How to change the layout of the zone	Changing the Layout on page 4300

Appendix

B

Administration

Topics:

- [UI Maps](#)
- [Feature Configurations](#)

This section lists some of the administrative tasks.

UI Maps

This section explains how to create the UI maps for viewing and modifying data of the business objects within the approval workflow group.

Creating Display UI Map for an Approval Workflow Group

The system provides you with the ability to automatically generate a Display UI map, and associate it with the approval workflow group. Alternatively, you can create a Display UI map manually, and attach it to the approval workflow group.

Procedure

To create a Display UI map manually:

1. Click the **Admin** link in the **Application** toolbar.
A list appears.
2. From the **Admin** menu, select **U** and then click **UI Map**.
A sub-menu appears.
3. Click the **Search** option from the **UI Map** sub-menu.
The **UI Map** screen appears.
4. In the **Main** tab, enter the name and description of the Display UI map.

Note: The system uses the CM_<Approval Workflow Group Code>_AppTxn_Display naming convention while automatically generating a Display UI map. Therefore, do not use this naming convention while creating a Display UI map manually.

5. Select **Complete HTML Document** from the **UI Map Type** list.
6. Click the **Schema** tab.
The **Schema** tab appears.
7. Add the following schema in the **Scheme Editor** zone:

```
<schema>
  <<Business Object Name> type="group">
    <includeBO name="<Business Object Name>" />
  </<Business Object Name>>
</schema>
```

In the above schema, you must replace <Business Object Name> with the name of the business object. For example, if you want to create a Display UI map for account, you must use the following schema:

```
<schema>
  <account type="group">
    <includeBO name="Account" />
  </account>
</schema>
```

8. Click the **Save** link in the **Actions/Navigation** area.
The **Display Only** and **Input Map** buttons are enabled on the dashboard.
9. Click the **Display Only** button.
The HTML code is generated in the **HTML Editor** zone.
10. Click the **Save** link in the **Actions/Navigation** area.
The changes are saved.

Related Topics

For more information on...	See...
How to define an approval workflow group	Defining an Approval Workflow Group on page 832
How to edit an approval workflow group	Editing an Approval Workflow Group on page 841

Creating Input UI Map for an Approval Workflow Group

The system provides you with the ability to automatically generate an Input UI map, and associate it with the approval workflow group. Alternatively, you can create an Input UI map manually, and attach it to the approval workflow group.

Procedure

To create an Input UI map manually:

1. Click the **Admin** link in the **Application** toolbar.
A list appears.
2. From the **Admin** menu, select **U** and then click **UI Map**.
A sub-menu appears.
3. Click the **Search** option from the **UI Map** sub-menu.
The **UI Map** screen appears.
4. In the **Main** tab, enter the name and description of the Input UI map.

Note: The system uses the CM_<Approval Workflow Group Code>_AppTxn_Input naming convention while automatically generating an Input UI map. Therefore, do not use this naming convention while creating an Input UI map manually.

5. Select **Complete HTML Document** from the **UI Map Type** list.
6. Click the **Schema** tab.
The **Schema** tab appears.
7. Add the following schema in the **Scheme Editor** zone:

```
<schema>
  <approvalTransactionId/>
  <action/>
  <<Business Object Name> type="group">
    <includeBO name="<Business Object Name>" />
  </<Business Object Name>>
</schema>
```

In the above schema, you must replace <Business Object Name> with the name of the business object. For example, if you want to create an Input UI map for account, you must use the following schema:

```
<schema>
  <approvalTransactionId/>
  <action/>
  <account type="group">
    <includeBO name="Account" />
  </account>
</schema>
```

The `<approvalTransactionId/>` tag is used in the schema to retrieve the approval transaction ID of the respective business object. The `<action/>` tag is used in the schema to retrieve the action performed by the submitter.

- Click the **Save** link in the **Actions/Navigation** area.

The **Display Only** and **Input Map** buttons are enabled on the dashboard.

- Click the **Input Map** button.

The HTML code is generated in the **HTML Editor** zone.

- Add the following tag in the head tag:

```
<script language="javascript" type="text/javascript" src="code/
approvalWorkflow.js"></script>
```

- Add the text highlighted in bold within the tag as shown below:

```
<td>
<input onClick="performAction('<Approval Workflow Group Code>');"
oraMdLabel="SAVE_BTN_LBL" class="oraButton" type="button">
<input onClick="oraSubmitMap('CANCEL', false);" oraMdLabel="CANCEL_LBL"
class="oraButton" type="button">
</td>
```

In the above HTML code, you must replace `<Approval Workflow Group Code>` with the code of the approval workflow group for which you are creating a UI map.

- Click the **Save** link in the **Actions/Navigation** area.

The changes are saved.

Related Topics

For more information on...	See...
How to define an approval workflow group	Defining an Approval Workflow Group on page 832
How to edit an approval workflow group	Editing an Approval Workflow Group on page 841

Feature Configurations

This section explains how to set various feature configurations which are required for implementing various features in Oracle Revenue Management and Billing.

Setting the C1_ACCTINFO Feature Configuration

Prerequisites

To set the **C1_ACCTINFO** feature configuration, you should have:

- Account Type characteristic type defined in the application (where the characteristic entity is set to Account)
- Invoice Group Account characteristic type defined in the application (where the characteristic entity is set to Account)

Procedure

To set the **C1_ACCTINFO** feature configuration:

- Click the **Admin** link in the **Application** toolbar.

A list appears.

- From the **Admin** menu, select **F** and then click **Feature Configuration**.

A sub-menu appears.

- Click the **Search** option from the **Feature Configuration** sub-menu.

The **Feature Configuration Query** screen appears.

- In the **Feature Configuration Search** zone, enter **C1_ACCTINFO** in the **Feature Name** field.

Note: ORMB search engine supports wildcard search, where you can substitute the percentage (%) symbol as a stand in for any word or letter in a search criteria. You can use the ‘%’ wildcard character in all input fields except the date and ID fields. The ‘%’ wildcard character is suffixed automatically at the end of the partial search criteria. Therefore, you may or may not specify the wildcard character at the end of the partial search criteria. However, you have to prefix the wildcard character manually wherever required.

- Click **Search**.

A list of feature configurations that meet the search criteria appears in the search results.

- In the **Search Results** section, click the link in the **Description** column corresponding to the feature configuration whose details you want to edit.

The **Feature Configuration** screen appears. It contains the following option types:

Option Type	Description	Mandatory (Yes or No)
Account Type	Used to specify the characteristic type. This characteristic type is used to define the type of account in the Account screen.	Yes
	Note: By default, the C1_F_ATY characteristic type is specified. If you want to use account types other than the ones defined in the C1_F_ATY characteristic type, you need to create a new predefined characteristic type and add the required account types as its characteristic values. Then, specify the newly created characteristic type as the value for this option type.	
Invoice Group Account	Used to specify the characteristic type. This characteristic type is used to indicate whether the account is a master or member account in the Account screen.	Yes
	Note: By default, the C1_F_IGA characteristic type is specified. If you want to use any other characteristic type other than C1_F_IGA , you need to create a new predefined characteristic type and add two characteristic values — Y and N. Then, specify the newly created characteristic type as the value for this option type.	

- Enter the values for the required option types in the **Feature Configuration** screen.
- Click the **Save** button in the **Page Title** area.

The changes made to the feature configuration are saved.

Related Topics

For more information on...	See...
Invoicing Group	Invoicing Group on page 249

Setting the C1_AXENTITY Feature Configuration

The **C1_AXENTITY** feature configuration enables you to configure various settings related to the **Approval Workflow** feature.

Prerequisites

To set the **C1_AXENTITY** feature configuration, you should have:

- An algorithm defined using the **C1-APPTXN** algorithm type in the application
- To Do types defined in the application
- Fields defined in the application
- XSL files that you want to use for the Input and Display UI maps

Procedure

To set the **C1_AXENTITY** feature configuration:

1. Click the **Admin** link in the **Application** toolbar.
A list appears.
2. From the **Admin** menu, select **F** and then click **Feature Configuration**.
A sub-menu appears.
3. Click the **Search** option from the **Feature Configuration** sub-menu.
The **Feature Configuration Query** screen appears.
4. In the **Feature Configuration Search** zone, enter **C1_AXENTITY** in the **Feature Name** field.

Note: ORMB search engine supports wildcard search, where you can substitute the percentage (%) symbol as a stand in for any word or letter in a search criteria. You can use the ‘%’ wildcard character in all input fields except the date and ID fields. The ‘%’ wildcard character is suffixed automatically at the end of the partial search criteria. Therefore, you may or may not specify the wildcard character at the end of the partial search criteria. However, you have to prefix the wildcard character manually wherever required.

5. Click **Search**.
A list of feature configurations that meet the search criteria appears in the search results.
6. In the **Search Results** section, click the link in the **Description** column corresponding to the feature configuration whose details you want to edit.

The **Feature Configuration** screen appears. It contains the following option types:

Option Type	Description	Mandatory (Yes or No)
Approval Transaction Compare New or Missing Entry Color	Used to indicate the color in which you want to highlight the new record or new additions made to the existing record. This helps in comparing the existing and new data while reviewing an approval transaction.	Yes
	Note: You must specify a hexadecimal value for this option type.	

Option Type	Description	Mandatory (Yes or No)
Approval Transaction Compare Value Changed Color	<p>Used to indicate the color in which you want to highlight the modifications made to the existing data. This helps in comparing the existing and new data while reviewing an approval transaction.</p> <p>Note: You must specify a hexadecimal value for this option type.</p>	Yes
Approval Transaction Entity Access Algorithms	<p>Used to specify the algorithm which controls access to the maintenance objects based on the access group and division.</p> <p>Note: By default, the value is set to C1-APPTXN. If you create new maintenance objects and want to control the access of these new maintenance objects based on the access group and division, you have to create a custom algorithm and then attach it to this option type. In such case, you will have to define this option type twice — one with the default algorithm (that is, C1-APPTXN) and another with the custom algorithm.</p>	Yes
Approval Transaction Field Masking	<p>Used to specify the business object for masking the approval transaction field in the approval workflow group schema.</p> <p>Note: If you do not specify the business object, masking is disabled for the respective field.</p>	Yes
Approval Transaction Resolve To Do Type	<p>Used to indicate that To Do entry of the specified To Do type must be created when an approver at any level in the hierarchy rejects an approval transaction.</p> <p>Note: You must specify a To Do type which is already defined in the system.</p>	Yes
Approval Transaction screen timeout	<p>Used to indicate the time (in minutes) in which the screen timeout message should appear in the Comparison: New versus Existing screen when the system takes longer time to display an approval transaction.</p>	Yes
Disable Approval Transaction Fields in Input UI Maps	<p>Used to indicate the fields that you want to disable whenever the input UI maps are regenerated.</p> <p>Note: You must specify a field which is already defined in the application.</p>	Yes
Display Existing Panel on Left Side (Y/N)	<p>Used to indicate whether you want to view the existing or new data in the left panel while reviewing an approval transaction. The valid values are:</p> <ul style="list-style-type: none"> • Y - Used when you want the existing data to appear in the left panel of the Comparison: New versus Existing screen. • N - Used when you want the new data to appear in the left panel of the Comparison: New versus Existing screen. 	No

Option Type	Description	Mandatory (Yes or No)
	Note: If you do not specify the value for this option type, by default, it is set to N .	
Display Information String	Used to indicate whether the approval transaction information string should appear in the Comparison: New versus Existing screen when you are reviewing an approval transaction of a construct. The valid values are: <ul style="list-style-type: none"> • true • false 	Yes
Display UI XSL	Used to indicate the XSL file that you want to use while regenerating the Display UI maps.	Yes
Display only Differences of fields on UI	Used to indicate whether you want to view only those fields of a record where the data is added or updated or all fields of a record while reviewing an approval transaction. The valid values are: <ul style="list-style-type: none"> • Yes - Used when you want to view only those fields of a record where the data is added or updated in the Comparison: New versus Existing screen. • No - Used when you want to view all fields of a record in the Comparison: New versus Existing screen. 	Yes
Input UI XSL	Used to indicate the XSL file that you want to use while regenerating the Input UI maps.	Yes

7. Enter the values for the required option types in the **Feature Configuration** screen.
8. Click the **Save** button in the **Page Title** area.
The changes made to the feature configuration are saved.

Setting the C1_DIVFUNCT Feature Configuration

Procedure

To set the **C1_DIVFUNCT** feature configuration:

1. Click the **Admin** link in the **Application** toolbar.
A list appears.
2. From the **Admin** menu, select **F** and then click **Feature Configuration**.
A sub-menu appears.
3. Click the **Search** option from the **Feature Configuration** sub-menu.
The **Feature Configuration Query** screen appears.
4. In the **Feature Configuration Search** zone, enter **C1_DIVFUNCT** in the **Feature Name** field.

Note: ORMB search engine supports wildcard search, where you can substitute the percentage (%) symbol as a stand in for any word or letter in a search criteria. You can use the ‘%’ wildcard character in all input fields except the date and ID fields. The ‘%’ wildcard character is suffixed automatically at the end of the partial search criteria. Therefore, you may or may not specify the wildcard character at the end of the partial search criteria. However, you have to prefix the wildcard character manually wherever required.

5. Click **Search**.

A list of feature configurations that meet the search criteria appears in the search results.

6. In the **Search Results** section, click the link in the **Description** column corresponding to the feature configuration whose details you want to edit.

The **Feature Configuration** screen appears. It contains the following option types:

Option Type	Description	Mandatory (Yes or No)
Enforce division-specific validations	Used to indicate whether the division-specific validations must be triggered on the Person, Account and Contract screens. The valid values are: <ul style="list-style-type: none"> • Y • N 	Yes

7. Enter the values for the required option types in the **Feature Configuration** screen.

8. Click the **Save** button in the **Page Title** area.

The changes made to the feature configuration are saved.

Setting the C1-Deal Feature Configuration

The **C1-Deal** feature configuration enables you to configure various settings related to the **Deal Management** feature.

Prerequisites

To set the **C1-Deal** feature configuration, you should have:

- Required FOP based reports defined in the application

Procedure

To set the **C1-Deal** feature configuration:

1. Click the **Admin** link in the **Application** toolbar.

A list appears.

2. From the **Admin** menu, select **F** and then click **Feature Configuration**.

A sub-menu appears.

3. Click the **Search** option from the **Feature Configuration** sub-menu.

The **Feature Configuration Query** screen appears.

4. In the **Feature Configuration Search** zone, enter **C1-Deal** in the **Feature Name** field.

Note: ORMB search engine supports wildcard search, where you can substitute the percentage (%) symbol as a stand in for any word or letter in a search criteria. You can use the ‘%’ wildcard character in all input fields except the date and ID fields. The ‘%’ wildcard character is suffixed automatically at the end of the partial search criteria. Therefore, you may or may not specify the wildcard character at the end of the partial search criteria. However, you have to prefix the wildcard character manually wherever required.

5. Click **Search**.

A list of feature configurations that meet the search criteria appears in the search results.

- In the **Search Results** section, click the link in the **Description** column corresponding to the feature configuration whose details you want to edit.

The **Feature Configuration** screen appears. It contains the following option types:

Option Type	Description	Mandatory (Yes or No)
Account Limit for Online Hierarchy Creation	<p>Used to determine whether the customer hierarchy for a deal should be created in the online or deferred mode. If the number of accounts in the customer hierarchy does not exceed the account limit, the system creates the corresponding prospect persons and accounts for the deal immediately and then changes the status of the deal to Pending Simulation. However, if the number of accounts in the customer hierarchy exceeds the account limit, the status of the deal is changed to Hierarchy Creation Deferred.</p> <p>Note: This option type is considered when a deal is created for an existing customer or prospect with the simulation type set to Customer. You must specify a value greater than or equal to zero. On executing the C1_HRC batch, the system checks whether there are any deals in the Hierarchy Creation Deferred status. If so, the system creates the corresponding prospect persons and accounts for the deal and then changes the status of the deal to Pending Simulation. For more information about the batch, see <i>Oracle Revenue Management and Billing Batch Guide</i>.</p>	Yes
Footnote Character for Terms & Conditions in Deal Extract	Used to specify a special character which you want to use while inserting terms and conditions of a price item or hierarchy entity as footnotes in the deal extract report. For example, *, \$, &, #, etc.	Yes
Deal Comparison Report	<p>Used to specify the FOP based report using which you want to extract the deal comparison report in the Excel format.</p> <p>Note: You can set the value of this option type to DCMR or to any custom FOP based report which is designed to show the deal comparison report in the Excel format.</p>	Yes
Company Logo File Name for Deal Extract	Used to specify the company logo file that you want to embed while extracting the deal information in the PDF format for the customer review and acceptance.	Yes

Option Type	Description	Mandatory (Yes or No)
	<p>Note:</p> <p>You must upload the specified company logo file in the required FOP based report using which you want to extract the deal information in the PDF format. It is then stored at the following location:</p> <pre>/scratch/rmbbuild/spl/INSTALL_DIR/splapp/reporting/xsl/</pre> <p>Here, you must specify a file name along with the extension.</p>	
Price Item Status Characteristic Type	<p>Used to indicate the characteristic type where the status of a price item is stored. This characteristic type is defined for a price item. The system uses this characteristic type while deriving active price items in the price item hierarchy of an existing customer or account in a deal. Here, you must specify a characteristic type where the characteristic entity is set to Price Item.</p> <p>Note: The C1-DLPIS characteristic type is shipped with the product.</p>	Yes
Default Period in Deal Dashboard and Deal Approver Dashboard	<p>Used to specify the duration in months. The system calculates the default period considering the specified duration and system date, and accordingly shows the details for the default period in:</p> <ul style="list-style-type: none"> • Deal Metrics, Deal Statistics, Deal To Dos, and Search Deal zones of the Deal Dashboard screen • Deal Metrics, Deal To Dos and Search Deal zones of the Deal Approver Dashboard screen <p>For example, if the system date is 07-11-2021 and the value for this option type is set to 12, then the system displays the following information in the respective zone of the Deal Dashboard screen on 07-11-2021:</p> <ul style="list-style-type: none"> • Deal Metrics - Indicates number of deals which are created, pending for approval, ready for finalization, pending for client acceptance, won, and rejected between Aug 2020 to July 2021. • Deal Statistics - Graphically represents the number of deals of an existing customer, existing account, and prospect in a particular status. • Deal To Dos - Lists the To Dos which are created between Aug 2020 to July 2021. • Search Deals - Lists deals where start date fall between Aug 2020 to July 2021. 	Yes
Deal Profitability Report	<p>Used to specify the FOP based report using which you want to extract the deal profitability report in the Excel format.</p>	Yes

Option Type	Description	Mandatory (Yes or No)
	<p>Note: You can set the value of this option type to DLPRTXLR or to any custom FOP based report which is designed to show the deal profitability report in the Excel format.</p>	
Deal External Report in Excel	<p>Used to specify the FOP based report using which you want to extract the deal information in the Excel format for the customer review and acceptance.</p> <p>Note: You can set the value of this option type to DEEEXCEL or to any custom FOP based report which is designed to show the deal information to the customer in the Excel format.</p>	Yes
Deal External Report in PDF	<p>Used to specify the FOP based report using which you want to extract the deal information in the PDF format for the customer review and acceptance.</p> <p>Note: You can set the value of this option type to DEEPDF or to any custom FOP based report which is designed to show the deal information to the customer in the PDF format.</p>	Yes
Deal Internal Report in Excel	<p>Used to specify the FOP based report using which you want to extract the deal information in the Excel format for the internal review.</p> <p>Note: You can set the value of this option type to DEIEXCEL or to any custom FOP based report which is designed to show the deal information to the internal user in the Excel format.</p>	Yes
Deal Internal Report in PDF	<p>Used to specify the FOP based report using which you want to extract the deal information in the PDF format for the internal review.</p> <p>Note: You can set the value of this option type to DEIPDF or to any custom FOP based report which is designed to show the deal information to the internal user in the PDF format.</p>	Yes
Validate Average Price Against Proposed Price List Pricing	<p>Used to indicate whether the average price of a price item in a deal should be validated against the proposed price list pricing. The valid values are:</p> <ul style="list-style-type: none"> • Y - Indicates that the average price of a price item in a deal should be validated against the proposed price list pricing. • N - Indicates that the average price of a price item in a deal should be validated against the eligible price list pricing. 	Yes

Option Type	Description	Mandatory (Yes or No)
	<p>Note: This option type is considered when the Price Item Approval Required field is set to Yes in the respective deal type.</p>	
Deal Pricing and Commitments - Pagination Limit	<p>Used to specify the maximum number of records that can be displayed on filtering the data in each page of the Deal Pricing and Commitments screen.</p> <p>Note: You must specify a numeric value greater than zero.</p>	Yes
Deal Questionnaire - Pagination Limit	<p>Used to specify the number of questions that should appear in the Questionnaire page of the Deal Information screen.</p> <p>Note: You must specify a numeric value greater than zero.</p>	Yes
Refer Volume Aggregation	<p>Used to indicate whether you want to derive the following for an account in a deal from the charge and volume aggregation tables:</p> <ul style="list-style-type: none"> • Recurring and non-recurring pass through charges • Commitments from recurring and non-recurring SQL based billable charges <p>The valid values are:</p> <ul style="list-style-type: none"> • Y - Indicates that you want to extract the charges and commitments of an account from the C1_CHARGE_AGGR and C1_VOLUME_AGGR tables, respectively, while viewing the pricing and commitment details of the account. <div style="border: 1px solid black; padding: 5px; margin: 10px 0;"> <p>Note: If you want to refer the data from the C1_CHARGE_AGGR and C1_VOLUME_AGGR tables, you need to execute the PREAGGR and CSTPREAG batches before creating a deal for an existing customer or account. For more information about these batches, see <i>Oracle Revenue Management and Billing Batch Guide</i>.</p> </div> <ul style="list-style-type: none"> • N - Indicates that you want to derive the charges and commitments of an account for the deal frequency, at the runtime, while viewing the pricing and commitment details of the account. 	Yes
Thread Count for Price Item Hierarchy	<p>Used to specify the number of threads you want to spawn in parallel. It is used while deriving the price item hierarchy for an existing customer or account in a deal.</p> <p>Note: You must specify a numeric value greater than zero.</p>	Yes
Valid Period for Seasonal Pricing in Months	<p>Used to specify the maximum duration in months for which you can offer a seasonal pricing for a price item in a deal. The system then validates the end date of a seasonal pricing using the specified duration. For example, if the value for this</p>	Yes

Option Type	Description	Mandatory (Yes or No)
	option type is set to 6 and the seasonal pricing start date is 02-01-2021, then the system checks whether the end date of the seasonal pricing is not beyond 07-31-2021.	
Volume and Commitment Limit Online Simulation	<p>Used to determine whether the cost, revenue, and profitability for a deal version should be calculated in the online or deferred mode. If the proposed commitments do not exceed the specified limit, the system calculates the cost, revenue, and profitability for the deal version immediately and then changes the status of the deal and its version to Simulated. However, if the proposed commitments exceed the specified limit, the status of the deal is changed to Simulation Deferred.</p> <p>Note: You must specify a value greater than or equal to zero.</p> <p>On executing the C1_SMLD batch, the system checks whether there are any deals in the Simulation Deferred status. If so, the system calculates the cost, revenue, and profitability for the deal version and then changes the status of the deal and its version to Simulated. For more information about the batch, see <i>Oracle Revenue Management and Billing Batch Guide</i>.</p>	Yes

7. Enter the values for the required option types in the **Feature Configuration** screen.
8. Click the **Save** button in the **Page Title** area.

The changes made to the feature configuration are saved.

Setting the C1-EHRCONFIG Feature Configuration

The **C1-EHRCONFIG** feature configuration enables the system to determine the maximum number of levels that can be included in an entity hierarchy relationship. Accordingly, the system enables you to create hierarchy entities for upto one level less than the level specified in the **Maximum Hierarchy Level** option type of the **C1-EHRCONFIG** feature configuration. For example, if you set the **Maximum Hierarchy Level** option type to 5, the system allows you to create hierarchy entities for upto four levels (i.e. Level 1, Level 2, Level 3, and Level 4). The last level (i.e. Level 5) is reserved for a price item that you want to include in an entity hierarchy relationship. Therefore, you need to accordingly set the value as per the business requirements.

Procedure

To set the **C1-EHRCONFIG** feature configuration:

1. Click the **Admin** link in the **Application** toolbar.
A list appears.
2. From the **Admin** menu, select **F** and then click **Feature Configuration**.
A sub-menu appears.
3. Click the **Search** option from the **Feature Configuration** sub-menu.
The **Feature Configuration Query** screen appears.

- In the **Feature Configuration Search** zone, enter **C1-EHRCONFIG** in the **Feature Name** field.

Note: ORMB search engine supports wildcard search, where you can substitute the percentage (%) symbol as a stand in for any word or letter in a search criteria. You can use the ‘%’ wildcard character in all input fields except the date and ID fields. The ‘%’ wildcard character is suffixed automatically at the end of the partial search criteria. Therefore, you may or may not specify the wildcard character at the end of the partial search criteria. However, you have to prefix the wildcard character manually wherever required.

- Click **Search**.

A list of feature configurations that meet the search criteria appears in the search results.

- In the **Search Results** section, click the link in the **Description** column corresponding to the feature configuration whose details you want to edit.

The **Feature Configuration** screen appears. It contains the following option type:

Option Type	Description	Mandatory (Yes or No)
Maximum Hierarchy Level	Used to indicate the maximum number of levels that you want to include in an entity hierarchy relationship. Note: At present, the system supports maximum 10 levels in an entity hierarchy relationship. Therefore, you can define hierarchy entities for upto 9 levels. The last level (i.e. Level 10) is reserved for a price item that you want to include in an entity hierarchy relationship. By default, the value is set to 10. If you do not require 10 levels in an entity hierarchy relationship, you can set a lower maximum limit in this option type.	Yes

- Enter the value for the required option type in the **Feature Configuration** screen.
- Click the **Save** button in the **Page Title** area.

The changes made to the feature configuration are saved.

Related Topics

For more information on...	See...
How to define a hierarchy entity	Defining a Hierarchy Entity on page 325
How to edit a hierarchy entity	Editing a Hierarchy Entity on page 331
How to copy a hierarchy entity	Copying a Hierarchy Entity on page 334

Setting the C1_EXCHRATE Feature Configuration

Procedure

To set the **C1_EXCHRATE** feature configuration:

- Click the **Admin** link in the **Application** toolbar.
A list appears.
- From the **Admin** menu, select **F** and then click **Feature Configuration**.
A sub-menu appears.
- Click the **Search** option from the **Feature Configuration** sub-menu.

The **Feature Configuration Query** screen appears.

- In the **Feature Configuration Search** zone, enter **C1_EXCHRATE** in the **Feature Name** field.

Note: ORMB search engine supports wildcard search, where you can substitute the percentage (%) symbol as a stand in for any word or letter in a search criteria. You can use the ‘%’ wildcard character in all input fields except the date and ID fields. The ‘%’ wildcard character is suffixed automatically at the end of the partial search criteria. Therefore, you may or may not specify the wildcard character at the end of the partial search criteria. However, you have to prefix the wildcard character manually wherever required.

- Click **Search**.

A list of feature configurations that meet the search criteria appears in the search results.

- In the **Search Results** section, click the link in the **Description** column corresponding to the feature configuration whose details you want to edit.

The **Feature Configuration** screen appears. It contains the following option types:

Option Type	Description	Mandatory (Yes or No)
End Date Required for Division Override	Used to indicate whether the end date is mandatory for a division-specific exchange rate. The valid values are: <ul style="list-style-type: none"> • Y • N By default, the value of this option type is set to N .	Yes

- Enter the values for the required option types in the **Feature Configuration** screen.
- Click the **Save** button in the **Page Title** area.

The changes made to the feature configuration are saved.

Related Topics

For more information on...	See...
How to define an exchange rate	Defining an Exchange Rate on page 971
How to edit an exchange rate	Editing an Exchange Rate on page 975

Setting the C1_EXP_OVRD Feature Configuration

Procedure

To set the **C1_EXP_OVRD** feature configuration:

- Click the **Admin** link in the **Application** toolbar.
A list appears.
- From the **Admin** menu, select **F** and then click **Feature Configuration**.
A sub-menu appears.
- Click the **Search** option from the **Feature Configuration** sub-menu.
The **Feature Configuration Query** screen appears.
- In the **Feature Configuration Search** zone, enter **C1_EXP_OVRD** in the **Feature Name** field.

Note: ORMB search engine supports wildcard search, where you can substitute the percentage (%) symbol as a stand in for any word or letter in a search criteria. You can use the ‘%’ wildcard character in all input fields except the date and ID fields. The ‘%’ wildcard character is suffixed automatically at the end of the partial search criteria. Therefore, you may or may not specify the wildcard character at the end of the partial search criteria. However, you have to prefix the wildcard character manually wherever required.

5. Click **Search**.

A list of feature configurations that meet the search criteria appears in the search results.

6. In the **Search Results** section, click the link in the **Description** column corresponding to the feature configuration whose details you want to edit.

The **Feature Configuration** screen appears. It contains the following option types:

Option Type	Description	Mandatory (Yes or No)
Expire Override Switch	Used to indicate whether you want to automatically expire an agreed pricing when the agreed pricing of a person or an account without end date is overridden. The valid values are: <ul style="list-style-type: none"> • Y • N 	Yes

7. Enter the values for the required option types in the **Feature Configuration** screen.

8. Click the **Save** button in the **Page Title** area.

The changes made to the feature configuration are saved.

Setting the C1_FINTRANOP Feature Configuration

The **C1_FINTRANOP** feature configuration enables the system to determine various options which should be considered while creating billable charges, determining a price item pricing, generating bill segments, and while creating an actual bill using a trial bill.

Prerequisites

To set the **C1_FINTRANOP** feature configuration, you should have:

- Values defined for the **BIRC_OPT_TYP_FLG** lookup field

Procedure

To set the **C1_FINTRANOP** feature configuration:

1. Click the **Admin** link in the **Application** toolbar.

A list appears.

2. From the **Admin** menu, select **F** and then click **Feature Configuration**.

A sub-menu appears.

3. Click the **Search** option from the **Feature Configuration** sub-menu.

The **Feature Configuration Query** screen appears.

4. In the **Feature Configuration Search** zone, enter **C1_FINTRANOP** in the **Feature Name** field.

Note: ORMB search engine supports wildcard search, where you can substitute the percentage (%) symbol as a stand in for any word or letter in a search criteria. You can use the ‘%’ wildcard character in all input fields except the date and ID fields. The ‘%’ wildcard character is suffixed automatically at the end of the partial search criteria. Therefore, you may or may not specify the wildcard character at the end of the partial search criteria. However, you have to prefix the wildcard character manually wherever required.

5. Click **Search**.

A list of feature configurations that meet the search criteria appears in the search results.

6. In the **Search Results** section, click the link in the **Description** column corresponding to the feature configuration whose details you want to edit.

The **Feature Configuration** screen appears. It contains the following option types:

Option Type	Description	Mandatory (Yes or No)
Account Financial History Details Switch	<p>Used to indicate whether detailed or summarized information should be displayed for an account in the Account Financial History screen. The valid values are:</p> <ul style="list-style-type: none"> • Y - Used when you want to list all financial transactions of a bill, payment, or adjustment for an account in the Account Financial History screen. • N - Used when you want to summarize all financial transactions of a particular type on an entity (i.e. bill, payment, or adjustment) and display the total amount in the Account Financial History screen. <p>Note: If you do not specify the value for this option type, by default, it is set to Y.</p>	No
Allow Advance Billing of Future Dated Charges	<p>Used to indicate whether you want to use advance billing for future dated billable charges. The valid values are:</p> <ul style="list-style-type: none"> • Y • N <p>Note:</p> <p>If the Allow Advance Billing of Future Dated Charges option type is set to Y, the system considers those billable charges where the bill after date is on or before the cut-off date, irrespective whether the date of those billable charges is past or future dated.</p> <p>The Allow Advance Billing of Future Dated Charges option type should be defined only in case of non-recurring billable charges.</p> <p>By default, the value for this option type is set to N.</p>	No
Allow Caching Of Rule Based Autopay List	<p>Used to indicate whether you want to cache the rule based auto pay instructions of an account when the C1-APRULEEVL algorithm is invoked. The valid values are:</p> <ul style="list-style-type: none"> • Y 	No

Option Type	Description	Mandatory (Yes or No)
	<ul style="list-style-type: none"> • N <p>Note: If you do not specify the value for this option type, by default, it is set to N.</p>	
Allow non-significant zero amount FT GL entry	<p>Used to indicate whether you want to allow non-significant zero amount FT GL entries in the system. The valid values are:</p> <ul style="list-style-type: none"> • Y • N <p>Note: The FT GL amount is considered significant only when the statistical and total amount are non-zero.</p>	<p>Yes (Conditional)</p> <p>Note: This data is required when you want to allow non-significant zero amount FT GL entries in the system.</p>
Avoid internal match event creation for zero dollar Bill	<p>Used to indicate whether you want to consider a zero balance bill for offsetting against another bills in an offset request. The valid values are:</p> <ul style="list-style-type: none"> • Y • N <p>Note: If you set this option type to Y, the system does not match the credit and debit line items internally of a zero balance bill on the bill completion. If you set this option type to N, the system matches the credit and debit line items internally of a zero balance bill on the bill completion.</p>	<p>Yes (Conditional)</p> <p>Note: This data is required when you want to consider a zero balance bill for offsetting against another bills in an offset request.</p>
Avoid Pricing Crawling if Rate Schedule present at Contract	<p>Used to indicate that the system should not determine the price item pricing using the price assignment search algorithm (which is attached on the account's division) when the effective rate schedule is present on the contract. The valid values are:</p> <ul style="list-style-type: none"> • Y • N <p>Note: If you do not specify the value for this option type, by default, it is set to N.</p>	No
Bill Segment Regeneration on Freeze	<p>Used to indicate whether you want to regenerate the bill segments before freezing them. The valid values are:</p> <ul style="list-style-type: none"> • Y • N 	No

Option Type	Description	Mandatory (Yes or No)
	<p>Note:</p> <p>If you do not specify the value for this option type, by default, it is set to N.</p> <p>If the Freeze and Complete option is selected for the respective window period in the bill cycle and the Bill Segment Regeneration on Freeze option type is set to Y, then the bill segments are regenerated and the status of the bill segments is set to Frozen. However, if the Freeze and Complete option is not selected for the respective window period in the bill cycle, then the bill segments are always regenerated irrespective of whether the Bill Segment Regeneration on Freeze option type is set to Y or N.</p>	
Billable Charges Date - Non Recurring	<p>Used to indicate whether you want to consider the non-recurring billable charges whose start or end date is earlier than or equal to the cut-off date. The valid values are:</p> <ul style="list-style-type: none"> • S - Used when you want to consider the non-recurring billable charges whose start date is earlier than or equal to the cut-off date. • E - Used when you want to consider the non-recurring billable charges whose end date is earlier than or equal to the cut-off date. <p>Note:</p> <p>If you do not specify the value for this option type, by default, it is set to S.</p> <p>The system always considers the recurring billable charges whose start date is earlier than the cut-off date and end date is later than the cut-off date irrespective of whether the Billable Charges Date option type is set to S or E.</p>	No
Billable Charges Date - Recurring	<p>Used to indicate whether you want to consider the recurring billable charges whose start or end date is earlier than or equal to the cut-off date. The valid values are:</p> <ul style="list-style-type: none"> • S - Used when you want to consider the recurring billable charges whose start date is earlier than or equal to the cut-off date. • E - Used when you want to consider the recurring billable charges whose end date is earlier than or equal to the cut-off date. <p>Note: If you do not specify the value for this option type, by default, it is set to S.</p>	No
Catch Up Flag For Recurring Charges	Used to indicate whether you want to consider the recurring billable charges for catch up. The valid values are:	Yes (Conditional)

Option Type	Description	Mandatory (Yes or No)
	<ul style="list-style-type: none"> • Y - Used when you want to consider the recurring billable charges for catch up during the bill generation process, where the billable charge end date is earlier than the billable charge cut-off date. • N - Used when you do not want to consider the recurring billable charges for catch up during the bill generation process, where the billable charge end date is earlier than the billable charge cut-off date. 	<p>Note: This data is required when you want to catch up with the recurring billable charges before the bill generation process.</p>
Defer Bill Segment Freeze	<p>Used to indicate whether you want to defer the freezing process of bill segments until the bill routing and due date calculation is completed. The valid values are:</p> <ul style="list-style-type: none"> • Y - Used when you want the system to freeze the bill segment after the bill routing and bill due date calculation is completed. • N - Used when you do not want the system to freeze the bill segment after the bill routing and bill due date calculation is completed. <p>Note: This flag is only considered for freezing the bill once the bill's status is set to Complete.</p>	<p>Yes (Conditional)</p> <p>Note: This data is required when you want to defer the freezing process of bill segments until the bill routing and due date calculation is completed.</p>
Hide Debt Class Details On Account Main Page	<p>Used to indicate whether you want to hide the debt class details in the Main tab of the Account screen. The valid values are:</p> <ul style="list-style-type: none"> • Y - Used when you want the system to hide the debt class details in the Main tab of the Account screen. • N - Used when you want the system to populate the debt class details in the Main tab of the Account screen. 	<p>Yes (Conditional)</p> <p>Note: This data is required when you want to hide the debt class details in the Main tab of the Account screen.</p>
Rate Component Step Optimization	<p>Used to indicate whether you want to determine the rate for all tiering ranges of a step tiered rate component or for only those tiering ranges of a step tiered rate component till when the quantity is exhausted. The valid values are:</p> <ul style="list-style-type: none"> • Y - Used when you want to determine the rate for only those tiering ranges of a step tiered rate component till when the quantity is exhausted. It helps to improve the performance of the billing batches. If you set this option type to Y, always ensure that you define the price components with the tiering ranges in the ascending order. • N - Used when you want to determine the rate for all tiering ranges of a step tiered rate component. <p>Note: If you do not specify the value for this option type, by default, it is set to N.</p>	<p>No</p>
Refund/Write-Off Flush Counter	<p>Used to specify the value for flush counter when the refund or write-off details are defined.</p>	<p>Yes (Conditional)</p>

Option Type	Description	Mandatory (Yes or No)
	<p>Note:</p> <p>You must specify a numeric value greater than zero.</p> <p>If the total number of refund or write-off records are equal to the flush counter, the system then performs a flush and clear at session level.</p>	<p>Note: This data is required when you are defining the refund or write-off details in the system.</p>
Skip Priceitem Contract Type Validation	<p>Used to indicate whether you want to skip the price item's and billable charge's contract's contract type validation. The valid values are:</p> <ul style="list-style-type: none"> • Y - Used when you want to create a billable charge for a price item on the contract which is created using a contract type to which the price item is not associated. • N - Used when you want to create a billable charge for a price item on the contract which is created using a contract type to which the price item is associated. <p>Note: If you do not specify the value for this option type, by default, it is set to N.</p>	No
Trial Bill Characteristics Conversion	<p>Used to indicate whether you want to copy the trial bill's characteristics when an actual bill is created using a trial bill. The valid values are:</p> <ul style="list-style-type: none"> • Y • N <p>Note: If you do not specify the value for this option type, by default, it is set to N.</p>	No

7. Enter the values for the required option types in the **Feature Configuration** screen.
 8. Click the **Save** button in the **Page Title** area.
- The changes made to the feature configuration are saved.

Setting the C1_FM Feature Configuration

Procedure

To set the **C1_FM** feature configuration:

1. Click the **Admin** link in the **Application** toolbar.
A list appears.
2. From the **Admin** menu, select **F** and then click **Feature Configuration**.
A sub-menu appears.
3. Click the **Search** option from the **Feature Configuration** sub-menu.
The **Feature Configuration Query** screen appears.
4. In the **Feature Configuration Search** zone, enter **C1_FM** in the **Feature Name** field.

Note: ORMB search engine supports wildcard search, where you can substitute the percentage (%) symbol as a stand in for any word or letter in a search criteria. You can use the ‘%’ wildcard character in all input fields except the date and ID fields. The ‘%’ wildcard character is suffixed automatically at the end of the partial search criteria. Therefore, you may or may not specify the wildcard character at the end of the partial search criteria. However, you have to prefix the wildcard character manually wherever required.

5. Click **Search**.

A list of feature configurations that meet the search criteria appears in the search results.

6. In the **Search Results** section, click the link in the **Description** column corresponding to the feature configuration whose details you want to edit.

The **Feature Configuration** screen appears. It contains the following option types:

Option Type	Description	Mandatory (Yes or No)
First Batch in Transaction Aggregation Cycle	Used to specify the first mandatory batch that you want to be executed in the transaction aggregation cycle.	Yes
	Note: At present, the system does not support any value other than C1-TXNIP for this option type.	
Last Batch in Transaction Aggregation Cycle	Used to specify the last mandatory batch that you want to be executed in the transaction aggregation cycle.	Yes
	Note: At present, the system does not support any value other than C1-TXNCU for this option type.	
Disaggregation - Price Assignment	Used to indicate whether the disaggregation request should be automatically created for a person or account when a price item is assigned to the person or account or the existing price item pricing assigned to the person or account is modified. The valid values are: <ul style="list-style-type: none"> • true • false 	No
	Note: You can use this feature when an algorithm which is created using the TXNDISAGGPRA algorithm type is attached to the Post-Processing system event of the C1_PRASGN_BO business object.	
Allow Duplicate Summary ID	Used to indicate whether the transaction legs can have duplicate summary ID while creating an aggregated billable charge using the Service Quantity Calculation (C1-TXNSQ) batch. The valid values are: <ul style="list-style-type: none"> • true • false 	No

Option Type	Description	Mandatory (Yes or No)
	<p>Note:</p> <p>If you set this option type to false, the system does not create the aggregated billable charge when one or more transaction legs have the same summary ID.</p> <p>If you do not specify the value for this option type, by default, the value is set to false.</p>	
Parallel Query Degree	<p>Used to specify the degree of parallelism that you want to use while creating chunks (i.e. work units) in various Transaction Feed Management (TFM) batches. The valid values are:</p> <ul style="list-style-type: none"> • 1 • 2 • 3 • 4 • 5 • 6 • 7 <p>Note:</p> <p>With the parallel query feature, multiple threads on the database can work together simultaneously to process a single SQL statement which is used to create chunks. This helps to improve the batch performance.</p> <p>The system calculates the number of threads on the database that can be used to execute the SQL statement by setting 2 to the power of the specified parallel query degree. For example, if you set the parallel query degree to 4, the system uses 16 (i.e. 2⁴) threads on the database to create work units.</p> <p>You must set the parallel query degree depending on the infrastructure available on the site. If you do not specify the value for this option type, by default, the parallel query degree is set to 2.</p>	No
Price Determination Description Item Batch	Used to specify the description for the batch which is used for validating the transaction and deriving the price item in the transaction aggregation cycle. For example, Validate Transaction and Derive Price Item . This description appears in the error message when the transaction aggregation batches are not executed in the specified sequence.	Yes
Remove Duplicates from Accumulated Rule Output	Used to indicate whether duplicate transaction legs must be created during the transaction aggregation cycle through the rule output accumulation process. The valid values are: <ul style="list-style-type: none"> • true • false 	No

Option Type	Description	Mandatory (Yes or No)
	Note: If you do not specify the value for this option type, by default, the value is set to false .	
Rule Output Accumulation	Used to indicate whether the system should accumulate the output parameters of all rules where the criteria returns Rule Is True irrespective of whether the rule true action is set to Next Dependent , Next Rule by Priority , or Success and then create transaction legs using the accumulated output parameters. The valid values are: <ul style="list-style-type: none"> • true • false Note: If you do not specify the value for this option type, by default, the value is set to false .	No
Show Default Values in Price Item Pricing	Used to indicate whether the default values must appear in the Ignore Transaction , Aggregate Transaction , and Aggregation Schedule fields while defining the price item pricing. The valid values are: <ul style="list-style-type: none"> • Y • N 	Yes
Use Materialized Views	Used to indicate whether the price item pricing information must be cached in the CI_PRC_AGRD , CI_PRC_PL , and CI_PRC_INH_PL tables. The valid values are: <ul style="list-style-type: none"> • true • false 	Yes
Maximum Price Item Parameters Cache Size	Used to indicate the maximum number of price items whose parameter information can be cached in the memory.	Yes
Maximum Price Item Parameter Groups Cache Size	Used to indicate the maximum number of price item parameter groups whose information can be cached in the memory.	Yes
SQ Recalculation Required	Used to indicate whether the SQIs in an aggregated billable charge must be recalculated while executing the C1-TXNCU batch. The valid values are: <ul style="list-style-type: none"> • Y • N Note: If you do not specify the value for this option type or if you set the value to N , the system will not recalculate the SQIs in an aggregated billable charge.	No
Transaction Detail Account Validation	Used to indicate whether the account must be validated during the transaction validation process. The valid values are: <ul style="list-style-type: none"> • Y • N 	No

Option Type	Description	Mandatory (Yes or No)
	<p>Note:</p> <p>If you set this option type to N, the system overrides the transaction's account identifier type, account identifier, and division with the first derived account's account identifier type, account identifier, and division, respectively.</p> <p>If you do not specify the value for this option type, the system will validate the account during the transaction validation process.</p>	
Populate Summary Table Batch Description	Used to specify the description for the batch which is used for adding a summary record in the CI_TXN_DTL_PRITM_SUMMARY table. For example, Populate CI_TXN_DTL_PRITM_SUMMARY Table . This description appears in the error message when the transaction aggregation batches are not executed in the specified sequence.	Yes (Conditional) Note: This data is required when the Use C1-TXNPS During Transaction Aggregation option type is set to true .
Find Price Item Pricing Batch Description	Used to specify the description for the batch which is used for finding the price item pricing for transactions in the transaction aggregation cycle. For example, Price Item Pricing Verification . This description appears in the error message when the transaction aggregation batches are not executed in the specified sequence.	Yes
Update Transaction Status Batch Description	Used to specify the description for the batch which is used for updating the status of the transactions (for which the error has occurred) in the transaction aggregation cycle. For example, Update Status . This description appears in the error message when the transaction aggregation batches are not executed in the specified sequence.	Yes
Service Quantity Calculation Batch Description	Used to specify the description for the batch which is used for creating the billable charges for transactions in the transaction aggregation cycle. For example, Service Quantity Calculation . This description appears in the error message when the transaction aggregation batches are not executed in the specified sequence.	Yes
Transaction Completion Batch Description	Used to specify the description for the batch which is used for updating the status of the transactions in the transaction aggregation cycle. For example, Mark Completion . This description appears in the error message when the transaction aggregation batches are not executed in the specified sequence.	Yes
Cleanup Unwanted Data Batch Description	Used to specify the description for the batch which is used for updating or deleting billable charges created for transactions in the transaction aggregation cycle. For example, Clean Up . This description appears in the error message when	Yes

Option Type	Description	Mandatory (Yes or No)
	the transaction aggregation batches are not executed in the specified sequence.	
Use C1-TXNPS During Transaction Aggregation	<p>Used to indicate whether you want to use an alternative transaction aggregation process when the aggregation ratio is low. The valid values are:</p> <ul style="list-style-type: none"> • true • false <p>Note: If you set this option type to true, you need to execute the following batches in the specified order in the transaction aggregation cycle:</p> <ol style="list-style-type: none"> 1. Flush All Caches (F1-FLUSH) 2. Refresh Pricing (C1-TXNRP) 3. Header Validation (C1-TXNHV) 4. Validate Transaction and Derive Price Item (C1-TXNIP) 5. Populate CI_TXN_DTL_PRITM_SUMMARY Table (C1-TXNPS) 6. Price Item Pricing Verification (C1-TXNVP) 7. Update Status (C1-TXNEX) 8. Service Quantity Calculation (C1-TXNSQ) 9. Mark Completion (C1-TXNCM) 10. Clean Up (C1-TXNCU) with the Request Type parameter set to EROR 	No

7. Enter the values for the required option types in the **Feature Configuration** screen.

8. Click the **Save** button in the **Page Title** area.

The changes made to the feature configuration are saved.

Setting the C1-INCT Feature Configuration

The **C1-INCT** feature configuration enables you to configure various settings related to the **Construct Based Billing and Settlement** feature.

Prerequisites

To set the **C1-INCT** feature configuration, you should have:

- Characteristic types defined in the application (where the characteristic entity is set to **Contract Type**)

Procedure

To set the **C1-INCT** feature configuration:

1. Click the **Admin** link in the **Application** toolbar.

A list appears.

- From the **Admin** menu, select **F** and then click **Feature Configuration**.

A sub-menu appears.

- Click the **Search** option from the **Feature Configuration** sub-menu.

The **Feature Configuration Query** screen appears.

- In the **Feature Configuration Search** zone, enter **C1-INCT** in the **Feature Name** field.

Note: ORMB search engine supports wildcard search, where you can substitute the percentage (%) symbol as a stand in for any word or letter in a search criteria. You can use the ‘%’ wildcard character in all input fields except the date and ID fields. The ‘%’ wildcard character is suffixed automatically at the end of the partial search criteria. Therefore, you may or may not specify the wildcard character at the end of the partial search criteria. However, you have to prefix the wildcard character manually wherever required.

- Click **Search**.

A list of feature configurations that meet the search criteria appears in the search results.

- In the **Search Results** section, click the link in the **Description** column corresponding to the feature configuration whose details you want to edit.

The **Feature Configuration** screen appears. It contains the following option types:

Option Type	Description	Mandatory (Yes or No)
Settlement Currency Validation Required	Used to indicate whether you want to enable or disable the linked accounts’ and settlement account’s currency validation. The valid values are: <ul style="list-style-type: none"> Y - Used when you want to validate whether the linked accounts’ currency matches the settlement account’s currency. N - Used when you do not want to validate whether the linked accounts’ currency matches the settlement account’s currency. 	No
Note: If you do not specify the value for this option type, by default, it is set to N .		
Target Contract Characteristic Type	Used to indicate the characteristic type which stores the contract type using which the contract should be created for the new invoice account when the construct is activated. This characteristic type must be defined on the usage accounts’ contract’s contract type.	Yes
Note: You must specify a characteristic type where the characteristic entity is set to Contract Type .		

- Enter the values for the required option types in the **Feature Configuration** screen.

- Click the **Save** button in the **Page Title** area.

The changes made to the feature configuration are saved.

--

Setting the C1_MASPRI Feature Configuration

Procedure

To set the **C1_MASPRI** feature configuration:

1. Click the **Admin** link in the **Application** toolbar.
A list appears.
2. From the **Admin** menu, select **F** and then click **Feature Configuration**.
A sub-menu appears.
3. Click the **Search** option from the **Feature Configuration** sub-menu.
The **Feature Configuration Query** screen appears.
4. In the **Feature Configuration Search** zone, enter **C1_MASPRI** in the **Feature Name** field.

Note: ORMB search engine supports wildcard search, where you can substitute the percentage (%) symbol as a stand in for any word or letter in a search criteria. You can use the ‘%’ wildcard character in all input fields except the date and ID fields. The ‘%’ wildcard character is suffixed automatically at the end of the partial search criteria. Therefore, you may or may not specify the wildcard character at the end of the partial search criteria. However, you have to prefix the wildcard character manually wherever required.

5. Click **Search**.
A list of feature configurations that meet the search criteria appears in the search results.
6. In the **Search Results** section, click the link in the **Description** column corresponding to the feature configuration whose details you want to edit.
The **Feature Configuration** screen appears. It contains the following option types:

Option Type	Description	Mandatory (Yes or No)
Thread Count	Used to specify the number of threads you want to spawn in parallel. It is used while creating a batch job for a mass pricing update request using the C1-GENRQ batch control.	Yes
Thread Pool Name	Used to specify the thread pool on which you want to execute the batch. It is used while creating a batch job for a mass pricing update request using the C1-GENRQ batch control.	Yes

7. Enter the values for the required option types in the **Feature Configuration** screen.
8. Click the **Save** button in the **Page Title** area.
The changes made to the feature configuration are saved.

Related Topics

For more information on...	See...
How to generate a batch job for a mass pricing update request	Generating a Batch Job for a Mass Pricing Update Request on page 2345

Setting the C1_MLTCURACC Feature Configuration

The **C1_MLTCURACC** feature configuration enables you to configure various settings related to the **Multi-Currency Accounts** feature.

Prerequisites

To set the **C1_MLTCURACC** feature configuration, you should have:

- Adjustment types and adjustment cancel reasons defined in the application

Procedure

To set the **C1_MLTCURACC** feature configuration:

1. Click the **Admin** link in the **Application** toolbar.
A list appears.
2. From the **Admin** menu, select **F** and then click **Feature Configuration**.
A sub-menu appears.
3. Click the **Search** option from the **Feature Configuration** sub-menu.
The **Feature Configuration Query** screen appears.
4. In the **Feature Configuration Search** zone, enter **C1_MLTCURACC** in the **Feature Name** field.

Note: ORMB search engine supports wildcard search, where you can substitute the percentage (%) symbol as a stand in for any word or letter in a search criteria. You can use the ‘%’ wildcard character in all input fields except the date and ID fields. The ‘%’ wildcard character is suffixed automatically at the end of the partial search criteria. Therefore, you may or may not specify the wildcard character at the end of the partial search criteria. However, you have to prefix the wildcard character manually wherever required.

5. Click **Search**.

A list of feature configurations that meet the search criteria appears in the search results.

6. In the **Search Results** section, click the link in the **Description** column corresponding to the feature configuration whose details you want to edit.

The **Feature Configuration** screen appears. It contains the following option types:

Option Type	Description	Mandatory (Yes or No)												
Allow Multi-Currency Accounts	<p>Used to indicate whether you want to enable the Multi-Currency Accounts feature. The valid values are:</p> <ul style="list-style-type: none"> • Y - If the Allow Multi-Currency Accounts option type is set to Y, the following fields are enabled in the respective screen: <table border="1" style="margin-left: 20px;"> <thead> <tr> <th>Screen Name</th> <th>Field Name</th> </tr> </thead> <tbody> <tr> <td>Account</td> <td>Invoice Currency</td> </tr> <tr> <td>Billable Charge</td> <td>Currency Code (for Bill Line)</td> </tr> <tr> <td>Adjustment</td> <td>Currency</td> </tr> <tr> <td>Payment Event Add</td> <td>Payment Currency</td> </tr> <tr> <td>Rate Component</td> <td>Allow Currency Conversion</td> </tr> </tbody> </table>	Screen Name	Field Name	Account	Invoice Currency	Billable Charge	Currency Code (for Bill Line)	Adjustment	Currency	Payment Event Add	Payment Currency	Rate Component	Allow Currency Conversion	No
Screen Name	Field Name													
Account	Invoice Currency													
Billable Charge	Currency Code (for Bill Line)													
Adjustment	Currency													
Payment Event Add	Payment Currency													
Rate Component	Allow Currency Conversion													

Option Type	Description	Mandatory (Yes or No)
	<ul style="list-style-type: none"> N - If the Allow Multi-Currency Accounts option type is set to N, the Invoice Currency field is disabled in the Account screen. By default, the base currency of the account's division appears in the Invoice Currency field. If the base currency is not defined for the account's division, the currency code specified in the Installation Options - Framework screen appears in the Invoice Currency field. 	
	Note: If you do not specify the value for this option type, by default, it is set to N.	
Transfer Adjustment Type	Used to specify the adjustment type using which you want to create a transfer adjustment when an amount is converted from one currency to another.	Yes (Conditional)
	Note: You must specify an adjustment type which is already defined in the system.	Note: This data is required when the Allow Multi-Currency Accounts option type is set to Y.
Reason Code for Cancelling Original Adjustment	Used to specify the reason code that you want to use while cancelling the original currency conversion adjustment.	Yes (Conditional)
	Note: You must specify an adjustment cancel reason which is already defined in the system.	Note: This data is required when the Allow Multi-Currency Accounts option type is set to Y.

- Enter the values for the required option types in the **Feature Configuration** screen.
- Click the **Save** button in the **Page Title** area.

The changes made to the feature configuration are saved.

Related Topics

For more information on...	See...
Multi-Currency Accounts feature	Multi-Currency Accounts on page 883

Setting the C1-ODBFC Feature Configuration

Procedure

To set the **C1-ODBFC** feature configuration:

- Click the **Admin** link in the **Application** toolbar.
A list appears.
- From the **Admin** menu, select **F** and then click **Feature Configuration**.
A sub-menu appears.
- Click the **Search** option from the **Feature Configuration** sub-menu.
The **Feature Configuration Search** window appears.

4. Enter **C1-ODBFC** in the **Feature Name** field.
5. Click the **Search** button corresponding to the **Feature Name** field.

The **Feature Configuration** screen appears. It contains the following option types:

Option Type	Description	Mandatory (Yes or No)
Average Record Size	Used to specify the average size of a usage record in bytes. By default, the value is set to 500. You can change the value, if required.	Yes
Billable Charge Chunk Size	Used to specify the number of billable charges you want to create in each work unit. By default, the value is set to 500. You can change the value, if required.	Yes
File Size Limit	Used to specify the size of a usage data file in bytes. By default, the value is set to 100000. You can change the value, if required.	Yes
Online Bill Creation Limit	Used to determine whether adhoc bills must be generated for a usage data file online or through the background process. If the total number of billable charges created for a usage data file exceeds the online bill creation limit, adhoc bills are generated for the usage data file through a batch process. By default, the value is set to 500. You can change the value, if required.	Yes
Staging XML Size	Used to specify the number of usage records you want to parse and map in each XML file. By default, the value is set to 500. You can change the value, if required.	Yes
Thread Count	Used to specify the number of threads you want to spawn in parallel.	No
Thread Pool Name	Used to specify the thread pool on which you want to execute the batch.	No
Transaction Limit	Used to determine whether billable charges for a usage data file must be created online or through the background process. If the total number of valid or approved records in a usage data file exceeds the transaction limit, billable charges are created for the valid or approved records through a batch process.	No
Validation Chunk Size	Used to specify the number of usage records you want to validate or revalidate in each work unit. By default, the value is set to 500. You can change the value, if required.	Yes

6. Enter the value for the option types in the **Feature Configuration** screen.
7. Click the **Save** button in the **Page Title** area.

The changes made to the feature configuration are saved.

Related Topics

For more information on...	See...
On Demand Billing	On Demand Billing on page 1171
How to upload a usage data file	Uploading a Usage Data File on page 1211
How to revalidate a usage data file	Revalidating a Usage Data File on page 1255
How to submit the valid records	Submitting a Valid Record on page 1248
How to approve the valid records	Approving a Valid Record on page 1250
How to generate adhoc bills for a usage data file	Generating Adhoc Bills for a File Group on page 1202

Setting the C1-OFFSETREQ Feature Configuration

The **C1-OFFSETREQ** feature configuration enables the system to determine whether the completed debit or credit bills of the effective child persons of the main customer (whose bill is added as the primary bill in the offset request) should be listed when you search for a bill in the offset request.

Procedure

To set the **C1-OFFSETREQ** feature configuration:

1. Click the **Admin** link in the **Application** toolbar.
A list appears.
2. From the **Admin** menu, select **F** and then click **Feature Configuration**.
A sub-menu appears.
3. Click the **Search** option from the **Feature Configuration** sub-menu.
The **Feature Configuration Query** screen appears.
4. In the **Feature Configuration Search** zone, enter **C1-OFFSETREQ** in the **Feature Name** field.

Note: ORMB search engine supports wildcard search, where you can substitute the percentage (%) symbol as a stand in for any word or letter in a search criteria. You can use the ‘%’ wildcard character in all input fields except the date and ID fields. The ‘%’ wildcard character is suffixed automatically at the end of the partial search criteria. Therefore, you may or may not specify the wildcard character at the end of the partial search criteria. However, you have to prefix the wildcard character manually wherever required.

5. Click **Search**.
A list of feature configurations that meet the search criteria appears in the search results.
6. In the **Search Results** section, click the link in the **Description** column corresponding to the feature configuration whose details you want to edit.

The **Feature Configuration** screen appears. It contains the following option type:

Option Type	Description	Mandatory (Yes or No)
Allow Offsetting Across Persons	Used to indicate whether you want to offset bills across main customer’s hierarchy. The valid values are: <ul style="list-style-type: none"> • Y - Used when you want to offset one or more bills of the main customer against one or more bills of the same or other accounts of the main customer 	Yes

Option Type	Description	Mandatory (Yes or No)
	<p>or against one or more bills of the accounts of its effective child persons.</p> <ul style="list-style-type: none"> • N - Used when you want to offset one or more bills of the main customer against one or more bills of the same or other accounts of the main customer. 	
Show Warning When Offsetting Across Person Hierarchy	<p>Used to indicate whether the system should display a warning message when a bill added for offsetting is in different person hierarchy than the base bill person hierarchy. The valid values are:</p> <ul style="list-style-type: none"> • Y - Used when you want the system to display a warning message when a bill is added for offset • N 	Yes (Conditional)
	<p>Note: If you do not specify the value for this option type, by default, it is set to N.</p>	<p>Note: This data is required when the Allow Offsetting Across Person option type is set to Y.</p>

7. Enter the value for the required option type in the **Feature Configuration** screen.

8. Click the **Save** button in the **Page Title** area.

The changes made to the feature configuration are saved.

Related Topics

For more information on...	See...
How to add a debit or credit bill to an offset request	Adding a Debit or Credit Bill to an Offset Request on page 1600

Setting the C1-PAYPORTAL Feature Configuration

Procedure

To set the **C1-PAYPORTAL** feature configuration:

1. Click the **Admin** link in the **Application** toolbar.

A list appears.

2. From the **Admin** menu, select **F** and then click **Feature Configuration**.

A sub-menu appears.

3. Click the **Search** option from the **Feature Configuration** sub-menu.

The **Feature Configuration Query** screen appears.

4. In the **Feature Configuration Search** zone, enter **C1-PAYPORTAL** in the **Feature Name** field.

Note: ORMB search engine supports wildcard search, where you can substitute the percentage (%) symbol as a stand in for any word or letter in a search criteria. You can use the ‘%’ wildcard character in all input fields except the date and ID fields. The ‘%’ wildcard character is suffixed automatically at the end of the partial search criteria. Therefore, you may or may not specify the wildcard character at the end of the partial search criteria. However, you have to prefix the wildcard character manually wherever required.

5. Click **Search**.

A list of feature configurations that meet the search criteria appears in the search results.

- In the **Search Results** section, click the link in the **Description** column corresponding to the feature configuration whose details you want to edit.

The **Feature Configuration** screen appears. It contains the following option types:

Option Type	Description	Mandatory (Yes or No)
Allow Overpayment	Used to indicate whether you want to allow overpayment against an entity while editing the payment amount. The valid values are: <ul style="list-style-type: none"> true false 	Yes
FK Reference for Bill	Used to indicate the foreign key reference which generates the information string for a bill in the Edit Payment Amount screen. Note: The C1-BLACT foreign key reference for bill is shipped with the product. You can also create a custom foreign key reference, if required.	Yes
FK Reference for Bill Segment	Used to indicate the foreign key reference which generates the information string for a bill segment in the Edit Payment Amount screen. Note: The C1-BSEG foreign key reference for bill segment is shipped with the product. You can also create a custom foreign key reference, if required.	Yes
FK Reference for Contract	Used to indicate the foreign key reference which generates the information string for a contract in the Edit Payment Amount screen. Note: The C1_F_SA foreign key reference for contract is shipped with the product. You can also create a custom foreign key reference, if required.	Yes
FK Reference for Settlement	Used to indicate the foreign key reference which generates the information string for a settlement ID in the Edit Payment Amount screen. Note: At present, no foreign key reference for settlement ID is shipped with the product. Only the settlement ID appears in the information string. You can create a foreign key reference for settlement ID and specify it in this field.	No

- Enter the values for the required option types in the **Feature Configuration** screen.
- Click the **Save** button in the **Page Title** area.

The changes made to the feature configuration are saved.

Related Topics

For more information on...	See...
How to edit the payment amount against each entity	Editing the Payment Amount on page 1495

Setting the C1_PER_REL Feature Configuration

You can define person to person relationship type sequence in the **C1_PER_REL** feature configuration. This sequence is used while searching for effective price item pricing at the parent customer level.

Procedure

To set the **C1_PER_REL** feature configuration:

1. Click the **Admin** link in the **Application** toolbar.
A list appears.
2. From the **Admin** menu, select **F** and then click **Feature Configuration**.
A sub-menu appears.
3. Click the **Search** option from the **Feature Configuration** sub-menu.
The **Feature Configuration Query** screen appears.
4. In the **Feature Configuration Search** zone, enter **C1_PER_REL** in the **Feature Name** field.

Note: ORMB search engine supports wildcard search, where you can substitute the percentage (%) symbol as a stand in for any word or letter in a search criteria. You can use the ‘%’ wildcard character in all input fields except the date and ID fields. The ‘%’ wildcard character is suffixed automatically at the end of the partial search criteria. Therefore, you may or may not specify the wildcard character at the end of the partial search criteria. However, you have to prefix the wildcard character manually wherever required.

5. Click **Search**.
A list of feature configurations that meet the search criteria appears in the search results.
6. In the **Search Results** section, click the link in the **Description** column corresponding to the feature configuration whose details you want to edit.

The **Feature Configuration** screen appears. It contains the following option types:

Option Type	Description	Mandatory (Yes or No)
Person to Person Relationship Type	Used to indicate the person to person relationship type. Note: If you want to define more than one relationship type in the feature configuration, you need to specify the sequence in which the relationship type should be considered while searching effective price item pricing at the parent customer level.	Yes

7. Enter the values for the required option types in the **Feature Configuration** screen.
8. Click the **Save** button in the **Page Title** area.

The changes made to the feature configuration are saved.

Related Topics

For more information on...	See...
Person to Person Relationship Type Sequence screen	<i>Person to Person Relationship Type Sequence</i> on page 721

Setting the C1-PLSM Feature Configuration

The **C1-PLSM** feature configuration enables you to extract the details and summary of a price list simulation in the Excel format. Two FOP based reports are shipped with the product — **PLSM_DETEXL** and **PLSM_SMRYEXL**. You can use these FOP based reports or create the custom FOP based reports to extract the data in the Excel format.

Prerequisites

To set the **C1-PLSM** feature configuration, you should have:

- Required FOP based reports defined in the application

Procedure

To set the **C1-PLSM** feature configuration:

1. Click the **Admin** link in the **Application** toolbar.
A list appears.
2. From the **Admin** menu, select **F** and then click **Feature Configuration**.
A sub-menu appears.
3. Click the **Search** option from the **Feature Configuration** sub-menu.
The **Feature Configuration Query** screen appears.
4. In the **Feature Configuration Search** zone, enter **C1-PLSM** in the **Feature Name** field.

Note: ORMB search engine supports wildcard search, where you can substitute the percentage (%) symbol as a stand in for any word or letter in a search criteria. You can use the ‘%’ wildcard character in all input fields except the date and ID fields. The ‘%’ wildcard character is suffixed automatically at the end of the partial search criteria. Therefore, you may or may not specify the wildcard character at the end of the partial search criteria. However, you have to prefix the wildcard character manually wherever required.

5. Click **Search**.
A list of feature configurations that meet the search criteria appears in the search results.
6. In the **Search Results** section, click the link in the **Description** column corresponding to the feature configuration whose details you want to edit.

The **Feature Configuration** screen appears. It contains the following option types:

Option Type	Description	Mandatory (Yes or No)
Detail Report Code Excel	Used to specify the FOP based report using which you want to extract the detailed report of a price list simulation in the Excel format.	Yes
	Note: You can set the value of this option type to PLSM_DETEXL or to any custom FOP based report which is designed to show the detailed report of a price list simulation in the Excel format.	

Option Type	Description	Mandatory (Yes or No)
Summary Report Code Excel	Used to specify the FOP based report using which you want to extract the summarized report of a price list simulation in the Excel format.	Yes
	Note: You can set the value of this option type to PLSM_SMRYEXL or to any custom FOP based report which is designed to show the summarized report of a price list simulation in the Excel format.	

- Enter the values for the required option types in the **Feature Configuration** screen.
- Click the **Save** button in the **Page Title** area.

The changes made to the feature configuration are saved.

Setting the C1_PPARM_FLG Feature Configuration

The **C1_PPARM_FLG** feature configuration enables the system to determine whether the multi parameter based pricing or variance parameter based pricing feature is enabled. For more information on how to define pricing for a price item or price item bundle based on multiple parameters, see [Multi Parameter Based Pricing](#) on page 271. For more information on how to define pricing for a price item or price item bundle based on variance parameter, see [Variance Parameter Based Pricing](#) on page 271.

Procedure

To set the **C1_PPARM_FLG** feature configuration:

- Click the **Admin** link in the **Application** toolbar.
A list appears.
- From the **Admin** menu, select **F** and then click **Feature Configuration**.
A sub-menu appears.
- Click the **Search** option from the **Feature Configuration** sub-menu.
The **Feature Configuration Query** screen appears.
- In the **Feature Configuration Search** zone, enter **C1_PPARM_FLG** in the **Feature Name** field.

Note: ORMB search engine supports wildcard search, where you can substitute the percentage (%) symbol as a stand in for any word or letter in a search criteria. You can use the ‘%’ wildcard character in all input fields except the date and ID fields. The ‘%’ wildcard character is suffixed automatically at the end of the partial search criteria. Therefore, you may or may not specify the wildcard character at the end of the partial search criteria. However, you have to prefix the wildcard character manually wherever required.

- Click **Search**.
A list of feature configurations that meet the search criteria appears in the search results.
- In the **Search Results** section, click the link in the **Description** column corresponding to the feature configuration whose details you want to edit.
The **Feature Configuration** screen appears. It contains the following option type:

Option Type	Description	Mandatory (Yes or No)
Multi Price Parameter	Used to indicate whether you want to enable the multi parameter or variance parameter based pricing feature. The valid values are: <ul style="list-style-type: none"> • True - Used when you want to enable the multi parameter based pricing feature. • False - Used when you want to enable the variance parameter based pricing feature. 	Yes

7. Enter the value for the required option type in the **Feature Configuration** screen.
8. Click the **Save** button in the **Page Title** area.

The changes made to the feature configuration are saved.

Setting the C1_PR_REC Feature Configuration

Procedure

To set the **C1_PR_REC** feature configuration:

1. Click the **Admin** link in the **Application** toolbar.
A list appears.
2. From the **Admin** menu, select **F** and then click **Feature Configuration**.
A sub-menu appears.
3. Click the **Search** option from the **Feature Configuration** sub-menu.
The **Feature Configuration Query** screen appears.
4. In the **Feature Configuration Search** zone, enter **C1_PR_REC** in the **Feature Name** field.

Note: ORMB search engine supports wildcard search, where you can substitute the percentage (%) symbol as a stand in for any word or letter in a search criteria. You can use the ‘%’ wildcard character in all input fields except the date and ID fields. The ‘%’ wildcard character is suffixed automatically at the end of the partial search criteria. Therefore, you may or may not specify the wildcard character at the end of the partial search criteria. However, you have to prefix the wildcard character manually wherever required.

5. Click **Search**.
A list of feature configurations that meet the search criteria appears in the search results.
6. In the **Search Results** section, click the link in the **Description** column corresponding to the feature configuration whose details you want to edit.

The **Feature Configuration** screen appears. It contains the following option type:

Option Type	Description	Mandatory (Yes or No)
Effective Pricing Record Set Limit	Used to specify the number of records that can be displayed in the Search Results section of the Effective Price Assignment zone. The value must be an integer and not in decimals. The maximum number of records that can be displayed are 5000.	Yes

Option Type	Description	Mandatory (Yes or No)
	Note: If you enter the value as 0 or if you do not specify the value for the Effective Pricing RecordSet Limit option type, no records will be displayed in the Search Results section.	

7. Enter the values for the required option types in the **Feature Configuration** screen.
8. Click the **Save** button in the **Page Title** area.

The changes made to the feature configuration are saved.

Related Topics

For more information on...	See...
Effective Price Assignment zone in the Pricing (Account) screen	Effective Price Assignments for Account on page 550
Effective Price Assignment zone in the Pricing (Person) screen	Effective Price Assignments for Person on page 583

Setting the C1_PRICING Feature Configuration

The **C1_PRICING** feature configuration enables the system to determine the following:

- The contract type that should be associated with a price item or price item bundle which is available for pricing.
- The priority that should be defaulted while assigning a price list to a person or an account from the user interface or through a business service.
- Whether the logs should be maintained when the **C1-GetAllAssignedPriceLists**, **C1-AssignPriceList**, **C1-GetEffectivePricing**, **C1-GetAccountRate**, **C1_PRICEASSIGN_SERVICE**, **C1-PriceAccount**, and **C1-GetPricing** business services are invoked.

Prerequisites

To set the **C1_PRICING** feature configuration, you should have:

- Contract types defined in the application

Procedure

To set the **C1_PRICING** feature configuration:

1. Click the **Admin** link in the **Application** toolbar.
A list appears.
2. From the **Admin** menu, select **F** and then click **Feature Configuration**.
A sub-menu appears.
3. Click the **Search** option from the **Feature Configuration** sub-menu.
The **Feature Configuration Query** screen appears.
4. In the **Feature Configuration Search** zone, enter **C1_PRICING** in the **Feature Name** field.

Note: ORMB search engine supports wildcard search, where you can substitute the percentage (%) symbol as a stand in for any word or letter in a search criteria. You can use the ‘%’ wildcard character in all input fields except the date and ID fields. The ‘%’ wildcard character is suffixed automatically at the end of the partial search criteria. Therefore, you may or may not specify the wildcard character at the end of the partial search criteria. However, you have to prefix the wildcard character manually wherever required.

5. Click **Search**.

A list of feature configurations that meet the search criteria appears in the search results.

6. In the **Search Results** section, click the link in the **Description** column corresponding to the feature configuration whose details you want to edit.

The **Feature Configuration** screen appears. It contains the following option types:

Option Type	Description	Mandatory (Yes or No)
Default Contract Type	Used to indicate the contract type that you want to associate with a price item or price item bundle which is available for pricing.	Yes
	Note: You must specify a contract type which is already defined in the system. You must ensure that the specified contract type is defined for all divisions in the system.	
Default Price List Priority	Used to indicate the default priority that should appear in the Price List Assignment screen when you assign a price list to a person or an account. You can then edit the priority, if required. It is also used when both the priority and priority indicator are not passed to the C1-AssignPriceList business service.	No
	Note: The value for this option type must be a positive integer.	
Enable Service Logging	Used to indicate whether you want to maintain logs when the C1-GetAllAssignedPriceLists , C1-AssignPriceList , C1-GetEffectivePricing , C1-GetAccountRate , C1_PRICEASSIGN_SERVICE , C1-PriceAccount , and C1-GetPricing business services are invoked. The valid values are: <ul style="list-style-type: none"> • True • False 	No

7. Enter the values for the required option types in the **Feature Configuration** screen.

8. Click the **Save** button in the **Page Title** area.

The changes made to the feature configuration are saved.

Related Topics

For more information on...	See...
How to define a price item or price item bundle	Defining a Price Item or Price Item Bundle on page 361

For more information on...	See...
How to edit a price item or price item bundle	Editing a Price Item or Price Item Bundle on page 413
How to copy a price item or price item bundle	Copying a Price Item or Price Item Bundle on page 394
How to assign a price list to a person	Assigning a Price List to a Person on page 513
How to assign a price list to an account	Assigning a Price List to an Account on page 510
How to assign a price list to one or more eligible persons	Assigning a Price List to One or More Eligible Persons on page 530
How to assign a price list to one or more eligible accounts	Assigning a Price List to One or More Eligible Accounts on page 528

Setting the C1_PRASNORDR Feature Configuration

The **C1_PRASNORDR** feature configuration enables the system to determine the manner in which price assignments should be searched for a global customer. For more information on how effective price item pricing is derived, see [Price Assignment Search Mechanism](#) on page 275.

Prerequisites

To set the **C1_PRASNORDR** feature configuration, you should have:

- An algorithm defined using the **C1_PRASN_PP** algorithm type in the application

Procedure

To set the **C1_PRASNORDR** feature configuration:

1. Click the **Admin** link in the **Application** toolbar.
A list appears.
2. From the **Admin** menu, select **F** and then click **Feature Configuration**.
A sub-menu appears.
3. Click the **Search** option from the **Feature Configuration** sub-menu.
The **Feature Configuration Query** screen appears.
4. In the **Feature Configuration Search** zone, enter **C1_PRASNORDR** in the **Feature Name** field.

Note: ORMB search engine supports wildcard search, where you can substitute the percentage (%) symbol as a stand in for any word or letter in a search criteria. You can use the ‘%’ wildcard character in all input fields except the date and ID fields. The ‘%’ wildcard character is suffixed automatically at the end of the partial search criteria. Therefore, you may or may not specify the wildcard character at the end of the partial search criteria. However, you have to prefix the wildcard character manually wherever required.

5. Click **Search**.
A list of feature configurations that meet the search criteria appears in the search results.
6. In the **Search Results** section, click the link in the **Description** column corresponding to the feature configuration whose details you want to edit.

The **Feature Configuration** screen appears. It contains the following option type:

Option Type	Description	Mandatory (Yes or No)
Price Assignment Algorithm	Used to specify the algorithm using which the price assignment should be searched for a global customer. Note: You must specify an algorithm which is already defined in the system.	Yes

- Enter the value for the required option type in the **Feature Configuration** screen.
- Click the **Save** button in the **Page Title** area.

The changes made to the feature configuration are saved.

Related Topics

For more information on...	See...
Pricing (Person) screen	Pricing (Person) on page 582

Setting the C1-PYREQSRT Feature Configuration

Procedure

To set the **C1-PYREQSRT** feature configuration:

- Click the **Admin** link in the **Application** toolbar.
A list appears.
- From the **Admin** menu, select **F** and then click **Feature Configuration**.
A sub-menu appears.
- Click the **Search** option from the **Feature Configuration** sub-menu.
The **Feature Configuration Query** screen appears.
- In the **Feature Configuration Search** zone, enter **C1-PYREQSRT** in the **Feature Name** field.

Note: ORMB search engine supports wildcard search, where you can substitute the percentage (%) symbol as a stand in for any word or letter in a search criteria. You can use the ‘%’ wildcard character in all input fields except the date and ID fields. The ‘%’ wildcard character is suffixed automatically at the end of the partial search criteria. Therefore, you may or may not specify the wildcard character at the end of the partial search criteria. However, you have to prefix the wildcard character manually wherever required.

- Click **Search**.
A list of feature configurations that meet the search criteria appears in the search results.
- In the **Search Results** section, click the link in the **Description** column corresponding to the feature configuration whose details you want to edit.

The **Feature Configuration** screen appears. It contains the following option types:

Option Type	Description	Mandatory (Yes or No)
Bill	Used to sort columns by the selected option type. The table fields in CI_BILL table are used to set the values for the option type Bill . It also enables sorting by order. Its valid values are:	No

Option Type	Description	Mandatory (Yes or No)
	<ul style="list-style-type: none"> Ascending Descending 	
Bill Segment	<p>Used to sort columns by the selected option type. The table fields in CI_BSEG table are used to set the values for the option type Bill Segment . It also enables sorting by order. Its valid values are:</p> <ul style="list-style-type: none"> Ascending Descending 	No
Contract	<p>Used to sort columns by the selected option type. The table fields in CI_SA table are used to set the values for the option type Contract . It also enables sorting by order. Its valid values are:</p> <ul style="list-style-type: none"> Ascending Descending 	No

Note: Above options types are configured for the **Sort By** field for sorting columns on the **Edit Payment Amount** screen.

- Enter the values for the required option types in the **Feature Configuration** screen.
- Click the **Save** button in the **Page Title** area.
The changes made to the feature configuration are saved.

Setting the C1_RLENG Feature Configuration

Procedure

To set the **C1_RLENG** feature configuration:

- Click the **Admin** link in the **Application** toolbar.
A list appears.
- From the **Admin** menu, select **F** and then click **Feature Configuration**.
A sub-menu appears.
- Click the **Search** option from the **Feature Configuration** sub-menu.
The **Feature Configuration Query** screen appears.
- In the **Feature Configuration Search** zone, enter **C1_RLENG** in the **Feature Name** field.

Note: ORMB search engine supports wildcard search, where you can substitute the percentage (%) symbol as a stand in for any word or letter in a search criteria. You can use the ‘%’ wildcard character in all input fields except the date and ID fields. The ‘%’ wildcard character is suffixed automatically at the end of the partial search criteria. Therefore, you may or may not specify the wildcard character at the end of the partial search criteria. However, you have to prefix the wildcard character manually wherever required.

- Click **Search**.
A list of feature configurations that meet the search criteria appears in the search results.

6. In the **Search Results** section, click the link in the **Description** column corresponding to the feature configuration whose details you want to edit.

The **Feature Configuration** screen appears. It contains the following option types:

Option Type	Description	Mandatory (Yes or No)
Logging Rules for Transaction Feed	Used to indicate whether a log should be generated when you execute the Transaction Validation and Initial Product Determination (C1-TXNIP) batch. The valid values are: <ul style="list-style-type: none"> • True • False 	Yes
	Note: This log indicates the rules that were executed for each transaction and whether each rule passed or failed during the execution.	
Maximum Number of Rules in Cache	Used to indicate the maximum number of rules whose entry should be created in the log file.	Yes

7. Enter the values for the required option types in the **Feature Configuration** screen.
8. Click the **Save** button in the **Page Title** area.

The changes made to the feature configuration are saved.

Related Topics

For more information on...	See...
Transaction Feed Management	Transaction Feed Management on page 983

Setting the C1-TXNDMYID Feature Configuration

For manually added transactions, the system can generate header details including the header ID automatically if you set the option types in the **C1-TXNDMYID** feature configuration.

Procedure

To set the **C1-TXNDMYID** feature configuration:

1. Click the **Admin** link in the **Application** toolbar.
A list appears.
2. From the **Admin** menu, select **F** and then click **Feature Configuration**.
A sub-menu appears.
3. Click the **Search** option from the **Feature Configuration** sub-menu.
The **Feature Configuration Query** screen appears.
4. In the **Feature Configuration Search** zone, enter **C1-TXNDMYID** in the **Feature Name** field.

Note: ORMB search engine supports wildcard search, where you can substitute the percentage (%) symbol as a stand in for any word or letter in a search criteria. You can use the ‘%’ wildcard character in all input fields except the date and ID fields. The ‘%’ wildcard character is suffixed automatically at the end of the partial search criteria. Therefore, you may or may not specify the wildcard character at the end of the partial search criteria. However, you have to prefix the wildcard character manually wherever required.

5. Click **Search**.

A list of feature configurations that meet the search criteria appears in the search results.

6. In the **Search Results** section, click the link in the **Description** column corresponding to the feature configuration whose details you want to edit.

The **Feature Configuration** screen appears. It contains the following option types:

Option Type	Description	Mandatory (Yes or No)
Dummy File Name	Used to specify the dummy file name.	Yes
Dummy Header ID	Used to specify the dummy header ID.	Yes
Dummy Transaction Source	Used to specify the dummy transaction source.	Yes
Dummy Header Date	Used to specify the dummy header date.	Yes

7. Enter the values for the required option types in the **Feature Configuration** screen.

8. Click the **Save** button in the **Page Title** area.

The changes made to the feature configuration are saved.

Related Topics

For more information on...	See...
Transaction Feed Management	Transaction Feed Management on page 983

Setting the C1-PAYFLUPLD Feature Configuration

Procedure

To set the **C1-PAYFLUPLD** feature configuration:

1. Click the **Admin** link in the **Application** toolbar.

A list appears.

2. From the **Admin** menu, select **F** and then click **Feature Configuration**.

A sub-menu appears.

3. Click the **Search** option from the **Feature Configuration** sub-menu.

The **Feature Configuration Query** screen appears.

4. In the **Feature Configuration Search** zone, enter **C1-PAYFLUPLD** in the **Feature Name** field.

Note: ORMB search engine supports wildcard search, where you can substitute the percentage (%) symbol as a stand in for any word or letter in a search criteria. You can use the ‘%’ wildcard character in all input fields except the date and ID fields. The ‘%’ wildcard character is suffixed automatically at the end of the partial search criteria. Therefore, you may or may not specify the wildcard character at the end of the partial search criteria. However, you have to prefix the wildcard character manually wherever required.

5. Click **Search**.

A list of feature configurations that meet the search criteria appears in the search results.

- In the **Search Results** section, click the link in the **Description** column corresponding to the feature configuration whose details you want to edit.

The **Feature Configuration** screen appears. It contains the following option types:

Option Type	Description	Mandatory (Yes or No)
Field Mapping for Match Type	<p>Used to specify a field mapping which is created using the Configuration for Match Type - Handling Overpayment preference category.</p> <p>Note: The system then considers this field mapping during the step-three PUPL batch execution whenever there are multiple payment records of the payee account in the CSV file. By default, the value is set to MT_CNF. You can change the value, if required. This option type is only applicable for the health insurance domain.</p>	Yes
Payment Portal Thread Count	<p>Used to specify the number of threads you want to spawn in parallel. This value is used when a batch job is automatically created for the Create Payments from Payment Staging Records (PUPL) batch.</p> <p>Note: By default, the value is set to 1. You can change the value, if required.</p>	No
Thread Pool Name	<p>Used to specify the thread pool on which you want to execute the batch. This value is used when a batch job is automatically created for the following batches:</p> <ul style="list-style-type: none"> Upload Payment Records in Pre-Staging Area (C1-PYUP1) Move Payment Records to Staging Area (C1-PYUP2) Create Payments from Payment Staging Records (PUPL) <p>Note: By default, the value is set to DEFAULT. You can change the value, if required.</p>	No

- Enter the values for the required option types in the **Feature Configuration** screen.
- Click the **Save** button in the **Page Title** area.

The changes made to the feature configuration are saved.

Setting the C1-CFS Feature Configuration

The **C1-CFS** feature configuration enables you to indicate whether the application environment should use the file object storage service of Oracle Cloud Infrastructure (OCI). If the file object storage service of OCI is used, you need to specify the buckets or containers within the Object Storage namespace from where you need to read files for the On Demand Billing and Payment Upload features. Before specifying the buckets to read files from the external location for the On Demand Billing and Payment Upload features, you need to define a file storage extendable lookup value using the **File Storage Configuration (F1-FileStorage)** extendable lookup where the file adapter is set to **Oracle Cloud Object Storage**. For more information on how to define a file storage extendable lookup value, refer to the **Oracle Utilities Application Framework Administrative Processes >> Configuration Tools >> Miscellaneous Topics >> Referencing URIs >> External File Storage** in the *Oracle Revenue Management and Billing Online Help*.

Prerequisites

To set the **C1-CFS** feature configuration, you should have:

- Required values defined in the **File Storage Configuration (F1-FileStorage)** extendable lookup

Procedure

To set the **C1-CFS** feature configuration:

1. Click the **Admin** link in the **Application** toolbar.
A list appears.
2. From the **Admin** menu, select **F** and then click **Feature Configuration**.
A sub-menu appears.
3. Click the **Search** option from the **Feature Configuration** sub-menu.
The **Feature Configuration Query** screen appears.
4. In the **Feature Configuration Search** zone, enter **C1-CFS** in the **Feature Name** field.

Note: ORMB search engine supports wildcard search, where you can substitute the percentage (%) symbol as a stand in for any word or letter in a search criteria. You can use the ‘%’ wildcard character in all input fields except the date and ID fields. The ‘%’ wildcard character is suffixed automatically at the end of the partial search criteria. Therefore, you may or may not specify the wildcard character at the end of the partial search criteria. However, you have to prefix the wildcard character manually wherever required.

5. Click **Search**.
A list of feature configurations that meet the search criteria appears in the search results.
6. In the **Search Results** section, click the link in the **Description** column corresponding to the feature configuration whose details you want to edit.

The **Feature Configuration** screen appears. It contains the following option types:

Option Type	Description	Mandatory (Yes or No)
File Object Storage Usage	Used to indicate whether the application environment should use the file object storage service of Oracle Cloud Infrastructure (OCI). The valid values are: <ul style="list-style-type: none"> • Y • N 	Yes

Option Type	Description	Mandatory (Yes or No)
	<p>Note:</p> <p>By default, the value is set to N.</p> <p>You must ensure that the value of this option type is set to N in the On Premise and Cloud Service environments.</p> <p>If the value of this option type is set to Y, you need to accordingly specify the directory paths while executing the DWLDBILC, C1-PUPSG, C1-APACK, and C1-RECUP batches. For more information, refer to the <i>Oracle Revenue Management and Billing Batch Guide</i>.</p>	
ODB Extendable Lookup and Bucket	<p>Used to specify the following information in the <File Storage Extendable Lookup Value>/<Object Storage Bucket> format:</p> <ul style="list-style-type: none"> • The file storage extendable lookup value from where the cloud storage compartment and connection details are retrieved while uploading the files through the On Demand Billing feature. • The bucket or container from where you want to upload the file using the On Demand Billing feature. <p>Note: This option type is required only when the File Object Storage Usage option type is set to Y and you want to use the On Demand Billing feature.</p>	Yes (Conditional)
Payment Upload Extendable Lookup and Bucket	<p>Used to specify the following information in the <File Storage Extendable Lookup Value>/<Object Storage Bucket> format:</p> <ul style="list-style-type: none"> • The file storage extendable lookup value from where the cloud storage compartment and connection details are retrieved while uploading the files through the Payment Upload feature. • The bucket or container from where you want to upload the file using the Payment Upload feature. <p>Note: This option type is required only when the File Object Storage Usage option type is set to Y and you want to use the Payment Upload feature.</p>	Yes (Conditional)

7. Set the **File Object Storage Usage** option type to **N**.

8. Click the **Save** button in the **Page Title** area.

The changes made to the feature configuration are saved.

Setting the C1-FLUPLD Feature Configuration

You need to set the **C1-FLUPLD** feature configuration only when you want to decrypt the encrypted files on the SFTP server while uploading and transforming the files through the **C1-FTRAN** batch. The **C1-FRDALG**

algorithm is used to decrypt the file using the keystore. Earlier, the following properties were derived from the **FW_spl.properties.keystore.truststore.include** file to generate the keystore:

- com.oracle.ouaf.system.keystore.file
- com.oracle.ouaf.system.keystore.passwordFileName
- com.oracle.ouaf.system.keystore.type
- com.oracle.ouaf.system.keystore.padding
- com.oracle.ouaf.system.keystore.mode
- com.oracle.ouaf.system.keystore.alias
- ouaf.system.fileupload.pgp.pvt.key.filepath

Prerequisites

To set the **C1-FLUPLD** feature configuration, you should have:

- Required values defined in the **File Storage Configuration (F1-FileStorage)** extendable lookup

Procedure

To set the **C1-FLUPLD** feature configuration:

1. Click the **Admin** link in the **Application** toolbar.
A list appears.
2. From the **Admin** menu, select **F** and then click **Feature Configuration**.
A sub-menu appears.
3. Click the **Search** option from the **Feature Configuration** sub-menu.
The **Feature Configuration Query** screen appears.
4. In the **Feature Configuration Search** zone, enter **C1-FLUPLD** in the **Feature Name** field.

Note: ORMB search engine supports wildcard search, where you can substitute the percentage (%) symbol as a stand in for any word or letter in a search criteria. You can use the ‘%’ wildcard character in all input fields except the date and ID fields. The ‘%’ wildcard character is suffixed automatically at the end of the partial search criteria. Therefore, you may or may not specify the wildcard character at the end of the partial search criteria. However, you have to prefix the wildcard character manually wherever required.

5. Click **Search**.
A list of feature configurations that meet the search criteria appears in the search results.
6. In the **Search Results** section, click the link in the **Description** column corresponding to the feature configuration whose details you want to edit.
The **Feature Configuration** screen appears. It contains the following option types:

Option Type	Description	Mandatory (Yes or No)
File Decryption Key Alias	Used to specify the alias using which you want to encrypt or decrypt passwords to access the keystore.	Yes
	Note: By default, the value is set to ouaf.system .	
Key Store File Path	Used to specify the directory or bucket where you want to store the keystore file. If the application environment is an On Premise or Cloud Service environment, you	Yes

Option Type	Description	Mandatory (Yes or No)
	<p>can specify the directory name along with either of the following relative paths:</p> <ul style="list-style-type: none"> • @SHARED_DIR – Used when you want to store the keystore file in the shared directory on the server. • @INSTALL_DIR – Used when you want to store the keystore file in the SPLEBASE directory which is defined in the spl.properties file. <p>For example, you can set the value to @SHARED_DIR/.ouaf_keystore or @INSTALL_DIR/.ouaf_keystore.</p> <p>However, if the application environment is a Cloud Service Premium Edition environment, you must specify the following information in the <code>file-storage://<File Storage Extendable Lookup Value>/<Object Storage Bucket></code> format:</p> <ul style="list-style-type: none"> • The file storage extendable lookup value from where the cloud storage compartment and connection details are retrieved while storing the keystore file on OCI. • The bucket or container where you want the system to store the keystore file. 	
Key Store Mode	<p>Used to specify the mode using which you want to encrypt or decrypt a keystore file.</p> <p>Note: By default, the value is set to CBC (i.e. Cipher-block Chaining).</p>	Yes
Key Store Padding	<p>Used to specify the padding using which you want to encrypt or decrypt a keystore file.</p> <p>Note: By default, the value is set to PKCS5Padding.</p>	Yes
Key Store Password File Path	<p>Used to specify the directory or bucket where you want to store the keystore password file. If the application environment is an On Premise or Cloud Service environment, you can specify the directory name along with either of the following relative paths:</p> <ul style="list-style-type: none"> • @SHARED_DIR – Used when you want to store the keystore password file in the shared directory on the server. • @INSTALL_DIR – Used when you want to store the keystore password file in the SPLEBASE directory which is defined in the spl.properties file. <p>For example, you can set the value to @SHARED_DIR/.ouaf_storepass or @INSTALL_DIR/.ouaf_storepass.</p>	Yes

Option Type	Description	Mandatory (Yes or No)
	<p>However, if the application environment is a Cloud Service Premium Edition environment, you must specify the following information in the <code>file-storage://<File Storage Extendable Lookup Value>/<Object Storage Bucket></code> format:</p> <ul style="list-style-type: none"> • The file storage extendable lookup value from where the cloud storage compartment and connection details are retrieved while storing the keystore password file on OCI. • The bucket or container where you want the system to store the keystore password file. 	
Key Store Type	<p>Used to indicate the type of keystore file that you want to create.</p> <p>Note: By default, the value is set to PKCS12.</p>	Yes
Private Key File Path	<p>Used to specify the directory or bucket where you want to store the private key file. If the application environment is an On Premise or Cloud Service environment, you can specify the directory name along with either of the following relative paths:</p> <ul style="list-style-type: none"> • @SHARED_DIR – Used when you want to store the private key file in the shared directory on the server. • @INSTALL_DIR – Used when you want to store the private key file in the SPLEBASE directory which is defined in the spl.properties file. <p>For example, you can set the value to <code>@SHARED_DIR/.ouaf_storepass</code> or <code>@INSTALL_DIR/.ouaf_storepass</code>.</p> <p>However, if the application environment is a Cloud Service Premium Edition environment, you must specify the following information in the <code>file-storage://<File Storage Extendable Lookup Value>/<Object Storage Bucket></code> format:</p> <ul style="list-style-type: none"> • The file storage extendable lookup value from where the cloud storage compartment and connection details are retrieved while storing the private key file on OCI. • The bucket or container where you want the system to store the private key file. 	Yes

7. Enter the values for the required option types in the **Feature Configuration** screen.

8. Click the **Save** button in the **Page Title** area.

The changes made to the feature configuration are saved.

Setting the C1-REPORTVW Feature Configuration

You need to set the **C1-REPORTVW** feature configuration only when you are using the Apache FOP Reporting framework in ORMB. It enables you to define the following properties which were earlier derived from the **spl.properties** file:

- ouaf.runtime.billView.directoryPath
- ouaf.runtime.reportView.directoryPath
- ouaf.application.reportingDir

Prerequisites

To set the **C1-REPORTVW** feature configuration, you should have:

- Required values defined in the **File Storage Configuration (F1-FileStorage)** extendable lookup

Procedure

To set the **C1-REPORTVW** feature configuration:

1. Click the **Admin** link in the **Application** toolbar.
A list appears.
2. From the **Admin** menu, select **F** and then click **Feature Configuration**.
A sub-menu appears.
3. Click the **Search** option from the **Feature Configuration** sub-menu.
The **Feature Configuration Query** screen appears.
4. In the **Feature Configuration Search** zone, enter **C1-REPORTVW** in the **Feature Name** field.

Note: ORMB search engine supports wildcard search, where you can substitute the percentage (%) symbol as a stand in for any word or letter in a search criteria. You can use the ‘%’ wildcard character in all input fields except the date and ID fields. The ‘%’ wildcard character is suffixed automatically at the end of the partial search criteria. Therefore, you may or may not specify the wildcard character at the end of the partial search criteria. However, you have to prefix the wildcard character manually wherever required.

5. Click **Search**.
A list of feature configurations that meet the search criteria appears in the search results.
6. In the **Search Results** section, click the link in the **Description** column corresponding to the feature configuration whose details you want to edit.

The **Feature Configuration** screen appears. It contains the following option types:

Option Type	Description	Mandatory (Yes or No)
Report Download HTTP URL	Used to specify the HTTP servlet using which you want to download and view the FOP reports that are generated in the online mode. You must specify the URL in the following format: https://ipaddress:port/ouaf/reportView	Yes
Report Generation (FOP) File Path	Used to specify the directory or bucket where you want to store the FOP reports which are generated either from the user interface or through a batch process. If the application environment is an On Premise or Cloud Service environment, you can specify the directory name along with either of the following relative paths:	Yes

Option Type	Description	Mandatory (Yes or No)
	<ul style="list-style-type: none"> • @SHARED_DIR – Used when you want to store the FOP reports in the shared directory on the server. • @INSTALL_DIR – Used when you want to store the FOP reports in the SPLEBASE directory which is defined in the spl.properties file. <p>For example, you can set the value to @SHARED_DIR/output or @INSTALL_DIR/output.</p> <p>However, if the application environment is a Cloud Service Premium Edition environment, you must specify the following information in the <code>file-storage://<File Storage Extendable Lookup Value>/<Object Storage Bucket></code> format:</p> <ul style="list-style-type: none"> • The file storage extendable lookup value from where the cloud storage compartment and connection details are retrieved while storing the FOP reports on OCI • The bucket or container where you want the system to store the FOP reports which are generated in the different formats. 	
Report Generation XSL Template File Path	<p>Used to specify the directory or bucket from where the respective XSL file should be fetched while generating the FOP report.</p> <p>If the application environment is an On Premise or Cloud Service environment, you can specify the directory name along with either of the following relative paths:</p> <ul style="list-style-type: none"> • @SHARED_DIR – Used when you want to fetch the XSL file from the shared directory on the server. • @INSTALL_DIR – Used when you want to fetch the XSL file from the SPLEBASE directory which is defined in the spl.properties file. <p>For example, you can set the value to @SHARED_DIR/xsl or @INSTALL_DIR/xsl.</p> <p>However, if the application environment is a Cloud Service Premium Edition environment, you must specify the following information in the <code>file-storage://<File Storage Extendable Lookup Value>/<Object Storage Bucket></code> format:</p> <ul style="list-style-type: none"> • The file storage extendable lookup value from where the cloud storage compartment and connection details are retrieved while fetching the XSL file for an FOP report. • The bucket or container from where you want the system to fetch the XSL file while generating the FOP report. 	Yes

Option Type	Description	Mandatory (Yes or No)
Report Generation XML Data File Path	<p>Used to specify the directory or bucket where you want to extract the data from the system in the XML format for an FOP report.</p> <p>If the application environment is an On Premise or Cloud Service environment, you can specify the directory name along with either of the following relative paths:</p> <ul style="list-style-type: none"> • @SHARED_DIR – Used when you want to store the XML file in the shared directory on the server. • @INSTALL_DIR – Used when you want to store the XML file in the SPLEBASE directory which is defined in the spl.properties file. <p>For example, you can set the value to @SHARED_DIR/extractxml or @INSTALL_DIR/extractxml.</p> <p>However, if the application environment is a Cloud Service Premium Edition environment, you must specify the following information in the file-storage://<File Storage Extendable Lookup Value>/<Object Storage Bucket> format:</p> <ul style="list-style-type: none"> • The file storage extendable lookup value from where the cloud storage compartment and connection details are retrieved while storing the XML file on OCI. • The bucket or container where you want the system to store the XML file for an FOP report. 	Yes

7. Enter the values for the required option types in the **Feature Configuration** screen.
8. Click the **Save** button in the **Page Title** area.

The changes made to the feature configuration are saved.

