

# Oracle® Exadata Database Machine

## System Overview



Release 22.1

F29255-17

September 2022

The Oracle logo, consisting of a solid red square with the word "ORACLE" in white, uppercase, sans-serif font centered within it.

ORACLE®

Oracle Exadata Database Machine System Overview, Release 22.1

F29255-17

Copyright © 2008, 2022, Oracle and/or its affiliates.

Primary Author: Peter Fusek

Contributing Authors: James Spiller

Contributors: Doug Archambault, Leo Agranonik, Andrew Babb, Nilesh Choudhury, Henry Chow, Ravindra Dani, Boris Erlikhman, Jaime Figueroa, Roger Hansen, Leslie Keller, Frank Kobylanski, René Kundersma, Sue Lee, Jennifer Leung, Yang Liu, Juan Loaiza, Barb Lundhild, Catherine Luu, Philip Newlan, Dan Norris, Michael Nowak, Bharat Paliwal, Hector Pujol, Dmitry Potapov, Darryl Presley, Ashish Ray, Richard Scales, Oliver Sharwood, Jia Shi, Kesavan Srinivasan, Mahesh Subramaniam, Krishnadev Telikicherla, Cliff Thomas, Alex Tsukerman, Shreyas Udgaonkar, Kothanda Umamageswaran, Doug Utzig, James Viscusi, Vern Wagman, Zheren Zhang, Alex Blyth

This software and related documentation are provided under a license agreement containing restrictions on use and disclosure and are protected by intellectual property laws. Except as expressly permitted in your license agreement or allowed by law, you may not use, copy, reproduce, translate, broadcast, modify, license, transmit, distribute, exhibit, perform, publish, or display any part, in any form, or by any means. Reverse engineering, disassembly, or decompilation of this software, unless required by law for interoperability, is prohibited.

The information contained herein is subject to change without notice and is not warranted to be error-free. If you find any errors, please report them to us in writing.

If this is software or related documentation that is delivered to the U.S. Government or anyone licensing it on behalf of the U.S. Government, then the following notice is applicable:

U.S. GOVERNMENT END USERS: Oracle programs (including any operating system, integrated software, any programs embedded, installed or activated on delivered hardware, and modifications of such programs) and Oracle computer documentation or other Oracle data delivered to or accessed by U.S. Government end users are "commercial computer software" or "commercial computer software documentation" pursuant to the applicable Federal Acquisition Regulation and agency-specific supplemental regulations. As such, the use, reproduction, duplication, release, display, disclosure, modification, preparation of derivative works, and/or adaptation of i) Oracle programs (including any operating system, integrated software, any programs embedded, installed or activated on delivered hardware, and modifications of such programs), ii) Oracle computer documentation and/or iii) other Oracle data, is subject to the rights and limitations specified in the license contained in the applicable contract. The terms governing the U.S. Government's use of Oracle cloud services are defined by the applicable contract for such services. No other rights are granted to the U.S. Government.

This software or hardware is developed for general use in a variety of information management applications. It is not developed or intended for use in any inherently dangerous applications, including applications that may create a risk of personal injury. If you use this software or hardware in dangerous applications, then you shall be responsible to take all appropriate fail-safe, backup, redundancy, and other measures to ensure its safe use. Oracle Corporation and its affiliates disclaim any liability for any damages caused by use of this software or hardware in dangerous applications.

Oracle, Java, and MySQL are registered trademarks of Oracle and/or its affiliates. Other names may be trademarks of their respective owners.

Intel and Intel Inside are trademarks or registered trademarks of Intel Corporation. All SPARC trademarks are used under license and are trademarks or registered trademarks of SPARC International, Inc. AMD, Epyc, and the AMD logo are trademarks or registered trademarks of Advanced Micro Devices. UNIX is a registered trademark of The Open Group.

This software or hardware and documentation may provide access to or information about content, products, and services from third parties. Oracle Corporation and its affiliates are not responsible for and expressly disclaim all warranties of any kind with respect to third-party content, products, and services unless otherwise set forth in an applicable agreement between you and Oracle. Oracle Corporation and its affiliates will not be responsible for any loss, costs, or damages incurred due to your access to or use of third-party content, products, or services, except as set forth in an applicable agreement between you and Oracle.

# Contents

## Preface

---

Audience	xvi
Documentation Accessibility	xvi
Diversity and Inclusion	xvi
Conventions	xvii

## 1 Introduction to Oracle Exadata Database Machine and Oracle Exadata Storage Expansion Rack

---

1.1 Exadata Database Machine Architecture	1-1
1.2 Exadata Database Machine Configurations	1-2
1.2.1 Elastic Configuration	1-3
1.3 Oracle Exadata Database Machine Performance Features	1-3
1.4 Oracle Exadata Rack Limits and Restrictions	1-4
1.4.1 Restrictions for Modifying Oracle Exadata Rack Hardware	1-4
1.4.2 Restrictions for Modifying the Exadata Database Machine Software Components	1-5
1.4.3 Restrictions for Connecting Exadata Database Machine with Other Hardware, Systems, or Networks	1-6
1.4.4 Maximum Number of Database Processes	1-7

## Part I What's New in Oracle Exadata Database Machine

---

## 2 New Features for Oracle Exadata System Software Release 22.x

---

2.1 What's New in Oracle Exadata Database Machine 22.1	2-1
2.1.1 Real-Time Insight	2-1
2.1.2 Oracle VM Server Management Domain Upgrade to Oracle Linux 7	2-1
2.1.3 Exadata Upgrade Improvements	2-2
2.1.4 Deprecated Features in Oracle Exadata System Software Release 22.1	2-2
2.1.4.1 Deprecation of RAM Cache	2-2
2.1.4.2 Deprecation of USB Images	2-2

## 3 New Features for Oracle Exadata System Software Release 21.x

---

3.1	What's New in Oracle Exadata Database Machine 21.2	3-1
3.1.1	Exadata Database Machine X9M Support	3-1
3.1.2	Persistent Storage Index	3-2
3.1.3	Persistent Columnar Cache	3-2
3.1.4	IORM Cluster Plan	3-3
3.1.5	Smart Scan Metadata Sharing	3-3
3.1.6	Oracle ASR Support for Cisco RoCE Network Fabric Switches and Management Network Switch	3-4
3.1.7	Patch Manager Support for the Management Network Switch	3-4
3.1.8	Options to Preserve Redundancy while Dropping a Physical Disk	3-4
3.1.9	Faster Upgrades with ILOM Pre-Staging	3-5
3.1.10	Faster Recovery from Flash Cache Failure	3-5
3.1.11	Automatic Recovery from Disk Controller Cache Failure	3-5
3.1.12	Enhanced Database Server Alerting	3-6
3.1.13	Oracle ACFS I/O Caching in Flash Cache	3-6
3.1.14	Smart Scan Fast Decryption	3-6
3.1.15	Deprecated Features in Oracle Exadata System Software Release 21.2	3-7
3.1.15.1	Deprecation of RAM Cache	3-7
3.1.15.2	Deprecation of USB Images	3-7

## 4 New Features for Oracle Exadata System Software Release 20.x

---

4.1	What's New in Oracle Exadata Database Machine 20.1.0	4-1
4.1.1	Exadata Secure RDMA Fabric Isolation	4-1
4.1.2	Smart Flash Log Write-Back	4-2
4.1.3	Fast In-Memory Columnar Cache Creation	4-3
4.1.4	Cell-to-Cell Rebalance Preserves PMEM Cache Population	4-3
4.1.5	Control Persistent Memory Usage for Specific Databases	4-3
4.1.6	Application Server Update for Management Server	4-4

## 5 New Features for Oracle Exadata System Software Release 19.x

---

5.1	What's New in Oracle Exadata Database Machine 19.3.0	5-1
5.1.1	Persistent Memory Data Accelerator	5-1
5.1.2	Persistent Memory Commit Accelerator	5-2
5.1.3	Support for Oracle Exadata X8M Systems	5-2
5.1.4	Instant Failure Detection for X8M Systems	5-3
5.1.5	KVM for Virtual Environments	5-3
5.1.6	Faster Encrypted Table Smart Scans	5-3
5.1.7	Smart Aggregation	5-4

5.1.8	Smart In-Memory Columnar Cache with Row IDs	5-4
5.1.9	Smart In-memory Columnar Cache with Chained Rows	5-5
5.1.10	Fast Smart In-memory Columnar Cache Creation	5-5
5.1.11	Encryption of System Logs to Remote Destinations	5-5
5.1.12	Update a Single SNMP User Definition	5-6
5.1.13	Securing Storage Server Software Processes with Memory Protection Keys	5-6
5.1.14	Default XFS File System for X8M Servers	5-6
5.1.15	Oracle Linux Kernel to Unbreakable Enterprise Kernel 5 and Oracle Linux Distribution Upgraded to Oracle Linux 7.7	5-6
5.1.16	Software Certification Ends for Exadata Database Machine X2 Servers	5-7
5.2	What's New in Oracle Exadata Database Machine 19.2.0	5-7
5.2.1	Support for New Hardware - X8 Servers	5-7
5.2.2	Exadata Extended (XT) Storage Server	5-8
5.2.3	Changes to IORM flashcachesize Attribute and Hard Disk I/O Limits	5-8
5.3	What's New in Oracle Exadata Database Machine 19.1.0	5-8
5.3.1	Oracle Linux Upgraded to Oracle Linux 7.5	5-9
5.3.2	Automated Cloud Scale Performance Monitoring	5-10
5.3.3	Faster Smart Scans Using Column-level Checksum	5-10
5.3.4	Enhanced OLTP High Availability During Cell Outages and Flash Failures	5-11
5.3.5	Support for Host and ILOM on Separate Network	5-12
5.3.6	DB_UNIQUE_NAME Support for Multiple Clusters Sharing Exadata Storage	5-12
5.3.7	Secure Eraser Updates	5-13
5.3.7.1	Automatic Upgrading of Multi-pass Disk Erasure to Secure Eraser	5-13
5.3.7.2	Automatic Secure Eraser as Part of Imaging	5-14
5.3.7.3	Secure Eraser Improvements and New Features	5-14
5.3.8	Server Time Synchronization Uses Chrony	5-14
5.3.9	Quorum Disk Manager Service Change	5-15
5.3.10	Audit Rules File	5-15
5.3.11	Customizable SYSLOG Format	5-15
5.3.12	USE_LARGE_PAGES Default Value Set To AUTO_ONLY	5-16
5.3.13	Security Improvements	5-16
5.3.13.1	Access Control for RESTful Service	5-16
5.3.13.2	Password Expiration for Remote Users	5-17
5.3.13.3	Advanced Intrusion Detection Environment (AIDE)	5-17
5.3.13.4	Implementing the Principle of Least Privilege to Improve Security	5-18
5.3.13.5	Increased Security for Storage Server Processes	5-18
5.3.13.6	SSHD ClientAliveInterval Changed to 600 Seconds	5-19
5.3.13.7	Stronger Password Requirements	5-19
5.3.13.8	Upload DIAGPACK to Oracle ASR Manager using HTTPs	5-20
5.3.14	Deprecated Features in Oracle Exadata System Software Release 19.1.0	5-20
5.3.14.1	Deprecation of Interleaved Grid Disks	5-20

5.3.14.2	Deprecation of nfsimg Images	5-20
5.3.15	Desupported Features in Oracle Exadata System Software Release 19.1.0	5-20

## 6 New Features for Oracle Exadata System Software Release 18

---

6.1	What's New in Oracle Exadata Database Machine 18c (18.1.0)	6-1
6.1.1	In-Memory OLTP and Consolidation Acceleration	6-1
6.1.2	In-Memory Columnar Caching on Storage Servers	6-2
6.1.3	Oracle Exadata Storage Server Cloud Scale Software Update	6-3
6.1.4	Faster Oracle Exadata Database Server Software Update	6-4
6.1.5	Improved Ethernet Performance in Oracle VM	6-4
6.1.6	Performance Improvement Following Disk Online Completion	6-4
6.1.7	Improved High Availability After Flash Failures	6-4
6.1.8	IORM Maximum Utilization Limit Applies to Flash Devices	6-5
6.1.9	OEDA Command Line Interface	6-5
6.2	Oracle Exadata Database Machine X7 New Features	6-6
6.2.1	Do Not Service LED on Storage Servers	6-6
6.2.2	Online Flash Disk Replacement for Oracle Exadata Storage Server X7	6-6
6.2.3	New Configuration for System Partitions on Storage Servers	6-7
6.2.4	Secure Boot	6-8

## 7 New Features for Oracle Exadata System Software Release 12.x

---

7.1	What's New in Oracle Exadata Database Machine 12.2.1.1.0	7-1
7.1.1	In-Memory Columnar Caching on Storage Servers	7-2
7.1.2	Columnar Flash Cache for Encrypted Tablespace	7-3
7.1.3	Set Membership in Storage Indexes	7-3
7.1.4	Storage Index to Store Column Information for More Than Eight Columns	7-3
7.1.5	5x Faster Oracle Exadata System Software Updates	7-4
7.1.6	Faster Performance for Large Analytic Queries and Large Loads	7-4
7.1.7	Secure Eraser	7-5
7.1.8	Cell-to-Cell Offload Support for ASM-Scoped Security	7-5
7.1.9	Adding an Additional Network Card to Oracle Exadata Database Machine X6-2 Database Servers	7-5
7.1.10	Automatic Diagpack Upload for Oracle ASR	7-6
7.1.11	CREATE DIAGPACK and LIST DIAGPACK Commands Available for Oracle Exadata Database Servers	7-7
7.1.12	Rescue Plan	7-7
7.1.13	Support for IPv6 Oracle VM and Tagged VLANs	7-8
7.1.14	Management Server Can Remain Online During NTP, DNS, and ILOM Changes	7-8
7.1.15	New Charts in ExaWatcher	7-8

7.1.16	New Metrics for Redo Log Writes	7-8
7.1.17	Quarantine Manager Support for Cell-to-Cell Rebalance and High Throughput Write Operations	7-9
7.1.18	ExaCLI and REST API Enabled for Management Server	7-9
7.1.19	New Features in Oracle Grid Infrastructure 12.2.1.1.0	7-9
7.1.19.1	Oracle ASM Flex Disk Groups	7-10
7.1.19.2	Oracle Flex ASM	7-10
7.1.19.3	Faster Redundancy Restoration After Storage Loss	7-10
7.1.19.4	Dynamic Power Change	7-11
7.1.19.5	Quorum Disk Support in Oracle Universal Installer	7-11
7.1.20	New Features in Oracle Database 12c Release 2 (12.2.0.1)	7-12
7.1.20.1	Database Server I/O Latency Capping	7-12
7.1.20.2	Exadata Smart Scan Offload for Compressed Index Scan	7-12
7.1.20.3	Exadata Smart Scan Offload Enhancements for In-Memory Aggregation (IMA)	7-12
7.1.20.4	Exadata Smart Scan Offload Enhancements for XML	7-13
7.1.20.5	Exadata Smart Scan Offload Enhancements for LOBs	7-13
7.1.20.6	New Features in Oracle Exadata Snapshots	7-13
7.1.21	Oracle Linux Kernel Upgraded to Unbreakable Enterprise Kernel 4 and Oracle VM Upgraded to 3.4.2	7-14
7.2	What's New in Oracle Exadata Database Machine 12c Release 1 (12.1.2.3.0)	7-14
7.2.1	Performance Improvement for Oracle Exadata System Software Updates	7-15
7.2.2	Quorum Disk Manager Utility	7-15
7.2.3	VLAN Support	7-15
7.2.4	Adaptive Scrubbing Schedule	7-16
7.2.5	IPv6 Support in ASR Manager	7-17
7.2.6	Increased Maximum Number of Database Processes	7-17
7.2.7	Cell-to-Cell Rebalance Preserves Storage Index	7-19
7.2.8	ASM Disk Size Checked When Reducing Grid Disk Size	7-19
7.2.9	Support for Alerts in CREATE DIAGPACK	7-20
7.3	What's New in Oracle Exadata Database Machine 12c Release 1 (12.1.2.2.0)	7-20
7.3.1	Smart Fusion Block Transfer	7-20
7.3.2	8 TB Hard Disk Support	7-21
7.3.3	IPv6 Support	7-21
7.3.4	Running CellCLI Commands from Compute Nodes	7-23
7.3.5	Disabling SSH on Storage Servers	7-24
7.3.6	Fixed Allocations for Databases in the Flash Cache	7-24
7.3.7	Oracle Exadata Storage Statistics in AWR Reports	7-24
7.3.8	Increased Maximum Number of Database Processes	7-25
7.3.9	Custom Diagnostic Package for Storage Server Alerts	7-26
7.3.10	Updating Nodes Using patchmgr	7-26
7.3.11	kdump Operational for 8-Socket Database Nodes	7-26

7.3.12	Redundancy Check When Powering Down the Storage Server	7-27
7.3.13	Specifying an IP Address for SNMP Traps	7-27
7.3.14	Reverse Offload Improvements	7-27
7.3.15	Cell-to-Cell Rebalance Preserves Flash Cache Population	7-28
7.4	What's New in Oracle Exadata Database Machine 12c Release 1 (12.1.2.1.2)	7-28
7.4.1	InfiniBand Partitioning for Virtualized Exadata Environments	7-28
7.5	What's New in Oracle Exadata Database Machine 12c Release 1 (12.1.2.1.1)	7-28
7.5.1	Flash Performance Improvement in X5 Storage Servers	7-29
7.5.2	Oracle Exadata Virtual Machines	7-29
7.5.3	Infrastructure as a Service (IaaS) with Capacity-on-Demand (CoD)	7-29
7.5.4	Improved Flash Cache Metrics	7-29
7.5.5	Leap Second Time Adjustment	7-29
7.5.6	Network Resource Management	7-29
7.5.7	DBMCLI Replaces /opt/oracle.cellos/comprmon/exadata_mon_hw_asr.pl Script	7-30
7.6	What's New in Oracle Exadata Database Machine 12c Release 1 (12.1.2.1.0)	7-30
7.6.1	Oracle Exadata Database Machine Elastic Configurations	7-31
7.6.2	Sparse Grid Disks	7-31
7.6.3	Snapshot Databases for Test and Development	7-31
7.6.4	Columnar Flash Caching	7-32
7.6.5	Oracle Exadata System Software I/O Latency Capping for Write Operations	7-33
7.6.6	Elimination of False Drive Failures	7-34
7.6.7	Flash and Disk Life Cycle Management Alert	7-34
7.6.8	Performance Optimization for SQL Queries with Minimum or Maximum Functions	7-34
7.6.9	Oracle Exadata Storage Server Software Performance Statistics in AWR Reports	7-35
7.6.10	Exafusion Direct-to-Wire Protocol	7-35
7.6.11	Management Server on Database Servers	7-35
7.6.12	SQL Operators for JSON and XML	7-36
7.6.13	I/O Resource Management for Flash	7-36
7.6.14	Flash Cache Space Resource Management	7-37
7.6.15	I/O Resource Management Profiles	7-37
7.6.16	Write Back Flash Cache on Extreme Flash Cells	7-37
7.6.17	Secure Erase for 1.6 TB Flash Drives in Extreme Flash and High Capacity Systems	7-38
7.6.18	Increased Exadata Cell Connection Limit	7-38
7.6.19	Support for SNMP v3	7-38
7.6.20	Federal Information Processing Standards (FIPS) 140-2 Compliant Smart Scan	7-39
7.6.21	Oracle Exadata Virtual Machines	7-40
7.7	What's New in Oracle Exadata Database Machine 12c Release 1 (12.1.1.1.1)	7-40
7.7.1	Additional SQL Operators and Conditions for LOB and CLOB	7-41



7.8	What's New in Oracle Exadata Database Machine 12c Release 1 (12.1.1.1.0)	7-41
7.8.1	Support for Oracle Database Releases 12c Release 1 (12.1) and 11g Release 2 (11.2)	7-41
7.8.2	IORM Support for CDBs and PDBs	7-42
7.8.3	Cell to Cell Data Transfer	7-43
7.8.4	Desupport of HP Oracle Database Machine Hardware	7-43

## 8 New Features for Oracle Exadata System Software Release 11.x

---

8.1	What's New in Oracle Exadata Database Machine 11g Release 2 (11.2.3.3.1)	8-1
8.1.1	Oracle Capacity-on-Demand for Database Servers	8-1
8.1.2	Exadata I/O Latency Capping	8-2
8.1.3	Oracle Exadata Storage Server I/O Timeout Threshold	8-2
8.1.4	Support for New Hardware	8-3
8.2	What's New in Oracle Exadata Database Machine 11g Release 2 (11.2.3.3.0)	8-3
8.2.1	Flash Cache Compression	8-3
8.2.2	Automatic Flash Caching for Table Scan Workloads	8-4
8.2.3	Fast Data File Creation	8-4
8.2.4	Network Resource Management	8-5
8.2.5	Active Bonding Network	8-5
8.2.6	Oracle ASM Disk Group in Appliance Mode	8-6
8.2.7	Automatic Hard Disk Scrub and Repair	8-6
8.2.8	Drop Hard Disk for Replacement	8-7
8.2.9	Drop BBU for Replacement	8-7
8.2.10	Oracle Exadata Database Machine Eighth Rack Configuration	8-8
8.2.11	Cell Alert Summary	8-8
8.2.12	Secure Erase for Larger Drives	8-9
8.2.13	Periodic ILOM Reset	8-9
8.2.14	Oracle Exawatcher Replaces Oracle OSwatcher	8-9
8.2.15	Enhancements for Hardware and Software	8-9
8.3	What's New in Oracle Exadata Database Machine 11g Release 2 (11.2.3.2)	8-10
8.3.1	Write-Back Flash Cache with Exadata Smart Flash Cache	8-11
8.3.1.1	Exadata Smart Flash Cache Persistent After Cell Restart	8-11
8.3.2	Graceful Shutdown of CELLSRV Services	8-11
8.3.3	LED Notification for Storage Server Disk Removal	8-11
8.3.4	Identification of Underperforming Disks	8-11
8.3.5	Oracle Database File System Support for Oracle Solaris	8-12
8.3.6	Health Factor for Predictive Failed Disk Drop	8-12
8.3.7	Hard Disk Drive Numbering in Servers	8-12
8.4	What's New in Oracle Exadata Database Machine 11g Release 2 (11.2.3.1)	8-13
8.4.1	Support for Oracle Solaris 11 (SRU2a)	8-14
8.4.2	Linux Database Server Updates with Unbreakable Linux Network	8-14

8.4.3	Oracle Enterprise Manager Cloud Control for Oracle Exadata Database Machine	8-14
8.4.4	I/O Resource Management Support for More Than 32 Databases	8-14
8.4.5	Oracle Database 11g Release 2 (11.2.0.3)	8-14
8.4.6	Exadata Cell Connection Limit	8-15
8.5	What's New in Oracle Exadata Database Machine 11g Release 2 (11.2.2.4)	8-15
8.5.1	Oracle Exadata Smart Flash Log	8-15
8.6	What's New in Oracle Exadata Database Machine 11g Release 2 (11.2.2.3)	8-15
8.6.1	Oracle Solaris Operating System for Database Servers	8-16
8.6.2	Exadata Secure Erase	8-16
8.6.3	Optimized Smart Scan	8-16
8.7	What's New in Oracle Exadata Database Machine 11g Release 2 (11.2.1.2)	8-17
8.7.1	Exadata Smart Flash Cache	8-17
8.7.2	Hybrid Columnar Compression	8-18
8.7.3	Storage Index	8-19
8.7.4	Smart Scan of Encrypted Data	8-19
8.7.5	Interleaved Grid Disks	8-19
8.7.6	Data Mining Scoring Offload	8-20
8.7.7	Enhanced Manageability Features	8-20
8.8	What's New in Oracle Exadata Database Machine 11g Release 2 (11.2)	8-20
8.8.1	Expanded Content in the Guide	8-21

## Part II Hardware Components

---

### 9 Hardware Components of Exadata Database Machine

---

9.1	Exadata Database Machine Hardware Components by Model	9-1
9.2	Oracle Exadata Database Server Hardware Components	9-25
9.2.1	Database Server Components of Exadata Database Machine X9M-2	9-26
9.2.2	Database Server Components of Exadata Database Machine X9M-8	9-26
9.2.3	Database Server Components of Exadata Database Machine X8M-2	9-27
9.2.4	Database Server Components of Exadata Database Machine X8M-8	9-27
9.2.5	Database Server Components of Oracle Exadata Database Machine X8-2	9-28
9.2.6	Database Server Components of Oracle Exadata Database Machine X8-8	9-28
9.2.7	Database Server Components of Oracle Exadata Database Machine X7-2	9-29
9.2.8	Database Server Components of Oracle Exadata Database Machine X7-8	9-29
9.2.9	Database Server Components of Oracle Exadata Database Machine X6-2	9-29
9.2.10	Database Server Components of Oracle Exadata Database Machine X5-2	9-30
9.2.11	Database Server Components of Oracle Exadata Database Machine X5-8 and X6-8	9-30
9.2.12	Database Server Components of Oracle Exadata Database Machine X4-2	9-31

9.2.13	Database Server Components of Oracle Exadata Database Machine X4-8 Full Rack	9-31
9.2.14	Database Server Components of Oracle Exadata Database Machine X3-2	9-31
9.2.15	Database Server Components of Oracle Exadata Database Machine X3-8 Full Rack	9-32
9.2.16	Database Server Components of Oracle Exadata Database Machine X2-2	9-32
9.2.17	Database Server Components of Oracle Exadata Database Machine X2-8 Full Rack	9-33
9.3	Oracle Exadata Storage Server Hardware Components	9-34
9.3.1	Extreme Flash Exadata Storage Server X9M-2 Hardware Components	9-35
9.3.2	High Capacity Exadata Storage Server X9M-2 Hardware Components	9-35
9.3.3	Extended Exadata Storage Server X9M-2 Hardware Components	9-36
9.3.4	Extreme Flash Exadata Storage Server X8M-2 and X8-2 Hardware Components	9-36
9.3.5	High Capacity Exadata Storage Server X8-2 and X8M-2 Hardware Components	9-37
9.3.6	Extended Exadata Storage Server X8-2 and X8M-2 Hardware Components	9-37
9.3.7	Extreme Flash Exadata Storage Server X7-2 Hardware Components	9-38
9.3.8	High Capacity Exadata Storage Server X7-2 Hardware Components	9-38
9.3.9	Extreme Flash Exadata Storage Server X6-2 Hardware Components	9-39
9.3.10	High Capacity Exadata Storage Server X6-2 Hardware Components	9-39
9.3.11	Extreme Flash Exadata Storage Server X5-2 Hardware Components	9-39
9.3.12	High Capacity Exadata Storage Server X5-2 Hardware Components	9-40
9.3.13	Exadata Storage Server X4-2L Hardware Components	9-40
9.3.14	Exadata Storage Server X3-2L Hardware Components	9-40
9.3.15	Exadata Storage Server with Sun Fire X4270 M2 Servers Hardware Components	9-41
9.3.16	Exadata Storage Server with Sun Fire X4275 Servers Hardware Components	9-41
9.4	Spares Kit Components for Oracle Exadata Database Machine	9-41

## 10 Hardware Components of the Exadata Storage Expansion Rack

---

10.1	Components of Oracle Exadata Storage Expansion Rack X9M-2	10-1
10.2	Components of Oracle Exadata Storage Expansion Rack X8M-2	10-2
10.3	Components of Oracle Exadata Storage Expansion Rack X8-2	10-3
10.4	Components of Oracle Exadata Storage Expansion Rack X7-2	10-3
10.5	Components of Oracle Exadata Storage Expansion Rack X6-2	10-4
10.6	Components of Oracle Exadata Storage Expansion Rack X5-2	10-4
10.7	Components of Oracle Exadata Storage Expansion Rack X4-2	10-5
10.8	Components of Oracle Exadata Storage Expansion Rack X3-2	10-6
10.9	Components of Oracle Exadata Storage Expansion Rack with Exadata Storage Server with Sun Fire X4270 M2 Servers	10-7

## Part III Cabling Information for Oracle Exadata Database Machine

---

### 11 Cabling Tables for Exadata Database Machine X9M

---

11.1	Rack Layout	11-1
11.2	Integrated Lights Out Manager (ILOM) Cabling	11-3
11.3	Administrative Ethernet Port Cabling	11-5
11.4	Single Phase Power Distribution Unit Cabling	11-7
11.4.1	Single Phase PDU Cabling for Exadata Database Machine X9M-2 Full Rack	11-8
11.4.2	Single Phase PDU Cabling for Exadata Database Machine X9M-8 Full Rack	11-9
11.5	Three-Phase Power Distribution Unit Cabling	11-9
11.5.1	Three-Phase PDU Cabling for Exadata Database Machine X9M-2 Full Rack	11-10
11.5.2	Three Phase PDU Cabling for Exadata Database Machine X9M-8 Full Rack	11-11
11.6	RDMA Network Fabric Network Cabling	11-12
11.6.1	RDMA Network Fabric Cabling for Exadata Database Machine X9M-2	11-12
11.6.2	RDMA Network Fabric Cabling for Exadata Database Machine X9M-8	11-16

### 12 Cabling Tables for Exadata Database Machine X8M

---

12.1	Rack Layout Diagrams	12-1
12.2	Integrated Lights Out Manager (ILOM) Cabling Tables	12-3
12.3	Administrative Ethernet Port Cabling Tables	12-5
12.4	Single Phase Power Distribution Unit Cabling Tables	12-7
12.4.1	Single Phase PDU Cabling for Oracle Exadata Database Machine X8M-2 Full Rack	12-8
12.4.2	Single Phase PDU Cabling for Oracle Exadata Database Machine X8M-8 Full Rack	12-9
12.5	Three-Phase Power Distribution Unit Cabling Tables	12-10
12.5.1	Three-Phase PDU Cabling for Oracle Exadata Database Machine X8M-2 Full Rack	12-10
12.5.2	Three Phase PDU Cabling for Oracle Exadata Database Machine X8M-8 Full Rack	12-11
12.6	RDMA Network Fabric Network Cabling Tables	12-12
12.6.1	RDMA Network Fabric Network Cabling Tables for X8M-2 Racks	12-13
12.6.2	RDMA Network Fabric Network Cabling Tables for X8M-8 Racks	12-16

### 13 Cabling Tables for Oracle Exadata Database Machine X8-2, X8-8, X7-2, and X7-8

---

13.1	Rack Layout Diagrams	13-1
------	----------------------	------

13.2	Sun Integrated Lights Out Manager Cabling Tables	13-4
13.3	Administrative Gigabit Ethernet Port Cabling Tables	13-5
13.4	Single Phase Power Distribution Unit Cabling Tables	13-7
13.4.1	Single Phase PDU Cabling for Oracle Exadata Database Machine X8-2 Full Rack	13-8
13.4.2	Single Phase PDU Cabling for Oracle Exadata Database Machine X8-8 Full Rack	13-9
13.4.3	Single Phase PDU Cabling for Oracle Exadata Database Machine X7-2 Full Rack	13-10
13.4.4	Single Phase PDU Cabling for Oracle Exadata Database Machine X7-8 Full Rack	13-11
13.5	Three-Phase Power Distribution Unit Cabling Tables	13-12
13.5.1	Three-Phase PDU Cabling for Oracle Exadata Database Machine X8-2 Full Rack	13-12
13.5.2	Three Phase PDU Cabling for Oracle Exadata Database Machine X8-8 Full Rack	13-13
13.5.3	Three-Phase PDU Cabling for Oracle Exadata Database Machine X7-2 Full Rack	13-14
13.5.4	Three Phase PDU Cabling for Oracle Exadata Database Machine X7-8 Full Rack	13-15
13.6	InfiniBand Network Cabling Tables	13-16

## 14 Cabling Tables for Oracle Exadata Database Machine X6-2, X6-8, X5-2, and X5-8

---

14.1	Rack Layout Diagrams	14-1
14.2	Sun Integrated Lights Out Manager Cabling Tables	14-5
14.3	Administrative Gigabit Ethernet Port Cabling Tables	14-8
14.4	Single Phase Power Distribution Unit Cabling Tables	14-11
14.5	Three Phase Power Distribution Unit Cabling Tables	14-14
14.6	InfiniBand Network Cabling Tables	14-17

## 15 Cabling Tables for Oracle Exadata Database Machine X4-2 and Oracle Exadata Database Machine X4-8 Full Rack

---

15.1	Rack Layout Diagrams	15-1
15.2	Sun Integrated Lights Out Manager Cabling Tables	15-5
15.3	Administrative Gigabit Ethernet Port Cabling Tables	15-8
15.4	Single Phase Power Distribution Unit Cabling Tables	15-11
15.5	Three Phase Power Distribution Unit Cabling Tables	15-14
15.6	InfiniBand Network Cabling Tables	15-17

## 16 Cabling Tables for Oracle Exadata Database Machine X3-2 and Oracle Exadata Database Machine X3-8 Full Rack

---

16.1	Rack Layout Diagrams	16-1
16.2	Sun Integrated Lights Out Manager Cabling Tables	16-5
16.3	Administrative Gigabit Ethernet Port Cabling Tables	16-8
16.4	Single Phase Power Distribution Unit Cabling Tables	16-11
16.5	Three Phase Power Distribution Unit Cabling Tables	16-14
16.6	InfiniBand Network Cabling Tables	16-17

## 17 Cabling Tables for Oracle Exadata Database Machine X2-2 and Oracle Exadata Database Machine X2-8 Full Rack

---

17.1	Rack Layout Diagrams	17-1
17.2	Keyboard, Video and Mouse Network Cabling Tables	17-5
17.3	Sun Integrated Lights Out Manager Cabling Tables	17-7
17.4	Administrative Gigabit Ethernet Port Cabling Tables	17-9
17.5	Single Phase Power Distribution Unit Cabling Tables	17-12
17.6	Three Phase Power Distribution Unit Cabling Tables	17-15
17.7	InfiniBand Network Cabling Tables	17-18

## 18 Cabling Tables for Oracle Exadata Storage Expansion Rack X9M-2

---

18.1	Rack Layout	18-1
18.2	Integrated Lights Out Manager (ILOM) Cabling	18-3
18.3	Administrative Network Cabling	18-3
18.4	Single Phase Power Distribution Unit Cabling	18-4
18.5	Three Phase Power Distribution Unit Cabling	18-5
18.6	RDMA Network Fabric Cabling	18-6

## 19 Cabling Tables for Oracle Exadata Storage Expansion Rack X8M and Earlier

---

19.1	Storage Expansion Rack Layout Diagrams	19-1
19.2	Integrated Lights Out Manager (ILOM) Cabling Tables	19-8
19.3	Administrative Network Cabling Tables	19-13
19.4	Single Phase Power Distribution Unit Cabling Tables	19-20
19.5	Three Phase Power Distribution Unit Cabling Tables	19-28
19.6	RDMA Network Fabric Network Cabling Tables	19-37
19.6.1	RDMA Network Fabric Cabling for Oracle Exadata Storage Expansion Rack X8M-2	19-38

19.6.2	InfiniBand Network Cabling for Oracle Exadata Storage Expansion X7-2, X6-2 and X5-2	19-39
19.6.3	InfiniBand Network Cabling for Oracle Exadata Storage Expansion Rack X4-2 and X3-2	19-41
19.6.4	InfiniBand Network Cabling for Oracle Exadata Storage Expansion with Sun Fire X4270 M2 Servers	19-48

## A Components of Exadata Database Machine

---

A.1	Obtaining Information about Exadata Database Machine Components	A-2
-----	---	-----

# Preface

This guide describes Oracle Exadata Database Machine for online transaction processing (OLTP) and enterprise data warehousing. It includes information about the components, restrictions and cabling.

- [Audience](#)
- [Documentation Accessibility](#)
- [Diversity and Inclusion](#)
- [Conventions](#)

## Audience

This guide is intended for Oracle Exadata Database Machine customers and those responsible for data center site planning, configuration, and maintenance of Oracle Exadata Database Machine.

## Documentation Accessibility

For information about Oracle's commitment to accessibility, visit the Oracle Accessibility Program website at <http://www.oracle.com/pls/topic/lookup?ctx=acc&id=docacc>.

### **Access to Oracle Support**

Oracle customers that have purchased support have access to electronic support through My Oracle Support. For information, visit <http://www.oracle.com/pls/topic/lookup?ctx=acc&id=info> or visit <http://www.oracle.com/pls/topic/lookup?ctx=acc&id=trs> if you are hearing impaired.

## Diversity and Inclusion

Oracle is fully committed to diversity and inclusion. Oracle respects and values having a diverse workforce that increases thought leadership and innovation. As part of our initiative to build a more inclusive culture that positively impacts our employees, customers, and partners, we are working to remove insensitive terms from our products and documentation. We are also mindful of the necessity to maintain compatibility with our customers' existing technologies and the need to ensure continuity of service as Oracle's offerings and industry standards evolve. Because of these technical constraints, our effort to remove insensitive terms is ongoing and will take time and external cooperation.



---

## Conventions

The following text conventions are used in this document:

Convention	Meaning
<b>boldface</b>	Boldface type indicates graphical user interface elements associated with an action, or terms defined in text or the glossary.
<i>italic</i>	Italic type indicates book titles, emphasis, or placeholder variables for which you supply particular values.
monospace	Monospace type indicates commands within a paragraph, URLs, code in examples, text that appears on the screen, or text that you enter.
\$ prompt	The dollar sign (\$) prompt indicates a command run as the <code>oracle</code> user.
# prompt	The pound (#) prompt indicates a command that is run as the <code>root</code> user.

---

# 1

## Introduction to Oracle Exadata Database Machine and Oracle Exadata Storage Expansion Rack

Oracle Exadata Database Machine is engineered to be the highest performing and most available platform for running Oracle Database.

Oracle Exadata Database Machine and Oracle Exadata Storage Expansion Rack are hardware systems that consist of multiple components. This chapter provides an overview of Exadata systems, and usage information.

### Note:

For ease of reading, the name "Oracle Exadata Rack" is used when information refers to both Oracle Exadata Database Machine and Oracle Exadata Storage Expansion Rack.

Oracle Exadata Database Machine and Oracle Exadata Storage Expansion Rack are described in the following topics:

- [Exadata Database Machine Architecture](#)  
Exadata Database Machine is a modern architecture featuring scale-out industry-standard database servers, scale-out intelligent storage servers, and an extremely high speed internal RDMA Network Fabric that connects the database and storage servers.
- [Exadata Database Machine Configurations](#)  
Exadata Database Machine can come in a specific configuration, for example the half rack, or use an elastic configuration with a custom number of database servers and storage servers.
- [Oracle Exadata Database Machine Performance Features](#)  
Oracle Exadata Database Machine not only provides high performance and scalability but also unique technology.
- [Oracle Exadata Rack Limits and Restrictions](#)

### 1.1 Exadata Database Machine Architecture

Exadata Database Machine is a modern architecture featuring scale-out industry-standard database servers, scale-out intelligent storage servers, and an extremely high speed internal RDMA Network Fabric that connects the database and storage servers.

Exadata Database Machine runs all types of database workloads including Online Transaction Processing (OLTP), Data Warehousing, and a consolidation of mixed workloads. Exadata Database Machine powers and protects the most important databases, and is the ideal foundation for a consolidated database cloud.

Exadata Database Machine includes all the hardware needed to run Oracle Database. The database servers, storage servers and network are preconfigured, pretuned and pretested by Oracle engineers, eliminating the weeks of effort typically required to deploy a high performance system. Extensive end-to-end testing ensures all components work together and there are no performance bottlenecks or single points of failure that can affect the complete system. Exadata Database Machine also includes the Oracle Exadata System Software, which runs on both database servers and storage servers. Unique software algorithms in Oracle Exadata System Software implement database intelligence in storage, PCI-based flash, and the RDMA Network Fabric network to deliver higher performance and high capacity at lower costs than other platforms.

## 1.2 Exadata Database Machine Configurations

Exadata Database Machine can come in a specific configuration, for example the half rack, or use an elastic configuration with a custom number of database servers and storage servers.

Exadata Database Machine uses a scale-out architecture for both database servers and storage servers. As Exadata Database Machine grows, more database CPUs, storage and networking are added in a balanced fashion, ensuring scalability without bottlenecks. The first Exadata Database Machine models (X2 and X3) had fixed configurations, such as the half rack or the quarter rack.

Now you can upgrade Exadata Database Machine to custom configurations called "elastic configurations". Elastic configurations enable you to build an Oracle Exadata Rack containing a custom number of database servers and storage servers that meet your needs. See [Elastic Configuration](#) for details.

In addition to upgrading within a rack, multiple racks can be connected using the integrated RDMA Network Fabric to form larger configurations. For example, a system composed of four Oracle Exadata Full Racks is four times as powerful as a single rack system. The four racks provide quadruple the I/O throughput, storage capacity and processors. It can be configured as a large single system or logically partitioned for consolidation of multiple databases. Oracle Real Application Clusters (Oracle RAC) can dynamically add more processing power, and Oracle Automatic Storage Management (Oracle ASM) can dynamically add more storage.

When larger storage capacity is required Oracle Exadata Storage Expansion Rack is available. Oracle Exadata Storage Expansion Rack enables growth of storage capacity and bandwidth for any Exadata Database Machine. It is designed for database deployments that require very large amounts of data including historical or archival data, backups, documents, images, XML, large objects (LOBs), and so on. Oracle Exadata Storage Expansion Rack starts with the quarter rack size, and you can add as many additional storage servers as you need. The servers in the Oracle Exadata Storage Expansion Rack connect to Exadata Database Machine using the integrated RDMA Network Fabric. Configuration does not require set up of logical unit numbers (LUNs) or mount points. Storage is configured and added to the database online using a command line interface.

All Exadata Database Machines are configured identically so customers benefit from the experience of other users who have deployed Exadata Database Machine for their mission-critical applications.

Exadata Database Machine runs standard Oracle Database. Any applications that run with Oracle Database can be seamlessly migrated to Exadata Database Machine with no changes to the application.

- [Elastic Configuration](#)

## 1.2.1 Elastic Configuration

Elastic configuration enables you to customize Oracle Exadata Rack within set limits. For example, using elastic configuration, Oracle Exadata Database Machine X9M-2 can have 0 to 22 database servers, 0 to 19 Exadata Storage Servers, or a combination of database servers and Exadata Storage Servers.



### Note:

Oracle Exadata Rack collectively refers to Oracle Exadata Database Machine and Oracle Exadata Storage Expansion Rack.

You can use Oracle Exadata Configuration Assistant (OECA) to quickly and easily define an elastic configuration. OECA automatically validates each Oracle Exadata Rack configuration and produces a report that contains the associated environmental specifications (power requirements, cooling requirements, rack weight, and so on).

OECA is available on Oracle Technology Network:

<https://www.oracle.com/database/technologies/oeca-download.html>

## 1.3 Oracle Exadata Database Machine Performance Features

Oracle Exadata Database Machine not only provides high performance and scalability but also unique technology.

The Exadata database servers can offload data-intensive SQL operations to Oracle Exadata Storage Servers. Moving the SQL processing to Oracle Exadata Storage Servers enables data filtering and processing to occur immediately and in parallel across all storage servers as data is read from disk. Exadata storage offload reduces database server CPU consumption and greatly reduces the amount of data moved between the storage and database servers.

Compressing data can provide a dramatic reduction in the storage consumed for large databases. Oracle Exadata Storage Server provides a very advanced compression capability called Hybrid Columnar Compression. Hybrid Columnar Compression enables the highest levels of data compression and provides tremendous cost savings and performance improvements due to reduced I/O. On conventional systems, enabling high data compression has the drawback of reducing performance. Oracle Exadata Database Machine is able to offload decompression overhead into a large number of processors in Oracle Exadata Storage Servers so most workloads run faster using Hybrid Columnar Compression than they do without it. Hybrid Columnar Compression combines the compression and analytic performance benefits of column storage while avoiding the dramatic slowdown that pure columnar stores experience for drill-down operations.

Oracle Exadata Database Machine uses the latest PCIe flash technology rather than flash disks. PCIe flash greatly accelerates performance by placing flash directly on the high speed

PCIe bus rather than behind slow disk controllers and directors. Refer to [Hardware Components of Exadata Database Machine](#) for information about flash card configurations and capacity.

Exadata Smart Flash Cache automatically caches frequently accessed data in PCIe flash while keeping infrequently accessed data on disk drives. This provides the performance of flash with the capacity and cost of disk. Exadata Smart Flash Cache understands database workloads and when to avoid caching data that will never be reused or fit in the cache. Oracle Database and Oracle Exadata System Software allow the user to provide directives at the database table, index and segment level to ensure that specific data is retained in flash. Tables can be retained in flash without the need to move the table to different tablespaces, files or LUNs as would have to be done with traditional storage and flash disks.

 **Note:**

Oracle Exadata Database Machine does not include any Oracle software licenses. Appropriate licensing of the following software is required when Oracle Exadata Database Machine is used as a database server:

- Oracle Database
- Oracle Exadata System Software

In addition, Oracle recommends that the following software is licensed:

- Oracle RAC
- Oracle Partitioning

## 1.4 Oracle Exadata Rack Limits and Restrictions

- [Restrictions for Modifying Oracle Exadata Rack Hardware](#)
- [Restrictions for Modifying the Exadata Database Machine Software Components](#)  
The following restrictions apply to software modifications to Oracle Exadata Rack. Violating these restrictions can result in loss of warranty and support.
- [Restrictions for Connecting Exadata Database Machine with Other Hardware, Systems, or Networks](#)  
The following restrictions apply to hardware and software modifications to Oracle Exadata Rack. Violating these restrictions can result in loss of warranty and support.
- [Maximum Number of Database Processes](#)  
This topic describes the limits relating to the maximum number of database processes on each Exadata database node or virtual machine guest.

### 1.4.1 Restrictions for Modifying Oracle Exadata Rack Hardware

Modification of Oracle Exadata Rack is generally not required or recommended, and unpermitted modifications can result in loss of warranty and support. However, the following hardware modifications are permitted:

- Customers may perform the following modifications to the included Management Network Switch, which supports the administration network. Modification is only

allowed after delivery of the Oracle Exadata Rack, and the customer bears responsibility for all costs and issues that may arise from any change.

Customers may:

- Replace the Management Network Switch with an equivalent customer-supplied 1U Gigabit Ethernet switch.
- Reconfigure the Management Network Switch settings and firmware.
- Remove the Management Network Switch and cable the administration network connections directly to an external customer-supplied switch or patch panel.
- Subject to validation using Oracle Exadata Configuration Assistant (OECA), customers may install additional equipment into unused rack slots.

Use the **ADD EQUIPMENT** button in OECA to specify the additional equipment details.

Additional equipment may only be installed after the resulting configuration is validated using OECA.

#### Related Topics

- [Oracle Exadata Configuration Assistant \(OECA\) Downloads](#)

## 1.4.2 Restrictions for Modifying the Exadata Database Machine Software Components

The following restrictions apply to software modifications to Oracle Exadata Rack. Violating these restrictions can result in loss of warranty and support.

- Oracle Exadata System Software and the operating systems cannot be modified, and you cannot install any additional software or agents on the Oracle Exadata Storage Servers.
- You cannot update the firmware directly on the Oracle Exadata Storage Servers. The firmware is updated as part of an Oracle Exadata Storage Server patch.
- You can update the firmware of the other components of Oracle Exadata Rack.
  - You can update the OS and firmware versions on the Management Network Switch to meet their data center requirements.
  - You can update the firmware of the components of the database servers provided they comply with the restrictions documented in My Oracle Support Doc ID 888828.1, and its related notes.
  - You can update the firmware of the RDMA Network Fabric switches provided they comply with the validated versions documented in My Oracle Support Doc ID 888828.1, and its related notes.
- You may load additional software on the database servers. However, to ensure best performance, Oracle discourages adding software except for agents, such as backup agents and security monitoring agents, on the database servers.

Loading non-standard kernel modules on the operating system of the database servers is allowed but discouraged. Oracle will not support questions or issues with the non-standard modules. If a server crashes, and Oracle suspects the crash may have been caused by a non-standard module, then Oracle support may refer you to the vendor of the non-standard module or ask that the issue be reproduced without the non-standard module. Modifying the database server operating system other than by applying official patches and upgrades is not supported.

- RDMA Network Fabric-related packages should always be maintained at the officially supported release.
- You can install Oracle Enterprise Manager Cloud Control Management Agents or Oracle Enterprise Manager Grid Control Management Agents on the database servers to monitor the system.
- Installing Oracle Enterprise Manager Ops Center agents to monitor the system is not allowed.
- Oracle Exadata Deployment Assistant (OEDA) is used to specify the physical network interfaces that you want to bond for the client network and the additional networks, if configured. OEDA generates bonded network interfaces that amalgamate two physical network interfaces.

Manual changes to the OEDA-generated bonding configuration are allowed but discouraged. Oracle will not support questions or issues associated with non-standard bonding configurations. In any event, bonding configurations having fewer than two networking interfaces are not permitted.

#### Related Topics

- [Exadata Database Machine and Exadata Storage Server Supported Versions \(My Oracle Support Doc ID 888828.1\)](#)

### 1.4.3 Restrictions for Connecting Exadata Database Machine with Other Hardware, Systems, or Networks

The following restrictions apply to hardware and software modifications to Oracle Exadata Rack. Violating these restrictions can result in loss of warranty and support.

- Oracle Exadata Storage Expansion Rack can only be connected to Oracle Exadata Database Machine or Oracle SuperCluster, and only supports databases running on the database servers on Oracle Exadata Database Machine or Oracle SuperCluster.
- Standalone Oracle Exadata Storage Servers can only be connected to Oracle Exadata Database Machine or Oracle SuperCluster, and only support databases running on the database servers of Oracle Exadata Database Machine or Oracle SuperCluster.
- Customers cannot connect USB devices that draw more than 100 mA of power to the database servers.
- Customers cannot connect USB devices to the Oracle Exadata Storage Servers except as documented in the Exadata Database Machine documentation. In those documented situations, the USB device should not draw more than 100 mA of power.
- Only switches specified for use in Oracle Exalogic Elastic Cloud, Oracle Big Data Appliance, and Oracle SuperCluster may be connected to the Oracle Exadata Rack RDMA Network Fabric network. It is not supported to connect other RDMA Network Fabric switches, including third-party switches, to the Oracle Exadata Rack RDMA Network Fabric network. Only the RDMA Network Fabric networking topologies specified in this guide and *Oracle Exadata Database Machine Extending and Multi-Rack Cabling Guide* are supported, and any other RDMA Network Fabric network topology is not supported.

 **Note:**

When interconnecting racks, all racks must use the same type of RDMA Network Fabric, either InfiniBand or RDMA over Converged Ethernet (RoCE).

- You may connect external servers, that are not part of Oracle Engineered Systems, to the RDMA Network Fabric switches in Exadata Database Machine. However, it is your responsibility to upgrade and maintain the compatibility of the RDMA Network Fabric software of the external servers with the RDMA Network Fabric software release for Exadata Database Machine. Oracle highly recommends that you maintain the same release of RDMA Network Fabric software and operating system on the external server as on Exadata Database Machine. If an RDMA Network Fabric problem is encountered and an external server is connected, then you may be asked to remove the external server and reproduce the problem.
- You can connect the database servers to external (non-Exadata) storage using iSCSI or NFS subject to the following:
  - The storage is allowed for application input and output files, Data Pump export files and logs, and files associated with backup and recovery operations.
  - The use of non-Oracle storage for Oracle Database files is not supported.
  - The Fibre Channel over Ethernet (FCoE) protocol is not supported.

**Related Topics**

- Multi-Rack Cabling Tables

## 1.4.4 Maximum Number of Database Processes

This topic describes the limits relating to the maximum number of database processes on each Exadata database node or virtual machine guest.

The following table shows the maximum number of database processes supported on each Exadata database node. The best practice is to keep the process count below these values. If a subset of your workload is running parallel queries, the maximum database process count will be between the values in the "Maximum Number of Processes with No Parallel Queries" column and the "Maximum Number of Processes with All Running Parallel Queries" column.

**Table 1-1 Maximum Number of Database Processes on a Database Node**

Machine Type	RDMA Network Fabric Bonding Type	Maximum Number of Processes with No Parallel Queries	Maximum Number of Processes with All Running Parallel Queries
8-socket (X2-8, X3-8)	Active passive	28,500	25,000
8-socket (X4-8, and later)	Active bonding	64,000	44,000
2-socket (X2-2, X3-2)	Active passive	12,500	10,000
2-socket (X4-2, and later)	Active bonding	16,000	14,000

The following table shows the maximum number of database processes supported on each virtual machine (VM) guest (Oracle VM DomU or KVM guest). The best practice is to keep



the process count below these values. If a subset of your workload is running parallel queries, the maximum database process count will be between the "Maximum Number of Processes with No Parallel Queries" column and the "Maximum Number of Processes with All Running Parallel Queries" column.

**Table 1-2 Maximum Number of Database Processes on a Virtual Machine Guest**

Machine Type	RDMA Network Fabric Bonding Type	Maximum Number of Processes with No Parallel Queries	Maximum Number of Processes with All Running Parallel Queries
2-socket (X2-2, X3-2)	Active passive	11,500	8,000
2-socket (X4-2, and later)	Active bonding	23,000	14,000

The following best practices should be followed to ensure optimal resource utilization at high process count:

- Application-initiated Oracle foregrounds should be established through a set of Oracle listeners running on the Exadata database nodes instead of using local bequeath connections.
- The number of listeners should be at least as high as the number of database node CPU sockets, and every database node CPU socket should run the same number of listeners. For example, on an Oracle Exadata X5-8 database node, eight listeners could be configured, one per database node CPU socket.
- Listeners should spawn Oracle processes evenly across database node CPU sockets. This can be done by specifying the socket they will run on at startup time. For example, assuming the `listener.ora` file is configured correctly for listeners 0 through 7, the following script could be used to spawn eight listeners on an X5-8 database node, each on a different socket:

```
#!/bin/bash
export ORACLE_HOME=/u01/app/oracle/product/12.1.0.2/dbhome_1
for socket in `seq 0 7`
do
    numactl --cpunodebind=${socket} $ORACLE_HOME/bin/lsnrctl start LISTENER${socket}
done
```

- Listener connection rate throttling should be used to control login storms and provide system stability at high process counts.
- The total number of connections established per second, in other words, the sum of `rate_limit` for all listeners, should not be more than 400 to avoid excessive client connection timeouts and server-side errors.

# Part I

## What's New in Oracle Exadata Database Machine

These topics describe the new features included in each release of Oracle Exadata Database Machine and Oracle Exadata System Software.

- [New Features for Oracle Exadata System Software Release 22.x](#)  
This section describes the new features introduced in Oracle Exadata System Software release 22.x.
- [New Features for Oracle Exadata System Software Release 21.x](#)  
This section describes the new features introduced in Oracle Exadata System Software release 21.x.
- [New Features for Oracle Exadata System Software Release 20.x](#)  
Several new features were introduced for Oracle Exadata System Software release 20.x.
- [New Features for Oracle Exadata System Software Release 19.x](#)  
Several new features were introduced for the various versions of Oracle Exadata System Software Release 19.x.
- [New Features for Oracle Exadata System Software Release 18](#)  
Several new features were introduced for Oracle Exadata System Software Release 18.
- [New Features for Oracle Exadata System Software Release 12.x](#)  
Several new features were introduced for the various versions of Oracle Exadata System Software Release 12.x.
- [New Features for Oracle Exadata System Software Release 11.x](#)  
Several new features were introduced for the various versions of Oracle Exadata System Software Release 11.x.

# 2

## New Features for Oracle Exadata System Software Release 22.x

This section describes the new features introduced in Oracle Exadata System Software release 22.x.

- [What's New in Oracle Exadata Database Machine 22.1](#)

### 2.1 What's New in Oracle Exadata Database Machine 22.1

- [Real-Time Insight](#)
- [Oracle VM Server Management Domain Upgrade to Oracle Linux 7](#)
- [Exadata Upgrade Improvements](#)
- [Deprecated Features in Oracle Exadata System Software Release 22.1](#)

#### 2.1.1 Real-Time Insight

Commencing with Oracle Exadata System Software 22.1.0, real-time insight provides the infrastructure to automatically stream up-to-the-second metric observations from all of the servers in your Exadata fleet and feed them into customizable monitoring dashboards for real-time analysis and problem-solving.

You can choose which of the 200+ Exadata metrics are included in the stream and use standard Web protocols to automatically propagate the stream to popular observability platforms, time-series databases, and visualization applications.

##### **Related Topics**

- [Using Real-Time Insight](#)

#### 2.1.2 Oracle VM Server Management Domain Upgrade to Oracle Linux 7

Oracle Exadata System Software 22.1.0 includes an upgrade to Oracle Linux 7 for the Oracle VM Server management domain (Dom0).

This upgrade modernizes the Oracle VM Server management domain, delivers numerous stability and security improvements, and removes the last dependence on Oracle Linux 6 in Oracle Exadata System Software.

The upgrade is transparent to the Oracle VM user domains (DomU), and the existing volume and filesystem structures continue to reside inside the management domain.

This change only applies to Exadata systems configured with virtual machines (VMs) on Exadata X8-2 and earlier 2-socket hardware models, which contain InfiniBand Network Fabric.

## 2.1.3 Exadata Upgrade Improvements

Oracle Exadata System Software 22.1.0 includes numerous changes that deliver quicker upgrades for Exadata database servers. The changes include:

- Optimizing the sequence of operations to remove unnecessary repetition, unnecessary checks, and unnecessary reboots.
- Performing operations and checks asynchronously (in the background) and in parallel where possible.
- Optimizing the packaging of Exadata software images to remove unnecessary repackaging.
- Pre-staging software and firmware images where possible.

The improvements cover all aspects of the upgrade process, including the Operating System (OS) upgrade procedures, Oracle software upgrade procedures, Exadata software imaging procedures, and firmware upgrade procedures.

Individual results vary depending on many variables, including the system configuration, system load, pre-upgrade software version, and system size. In most cases, each server upgrade is at least 10% faster. While in some cases, the upgrade duration is half of comparable previous upgrades.

Furthermore, the benefit multiplies across multiple servers. So, depending on the size of the rack, or the number of racks in the fleet, these improvements can reduce the overall time to perform an upgrade by hours or even days.

## 2.1.4 Deprecated Features in Oracle Exadata System Software Release 22.1

The following features are deprecated in this release, and may be desupported in a future release:

- [Deprecation of RAM Cache](#)
- [Deprecation of USB Images](#)

### 2.1.4.1 Deprecation of RAM Cache

Commencing with the September 2022 Oracle Exadata System Software release updates (versions 21.2.16 and 22.1.3), the cell RAM Cache feature is deprecated.

Existing RAM Cache installations continue to operate as they did in previous releases. However, new RAM Cache creation requests are not allowed after the deprecation.

The cell RAM Cache feature was introduced in Oracle Exadata System Software version 18.1.0. See [In-Memory OLTP and Consolidation Acceleration](#).

### 2.1.4.2 Deprecation of USB Images

Commencing with the September 2022 Oracle Exadata System Software release updates (versions 21.2.16 and 22.1.3), USB images are deprecated.

After the deprecation, USB images are no longer available for imaging or re-imaging an Oracle Exadata Database Machine server and are not included in the Secure

Eraser package (`secureeraser_label.zip`). Instead of USB image files, use the PXE option with ISO image files.

# 3

## New Features for Oracle Exadata System Software Release 21.x

This section describes the new features introduced in Oracle Exadata System Software release 21.x.

- [What's New in Oracle Exadata Database Machine 21.2](#)

### 3.1 What's New in Oracle Exadata Database Machine 21.2

- [Exadata Database Machine X9M Support](#)
- [Persistent Storage Index](#)
- [Persistent Columnar Cache](#)
- [IORM Cluster Plan](#)
- [Smart Scan Metadata Sharing](#)
- [Oracle ASR Support for Cisco RoCE Network Fabric Switches and Management Network Switch](#)
- [Patch Manager Support for the Management Network Switch](#)
- [Options to Preserve Redundancy while Dropping a Physical Disk](#)
- [Faster Upgrades with ILOM Pre-Staging](#)
- [Faster Recovery from Flash Cache Failure](#)
- [Automatic Recovery from Disk Controller Cache Failure](#)
- [Enhanced Database Server Alerting](#)
- [Oracle ACFS I/O Caching in Flash Cache](#)
- [Smart Scan Fast Decryption](#)
- [Deprecated Features in Oracle Exadata System Software Release 21.2](#)

#### 3.1.1 Exadata Database Machine X9M Support

Oracle Exadata System Software release 21.2.0 introduces support for the Exadata Database Machine X9M system family.

Exadata X9M is the second generation of system hardware based on RoCE Network Fabric, and offers performance and capacity improvements throughout.

See *Hardware Components of Oracle Exadata Database Machine* in the *Oracle Exadata Database Machine System Overview* for details.

Minimum requirements:

- Oracle Exadata System Software release 21.2.0

- Exadata Database Machine X9M

## 3.1.2 Persistent Storage Index

Storage indexes help Oracle Exadata System Software to avoid unnecessary I/O operations. By avoiding unnecessary I/O, affected operations perform better. Also, overall system throughput increases because the saved I/O bandwidth can be used to perform other work.

Oracle Exadata System Software creates and maintains a storage index in Exadata Storage Server shared memory. For each storage region, the storage index automatically tracks minimum and maximum column values and set membership. Storage index functionality works transparently with no user input. There is no need to create, drop, or tune the storage index.

Starting with Oracle Exadata System Software release 21.2.0, the storage index can persist across cell restarts and upgrades. When the feature is enabled, the storage index shared memory segments are written to the storage server system disks during a graceful shutdown, and these are automatically restored during restart. In the event of a cell server crash or offload server crash, the storage index shared memory segments are retained by the operating system and are immediately available when the software service restarts.

On Oracle Exadata Database Machine X7-2 and later systems with M.2 solid-state drives (SSD), persistence can also be maintained across Oracle Exadata System Software upgrades.

This feature eliminates the need to rebuild the storage index and enables more consistent query performance immediately after a cell restart.

The feature is controlled by setting the `storageIndexPersMode` cell attribute.

Minimum requirements:

- Oracle Exadata System Software release 21.2.0
- Oracle Database 12c Release 2 (12.2)

### Related Topics

- ALTER CELL - Persistence Attributes

## 3.1.3 Persistent Columnar Cache

The columnar cache is a portion of Exadata Smart Flash Cache that contains data in columnar format. Data in Exadata Smart Flash Cache is automatically converted to columnar format and stored in the columnar cache to aid query performance.

Before Oracle Exadata System Software release 21.2.0, metadata for managing the columnar cache is lost when the cell fails or shuts down. Consequently, the columnar cache must be rebuilt following each cell restart.

Starting with Oracle Exadata System Software release 21.2.0, the columnar cache can persist across cell restarts and upgrades. This feature saves resources associated with rebuilding the cache and enables more consistent query performance immediately after a cell restart.

To use persistent columnar cache, Exadata Smart Flash Cache must be in Write-Back mode. The feature is controlled by setting the `columnarCachePersMode` cell attribute.

Minimum requirements:

- Oracle Exadata System Software release 21.2.0

#### Related Topics

- ALTER CELL - Persistence Attributes

## 3.1.4 IORM Cluster Plan

Oracle Exadata System Software release 21.2.0 extends I/O Resource Management (IORM) to include the cluster plan. The IORM cluster plan specifies how storage server resources are allocated across multiple Oracle Grid Infrastructure clusters. Each directive in a cluster plan specifies an allocation to an Oracle Grid Infrastructure cluster, rather than an individual database or consumer group.

For example, consider a system hosting two clusters; `clusterA` and `clusterB`. Now, imagine a cluster plan with share-based resource allocation where `clusterA` has three shares, and `clusterB` has one share. In that case, and in the absence of any other IORM plans, all of the databases running in `clusterA` share 75% of the I/O resources, while the databases in `clusterB` share the remaining 25%.

Minimum requirements:

- Oracle Exadata System Software release 21.2.0
- To operate the IORM cluster plan, ASM-scoped security must be configured.

#### Related Topics

- Managing I/O Resources
- ALTER IORMPLAN

## 3.1.5 Smart Scan Metadata Sharing

During Smart Scan operations, Oracle Database sends query metadata to the Exadata Storage Servers. The query metadata contains information like predicated columns, projected columns, predicates, database session information, bloom filters, and so on, which is required to offload the query to the storage servers. Historically, during parallel query execution, each Oracle Database parallel query server process sends serialized and compressed query metadata to the storage server, where it is uncompressed and deserialized before use. Furthermore, for each parallel query, a significant portion of the metadata is common to all of the parallel query server processes.

Starting with release 21.2.0, Oracle Exadata System Software shares common query metadata across Smart Scan sessions belonging to the same parallel query. This feature reduces the memory and processing footprint for parallel queries in Exadata Storage Server. In turn, the saved resources can support other work and increase the overall system throughput. The benefit is greatest for sophisticated operations that typically require more metadata, such as join queries using Bloom filters, data mining models, external tables, and tables with JSON/XML types.

Minimum requirements:

- Oracle Exadata System Software release 21.2.0



## 3.1.6 Oracle ASR Support for Cisco RoCE Network Fabric Switches and Management Network Switch

Oracle Exadata System Software release 21.2.0 introduces new capabilities to monitor Cisco switches using Oracle Auto Service Request (ASR). This capability covers the Cisco Management Network Switch and RoCE Network Fabric Switches present in X8M and later systems. It also covers Management Network Switch model 9348 present in earlier X8 and some X7 systems.

With this release, when you use the Patch Manager utility (`patchmgr`) to upgrade the Cisco switch firmware, a new monitoring component is also installed on the Cisco switch. The new monitoring component propagates switch alerts to Oracle ASR, enabling automated problem detection and resolution.

Minimum requirements:

- Oracle Exadata System Software release 21.2.0
- Oracle Exadata Database Machine X8M, or earlier models with Cisco Management Network Switch model 9348.

### Related Topics

- Configuring Cisco Switches for Oracle ASR

## 3.1.7 Patch Manager Support for the Management Network Switch

Commencing with Oracle Exadata System Software release 21.2.0, the Patch Manager utility (`patchmgr`) introduces capabilities to manage firmware upgrades on the 9000 series Management Network Switch found on Oracle Exadata Database Machine X7-2 and later systems.

Minimum requirements:

- Oracle Exadata System Software release 21.2.0
- Oracle Exadata Database Machine X7-2

### Related Topics

- Patchmgr Syntax for the Cisco Management Switch

## 3.1.8 Options to Preserve Redundancy while Dropping a Physical Disk

Oracle Exadata System Software release 21.2.0 introduces the `MAINTAIN REDUNDANCY` and `NOWAIT` options to the `CELLCLI ALTER PHYSICALDISK DROP FOR REPLACEMENT` command.

The `MAINTAIN REDUNDANCY` option streamlines Exadata Storage Server administration by automatically rebalancing data before dropping the corresponding ASM disks. In previous releases, maintaining redundancy required additional administrator intervention to manually drop the corresponding ASM disks and rebalance the data prior to using the `ALTER PHYSICALDISK DROP FOR REPLACEMENT` command.

The `NOWAIT` option allows the `ALTER PHYSICALDISK` command to complete immediately while the `DROP FOR REPLACEMENT` operation executes asynchronously in the background.

Minimum requirements:

- Oracle Exadata System Software release 21.2.0

#### Related Topics

- `ALTER PHYSICALDISK`
- Replacing a Hard Disk Proactively

### 3.1.9 Faster Upgrades with ILOM Pre-Staging

The upgrade process for Oracle Exadata System Software typically includes a firmware upgrade for Integrated Lights Out Manager (ILOM). Historically, the ILOM firmware upgrade was performed as a serial process, taking approximately 30% of the total software upgrade time on each physical server (database server or storage server).

ILOM version 5 introduces support for pre-staging of new ILOM firmware. With this feature, pre-staging occurs in parallel with other server upgrade activities, and the new ILOM firmware is automatically enabled when the server reboots at the end of the upgrade procedure.

On Exadata X7 and newer systems, this approach approximately halves the ILOM firmware upgrade time on each server, which translates to an improvement of approximately 15% for the total software upgrade time.

Minimum requirements:

- This feature is automatically used on Exadata X7 and newer systems, except for X8-2L servers, when upgrading Oracle Exadata System Software from at least version 19.3.11 or 20.1.1.
- For X8-2L servers only, this feature is automatically used when upgrading Oracle Exadata System Software from at least version 19.3.12 or 20.1.2.

### 3.1.10 Faster Recovery from Flash Cache Failure

This feature reduces the recovery time following flash cache failure by staging flash cache metadata to the M.2 solid-state drives (SSD) found on Oracle Exadata Database Machine X7 and later systems. Using the M.2 SSD speeds up resilvering table creation and the assignment of caching devices following flash failure. This feature reduces the overall brownout time following a flash failure.

Minimum requirements:

- Oracle Exadata System Software release 21.2.0
- Oracle Exadata Database Machine X7-2

### 3.1.11 Automatic Recovery from Disk Controller Cache Failure

High Capacity (HC) and Extended (XT) Oracle Exadata Storage Server models have a disk controller that contains a write-back cache, which is separate and distinct from the write-back flash cache.

A multiple-bit ECC error on the disk controller cache can crash the server, resulting in the loss of unflushed data in the disk controller cache and leaving stale data on the disks. If not handled carefully, such errors are severe and can result in data loss.

Oracle Exadata System Software release 21.2.0 supports automatic recovery following a disk controller cache failure. Where possible, this feature automatically detects the problem and copies data from other mirrors to recover all of the disks in the failed server.

Minimum requirements:

- Oracle Exadata System Software release 21.2.0

### 3.1.12 Enhanced Database Server Alerting

Oracle Exadata System Software release 21.2.0 introduces enhanced alerting on the database servers.

With this capability, the `DBMCLI LIST ALERTHISTORY` command now shows incidents relating to Oracle Grid Infrastructure and Oracle Database software.

Minimum requirements:

- Oracle Exadata System Software release 21.2.0

#### Related Topics

- `LIST ALERTHISTORY`

### 3.1.13 Oracle ACFS I/O Caching in Flash Cache

To optimize I/O efficiency, small sequential writes to Oracle Advanced Cluster File System (Oracle ACFS) are automatically combined into 1 MB chunks. However, before Oracle Exadata System Software release 21.2.0, these larger writes would bypass the cache and go directly to disk.

Commencing with Oracle Exadata System Software release 21.2.0, all Oracle ACFS I/O is eligible for caching in Exadata Smart Flash Cache.

This feature enhances Oracle ACFS performance, especially for applications such as Oracle GoldenGate trail files, having an I/O profile dominated by small sequential writes and fast subsequent reads.

Minimum requirements:

- Oracle Exadata System Software release 21.2.0

### 3.1.14 Smart Scan Fast Decryption

In conjunction with applicable hardware first introduced in Exadata Database Machine X9M, Oracle Exadata System Software release 21.2.0 uses VAES and AVX512 instruction sets and implements cache-friendly algorithms to improve Smart Scan performance on encrypted tables and compressed tables.

Minimum requirements:

- Oracle Exadata System Software release 21.2.0
- Exadata Database Machine X9M

## 3.1.15 Deprecated Features in Oracle Exadata System Software Release 21.2

The following features are deprecated in this release, and may be desupported in a future release:

- [Deprecation of RAM Cache](#)
- [Deprecation of USB Images](#)

### 3.1.15.1 Deprecation of RAM Cache

Commencing with the September 2022 Oracle Exadata System Software release updates (versions 21.2.16 and 22.1.3), the cell RAM Cache feature is deprecated.

Existing RAM Cache installations continue to operate as they did in previous releases. However, new RAM Cache creation requests are not allowed after the deprecation.

The cell RAM Cache feature was introduced in Oracle Exadata System Software version 18.1.0. See [In-Memory OLTP and Consolidation Acceleration](#).

### 3.1.15.2 Deprecation of USB Images

Commencing with the September 2022 Oracle Exadata System Software release updates (versions 21.2.16 and 22.1.3), USB images are deprecated.

After the deprecation, USB images are no longer available for imaging or re-imaging an Oracle Exadata Database Machine server and are not included in the Secure Eraser package (`secureeraser_label.zip`). Instead of USB image files, use the PXE option with ISO image files.

# 4

## New Features for Oracle Exadata System Software Release 20.x

Several new features were introduced for Oracle Exadata System Software release 20.x.

- [What's New in Oracle Exadata Database Machine 20.1.0](#)

### 4.1 What's New in Oracle Exadata Database Machine 20.1.0

The following features are new for Oracle Exadata System Software 20.1.0:

- [Exadata Secure RDMA Fabric Isolation](#)
- [Smart Flash Log Write-Back](#)
- [Fast In-Memory Columnar Cache Creation](#)
- [Cell-to-Cell Rebalance Preserves PMEM Cache Population](#)
- [Control Persistent Memory Usage for Specific Databases](#)
- [Application Server Update for Management Server](#)

#### 4.1.1 Exadata Secure RDMA Fabric Isolation

Exadata Secure RDMA Fabric Isolation enables strict network isolation for Oracle Real Application Clusters (Oracle RAC) clusters on Exadata Database Machine systems that use RDMA over Converged Ethernet (RoCE).

Secure Fabric provides critical infrastructure for secure consolidation of multiple tenants on Exadata Database Machine, where each tenant resides in a dedicated virtual machine (VM) cluster. Using this feature ensures that:

- Database servers in separate clusters cannot communicate with each other. They are completely isolated from each other on the network.
- Database servers in multiple clusters can share all of the storage server resources. However, even though the different clusters share the same storage network, no cross-cluster network traffic is possible.

Exadata Secure RDMA Fabric Isolation uses RoCE VLANs to ensure that network packets from one VM cluster cannot be seen by another VM cluster. VLAN tag enforcement is done at the KVM host level, which means that security cannot be bypassed by any software exploits or misconfiguration on the database server VMs.

See [Using Exadata Secure RDMA Fabric Isolation](#).

Minimum requirements:

- Oracle Exadata System Software release 20.1.0
- Exadata Database Machine X8M-2
- Deployment must contain VM clusters using Oracle Linux KVM

- Oracle Grid Infrastructure:
  - 19.6.0.0.200114 with patches
  - 18.8.0.0.191015 with patches
  - 12.2.0.1.191015 with patches
  - 12.1.0.2.190716 with patches
- Oracle Database:
  - 19.6.0.0.200114 with patches
  - 18.8.0.0.191015 with patches
  - 12.2.0.1.191015 with patches
  - 12.1.0.2.180831
  - 11.2.0.4.180717

Refer to My Oracle Support Doc ID 888828.1 for details about the required patches.

### Related Topics

- [Exadata Database Machine and Exadata Storage Server Supported Versions \(My Oracle Support Doc ID 888828.1\)](#)

## 4.1.2 Smart Flash Log Write-Back

On High Capacity Oracle Exadata Storage Servers, all redo log entries must be written to the hard disk drives (HDDs). Even though Exadata Smart Flash Log prevents occasional log write outliers, the total log write throughput is still bound by the HDDs. Consequently, log writes can become a performance bottleneck when I/O bandwidth is saturated on the HDDs, either because of high-volume redo log activity or because of other I/O-intensive activities such as Golden Gate log mining, log archiving, and RMAN backup and restore.

The Smart Flash Log Write-Back feature automatically and transparently stores the entire contents of redo log files using Exadata Smart Flash Cache in Write-Back mode, thereby eliminating the HDDs as a potential performance bottleneck. Depending on the system workload, overall log write throughput can improve up to 250%.

Smart Flash Log Write-Back works transparently in conjunction with Exadata Smart Flash Log. Smart Flash Log Write-Back boosts overall log write throughput, while Exadata Smart Flash Log continues to prevent log write latency outliers.

Smart Flash Log Write-Back works with Oracle Data Guard Primary and Standby databases, boosting throughput for online redo log files and standby redo log files.

If flash cache space resource management is configured in the IORM plan, then caching of redo log files is included in the space accounting for each multitenant container database (CDB) or non-CDB database.

Minimum requirements:

- Oracle Exadata System Software release 20.1.0.
- Oracle Exadata Database Machine X7.
- Exadata Smart Flash Cache in Write-Back mode.
- Oracle Database in `ARCHIVELOG` mode.

### 4.1.3 Fast In-Memory Columnar Cache Creation

Columnar cache with in-memory database formats are created when data is read from the hard disks, where it is stored in the hybrid columnar format. With this feature, columnar cache with in-memory database formats are also created when reading data in an intermediate format from the flash cache.

This feature provides a significant performance improvement for columnar cache creation, especially when there are concurrent workloads utilizing hard disk IO bandwidth. For example, a backup that utilizes the hard disk bandwidth no longer needs to share that bandwidth with the in-memory columnar cache creation. As a result, both the backup and the in-memory columnar cache creation run faster.

See In-Memory Columnar Format Support in the *Oracle Exadata System Software User's Guide* for more information about the in-memory columnar cache format.

Minimum requirements:

- Oracle Exadata System Software release 20.1.0

### 4.1.4 Cell-to-Cell Rebalance Preserves PMEM Cache Population

Data rebalancing may occur for a variety of reasons. For example, a rebalance operation might happen to maintain data redundancy when a hard disk suffers a real or predictive failure. When a rebalance operation moves data to a different storage server, some of the data might be cached in the persistent memory (PMEM) cache, also known as Persistent Memory Data Accelerator.

Commencing with Oracle Exadata System Software release 20.1.0, relevant PMEM cache entries are automatically replicated to the target storage server when a rebalance operation moves data to a different storage server. This new feature maintains more consistent application performance after a rebalance operation.

This feature builds on existing features that preserve data in Exadata Smart Flash Cache during cell-to-cell rebalance operations.

Minimum requirements:

- Oracle Exadata System Software release 20.1.0.
- Oracle Exadata Database Machine X8M.

### 4.1.5 Control Persistent Memory Usage for Specific Databases

This feature introduces `pmemcache` and `pmemlog`, which are two new directives for the interdatabase IORM plan. With these directives, you can control persistent memory usage for specific databases and ensure that valuable persistent memory resources are reserved for mission-critical databases, especially in consolidated environments.

You can set `pmemcache=off` to prevent the specified database from using the persistent memory (PMEM) cache. Likewise, setting `pmemlog=off` prevents the specified database from using the PMEM log. By default, all databases can use persistent memory for caching and logging.

You can check the current IORM plan settings by issuing the command `LIST IORMPLAN DETAIL` in CellCLI.

See Using IORM to Control Database Access to Flash and PMEM Resources and Controlling Access to PMEM Cache and PMEM Log in the *Oracle Exadata System Software User's Guide* for more information.

Minimum requirements:

- Oracle Exadata System Software release 20.1.0
- Exadata Database Machine X8M

## 4.1.6 Application Server Update for Management Server

In this release, Eclipse Jetty replaces Oracle WebLogic Server as the application server engine that is used internally by Oracle Exadata System Software, in particular Management Server (MS).

Oracle Exadata System Software does not need most of the sophisticated functionality provided by Oracle WebLogic Server. Consequently, moving to Eclipse Jetty delivers the following benefits:

- **Speed** — Eclipse Jetty is a light-weight web server, which consumes considerably fewer system resources than a full-featured application server, like Oracle WebLogic Server. Consequently, Eclipse Jetty can perform the required tasks more efficiently and free up resources to improve system performance across the board.
- **Security** — As a light-weight web server, Eclipse Jetty improves security by presenting fewer attack vectors. Furthermore, the security of Eclipse Jetty is demonstrated by its use in a wide variety of projects and products, both in development and production.

Minimum requirements:

- Oracle Exadata System Software release 20.1.0.



# 5

## New Features for Oracle Exadata System Software Release 19.x

Several new features were introduced for the various versions of Oracle Exadata System Software Release 19.x.

- [What's New in Oracle Exadata Database Machine 19.3.0](#)
- [What's New in Oracle Exadata Database Machine 19.2.0](#)
- [What's New in Oracle Exadata Database Machine 19.1.0](#)

### 5.1 What's New in Oracle Exadata Database Machine 19.3.0

The following features are new for Oracle Exadata System Software 19.3.0:

- [Persistent Memory Data Accelerator](#)
- [Persistent Memory Commit Accelerator](#)
- [Support for Oracle Exadata X8M Systems](#)
- [Instant Failure Detection for X8M Systems](#)
- [KVM for Virtual Environments](#)
- [Faster Encrypted Table Smart Scans](#)
- [Smart Aggregation](#)
- [Smart In-Memory Columnar Cache with Row IDs](#)
- [Smart In-memory Columnar Cache with Chained Rows](#)
- [Fast Smart In-memory Columnar Cache Creation](#)
- [Encryption of System Logs to Remote Destinations](#)
- [Update a Single SNMP User Definition](#)
- [Securing Storage Server Software Processes with Memory Protection Keys](#)
- [Default XFS File System for X8M Servers](#)
- [Oracle Linux Kernel to Unbreakable Enterprise Kernel 5 and Oracle Linux Distribution Upgraded to Oracle Linux 7.7](#)
- [Software Certification Ends for Exadata Database Machine X2 Servers](#)

#### 5.1.1 Persistent Memory Data Accelerator

Oracle Exadata Storage Server can now use a Persistent Memory (PMEM) Cache in front of Flash Cache. Known as Persistent Memory Data Accelerator, the PMEM cache uses Intel Optane™ DC Persistent Memory Modules (DCPMM). The Database Server uses remote direct memory access (RDMA) to enable 10x faster access latency to remote persistent memory.

Since the persistent memory is used as a shared cache, caching capacity effectively increases by 10x compared to directly using the persistent memory modules as expensive storage. This arrangement makes it cost effective to apply the benefits of persistent memory to multi-terabyte databases.

See Persistent Memory and RDMA for details.

Minimum requirements:

- Oracle Exadata System Software release 19.3.0
- Oracle Database 19c
- Oracle Exadata Storage Server X8M-2

## 5.1.2 Persistent Memory Commit Accelerator

Consistent low latency for redo log writes is critical for OLTP database performance, since transactions are committed only when redo logs are persisted. Furthermore, slow redo log persistence affects critical database algorithms. With the persistent memory commit accelerator, Oracle Database 19c uses Remote Direct Memory Access (RDMA) to write redo records in persistent memory on multiple storage servers. By using RDMA, the redo log writes are up to 8x faster, and excellent resilience is provided because the redo log is persisted on multiple storage servers.

On each storage server, the persistent memory area contains only the recently written log records and persistent memory space is not required for the entire redo log. Therefore, hundreds of databases can share the persistent memory area, enabling consolidation with consistent performance.

See Persistent Memory and RDMA for details.

Minimum requirements:

- Oracle Exadata System Software release 19.3.0
- Oracle Database 19c
- Oracle Exadata Storage Server X8M-2

## 5.1.3 Support for Oracle Exadata X8M Systems

A new class of Database and Storage Server, designated X8M, are designed to utilize RDMA over Converged Ethernet. Known as RoCE (pronounced rocky), RDMA over Converged Ethernet is the combination of using the existing Remote Direct Memory Access (RDMA) networking verbs, in association with the InfiniBand™ Trade Association (IBTA) standards based extensions for Converged Ethernet to enable high speed fabrics over Ethernet layer 2 and 3 networks. RoCE shares a common API infrastructure with InfiniBand, differing only at the physical and link layers. All existing Exadata Database Machine high-performance architecture and tuning is compatible with the new network.

Exadata Database Machine X8M-2 and X8M-8 Database Servers utilize 100Gb/sec RDMA Network cards, which enables higher IO performance, and, when used in conjunction with Exadata Database Machine X8M-2 Storage Servers with persistent memory acceleration, experience up to 10x lower latency for RDMA reads. All Exadata Database Machine X8M-2 Storage Servers use the 100Gb/sec RDMA network cards, however the Extended Storage Server (XT) does not receive the persistent memory

acceleration. High Capacity and Extreme Flash Storage Servers for the X8M generation receive 1.5 TB of persistent memory per server.

See *Hardware Components of Oracle Exadata Database Machine* in the *Oracle Exadata Database Machine System Overview* for details.

The Oracle Database and Oracle Grid Infrastructure software installations on Exadata Database Machine X8M database servers must meet the minimum release requirements listed in [Oracle Linux Kernel to Unbreakable Enterprise Kernel 5](#) and [Oracle Linux Distribution Upgraded to Oracle Linux 7.7](#).

Exadata Database Machine X8M servers must use Oracle Exadata System Software release 19.3.0 or later.

## 5.1.4 Instant Failure Detection for X8M Systems

Exadata uses heartbeats to detect the failure of various components. Server failure detection normally requires many missed heartbeats to avoid a false failure diagnosis. Exadata uses remote direct memory access (RDMA) on the RoCE network to quickly confirm server failures. Since RDMA uses hardware, the remote ports respond quickly even when the server is heavily loaded.

Instant failure detection is a unique technology that works transparently and enables incredible availability for OLTP applications.

## 5.1.5 KVM for Virtual Environments

KVM is the virtualization technology used with Exadata Database Machine systems configured with RoCE interconnects. KVM provides kernel level hypervisor support, so the host kernel and KVM guest kernel are the same. Oracle Exadata Deployment Assistant (OEDA) is used to create KVM guests and clusters, and a KVM guest uses SR IOV virtual functions for RoCE network connectivity.

Xen is not supported for Exadata Database Machine systems configured with RoCE interconnects, and KVM is not supported on Exadata Database Machine systems configured with InfiniBand interconnects.

See *Managing Oracle VM Domains using KVM* for more information.

## 5.1.6 Faster Encrypted Table Smart Scans

Scans of encrypted tables stored in the in-memory columnar format have been improved by decrypting columns only when needed. Columns in the SELECT set or predicates are the only columns decrypted, not the entire flash cache cacheline. If the first predicate does not return any matches, then the columns for the second predicate are not accessed. This feature has up to 30% faster encrypted smart scans and reduced storage server CPU usage.

For example, consider the following query:

```
SELECT ename FROM emp
WHERE job LIKE '%VP' AND sal + bonus > 500000
```

Only the projected columns (`ename`) and one or more predicated columns are decrypted. The salary in data regions that do not have a VP are not accessed.

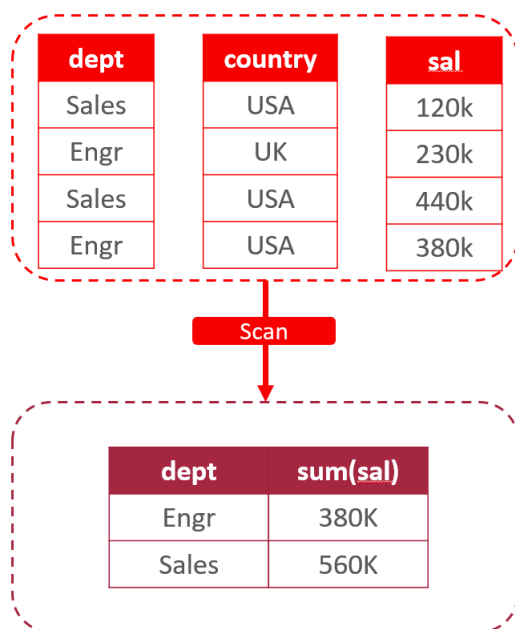
Minimum requirements:

- Oracle Exadata System Software release 19.3.0
- Oracle Database In-Memory option

## 5.1.7 Smart Aggregation

SUM and GROUP BY SQL operations are now smart scan enabled with in-memory columnar format. This feature benefits SQL statements with a low degree of parallelism, such as the following example:

```
SELECT dept, sum(sal) FROM emp
WHERE country='USA' GROUP BY dept;
```



Performance benefits of this feature include:

- Reduces data sent to the database server
- Improves CPU utilization on the database server
- Queries execute up to 2x faster

Minimum requirements:

- Oracle Exadata System Software release 19.3.0
- Oracle Database 18c
- Oracle Database In-Memory option

## 5.1.8 Smart In-Memory Columnar Cache with Row IDs

Oracle Exadata System Software evaluates the predicate in a DML statement to determine the rows of interest. These rows are sent back from the storage servers to the database servers, which then uses the ROWIDs to update the rows. This feature

expands this functionality to return ROWIDs for data stored in columnar compression format.

For example, consider the following SQL query:

```
UPDATE weather_history SET temp = (temp - 32) * (5/9)
WHERE country = 'ENGLAND'
```

Smart scan is used to find the rows that satisfy `country = 'ENGLAND'` using ROWID values returned from a previous phase of the command processing.

This feature can improve the performance of DML statements by up to 5x.

Minimum requirements:

- Oracle Exadata System Software release 19.3.0
- Oracle Database release 18.3.0.0.180717DBRU

## 5.1.9 Smart In-memory Columnar Cache with Chained Rows

Wide tables, large rows or row migration on update can create chained rows. Smart In-memory Columnar Cache works by creating optimized Single Instruction Multiple Data (SIMD) representation for chained rows when the head and tail pieces fit in the same 1 MB region. This results in up to 3x faster scans for wide tables.

Minimum requirements:

- Oracle Exadata System Software release 19.3.0

## 5.1.10 Fast Smart In-memory Columnar Cache Creation

The run-time analyzer finds the best compression algorithm, reusing the dictionary created in-line during the analysis. This provides faster symbol lookup and insert using the new dictionary data structure. The Single Instruction Multiple Data (SIMD) optimized columnar cache creation reuses data from the first pass scan in the flash cache. The result is much faster reads from the flash cache, with an up to 35% improved speed in columnar cache creation.

This feature applies to Exadata Hybrid Columnar Compression tables only.

Minimum requirements:

- Oracle Exadata System Software release 19.3.0
- 

## 5.1.11 Encryption of System Logs to Remote Destinations

Management Server (MS) on storage servers and database servers supports the `syslogconf` attribute, which enables log transfer configuration. This feature adds encryption transfer support for `rsyslog`.

See [Encrypting System Log Information](#) for more information.

Minimum requirements:

- Oracle Exadata System Software release 19.3.0

## 5.1.12 Update a Single SNMP User Definition

This feature adds new syntax to `ALTER CELL` and `ALTER DBSERVER` commands to allow SNMP V3 users to be added, altered, and deleted individually instead of configuring all users in one command string. This feature makes it easier to change the password for an individual SNMP user.

See `ALTER CELL` and `ALTER DBSERVER` for details.

Minimum requirements:

- Oracle Exadata System Software release 19.3.0

## 5.1.13 Securing Storage Server Software Processes with Memory Protection Keys

Memory Protection Keys is a hardware feature found in Exadata Database Machine X7-2 and newer systems. Memory Protection Keys provide a thread local permission control on memory pages without incurring the high cost of Page Table Entry (PTE) modifications and Translation Look-aside Buffer (TLB) flushes.

The Exadata storage server process that performs block IO (`cellsrv`) and the processes that perform smart scans (`celloflsrv`) are now enhanced to run with memory protection keys. This feature is enabled out of the box with no tuning needed. Each thread in these processes needs to obtain access to the appropriate memory protection key before it can access the data. Any access to a piece of memory that does not have the correct key traps the process. This enhances the security and robustness of the storage server processes by eliminating a class of potential memory corruptions.

Minimum requirements:

- Oracle Exadata System Software release 19.3.0
- Exadata Database Machine X7-2

## 5.1.14 Default XFS File System for X8M Servers

To further improve the security of Exadata Database Machine, the new X8M servers will use the XFS file system for bare metal, KVM guests, and storage servers.

New partitions are created for `/home`, `/tmp`, `/var`, and `/var/log/audit`.

Minimum requirements:

- Oracle Exadata System Software release 19.3.0
- Exadata Database Machine X8M servers

## 5.1.15 Oracle Linux Kernel to Unbreakable Enterprise Kernel 5 and Oracle Linux Distribution Upgraded to Oracle Linux 7.7

This release upgrades Oracle Linux to Unbreakable Enterprise Kernel (UEK) 5, (4.14.35-x.el7uek.x86\_64). Oracle Linux Kernel UEK5 introduces support for

persistent memory, ROCE, and KVM on Exadata. The Linux distribution is upgraded to Oracle Linux 7.7.

**Minimum** requirements to upgrade to Oracle Exadata System Software release 19.3.0:

- Oracle Grid Infrastructure:
  - 19c
    - \* 19.5.0.0.191015 with patches or
    - \* 19.4.0.0.190716 with patches
  - 18.7.0.0.190716 with patches
  - 12.2.0.1.0.190716 with patches
  - 12.1.0.2.0.190716 with patches
- Oracle Database:
  - 19.4.0.0.0.190716 with patches
  - 18.7.0.0.0.190716 with patches
  - 12.2.0.1.0.181016
  - 12.1.0.2.0.180831
  - 11.2.0.4.0.180717

Refer to My Oracle Support Doc ID 888828.1 for details about the required patches.

#### Related Topics

- [Exadata Database Machine and Exadata Storage Server Supported Versions \(My Oracle Support Doc ID 888828.1\)](#)

## 5.1.16 Software Certification Ends for Exadata Database Machine X2 Servers

Software certification ends for Oracle Exadata Database Machine X2 servers. This includes the following servers:

- Sun Fire X4170 M2 Server
- Sun Fire X4800 Server
- Sun Fire X4270 M2 Server

## 5.2 What's New in Oracle Exadata Database Machine 19.2.0

The following features are new for Oracle Exadata System Software 19.2.0:

- [Support for New Hardware - X8 Servers](#)
- [Exadata Extended \(XT\) Storage Server](#)
- [Changes to IORM flashcachesize Attribute and Hard Disk I/O Limits](#)

### 5.2.1 Support for New Hardware - X8 Servers

This release includes support for the following hardware:

- Oracle Exadata Database Machine X8-2
- Oracle Exadata Database Machine X8-8
- 14 TB high-capacity drives for Exadata Storage Server X8-2

Minimum requirements:

- Oracle Exadata System Software release 19.2.0

## 5.2.2 Exadata Extended (XT) Storage Server

A new storage configuration is available starting with Exadata Database Machine X8-2. The XT model does not have Flash drives, only 14 TB hard drives with HCC compression. This is a lower cost storage option, with only one CPU, less memory, and with SQL Offload capability turned off by default. If used without the SQL Offload feature, then you are not required to purchase the Oracle Exadata System Software license for the servers.

If you purchase the Oracle Exadata System Software license for the servers and want to enable the SQL Offload capability for the XT storage servers, then you can use this CellCLI command on *each* XT storage server to dynamically enable the SQL Offload feature:

```
$ cellcli -e 'ALTER CELL enableSmartStorage=true'
```

Minimum requirements:

- Oracle Exadata System Software release 19.2.0
- Oracle Exadata Rack X4

## 5.2.3 Changes to IORM flashcachesize Attribute and Hard Disk I/O Limits

The `flashcachesize` IORM attribute and the hard disk I/O limit have been changed:

- The IORM `flashcachesize` attribute can now be used to over-provision the total flash cache.
- The IORM maximum utilization limit does not apply to hard disks.

See *Monitoring IORM Utilization and Understanding I/O Resource Management in the Oracle Exadata System Software User's Guide* for details.

Minimum requirements:

- Oracle Exadata System Software release 19.2.0

## 5.3 What's New in Oracle Exadata Database Machine 19.1.0

The following features are new for Oracle Exadata System Software 19.1.0:

- [Oracle Linux Upgraded to Oracle Linux 7.5](#)
- [Automated Cloud Scale Performance Monitoring](#)



- [Faster Smart Scans Using Column-level Checksum](#)
- [Enhanced OLTP High Availability During Cell Outages and Flash Failures](#)
- [Support for Host and ILOM on Separate Network](#)
- [DB\\_UNIQUE\\_NAME Support for Multiple Clusters Sharing Exadata Storage](#)
- [Secure Eraser Updates](#)
- [Server Time Synchronization Uses Chrony](#)
- [Quorum Disk Manager Service Change](#)
- [Audit Rules File](#)
- [Customizable SYSLOG Format](#)
- [USE\\_LARGE\\_PAGES Default Value Set To AUTO\\_ONLY](#)
- [Security Improvements](#)
- [Deprecated Features in Oracle Exadata System Software Release 19.1.0](#)
- [Desupported Features in Oracle Exadata System Software Release 19.1.0](#)

### 5.3.1 Oracle Linux Upgraded to Oracle Linux 7.5

With Oracle Exadata System Software release 19.1.0, the operating system used on the database servers and storage servers has been updated to Oracle Linux 7.5. The Oracle Linux kernel UEK4 that has been used in previous releases continues to stay the same.

The following Oracle Database and Oracle Grid Infrastructure software releases are supported with Oracle Exadata System Software release 19.1.0 and Oracle Linux 7.5.

Oracle Exadata System Software 19.1.0 and later supports the following Oracle Database software releases:

- Oracle Database and Oracle Grid Infrastructure 19c
- Oracle Database and Oracle Grid Infrastructure 18c
  - Minimum version 18.3.0.0.180717
- Oracle Database and Oracle Grid Infrastructure 12c Release 2 (12.2.0.1.0)
  - Minimum version 12.2.0.1.180717
- Oracle Database and Oracle Grid Infrastructure 12c Release 1 (12.1.0.2.0)
  - Minimum version 12.1.0.2.180831
- Oracle Database 11g Release 2 (11.2.0.4.0)
  - Minimum version 11.2.0.4.180717
  - Requires Oracle Grid Infrastructure release 12.1.0.2.180831 or higher
- Oracle Database 11g Release 2 (11.2.0.3.0)
  - Minimum version 11.2.0.3.28
  - Requires Oracle Grid Infrastructure release 12.1.0.2.180831 or higher
  - Installation of the Oracle Database software is a manual task for this release and is not covered by OEDA.

 **Note:**

There are no further bundle patches for Oracle Database 11g Release 2 (11.2.0.3.0). The patching end date for this release was August 27, 2015.

Refer to New Features and Changes in the *Oracle Linux 7 Release Notes* for information about the Oracle Linux 7 release.

## 5.3.2 Automated Cloud Scale Performance Monitoring

Starting with Oracle Exadata System Software release 19.1.0, Exadata Database Machine provides automated, cloud-scale performance monitoring covering a wide range of sub-systems, including CPU, memory, file system, IO, and network. This feature combines artificial intelligence, years of real-world performance triaging experience, and best practices.

Oracle Exadata System Software can automatically detect performance issues and figure out the root cause without human intervention. Examples of how this feature operates include:

- If a spinning process is taking up all the resources on the system and impacting database performance, Oracle Exadata System Software automatically detects the CPU spin, pinpoints the exact process that is causing the spin, and generates an alert.
- If the Oracle database is not properly configured with huge pages according to the best practice recommendation, Oracle Exadata System Software automatically detects the misconfiguration and generates an alert for the affected database instances.

There is no configuration required for this feature. To receive alerts, you must configure the notification mechanism. See *Monitoring Requests and Alerts for Oracle Exadata Storage Server* and `ALTER DBSERVER`.

As a part of this feature, Management Server (MS) is enabled on user domains (domU) in addition to storage servers, database servers (bare metal configuration), and management domains (dom0).

Minimum requirements:

- Oracle Exadata System Software 19.1.0

## 5.3.3 Faster Smart Scans Using Column-level Checksum

Checksum computation and validation helps to detect errors that may happen during storage or retrieval of data. A checksum is computed when a piece of data is written to Exadata Flash Cache and the checksum is verified on a subsequent read.

Prior to the Oracle Exadata System Software release 19.1.0, a checksum was computed on a block on flash after it was read. This block usually contains multiple columns, but a typical Data Warehousing query only accesses a few columns of a table. In Oracle Exadata System Software release 19.1.0, the unit of checksum computation is reduced to a single column. A checksum is computed for each column and stored in the column compression unit (CU) header. This optimization is enabled only for In-memory Columnar format on Exadata Smart Flash Cache.

The key benefits of the column level checksum approach are:

- **Selective checksum computation:** When smart scan reads a flash block containing the columns of interest, checksum verification is performed only for those specific column CUs even though there are many other columns present in the cache line. This reduces the amount of data on which the checksum is performed resulting in lower CPU usage. For example, consider the predicate  $A < 5$  and  $Z < 10$ . The flash block where column A resides could contain columns B, C, and D. However, because B, C, and D are not referenced in the query, checksums are not performed for B, C, and D.
- **Just in time checksum computation:** Checksums are performed only when a column is processed. For example, consider the predicate  $A < 5$  and  $Z < 10$ . Checksum is computed on the column CU for column A and the predicates are evaluated. If there are no rows satisfying the predicate  $A < 5$ , then there is no reason to evaluate  $Z < 10$ . Checksum computation is not performed on the column CU for column Z. This can greatly reduce the amount of data on which the checksum is performed resulting in lower CPU usage.

This feature is automatically enabled when you configure the `INMEMORY_SIZE` database initialization parameter and upgrade to Oracle Exadata System Software release 19.1.0; no further configuration is required to use this new feature.

See Offloading of Data Search and Retrieval Processing in *Oracle Exadata System Software User's Guide* for more information.

Minimum requirements:

- Oracle Exadata System Software release 19.1.0
- Exadata Smart Flash Cache
- Oracle Database In-Memory option

## 5.3.4 Enhanced OLTP High Availability During Cell Outages and Flash Failures

Oracle Exadata System Software release 19.1.0 introduces a new feature that further enhances the OLTP high availability caused by cell outages and flash failures. This feature provides better application performance after the failure of a flash device or storage server by partially duplicating hot data in the flash cache of multiple storage servers.

If a cell goes offline or a flash device fails, then the databases redirect IOs to use secondary mirrors for data read operations because the primary mirrors are unavailable due to the outage. However, the secondary mirrors might not be in the flash cache of the respective cell, so the databases must read the data from hard disks. This can negatively impact application performance due to flash cache misses.

With this new feature, Oracle Exadata System Software prefetches the secondary mirrors of the OLTP data that is most frequently accessed into the flash cache. This prefetching is done as a background task. Oracle Exadata System Software automatically manages the secondary mirrors in the flash cache in an optimal way so that newer or more active secondary mirrors replace the cold data in the cache. In addition, when a flash device is replaced, this feature also ensures that the newly replaced flash device is made more current (warmed up) before redirecting database read operations to the new flash device. Thus, this feature provides better high availability for application performance by greatly reducing the secondary mirror flash cache misses during cell or flash device failures and flash device replacements.

This feature is useful for OLTP workloads only. Oracle Exadata System Software does not cache the secondary mirrors for scan data. Also, this feature is only enabled for write-back Flash Cache. No secondary mirror caching is done for write-through Flash Cache.

Minimum requirements:

- Oracle Exadata System Software release 19.1.0
- Oracle Database 19c
- Exadata Write Back Flash Cache on High Capacity storage servers
- Exadata Database Machine X6 or later (due to flash cache size requirements)

### 5.3.5 Support for Host and ILOM on Separate Network

Previously Exadata servers and Integrated Lights Out Manager (ILOM) needed to use the same Administrative network for certain features to function properly, like alert notification in Oracle Exadata System Software. Oracle Exadata System Software release 19.1.0 or later eliminates this network dependency while maintaining all the features previously supported.

This feature helps improve security by enabling you to configure a separate network for ILOM so that the Exadata servers and ILOM are completely separate from each other.

See *Configuring a Separate Network for ILOM* in *Oracle Exadata Database Machine Installation and Configuration Guide*.

Minimum requirements:

- Oracle Exadata System Software release 19.1.0

#### Related Topics

- Overview of Network Requirements

### 5.3.6 DB\_UNIQUE\_NAME Support for Multiple Clusters Sharing Exadata Storage

You can now use the same `DB_UNIQUE_NAME` value for databases that share the same storage. This feature enables Oracle Multitenant clustered databases sharing the same storage cells to have the same `DB_UNIQUE_NAME`.

In previous releases, multiple clusters could share Exadata storage if the `DB_UNIQUE_NAME` value for each instance was globally unique across all clusters. In Oracle Exadata System Software release 19.1.0, each cluster can have its own `DB_UNIQUE_NAME` namespace. This means matching `DB_UNIQUE_NAME` values are allowed between different clusters. For example, in prior releases, `cluster1` and `cluster2` could have only one database (either in `cluster1` or `cluster2`) with the `DB_UNIQUE_NAME` parameter set to `db1`. In this release, if each cluster configures ASM-scoped security, then both clusters can have a database with the `DB_UNIQUE_NAME` parameter set to `db1`.

This feature eliminates the need for different clusters that share Exadata storage to coordinate the `DB_UNIQUE_NAME` assignments to avoid a name conflict. Each cluster is

free to choose any `DB_UNIQUE_NAME` value, without having to coordinate with other clusters, as long as ASM-scoped security is configured for each cluster.

When ASM-scoped security is configured, the ASM cluster name is used to qualify the `DB_UNIQUE_NAME` for access to the storage servers. The metrics and stats collected for each database also use the `asmcluster.database` name qualification in various areas including I/O Resource Management (IORM), Flash Cache, quarantines, and cell offloading.

 **WARNING:**

If you configure databases to have the same `DB_UNIQUE_NAME`, then those databases cannot be backed up to Oracle Zero Data Loss Recovery Appliance. The `DB_UNIQUE_NAME` for each database instance must be unique within the scope of the Oracle Zero Data Loss Recovery Appliance.

Minimum requirements:

- Oracle Exadata System Software release 19.1.0
- Each database with the same `DB_UNIQUE_NAME` must be in a different Oracle ASM cluster
- ASM-scoped security configured for each Oracle ASM cluster

**Related Topics**

- [ASSIGN KEY command](#)
- [About Exadata Storage Server Security Modes](#)
- [About Interdatabase Resource Management](#)

## 5.3.7 Secure Eraser Updates

With Oracle Exadata System Software release 19.1.0, various improvements were made to Secure Eraser.

- [Automatic Upgrading of Multi-pass Disk Erasure to Secure Eraser](#)
- [Automatic Secure Eraser as Part of Imaging](#)
- [Secure Eraser Improvements and New Features](#)

### 5.3.7.1 Automatic Upgrading of Multi-pass Disk Erasure to Secure Eraser

If you specify to erase disks using 1pass, 3pass, or 7pass method, Oracle Exadata System Software automatically uses the optimal Secure Eraser method, if it is supported by the underlying hardware.

As disks get larger and larger, the traditional multi-pass overwrite methods such as 1-pass, 3-pass and 7-pass take more time to complete than the erasure method used by Secure Eraser. For example, a 10 TB hard drive can take more than 4 days for 7-pass erase, but only 1 minute using Secure Eraser. See [Securely Erasing Database Servers and Storage Servers](#) for a table of supported hardware and estimated erasure times.

It is much faster and more secure to use Secure Eraser on the disks when it is supported. The Secure Eraser methods used in `DROP CELL` and `DROP CELLDISK` are the same as those in the Secure Eraser feature and are fully compliant with NIST SP-800-88r1 standard.

See DROP CELL and DROP CELLDISK for more information.

Minimum requirements:

- Oracle Exadata System Software 19.1.0
- Oracle Exadata Database Machine X5-2 or later

### 5.3.7.2 Automatic Secure Eraser as Part of Imaging

When re-purposing an Oracle Exadata Rack, it is typically a two-part process where you would first use the Secure Eraser feature introduced in Oracle Exadata System Software release 12.2.1.1.0 to securely erase the data first and then re-image the rack with the desired Exadata Database Machine image.

Starting with Oracle Exadata System Software release 19.1.0, Secure Eraser is automatically started during re-imaging if the hardware supports Secure Eraser. This significantly simplifies the re-imaging procedure while maintaining performance. Now, when re-purposing a rack, you only have to image the rack and the secure data erasure is taken care of transparently as part of the process.

See Overview of Secure Erasure in *Oracle Exadata Database Machine Security Guide* for more information.

Minimum requirements:

- Oracle Exadata System Software release 19.1.0
- Oracle Exadata Database Machine X5-2 or later

### 5.3.7.3 Secure Eraser Improvements and New Features

In this release, the following new features and command options were added to Secure Eraser:

- The timezone is now included with the timestamps in the certificate
- Support for erasing individual devices (`--devices_to_erase`)

See Secure Eraser Syntax in *Oracle Exadata Database Machine Security Guide* for more information.

Minimum requirements:

- Oracle Exadata System Software release 19.1.0
- Oracle Exadata Database Machine X5-2 or later (for crypto erase)

### 5.3.8 Server Time Synchronization Uses Chrony

Starting with Oracle Exadata System Software release 19.1.0, Exadata database servers and storage servers running Oracle Linux 7 no longer use `ntpd`. Instead, `chrony` is used to synchronize the system clock on the servers with NTP servers. `chrony` can usually synchronize the system clock faster and with better time accuracy compared to `ntpd`.

When you upgrade from Oracle Linux 6 to Oracle Linux 7, the NTP server settings are migrated to `chrony`.

All Oracle Grid Infrastructure and Oracle Database releases certified with Oracle Linux 7 also support `chrony`.

Minimum requirements:

- Oracle Exadata System Software release 19.1.0

#### Related Topics

- <https://chrony.tuxfamily.org/comparison.html>

## 5.3.9 Quorum Disk Manager Service Change

Exadata Database Machine database servers and storage servers running Oracle Linux 7 use the `target` service instead of the `tgt` service for the Exadata Quorum Disk Manager.

During the upgrade from Oracle Linux 6 to Oracle Linux 7, Exadata Database Machine database servers that use Quorum Disk Manager are migrated to use the new underlying `target` service. The migration can be done in a rolling fashion. The administration interface for the Quorum Disk Manager remains the same and can be used if any changes are needed after the upgrade to Oracle Linux 7.

Minimum requirements:

- Oracle Exadata System Software release 19.1.0

#### Related Topics

- Overview of Quorum Disk Manager

## 5.3.10 Audit Rules File

During the upgrade from Oracle Linux 6 to Oracle Linux 7 on Exadata database servers, the Oracle Linux 6 audit settings are migrated and moved into to the audit file `01-exadata_audit.rules`. Rules that are not specific to Exadata Database Machine are not migrated during the upgrade. You must reconfigure these rules separately. Oracle recommends creating and maintaining a custom audit rules file for rules that are not specific to Exadata Database Machine.

See Operating System Activity Monitoring on Oracle Exadata Storage Servers in the *Oracle Exadata System Software User's Guide* for more information.

Minimum requirements:

- Oracle Exadata System Software release 19.1.0

## 5.3.11 Customizable SYSLOG Format

A new cell and database server attribute, `syslogFormat`, can be used to change the standard syslog format to any format desired.

When the attribute is set, Management Server (MS) modifies the `/etc/rsyslog.conf` file to contain the format string specified, and restarts the syslog daemon. Setting `syslogFormat` to an empty string removes the format change and the default format is restored.

See ALTER CELL in *Oracle Exadata System Software User's Guide* or ALTER DBSERVER in *Oracle Exadata Database Machine Maintenance Guide* for details.

Minimum requirements:

- Oracle Exadata System Software release 19.1.0

## 5.3.12 USE\_LARGE\_PAGES Default Value Set To AUTO\_ONLY

Starting with Oracle Database 19c, `AUTO_ONLY` is the new default value for the `USE_LARGE_PAGES` database initialization parameter.

When `USE_LARGE_PAGES` is set to `AUTO_ONLY`, if `SGA_TARGET` is specified in the initialization parameter file, then the database calculates how many HugePages are needed to create the SGA and reconfigures the total number of HugePages in the operating system. If there are no pre-provisioned HugePages on the system, then the database automatically requests the amount of HugePages it needs from the operating system. If the request is successful, then the database start up proceeds. If the operating system cannot find enough HugePages to satisfy the request for the database, then the database start up fails.

Minimum requirements:

- Oracle Database release 19.1

## 5.3.13 Security Improvements

With Oracle Exadata System Software release 19.1.0, various security improvements were introduced.

- [Access Control for RESTful Service](#)
- [Password Expiration for Remote Users](#)
- [Advanced Intrusion Detection Environment \(AIDE\)](#)
- [Implementing the Principle of Least Privilege to Improve Security](#)
- [Increased Security for Storage Server Processes](#)
- [SSHD ClientAliveInterval Changed to 600 Seconds](#)
- [Stronger Password Requirements](#)
- [Upload DIAGPACK to Oracle ASR Manager using HTTPs](#)

### 5.3.13.1 Access Control for RESTful Service

Oracle Exadata System Software release 19.1.0 or later introduces a new capability for users to configure access control lists on the HTTPs access to the Exadata RESTful service. Users can specify a list of IP addresses or IP subnet masks to control who can access the RESTful service via HTTPs. Alternatively, if the RESTful service is not used, users can choose to disable HTTPs access to the node altogether. This feature applies to both Oracle Exadata Database Server and Oracle Exadata Storage Server.

See the following topics for more information:

- ALTER CELL
- CREATE CELL
- ALTER DBSERVER
- CREATE DBSERVER



Minimum requirements:

- Oracle Exadata System Software release 19.1.0

### 5.3.13.2 Password Expiration for Remote Users

You can now configure password expiration for remote users that use access the Exadata RESTful service or use ExaCLI. On the Exadata server, you can set attributes to configure password expiration time and whether the user is allowed to remotely change an expired password. Additional attributes can be set to specify the length of the warning period before the password expires, and how long after the password expires before the user account is locked.



#### Note:

This feature applies only to remote users and does not apply to operating system users like `celladmin` or `oracle`.

If these attributes are set on the server, then when a user attempts to connect to an account with an expired password, one of two things happens:

- If the server is configured to permit changing the password remotely, then the user is prompted to change the password immediately.
- If the server does not allow changing the password remotely, then the user is presented with an error indicating the password is expired and they will need assistance in getting it changed.

See the following topics for more information:

- Security Policies for Oracle Exadata Storage Servers
- DESCRIBE DBSERVER
- DESCRIBE CELL

Minimum requirements:

- Oracle Exadata System Software release 19.1.0

### 5.3.13.3 Advanced Intrusion Detection Environment (AIDE)

Oracle Exadata System Software release 19.1.0 adds support for Advanced Intrusion Detection Environment (AIDE) to help guard against unauthorized access to the files on your Exadata system. AIDE is a security feature that reports any malicious or unplanned change to the system. AIDE creates a database of files on the system, and then uses that database to ensure file integrity and to detect system intrusions.

See the following topics for more information:

- Guarding Against Unauthorized Operating System Intrusions
- [https://en.wikipedia.org/wiki/Advanced\\_Intrusion\\_Detection\\_Environment](https://en.wikipedia.org/wiki/Advanced_Intrusion_Detection_Environment)

Minimum requirements:

- Oracle Exadata System Software release 19.1.0

### 5.3.13.4 Implementing the Principle of Least Privilege to Improve Security

Security best practices require that each process run with the lowest privileges needed to perform the task. The following processes now run as non-privileged users:

- **Smart Scan processes**

The processes that perform a smart scan on the Oracle Exadata Storage Server used to run with the `root` user privilege. Performing predicate evaluation does not require root privileges. Starting with Oracle Exadata System Software release 19.1.0, these smart scan processes are owned by a new operating system user called `cellofl`. The user `cellofl` and group `celltrace` are automatically created when you perform a Software Update to Oracle Exadata System Software release 19.1.0.

- **Select ExaWatcher processes**

The ExaWatcher infrastructure is responsible for collecting and archiving system statistics on both the Oracle Exadata Database Servers and Oracle Exadata Storage Servers. Some of the commands that collect `iostat`, `netstat`, `ps`, `top`, and other information have been modified to run without requiring `root` user privilege. The new operating system user `exawatch` and group `exawatch` are automatically created when you perform a Software Update on the Oracle Exadata Storage Server, Oracle Exadata Database Server, and within a virtual machine running on the Oracle Exadata Database Server.

As a result of these changes, the number of processes running as the `root` user is significantly reduced which improves security on Oracle Exadata servers.

This feature is automatically enabled by performing a software update to Oracle Exadata System Software release 19.1.0. No additional configuration is required.

See the following topics for more information:

- [Understanding User Accounts](#)
- [Offloading of Data Search and Retrieval Processing](#)
- [ExaWatcher Charts](#)

### 5.3.13.5 Increased Security for Storage Server Processes

The secure computing (`seccomp`) feature in the Oracle Linux kernel is used to restrict the system calls that can be made from a process.

The Oracle Linux kernel has a few hundred system calls, but most of them are not needed by any given process. A `seccomp` filter defines whether a system call is allowed or restricted. `Seccomp` filters are installed for cell server and cell offload server processes automatically on an upgrade. An allowlist of system calls are allowed to be made from cell server and cell offload server. For certain allowlist system calls, the `seccomp` filters perform an additional validation of the arguments.

`Seccomp` filters provide a higher level of security for the cell processes. This feature is automatically enabled in Oracle Exadata System Software release 19.1.0.

#### Related Topics

- [Oracle Linux containers security blog](#)

### 5.3.13.6 SSHD ClientAliveInterval Changed to 600 Seconds

The `ClientAliveInterval` parameter causes the SSH client to time out automatically after a period of inactivity, which is specified in seconds. When the specified time limit has been reached, if no data has been received from the client, SSHD sends a message through the encrypted channel to request a response from the client. If no response is received from the server side, then the connection is discarded. Previously `ClientAliveInterval` was set to 2 hours on the storage servers and 24 hours on the database servers. These large values were required to keep the `dcli` calls made from `patchmgr` from timing out.

The `patchmgr` utility has also been modified. `dcli` calls made from `patchmgr` use run-time parameters to extend the timeout limit. This prevents the calls from timing out if there is no communication from the server for more than 10 minutes.

If you require a long-running connection to the database servers, such as when taking operating system backups, you can specify a larger value for `ClientAliveInterval` in the `/etc/ssh/sshd_config` file. You must restart the SSH service for changes to take effect. After the long running operation completes, you must remove the modification to the `ClientAliveInterval` and restart the SSH service.

### 5.3.13.7 Stronger Password Requirements

When creating operating system users on the database servers and storage servers, the new Exadata default password policy rules are:

- Minimum characters: 8
- Minimum numbers: 1
- Minimum lowercase characters: 1
- Minimum uppercase characters: 1
- Minimum special characters: 1
- Maximum consecutive repeating characters: 3
- Maximum consecutive repeating characters of the same class: 4
- Minimum number of different characters: 8
- Minimum days for password change: 1
- Maximum days for password change: 60
- Dictionary words are not valid or accepted.
- The last ten passwords cannot be reused

 **Note:**

Passwords that were created before the new restrictions were added in Oracle Exadata System Software release 19.1.0 will continue to work without issue. If you use SSH equivalence, then you should notice no difference.

See the following topics for more information:

- Default Security Setting Enacted by OEDA

- Security Policies for Oracle Exadata Storage Servers

Minimum requirements:

- Oracle Exadata System Software release 19.1.0

### 5.3.13.8 Upload DIAGPACK to Oracle ASR Manager using HTTPs

For enhanced security, you can configure Management Server (MS) and Oracle ASR Manager to upload diagnostic packages using HTTPs.

See [Enabling Automatic Diag Pack Upload for ASR](#) for information.

## 5.3.14 Deprecated Features in Oracle Exadata System Software Release 19.1.0

The following features are deprecated in this release, and may be desupported in a future release:

- [Deprecation of Interleaved Grid Disks](#)
- [Deprecation of nfsimg Images](#)

### 5.3.14.1 Deprecation of Interleaved Grid Disks

The interleaving option for grid disks has been deprecated. Attempts to create interleaved grid disks will be automatically converted to a normal grid disk creation.

Interleaved grid disks created before Oracle Exadata System Software release 19.1.0 continue to work as they did in previous releases.

### 5.3.14.2 Deprecation of nfsimg Images

When imaging or re-imaging an Oracle Exadata Database Machine server, starting with Oracle Exadata System Software release 19.1.0, NFS images have been deprecated. Use the PXE option with ISO image files instead of NFS image files.

The Secure Eraser package (`secureeraser_label.zip`) also contains ISO images instead of NFS images starting with Oracle Exadata System Software release 19.1.0.

The relevant sections in the documentation have been updated to reflect this change.

- [Imaging a New System in the \*Oracle Exadata Database Machine Installation and Configuration Guide\*](#) has the updated imaging instructions
- [Securely Erasing Oracle Exadata Database Machine in the \*Oracle Exadata Database Machine Security Guide\*](#) has the updated Secure Eraser instructions

## 5.3.15 Desupported Features in Oracle Exadata System Software Release 19.1.0

Oracle Exadata V2 is no longer certified, starting with Oracle Exadata System Software release 19.1.0. The current certification information can be found in [Exadata System Software Certification \(My Oracle Support Doc ID 2075007.1\)](#)

# 6

## New Features for Oracle Exadata System Software Release 18

Several new features were introduced for Oracle Exadata System Software Release 18.

- [What's New in Oracle Exadata Database Machine 18c \(18.1.0\)](#)
- [Oracle Exadata Database Machine X7 New Features](#)

The following new features are available with Oracle Exadata Database Machine X7:

### 6.1 What's New in Oracle Exadata Database Machine 18c (18.1.0)

The following features are new for Oracle Exadata System Software 18c (18.1.0):

- [In-Memory OLTP and Consolidation Acceleration](#)
- [In-Memory Columnar Caching on Storage Servers](#)
- [Oracle Exadata Storage Server Cloud Scale Software Update](#)
- [Faster Oracle Exadata Database Server Software Update](#)
- [Improved Ethernet Performance in Oracle VM](#)
- [Performance Improvement Following Disk Online Completion](#)
- [Improved High Availability After Flash Failures](#)
- [IORM Maximum Utilization Limit Applies to Flash Devices](#)
- [OEDA Command Line Interface](#)

#### 6.1.1 In-Memory OLTP and Consolidation Acceleration

Oracle Exadata Storage Servers add a new memory cache in front of flash memory. This is similar to how the current flash cache is in front of hard disks. This feature provides 100 microsecond ( $\mu\text{s}$ ) online transaction processing (OLTP) read IO latency, which is 2.5 times lower than the 250  $\mu\text{s}$  flash OLTP read IO latency. You can use existing memory upgrade kits to add more memory to storage servers to take advantage of this feature.

Cell RAM cache is a cache in front of the Flash Cache on storage servers and is extension of the database cache. It is faster than the Flash Cache, but has smaller capacity. When buffers are aged out of the database buffer cache, the database notifies the cells so that the cell RAM cache can be populated with these buffers according to caching policies. These buffers are exclusively cached in the cell RAM cache. If a data block needs to be returned to the database buffer cache, then the buffer, if present, is evicted from the cell RAM cache. The cell RAM cache is an exclusive cache — the data block is present only in the cell RAM cache or in the database buffer cache, but not in both.

During read operations, if a data block is not found in the database buffer cache (cache miss), then the database issues a read for the data block from the cell. CELLSRV checks the RAM cache before accessing a lower layer in the IO stack (flash memory or hard disk):

- If the data block is found in the RAM cache, then the data block is returned synchronously to the database. If the data block is going to be cached in database buffer cache, then the storage server evicts the data block from RAM cache.
- If the data block is not found in RAM cache, then the storage server looks in the Flash cache. If the data block is not found in the Flash cache, then the data block is read from disk. The data block is returned to the database, but the data block is not added to the RAM cache.

During write operations, the database issues a write for a data block to the storage server. Cell Server (CELLSRV) checks the RAM cache before accessing a lower layer in the IO stack (Flash Cache or hard disk):

- If the data block is found in the RAM cache, then CELLSRV invalidates the corresponding cache line in the RAM cache, and sends the data block to the lower layer to be written to disk. The RAM cache is not populated.
- If the data block is not found in RAM cache, then the storage server sends the data block to the lower layer to be written to disk. The RAM cache is not populated.

Unlike the flash cache, the RAM cache on the storage servers is an exclusive cache — the data block stored is present either in RAM cache or in the buffer cache of the database, but not both. When the database evicts a data block from buffer cache, it instructs CELLSRV to populate the data block in the RAM cache. CELLSRV populates the RAM cache in an asynchronous manner.

In the event of storage server failure on the primary mirror, the database sends the RAM cache population to the secondary mirror, so that the blocks are now cached in the RAM cache for the secondary mirror. When the primary mirror comes back to online state, the blocks are populated back in the primary mirror's RAM cache.

A new Memory Cache section is available in the AWR report for monitoring RAM cache status and activities.

Minimum requirements:

- Oracle Exadata System Software 18c (18.1.0)
- Oracle Exadata Storage Server X6 or X7
- Oracle Database version 12.2.0.1 April 2018 DBRU or 18.1 or higher

#### Related Topics

- [Managing the RAM Cache on the Storage Servers](#)

## 6.1.2 In-Memory Columnar Caching on Storage Servers

Oracle Exadata System Software release 12.2.1.1.0 introduced the support for In-Memory Columnar Caching on Oracle Exadata Storage Servers for Exadata Hybrid Columnar Compression tables. Oracle Exadata System Software 18c (18.1.0) extends the support for In-Memory Columnar Caching on storage servers for additional table types, specifically uncompressed tables and OLTP compressed tables.

By extending the Database In-Memory format for uncompressed tables and OLTP compressed tables, smart scan queries on more table types can benefit from fast vector-processing in-memory algorithms on data stored in the storage flash cache. With this format, most in-memory performance enhancements are supported in Smart Scan including joins and aggregation. Database In-Memory format is space efficient and usually takes up less space than uncompressed or OLTP compressed formats. Storing data in Database In-memory format results in better storage flash cache space utilization.

Rewriting data from the traditional uncompressed or OLTP compressed format to Database In-Memory format is very CPU intensive. Oracle Exadata System Software has built-in intelligence to cache data in Database In-Memory format for regions that are not modified frequently.

Data from normal (unencrypted) as well as encrypted tablespaces can be cached in the in-memory columnar cache format.

Just as with Oracle Database In-Memory, the new Database In-Memory format is created by a background process so that it does not interfere with the performance of queries.

This feature is enabled by default when you configure the `INMEMORY_SIZE` database initialization parameter; no further configuration is required to use this new feature. If `INMEMORY_SIZE` is not configured, then uncompressed tables and OLTP compressed table data is cached in Flash Cache in its native format and not in the Database In-Memory columnar format.

If you need to disable this feature, you can use a new DDL keyword `CELLMEMORY` with the `ALTER TABLE` command. See "Enabling or Disabling In-Memory Columnar Caching on Storage Servers" in *Oracle Exadata System Software User's Guide*.

Minimum requirements:

- Oracle Exadata System Software 18c (18.1.0)
- Oracle Database 12c release 1 (12.1.0.2) version 12.1.0.2.161018DBBP or Oracle Database 12c release 2 (12.2.0.1)
- Patch for bug 24521608 if using Oracle Database 12c release 1 (12.1.0.2)
- (Recommended) Patch for bug 26261327 (Enables better reverse offload functionality for complex queries)

### 6.1.3 Oracle Exadata Storage Server Cloud Scale Software Update

The Oracle Exadata Storage Server Cloud Scale Software Update feature introduces a brand new cloud-scale software update process for storage servers. You point the storage servers to a software store. The storage servers download new software in the background. You can schedule the preferred time of software update. Storage servers automatically upgrade the Oracle Exadata System Software in a rolling fashion while keeping the databases online. A single software repository can be used for hundreds of storage servers. This feature provides simpler and faster software updates for Cloud and On-Premise customers.

Each storage server downloads the software to its active partition, and then loads the software on its passive partition. The storage servers then reboot to the new version according to a specified schedule.

This feature improves scalability of software updates by allowing storage servers to update without dedicated `patchmgr` sessions. When updating hundreds of storage servers, administrators can use `dcli` to issue `ALTER SOFTWAREUPDATE` commands to set the software



location and time parameters for all storage servers. Multiple software locations could be used for very large deployments to reduce contention.

See Scheduling Automated Updates of Storage Servers in the *Oracle Exadata Database Machine Maintenance Guide* for details.

Minimum requirements:

- Oracle Exadata System Software 18c (18.1.0). You can use this feature to install subsequent software updates.

## 6.1.4 Faster Oracle Exadata Database Server Software Update

The Oracle Exadata Database Server software update process now takes significantly less time than before and is up to 40% faster compared to previous releases. This helps reduce the cost and effort required to update the software on database server.

Minimum requirements:

- Oracle Exadata System Software 18c (18.1.0)

## 6.1.5 Improved Ethernet Performance in Oracle VM

Oracle Exadata System Software 18c (18.1.0) has optimized receive and transmit of Ethernet packets for systems using virtualization. This optimization provides significant network performance boost with lower network latency and improved CPU utilization on the management domain (dom0) and user domains (domU).

Minimum requirements:

- Oracle Exadata System Software 18c (18.1.0)

## 6.1.6 Performance Improvement Following Disk Online Completion

In previous releases, during Oracle ASM resync operations, if the cachelines are not cached in source storage server, even if they have been cached in target storage server, Oracle Exadata System Software evicts them from the flash cache of the target storage server. This potentially impacted primary mirrors, resulting in cache misses and degraded performance.

Starting with this release, Oracle Exadata System Software ensures that cachelines in the Oracle ASM resync chunk region that are already in the flash cache are preserved, instead of being invalidated. This helps prevent cache misses. This feature provides significant performance improvement compared to earlier version releases for during Oracle ASM resync operations.

Minimum requirements:

- Oracle Exadata System Software 18c (18.1.0)

## 6.1.7 Improved High Availability After Flash Failures

Overall system performance after flash failures has been improved. Previously, after a flash failure, Oracle ASM would start reading from the disks on the affected Oracle Exadata Storage Server as soon as flash resilvering completes. However, the storage server would still have a fewer than normal number of flash devices, so performance on that storage server was affected. Starting with Oracle Exadata System Software



18c (18.1.0), Oracle ASM starts reading from the disks only after all failed flash devices are replaced on that storage server.

Minimum software required:

- Oracle Exadata System Software 18c (18.1.0)

## 6.1.8 IORM Maximum Utilization Limit Applies to Flash Devices

Starting with Oracle Exadata System Software release 18c (18.1.0), using `LIMIT` in an I/O Resource Management (IORM) plan directive or `max_utilization_limit` in an intra-database resource plan directive restricts the I/O utilization for a database on flash devices as well hard disks.

The concept of maximum utilization limit (`LIMIT`) is supported by IORM. In addition to specifying the resource allocation values, you can also provide a maximum utilization limit for a given database. This directive ensures that the database never utilizes I/O resources beyond the specified limits. For example, if a production and test database are sharing the Exadata cell, then you could specify `LIMIT` for the test database to limit the I/O utilization for the test database.

If a maximum utilization limit is specified, then excess capacity is never used by the databases. It is possible that the disks are running below full capacity when maximum utilization limits are specified.

See `ALTER IORMPLAN` or *Understanding I/O Resource Management*.

Minimum software required:

- Oracle Exadata System Software 18c (18.1.0)

## 6.1.9 OEDA Command Line Interface

The Oracle Exadata Deployment Assistant (OEDA) command-line interface (`oedacli`) is a new interface you can use to update an existing `es.xml` file. These updates are called **Actions**. An Action is a single atomic task. An example of an Action might be to create a new Guest. An Action can have many sub commands; however, most actions are single commands. Examples of multi-command steps are `CLONE GUEST` and `CLONE CELL`.

You can use `oedacli` to help with various Exadata life cycle management tasks, such as:

- Add node to or remove node from a Virtual Cluster on Oracle Exadata Database Machine
- Add database home to or remove database home from physical cluster
- Add or remove storage cells
- Resize Oracle ASM disk groups
- Add or remove additional databases
- Add or remove additional database homes to an Oracle VM cluster

See *About the OEDA Command Line Interface* in the *Oracle Exadata Database Machine Installation and Configuration Guide* for details.

Minimum software required:

- Oracle Exadata System Software 18c (18.1.0)
- Oracle Exadata Deployment Assistant (OEDA), August 2017 release

## 6.2 Oracle Exadata Database Machine X7 New Features

The following new features are available with Oracle Exadata Database Machine X7:

- [Do Not Service LED on Storage Servers](#)
- [Online Flash Disk Replacement for Oracle Exadata Storage Server X7](#)
- [New Configuration for System Partitions on Storage Servers](#)
- [Secure Boot](#)

### 6.2.1 Do Not Service LED on Storage Servers

Powering off an Oracle Exadata Storage Server in a cluster with reduced redundancy may cause Oracle ASM disk group force dismount and compromise data availability. To prevent human errors such as mistakenly powering off the wrong storage server, on Oracle Exadata Database Machine X7 come with a new Do Not Service LED. This LED indicates whether it is safe to power off the Oracle Exadata Storage Server for services. Starting with Oracle Exadata System Software release 18.1, the Do Not Service LED is turned on automatically in real-time when redundancy is reduced to inform system administrators or field engineers that the storage server should not be powered off for services.

For example, if a storage server or disk is offline, Oracle Exadata System Software automatically turns on the Do Not Service LED on the storage servers that contain the partner disks to indicate these servers should not be turned off for servicing. When redundancy is restored, Oracle Exadata System Software automatically turns off the Do Not Service LED to indicate that the storage server can be powered off for servicing.

See the following for additional details:

- Exadata Storage Server X7-2 LEDs in the *Oracle Exadata Database Machine Maintenance Guide*
- LIST CELL in the *Oracle Exadata System Software User's Guide*

Minimum requirements:

- Oracle Exadata System Software release 18.1.0.0.0
- Oracle Grid Infrastructure:
  - Release 12.1.0.2 July 2017 BP with ARU 21405133
  - Release 12.1.0.2 October 2017 BP or later
  - Release 12.2.0.1 July 2017 BP with ARU 21405125
  - Release 12.2.0.1 October 2017 BP or later
- Oracle Exadata Database Machine X7-2 or X7-8 (storage servers only)

### 6.2.2 Online Flash Disk Replacement for Oracle Exadata Storage Server X7

Previous generations of Oracle Exadata Database Machine allowed for online flash disk replacement in Oracle Exadata Storage Server X7-2 Extreme Flash, but flash disk

replacement in Oracle Exadata Storage Server X7-2 High Capacity still required server downtime. Starting with Oracle Exadata Database Machine X7-2L and X7-8, flash disks in Oracle Exadata Storage Server X7-2 High Capacity can also be replaced online without server downtime.

Oracle Exadata System Software constantly monitors flash disk health. If a flash disk fails or experiences poor performance, then the disk can be replaced right away. If a flash disk enters predictive failure, then, to ensure redundancy, flash disk should not be replaced until:

- Oracle ASM disk rebalance completes if the device is used as data grid disk
- Flash cache flush completes if the device is used for flash cache

Oracle Exadata System Software automatically monitors the progress of Oracle ASM disk rebalance and flash cache flush operations and sends a notification to users once the flash disk can be safely replaced without compromising redundancy. In any case, when it's safe to replace a flash disk, Oracle Exadata System Software automatically prepares the flash disk for online replacement and moves the flash disk to `dropped for replacement` status to indicate it's ready to be replaced. In addition, Oracle Exadata System Software automatically turns on the attention LED on the flash card and turns off the power LED on the card to help identify the card to replace.

System administrators or field engineers can open the chassis without shutting down the storage server, easily identify the card by the LED pattern, and replace the disks.

See *Performing a Hot Pluggable Replacement of a Flash Disk in Oracle Exadata Database Machine Maintenance Guide* for details.

Minimum requirements:

- Oracle Exadata Storage Server X7-2 Extreme Flash
- Oracle Exadata System Software release 18.1.0.0.0 and Oracle Exadata Storage Server X7-2 High Capacity or Oracle Exadata Database Machine X7-8

## 6.2.3 New Configuration for System Partitions on Storage Servers

Previous generations of Oracle Exadata Database Machine use portions of two disks at slot 0 and 1 as system partitions. This is where the operating system and Oracle Exadata System Software are installed. Starting with Oracle Exadata Database Machine X7, there are two M.2 disks dedicated for system partitions. All hard disks on Oracle Exadata Storage Server X7-2 High Capacity and all flash disks on Oracle Exadata Storage Server X7-2 Extreme Flash are dedicated now for data storage only.

This configuration separates the system I/Os from the data I/Os and improves the performance on data disks at slot 0 and 1. Storage server disks now can be created on the entire disks at slot 0 and 1 and have a uniform size across all disks.

Additionally, Oracle Exadata System Software creates system partitions on the M.2 disks with the latest Intel Rapid Storage Technology enterprise (Intel RSTe) RAID, which delivers faster performance and better data protection compared to the traditional software RAID.

Oracle Exadata System Software also supports online replacement of the M.2 disks. The M.2 disks can be replaced without server downtime.

See *Maintaining the M.2 Disks of Exadata Storage Servers in Oracle Exadata Database Machine Maintenance Guide* for details.

Minimum software required:

- Oracle Exadata System Software 18c (18.1.0)
- Oracle Exadata Database Machine X7-2 or Oracle Exadata Database Machine X7-8

## 6.2.4 Secure Boot

Secure Boot is a method used to restrict which binaries can be executed to boot the system. With Secure Boot, the system UEFI firmware will only allow the execution of boot loaders that carry the cryptographic signature of trusted entities. In other words, anything run in the UEFI firmware must be *signed* with a key that the system recognizes as trustworthy. With each reboot of the server, every executed component is verified. This prevents malware from hiding embedded code in the boot chain.

- Intended to prevent boot-sector malware or kernel code injection
- Hardware-based code signing
- Extension of the UEFI firmware architecture
- Can be enabled or disabled through the UEFI firmware

See Restricting the Binaries Used to Boot the System in *Oracle Exadata Database Machine Security Guide* for details.

Minimum software required:

- Oracle Exadata System Software release 18c (18.1.0)
- Oracle Exadata Database Machine X7-2 or X7-8
- Bare metal installation

# 7

## New Features for Oracle Exadata System Software Release 12.x

Several new features were introduced for the various versions of Oracle Exadata System Software Release 12.x.

- [What's New in Oracle Exadata Database Machine 12.2.1.1.0](#)
- [What's New in Oracle Exadata Database Machine 12c Release 1 \(12.1.2.3.0\)](#)
- [What's New in Oracle Exadata Database Machine 12c Release 1 \(12.1.2.2.0\)](#)
- [What's New in Oracle Exadata Database Machine 12c Release 1 \(12.1.2.1.2\)](#)
- [What's New in Oracle Exadata Database Machine 12c Release 1 \(12.1.2.1.1\)](#)
- [What's New in Oracle Exadata Database Machine 12c Release 1 \(12.1.2.1.0\)](#)
- [What's New in Oracle Exadata Database Machine 12c Release 1 \(12.1.1.1.1\)](#)
- [What's New in Oracle Exadata Database Machine 12c Release 1 \(12.1.1.1.0\)](#)

### 7.1 What's New in Oracle Exadata Database Machine 12.2.1.1.0

The following features are new for Oracle Exadata Database Machine 12.2.1.1.0:

- [In-Memory Columnar Caching on Storage Servers](#)
- [Columnar Flash Cache for Encrypted Tablespace](#)
- [Set Membership in Storage Indexes](#)
- [Storage Index to Store Column Information for More Than Eight Columns](#)
- [5x Faster Oracle Exadata System Software Updates](#)
- [Faster Performance for Large Analytic Queries and Large Loads](#)
- [Secure Eraser](#)
- [Cell-to-Cell Offload Support for ASM-Scoped Security](#)  
To perform cell-to-cell offload operations efficiently, storage servers need to access other storage servers directly, instead of through a database server.
- [Adding an Additional Network Card to Oracle Exadata Database Machine X6-2 Database Servers](#)
- [Automatic Diagpack Upload for Oracle ASR](#)
- [CREATE DIAGPACK and LIST DIAGPACK Commands Available for Oracle Exadata Database Servers](#)
- [Rescue Plan](#)
- [Support for IPv6 Oracle VM and Tagged VLANs](#)
- [Management Server Can Remain Online During NTP, DNS, and ILOM Changes](#)
- [New Charts in ExaWatcher](#)

- [New Metrics for Redo Log Writes](#)  
New metrics are available to help analyze redo log write performance.
- [Quarantine Manager Support for Cell-to-Cell Rebalance and High Throughput Write Operations](#)
- [ExaCLI and REST API Enabled for Management Server](#)  
Both ExaCLI and REST API are enabled for Management Server (MS) on the database servers.
- [New Features in Oracle Grid Infrastructure 12.2.1.1.0](#)
- [New Features in Oracle Database 12c Release 2 \(12.2.0.1\)](#)
- [Oracle Linux Kernel Upgraded to Unbreakable Enterprise Kernel 4 and Oracle VM Upgraded to 3.4.2](#)

## 7.1.1 In-Memory Columnar Caching on Storage Servers

Oracle Exadata System Software release 12.2.1.1.0 can use fast vector-processing in-memory algorithms on data in the storage flash cache. This feature is available if you have licensed the Oracle Database In-Memory (Database In-Memory) option.

Oracle Exadata System Software release 12.1.2.1.0 added a columnar flash cache format which automatically stored Exadata Hybrid Columnar Compression data in pure columnar Exadata Hybrid Columnar Compression format in the flash cache. This release extends support for Exadata Hybrid Columnar Compression data to enable the cached data to be rewritten into Database In-Memory format and enabling ultra-fast single instruction, multiple data (SIMD) predicates to be used in Smart Scan. With this format, most in-memory performance enhancements are supported in Smart Scan including joins and aggregation.

Data from normal (unencrypted) as well as encrypted tablespaces can be cached in the in-memory columnar cache format.

Just as with Oracle Database In-Memory, the new Database In-Memory format is created by a background process so that it does not interfere with the performance of queries.

This feature is enabled by default when the `INMEMORY_SIZE` database initialization parameter is configured and the user does not need to do anything to get this enhancement. See `INMEMORY_CLAUSE_DEFAULT` in *Oracle Database Reference* for information about `INMEMORY_SIZE`. If `INMEMORY_SIZE` is not configured, then the Exadata Hybrid Columnar Compression format columnar cache is still used exactly as in 12.1.2.1.0.

If you need to disable this feature, you can use a new DDL keyword `CELLMEMORY` with the `ALTER TABLE` command. See *Enabling or Disabling In-Memory Columnar Caching on Storage Servers* in *Oracle Exadata System Software User's Guide*.

Minimum requirements:

- Oracle Database 12c release 1 (12.1.0.2), minimum software version required is 12.1.0.2.161018DBBP or
- Oracle Database 12c release 2 (12.2.0.1)
- Patch for bug 24521608

**Related Topics**

- *Oracle Database In-Memory Guide*
- Enabling or Disabling In-Memory Columnar Caching on Storage Servers

## 7.1.2 Columnar Flash Cache for Encrypted Tablespace

In Oracle Exadata System Software 12.2.1.1.0, columnar flash cache support has been extended to encrypted tablespaces. If you have licensed the Oracle Database In-Memory (Database In-Memory) option, the encrypted tablespace data is stored in in-memory columnar format on storage flash cache. If you have not licensed the option, the encrypted tablespace data is stored in pure columnar Exadata Hybrid Columnar Compression format on storage server flash cache.

Minimum requirements:

- Oracle Database 12c release 1 (12.1.0.2), minimum software version required is 12.1.0.2.161018DBBP or
- Oracle Database 12c release 2 (12.2.0.1)
- Patch for bug 24521608

## 7.1.3 Set Membership in Storage Indexes

In Oracle Exadata System Software release 12.2.1.1.0, when data has been stored using the in-memory format columnar cache, Oracle Exadata Database Machine stores these columns compressed using dictionary encoding. For columns with fewer than 200 distinct values, the storage index creates a very compact in-memory representation of the dictionary and uses this compact representation to filter disk reads based on equality predicates. This feature is called **set membership**. A more limited filtering ability extends up to 400 distinct values.

For example, suppose a region of disk holds a list of customers in the United States and Canada. When you run a query looking for customers in Mexico, Oracle Exadata Storage Server can use the new set membership capability to improve the performance of the query by filtering out disk regions that do not contain customers from Mexico. In Oracle Exadata System Software releases earlier than 12.2.1.1.0, which do not have the set membership capability, a regular storage index would be unable to filter those disk regions.

Minimum requirements:

- Oracle Database 12c release 1 (12.1.0.2), minimum software version required is 12.1.0.2.161018DBBP or
- Oracle Database 12c release 2 (12.2.0.1)
- Patch for bug 24521608

## 7.1.4 Storage Index to Store Column Information for More Than Eight Columns

In Oracle Exadata System Software releases earlier than 12.2.1.1.0, storage indexes can hold column information for up to eight columns. In Oracle Exadata System Software release 12.2.1.1.0, storage indexes have been enhanced to store column information for up to 24 columns.

Space to store column information for eight columns is guaranteed. For more than eight columns, space is shared between column set membership summary and column minimum/maximum summary. The type of workload determines whether set membership summary gets stored in storage index.

See [Set Membership in Storage Indexes](#) for more information.

## 7.1.5 5x Faster Oracle Exadata System Software Updates

Updating Oracle Exadata System Software now takes even less time. The Oracle Exadata System Software update process is now up to 2 times faster compared to 12.1.2.3.0, and up to 5 times faster compared to releases earlier than 12.1.2.3.0. A faster update time reduces the cost and effort required to update the software.

## 7.1.6 Faster Performance for Large Analytic Queries and Large Loads

Temp writes and temp reads are used when large joins or aggregation operations don't fit in memory and must be spilled to storage. In Oracle Exadata System Software releases earlier than 12.2.1.1.0, temp writes were not cached in flash cache; both temp writes and subsequent temp reads were from hard disk only. In Oracle Exadata System Software release 12.2.1.1.0, temp writes are sent to flash cache so that subsequent temp reads can be read from flash cache as well. This significantly speeds up queries that spill to temp if they are temp I/O bound. For certain queries, performance can improve up to four times faster. This is comparable to putting the temporary tablespace entirely in flash. Write-back flash cache has to be enabled for this feature to work.

Prior to Oracle Exadata System Software release 12.2.1.1.0, there was a size threshold for writes to the flash cache. Most writes over 128 KB are routed straight to disk because these writes are not expected to be read any time soon. For example, direct load writes, flashback database log writes, archived log writes, and incremental backup writes would bypass flash cache. Starting with Oracle Exadata System Software release 12.2.1.1.0, the flash cache algorithms have been enhanced to redirect such large writes into the flash cache, provided that such large writes do not disrupt the higher priority OLTP or scan workloads. Such writes are later written back to the disks when the disks are less busy. This feature allows Oracle Exadata Storage Server to utilize additional spare flash capacity and I/O bandwidth to provide better overall performance.

Note that this feature is supported on all Oracle Exadata Database Machine hardware except for V2 and X2 storage servers. On X3 and X4 storage servers, flash caching of temp writes and large writes is not supported when flash compression is enabled.

New statistics and report sections related to this feature were added to Automatic Workload Repository (AWR) reports in Oracle Database 18c (18.1.0), also available in the 12.1.0.2.0 July 2017 DBBP and the 12.2.0.1.0 Oct 2017 RUR.

Minimum requirements:

- Oracle Exadata Database Machine X3-2 or later
- Oracle Exadata System Software 12.2.1.1.0
- Oracle Database (one of the following):
  - Oracle Database 11g release 2 (11.2) with the fix for bug 24944847 applied
  - Oracle Database 12c release 1 (12.1) — 12.1.0.2.0 July 2017 DBBP



- Oracle Database 12c release 2 (12.2.0.1) — 12.2.0.1.0 Oct 2017 RUR
- Oracle Database 18c (18.1.0)

## 7.1.7 Secure Eraser

Oracle Exadata System Software software releases 12.2.1.1.0 or later provide a secure erasure solution, called Secure Eraser, for every component within Oracle Exadata Database Machine. This is a comprehensive solution that covers all Exadata Database Machines V2 and higher, including both 2-socket and 8-socket servers.

In earlier versions of Oracle Exadata Database Machine, you could securely erase user data through CellCLI commands like `DROP CELL ERASE`, `DROP CELLDISK ERASE`, or `DROP GRIDDISK ERASE`. However, these `DROP` commands only cover user data on hard drives and flash devices. Secure Eraser sanitizes all content, not only user data but also operating system, Oracle Exadata System Software, and user configurations. In addition, Secure Eraser covers a wider range of hardware components including hard drives, flash devices, internal USB, and ILOM.

The Secure Eraser securely erases all data on both database servers and storage servers, and resets InfiniBand switches, Ethernet switches, and power distribution units back to factory default. You can use this feature to decommission or repurpose an Oracle Exadata machine. The Secure Eraser completely erases all traces of data and metadata on every component of the machine.

For details on the Secure Eraser utility, see *Oracle Exadata Database Machine Security Guide*.

## 7.1.8 Cell-to-Cell Offload Support for ASM-Scoped Security

To perform cell-to-cell offload operations efficiently, storage servers need to access other storage servers directly, instead of through a database server.

If you have configured ASM-scoped security in your Exadata environment, you need to set up **cell keys** to ensure storage servers can authenticate themselves to other storage servers so that they can communicate with each other directly. This applies to Oracle ASM resync, resilver, rebuild and rebalance operations, and database high-throughput write operations

### Related Topics

- Enabling Cell-to-Cell Operations

## 7.1.9 Adding an Additional Network Card to Oracle Exadata Database Machine X6-2 Database Servers

Oracle Exadata Database Machine X6-2 database servers offer a highly available copper 10 Gbps network on the motherboard, and an optical 10 Gbps network via a PCI card on slot 2.

Starting with Oracle Exadata System Software release 12.2.1.1.0, you can add an additional Ethernet card if you require additional connectivity. The additional card can provide either dual port 10 GbE optical connectivity (part number X1109A-Z) or dual port 10 GbE copper connectivity (part number 7100488). You can install this part in PCIe slot 1 on the Oracle Exadata Database Machine X6-2 database server.

After you install the network card and connect it to the network, Oracle Exadata System Software release 12.2.1.1.0 automatically recognizes the new card and configures the two

ports as `eth6` and `eth7` interfaces on the database server. You can use these additional ports for providing an additional client network, or for creating a separate backup or disaster recovery network. On a database server that runs virtual machines, you could use this network card to isolate traffic from two virtual machines.



### See Also:

*Oracle Exadata Database Machine Maintenance Guide*

## 7.1.10 Automatic Diagpack Upload for Oracle ASR

In Oracle Exadata System Software release 12.2.1.1.0, Management Server (MS) communicates with Oracle ASR Manager to upload a diagnostic package containing information relevant to the Oracle ASR automatically. In earlier releases you had to manually upload other diagnostics information after an automatic service request (SR) has been opened. By automating this step, this feature significantly reduces the turnaround time of Oracle ASRs.

This feature adds two new attributes to the `AlertHistory` object:

- The new `serviceRequestNumber` attribute shows the associated service request number.
- The new `serviceRequestLink` attribute shows the URL to the associated service request number.

Other feature highlights include:

- The diagnostic package RESTful page (<https://hostname/diagpack/download?name=diagpackname>) has a new column showing a link to the corresponding service request.
- Oracle ASR alert emails include SR links.

To enable Automatic Diagpack Upload for Oracle ASR, you must enable `http_receiver` in the Oracle ASR Manager:

- To check if `http_receiver` is enabled, run the following command from Oracle ASR Manager:

```
asr show_http_receiver
```

- To enable the `http_receiver`, use the following command, where `port` is the port the `http_receiver` listens on.

```
asr enable_http_receiver -p port
```

 **Note:**

The port specified here has to be the same as the `asrmPort` specified for the subscriber on the database server or on the storage server. The following commands show how to verify the `asrmPort` on a database server and storage server.

```
DBMCLI> LIST DBSERVER ATTRIBUTES snmpSubscriber
      ((host=test-engsys-asr1.example.com,
port=162,community=public,
type=ASR,fromIP=10.242.0.55,asrmPort=16168))
```

```
CellCLI> LIST CELL ATTRIBUTES snmpSubscriber
      ((host=test-engsys-
asr1.example.com,port=162,community=public,
type=ASR,asrmPort=16168))
```

If you do not want to automatically upload diagnostic data to a service request, you can run `ALTER CELL diagPackUploadEnabled=FALSE` to disable the automatic upload.

Minimum software required: Oracle ASR Manager Release 5.7

**Related Topics**

- *Oracle Exadata Database Machine Maintenance Guide*
- [Enabling Automatic DiagPack Upload for ASR](#)

## 7.1.11 CREATE DIAGPACK and LIST DIAGPACK Commands Available for Oracle Exadata Database Servers

The diagnostic package feature, which is available for storage servers, is now available for database servers as well. Management Server (MS) on database servers automatically collects customized diagnostic packages that include relevant logs and traces upon generating a database server alert. This applies to all critical database server alerts. Timely collection of diagnostic information prevents rollover of critical logs.

MS on database servers sends the diagnostic package as an email attachment for every critical email alert. Users can create hourly custom diagnostic packages by providing the start time and duration using the new `CREATE DIAGPACK DBMCLI` command.

See `CREATE DIAGPACK` and `LIST DIAGPACK` in the *Oracle Exadata Database Machine Maintenance Guide* for details.

## 7.1.12 Rescue Plan

In Oracle Exadata System Software releases earlier than 12.2.1.1.0, after a Oracle Exadata Database Server or Oracle Exadata Storage Server rescue, you must re-run multiple commands to configure items such as I/O Resource Management (IORM) plans, thresholds, and storage server and database server notification setting.

In Oracle Exadata System Software release 12.2.1.1.0, there is a new attribute called `rescuePlan` for the `cell` and `dbserver` objects. You can use this attribute to get a list of

commands, which you can store as a script. You can then run the script after a cell rescue to restore the settings.

For details on the `rescuePlan` attribute, see *Oracle Exadata Database Machine Maintenance Guide*.

### 7.1.13 Support for IPv6 Oracle VM and Tagged VLANs

Oracle Exadata System Software release 12.2.1.1.0 supports IPv6 Oracle VM and tagged virtual LANs (VLANs) using Oracle Exadata Deployment Assistant (OEDA).

IPv6 VLANs are now supported on the management network. In earlier releases, this was not supported.

See *Oracle Exadata Database Machine Installation and Configuration Guide*.

### 7.1.14 Management Server Can Remain Online During NTP, DNS, and ILOM Changes

If you are changing NTP, DNS, or ILOM parameters, the Management Server (MS) can remain online during the operation and does not need to be restarted.



#### See Also:

*Oracle Exadata Database Machine Maintenance Guide*

### 7.1.15 New Charts in ExaWatcher

In Oracle Exadata System Software release 12.2.1.1.0, `GetExaWatcherResults.sh` generates HTML pages that contain charts for IO, CPU utilization, cell server statistics, and alert history. The IO and CPU utilization charts use data from `iostat`, while the cell server statistics use data from `cellsrvstat`. Alert history is retrieved for the specified timeframe.

For details, see ExaWatcher Charts in the *Oracle Exadata Database Machine Maintenance Guide*.

### 7.1.16 New Metrics for Redo Log Writes

New metrics are available to help analyze redo log write performance.

Previously, when Automatic Workload Repository (AWR) reported an issue with redo log write wait time for database servers, the storage cells often indicated no issue with redo log write performance. New metrics help to give a better overall picture. These metrics provide insight into the following concerns:

- Is the I/O latency high, or is it some other factor (for example, network) ?
- How many redo log writes bypassed Flash Log ?
- What is the overall latency of redo log writes on each cell, taking into account all redo log writes, not just those which were handled by Flash Log ?

Oracle Exadata System Software release 12.2.1.1.0 introduces the following metrics related to redo log write requests:

- `FL_IO_TM_W`: Cumulative redo log write latency. It includes latency for requests not handled by Exadata Smart Flash Log.
- `FL_IO_TM_W_RQ`: Average redo log write latency. It includes write I/O latency only.
- `FL_RQ_TM_W`: Cumulative redo log write request latency. It includes networking and other overhead.

To get the latency overhead due to factors such as network and processing, you can use  $(FL\_RQ\_TM\_W - FL\_IO\_TM\_W)$ .

- `FL_RQ_TM_W_RQ`: Average redo log write request latency.
- `FL_RQ_W`: Total number of redo log write requests. It includes requests not handled by Exadata Smart Flash Log.

To get the number of redo log write requests not handled by Exadata Smart Flash Log, you can use  $(FL\_RQ\_W - FL\_IO\_W)$ .

## 7.1.17 Quarantine Manager Support for Cell-to-Cell Rebalance and High Throughput Write Operations

Quarantine manager support is enabled for rebalance and high throughput writes in cell-to-cell offload operations. If Oracle Exadata System Software detects a crash during these operations, the offending operation is quarantined, and an less optimized path is used to continue the operation.

The quarantine types for the new quarantines are `ASM_OFFLOAD_REBALANCE` and `HIGH_THROUGHPUT_WRITE`.

See Quarantine Manager Support for Cell-to-Cell Offload Operations in the *Oracle Exadata System Software User's Guide* for details.

## 7.1.18 ExaCLI and REST API Enabled for Management Server

Both ExaCLI and REST API are enabled for Management Server (MS) on the database servers.

You can now perform remote execution of MS commands. You can access the interface using HTTPS in a web browser, or curl. See *Oracle Exadata Database Machine Maintenance Guide* for more information.

## 7.1.19 New Features in Oracle Grid Infrastructure 12.2.1.1.0

The following new features in Oracle Grid Infrastructure 12.2.1.1.0 affect Oracle Exadata Database Machine:

- [Oracle ASM Flex Disk Groups](#)  
An Oracle ASM flex disk group is a disk group type that supports Oracle ASM file groups.
- [Oracle Flex ASM](#)  
Oracle Flex ASM enables Oracle ASM instances to run on a separate physical server from the database servers.

- [Faster Redundancy Restoration After Storage Loss](#)  
Using Oracle Grid Infrastructure 12c Release 2 (12.2), redundancy restoration after storage loss takes less time than in previous releases.
- [Dynamic Power Change](#)  
You can adjust the value of the `ASM_POWER_LIMIT` parameter dynamically.
- [Quorum Disk Support in Oracle Universal Installer](#)  
You can specify a quorum failure group during the installation of Oracle Grid Infrastructure.

### 7.1.19.1 Oracle ASM Flex Disk Groups

An Oracle ASM flex disk group is a disk group type that supports Oracle ASM file groups.

An Oracle ASM file group describes a group of files that belong to a database, and enables storage management to be performed at the file group, or database, level. In general, a flex disk group enables users to manage storage at the granularity of the database, in addition to at the disk group level.

See *Managing Flex Disk Groups in Oracle Automatic Storage Management Administrator's Guide*.

### 7.1.19.2 Oracle Flex ASM

Oracle Flex ASM enables Oracle ASM instances to run on a separate physical server from the database servers.

If the Oracle ASM instance on a node in a standard Oracle ASM cluster fails, then all of the database instances on that node also fail. However, in an Oracle Flex ASM configuration, Oracle 12c database instances would not fail as they would be able to access another Oracle ASM instance remotely on another node.

With Oracle Flex ASM, you can consolidate all the storage requirements into a single set of disk groups. All these disk groups are mounted by and managed by a small set of Oracle ASM instances running in a single cluster. You can specify the number of Oracle ASM instances with a cardinality setting.

Oracle Flex ASM is enabled by default with Oracle Database 12c release 2 (12.2). Oracle Exadata Database Machine ships with cardinality set to `ALL`, which means an Oracle ASM instance is created on every available node. See the following topics for details:

- [About Oracle Flex ASM in Oracle Automatic Storage Management Administrator's Guide](#)
- [Managing Oracle Flex ASM in Oracle Automatic Storage Management Administrator's Guide](#)
- [About Oracle Flex ASM Clusters Networks in Oracle Grid Infrastructure Installation and Upgrade Guide for Linux](#)

### 7.1.19.3 Faster Redundancy Restoration After Storage Loss

Using Oracle Grid Infrastructure 12c Release 2 (12.2), redundancy restoration after storage loss takes less time than in previous releases.

A new `REBUILD` phase was introduced to the rebalance operation. The `REBUILD` phase restores redundancy first after storage failure, greatly reducing the risk window within which a secondary failure could occur. A subsequent `BALANCE` phase restores balance.

Oracle Grid Infrastructure release 12.1.0.2 with DBBP 12.1.0.2.170718 also includes the Oracle ASM `REBUILD` phase of rebalance.

 **Note:**

In Oracle Grid Infrastructure 12c release 2 (12.2), rebuild is tracked in `V$ASM_OPERATION` via a separate pass (`REBUILD`). In Oracle Grid Infrastructure 12c release 1 (12.1), both rebuild and rebalance phases are tracked in the same pass (`REBALANCE`).

#### Related Topics

- Manually Rebalancing Disk Groups

### 7.1.19.4 Dynamic Power Change

You can adjust the value of the `ASM_POWER_LIMIT` parameter dynamically.

If the `POWER` clause is not specified in an `ALTER DISKGROUP` statement, or when rebalance is implicitly run by adding or dropping a disk, then the rebalance power defaults to the value of the `ASM_POWER_LIMIT` initialization parameter. You can adjust the value of this parameter dynamically. The range of values for the `POWER` clause is the same for the `ASM_POWER_LIMIT` initialization parameter.

The higher the power limit, the more quickly a rebalance operation can complete. Rebalancing takes longer with lower power values, but consumes fewer processing and I/O resources which are shared by other applications, such as the database.

See Tuning Rebalance Operations in *Oracle Automatic Storage Management Administrator's Guide*.

### 7.1.19.5 Quorum Disk Support in Oracle Universal Installer

You can specify a quorum failure group during the installation of Oracle Grid Infrastructure.

On Oracle Exadata Storage Servers, quorum disk groups are automatically created during deployment. A quorum failure group is a special type of failure group that is used to store the Oracle Clusterware voting files. The quorum failure group is used to ensure that a quorum of the specified failure groups are available.

The installer for Oracle Grid Infrastructure 12.2 was updated to allow you to specify quorum failure groups during installation instead of configuring the quorum failure group after installation using the Quorum Disk Manager utility.

See Identifying Storage Requirements for Oracle Automatic Storage Management in *Oracle Grid Infrastructure Installation and Upgrade Guide for Linux*

## 7.1.20 New Features in Oracle Database 12c Release 2 (12.2.0.1)

The following new features in Oracle Database 12c release 2 (12.2.0.1) affect Oracle Exadata:

- [Database Server I/O Latency Capping](#)
- [Exadata Smart Scan Offload for Compressed Index Scan](#)
- [Exadata Smart Scan Offload Enhancements for In-Memory Aggregation \(IMA\)](#)
- [Exadata Smart Scan Offload Enhancements for XML](#)
- [Exadata Smart Scan Offload Enhancements for LOBs](#)
- [New Features in Oracle Exadata Snapshots](#)

### 7.1.20.1 Database Server I/O Latency Capping

On very rare occasions there may be high I/O latency between a database server and a storage server due to network latency outliers, hardware problems on the storage servers, or some other system problem with the storage servers. Oracle ASM and Oracle Exadata Storage Server software automatically redirect read I/O operations to another storage server when the latency of the read I/O is much longer than expected. Any I/Os issued to the last valid mirror copy of the data are not redirected.

This feature works with all Exadata Storage Software releases. You do not have to perform any configuration to use this feature.

Minimum software required: Oracle Database and Oracle Grid Infrastructure 12c release 2 (12.2.0.1.0)

### 7.1.20.2 Exadata Smart Scan Offload for Compressed Index Scan

In Oracle Exadata Storage Server Software 12.1.2.3.0 and prior releases, smart scan offload supported normal uncompressed indexes and bitmap indexes.

In Oracle Exadata Storage Server Software 12.2.1.1.0, smart scan offload has been implemented for compressed indexes. Queries involving compressed index scan on Oracle Exadata can benefit from this feature.

Minimum software required: Oracle Database 12c release 2 (12.2.0.1.0) and Oracle Exadata Storage Server software release 12.2.1.1.0

### 7.1.20.3 Exadata Smart Scan Offload Enhancements for In-Memory Aggregation (IMA)

Oracle Exadata Storage Server software supports offloading many SQL operators for predicate evaluation. The In-Memory Aggregation feature attempts to perform a "vector transform" optimization which takes a star join SQL query with certain aggregation operators (for example, `SUM`, `MIN`, `MAX`, and `COUNT`) and rewrites it for more efficient processing. A vector transformation query is similar to a query that uses bloom filter for joins, but is more efficient. When a vector transformed query is used with Oracle Exadata Storage Server release 12.1.2.1.0, the performance of joins in the query is enhanced by the ability to offload filtration for rows used for aggregation. You will see "KEY VECTOR USE" in the query plan when this optimization kicks in.



In Oracle Exadata Storage Server software release 12.2.1.1.0, vector transformed queries benefit from more efficient processing due to the application of group-by columns (key vectors) to the Exadata Storage Index.

Additionally, vector transformed queries that scan data in in-memory columnar format on the storage server can offload processing of aggregation work. These optimizations are automatic and do not depend on user settings.

Minimum software required: Oracle Database 12c release 2 (12.2.0.1.0) and Oracle Exadata Storage Server software release 12.2.1.1.0

#### 7.1.20.4 Exadata Smart Scan Offload Enhancements for XML

When XML data is stored using a SecureFiles LOB of less than 4 KB, the evaluation in a SQL WHERE clause of Oracle SQL condition `XMLExists` or Oracle SQL function `XMLCast` applied to the return value of Oracle SQL function `XMLQuery` can sometimes be offloaded to an Oracle Exadata Storage Server.

Minimum software required: Oracle Database 12c Release 2 (12.2.0.1.0) and Oracle Exadata Storage Server software release 12.2.1.1.0.

#### 7.1.20.5 Exadata Smart Scan Offload Enhancements for LOBs

In Oracle Exadata Storage Server 12.2.1.1.0, offload support has been extended for the following LOB operators: `LENGTH`, `SUBSTR`, `INSTRM CONCAT`, `LPAD`, `RPAD`, `LTRIM`, `RTRIM`, `LOWER`, `UPPER`, `NLS_LOWER`, `NLS_UPPER`, `NVL`, `REPLACE`, `REGEXP_INSTR`, `TO_CHAR`.

Exadata smart scan offload evaluation is supported only on uncompressed inlined LOBs (less than 4 KB in size).

Minimum software required: Oracle Database 12c release 2 (12.2.0.1.0) and Oracle Exadata Storage Server software release 12.2.1.1.0.

#### 7.1.20.6 New Features in Oracle Exadata Snapshots

- Hierarchical snapshot databases  
You can create space-efficient snapshot databases from a parent that is itself a snapshot. This allows for hierarchical snapshot databases. The parent snapshot is also space-efficient, all the way to the base test master. Multiple users can create their own snapshots from the same parent snapshot. The set of snapshots can be represented as a tree, where the root of the tree is the base test master. All the internal nodes in the tree are read-only databases and all the leaves in the tree are read/write databases. All Oracle Exadata features are supported on the hierarchical snapshot databases. For hierarchical snapshot databases, because there is performance penalty with every additional depth level of the snapshot, Oracle recommends having a snapshot tree with a maximum depth of 10.
- Spare Test Master databases  
You can also create and manage a sparse test master, while having active snapshots from it. This feature allows the sparse test master to sync almost continuously with Oracle Data Guard, except for small periods of time when users are creating a snapshot directly from the sparse test master. This feature utilizes the hierarchical snapshot feature described above, by creating read-only hidden parents. Note that Oracle Exadata snapshot databases are intended for test and development databases only.
- Sparse backup and recovery

When you choose to perform a sparse backup on DB0, the operation copies data only from the delta storage space of the database and the delta space of the sparse data files. A sparse backup can be either in the backup set format (default) or the image copy format. RMAN restores sparse data files from sparse backups and then recovers them from archive and redo logs. You can perform a complete or a point-in-time recovery on sparse data files. Sparse backups help in efficiently managing storage space and facilitate faster backup and recovery.

See *Oracle Database Backup and Recovery User's Guide* for information about sparse backups.

Minimum hardware: Storage servers must be X3 or later

Minimum software: Oracle Database and Grid Infrastructure 12c release 2 (12.2), and Oracle Exadata Storage Server software release 12.2.1.1.0.

## 7.1.21 Oracle Linux Kernel Upgraded to Unbreakable Enterprise Kernel 4 and Oracle VM Upgraded to 3.4.2

This release upgrades Oracle Linux to Unbreakable Enterprise Kernel (UEK) 4, (4.1.12-61.28.1.el6uek.x86\_64). For systems using virtualization, the DOM0 is upgraded to Oracle VM 3.4.2. This enables you to use Oracle Linux 6 on the dom0. The Linux kernels used on the dom0 and domU are now unified.

For systems previously using virtualization on the compute nodes, you must upgrade the Oracle Grid Infrastructure home to release 12.1.0.2.161018DBBP or later in all domU's before upgrading the Oracle Exadata Storage Server software to release 12.2.1.1.0. The Oracle Exadata Storage Server software upgrade to release 12.2.1.1.0 requires you to upgrade all the domU's first before you upgrade the dom0. This requirement is enforced by the `patchmgr` software.

If you use Oracle Advanced Cluster File System (Oracle ACFS), then you must apply the fix for bug 22810422 prior to the upgrade of the Oracle Grid Infrastructure home to enable Oracle ACFS support on the UEK4 kernel. In addition, Oracle recommends that you install the fix for bug 23642667 on both the Oracle Grid Infrastructure home and the Oracle Database home to increase OLTP workload performance.

## 7.2 What's New in Oracle Exadata Database Machine 12c Release 1 (12.1.2.3.0)

The following features are new for Oracle Exadata Database Machine 12c Release 1 (12.1.2.3.0):

- [Performance Improvement for Oracle Exadata System Software Updates](#)
- [Quorum Disk Manager Utility](#)
- [VLAN Support](#)
- [Adaptive Scrubbing Schedule](#)
- [IPv6 Support in ASR Manager](#)
- [Increased Maximum Number of Database Processes](#)
- [Cell-to-Cell Rebalance Preserves Storage Index](#)
- [ASM Disk Size Checked When Reducing Grid Disk Size](#)

- [Support for Alerts in CREATE DIAGPACK](#)

## 7.2.1 Performance Improvement for Oracle Exadata System Software Updates

Updating Oracle Exadata System Software now takes significantly less time. By optimizing internal processing even further, the cell update process is now up to 2.5 times faster compared to previous releases.

## 7.2.2 Quorum Disk Manager Utility

In earlier releases, when Oracle Exadata systems with fewer than 5 storage servers were deployed with HIGH redundancy, the voting disk for the cluster was created on a disk group with NORMAL redundancy. If two cells go down in such a system, the data is still preserved due to HIGH redundancy but the cluster software comes down because the voting disk is on a disk group with NORMAL redundancy.

Quorum disks enable users to deploy and leverage disks on database servers to achieve highest redundancy in quarter rack or smaller configurations. Quorum disks are created on the database servers and added into the quorum failure group.

For new systems to be configured with HIGH redundancy but having fewer than 5 storage servers, Oracle Exadata Deployment Assistant can be used to automatically create such quorum disks.

Users who have deployed such systems can use the new `quorumdiskmgr` utility manually. `quorumdiskmgr` enables you to manage quorum disks on database servers. With this utility, you can create, list, delete, and alter quorum disk configurations, targets, and devices.

See "Managing Quorum Disks for High Redundancy Disk Groups" in the Oracle Exadata Database Machine Maintenance Guide for details.

Minimum software required:

- Oracle Exadata Storage Server Software release 12.1.2.3.0
- Grid Infrastructure release 12.1.0.2.160119 with these patches: 22722476 and 22682752; or Grid Infrastructure release 12.1.0.2.160419 or later
- Patch 23200778 for all Database homes

## 7.2.3 VLAN Support

OEDA now supports the creation of VLANs on compute nodes and storage servers for the admin network, ILOM, client and the backup access network. Note the following:

- Client and backup VLAN networks must be bonded. The admin network is never bonded.
- If the backup network is on a tagged VLAN network, the client network must also be on a separate tagged VLAN network.
- The backup and client networks can share the same network cables.
- OEDA supports VLAN tagging for both physical and virtual deployments.
- IPv6 VLANs are supported for bare metal on all Oracle Exadata systems except for X2 and V2 systems.

IPv6 VLAN with VM is not supported currently.

 **Note:**

If your system will use more than 10 VIP addresses in the cluster and you have VLAN configured for the Oracle Clusterware client network, then you must use 3 digit VLAN ids. Do not use 4 digit VLAN ids because the VLAN name can exceed the 15 character operating system interface name limit.

The following table shows IPv4 and IPv6 support on the admin, client, and backup networks for the different Exadata systems and Oracle Database versions.

Version of Oracle Database	VLAN Tagging on Admin Network	Client and Backup Networks
11.2.0.4	Only supported with IPv4 addresses on X3-2 and above for two-socket servers, and X4-8 and above for eight-socket servers.	Supported with IPv4 and IPv6 on all hardware models.
12.1.0.2	Only supported with IPv4 addresses on X3-2 and above for two-socket servers, and X4-8 and above for eight-socket servers.	Supported with IPv4 on all hardware models. Supported with IPv6 on all hardware models with fix for 22289350.

See "Using Network VLAN Tagging with Oracle Exadata Database Machine" in the *Oracle Exadata Database Machine Installation and Configuration Guide* for details.

## 7.2.4 Adaptive Scrubbing Schedule

Oracle Exadata System Software automatically inspects and repairs hard disks periodically when the hard disks are idle. The default schedule of scrubbing is every two weeks.

However, once a hard disk starts to develop bad sectors, it is better to scrub that disk more frequently because it is likely to develop more bad sectors. In release 12.1.2.3.0, if a bad sector is found on a hard disk in a current scrubbing job, Oracle Exadata System Software will schedule a follow-up scrubbing job for that disk in one week. When no bad sectors are found in a scrubbing job for that disk, the schedule will fall back to the scrubbing schedule specified by the `hardDiskScrubInterval` attribute.

If the user has changed the `hardDiskScrubInterval` to less than or equal to weekly, Oracle Exadata System Software will use the user-configured frequency instead of the weekly follow-up schedule even if bad sectors are found. See the `ALTER CELL` section in the *Oracle Exadata System Software User's Guide* for more information about scrubbing.

Minimum software required:

- Oracle Exadata System Software release 12.1.2.3.0
- Grid Infrastructure home:
  - 11.2.0.4.16 (April 2015) or higher
  - 12.1.0.2.4 (January 2015) or higher

## 7.2.5 IPv6 Support in ASR Manager

Systems using IPv6 can now connect to Auto Service Request (ASR) using ASR Manager 5.4.

## 7.2.6 Increased Maximum Number of Database Processes

Table 7-1 shows the maximum number of database processes supported per database node. These numbers are higher than in previous releases. The best practice is to keep the process count below these values. If a subset of your workload is running parallel queries, the maximum database process count will be between the values in the "Maximum Number of Processes with No Parallel Queries" column and the "Maximum Number of Processes with All Running Parallel Queries" column.

**Table 7-1 Maximum Number of Database Processes Per Node**

Machine Type	InfiniBand Bonding Type	Maximum Number of Processes with No Parallel Queries	Maximum Number of Processes with All Running Parallel Queries
8-socket (X2-8, X3-8)	Active passive	28,500	25,000
8-socket (X4-8, X5-8)	Active bonding	64,000	44,000
2-socket (X2-2, X3-2)	Active passive	12,500	10,000
2-socket (X4-2, X5-2, X6-2)	Active bonding	16,000	14,000

Table 7-2 shows the maximum number of database processes supported per Oracle VM user domain. These numbers are higher than in previous releases. The best practice is to keep the process count below these values. If a subset of your workload is running parallel queries, the maximum database process count will be between the "Maximum Number of Processes with No Parallel Queries" column and the "Maximum Number of Processes with All Running Parallel Queries" column.

**Table 7-2 Maximum Number of Database Processes Per Oracle VM User Domain**

Machine Type	InfiniBand Bonding Type	Maximum Number of Processes with No Parallel Queries	Maximum Number of Processes with All Running Parallel Queries
2-socket (X2-2, X3-2)	Active passive	11,500	8,000
2-socket (X4-2, X5-2, X6-2)	Active bonding	23,000	14,000

The machines are configured as follows:

- On an 8-socket database node with active bonding InfiniBand configurations (X4-8 and X5-8), there are 8 IP addresses across 4 InfiniBand cards (8 InfiniBand ports).
- On an 8-socket database node with active-passive InfiniBand configurations (X2-8 and X3-8), there are 4 IP addresses across 4 InfiniBand cards (8 InfiniBand ports).

- On a 2-socket database node with active bonding InfiniBand configurations (X4-2, X5-2, and X6-2), there are 2 IP addresses on 1 InfiniBand card (2 InfiniBand ports).
- On a 2-socket database node with active-passive InfiniBand configurations (X2-2 and X3-2), there is 1 IP address on 1 InfiniBand card (2 InfiniBand ports).

Up to 50,000 RDS sockets are allocated per InfiniBand IP address for database usage. Each IO-capable database process will consume RDS sockets across IPs with even load balancing.

Starting with Exadata 12.1.2.3.0, there is no connection limit on the cell side.

In addition to the higher process count supported by the Exadata image and the Oracle kernel, the following related products have also been enhanced:

- Oracle Exadata Deployment Assistant automatically configures higher limits in `Grid_home/crs/install/s_crsconfig_nodenameenv.txt` at deployment time.
- Exadata Patch Manager (`patchmgr` and `dbnodeupdate.sh`) automatically configures higher limits in `Grid_home/crs/install/s_crsconfig_nodenameenv.txt` during database node upgrades.

The following best practices should be followed to ensure optimal resource utilization at high process count:

- Application-initiated Oracle foregrounds should be established through a set of Oracle listeners running on the Exadata database nodes instead of using local bequeath connections.
- The number of listeners should be at least as high as the number of database node CPU sockets, and every database node CPU socket should run the same number of listeners. For example, on an Oracle Exadata X5-8 database node, eight listeners could be configured, one per database node CPU socket.
- Listeners should spawn Oracle processes evenly across database node CPU sockets. This can be done by specifying the socket they will run on at startup time. For example, assuming the `listener.ora` file is configured correctly for listeners 0 through 7, the following script could be used to spawn eight listeners on an X5-8 database node, each on a different socket:

```
#!/bin/bash
export ORACLE_HOME=/u01/app/oracle/product/12.1.0.2/dbhome_1
for socket in `seq 0 7`
do
    numactl --cpunodebind=${socket} $ORACLE_HOME/bin/lsnrctl start
    LISTENER${socket}
done
```

- Listener connection rate throttling should be used to control login storms and provide system stability at high process counts.
- The total number of connections established per second, in other words, the sum of `rate_limit` for all listeners, should not be more than 400 to avoid excessive client connection timeouts and server-side errors.

Minimum software required:

- Oracle Exadata System Software release 12.1.2.3.0

- Oracle Database 12c Release 1 (12.1) release 12.1.0.2.160119 with these patches: 22711561, 22233968, and 22609314

## 7.2.7 Cell-to-Cell Rebalance Preserves Storage Index

Storage index provides significant performance enhancement by pruning I/Os during a smart scan. When a disk hits a predictive failure or a true failure, data needs to be rebalanced out to disks on other cells. This feature enables storage index entries, created for regions of data in the disk that failed, to be moved along with the data during the cell-to-cell offloaded rebalance to maintain application performance.

This feature provides significant performance improvement compared to earlier releases for application performance during a rebalance due to disk failure.

Minimum software required:

- Oracle Exadata Storage Server Software release 12.1.2.3.0
- Grid Infrastructure release 12.1.0.2.160119 with patch 22682752

## 7.2.8 ASM Disk Size Checked When Reducing Grid Disk Size

In releases earlier than 12.1.2.3.0, a user might accidentally decrease the size of a grid disk before decreasing the size of an ASM disk that is part of the disk group. In release 12.1.2.3.0, the resize order is checked so that the user cannot reduce the size of the grid disk to be smaller than the ASM disk.

A new attribute `asmDiskSize` is added to grid disk to support ASM disk size query. When the user runs `ALTER GRIDDISK` to alter the grid disk size, the command now checks the ASM disk size and prevents the user from making the grid disk smaller than the ASM disk.

The check works for both normal data disk and sparse disk. If it is a sparse grid disk, the check is performed when the virtual size is being changed. If it is a normal grid disk, the check is performed when size is being changed.

For example, suppose the following command:

```
CellCLI> list griddisk DATA1_CD_00_adczarcel04 attributes name,asmdisksize
```

returns the following output:

```
DATA1_CD_00_adczarcel04      14880M
```

When you try to reduce the size of the grid disk to be smaller than the ASM disk:

```
CellCLI> alter griddisk DATA1_CD_00_adczarcel04 size=10G
```

the command returns an error:

```
CELL-02894: Requested grid disk size is smaller than ASM disk size. Please resize ASM disk DATA1_CD_00_ADCZARCEL04 first.
```

Minimum software required:

- Oracle Exadata Storage Server Software release 12.1.2.3.0
- Grid Infrastructure release 12.1.0.2.160119 with patch 22347483



## 7.2.9 Support for Alerts in CREATE DIAGPACK

The `CREATE DIAGPACK` command now supports creating diagnostic packages for a specified alert using the `alertName` parameter.

See `CREATE DIAGPACK` in *Oracle Exadata System Software User's Guide* for details.

## 7.3 What's New in Oracle Exadata Database Machine 12c Release 1 (12.1.2.2.0)

The following features are new for Oracle Exadata Database Machine 12c Release 1 (12.1.2.2.0):

- [Smart Fusion Block Transfer](#)
- [8 TB Hard Disk Support](#)
- [IPv6 Support](#)
- [Running CellCLI Commands from Compute Nodes](#)
- [Disabling SSH on Storage Servers](#)
- [Fixed Allocations for Databases in the Flash Cache](#)
- [Oracle Exadata Storage Statistics in AWR Reports](#)
- [Increased Maximum Number of Database Processes](#)
- [Custom Diagnostic Package for Storage Server Alerts](#)
- [Updating Nodes Using patchmgr](#)
- [kdump Operational for 8-Socket Database Nodes](#)
- [Redundancy Check When Powering Down the Storage Server](#)
- [Specifying an IP Address for SNMP Traps](#)
- [Reverse Offload Improvements](#)
- [Cell-to-Cell Rebalance Preserves Flash Cache Population](#)

### 7.3.1 Smart Fusion Block Transfer

Minimum software required: 12.1.0.2 BP13

Many OLTP workloads can have hot blocks that need to be updated frequently across multiple nodes in Oracle Real Application Clusters (Oracle RAC). One example is Right Growing Index (RGI), where new rows are added to a table with an index from several Oracle RAC nodes. The index leaf block becomes a hot block that needs frequent updates across all nodes.

Without the Smart Fusion Block Transfer feature of Oracle Exadata Database Machine, a hot block can be transferred from a sending node to a receiver node only after the sending node has made changes in its redo log buffer durable in its redo log. With Smart Fusion Block Transfer, this latency of redo log write at the sending node is eliminated. The block is transferred as soon as the IO to the redo log is issued at the sending node, without waiting for it to complete. Smart Fusion Block Transfer



increases throughput (about 40% higher) and decreases response times (about 33% less) for RGI workloads.

To enable Smart Fusion Block Transfer:

- Set the hidden static parameter `_cache_fusion_pipelined_updates` to `TRUE` on all Oracle RAC nodes. Because this is a static parameter, you need to restart your database for this change to take effect.
- Set the `exafusion_enabled` parameter to `1` on all Oracle RAC instances.



**Note:**

The Oracle Exadata Database Machine initialization parameter `exafusion_enabled` is desupported in Oracle Database 19c.

## 7.3.2 8 TB Hard Disk Support

In this software release, Exadata storage server supports 8 TB high capacity disks. Supporting 8 TB high capacity disks has the following advantages:

- Doubles the disk capacity of the pervious Exadata machines, up to 1344 TB per rack
- Provides more storage for scaling out your existing databases and data warehouses

Requirements for using 8 TB high capacity disks:

- Exadata 12.1.2.1.2 or higher
- Grid Infrastructure home requires one of the following:
  - 12.1.0.2.11 or higher BP
  - 12.1.0.2.10 or lower BP plus the following patches: 21281532, 21099555, and 20904530
  - 11.2.0.4.18 or higher BP
  - 11.2.0.4.17 or lower BP plus patch 21099555
  - 11.2.0.3 plus patch 21099555

## 7.3.3 IPv6 Support

IPv6 support is for Ethernet.

Compute nodes and storage servers are now enabled to use IPv6 for the admin network, ILOM, and the client access network. This works for both bare metal and virtualized deployments. The following table describes how various components support IPv6:

Component	Description of IPv6 Support
Oracle Exadata Deployment Assistant (OEDA)	<p>OEDA allows a user to enter an IPv6 address in the "Define Customer Networks" screen (see <a href="#">Figure 7-1</a> for a screenshot). When IPv6 addresses are used for the admin network, the DNS servers, NTP servers, SMTP servers, and SNMP servers need to be on an IPv6 network.</p> <p>On the "Define Customer Networks" screen, if you specify the gateway with an IPv6 address and the /64 suffix to denote the mask, the Subnet Mask field becomes greyed out and unavailable.</p>
Cisco switch	<p>The Cisco switch can be enabled with an IPv6 address using the minimum firmware version of 15.2(3)E2 for the Cisco 4948E-F switches.</p> <p>Refer to My Oracle Support note 1415044.1 for upgrade instructions and to open an SR to obtain the updated Cisco firmware through Oracle Support.</p>
Auto Service Request (ASR)	<p>ASR does not work with IPv6 addresses. This will be resolved in a future release. ASR can be enabled by bridging to an IPv4 network.</p>
Enterprise Manager	<p>Enterprise Manager needs to be on a bridged network such that it can monitor both the InfiniBand switches (on an IPv4 network) and the compute and storage nodes (on an IPv6 network).</p>
dbnodeupdate	<p>dbnodeupdate requires remote repositories that are hosted on machines with IPv6 address, or an ISO file needs to be used.</p> <p>Remote repositories may not be reachable (using http or other protocols) if they use IPv4 and the host only has IPv6 IPs. Some customers may be able to reach IPv4 IPs from their IPv6 hosts if the network routers and devices permit it. Most customers will likely need an IPv6 repository server or use an ISO file.</p>
InfiniBand network	<p>Private InfiniBand network is required to remain on IPv4 only. Note that only private addresses are used on the InfiniBand network, so there is little benefit from moving InfiniBand to IPv6.</p>
SMTP and SNMP	<p>SMTP and SNMP servers should usually be IPv6 (or a name that resolves to an IPv6 IP address) unless the customer network has a bridge or gateway to route between IPv4 and IPv6.</p>
Platinum Support	<p>Platinum Support will not be available for IPv6 deployments until a subsequent Platinum Gateway software release is available.</p>

Figure 7-1 "Define Customer Networks" Screen in Oracle Exadata Deployment Assistant

**Define Customer Networks**

Exadata requires a minimum of 2 separate customer subnets. This page allows you to describe those subnets, for completeness it also includes subnet 3 which is the Private infiniband network. Some customers have more than 2 subnets. In those cases Exadata can configure one of those additional subnets for 'backup', 'replication', 'dr' or for an 'independent client' network in multi cluster environments. This is included here as subnet 4 however this subnet is NOT mandatory for deployment

**Subnet 1**

Name : **Admin**  Bonded  Non Bonded  
 Subnet Mask :   
 Gateway : 2606:b400:418:1ea5::1/64  
 Network Format :  1/10 Gbit Copper Base-T  10 Gbit Optical

**Subnet 2**

Name : **Client**  Bonded  Non Bonded  
 Subnet Mask :   
 Gateway : 2606:b400:418:1ea4::1/64  
 Network Format :  1/10 Gbit Copper Base-T  10 Gbit Optical

**Subnet 3**

Name : **Private**  Bonded  Non Bonded  
 Subnet Mask : 255.255.248.0   
 Network Format :  InfiniBand

**Subnet 4**

Available Network : **Backup**  Bonded  Non Bonded  
 Subnet Mask : 255.255.255.0   
 Gateway :   
 Network Format :  1/10 Gbit Copper Base-T  10 Gbit Optical

Buttons: Help, Import..., Oracle VM Defaults..., Save, < Back, Next >, Finish, Cancel

### Related Topics

- [My Oracle Support note 1415044.1](#)

## 7.3.4 Running CellCLI Commands from Compute Nodes

The new ExaCLI utility enables you to run CellCLI commands on storage servers remotely from database servers. This is useful in cases where you locked the storage serves by disabling SSH access, as described in [Disabling SSH on Storage Servers](#).

ExaCLI also provides an easier to use interface for storage server management, and enables you to separate the roles of a storage user from a storage administrator.

To run ExaCLI, you need to create users on the storage servers, and grant roles to the users. Granting roles assign privileges to users, that is, they specify which CellCLI commands users are allowed to run. When connecting to a storage server, ExaCLI authenticates the specified user name, and checks that the user has the appropriate privileges to run the specified command.

The new `exadcli` utility is similar to the `dcli` utility: `exadcli` enables you to run CellCLI commands across multiple storage servers.

For details, see:

- Using the ExaCLI Utility in the *Oracle Exadata Database Machine Maintenance Guide*
- Using the `exadcli` Utility in the *Oracle Exadata System Software User's Guide*

You can control which commands users can run by granting privileges to roles, and granting roles to users. For example, you can specify that a user can run the `LIST GRIDDISK` command but not `ALTER GRIDDISK`. This level of control is useful in Oracle Cloud environments, where you might want to allow full access to the system to only a few users.

You also need to create users if you are using the new ExaCLI utility. You use the `CREATE USER`, `GRANT PRIVILEGE`, and `GRANT ROLE` commands to create users, specify privileges to roles, and grant roles to users. For details, see *Creating Exadata Software Users and Roles* in the *Oracle Exadata System Software User's Guide*.

### 7.3.5 Disabling SSH on Storage Servers

By default, SSH is enabled on storage servers. If required, you can "lock" the storage servers to disable SSH access. You can still perform operations on the cell using ExaCLI, which runs on compute nodes and communicates using https and REST APIs to a web service running on the cell.

When you need to perform operations that require you to log in to the cell, you can temporarily unlock the cell. After the operation is complete, you can relock the cell.

For details, see *Disabling SSH on Storage Servers* in the *Oracle Exadata System Software User's Guide*.

### 7.3.6 Fixed Allocations for Databases in the Flash Cache

The `ALTER IORMPLAN` command has a new attribute called `flashcachesize` which enables you to allocate a fixed amount of space in the flash cache for a database. The value specified in `flashcachesize` is a hard limit, which means that the database cannot use more than the specified value. This is different from the `flashcachelimit` value, which is a "soft" maximum: databases can exceed this value if the flash cache is not full.

`flashcachesize` is ideal for situations such as Cloud and "pay for performance" deployments where you want to limit databases to their allocated space.

For details, see the following:

- *Managing I/O Resources* chapter in the *Oracle Exadata System Software User's Guide*
- `ALTER IORMPLAN` command in the *Oracle Exadata System Software User's Guide*

### 7.3.7 Oracle Exadata Storage Statistics in AWR Reports

The Exadata Flash Cache Performance Statistics sections have been enhanced in the AWR report:

- Added support for Columnar Flash Cache and Keep Cache.
- Added a section on Flash Cache Performance Summary to summarize Exadata storage cell statistics along with database statistics.

The Exadata Flash Log Statistics section in the AWR report now includes statistics for first writes to disk and flash.

Minimum software: Oracle Database release 12.1.0.2 Bundle Patch 11

## 7.3.8 Increased Maximum Number of Database Processes

Minimum software required: 12.1.0.2 BP11, or 11.2.0.4 BP18

The following table shows the maximum number of database processes supported per database node. These numbers are higher than in previous releases. The best practice is to keep the process count below these values. If a subset of your workload is running parallel queries, the maximum database process count will be between the "Number of Processes with No Parallel Queries" column and the "Number of Processes with All Running Parallel Queries" column.

**Table 7-3 Maximum Number of Database Processes Per Node**

Machine Type	InfiniBand Bonding Type	Maximum Number of Processes with No Parallel Queries	Maximum Number of Processes with All Running Parallel Queries
8-socket (X2-8, X3-8)	Active passive	28,500	25,000
8-socket (X4-8, X5-8)	Active bonding	50,000	44,000
2-socket (X2-2, X3-2)	Active passive	12,500	10,000
2-socket (X4-2, X5-2)	Active bonding	16,500	14,000

The machines are configured as follows:

- On an 8-socket database node with active bonding InfiniBand configurations (X4-8 and X5-8), there are 8 IP addresses across 4 InfiniBand cards (8 InfiniBand ports).
- On an 8-socket database node with active-passive InfiniBand configurations (X2-8 and X3-8), there are 4 IP addresses across 4 InfiniBand cards (8 InfiniBand ports).
- On a 2-socket database node with active bonding InfiniBand configurations (X4-2 and X5-2), there are 2 IP addresses on 1 InfiniBand card (2 InfiniBand ports).
- On a 2-socket database node with active-passive InfiniBand configurations (X2-2 and X3-2), there is 1 IP address on 1 InfiniBand card (2 InfiniBand ports).

50,000 RDS sockets are provisioned per IP for database usage. Each IO-capable database process will consume RDS sockets across IPs with even load balancing.

Note that cells have the following connection limits:

- On X4 and X5 systems, the cell connection limit is 120,000 processes.
- On X2 and X3 systems, the cell connection limit is 60,000 processes.

This means that the total number of database processes cannot exceed the above limits on the cell nodes. For example, a full rack of 8 databases running at the maximum process count will exceed the cell connection limit.

### Related Topics

- [Increased Exadata Cell Connection Limit](#)

## 7.3.9 Custom Diagnostic Package for Storage Server Alerts

Oracle Exadata Storage Servers automatically collect customized diagnostic packages that include relevant logs and traces upon generating a cell alert. This applies to all cell alerts, including both hardware alerts and software alerts. The timely collection of the diagnostic information prevents rollover of critical logs.

Management Server (MS) sends the diagnostic package as an email attachment for every email alert. You can access the following URL to download an existing diagnostic package if the email attachment is misplaced. In the following URL, *hostname* refers to the host name of the cell.

```
https://hostname/diagpack
```

You can also download the packages using ExaCLI.

You can create hourly custom diagnostic packages by providing the start time and duration using the `CREATE DIAGPACK CellCLI` command.

For details, see `CREATE DIAGPACK` in the *Oracle Exadata System Software User's Guide*.

## 7.3.10 Updating Nodes Using patchmgr

Starting with Oracle Exadata System Software release 12.1.2.2.0, Exadata Database Machine database nodes (releases later than 11.2.2.4.2), Oracle Exadata VM management domains (dom0), and Oracle Exadata VM user domains (domU) can be updated, rolled back, and backed up using patchmgr. You can still run `dbnodeupdate.sh` in standalone mode, but using patchmgr enables you to run a single command to update multiple nodes; you do not need to run `dbnodeupdate.sh` separately on each node. patchmgr can update the nodes in a rolling or non-rolling fashion.

The updated patchmgr and `dbnodeupdate.sh` are available in the new `dbserver.patch.zip` file, which can be downloaded from My Oracle Support Doc ID 1553103.1.

### Related Topics

- [Overview of Performing Exadata Database Servers Updates](#)
- [dbnodeupdate.sh and dbserver.patch.zip: Updating Exadata Database Server Software using the DBNodeUpdate Utility and patchmgr \(My Oracle Support Doc ID 1553103.1\)](#)

## 7.3.11 kdump Operational for 8-Socket Database Nodes

In releases earlier than 12.1.2.2.0, kdump, a service that creates and stores kernel crash dumps, was disabled on Exadata 8-socket database nodes because generating the vmcore took too long and consumed too much space. Starting with Exadata release 12.1.2.2.0, kdump is fully operational on 8-socket database nodes due to the following optimizations:

- Hugepages and several other areas of shared memory are now exposed by the Linux kernel to user space, then filtered out by makedumpfile at kernel crash time. This saves both time and space for the vmcore.
- Memory configuration for the kexec kernel has been optimized.
- Overall memory used has been reduced by blocking unnecessary modules.
- Snappy compression is enabled on the database nodes to speed up vmcore generation.

### 7.3.12 Redundancy Check When Powering Down the Storage Server

If you try to shut down gracefully a storage server by pressing the power button on the front or going through ILOM, the storage server performs an ASM data redundancy check. If shutting down the storage server could lead to an ASM disk group force dismount due to reduced data redundancy, the shutdown is aborted and the LEDs blink as follows to alert the user that shutting down the storage server is not safe:

- On high capacity cells, all three LEDs on all hard drives blink for 10 seconds.
- On extreme flash cells, the blue OK-to-Remove LED blinks for 10 seconds, and the amber LED is lit.

You should not attempt a hard reset on the storage server.

If a storage server cannot be safely shut down due to reduced redundancy (the command "cellcli -e list griddisk attributes name, deactivationOutcome" will show all the offline and unhealthy disks), then you need to restore the data redundancy first. If there are other offline disks, you need to bring them back online and wait for resync to finish. If there is rebalance running to force drop failed disks or resilvering running to resilver data blocks after write back flash cache failure, you need to wait for the rebalance or resilvering to complete. Once data redundancy is restored, you may proceed to shut down the storage server again.

### 7.3.13 Specifying an IP Address for SNMP Traps

If the IP address associated with eth0 is not registered with Oracle ASR Manager, you can specify a different IP address using the new `fromIPfield` in the `ALTER CELL` command (for storage servers) or the `ALTER DBSERVER` command (for database servers).

For details, see the description for:

- `ALTER CELL` in the *Oracle Exadata System Software User's Guide*
- `ALTER DBSERVER` in the *Oracle Exadata Database Machine Maintenance Guide*

### 7.3.14 Reverse Offload Improvements

Minimum software required: 12.1.0.2 BP11

The reverse offload feature enables a storage cell to push some offloaded work back to the database node when the storage cell's CPU is saturated.

Reverse offload from storage servers to database nodes is essential in providing a more uniform usage of all the database and storage CPU resources available in an Exadata environment. In most configurations, there are more database CPUs than storage CPUs, and the ratio may vary depending on the hardware generation and the number of database and cell nodes.

Different queries running at the same time need different rates of reverse offload to perform optimally with regard to elapsed time. Even the same query running in different instances may need different rates of reverse offload.

In this release, a number of heuristic improvements have been added for elapsed time improvement of up to 15% for multiple database instances and different queries running in parallel.

### 7.3.15 Cell-to-Cell Rebalance Preserves Flash Cache Population

Minimum software required: 12.1.0.2 BP11

When a hard disk hits a predictive failure or true failure, and data needs to be rebalanced out of it, some of the data that resides on this hard disk might have been cached on the flash disk, providing better latency and bandwidth accesses for this data. To maintain an application's current performance SLA, it is critical to rebalance the data while honoring the caching status of the different regions on the hard disk during the cell-to-cell offloaded rebalance.

This feature provides significant performance improvement compared to earlier releases for application performance during a rebalance due to disk failure or disk replacement.

When data is rebalanced from one cell to another, the data that was cached on the source cell is also cached on the target cell.

## 7.4 What's New in Oracle Exadata Database Machine 12c Release 1 (12.1.2.1.2)

The following features are new for Oracle Exadata Database Machine 12c Release 1 (12.1.2.1.2):

- [InfiniBand Partitioning for Virtualized Exadata Environments](#)

### 7.4.1 InfiniBand Partitioning for Virtualized Exadata Environments

InfiniBand partitioning is now available for virtualized Exadata environments and can be configured with the Oracle Exadata Deployment Assistant (OEDA).

Use the graphical user interface of OEDA to define the InfiniBand partitions on a per-cluster basis, and the command line interface of OEDA to configure the guests and the InfiniBand switches with the appropriate partition keys and membership requirements to enable InfiniBand partitions.

InfiniBand partitions can be defined on a per-cluster basis. If storage servers are shared among multiple clusters, then all clusters will use the same storage partition key.

## 7.5 What's New in Oracle Exadata Database Machine 12c Release 1 (12.1.2.1.1)

The following features are new for Oracle Exadata Database Machine 12c Release 1 (12.1.2.1.1):



- [Flash Performance Improvement in X5 Storage Servers](#)
- [Oracle Exadata Virtual Machines](#)
- [Infrastructure as a Service \(IaaS\) with Capacity-on-Demand \(CoD\)](#)
- [Improved Flash Cache Metrics](#)
- [Leap Second Time Adjustment](#)
- [Network Resource Management](#)
- [DBMCLI Replaces /opt/oracle.cellos/compmon/exadata\\_mon\\_hw\\_asr.pl Script](#)

## 7.5.1 Flash Performance Improvement in X5 Storage Servers

Changes were made in the NVMe flash firmware to improve I/O task handling resources and modifications to the background refresh algorithms and operations. The flash performance is equivalent or slightly higher in this release.

## 7.5.2 Oracle Exadata Virtual Machines

Consolidated environments can now use Oracle Virtual Machine (Oracle VM) on X5-2, X4-2, X3-2, and X2-2 database servers to deliver higher levels of isolation between workloads. Virtual machine isolation is desirable for workloads that cannot be trusted to restrict their security, CPU, or memory usage in a shared environment.

## 7.5.3 Infrastructure as a Service (IaaS) with Capacity-on-Demand (CoD)

Oracle Exadata Infrastructure as a Service (IaaS) customers now have the Capacity-on-Demand feature to limit the number of active cores in the database servers in order to restrict the number of required database software licenses. Exadata 12.1.2.1.1 Software allows CoD and IaaS to coexist on the same system. Note that IaaS-CoD, the ability to turn on/off a reserved set of cores, is still included with IaaS.

## 7.5.4 Improved Flash Cache Metrics

This release contains integrated block cache and columnar cache metrics for better flash cache performance analysis.

## 7.5.5 Leap Second Time Adjustment

This release contains leap second support in anticipation of the June 30, 2015 leap second adjustment.

## 7.5.6 Network Resource Management

- Oracle 1.6TB NVMe SSD firmware update to 8DV1RA12 in X5-2 Extreme Flash (EF) Storage Servers
- Oracle Flash Accelerator F160 PCIe card's firmware update to 8DV1RA12 in X5-2 High Capacity (HC) Storage Servers

## 7.5.7 DBMCLI Replaces /opt/oracle.cellos/compmon/exadata\_mon\_hw\_asr.pl Script

Starting in Oracle Exadata Storage Server Release 12.1.2.1.0, a new command-line interface called DBMCLI is introduced to configure, monitor, and manage the database servers. DBMCLI is pre-installed on each database server and on DOM0 of virtualized machines. DBMCLI configures Auto Service Request, capacity-on-demand, Infrastructure as a Service, and database server e-mail alerts. DBMCLI replaces the /opt/oracle.cellos/compmon/exadata\_mon\_hw\_asr.pl Perl script. Refer to the *Oracle Exadata Database Machine Maintenance Guide* for information on how to use DBMCLI.

## 7.6 What's New in Oracle Exadata Database Machine 12c Release 1 (12.1.2.1.0)

The following features are new for Oracle Exadata Database Machine 12c Release 1 (12.1.2.1.0):

- [Oracle Exadata Database Machine Elastic Configurations](#)
- [Sparse Grid Disks](#)
- [Snapshot Databases for Test and Development](#)
- [Columnar Flash Caching](#)
- [Oracle Exadata System Software I/O Latency Capping for Write Operations](#)
- [Elimination of False Drive Failures](#)
- [Flash and Disk Life Cycle Management Alert](#)
- [Performance Optimization for SQL Queries with Minimum or Maximum Functions](#)
- [Oracle Exadata Storage Server Software Performance Statistics in AWR Reports](#)
- [Exafusion Direct-to-Wire Protocol](#)
- [Management Server on Database Servers](#)
- [SQL Operators for JSON and XML](#)
- [I/O Resource Management for Flash](#)
- [Flash Cache Space Resource Management](#)
- [I/O Resource Management Profiles](#)
- [Write Back Flash Cache on Extreme Flash Cells](#)
- [Secure Erase for 1.6 TB Flash Drives in Extreme Flash and High Capacity Systems](#)
- [Increased Exadata Cell Connection Limit](#)
- [Support for SNMP v3](#)
- [Federal Information Processing Standards \(FIPS\) 140-2 Compliant Smart Scan](#)
- [Oracle Exadata Virtual Machines](#)

## 7.6.1 Oracle Exadata Database Machine Elastic Configurations

Elastic configurations allow Oracle Exadata Racks to have customer-defined combinations of database servers and Exadata Storage Servers. At least 2 database servers and 3 storage servers must be installed in the rack. The storage servers must all be the same type. Oracle Exadata Database Machine X5-2 Elastic Configurations and Oracle Exadata Database Machine X4-8 Elastic Configuration can have 2 to 19 database servers, 3 to 20 Exadata Storage Servers, or a combination of database servers and Exadata Storage Servers. Oracle Exadata Storage Expansion Rack X5-2 Elastic Configurations can have 4 to 19 storage servers.

Elastic configurations allow Oracle Exadata Racks to have customer-defined combinations of database servers and Exadata Storage Servers. This allows the hardware configuration to be tailored to specific workloads such as Database In-Memory, OLTP, Data Warehousing, or Data Retention.

- Oracle Exadata Database Machine X5-2 Elastic Configurations start with a quarter rack containing 2 database servers and 3 Exadata Storage Servers. Additional database and storage servers (High Capacity (HC) or Extreme Flash (EF)) can be added until the rack fills up or a rack maximum of 22 total servers is reached.
- Oracle Exadata Storage Expansion Rack X5-2 Elastic Configurations start with a quarter rack containing 4 Exadata Storage Servers. Additional storage servers (HC or EF) can be added to a total of 19 storage servers per rack.
- Oracle Exadata Database Machine X4-8 Elastic Configurations start with a half rack containing 2 database server X4-8 8-socket servers and 3 Exadata Storage Servers. Up to 2 additional X4-8 8-socket servers can be added per rack. Up to 11 additional Exadata Storage Servers (HC or EF) can be added per rack.



**See Also:**

[Elastic Configurations](#)

## 7.6.2 Sparse Grid Disks

Sparse grid disks allocate space as new data is written to the disk, and therefore have a virtual size that can be much larger than the actual physical size. Sparse grid disks can be used to create a sparse disk group to store database files that will use a small portion of their allocated space. Sparse disk groups are especially useful for quickly and efficiently creating database snapshots on Oracle Exadata. Traditional databases can also be created using a sparse disk group.

Minimum hardware: Storage nodes must be X3 or later

Minimum software: Oracle Database 12c Release 1 (12.1) release 12.1.0.2 BP5 or later.

## 7.6.3 Snapshot Databases for Test and Development

Space-efficient database snapshots can now be quickly created for test and development purposes. Snapshots start with a shared read-only copy of the production database (or

pluggable database (PDB)) that has been cleansed of any sensitive information. As changes are made, each snapshot writes the changed blocks to a sparse disk group.

Multiple users can create independent snapshots from the same base database. Therefore multiple test and development environments can share space while maintaining independent databases for each task. Snapshots on Exadata Storage Servers allow testing and development with Oracle Exadata Storage Server Software features such as Smart Scan.

Exadata database snapshots are integrated with the Multi-tenant Database Option to provide an extremely simple interface for creating new PDB snapshots.

Minimum hardware: Storage nodes must be X3 or later

Minimum software: Oracle Database 12c Release 1 (12.1) release 12.1.0.2 BP5 or later.

## 7.6.4 Columnar Flash Caching

Oracle Exadata System Software release 12.1.2.1.0 can efficiently support mixed workloads, delivering optimal performance for both OLTP and analytics. This is possible due to the dual format architecture of Exadata Smart Flash Cache that enables the data to be stored in hybrid columnar for transactional processing and also stored in pure columnar, which is optimized for analytical processing.

In addition, Exadata Hybrid Columnar Compression balances the needs of OLTP and analytic workloads. Exadata Hybrid Columnar Compression enables the highest levels of data compression and provides tremendous cost-savings and performance improvements due to reduced I/O, especially for analytic workloads.

In Oracle Exadata System Software release 12.1.2.1.0, Exadata Smart Flash Cache software transforms hybrid columnar compressed data into pure columnar during flash cache population for optimal analytics processing. Flash caches on pure columnar data in flash run faster because they read only the selected columns, reducing flash I/Os and storage server CPU consumption.

Oracle Exadata System Software release 12.1.2.1.0 has the ability to cache Exadata Hybrid Columnar Compression table data on flash cache in a pure columnar layout. When Exadata Hybrid Columnar Compression tables are accessed using Smart Scan, the Exadata Hybrid Columnar Compression compressed data is reformatted to a pure columnar layout in the same amount of storage space on flash cache.

The percentage of data for a given column in a compression unit (CU) for a wide table is small compared to narrow table. This results in more CUs being fetched from disks and flash to get data for the entire column. Queries reading only a few columns of a wide Exadata Hybrid Columnar Compression table exhibit high I/O bandwidth utilization due to irrelevant columns being read from storage. Storing the data in a columnar format on flash cache alleviates the need for reading the irrelevant columns and provides a significant performance boost.

Depending on the type of workload (OLTP or data warehousing), the same region of data can be cached in both the traditional block format as well as the columnar format in flash cache.

This feature is enabled by default; you do not need to configure anything to use this feature.

Columnar Flash Caching accelerates reporting and analytic queries while maintaining excellent performance for OLTP style single row lookups.

Columnar Flash Caching implements a dual format architecture in Oracle Exadata Database Machine flash by automatically transforming frequently scanned Exadata Hybrid Columnar Compression compressed data into a pure columnar format as it is loaded into the flash cache. Smart Scans operating on pure columnar data in flash run faster because they read only the selected columns reducing flash I/Os and storage server CPU.

The original Exadata Hybrid Columnar Compression formatted data can also be cached in the flash cache if there are frequent OLTP lookups for the data. Therefore the Exadata Smart Flash Cache automatically optimizes the format of the cached data to accelerate all types of frequent operations.

This feature is enabled by default; you do not need to configure anything to use this feature.

Minimum software: Oracle Exadata System Software release 12.1.2.1.0 running Oracle Database 12c release 12.1.0.2.0.

#### See Also:

*Oracle Exadata System Software User's Guide* for information about the flash cache metrics

## 7.6.5 Oracle Exadata System Software I/O Latency Capping for Write Operations

This feature helps eliminate any outliers due to slow reads. It prevents read outliers that would otherwise have been visible to applications.

Disks drives, disk controllers, and flash devices are complex computers that can, occasionally, exhibit high latencies while the device is performing an internal maintenance or recovery operation. In addition, devices that are close to failing sometimes exhibit high latencies before they fail. Previously, devices exhibiting high latencies could occasionally cause slow SQL response times. Oracle Exadata System Software I/O latency capping for write operations ensures excellent SQL I/O response times on Oracle Exadata Database Machine by automatically redirecting high latency I/O operations to a mirror copy.

In Oracle Exadata System Software releases 11.2.3.3.1 and 12.1.1.1.1, if Oracle Exadata Database Machine tries to read from a flash device but the latency of the read I/O is longer than expected, the Oracle Exadata System Software automatically redirects the read I/O operations to another storage server (cell). The database server that initiated the read I/O is sent a message that causes the database server to redirect the read I/O to another mirror copy of the data. Any read I/O issued to the last valid mirror copy of the data is not redirected.

In Oracle Exadata System Software release 12.1.2.1.0, if a write operation encounters high latency, then Oracle Exadata System Software automatically redirects the write operation to another healthy flash device on the same storage server. After the write completes successfully, the write I/O is acknowledged as successful to the database server, thereby eliminating the write outlier.

Requirements:

- Minimum software:

- Oracle Database 11g release 2 (11.2) Monthly Database Patch For Exadata (June 2014 - 11.2.0.4.8)
- Oracle Grid Infrastructure 11g release 2 (11.2) Monthly Database Patch For Exadata (June 2014 - 11.2.0.4.8)
- Enable write-back flash cache on the storage server (cell)

## 7.6.6 Elimination of False Drive Failures

Disks drives, and flash drives are complex computers that can occasionally appear to fail due to internal software lockups without actually physically failing. In the event of an apparent hard drive failure on X5-2 High Capacity cell or an apparent flash drive failure on X5-2 Extreme Flash cell, Oracle Exadata System Software automatically redirects I/Os to other drives, and then power cycles the drive. If the drive returns to normal status after the power cycle, then it will be re-enabled and resynchronized. If the drive continues to fail after being power cycled, then it will be dropped. This feature allows Oracle Exadata System Software to eliminate false-positive disk failures and therefore helps to preserve data redundancy and reduce management.

## 7.6.7 Flash and Disk Life Cycle Management Alert

Oracle Exadata Storage Server Software now monitors Oracle ASM rebalance operations due to disk failure and replacement. Management Server sends an alert when a rebalance operation completes successfully, or encounters an error.

In previous releases, the user would have to periodically monitor the progress of rebalance operations by querying the V\$ASM\_OPERATION view. Now the user can subscribe to alerts from Management Server, and receive updates on Oracle ASM rebalance operations.

Minimum software: Oracle Database release 12.1.0.2 BP4 or later, and Oracle Exadata Storage Server Software release 12.1.2.1.0 or later.

## 7.6.8 Performance Optimization for SQL Queries with Minimum or Maximum Functions

SQL queries using minimum or maximum functions are designed to take advantage of the storage index column summary that is cached in Exadata Storage Server memory. As a query is processed, a running minimum value and a running maximum value are tracked. Before issuing an I/O, the minimum/maximum value cached in the storage index for the data region is checked in conjunction with the running minimum/maximum value to decide whether that I/O should be issued or can be pruned. Overall, this optimization can result in significant I/O pruning during the course of a query and improves query performance. An example of a query that benefits from this optimization is:

```
Select max(Salary) from EMP where Department = 'sales';
```

Business intelligence tools that get the shape of a table by querying the minimum or maximum value for each column benefit greatly from this optimization.

The following session statistic shows the amount of I/O saved due to storage index optimization.

```
cell physical IO bytes saved by storage index
```

Minimum software: Oracle Database release 12.1.0.2.

## 7.6.9 Oracle Exadata Storage Server Software Performance Statistics in AWR Reports

Exadata Storage Server configuration and performance statistics are collected in the Automatic Workload Repository (AWR), and the data is available in the AWR report. The Oracle Exadata section of the AWR report is available in HTML or active report format.

The following sections are three main sections in the AWR report:

- Exadata Server Configuration: Hardware model information, software versions, and storage configuration
- Exadata Server Health Report: Offline disks and open alerts
- Exadata Performance Statistics: Operating system statistics, storage server software statistics, smart scan statistics, and statistics by databases

The AWR report provides storage level performance statistics, not restricted to a specific instance or a database. This is useful for analyzing cases where one database can affect the performance of another database.

Configuration differences are highlighted using specific colors for easy analysis. For example, a cell with a different software release than the other cells, or a cell with different memory configuration than the other cells are highlighted.

Outliers are automatically analyzed and presented for easy performance analysis. Outliers are appropriately colored and linked to detailed statistics.

Minimum software: Oracle Database release 12.1.0.2, and Oracle Exadata Storage Server Software release 12.1.2.1.0.

## 7.6.10 Exafusion Direct-to-Wire Protocol

Exafusion Direct-to-Wire protocol allows database processes to read and send Oracle Real Applications Cluster (Oracle RAC) messages directly over the InfiniBand network bypassing the overhead of entering the OS kernel, and running the normal networking software stack. This improves the response time and scalability of the Oracle RAC environment on Oracle Exadata Database Machine. Exafusion is especially useful for OLTP applications because per message overhead is particularly apparent in small OLTP messages.

Minimum software: Oracle Exadata Storage Server Software release 12.1.2.1.0 contains the OS, firmware, and driver support for Exafusion and Oracle Database software release 12.1.0.2.0 BP1.

## 7.6.11 Management Server on Database Servers

Management Server (MS) on database servers implements a web service for database server management commands, and runs background monitoring threads. The management service provides the following:

- Comprehensive hardware and software monitoring including monitoring of hard disks, CPUs, and InfiniBand ports.
- Enhanced alerting capabilities.
- Important system metric collection and monitoring.



- A command-line interface called DBMCLI to configure, monitor, and manage the database servers. DBMCLI is pre-installed on each database server and on DOM0 of virtualized machines. DBMCLI configures Auto Service Request, capacity-on-demand, Infrastructure as a Service, and database server e-mail alerts.

Oracle Exadata Database Machine Command-Line Interface (DBMCLI) utility is the command-line administration tool for managing the database servers. DBMCLI runs on each server to enable you to manage an individual database server. DBMCLI also runs on virtual machines. You use DBMCLI to configure, monitor, and manage the database servers. The command-line utility is already installed when Oracle Exadata Database Machine is shipped.

DBMCLI provides an integrated client interface to configure Auto Service Request, capacity-on-demand, Infrastructure as a Service, and database server e-mail alerts. It also provides for monitoring of hard disks, CPUs, InfiniBand ports, as well as system metrics and thresholds.



#### See Also:

*Oracle Exadata Database Machine Maintenance Guide* for additional information about DBMCLI

## 7.6.12 SQL Operators for JSON and XML

Oracle Exadata System Software supports offload of many SQL operators for predicate evaluation. Offload of the following SQL operators are now supported by Oracle Exadata System Software:

- JSON Operators
  - JSON\_VALUE
  - JSON\_EXISTS
  - JSON\_QUERY
  - IS JSON
  - IS NOT JSON
- XML Operators
  - XMLExists
  - XMLCast(XMLQuery())

Minimum software: Oracle Database release 12.1.0.2 for offload of JSON. Oracle Database release 12.1.0.2 BP1 for XML operator offload.

## 7.6.13 I/O Resource Management for Flash

I/O Resource Management (IORM) now manages flash drive I/Os in addition to disk drive I/Os to control I/O contention between databases, pluggable databases, and consumer groups. Because it is very rare for Oracle Exadata environments to be limited by OLTP I/Os, IORM automatically prioritizes OLTP flash I/Os over smart scan flash I/Os, ensuring fast OLTP response times with little cost to smart scan throughput.



Minimum software: Exadata cell software release 12.1.2.1.0 running Oracle Database 11g or Oracle Database 12c releases

Minimum hardware: Exadata releases X2-\*

## 7.6.14 Flash Cache Space Resource Management

Flash cache is a shared resource. Flash Cache Space Resource Management allows users to specify the minimum and maximum sizes a database can use in the flash cache using interdatabase IORM plans. Flash Cache Space Resource Management also allows users to specify the minimum and maximum sizes a pluggable database (PDB) can use in the flash cache using database resource plans.

Minimum software: Oracle Exadata System Software release 12.1.2.1.0 running Oracle Database 11g or Oracle Database 12c Release 1 (12.1) release 12.1.0.2

Minimum hardware: Oracle Exadata Database Machine model X2-\*



### See Also:

*Oracle Exadata System Software User's Guide*

## 7.6.15 I/O Resource Management Profiles

IORM interdatabase plans now support profiles that reduce management of interdatabase plans for environments with many databases. Previously, a storage administrator had to specify resources for every database in the interdatabase plan. The plan needed updates each time a new database was created. IORM profiles greatly reduce this management. The storage administrator can now create profile directives that define different profile types based on performance requirements. Next, the administrator maps new and existing databases to one of the defined profiles in the interdatabase plan using the database parameter `DB_PERFORMANCE_PROFILE`. Each database inherits all its attributes from the specified profile directive automatically.

Minimum software: Exadata cell software release 12.1.2.1.0 running Oracle Database 12c Release 1 (12.1) release 12.1.0.2 Exadata Bundle Patch 4.

## 7.6.16 Write Back Flash Cache on Extreme Flash Cells

On Extreme Flash cells, flash cache runs in write back mode by default, and takes 5 percent of the flash space. Flash cache on Extreme Flash cells is not used as a block cache because user grid disks are already created on flash and therefore caching is not needed. However, flash cache is still useful for the following advanced operations:

- Columnar caching caches Exadata Hybrid Columnar Compression (EHCC) table data on flash cache in a pure columnar layout on an Extreme Flash cell.
- Write I/O latency capping cancels write I/O operations to a temporarily stalled flash, and redirects the write to be logged in the write back flash cache of another healthy flash device on an Extreme Flash cell
- Fast data file creation persists the metadata about the blocks in the write back flash cache, eliminating the actual formatting writes to user grid disks, on an Extreme Flash cell.

Administrators can choose to configure flash cache in write through mode on Extreme Flash cells. Columnar caching works in write through flash cache mode, but write I/O latency capping and fast data file creation require write back flash cache to be enabled.

## 7.6.17 Secure Erase for 1.6 TB Flash Drives in Extreme Flash and High Capacity Systems

With this release, Oracle Exadata System Software supports secure erase for 1.6 TB flash drives in the Extreme Flash and High Capacity systems. The 1.6 TB flash drives take approximately 5.5 hours to securely erase.



### See Also:

[Exadata Secure Erase](#)

## 7.6.18 Increased Exadata Cell Connection Limit

Oracle Exadata X5-2 and X4-2 cells can now support up to 120,000 simultaneous connections originating from one or more database servers that is using active-active bonding. This implies that at most 120,000 processes can simultaneously remain connected to a cell and perform I/O operations.



### See Also:

["Exadata Cell Connection Limit"](#)

## 7.6.19 Support for SNMP v3

Oracle Exadata Database Machine database and storage servers support SNMP v3 for sending alerts. SNMP v3 provides authentication and encryption for alerts sent from the servers to administrators and Oracle Auto Service Request (ASR).



### See Also:

- *Oracle Exadata Database Machine Maintenance Guide*
- *Oracle Exadata System Software User's Guide*

## 7.6.20 Federal Information Processing Standards (FIPS) 140-2 Compliant Smart Scan

The U.S. Federal Information Processing Standard (FIPS) 140-2 specifies security requirements for cryptographic modules. To support customers with FIPS 140-2 requirements, Oracle Exadata version 12.1.2.1.0 can be configured to use FIPS 140-2 validated cryptographic modules. These modules provide cryptographic services such as Oracle Database password hashing and verification, network encryption (SSL/TLS and native encryption), as well as data at rest encryption (Transparent Data Encryption).

When Transparent Data Encryption is used and Oracle Database is configured for FIPS 140 mode, Oracle Exadata Smart Scan offloads will automatically leverage the same FIPS 140 validated modules for encryption and decryption operations of encrypted columns and encrypted tablespaces.

In Oracle Database release 12.1.0.2.0, the database parameter, `DBFIPS_140`, provides the ability to turn on and off the FIPS 140 cryptographic processing mode inside the Oracle Database and Exadata Storage Server.

In Oracle Database release 11.2.0.4.0, the underscore parameter `_use_fips_mode` provides the ability to turn on or off the FIPS 140 cryptographic processing in Oracle Database and Exadata Storage Server.

For example, using `DBFIPS_140`:

```
ALTER SYSTEM SET DBFIPS_140 = TRUE;
```

For example in the parameter file:

```
DBFIPS_140=TRUE
```

The following hardware components are now FIPS compliant with the firmware updates in the specified releases:

- Oracle Server X5-2 and later systems are designed to be FIPS 140–2 compliant
- Oracle Sun Server X4-8 with ILOM release 3.2.4
- Sun Server X4-2 and X4-2L with SW1.2.0 and ILOM release 3.2.4.20/22
- Sun Server X3-2 and X3-2L with SW1.4.0 and ILOM release 3.2.4.26/28
- Sun Server X2-2 with SW1.8.0 and ILOM release 3.2.7.30.a
- Cisco Catalyst 4948E-F Ethernet Switch

FIPS compliance for V1, X2-\* and database node X3-8 generations of Exadata Database Machine Servers is not planned.

Minimum software: Oracle Database release 12.1.0.2.0 BP3, Oracle Database release 11.2.0.4 with MES Bundle on Top of Quarterly Database Patch For Exadata (APR2014 - 11.2.0.4.6), Oracle Exadata Storage Server Software release 12.1.2.1.0, ILOM 3.2.4.



**See Also:**

*Oracle Database Security Guide* for additional information about FIPS

## 7.6.21 Oracle Exadata Virtual Machines

Consolidated environments can now use Oracle Virtual Machine (Oracle VM) on X5-2, X4-2, X3-2, and X2-2 database servers to deliver higher levels of isolation between workloads. Virtual machine isolation is desirable for workloads that cannot be trusted to restrict their security, CPU, or memory usage in a shared environment. Examples are hosted or cloud environments, cross department consolidation, test and development environments, and non-database or third party applications running on a database machine. Oracle VM can also be used to consolidate workloads that require different versions of clusterware, for example SAP applications that require specific clusterware patches and versions.

The higher isolation provided by virtual machines comes at the cost of increased resource usage, management, and patching because a separate operating system, clusterware, and database install is needed for each virtual machine. Therefore it is desirable to blend Oracle VM with database native consolidation by consolidating multiple trusted databases within a virtual machine. Oracle Resource Manager can be used to control CPU, memory, and I/O usage for the databases within a virtual machine. The Oracle Multitenant option can be used to provide the highest level of consolidation and agility for consolidated Oracle databases.

Exadata Virtual Machines use high speed InfiniBand networking with Single Root I/O Virtualization (SR-IOV) to ensure that performance within a virtual machine is similar to Exadata's famous raw hardware performance. Exadata Smart Scans greatly decrease virtualization overhead compared to other platforms by dramatically reducing message traffic to virtual machines. Exadata Virtual Machines can dynamically expand or shrink CPUs and memory based on the workload requirement of the applications running in that virtual machine.

Virtual machines on Exadata are considered Trusted Partitions, and therefore software can be licensed at the virtual machine level instead of the physical processor level. Without Trusted Partitions, database options and other Oracle software must be licensed at a server or cluster level even though all databases running on that server or cluster may not require a particular option.

## 7.7 What's New in Oracle Exadata Database Machine 12c Release 1 (12.1.1.1.1)

The preceding release 11.2.3.3.1 features are described in "[What's New in Oracle Exadata Database Machine 11g Release 2 \(11.2.3.3.1\)](#)."

The following feature is new for Oracle Exadata Database Machine 12c Release 1 (12.1.1.1.1):

- [Additional SQL Operators and Conditions for LOB and CLOB](#)

## 7.7.1 Additional SQL Operators and Conditions for LOB and CLOB

Oracle Exadata Storage Server Software supports offload of many SQL operators and conditions for predicate evaluation. Offload of the following SQL operators and conditions are now supported by Oracle Exadata Storage Server Software:

- LOB and CLOB Conditions
  - LIKE
  - REGEXP\_LIKE

Smart Scan evaluates the LOB operators and conditions only when a LOB is inlined (stored in the table row). In addition, Smart Scan handles Secure File compression. Using Secure File compression helps reduce the size of LOBs so that they can be inlined.

Minimum software: Oracle Database release 12.1.0.2 for offload of LOB/CLOB



### See Also:

*Oracle Database SecureFiles and Large Objects Developer's Guide* for information about inline LOBs

## 7.8 What's New in Oracle Exadata Database Machine 12c Release 1 (12.1.1.1.0)

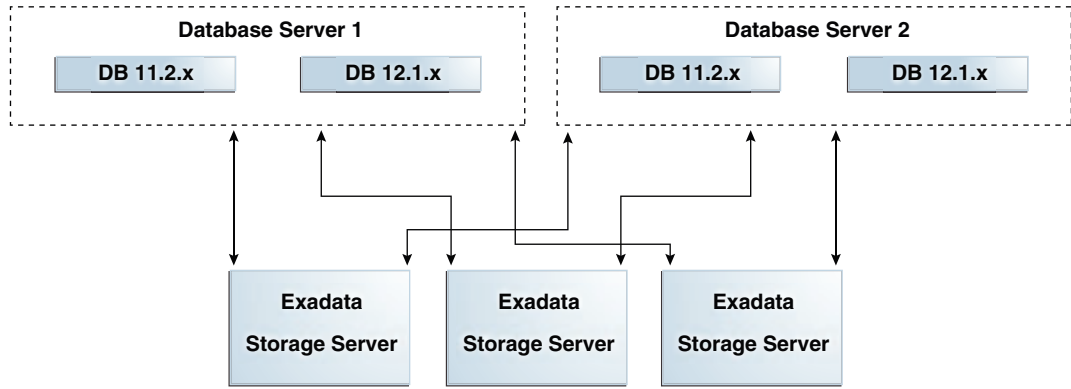
The following are new for Oracle Exadata Database Machine 12c Release 1 (12.1.1.1.0):

- [Support for Oracle Database Releases 12c Release 1 \(12.1\) and 11g Release 2 \(11.2\)](#)
- [IORM Support for CDBs and PDBs](#)
- [Cell to Cell Data Transfer](#)
- [Desupport of HP Oracle Database Machine Hardware](#)

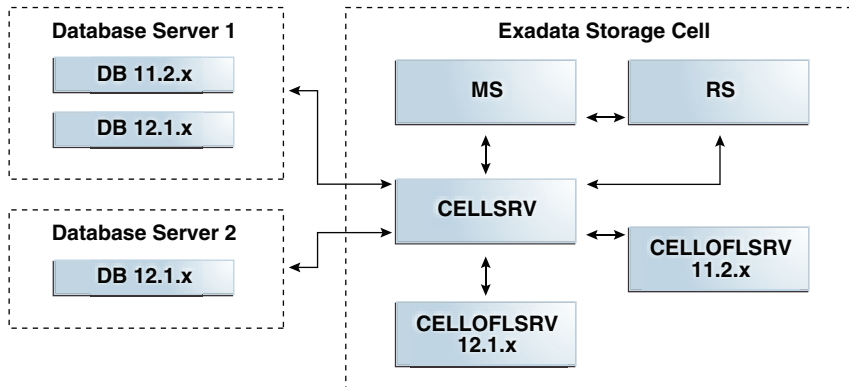
### 7.8.1 Support for Oracle Database Releases 12c Release 1 (12.1) and 11g Release 2 (11.2)

Oracle Exadata Storage Server Software 12c Release 1 (12.1) supports Oracle Database releases 12c Release 1 (12.1) and 11g Release 2 (11.2) running on a single Oracle Exadata Database Machine. The database servers get full performance, such as smart scans, fast file creation, and fast incremental backup, from all Exadata Storage Servers running Oracle Exadata Storage Server Software release 12c Release 1 (12.1).

Oracle Exadata Storage Server Software 12c Release 1 (12.1) is able to support multiple database releases by running appropriate cell offload servers to handle the offload requests. Offload requests coming from Oracle Database 11g Release 2 (11.2) are handled by a release 11g offload server, and offload requests coming from Oracle Database 12c Release 1 (12.1) database are handled by a 12c offload server.



Oracle Exadata Storage Server Software 12c Release 1 (12.1) now contains separate offload servers for each major database release so that it can fully support all offload operations. Offload requests coming from Oracle Database 11g Release 2 (11.2) are handled automatically by a release 11g offload server, and offload requests coming from Oracle Database 12c Release 1 (12.1) database are handled automatically by a 12c offload server.



Exadata Storage Server 12c Release 1 (12.1) can support the following releases of Oracle Database:

Database Release	Minimum Required Release
11.2.0.2	Bundle patch 22
11.2.0.3	Bundle patch 20
11.2.0.4	Current release
12.1.0.1	Current release

## 7.8.2 IORM Support for CDBs and PDBs

Oracle Database 12c Release 1 (12.1) supports a multitenant architecture. In a multitenant architecture, a container is a collection of schemas, objects, and related structures in a Oracle Multitenant container database (CDB) that appears logically to an application as a separate database. In a CDB, administrators can create multiple

pluggable databases (PDBs) to run their workloads. In a CDB, there are multiple workloads within multiple PDBs competing for shared resources.

By using CDB plans and PDB plans, I/O Resource Management (IORM) provides the ability to manage I/O resource utilization among different PDBs as well as manage the workloads within each PDB.

Oracle Database 12c Release 1 (12.1) supports IORM prioritization to manage I/O resource utilization among different PDBs as well as manage the workloads within each PDB.

#### **Related Topics**

- About the Multitenant Architecture
- About Interdatabase IORM Plan Directives

### 7.8.3 Cell to Cell Data Transfer

In earlier releases, Exadata Cells did not directly communicate to each other. Any data movement between the cells was done through the database servers. Data was read from a source cell into database server memory, and then written out to the destination cell. Starting with Oracle Exadata Storage Server Software 12c Release 1 (12.1), database server processes can offload data transfer to cells. A database server instructs the destination cell to read the data directly from the source cell, and write the data to its local storage. This reduces the amount of data transferred across the fabric by half, reducing InfiniBand bandwidth consumption, and memory requirements on the database server. Oracle Automatic Storage Management (Oracle ASM) resynchronization, resilver, and rebalance use this feature to offload data movement. This provides improved bandwidth utilization at the InfiniBand fabric level in Oracle ASM instances. No configuration is needed to utilize this feature.

Minimum software: Oracle Database 12c Release 1 (12.1) or later, and Oracle Exadata Storage Server Software 12c Release 1 (12.1) or later.

### 7.8.4 Desupport of HP Oracle Database Machine Hardware

Oracle Exadata System Software 12c Release 1 (12.1) is not supported on HP Oracle Database Machine hardware. Oracle continues to support HP Oracle Database Machines running Oracle Exadata System Software 11g Release 2 (11.2).

# 8

## New Features for Oracle Exadata System Software Release 11.x

Several new features were introduced for the various versions of Oracle Exadata System Software Release 11.x.

- [What's New in Oracle Exadata Database Machine 11g Release 2 \(11.2.3.3.1\)](#)
- [What's New in Oracle Exadata Database Machine 11g Release 2 \(11.2.3.3.0\)](#)
- [What's New in Oracle Exadata Database Machine 11g Release 2 \(11.2.3.2\)](#)
- [What's New in Oracle Exadata Database Machine 11g Release 2 \(11.2.3.1\)](#)
- [What's New in Oracle Exadata Database Machine 11g Release 2 \(11.2.2.4\)](#)
- [What's New in Oracle Exadata Database Machine 11g Release 2 \(11.2.2.3\)](#)
- [What's New in Oracle Exadata Database Machine 11g Release 2 \(11.2.1.2\)](#)
- [What's New in Oracle Exadata Database Machine 11g Release 2 \(11.2\)](#)

### 8.1 What's New in Oracle Exadata Database Machine 11g Release 2 (11.2.3.3.1)

The following are new for Oracle Exadata System Software 11g Release 2 (11.2.3.3.1):

- [Oracle Capacity-on-Demand for Database Servers](#)
- [Exadata I/O Latency Capping](#)
- [Oracle Exadata Storage Server I/O Timeout Threshold](#)
- [Support for New Hardware](#)

#### 8.1.1 Oracle Capacity-on-Demand for Database Servers

Oracle allows users to limit the number of active cores in the database servers in order to restrict the number of required database software licenses. The reduction of processor cores is implemented during software installation using Oracle Exadata Database Machine Deployment Assistant (OEDA). The number of active cores can be increased at a later time, when more capacity is needed, but not decreased. The number of active processor cores must be the same on every socket of a database server.

Capacity-on-demand differs from Oracle Exadata Infrastructure as a Service (IaaS) as follows:

- The number of active cores for capacity-on-demand cannot be decreased after initial installation.
- Software licenses are only needed for the active cores when using capacity-on-demand.





#### Note:

Reducing the number of active cores lowers the initial software licensing cost. It does not change the hardware cost.



#### See Also:

- *Oracle Exadata Database Machine Maintenance Guide* for information about increasing the number of active cores
- *Oracle Exadata Database Machine Licensing Information User's Guide* for information about licensing and restrictions

## 8.1.2 Exadata I/O Latency Capping

Disks drives or flash devices can, on rare occasion, exhibit high latencies for a small amount of time while an internal recovery operation is running. In addition, drives that are close to failing can sometimes exhibit high latencies before they fail. This feature masks these very rare latency spikes by redirecting read I/O operations to a mirror copy.

Oracle Exadata Storage Server Software automatically redirects read I/O operations to another cell when the latency of the read I/O is much longer than expected. This is performed by returning a message to the database that initiated the read I/O. The database then redirects the I/O to another mirror copy of the data. Any I/Os issued to the last valid mirror copy of the data is not redirected.

Minimum software: Oracle Database 11g Release 2 (11.2) release Monthly Database Patch For Exadata (June 2014 - 11.2.0.4.8). The same release is required for Grid Infrastructure.

## 8.1.3 Oracle Exadata Storage Server I/O Timeout Threshold

The I/O timeout threshold can be configured for Oracle Exadata Storage Servers. Storage server I/O that takes longer than the defined threshold is canceled. Oracle Automatic Storage Management (Oracle ASM) redirects the I/O to another mirror copy of the data. Any write I/Os issued to the last valid mirror copy of the data are not canceled, even if the timeout threshold is exceeded.

Setting the timeout threshold too low can negatively impact system performance. Oracle recommends reviewing the Automatic Workload Repository (AWR) reports of peak I/O loads, and setting the threshold value to a value higher than the peak I/O latency with sufficient safety margin.

Minimum software: Oracle Database 11g Release 2 (11.2) release Monthly Database Patch For Exadata (June 2014 - 11.2.0.4.8). The same release is required for Oracle Grid Infrastructure.



### See Also:

*Oracle Exadata System Software User's Guide* for additional information about the ALTER CELL I/O threshold timeout attribute

## 8.1.4 Support for New Hardware

This release includes support for the following hardware:

- Oracle Exadata Database Machine X4-8 Full Rack
- 4 TB high-capacity drives for Exadata Storage Server X4-2, Exadata Storage Server X3-2, and Exadata Storage Server X2-2

Minimum software: Oracle Exadata Storage Server Software release 11.2.3.3.1

## 8.2 What's New in Oracle Exadata Database Machine 11g Release 2 (11.2.3.3.0)

The following are new for Oracle Exadata System Software 11g Release 2 (11.2.3.3.0):

- [Flash Cache Compression](#)
- [Automatic Flash Caching for Table Scan Workloads](#)
- [Fast Data File Creation](#)
- [Network Resource Management](#)
- [Active Bonding Network](#)
- [Oracle ASM Disk Group in Appliance Mode](#)
- [Automatic Hard Disk Scrub and Repair](#)
- [Drop Hard Disk for Replacement](#)
- [Drop BBU for Replacement](#)
- [Oracle Exadata Database Machine Eighth Rack Configuration](#)
- [Cell Alert Summary](#)
- [Secure Erase for Larger Drives](#)
- [Periodic ILOM Reset](#)
- [Oracle Exawatcher Replaces Oracle OSwatcher](#)
- [Enhancements for Hardware and Software](#)

### 8.2.1 Flash Cache Compression

Flash cache compression dynamically increases the logical capacity of the flash cache by transparently compressing user data as it is loaded into the flash cache. This allows much more data to be kept in flash, and decreases the need to access data on disk drives. The I/Os to data in flash are orders of magnitude faster than the I/Os to data on disk. The compression and decompression operations are completely transparent to the application

and database, and have no performance overhead, even when running at rates of millions of I/Os per second.

Depending on the user data compressibility, Oracle Exadata System Software dynamically expands the flash cache size up to two times. Compression benefits vary based on the redundancy in the data. Tables and indexes that are uncompressed have the largest space reductions. Tables and indexes that are OLTP compressed have significant space reductions. Tables that use Hybrid Columnar Compression have minimal space reductions. Oracle Advanced Compression Option is required to enable flash cache compression.

This feature is enabled using the CellCLI `ALTER CELL flashCacheCompress=true` command.

Minimum hardware: Oracle Exadata Database Machine X3-2

## 8.2.2 Automatic Flash Caching for Table Scan Workloads

Oracle Exadata Storage Server Software automatically caches objects read by table and partition scan workloads in flash cache based on how frequently the objects are read. The algorithm takes into account the size of the object, the frequency of access of the object, the frequency of access to data displaced in the cache by the object, and the type of scan being performed by the database. Depending on the flash cache size, and the other concurrent workloads, all or only part of the table or partition is cached. There is no risk of thrashing the flash cache by trying to cache an object that is large compared to the size of the flash cache, or by caching a table that is accessed by maintenance operations.

This new feature largely eliminates the need for manually keeping tables in flash cache except to guarantee low response times for certain objects at the expense of potentially increasing total disk I/Os. In earlier releases, database administrators had to mark a large object as `KEEP` to have it cached in flash cache for table scan workloads.

This feature primarily benefits table scan intensive workloads such as Data Warehouses and Data Marts. Random I/Os such as those performed for Online Transaction Processing (OLTP) continue to be cached in the flash cache the same way as in earlier releases.

Minimum software: Oracle Exadata Storage Server Software release 11.2.3.3

## 8.2.3 Fast Data File Creation

Fast data file creation more than doubles the speed at which new data files are formatted. Instead of writing the newly formatted blocks to disk or flash, the flash cache just persists the metadata about the blocks in the write back flash cache, eliminating the actual formatting writes to disks. For example, creating a 1 TB data file on Oracle Exadata Full Rack running release 11.2.3.3 takes 90 seconds when using fast data file creation. Creating the same 1TB data file on earlier releases takes 220 seconds. This feature works automatically when write back flash cache is enabled, and the correct software releases are in use.

Minimum software: Oracle Exadata Storage Server Software release 11.2.3.3 running Oracle Database 11g Release 2 (11.2) release 11.2.0.4, or Oracle Database 12c Release 1 (12.1) release 12.1.0.1

## 8.2.4 Network Resource Management

Network Resource Management automatically and transparently prioritizes critical database network messages through the InfiniBand fabric ensuring fast response times for latency critical operations. Prioritization is implemented in the database, database InfiniBand adapters, Oracle Exadata Storage Server Software, Exadata storage InfiniBand adapters, and InfiniBand switches to ensure prioritization happens through the entire InfiniBand fabric.

Latency sensitive messages such as Oracle RAC Cache Fusion messages are prioritized over batch, reporting, and backup messages. Log file write operations are given the highest priority to ensure low latency for transaction processing.

This feature works in conjunction with CPU and I/O Resource Management to help ensure high and predictable performance in consolidated environments. For example, given an online transaction processing (OLTP) workload, commit latency is determined by log write latency. This feature enables log writer process (LGWR) network transfer to be prioritized over other database traffic in the same or other databases, such as backups or reporting.

This feature is enabled by default, and requires no configuration or management.

Minimum software: Oracle Exadata Storage Server Software release 11.2.3.3 running Oracle Database 11g Release 2 (11.2) release 11.2.0.4, or Oracle Database 12c Release 1 (12.1) release 12.1.0.1, and switch firmware release 2.1.3-4

## 8.2.5 Active Bonding Network

Oracle Exadata Database Machine X4-2 database servers and storage servers enable active bonding support for both ports of an InfiniBand card. Active bonding provides much higher network bandwidth when compared to active passive bonding in earlier releases because both InfiniBand ports are simultaneously used for sending network traffic.

The active bonding capability improves network bandwidth on Oracle Exadata Database Machine X4-2 because it features a new InfiniBand card that supports much higher throughput than previous InfiniBand cards. Active bonding does not improve bandwidth on earlier generation hardware because earlier InfiniBand cards were not fast enough to take advantage of the faster bandwidth provided by the latest generation server PCI bus.

Note the following about active bonding on an InfiniBand card:

- Database servers running Oracle Linux provide the active bonding capability.
- Oracle Clusterware requires the same interconnect name on each database server in the cluster. It is advisable to keep legacy bonding on the database servers when expanding existing Oracle Exadata Database Machine X3-2 and Oracle Exadata Database Machine X2-2 systems with Oracle Exadata Database Machine X4-2 systems.
- Two IP addresses are required for each InfiniBand card for increased network bandwidth.

The following table provides guidelines on how to configure systems:

Operating System	Database Servers in Oracle Exadata Database Machine X4-2	Storage Servers in Oracle Exadata Database Machine X4-2	Database Servers in Oracle Exadata Database Machine X3-8 Full Rack with Exadata Storage Server X4-2L Servers
Oracle Linux	Active bonding	Active bonding	Legacy bonding, single port per HCA active
Oracle Solaris	IPMP, single port active	Active bonding	IPMP, single port per HCA active

Minimum hardware: Oracle Exadata Database Machine X4 generation servers

Minimum software: Oracle Exadata Storage Server Software release 11.2.3.3

## 8.2.6 Oracle ASM Disk Group in Appliance Mode

The Oracle ASM `appliance.mode` attribute improves disk rebalance completion time when dropping one or more Oracle ASM disks. This means that redundancy is restored faster after a failure. The attribute is automatically enabled when creating a new disk group. Existing disk groups must explicitly set the attribute using the `ALTER DISKGROUP` command.

The attribute can only be enabled on disk groups that meet the following requirements:

- The Oracle ASM disk group attribute `compatible.asm` is set to release 11.2.0.4, or later.
- The `cell.smart_scan_capable` attribute is set to `TRUE`.
- All disks in the disk group are the same type of disk, such as all hard disks or extreme flash disks.
- All disks in the disk group are the same size.
- All failure groups in the disk group have an equal number of disks.
- No disk in the disk group is offline.

Minimum software: Oracle Exadata System Software release 11.2.3.3 running Oracle Database 11g Release 2 (11.2) release 11.2.0.4 or Oracle Database 12c Release 1 (12.1) release 12.1.0.2

### See Also:

*Oracle Exadata System Software User's Guide* for additional information about the `appliance.mode` attribute

## 8.2.7 Automatic Hard Disk Scrub and Repair

Oracle Exadata System Software automatically inspects and repairs hard disks periodically when hard disks are idle. If bad sectors are detected on a hard disk, then

Oracle Exadata System Software automatically sends a request to Oracle ASM to repair the bad sectors by reading the data from another mirror copy. By default, the hard disk scrub runs every two weeks.

Minimum software: Oracle Exadata System Software release 11.2.3.3 running Oracle Database 11g Release 2 (11.2) release 11.2.0.4 or Oracle Database 12c Release 1 (12.1) release 12.1.0.2.

 **See Also:**

*Oracle Exadata System Software User's Guide* for additional information about setting the scrub interval

## 8.2.8 Drop Hard Disk for Replacement

Before replacing a normal hard disk that is not in any failure status, the Oracle Exadata Database Machine administrator must run the `ALTER PHYSICALDISK DROP FOR REPLACEMENT` command, and confirm its success before removing the hard disk from Oracle Exadata Storage Server. The command checks to ensure that the grid disks on that hard disk can be safely taken offline from Oracle ASM without causing a disk group force dismount. If all the grid disks can be offlined without leading to disk group force dismount, then the command puts the grid disks offline from Oracle ASM, disables the hard disk, and then turns on the service LED on the storage server.

Minimum software: Oracle Exadata System Software release 11.2.3.3

 **See Also:**

*Oracle Exadata System Software User's Guide* for additional information about the `ALTER PHYSICALDISK` command

## 8.2.9 Drop BBU for Replacement

Before performing an online BBU (battery backup unit) replacement on an Oracle Exadata Database Machine database server or storage server, the Oracle Exadata Database Machine administrator must run the `ALTER CELL BBU DROP FOR REPLACEMENT` command, and confirm the success of the command. The command changes the controller to write-through caching and ensures that no data loss can occur when the BBU is replaced in case of a power loss.

Minimum hardware: Oracle Exadata Database Machine X3-2 or Oracle Exadata Database Machine X3-8 Full Rack, with disk-form-factor BBU

Minimum software: Oracle Exadata System Software release 11.2.3.3

 **See Also:**

- *Oracle Exadata Database Machine Maintenance Guide* for information about replacing the BBU
- *Oracle Exadata System Software User's Guide* for information about the `ALTER CELL BBU DROP FOR REPLACEMENT` command

## 8.2.10 Oracle Exadata Database Machine Eighth Rack Configuration

Oracle Exadata Database Machine Eighth Rack configuration for storage cells can be enabled and disabled using the `ALTER CELL eighthRack` command. No more than 6 cell disks are created on hard disks and no more than 8 cell disks are created on flash disks when using an eighth rack configuration.

Minimum software: Oracle Exadata Storage Server Software release 11.2.3.2.1

 **See Also:**

*Oracle Exadata Database Machine Maintenance Guide* for additional information about configuring Oracle Exadata Database Machine Eighth Rack

## 8.2.11 Cell Alert Summary

Oracle Exadata System Software periodically sends out an e-mail summary of all open alerts on Oracle Exadata Storage Servers. The open alerts e-mail message provides a concise summary of all open issues on a cell. The summary includes the following:

- Cell name
- Event time
- Severity of the alert
- Description of the alert
- Information about configuring the alert summary

Alerts created since the previous summary are marked with an asterisk.

Minimum software: Oracle Exadata System Software release 11.2.3.3

 **See Also:**

*Oracle Exadata System Software User's Guide* for additional information about configuring the alert summary

## 8.2.12 Secure Erase for Larger Drives

With this release, Oracle Exadata Storage Server Software supports secure erase for larger hard drives, and flash drives. The following are the approximate times needed to securely erase the drives using the supported algorithms:

Type of Drive	One Pass (1pass)	Three Pass (3pass)	Seven Pass (7pass)
1.2 TB drive	1.67 hours	5 hours	11.67 hours
4 TB drive	8 hours	24 hours	56 hours
186 GB flash drive	NA	NA	36 minutes

 **See Also:**  
"Exadata Secure Erase"


## 8.2.13 Periodic ILOM Reset

The Integrated Lights Out Manager (ILOM) hang detection module in Management Server (MS) periodically resets the ILOM as a proactive measure. It is done in order to prevent the ILOM from entering an unstable state after running for a long period. The reset interval is 90 days.

Minimum software: Oracle Exadata System Software release 11.2.3.3.0

## 8.2.14 Oracle Exawatcher Replaces Oracle OSwatcher

Starting with this release, Oracle Exawatcher replaces Oracle OSwatcher. Oracle Exawatcher has greater collection and reporting functionality than Oracle OSwatcher.

 **See Also:**  
*Oracle Exadata System Software User's Guide* for information about Oracle Exawatcher

## 8.2.15 Enhancements for Hardware and Software

The following enhancements have been added for the hardware and software:

- Enhancements for Sun Datacenter InfiniBand Switch 36 switches
  - Sun Datacenter InfiniBand Switch 36 switches in Exadata Database Machine are upgraded in a rolling manner using the patchmgr utility. See Understanding Rolling and Non-Rolling Updates for additional information.
  - Switch software release 2.1.3-4 includes the ability to automatically disable intermittent links. The InfiniBand specification stipulates that the bit error rate on a



link must be less than  $10^{12}$ . If the number of symbol errors is greater than 3546 bit errors per day, or 144 bit errors per hour, then the link is disabled. The InfiniBand switch software provides the `autodisable` command, and the `patchmgr` utility automatically enables this feature when the switch is upgraded to release 2.1.3-4.

- The new switch software release 2.1.3-4 can create fat tree topologies with two switches, or with an unbalanced number of links across multiple spine switches in the fabric.
- The amount of time taken to perform a subnet manager failover has been reduced to subseconds even on multi-rack configurations.
- Enhancements for Patch Application
  - The `patchmgr` utility provides the ability to send e-mail messages upon completion of patching, as well as the status of rolling and non-rolling patch application. See `Patchmgr` syntax, and the `patch` set for additional information.
  - Firmware upgrades on database servers for ILOM/BIOS, InfiniBand HCA, and disk controller happen automatically during component replacements on racks running Oracle Linux and Oracle Solaris.
- Enhancements for Hardware Robustness
  - The time to recover from a bad sector on a hard disk has been reduced by 12 times.
  - The failure state of a hard drive or flash drive is rarely Boolean. Most devices slow down considerably before they fail. Slow and intermittent drives are detected much earlier, and failed by Oracle Exadata System Software before the drives reach `predictive failure` or a hard failure state.
  - If the ILOM on a storage server stops responding, then the management software can automatically reset the ILOM.
- Support for Oracle Solaris 11.1 (SRU 9.5.1)

This release supports Oracle Solaris 11.1 SRU 9.5.1 on the database servers.

## 8.3 What's New in Oracle Exadata Database Machine 11g Release 2 (11.2.3.2)

The following are new for Oracle Exadata System Software 11g Release 2 (11.2.3.2):

- [Write-Back Flash Cache with Exadata Smart Flash Cache](#)
- [Graceful Shutdown of CELLSRV Services](#)
- [LED Notification for Storage Server Disk Removal](#)
- [Identification of Underperforming Disks](#)
- [Oracle Database File System Support for Oracle Solaris](#)
- [Health Factor for Predictive Failed Disk Drop](#)
- [Hard Disk Drive Numbering in Servers](#)

## 8.3.1 Write-Back Flash Cache with Exadata Smart Flash Cache

Exadata Smart Flash Cache transparently caches frequently-accessed data to fast solid-state storage, improving query response times and throughput. Write operations serviced by flash instead of by disk are referred to as **write-back flash cache**. Write-back flash cache allows 20 times more write I/Os per second on X3 systems, and 10 times more on X2 systems. The larger flash capacity on X3 systems means that almost all writes are serviced by flash.

An active data block can remain in write-back flash cache for months or years. Blocks that have not been read recently only keep the primary copy in cache. All data is copied to disk, as needed. This provides for smart usage of the premium flash space.

If there is a problem with the flash cache, then the operations transparently fail over to the mirrored copies on flash. No user intervention is required. The data on flash is mirrored based on their allocation units. This means the amount of data written is proportional to the lost cache size, not the disk size.

- [Exadata Smart Flash Cache Persistent After Cell Restart](#)



### See Also:

*Oracle Exadata System Software User's Guide* for additional information about write-back flash cache and write-through flash cache

### 8.3.1.1 Exadata Smart Flash Cache Persistent After Cell Restart

Exadata Smart Flash Cache is persistent through power outages, shutdown operations, cell restarts, and so on. Data in flash cache is not repopulated by reading from the disk after a cell restarts. Write operations from the server go directly to flash cache. This reduces the number of I/O operations on the disks. The caching of data on the flash disks is set by the administrator.

## 8.3.2 Graceful Shutdown of CELLSRV Services

If a cell or disk is offline, and an administrator tries to restart or shut down CELLSRV services, then the administrator gets a message that the cell cannot be shutdown due to reduced redundancy.

## 8.3.3 LED Notification for Storage Server Disk Removal

When a storage server disk needs to be removed, a blue LED light is displayed on the server. The blue light makes it easier to determine which server disk needs maintenance.

## 8.3.4 Identification of Underperforming Disks

Underperforming disks affect the performance of all disks because work is distributed equally to all disks. For example, if a disk is performing 30% slower than other disks, then the entire system's I/O capacity will be 30% lower.

When an underperforming disk is detected, it is removed from the active configuration. Oracle Exadata Database Machine then performs a set of performance tests. If the problem with the

disk is temporary and it passes the tests, then it is brought back into the configuration. If the disk does not pass the tests, then it is marked as poor performance, and an Auto Service Request (ASR) service request is opened to replace the disk. This feature applies to both hard disks and flash disks.

## 8.3.5 Oracle Database File System Support for Oracle Solaris

Oracle Database File System (DBFS) manages unstructured data in an Oracle database. Files in DBFS are stored in the database in SecureFiles and inherit all of its performance, scalability, security, availability and rich functionality benefits, such as compression, deduplication, encryption, text search, and XQuery.

In earlier releases, DBFS was only available for Oracle Exadata Database Machine running Linux. With this release, DBFS is also supported on Oracle Exadata Database Machine running Oracle Solaris.

### See Also:

*Oracle Database SecureFiles and Large Objects Developer's Guide* for additional information about DBFS

## 8.3.6 Health Factor for Predictive Failed Disk Drop

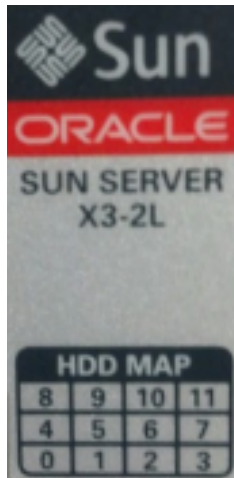
When a hard disk enters predictive failure on Oracle Exadata Storage Server, Oracle Exadata System Software automatically triggers an Oracle Automatic Storage Management (Oracle ASM) rebalance to relocate data from the disk. The Oracle ASM rebalance first reads from healthy mirrors to restore redundancy. If all other mirrors are not available, then Oracle ASM rebalance reads the data from the predictively-failed disk. This diverts rebalance reads away from the predictively-failed disk when possible to ensure optimal rebalance progress while maintaining maximum data redundancy during the rebalance process.

Before the data is completely relocated to other healthy disks in the disk group, Oracle Exadata System Software notifies database instances of the poor health of the predictively-failed disk so that queries and smart scans for data on that disk will be diverted to other mirrors for better response time.

## 8.3.7 Hard Disk Drive Numbering in Servers

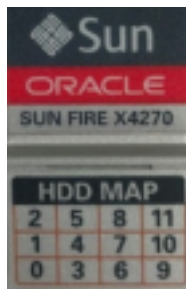
The drives in the Exadata Storage Server X3-2 Servers are numbered from left to right in each row. The drives in the bottom row are numbered 0, 1, 2, and 3. The drives in the middle row are numbered 4, 5, 6, and 7. The drives in the top row are numbered 8, 9, 10, and 11.

**Figure 8-1 Disk Layout in Exadata Storage Server X3-2 Servers**



The drives in the Exadata Storage Server with Sun Fire X4270 M2 Servers and earlier servers were numbered from the lower left to the top, such that the drives in the leftmost column were 0, 1, and 2. The drives in the next column were 3, 4, and 5. The drives in the next column were 6, 7, and 8. The drives in the rightmost column were 9, 10, and 11.

**Figure 8-2 Disk Layout in Exadata Storage Server with Sun Fire X4270 M2 Servers**



## 8.4 What's New in Oracle Exadata Database Machine 11g Release 2 (11.2.3.1)

The following are new for Oracle Exadata System Software 11g Release 2 (11.2.3.1):

- [Support for Oracle Solaris 11 \(SRU2a\)](#)
- [Linux Database Server Updates with Unbreakable Linux Network](#)
- [Oracle Enterprise Manager Cloud Control for Oracle Exadata Database Machine](#)
- [I/O Resource Management Support for More Than 32 Databases](#)
- [Oracle Database 11g Release 2 \(11.2.0.3\)](#)
- [Exadata Cell Connection Limit](#)

## 8.4.1 Support for Oracle Solaris 11 (SRU2a)

This release supports Oracle Solaris 11 (SRU2a) on the database servers.

## 8.4.2 Linux Database Server Updates with Unbreakable Linux Network

Starting with Oracle Exadata Storage Server Software 11g Release 2 (11.2) release 11.2.3.1, the minimal pack is deprecated. The database server update procedure uses the Unbreakable Linux Network (ULN) for the distribution of updates, and the yum utility to apply the updates.



### See Also:

*Oracle Exadata Database Machine Maintenance Guide* for information about updating the database servers

## 8.4.3 Oracle Enterprise Manager Cloud Control for Oracle Exadata Database Machine

Oracle Exadata Database Machine can be managed using Oracle Enterprise Manager Cloud Control. Oracle Enterprise Manager Cloud Control combines management of servers, operating systems, firmware, virtual machines, storage, and network fabrics into a single console.

## 8.4.4 I/O Resource Management Support for More Than 32 Databases

I/O Resource Management (IORM) now supports share-based plans, which can support up to 1024 databases, and up to 1024 directives for interdatabase plans. The share-based plans allocate resources based on shares instead of percentages. A share is a relative distribution of the I/O resources. In addition, the new `default` directive specifies the default value for all databases that are not explicitly named in the database plan.



### See Also:

*Oracle Exadata System Software User's Guide* for information about IORM

## 8.4.5 Oracle Database 11g Release 2 (11.2.0.3)

The Smart Scan in Oracle Exadata System Software 11g Release 2 (11.2) release 11.2.3.*n* is based on the technology present in Oracle Database software 11g Release 2 (11.2) release 11.2.0.3, and is backwards compatible with the 11.2.0.*n* releases of the database.

## 8.4.6 Exadata Cell Connection Limit

Oracle Database, Oracle ASM, Oracle Clusterware and Oracle utilities perform I/O operations on Exadata Cells. In order for a process to perform I/O operations on Exadata Cell, the process must first establish a connection to the cell. Once a process is connected to Exadata Cell, it remains connected until process termination.

With this release, each Exadata Cell can support up to 60,000 simultaneous connections originating from one or more database servers. This implies that no more than 60,000 processes can simultaneously remain connected to a cell and perform I/O operations. The limit was 32,000 connections in release 11.2.2.4. Prior to release 11.2.2.4, the limit was 20,000 connections.

## 8.5 What's New in Oracle Exadata Database Machine 11g Release 2 (11.2.2.4)

The following is new for Oracle Exadata System Software 11g release 2 (11.2.2.4):

- [Oracle Exadata Smart Flash Log](#)

### 8.5.1 Oracle Exadata Smart Flash Log

The time to commit user transactions is very sensitive to the latency of log writes. In addition, many performance-critical database algorithms, such as space management and index splits, are sensitive to log write latency. Oracle Exadata Storage Server Software speeds up log writes using battery-backed DRAM cache in the disk controller. Writes to the disk controller cache are normally very fast, but they can become slow during periods of high disk I/O. Oracle Exadata Smart Flash Log takes advantage of flash memory in Exadata Storage Server to accelerate log writes.

Flash memory has very good average write latency, but it has occasional slow outliers that are one to two orders of magnitude slower than the average. Oracle Exadata Smart Flash Log performs redo writes simultaneously to both flash memory and the disk controller cache, and completes the write when the first of the two completes. This improves the user transaction response time, and increases overall database throughput for I/O intensive workloads.

Oracle Exadata Smart Flash Log only uses Exadata flash storage for temporary storage of redo log data. By default, Oracle Exadata Smart Flash Log uses 32 MB on each flash disk, for a total of 512 MB across each Exadata Cell. It is automatically configured and enabled. No additional configuration is needed.

## 8.6 What's New in Oracle Exadata Database Machine 11g Release 2 (11.2.2.3)

The following are new for Oracle Exadata System Software 11g Release 2 (11.2.2.3):

- [Oracle Solaris Operating System for Database Servers](#)
- [Exadata Secure Erase](#)
- [Optimized Smart Scan](#)

## 8.6.1 Oracle Solaris Operating System for Database Servers

The database servers in Oracle Exadata Database Machine have the Linux operating system and Oracle Solaris operating system. During initial configuration, choose the operating system for your environment. After selecting an operating system, you can reclaim the disk space used by the other operating system.

## 8.6.2 Exadata Secure Erase

Oracle Exadata System Software includes a method to securely erase and clean physical disks before redeployment. The `ERASE` option overwrites the existing content on the disks with one pass, three passes or seven passes. The one pass option overwrites content with zeros. The three pass option follows recommendations from NNSA and the seven pass option follows recommendations from DOD.

The following table shows the approximate times needed to securely erase a drive using the supported algorithms.

Type of Drive	One Pass	Three Pass	Seven Pass
600 GB drive	1 hour	3 hours	7 hours
2 TB drive	5 hours	15 hours	35 hours
3 TB drive	7 hours	21 hours	49 hours
22.875 GB flash drive	NA	NA	21 minutes
93 GB flash drive	NA	NA	32 minutes

### Note:

- Oracle Exadata System Software secure data erase uses multiple overwrites of all accessible data. The over-writes use variations of data characters. This method of data erase is based on commonly known algorithms. Under rare conditions even a 7-pass erase may not remove all traces of data. For example, if a disk has internally remapped sectors, then some data may remain physically on the disk. This data will not be accessible using normal I/O interfaces.
- Using tablespace encryption is another way to secure data.

## 8.6.3 Optimized Smart Scan

Oracle Exadata Storage Server Software detects resource bottlenecks on Exadata Storage Servers by monitoring CPU utilization. When a bottleneck is found, work is relocated to improve performance. Each Exadata Cell maintains the following statistics:

- Exadata Cell CPU usage and push-back rate snapshots for the last 30 minutes.
- Total number of 1MB blocks that had a push-back decision on.
- Number of blocks that have been pushed back to the database servers.

- The statistic `Total cpu passthru output IO size in KB`.

## 8.7 What's New in Oracle Exadata Database Machine 11g Release 2 (11.2.1.2)

The following features are new for Oracle Exadata System Software 11g release 2 (11.2.1.2):

- [Exadata Smart Flash Cache](#)
- [Hybrid Columnar Compression](#)
- [Storage Index](#)
- [Smart Scan of Encrypted Data](#)
- [Interleaved Grid Disks](#)
- [Data Mining Scoring Offload](#)
- [Enhanced Manageability Features](#)

### 8.7.1 Exadata Smart Flash Cache

Exadata Smart Flash Cache provides a caching mechanism for frequently-accessed data on each Exadata Cell. It is a write-through cache which is useful for absorbing repeated random reads, and very beneficial to online transaction processing (OLTP). It provides a mechanism to cache data in `KEEP` mode using database-side storage clause hints at a table or index level. The Exadata Smart Flash Cache area on flash disks is automatically created on Exadata Cells during start up.

Oracle Exadata Storage Servers are equipped with high-performance flash disks in addition to traditional rotational hard disks. These high-performance flash disks can be used to create Exadata grid disks to store frequently accessed data. It requires the user to do accurate space planning, and to place the most active tablespaces on the premium disks. The recommended option is to dedicate all or part of flash disk space for Exadata Smart Flash Cache. In this case, the most frequently-accessed data on the spinning disks are automatically cached in the Exadata Smart Flash Cache area on high-performance flash disks. When the database needs to access this data Oracle Exadata Storage Server fetches the data from Exadata Smart Flash Cache instead of getting it from slower rotational disks.

When a partition or a table is scanned by the database, Exadata Storage Server can fetch the data being scanned from the Exadata Smart Flash Cache if the object has the `CELL_FLASH_CACHE` attribute set. In addition to serving data from the Exadata Flash Cache, Exadata Storage Server also has the capability to fetch the object being scanned from hard disks.

The performance delivered by Exadata Storage Server is additive when it fetches scanned data from the Exadata Smart Flash Cache and hard disks. Exadata Storage Server has the ability to utilize the maximum Exadata Smart Flash Cache bandwidth and the maximum hard disk bandwidth to scan an object, and give an additive maximum bandwidth while scanning concurrently from both.

Oracle Database and Exadata Smart Flash Cache software work closely with each other. When the database sends a read or write request to Oracle Exadata Storage Server, it includes additional information in the request about whether the data is likely to be accessed again, and should be cached. For example, when writing data to a log file or to a mirrored copy, the database sends a hint to skip caching. When reading a table index, the database



sends a hint to cache the data. This cooperation allows optimized usage of Exadata Smart Flash Cache space to store only the most frequently-accessed data.

Users have additional control over which database objects, such as tablespace, tables, and so on, should be cached more aggressively than others, and which ones should not be cached at all. Control is provided by the new storage clause attribute, `CELL_FLASH_CACHE`, which can be assigned to a database object.

For example, to pin table `CALLDETAIL` in Exadata Smart Flash Cache one can use the following command:

```
ALTER TABLE calldetail STORAGE (CELL_FLASH_CACHE KEEP)
```

Exadata Storage Server caches data for the `CALLDETAIL` table more aggressively and tries to keep this data in Exadata Smart Flash Cache longer than cached data for other tables. If the `CALLDETAIL` table is spread across several Oracle Exadata Storage Servers, then each one caches its part of the table in its own Exadata Smart Flash Cache. If caches are sufficient size, then `CALLDETAIL` table is likely to be completely cached over time.

## 8.7.2 Hybrid Columnar Compression

Exadata Hybrid Columnar Compression offers higher compression levels for direct path loaded data. This new compression capability is recommended for data that is not updated frequently. You can specify Hybrid Columnar Compression at the partition, table, and tablespace level. You can also specify the desired level of compression, to achieve the proper trade-off between disk usage and CPU overhead. Included is a compression advisor that helps you determine the proper compression levels for your application.

This feature allows the database to reduce the number of I/Os to scan a table. For example, if you compress data 10 to 1, then the I/Os are reduced 10 to 1 as well. In addition, Hybrid Columnar Compression saves disk space by the same amount.

This feature also allows the database to offload Smart Scans for a column-compressed table to Oracle Exadata Storage Servers. When a scan is done on a compressed table, Oracle Exadata Storage Server reads the compressed blocks from the disks for the scan. Oracle Exadata System Software then decompresses the referenced columns, does predicate evaluation of the data, and applies the filter. The storage server then sends back qualifying data in an uncompressed format. Without this offload, data decompression would take place on the database server. Having Oracle Exadata Storage Server decompress the data results in significant CPU savings on the database server.



### See Also:

*Oracle Exadata System Software User's Guide* for information about Hybrid Columnar Compression

## 8.7.3 Storage Index

Storage indexes are a very powerful capability provided in Oracle Exadata System Software that help avoid I/O operations. Oracle Exadata System Software creates and maintains a storage index in Exadata memory. The storage index keeps track of minimum and maximum values of columns per storage region for tables stored on that cell. This functionality is done transparently, and does not require any administration by the user.

When a query specifies a `WHERE` clause, Oracle Exadata System Software examines the storage index to determine if rows with the specified column value does not exist in a region of disk in the cell by comparing the column value to the minimum and maximum values maintained in the storage index. If the column value is outside the minimum and maximum range, then scan I/O in that region for that query is avoided. Many SQL operations run dramatically faster because large numbers of I/O operations are automatically replaced by a few in-memory lookups. To minimize operational overhead, storage indexes are created and maintained transparently and automatically by Oracle Exadata System Software.

Storage indexes provide benefits for encrypted tablespaces. However, storage indexes do not maintain minimum and maximum values for encrypted columns.

## 8.7.4 Smart Scan of Encrypted Data

Oracle Exadata System Software offloads decryption, and performs Smart Scans on encrypted tablespaces and encrypted columns. While the earlier release of Oracle Exadata System Software fully supported encrypted tablespaces and encrypted columns, it did not benefit from Exadata offload processing. For encrypted tablespaces, Oracle Exadata System Software can decrypt blocks and return the decrypted blocks to the Oracle Database, or it can perform smart scan which returns rows and columns. When Oracle Exadata System Software performs the decryption instead of the database there is significant CPU savings because CPU usage is offloaded to Exadata Cells.

## 8.7.5 Interleaved Grid Disks

**This feature is deprecated in Oracle Exadata System Software release 19.1.0.**

Space for grid disks can be allocated in an interleaved manner. Grid disks that use this type of space allocation are referred to as interleaved grid disks. This method attempts to equalize the performance of the grid disks residing on the same cell disk rather than having the grid disks that occupy the outer tracks getting better performance at the expense of the grid disks on the inner tracks.

A cell disk is divided into two equal parts, the outer half (upper portion) and the inner half (lower portion). When a new grid disk is created, half of the grid disk space is allocated on the outer half of the cell disk, and the other half of the grid disk space is allocated the inner half of the cell disk. The upper portion of the grid disk starts on the first available outermost offset in the outer half depending on free or used space in the outer half. The lower portion of the grid disk starts on the first available outermost offset in the inner half.

For example, if cell disk, `CD_01_cell101` is completely empty and has 100 GB of space, and a grid disk, `data_CD_01_cell101`, is created and sized to 50 GB on the cell disk, then the cell disk would have the following layout:

- Outer portion of `data_CD_01_cell101` - 25GB
- Free space - 25GB

```
----- Middle Point -----  
- Inner portion of data_CD_cell101 - 25GB  
- Free space - 25GB
```

**See Also:**

*Oracle Exadata System Software User's Guide* for information about grid disks

## 8.7.6 Data Mining Scoring Offload

Oracle Exadata System Software now offloads data mining model scoring. This makes the deployment of your data warehouse on Oracle Exadata Storage Servers a better and more performant data analysis platform. All data mining scoring functions, such as `PREDICTION_PROBABILITY`, are offloaded to Oracle Exadata Storage Servers for processing. This accelerates warehouse analysis while it reduces database server CPU consumption and the I/O load between the Oracle Exadata Database Server and Oracle Exadata Storage Server.

## 8.7.7 Enhanced Manageability Features

Oracle Exadata Storage Server Software now includes the following manageability features:

- Automatic addition of replacement disk to the disk group: All the required Exadata operations to re-create the disk groups, and add the grid disks back to the original disk group are now performed automatically when a replacement disk is inserted after a physical disk failure.
- Automatic cell restart: Grid disks are automatically changed to online when a cell recovers from a failure, or after a restart.
- Support for OCR and voting disks on ASM disk groups: In Oracle Database 11g Release 2 (11.2), Oracle Cluster Registry (OCR) and voting disks are supported on ASM disk groups, and the iSCSI partitions are no longer needed.
- Support for up to four dual-port InfiniBand Host Channel Adapters in the database server. This feature enables larger Oracle Exadata Database Machine X2-8 Full Rack servers to be used as database servers using Oracle Exadata Storage Server Software.

## 8.8 What's New in Oracle Exadata Database Machine 11g Release 2 (11.2)

The following is new for Oracle Exadata System Software 11g Release 2 (11.2):

- [Expanded Content in the Guide](#)

## 8.8.1 Expanded Content in the Guide

This release of *Oracle Exadata Database Machine System Overview* includes maintenance procedures, cabling information, site planning checklists, and so on. This guide is the main reference book for Oracle Exadata Database Machine.

# Part II

## Hardware Components

The Exadata Database Machine comes in many different configurations and has several different components.

- [Hardware Components of Exadata Database Machine](#)  
Exadata Database Machine consists of database servers, storage servers, and the network components to connect to your network.
- [Hardware Components of the Exadata Storage Expansion Rack](#)  
Oracle Exadata Storage Expansion Rack provides additional storage for Exadata Database Machine.

# 9

## Hardware Components of Exadata Database Machine

Exadata Database Machine consists of database servers, storage servers, and the network components to connect to your network.

Exadata Database Machine is available in flexible configurations that consist of a number of database and storage servers up to the capacity of the rack as defined using OECA. Exadata Database Machine is also available in specific configurations, such as a full rack, half rack, quarter rack or eighth rack.

- [Exadata Database Machine Hardware Components by Model](#)  
These tables list the components included for each type of Exadata Database Machine model and configuration.
- [Oracle Exadata Database Server Hardware Components](#)  
Each Oracle Exadata Database Machine contains multiple database servers.
- [Oracle Exadata Storage Server Hardware Components](#)  
Each Oracle Exadata Database Machine contains multiple storage servers.
- [Spares Kit Components for Oracle Exadata Database Machine](#)  
Oracle Exadata Database Machines include a spares kit.

### 9.1 Exadata Database Machine Hardware Components by Model

These tables list the components included for each type of Exadata Database Machine model and configuration.

In the following tables, for raw capacity, 1 GB = 1 billion bytes. Capacity is calculated using normal space terminology of 1 TB = 1024 \* 1024 \* 1024 \* 1024 bytes. Actual formatted capacity is less.

Oracle Exadata Storage Server variants are abbreviated as follows:

- HC - High Capacity
- EF - Extreme Flash
- XT - Extended

The following table describes the flexible configurations for X6-2 and later systems.

Table 9-1 Exadata Database Machine Flexible Configurations

Model	Base Configuration	Flexible Configurations	Exadata Database Machine Eighth Rack
Exadata Database Machine X9M-2	<ul style="list-style-type: none"> <li>• 2 Exadata X9M-2 database servers</li> <li>• 3 Exadata X9M-2 storage servers</li> <li>• 2 RoCE Network Fabric Switches</li> <li>• 2 redundant PDUs (single phase or three phase, high voltage or low voltage)</li> <li>• 1 Management Network Switch</li> <li>• Raw flash capacity: 153.6 TB for EF, or 76.8 TB for HC</li> <li>• Raw hard disk capacity: 648 TB for HC</li> <li>• Persistent memory capacity: 4.5 TB</li> </ul>	<ul style="list-style-type: none"> <li>• Maximum of 22 servers (database and storage) in a rack</li> <li>• Minimum of 2 database servers, maximum of 19 database servers</li> <li>• Minimum of 3 HC or EF storage servers, can add 2 or more XT servers or additional HC or EF storage servers for a maximum of 18 storage servers</li> <li>• An extra RoCE Network Fabric Switch can be installed for combining racks.</li> <li>• An extra network card can be installed if you require additional connectivity for client networks, or for a separate network.</li> <li>• A memory expansion kit can be installed to increase memory capacity for the database servers. Memory expansion kit is not available for the storage servers.</li> <li>• A disk expansion kit can be used to upgrade disk storage of the database server, which increases the usable disk capacity of the database server, for use by Oracle Homes or other local disk requirements.</li> </ul>	<ul style="list-style-type: none"> <li>• 2 Exadata X9M-2 database servers. Each server has 1 x 32-core processor with all 32 cores enabled</li> <li>• 3 Exadata X9M-2 storage servers. Each server has 2 x 16-core processors and contains the following storage: <ul style="list-style-type: none"> <li>– 6 x 18 TB 7,200 RPM high capacity disks.</li> <li>– 2 PCI flash cards, each with 6.4 TB of raw flash storage.</li> <li>– 768 GB of persistent memory</li> </ul> </li> <li>• Expand the storage by: <ul style="list-style-type: none"> <li>– Adding one or more X9M-2 eighth (1/8) rack storage server(s) to the existing disk group. Licenses required.</li> <li>– Or, by adding a minimum of three X9M storage servers (eighth or fully populated) for a new disk group.</li> </ul> </li> <li>• 2 RoCE Network Fabric Switches</li> <li>• 2 redundant PDUs (1-phase or 3-phase, high voltage or low voltage)</li> <li>• 1 Management Network Switch</li> <li>• Raw flash capacity: 38.4 TB</li> <li>• Raw hard disk capacity: 324 TB</li> <li>• Persistent memory capacity: 2.3 TB</li> </ul>

Table 9-1 (Cont.) Exadata Database Machine Flexible Configurations

Model	Base Configuration	Flexible Configurations	Exadata Database Machine Eighth Rack
Exadata Database Machine X8M-2	<ul style="list-style-type: none"> <li>• 2 Exadata X8M-2 database servers</li> <li>• 3 Exadata X8M-2 storage servers</li> <li>• 2 RoCE Network Fabric Switches</li> <li>• 2 redundant PDUs (single phase or three phase, high voltage or low voltage)</li> <li>• 1 Management Network Switch</li> <li>• Raw flash capacity: 153.6 TB for EF, or 76.8 TB for HC</li> <li>• Raw hard disk capacity: 504 TB for HC</li> </ul>	<ul style="list-style-type: none"> <li>• Maximum of 22 servers (database and storage) in a rack</li> <li>• Minimum of 2 database servers, maximum of 19 database servers</li> <li>• Minimum of 3 HC or EF storage servers, can add 2 or more XT servers or additional HC or EF storage servers for a maximum of 18 storage servers</li> <li>• An extra RoCE Network Fabric Switch can be installed for combining racks.</li> <li>• An extra network card can be installed if you require additional connectivity for client networks, or for a separate network.</li> <li>• A memory expansion kit can be installed to increase memory capacity for the database servers. Memory expansion kit is not available for the storage servers.</li> <li>• A disk expansion kit can be used to upgrade disk storage of the database server, which increases the usable disk capacity of the database server, for use by Oracle Homes or other local disk requirements.</li> </ul>	<ul style="list-style-type: none"> <li>• 2 Exadata X8M-2 database servers. Each server has 1x 24-core processor with all 24-cores enabled</li> <li>• 3 Exadata X8M-2 storage servers. Each server has 2 x 16-core processors, each with 8 cores enabled. <ul style="list-style-type: none"> <li>– HC storage servers have 2 PCI flash cards, each with 6.4 TB (raw) Smart Flash Cache and 6 x 14 TB 7,200 RPM high capacity disks.</li> <li>– EF storage servers have 4 PCI flash cards, each with 6.4 TB (raw) storage.</li> </ul> </li> <li>• Expand the storage by: <ul style="list-style-type: none"> <li>– Adding one or more X8M-2 eighth (1/8) rack storage server(s) to the existing disk group. Licenses required.</li> <li>– Or, by adding a minimum of three X8M storage servers (eighth or fully populated) for a new disk group.</li> </ul> </li> <li>• 2 RoCE Network Fabric Switches</li> <li>• 2 redundant PDUs (1-phase or 3-phase, high voltage or low voltage)</li> <li>• 1 Management Network Switch</li> <li>• Raw flash capacity: 76.8 TB for EF, or 38.4 TB for HC</li> <li>• Raw hard disk capacity: 180 TB for HC disks</li> </ul>



Table 9-1 (Cont.) Exadata Database Machine Flexible Configurations

Model	Base Configuration	Flexible Configurations	Exadata Database Machine Eighth Rack
Exadata Database Machine X8-2	<ul style="list-style-type: none"> <li>• 2 Exadata X8-2 database servers</li> <li>• 3 Exadata X8-2 storage servers</li> <li>• 2 Sun Datacenter InfiniBand Switch 36</li> <li>• 2 redundant PDUs (single phase or three phase, high voltage or low voltage)</li> <li>• 1 48-port Cisco Nexus 9348 Ethernet switch</li> <li>• Raw flash capacity: 153.6 TB for EF, or 76.8 TB for HC</li> <li>• Raw hard disk capacity: 504 TB for HC</li> </ul>	<ul style="list-style-type: none"> <li>• Maximum of 22 servers (database and storage) in a rack</li> <li>• Minimum of 2 database servers, maximum of 19 database servers</li> <li>• Minimum of 3 HC or EF storage servers, can add 2 or more XT servers or additional HC or EF storage servers for a maximum of 18 storage servers</li> <li>• An extra InfiniBand leaf switch can be installed for combining racks.</li> <li>• An extra network card can be installed if you require additional connectivity for client networks, or for a separate network.</li> <li>• A memory expansion kit can be installed to increase memory capacity for the database or storage servers. Memory expansion kit is not available for the XT storage servers.</li> <li>• A disk expansion kit can be used to upgrade disk storage of the database server, which increases the usable disk capacity of the database server, for use by Oracle Homes or other local disk requirements.</li> </ul>	<ul style="list-style-type: none"> <li>• 2 Exadata X8-2 database servers. Each server has 1x 24-core processor with all 24-cores enabled</li> <li>• 3 Exadata X8-2 storage servers. Each server has 2 x 16-core processors, each with 8 cores enabled. <ul style="list-style-type: none"> <li>– HC storage servers have 2 PCI flash cards, each with 6.4 TB (raw) Smart Flash Cache and 6 x 14 TB 7,200 RPM high capacity disks.</li> <li>– EF storage servers have 4 PCI flash cards, each with 6.4 TB (raw) storage.</li> </ul> </li> <li>• 2 Sun Datacenter InfiniBand Switch 36 switches</li> <li>• 2 redundant PDUs (1-phase or 3-phase, high voltage or low voltage)</li> <li>• 1 48-port Cisco Nexus 9348 Ethernet switch</li> <li>• Raw flash capacity: 76.8 TB for EF, or 38.4 TB for HC</li> <li>• Raw hard disk capacity: 180 TB for HC disks</li> </ul>

Table 9-1 (Cont.) Exadata Database Machine Flexible Configurations

Model	Base Configuration	Flexible Configurations	Exadata Database Machine Eighth Rack
Exadata Database Machine X7-2	<ul style="list-style-type: none"> <li>• 2 Exadata X7-2 database servers</li> <li>• 3 Exadata X7-2 storage servers</li> <li>• 2 Sun Datacenter InfiniBand Switch 36</li> <li>• 2 redundant PDUs (single phase or three phase, high voltage or low voltage)</li> <li>• 1 48-port Cisco Nexus 93108-1G or 9348 Ethernet switch</li> <li>• Raw flash capacity: 153.6 TB for EF, or 76.8 TB for HC</li> <li>• Raw hard disk capacity: 360 TB for HC</li> </ul>	<ul style="list-style-type: none"> <li>• Maximum of 22 servers (database and storage) in a rack</li> <li>• Minimum of 2 database servers, maximum of 19 database servers</li> <li>• Minimum of 3 HC or EF storage servers, maximum of 18 storage servers</li> <li>• An extra InfiniBand leaf switch can be installed for combining racks.</li> <li>• An extra network card can be installed if you require additional connectivity for client networks, or for a separate network.</li> <li>• A memory expansion kit can be installed to increase memory capacity for the database or storage servers.</li> <li>• A disk expansion kit can be used to upgrade disk storage of the database server, which increases the usable disk capacity of the database server, for use by Oracle Homes or other local disk requirements.</li> </ul>	<ul style="list-style-type: none"> <li>• 2 database servers. Each server has 1x 24-core processor with all 24-cores enabled</li> <li>• 3 Exadata X7-2 storage servers. Each server has 2 x 10-core processors, each with 5 cores enabled <ul style="list-style-type: none"> <li>– High Capacity (HC) storage servers have 2 PCI flash cards, each with 6.4 TB (raw) Smart Flash Cache and 6 x 10 TB 7,200 RPM high capacity disks.</li> <li>– EF storage servers have 4 PCI flash drives, each with 3.2 TB (raw) storage.</li> </ul> </li> <li>• 2 Sun Datacenter InfiniBand Switch 36 switches</li> <li>• 2 redundant PDUs (1-phase or 3-phase, high voltage or low voltage)</li> <li>• 1 48-port Cisco Nexus 93108-1G or 9348 Ethernet switch</li> <li>• Raw flash capacity: 76.8 TB for EF, or 38.4 TB for HC</li> <li>• Raw hard disk capacity: 180 TB for HC disks</li> </ul>

Table 9-1 (Cont.) Exadata Database Machine Flexible Configurations

Model	Base Configuration	Flexible Configurations	Exadata Database Machine Eighth Rack
Exadata Database Machine X6-2	<ul style="list-style-type: none"> <li>• 2 Exadata X6-2 database servers</li> <li>• 3 Exadata X6-2 storage servers</li> <li>• 2 Sun Datacenter InfiniBand Switch 36 switches</li> <li>• 2 redundant PDUs (single phase or three phase, high voltage or low voltage)</li> <li>• 1 48-port Cisco Catalyst 4948E-F, model number WS-C4948E-F-S Ethernet switch</li> <li>• Raw flash capacity: 76.8 TB for EF, or 38.4 TB for HC</li> <li>• Raw hard disk capacity: 288 TB for HC</li> </ul>	<ul style="list-style-type: none"> <li>• Maximum of 22 servers (database and storage) in a rack</li> <li>• Minimum of 2 database servers, maximum of 19 database servers</li> <li>• Minimum of 3 HC or EF storage servers, maximum of 18 storage servers</li> <li>• An extra InfiniBand leaf switch can be installed for combining racks.</li> <li>• An extra network card can be installed if you require additional connectivity for client networks, or for a separate network.</li> <li>• A memory expansion kit can be installed to increase memory capacity for the database or storage servers.</li> <li>• A disk expansion kit can be used to upgrade disk storage of the database server, which increases the usable disk capacity of the database server, for use by Oracle Homes or other local disk requirements.</li> </ul>	<ul style="list-style-type: none"> <li>• 2 database servers. Each server has 2x 22-core processors, each with 11-cores enabled</li> <li>• 3 Exadata X6-2 storage servers. Each server has 2 x 10-core processors, each with 5 cores enabled. <ul style="list-style-type: none"> <li>– High Capacity (HC) storage servers have 2 PCI flash cards, each with 3.2 TB (raw) Smart Flash Cache and 6 x 8 TB 7,200 RPM high capacity disks.</li> <li>– EF storage servers have 4 enabled PCI flash drives, each with 3.2 TB (raw) storage.</li> </ul> </li> <li>• 2 Sun Datacenter InfiniBand Switch 36 switches</li> <li>• 2 redundant PDUs (1-phase or 3- phase, high voltage or low voltage)</li> <li>• 1 48-port Cisco Catalyst 4948E-F, model number WS-C4948E-F-S Ethernet switch</li> <li>• Raw flash capacity: 38.4 TB for EF, or 19.2 TB for HC</li> <li>• Raw hard disk capacity: 144 TB for HC disks</li> </ul>

The following table describes the fixed configurations (Full Rack, Half Rack, Quarter Rack, and Eighth Rack) for Exadata Database Machine.

**Table 9-2 Components of Exadata Database Machines in Fixed Configurations**

Edition	Exadata Database Machine Full Rack	Exadata Database Machine Half Rack	Exadata Database Machine Quarter Rack	Exadata Database Machine Eighth Rack
Exadata Database Machine X9M-2	Not applicable	Not applicable	Not applicable	<ul style="list-style-type: none"> <li>• 2 Exadata X9M-2 database servers. Each server has 1 x 32-core processor with all 32 cores enabled</li> <li>• 3 Exadata X9M-2 storage servers. Each server has 2 x 16-core processors and contains the following storage:               <ul style="list-style-type: none"> <li>– 6 x 18 TB 7,200 RPM high capacity disks.</li> <li>– 2 PCI flash cards, each with 6.4 TB of raw flash storage.</li> <li>– 768 GB of persistent memory</li> </ul> </li> <li>• 2 RoCE Network Fabric Switches</li> <li>• 2 redundant PDUs (1- phase or 3- phase, high voltage or low voltage)</li> <li>• 1 Management Network Switch</li> <li>• Raw flash capacity: 38.4 TB</li> <li>• Raw hard disk capacity: 324 TB</li> <li>• Persistent memory capacity: 2.3 TB</li> </ul>

Table 9-2 (Cont.) Components of Exadata Database Machines in Fixed Configurations

Edition	Exadata Database Machine Full Rack	Exadata Database Machine Half Rack	Exadata Database Machine Quarter Rack	Exadata Database Machine Eighth Rack
Exadata Database Machine X9M-8	<ul style="list-style-type: none"> <li>• 2 Exadata X9M-8 database servers. An additional database server can be added.</li> <li>• 14 Exadata X9M-2 storage servers, either High Capacity or Extreme Flash</li> <li>• 2 RoCE Network Fabric Switches</li> <li>• 2 redundant PDUs (single phase or three phase, high voltage or low voltage)</li> <li>• 1 Management Network Switch</li> <li>• Raw flash capacity: 716.8 TB for EF, or 358.4 TB for HC</li> <li>• Raw hard disk capacity: 3024 TB for HC</li> <li>• Persistent memory capacity: 21 TB</li> </ul>	<ul style="list-style-type: none"> <li>• 2 Exadata X9M-8 database servers. An additional database server can be added.</li> <li>• 3 Exadata X9M-2 storage servers, either High Capacity or Extreme Flash</li> <li>• 2 RoCE Network Fabric Switches. An extra switch can be installed for combining racks.</li> <li>• 2 redundant PDUs (single phase or three phase, high voltage or low voltage)</li> <li>• 1 Management Network Switch</li> <li>• Raw flash capacity: 153.6 TB for EF, or 76.8 TB for HC</li> <li>• Raw hard disk capacity: 648 TB for HC</li> <li>• Persistent memory capacity: 4.5 TB</li> </ul>	Not applicable	Not applicable

**Table 9-2 (Cont.) Components of Exadata Database Machines in Fixed Configurations**

Edition	Exadata Database Machine Full Rack	Exadata Database Machine Half Rack	Exadata Database Machine Quarter Rack	Exadata Database Machine Eighth Rack
Exadata Database Machine X8M-2	Not applicable	Not applicable	Not applicable	<ul style="list-style-type: none"> <li>• 2 Exadata X8M-2 database servers. Each server has 1x 24-core processor with all 24-cores enabled.</li> <li>• 3 Exadata X8M-2 storage servers, either High Capacity or Extreme Flash. Each server has 2 x 16-core processors, each with 8 cores enabled.               <ul style="list-style-type: none"> <li>– High Capacity (HC) storage servers have 2 PCI flash cards, each with 6.4 TB (raw) Smart Flash Cache and 6 x 14 TB 7,200 RPM high capacity disks.</li> <li>– EF storage servers have 4 PCI flash cards, each with 6.4 TB (raw) storage.</li> </ul> </li> <li>• 2 RoCE Network Fabric Switches</li> <li>• 2 redundant PDUs (single phase or three phase, high voltage or low voltage)</li> <li>• 1 Management Network Switch</li> <li>• Raw flash capacity: 76.8</li> </ul>

Table 9-2 (Cont.) Components of Exadata Database Machines in Fixed Configurations

Edition	Exadata Database Machine Full Rack	Exadata Database Machine Half Rack	Exadata Database Machine Quarter Rack	Exadata Database Machine Eighth Rack
				TB for EF, or 38.4 TB for HC <ul style="list-style-type: none"> <li>• Raw hard disk capacity: 180 TB for HC</li> </ul>
Exadata Database Machine X8M-8	<ul style="list-style-type: none"> <li>• 2 Exadata X8M-8 database servers. An additional database server can be added.</li> <li>• 14 Exadata X8M-2 storage servers, either High Capacity or Extreme Flash</li> <li>• 2 RoCE Network Fabric Switches</li> <li>• 2 redundant PDUs (single phase or three phase, high voltage or low voltage)</li> <li>• 1 Management Network Switch</li> <li>• Raw flash capacity: 716.8 TB for EF, or 358.4 TB for HC</li> <li>• Raw hard disk capacity: 2352 TB for HC</li> </ul>	<ul style="list-style-type: none"> <li>• 2 Exadata X8M-8 database servers. An additional database server can be added.</li> <li>• 3 Exadata X8M-2 storage servers, either High Capacity or Extreme Flash</li> <li>• 2 RoCE Network Fabric Switches. An extra switch can be installed for combining racks.</li> <li>• 2 redundant PDUs (single phase or three phase, high voltage or low voltage)</li> <li>• 1 Management Network Switch</li> <li>• Raw flash capacity: 153.3 TB for EF, or 76.8 TB for HC</li> <li>• Raw hard disk capacity: 504 TB for HC</li> </ul>	Not applicable	Not applicable

**Table 9-2 (Cont.) Components of Exadata Database Machines in Fixed Configurations**

Edition	Exadata Database Machine Full Rack	Exadata Database Machine Half Rack	Exadata Database Machine Quarter Rack	Exadata Database Machine Eighth Rack
Exadata Database Machine X8-2	Not applicable	Not applicable	Not applicable	<ul style="list-style-type: none"> <li>• 2 Exadata X8-2 database servers. Each server has 1x 24-core processor with all 24-cores enabled.</li> <li>• 3 Exadata X8-2 storage servers, either High Capacity or Extreme Flash. Each server has 2 x 16-core processors, each with 8 cores enabled.               <ul style="list-style-type: none"> <li>– High Capacity (HC) storage servers have 2 PCI flash cards, each with 6.4 TB (raw) Smart Flash Cache and 6 x 14 TB 7,200 RPM high capacity disks.</li> <li>– EF storage servers have 4 PCI flash cards, each with 6.4 TB (raw) storage.</li> </ul> </li> <li>• 2 Sun Datacenter InfiniBand Switch 36 switches</li> <li>• 2 redundant PDUs (single phase or three phase, high voltage or low voltage)</li> </ul>



Table 9-2 (Cont.) Components of Exadata Database Machines in Fixed Configurations

Edition	Exadata Database Machine Full Rack	Exadata Database Machine Half Rack	Exadata Database Machine Quarter Rack	Exadata Database Machine Eighth Rack
				<ul style="list-style-type: none"> <li>• 1 48-port Cisco Nexus 9348 Ethernet switch.</li> <li>• Raw flash capacity: 76.8 TB for EF, or 38.4 TB for HC</li> <li>• Raw hard disk capacity: 180 TB for HC</li> </ul>
Exadata Database Machine X8-8	<ul style="list-style-type: none"> <li>• 2 Exadata X8-8 database servers. An additional database server can be added.</li> <li>• 14 Exadata X8-2 storage servers, either High Capacity or Extreme Flash</li> <li>• 2 Sun Datacenter InfiniBand Switch 36 switches.</li> <li>• 2 redundant PDUs (single phase or three phase, high voltage or low voltage)</li> <li>• 1 48-port Cisco Nexus 9348 Ethernet switch.</li> <li>• Raw flash capacity: 716.8 TB for EF, or 358.4 TB for HC</li> <li>• Raw hard disk capacity: 2352 TB for HC</li> </ul>	<ul style="list-style-type: none"> <li>• 2 Exadata X8-8 database servers. An additional database server can be added.</li> <li>• 3 Exadata X8-2 storage servers, either High Capacity or Extreme Flash</li> <li>• 2 Sun Datacenter InfiniBand Switch 36 switches. An extra InfiniBand leaf switch can be installed for combining racks.</li> <li>• 2 redundant PDUs (single phase or three phase, high voltage or low voltage)</li> <li>• 1 48-port Cisco Nexus 9348 Ethernet switch</li> <li>• Raw flash capacity: 716.8 TB for EF, or 358.4 TB for HC</li> <li>• Raw hard disk capacity: 2352 TB for HC</li> </ul>	Not applicable	Not applicable

Table 9-2 (Cont.) Components of Exadata Database Machines in Fixed Configurations

Edition	Exadata Database Machine Full Rack	Exadata Database Machine Half Rack	Exadata Database Machine Quarter Rack	Exadata Database Machine Eighth Rack
Exadata Database Machine X7-2	<ul style="list-style-type: none"> <li>• 8 database servers</li> <li>• 14 Exadata X7-2 storage servers</li> <li>• 2 Sun Datacenter InfiniBand Switch 36 switches</li> <li>• 2 redundant PDUs (single phase or three phase, high voltage or low voltage)</li> <li>• 1 48-port Cisco Nexus 93108-1G or 9348 Ethernet switch</li> <li>• Raw flash capacity: 716.8 TB for EF, or 358.4 TB for HC</li> <li>• Raw hard disk capacity: 1680 TB for HC</li> </ul>	<ul style="list-style-type: none"> <li>• 4 database servers</li> <li>• 7 Exadata X7-2 storage servers</li> <li>• 2 Sun Datacenter InfiniBand Switch 36 switches</li> <li>• 2 redundant PDUs (single phase or three phase, high voltage or low voltage)</li> <li>• 1 48-port Cisco Nexus 93108-1G or 9348 Ethernet switch</li> <li>• Raw flash capacity: 358.4 TB for EF, or 179.2 TB for HC</li> <li>• Raw hard disk capacity: 840 TB for HC</li> </ul>	<ul style="list-style-type: none"> <li>• 2 database servers</li> <li>• 3 Exadata X7-2 storage servers</li> <li>• 2 Sun Datacenter InfiniBand Switch 36 switches</li> <li>• 2 redundant PDUs (single phase or three phase, high voltage or low voltage)</li> <li>• 1 48-port Cisco Nexus 93108-1G or 9348 Ethernet switch</li> <li>• Raw flash capacity: 153.6 TB for EF, or 76.8 TB for HC</li> <li>• Raw hard disk capacity: 360 TB for HC</li> </ul>	<ul style="list-style-type: none"> <li>• 2 database servers. Each server has 1x 24-core processor with all 24-cores enabled.</li> <li>• 3 Exadata X7-2 storage servers, either High Capacity or Extreme Flash. Each server has 2 x 10-core processors, each with 5 cores enabled. <ul style="list-style-type: none"> <li>– High Capacity (HC) storage servers have 2 PCI flash cards, each with 6.4 TB (raw) Smart Flash Cache and 6 x 10 TB 7,200 RPM high capacity disks.</li> <li>– EF storage servers have 8 PCI flash cards, 4 enabled, each with 3.2 TB (raw) storage.</li> </ul> </li> <li>• 2 Sun Datacenter InfiniBand Switch 36 switches</li> <li>• 2 redundant PDUs (single phase or three phase, high voltage or low voltage)</li> </ul>

Table 9-2 (Cont.) Components of Exadata Database Machines in Fixed Configurations

Edition	Exadata Database Machine Full Rack	Exadata Database Machine Half Rack	Exadata Database Machine Quarter Rack	Exadata Database Machine Eighth Rack
				<ul style="list-style-type: none"> <li>• 1x 48-port Cisco Nexus 93108-1G or 9348 Ethernet switch</li> <li>• Raw flash capacity: 76.8 TB for EF, or 38.4 TB for HC</li> <li>• Raw hard disk capacity: 180 TB for HC</li> </ul>
Exadata Database Machine X7-8	<ul style="list-style-type: none"> <li>• 2 database servers</li> <li>• 14 Exadata X7-2 storage servers</li> <li>• 2 Sun Datacenter InfiniBand Switch 36 switches</li> <li>• 2 redundant PDUs (single phase or three phase, high voltage or low voltage)</li> <li>• 1 48-port Cisco Nexus 93108-1G or 9348 Ethernet switch</li> <li>• Raw flash capacity: 716.8 TB for EF, or 358.4 TB for HC</li> <li>• Raw hard disk capacity: 1680 TB for HC</li> </ul>	Not applicable	Not applicable	Not applicable

Table 9-2 (Cont.) Components of Exadata Database Machines in Fixed Configurations

Edition	Exadata Database Machine Full Rack	Exadata Database Machine Half Rack	Exadata Database Machine Quarter Rack	Exadata Database Machine Eighth Rack
Exadata Database Machine X6-2	<ul style="list-style-type: none"> <li>• 8 database servers</li> <li>• 14 Exadata X6-2 storage servers</li> <li>• 2 Sun Datacenter InfiniBand Switch 36 switches</li> <li>• 2 redundant PDUs (single phase or three phase, high voltage or low voltage)</li> <li>• 1 48-port Cisco Catalyst 4948E-F, model number WS-C4948E-F-S Ethernet switch</li> <li>• Raw flash capacity: 358.4 TB for EF, or 179.2 TB for HC</li> <li>• Raw hard disk capacity: 1344 TB for HC</li> </ul>	<ul style="list-style-type: none"> <li>• 4 database servers</li> <li>• 7 Exadata X6-2 storage servers</li> <li>• 2 Sun Datacenter InfiniBand Switch 36 switches</li> <li>• 2 redundant PDUs (single phase or three phase, high voltage or low voltage)</li> <li>• 1 48-port Cisco Catalyst 4948E-F, model number WS-C4948E-F-S Ethernet switch</li> <li>• Raw flash capacity: 179.2 TB for EF, or 89.6 TB for HC</li> <li>• Raw hard disk capacity: 672 TB for HC</li> </ul>	<ul style="list-style-type: none"> <li>• 2 database servers</li> <li>• 3 Exadata X6-2 storage servers</li> <li>• 2 Sun Datacenter InfiniBand Switch 36 switches</li> <li>• 2 redundant PDUs (single phase or three phase, high voltage or low voltage)</li> <li>• 1 48-port Cisco Catalyst 4948E-F, model number WS-C4948E-F-S Ethernet switch</li> <li>• Raw flash capacity: 76.8 TB for EF, or 38.4 TB for HC</li> <li>• Raw hard disk capacity: 288 TB for HC</li> </ul>	<ul style="list-style-type: none"> <li>• 2 database servers. Each server has 2 x22-core processors, each with 11 cores enabled.</li> <li>• 3 Exadata X6-2 storage servers. Each server has 2x 10-core processors, with 5 cores enabled. <ul style="list-style-type: none"> <li>– High Capacity (HC) storage servers have 2 PCI flash cards, each with 3.2 TB (raw) Smart Flash Cache and 6 x 8 TB 7,200 RPM high capacity disks.</li> <li>– EF storage servers have 8 PCI flash cards, 4 enabled, each with 3.2 TB (raw) storage.</li> </ul> </li> <li>• 2 Sun Datacenter InfiniBand Switch 36 switches</li> <li>• 2 redundant PDUs (single phase or three phase, high voltage or low voltage)</li> <li>• 1 48-port Cisco Catalyst 4948E-F, model number</li> </ul>

Table 9-2 (Cont.) Components of Exadata Database Machines in Fixed Configurations

Edition	Exadata Database Machine Full Rack	Exadata Database Machine Half Rack	Exadata Database Machine Quarter Rack	Exadata Database Machine Eighth Rack
				WS-C4948E-F-S Ethernet switch <ul style="list-style-type: none"> <li>• Raw flash capacity: 38.4 TB for EF, or 19.2 TB for HC</li> <li>• Raw hard disk capacity: 144 TB for HC</li> </ul>

Table 9-2 (Cont.) Components of Exadata Database Machines in Fixed Configurations

Edition	Exadata Database Machine Full Rack	Exadata Database Machine Half Rack	Exadata Database Machine Quarter Rack	Exadata Database Machine Eighth Rack
Exadata Database Machine X5-2	<ul style="list-style-type: none"> <li>• 8 database servers</li> <li>• 14 Exadata X5-2 storage servers</li> <li>• 2 Sun Datacenter InfiniBand Switch 36</li> <li>• 2 redundant PDUs (single phase or three phase, high voltage or low voltage)</li> <li>• 1 48-port Cisco Catalyst 4948E-F, model number WS-C4948E-F-S Ethernet switch</li> <li>• Raw flash capacity: 179.2 TB for EF, or 89.6 TB for HC</li> <li>• Raw hard disk capacity: 1344 TB for HC</li> </ul>	<ul style="list-style-type: none"> <li>• 4 database servers</li> <li>• 7 Exadata X5-2 storage servers</li> <li>• 2 Sun Datacenter InfiniBand Switch 36</li> <li>• 2 redundant PDUs (single phase or three phase, high voltage or low voltage)</li> <li>• 1 48-port Cisco Catalyst 4948E-F, model number WS-C4948E-F-S Ethernet switch</li> <li>• Raw flash capacity: 89.6 TB for EF, or 44.8 TB for HC</li> <li>• Raw hard disk capacity: 672 TB for HC</li> </ul>	<ul style="list-style-type: none"> <li>• 2 database servers</li> <li>• 3 Exadata X5-2 storage servers</li> <li>• 2 Sun Datacenter InfiniBand Switch 36</li> <li>• 2 redundant PDUs (single phase or three phase, high voltage or low voltage)</li> <li>• 1 48-port Cisco Catalyst 4948E-F, model number WS-C4948E-F-S Ethernet switch</li> <li>• Raw flash capacity: 38.4 TB for EF, or 19.2 TB for HC</li> <li>• Raw hard disk capacity: 288 TB for HC</li> </ul>	<ul style="list-style-type: none"> <li>• 2 database servers. Each server has 2 18-core processors, each with 9 cores enabled</li> <li>• 3 Exadata X5-2 storage servers. Each server has: <ul style="list-style-type: none"> <li>– 2 eight-core processors, each with 4 cores enabled</li> <li>– 4 PCI flash cards, 2 enabled, each with 1.6 TB (raw) Smart Flash Cache and 12 x 8 TB 7,200 RPM High Capacity (HC) disks, OR</li> <li>– 8 PCI flash drives, 4 enabled, each with 1.6 TB (raw) storage</li> </ul> </li> <li>• 2 Sun Datacenter InfiniBand Switch 36</li> <li>• 2 redundant PDUs (1 phase or 3 phase, high voltage or low voltage)</li> <li>• 1 48-port Cisco Catalyst 4948E-F, model number WS-C4948E-F-S Ethernet switch</li> <li>• Raw flash capacity: 19.2 TB for EF, or 9.6 TB for HC</li> <li>• Raw hard disk capacity: 144 TB for HC disks</li> </ul>

Table 9-2 (Cont.) Components of Exadata Database Machines in Fixed Configurations

Edition	Exadata Database Machine Full Rack	Exadata Database Machine Half Rack	Exadata Database Machine Quarter Rack	Exadata Database Machine Eighth Rack
Exadata Database Machine X5-8 Exadata Database Machine X6-8	<ul style="list-style-type: none"> <li>• 2 database servers</li> <li>• 14 Exadata X5-2 storage servers (X6-2 for X6-8)</li> <li>• 2 Sun Datacenter InfiniBand Switch 36</li> <li>• 2 redundant PDUs (single phase or three phase, high voltage or low voltage)</li> <li>• 1 48-port Cisco Catalyst 4948E-F, model number WS-C4948E-F-S Ethernet switch</li> <li>• Raw flash capacity: 179.2 TB for EF, or 89.6 TB for HC</li> <li>• Raw hard disk capacity: 1344 TB for HC</li> </ul>	<ul style="list-style-type: none"> <li>• 2 database servers</li> <li>• 3 Exadata X5-2 storage servers</li> <li>• 2 Sun Datacenter InfiniBand Switch 36</li> <li>• 2 redundant PDUs (single phase or three phase, high voltage or low voltage)</li> <li>• 1 48-port Cisco Catalyst 4948E-F, model number WS-C4948E-F-S Ethernet switch</li> <li>• Raw flash capacity: 38.4 TB for EF, or 19.2 TB for HC</li> <li>• Raw hard disk capacity: 288 TB for HC</li> </ul>	Not applicable	Not applicable

Table 9-2 (Cont.) Components of Exadata Database Machines in Fixed Configurations

Edition	Exadata Database Machine Full Rack	Exadata Database Machine Half Rack	Exadata Database Machine Quarter Rack	Exadata Database Machine Eighth Rack
Exadata Database Machine X4-2	<ul style="list-style-type: none"> <li>• 8 database servers</li> <li>• 14 Exadata X4-2L storage servers</li> <li>• 2 Sun Datacenter InfiniBand Switch 36</li> <li>• 2 redundant 15 kVA PDUs (single phase or three phase, high voltage or low voltage)</li> <li>• 1 48-port Cisco Catalyst 4948E-F, model number WS-C4948E-F-S Ethernet switch</li> <li>• 44.8 TB of raw flash capacity</li> <li>• 200 TB raw storage capacity for high performance disks, or 672 TB raw capacity for HC</li> </ul>	<ul style="list-style-type: none"> <li>• 4 database servers</li> <li>• 7 Exadata X4-2L storage servers</li> <li>• 2 Sun Datacenter InfiniBand Switch 36</li> <li>• 2 redundant 15 kVA PDUs (single phase or three phase, high voltage or low voltage)</li> <li>• 1 48-port Cisco Catalyst 4948E-F, model number WS-C4948E-F-S Ethernet switch</li> <li>• 22.4 TB of raw flash capacity</li> <li>• 100 TB raw storage capacity for high performance disks, or 386 TB raw capacity for HC</li> </ul>	<ul style="list-style-type: none"> <li>• 2 database servers</li> <li>• 3 Exadata X4-2L storage servers</li> <li>• 2 Sun Datacenter InfiniBand Switch 36</li> <li>• 2 redundant 15 kVA PDUs (single phase or three phase, high voltage or low voltage)</li> <li>• 1 48-port Cisco Catalyst 4948E-F, model number WS-C4948E-F-S Ethernet switch</li> <li>• 9.6 TB of raw flash capacity</li> <li>• 43.2 TB raw storage capacity for high performance disks, or 144 TB raw capacity for HC</li> </ul>	<ul style="list-style-type: none"> <li>• 2 database servers</li> <li>• 3 Exadata X4-2L storage servers. Each server has:               <ul style="list-style-type: none"> <li>- 2 six-core processors</li> <li>- 12 x 1.2 TB 10,000 RPM High Performance disks, OR</li> <li>- 12 x 4 TB 7,200 RPM High Capacity disks</li> </ul> </li> <li>• 2 Sun Datacenter InfiniBand Switch 36</li> <li>• 2 redundant 15 kVA PDUs (single phase or three phase, high voltage or low voltage)</li> <li>• 1 48-port Cisco Catalyst 4948E-F, model number WS-C4948E-F-S Ethernet switch</li> <li>• 4.8 TB of raw flash capacity</li> <li>• 21.6 TB raw storage capacity for high performance disks, or 72 TB raw capacity for HC</li> </ul>



**Table 9-2 (Cont.) Components of Exadata Database Machines in Fixed Configurations**

Edition	Exadata Database Machine Full Rack	Exadata Database Machine Half Rack	Exadata Database Machine Quarter Rack	Exadata Database Machine Eighth Rack
Exadata Database Machine X4-8 Full Rack	<ul style="list-style-type: none"> <li>• 2 database servers</li> <li>• 14 Exadata X4-2L storage servers</li> <li>• 2 Sun Datacenter InfiniBand Switch 36</li> <li>• 2 redundant 15 kVA PDUs (single phase or three phase, high voltage or low voltage)</li> <li>• 1 48-port Cisco Catalyst 4948E-F, model number WS-C4948E-F-S Ethernet switch</li> <li>• 44.8 TB of raw flash capacity</li> <li>• 200 TB raw storage capacity for high performance disks, or 672 TB raw capacity for HC</li> </ul>	Not applicable	Not applicable	Not applicable

Table 9-2 (Cont.) Components of Exadata Database Machines in Fixed Configurations

Edition	Exadata Database Machine Full Rack	Exadata Database Machine Half Rack	Exadata Database Machine Quarter Rack	Exadata Database Machine Eighth Rack
Exadata Database Machine X3-2	<ul style="list-style-type: none"> <li>• 8 database servers</li> <li>• 14 Exadata X3-2 storage servers</li> <li>• 3 Sun Datacenter InfiniBand Switch 36</li> <li>• 2 redundant 15 kVA PDUs (single phase or three phase, high voltage or low voltage)</li> <li>• 1 48-port Cisco Catalyst 4948E-F, model number WS-C4948E-F-S Ethernet switch</li> <li>• 22.4 TB of raw flash capacity</li> <li>• 100 TB raw storage capacity for high performance disks, or 504 TB raw capacity for HC</li> </ul>	<ul style="list-style-type: none"> <li>• 4 database servers</li> <li>• 7 Exadata X3-2 storage servers</li> <li>• 3 Sun Datacenter InfiniBand Switch 36 (Exadata Database Machine Half Rack based on Sun Fire X4170 Oracle Database Servers includes two Sun Datacenter InfiniBand Switch 36 switches.)</li> <li>• 2 redundant 15 kVA PDUs (single phase or three phase, high voltage or low voltage)</li> <li>• 1 48-port Cisco Catalyst 4948E-F, model number WS-C4948E-F-S Ethernet switch</li> <li>• 11.2 TB of raw flash capacity</li> <li>• 50 TB raw storage capacity for high performance disks, or 252 TB raw capacity for HC</li> </ul>	<ul style="list-style-type: none"> <li>• 2 database servers</li> <li>• 3 Exadata X3-2 storage servers</li> <li>• 2 Sun Datacenter InfiniBand Switch 36</li> <li>• 2 redundant 15 kVA PDUs (single phase or three phase, high voltage or low voltage)</li> <li>• 1 48-port Cisco Catalyst 4948E-F, model number WS-C4948E-F-S Ethernet switch</li> <li>• 4.8 TB of raw flash capacity</li> <li>• 21.6 TB raw storage capacity for high performance disks, or 108 TB raw capacity for HC</li> </ul>	<ul style="list-style-type: none"> <li>• 2 database servers</li> <li>• 3 Exadata X3-2 storage servers               <ul style="list-style-type: none"> <li>- 2 six-core processors, each with 3 cores enabled</li> <li>- 12 PCI flash cards (6 cards enabled) with 2.4 TB Exadata Smart Flash Cache</li> <li>- 18 x 600 GB 15,000 RPM High Performance disks, OR 18 x 3 TB 7,200 RPM High Capacity disks (6 disks per storage server enabled)</li> </ul> </li> <li>• 2 Sun Datacenter InfiniBand Switch 36</li> <li>• 2 redundant 15 kVA PDUs (single phase or three phase, high voltage or low voltage)</li> <li>• 1 48-port Cisco Catalyst 4948E-F, model number WS-C4948E-F-S Ethernet switch</li> <li>• 2.4 TB of raw flash capacity</li> <li>• 10.8 TB raw storage capacity for high performance disks, or 54 TB raw capacity for HC</li> </ul>

**Table 9-2 (Cont.) Components of Exadata Database Machines in Fixed Configurations**

Edition	Exadata Database Machine Full Rack	Exadata Database Machine Half Rack	Exadata Database Machine Quarter Rack	Exadata Database Machine Eighth Rack
Exadata Database Machine X3-8 Full Rack with Exadata X4-2L storage servers	<ul style="list-style-type: none"> <li>• 2 database servers</li> <li>• 14 Exadata X4-2L storage servers</li> <li>• 2 Sun Datacenter InfiniBand Switch 36</li> <li>• 2 redundant 24 kVA PDUs (three phase, high voltage or low voltage)</li> <li>• 1 48-port Cisco Catalyst 4948E-F, model number WS-C4948E-F-S Ethernet switch</li> <li>• 44.8 TB of raw flash capacity</li> <li>• 200 TB raw storage capacity for high performance disks, or 672 TB raw capacity for HC</li> </ul>	Not applicable	Not applicable	Not applicable

Table 9-2 (Cont.) Components of Exadata Database Machines in Fixed Configurations

Edition	Exadata Database Machine Full Rack	Exadata Database Machine Half Rack	Exadata Database Machine Quarter Rack	Exadata Database Machine Eighth Rack
Exadata Database Machine X3-8 Full Rack with Exadata X3-2 storage servers	<ul style="list-style-type: none"> <li>• 2 database servers</li> <li>• 14 Exadata X3-2 storage servers</li> <li>• 3 Sun Datacenter InfiniBand Switch 36</li> <li>• 2 redundant 24 kVA PDUs (three phase, high voltage or low voltage)</li> <li>• 1 48-port Cisco Catalyst 4948E-F, model number WS-C4948E-F-S Ethernet switch</li> <li>• 22.4 TB of raw flash capacity</li> <li>• 100 TB raw storage capacity for high performance disks, or 504 TB raw capacity for HC</li> </ul>	Not applicable	Not applicable	Not applicable

Table 9-2 (Cont.) Components of Exadata Database Machines in Fixed Configurations

Edition	Exadata Database Machine Full Rack	Exadata Database Machine Half Rack	Exadata Database Machine Quarter Rack	Exadata Database Machine Eighth Rack
Exadata Database Machine X2-2	<ul style="list-style-type: none"> <li>• 8 database servers</li> <li>• 14 Exadata X2-2 storage servers</li> <li>• 3 Sun Datacenter InfiniBand Switch 36</li> <li>• Keyboard, video, and mouse (KVM) hardware</li> <li>• 2 redundant 15 kVA PDUs (single phase or three phase, high voltage or low voltage)</li> <li>• 1 48-port Cisco Catalyst 4948, model number WS-C4948-S Ethernet switch</li> <li>• 5.3 TB of raw flash capacity</li> </ul>	<ul style="list-style-type: none"> <li>• 4 database servers</li> <li>• 7 Exadata X2-2 storage servers</li> <li>• 3 Sun Datacenter InfiniBand Switch 36 (Exadata Database Machine Half Rack based on Sun Fire X4170 Oracle Database Servers includes two Sun Datacenter InfiniBand Switch 36 switches.)</li> <li>• Keyboard, video, and mouse (KVM) hardware</li> <li>• 2 redundant 15 kVA PDUs (single phase or three phase, high voltage or low voltage)</li> <li>• 1 48-port Cisco Catalyst 4948, model number WS-C4948-S Ethernet switch</li> <li>• 2.6 TB of raw flash capacity</li> </ul>	<ul style="list-style-type: none"> <li>• 2 database servers</li> <li>• 3 Exadata X2-2 storage servers</li> <li>• 2 Sun Datacenter InfiniBand Switch 36</li> <li>• Keyboard, video, and mouse (KVM) hardware</li> <li>• 2 redundant 15 kVA PDUs (single phase or three phase, high voltage or low voltage)</li> <li>• 1 48-port Cisco Catalyst 4948, model number WS-C4948-S Ethernet switch</li> <li>• 1.1 TB of raw flash capacity</li> </ul>	Not applicable

Table 9-2 (Cont.) Components of Exadata Database Machines in Fixed Configurations

Edition	Exadata Database Machine Full Rack	Exadata Database Machine Half Rack	Exadata Database Machine Quarter Rack	Exadata Database Machine Eighth Rack
Exadata Database Machine X2-8 Full Rack	<ul style="list-style-type: none"> <li>• 2 database servers</li> <li>• 14 Exadata X2-2 storage servers</li> <li>• 3 Sun Datacenter InfiniBand Switch 36</li> <li>• 2 redundant 24 kVA PDUs (three phase, high voltage or low voltage)</li> <li>• 1 48-port Cisco Catalyst 4948, model number WS-C4948-S Ethernet switch</li> <li>• 5.3 TB of raw flash capacity</li> </ul>	Not applicable	Not applicable	Not applicable

## 9.2 Oracle Exadata Database Server Hardware Components

Each Oracle Exadata Database Machine contains multiple database servers.

The following sections describe the database server components for each type of Oracle Exadata Database Machine:

- [Database Server Components of Exadata Database Machine X9M-2](#)
- [Database Server Components of Exadata Database Machine X9M-8](#)
- [Database Server Components of Exadata Database Machine X8M-2](#)
- [Database Server Components of Exadata Database Machine X8M-8](#)
- [Database Server Components of Oracle Exadata Database Machine X8-2](#)
- [Database Server Components of Oracle Exadata Database Machine X8-8](#)
- [Database Server Components of Oracle Exadata Database Machine X7-2](#)
- [Database Server Components of Oracle Exadata Database Machine X7-8](#)
- [Database Server Components of Oracle Exadata Database Machine X6-2](#)
- [Database Server Components of Oracle Exadata Database Machine X5-2](#)
- [Database Server Components of Oracle Exadata Database Machine X5-8 and X6-8](#)
- [Database Server Components of Oracle Exadata Database Machine X4-2](#)
- [Database Server Components of Oracle Exadata Database Machine X4-8 Full Rack](#)
- [Database Server Components of Oracle Exadata Database Machine X3-2](#)

- [Database Server Components of Oracle Exadata Database Machine X3-8 Full Rack](#)
- [Database Server Components of Oracle Exadata Database Machine X2-2](#)
- [Database Server Components of Oracle Exadata Database Machine X2-8 Full Rack](#)

## 9.2.1 Database Server Components of Exadata Database Machine X9M-2

Each Exadata Database Machine X9M-2 database server includes the following components:

- CPU - 32-core Intel Xeon 8358 processors (2.6 GHz):
  - Flexible configuration: 2 CPUs
  - Eighth Rack: 1 CPU
- RAM:
  - Flexible configuration: 512 GB RAM (16 x 32 GB DIMMs), expandable to 1 TB (16 x 64 GB DIMMs), 1.5 TB (16 x 32 GB and 16 x 64 GB DIMMs), or 2 TB (32 x 64 GB DIMMs) with memory expansion kit
  - Eighth Rack: 384 GB RAM (12 x 32 GB DIMMs), expandable to 1 TB (16 x 64 GB DIMMs) with memory expansion kit
- System storage: 2 x 3.84 TB PCIe 4.0 NVMe storage drives, expandable to 4 drives
- RDMA Network Fabric: 1 x dual-port CX5 RDMA Network Fabric card; PCIe 4.0, 2 x 100 Gb/s ports active-active (200 Gb/s combined throughput)
- Administration network: 1 x 1 GbE Base-T Ethernet port
- Integrated Lights Out Manager (ILOM) port for remote management: 1 x 1 GbE Base-T Ethernet port
- Client and additional network connectivity:
  - Flexible configuration options:
    - \* Two factory-installed network cards. Each card contains 2 x SFP+/SFP28 ports (10/25 GbE) or 4 x 10GBASE-T ports (10 GbE)
    - \* One optional field-installed network card containing 2 x SFP+/SFP28 ports (10/25 GbE) or 4 x 10GBASE-T ports (10 GbE) or 2 x QSFP28 ports (100GbE). Each QSFP28 port can support one 10 GbE or 25 GbE link with appropriate breakout cables.
  - Eighth Rack: Two factory-installed network cards only. Each card contains 2 x SFP+/SFP28 ports (10/25 GbE) or 4 x 10GBASE-T ports (10 GbE)

## 9.2.2 Database Server Components of Exadata Database Machine X9M-8

Each Exadata Database Machine X9M-8 database server includes the following components:

- CPU: 8 x 24-core Intel Xeon Platinum 8268 Processors (2.9GHz)
- RAM: 3 TB (48 x 64 GB DIMMs), expandable to a maximum of 6 TB
- System storage: 2 x 6.4 TB flash accelerator PCIe cards (Hot-Pluggable)
- RDMA Network Fabric: 4 x dual-port QSFP28 100 Gb/s PCIe 3.0 RDMA Network Fabric cards - all ports active
- Network connectivity:
  - 8 x 10GBASE-T ports (1/10 GbE) - 1 port used for the administration network
  - 8 x SFP+/SFP28 ports (10/25 GbE)
- Integrated Lights Out Manager (ILOM) port for remote management: 1 x 1 GbE Base-T Ethernet port
- Redundant hot-swappable power supplies and fans

## 9.2.3 Database Server Components of Exadata Database Machine X8M-2

Exadata Database Machine X8M-2 database servers include the following components:

- 2 x 24-core Intel Xeon Platinum 8260 Processors (2.4 GHz)
- 384 GB RAM (12 x 32 GB DIMMs), expandable to 1.5 TB (24 x 64 GB DIMMs) with memory expansion kit
- 4 x 1.2 TB boot drive/hard disks, hot swappable, expandable to 8 drives
- Disk controller HBA with 2 GB cache (no batteries)
- RDMA Network Fabric: 1 x dual-port QSFP28 100 Gb/s PCIe 3.0 RDMA Network Fabric card - both ports active
- Client network: 2 x SFP+/SFP28 ports (10/25 GbE) or 2 x 10GBASE-T ports (10 GbE)
- Backup/optional networks: 2 x SFP+/SFP28 ports (10/25 GbE) or 4 x 10GBASE-T ports (10 GbE)
- Administration network: 1 x 1 GbE Base-T Ethernet port
- Integrated Lights Out Manager (ILOM) port for remote management: 1 x 1 GbE Base-T Ethernet port

## 9.2.4 Database Server Components of Exadata Database Machine X8M-8

Exadata Database Machine X8M-8 database servers include the following components:

- 8 x 24-core Intel(R) Xeon(R) Platinum 8268 Processors (2.9GHz)
- 3 TB (48 x 64 GB DIMMs) RAM
- 2 x 6.4 TB flash accelerator PCIe cards (Hot-Pluggable)
- RDMA Network Fabric: 4 x dual-port QSFP28 100 Gb/s PCIe 3.0 RDMA Network Fabric cards - all ports active
- 8 x 10GBASE-T ports (10 GbE) - 1 port used for the administration network
- 8 x SFP+/SFP28 ports (10/25 GbE)
- Integrated Lights Out Manager (ILOM) port for remote management: 1 x 1 GbE Base-T Ethernet port



- Redundant hot swappable power supplies and fans

## 9.2.5 Database Server Components of Oracle Exadata Database Machine X8-2

Oracle Exadata Database Machine X8-2 database servers include the following components:

- 2 x 24-core Intel Xeon Platinum 8260 Processors (2.4 GHz)
- 384 GB RAM (12 x 32 GB DIMMs), expandable to 768 GB (12 x 64 GB DIMMs) or 1.5 TB (24 x 64 GB DIMMs) with memory expansion kit
- 4 x 1.2 TB boot drive/hard disks, hot swappable, expandable to 8 drives
- Disk controller HBA with 2 GB cache (no batteries)
- RDMA Network Fabric: 2 x InfiniBand 4X QDR (40 Gb/s) ports (PCIe 3.0) - both ports active
- Client network: 2 x SFP+/SFP28 ports (10/25 GbE) or 2 x 10GBASE-T ports (10 GbE)
- Backup/optional networks: 2 x SFP+/SFP28 ports (10/25 GbE) or 4 x 10GBASE-T ports (10 GbE)
- Administration network: 1 x 1 GbE Base-T Ethernet port
- Integrated Lights Out Manager (ILOM) port for remote management: 1 x 1 GbE Base-T Ethernet port

## 9.2.6 Database Server Components of Oracle Exadata Database Machine X8-8

Oracle Exadata Database Machine X8-8 database servers include the following components:

- 8 x 24-core Intel(R) Xeon(R) Platinum 8268 Processors (2.9GHz)
- 3 TB (48 x 64 GB DIMMs) RAM, expandable to 6 TB (96 x 64 GB DIMMs) with memory expansion kit
- 2 x 6.4 TB flash accelerator PCIe cards (Hot-Pluggable)
- RDMA Network Fabric: 8 x InfiniBand 4X QDR (40 Gb/s) ports (PCIe 3.0) - all ports active
- 8 x 10GBASE-T ports (10 GbE) - 1 port used for the administration network
- 8 x SFP+/SFP28 ports (10/25 GbE)
- Integrated Lights Out Manager (ILOM) port for remote management: 1 x 1 GbE Base-T Ethernet port
- Redundant hot swappable power supplies and fans

## 9.2.7 Database Server Components of Oracle Exadata Database Machine X7-2

Oracle Exadata Database Machine X7-2 database servers include the following components:

- 2 x 24-core Intel Xeon Platinum 8160 Processors (2.10GHz)
- 384 GB RAM, expandable to 768 GB (12 x 64 GB) or 1.5 TB (24 x 64GB) with memory expansion kit
- 4 x 600 GB 10K RPM SAS disks, hot swappable, expandable to 8 drives
- Disk controller HBA with 2 GB cache (no batteries)
- 2 x InfiniBand 4X QDR (40 Gbps) ports (PCIe 3.0), both ports active
- 2 x 10 GbE Base-T Ethernet ports or 2 x 10GbE/25GbE Ethernet SFP28 Ports
- 2 x 10GbE/25GbE Ethernet SFP28 Ports
- 1 x 10/100/1000 BASE-T Ethernet port for Integrated Lights Out Manager (ILOM) for remote management

## 9.2.8 Database Server Components of Oracle Exadata Database Machine X7-8

Oracle Exadata Database Machine X7-8 database servers include the following components:

- 8 x 24-core Intel(R) Xeon(R) Platinum 8168 Processors (2.70GHz)
- 3TB (48 x 64 GB) RAM, expandable to 6 TB (96 x 64 GB) with memory expansion kit
- 8 x InfiniBand 4X QDR (40 Gbps) ports (PCIe 3.0) - all ports active
- 8 x 10 GbE Base-T Ethernet ports (8 embedded ports based on the Intel 722 1/10GbE Controller)
- 8 x 10GbE/25GbE Ethernet SFP28 Ports (4 Dual-port 10/25 GbE PCIe 3.0 network card based on the Broadcom BCM57414 10Gb/25Gb Ethernet Controller technology)
- 1 Ethernet port for Integrated Lights Out Manager (ILOM) for remote management
- Redundant hot swappable power supplies and fans

## 9.2.9 Database Server Components of Oracle Exadata Database Machine X6-2

Oracle Exadata Database Machine X6-2 database servers include the following components:

- 2 x 22-core Intel Xeon E5-2699 v4 processors (2.2 GHz)
- 256 GB (8 x 32 GB) RAM expandable to 512 GB (16 x 32 GB) or 768 GB (24 x 32 GB) with memory expansion kit
- 4 x 600 GB 10K RPM SAS disks, hot swappable, expandable to 8x
- Disk controller HBA with 1 GB cache (no more batteries)
- 2 x InfiniBand 4X QDR (40 Gbps) ports (PCIe 3.0), both ports active

- 4 x 1 GbE/10 GbE Base-T Ethernet ports
- 2 x 10 GbE Ethernet SFP+ ports (1 dual-port 10 GbE PCIe 2.0 network card based on the Intel 82599 10 GbE controller technology)
- 1 Ethernet port for Integrated Lights Out Manager (ILOM) for remote management

## 9.2.10 Database Server Components of Oracle Exadata Database Machine X5-2

Oracle Exadata Database Machine X5-2 database servers include the following components:

- 2 Eighteen-Core Intel Xeon E5-2699 v3 processors (2.3 GHz)
- 256 GB (8 x 32 GB) RAM expandable to 768 GB with memory expansion kit
- 4 x 600 GB 10K RPM SAS disks
- Disk controller HBA with 1 GB supercap-backed write cache
- 2 InfiniBand 4X QDR (40 Gb/s) ports (1 dual-port PCIe 3.0 Host Channel Adapter (HCA))
- 4 x 1 GbE/10GbE Base-T Ethernet ports
- 2 x 10 GbE Ethernet SFP+ ports (1 dual-port 10GbE PCIe 2.0 network card based on the Intel 82599 10 GbE controller technology)
- 1 Ethernet port for Integrated Lights Out Manager (ILOM) for remote management

## 9.2.11 Database Server Components of Oracle Exadata Database Machine X5-8 and X6-8

Oracle Exadata Database Machine X5-8 and X6-8 database servers include the following components:

- 8 Eighteen-Core Intel Xeon E7-8895 v3 processors (2.6 GHz)
- 2 TB (64 x 32 GB) RAM, expandable to 6 TB (192 x 32 GB) with memory expansion kit
- 8 x 600 GB 10K RPM SAS disks (hot swappable)
- Disk controller HBA with 1 GB cache
- 8 x InfiniBand 4X QDR (40 Gbps) ports (PCIe 3.0) - all ports active
- 10 x 1 GbE Base-T Ethernet ports (2 Quad-port PCIe 2.0 network card, and 2 embedded ports based on the Intel I350 1 GbE Controller technology)
- 8 x 10 GbE Ethernet SFP+ ports (4 Dual-port 10 GbE PCIe 2.0 network card based on the Intel 82599 10 GbE Controller technology)
- 1 Ethernet port for Integrated Lights Out Manager (ILOM) for remote management
- Redundant hot swappable power supplies and fans

## 9.2.12 Database Server Components of Oracle Exadata Database Machine X4-2

Oracle Exadata Database Machine X4-2 database servers include the following components:

- 2 Twelve-Core Intel Xeon E5-2697 v2 processors (2.7 GHz)
- 256 GB (16 x 16 GB) RAM expandable to 512 GB with memory expansion kit
- 4 x 600 GB 10K RPM SAS disks
- Disk controller HBA with 512 MB battery-backed write cache, and swappable battery backup unit (BBU)
- 2 InfiniBand 4X QDR (40 Gb/s) ports (1 dual-port PCIe 3.0 Host Channel Adapter (HCA))
- 4 x 1 GbE/10GbE Base-T Ethernet ports
- 2 x 10 GbE Ethernet SFP+ ports (1 dual-port 10GbE PCIe 2.0 network card based on the Intel 82599 10 GbE controller technology)
- 1 Ethernet port for Integrated Lights Out Manager (ILOM) for remote management

## 9.2.13 Database Server Components of Oracle Exadata Database Machine X4-8 Full Rack

Oracle Exadata Database Machine X4-8 Full Rack database servers include the following components:

- 8 Fifteen-Core Intel Xeon E5-8895 v2 processors (2.8 GHz)
- 2 TB (64 x 32 GB) RAM expandable to 4 TB or 6 TB with memory expansion kit
- 7 x 600 GB 10K RPM SAS disks
- Disk controller HBA with 512 MB battery-backed write cache, and swappable battery backup unit (BBU)
- 8 InfiniBand 4X QDR (40 Gb/s) ports
- 10 x 1 GbE Base-T Ethernet ports
- 8 x 10 GbE Ethernet SFP+ ports (4 dual-port 10GbE PCIe 2.0 network card based on the Intel 82599 10 GbE controller technology)
- 1 Ethernet port for Integrated Lights Out Manager (ILOM) for remote management

## 9.2.14 Database Server Components of Oracle Exadata Database Machine X3-2

Oracle Exadata Database Machine X3-2 database servers include the following components:

- 2 Eight-Core Intel Xeon E5-2690 processors (2.9 GHz)
- 256 GB (16 x 16 GB) RAM expandable to 512 GB with memory expansion kit
- 4 x 300 GB 10K RPM SAS disks
- Disk controller HBA with 512 MB battery-backed write cache

- 2 InfiniBand 4X QDR (40 Gb/s) ports (1 dual-port PCIe 2.0 Host Channel Adapter (HCA))
- 4 x 1 GbE/10GbE Base-T Ethernet ports
- 2 x 10 GbE Ethernet SFP+ ports (1 dual-port 10GbE PCIe 2.0 network card based on the Intel 82599 10 GbE controller technology)
- 1 Ethernet port for ILOM for remote management

## 9.2.15 Database Server Components of Oracle Exadata Database Machine X3-8 Full Rack

Oracle Exadata Database Machine X3-8 Full Rack database servers include the following components:

- 8 Ten-core Intel Xeon E7-8870 Processors (2.40 GHz)
- 2 TB RAM (128 x 16 GB)
- 8 x 300GB 10K RPM SAS Disks
- Disk Controller HBA with 512MB Battery-backed cache
- 8 x InfiniBand QDR (40 Gb/s) Ports
- 2 Network Express Modules (NEM) providing the following:
  - 8 x 10 Gb Ethernet network ports using SFP+ connectors (based on Intel 82599 10 GbE controller)
  - 8 x 1 Gb Ethernet network ports
- 1 Ethernet port for Sun Integrated Lights Out Manager (ILOM) for remote management

## 9.2.16 Database Server Components of Oracle Exadata Database Machine X2-2

### **Components of Sun Fire X4170 Oracle Database Servers**

- 2 Quad-Core Intel Xeon E5540 processors (2.53 GHz)
- 72 GB RAM expandable to 144 GB with memory expansion kit
- 4 x 146 GB 10K RPM SAS disks
- Disk controller HBA with 512 MB battery-backed write cache
- Dual-port 4X QDR (40 Gb/s) InfiniBand Host Channel Adapter (HCA)
- 4 embedded Gigabit Ethernet ports
- 1 Ethernet port for Sun Integrated Lights Out Manager (ILOM) for remote management

### **Components of Sun Fire X4170 M2 Oracle Database Servers**

- 2 Six-Core Intel Xeon X5675 processors (3.06 GHz)
- 96 GB RAM expandable to 288 GB with memory expansion kit
- 4 x 300 GB 10 K RPM SAS disks

- Disk controller HBA with 512 MB battery-backed write cache
- Dual-port 4X QDR (40 Gb/s) InfiniBand Host Channel Adapter (HCA)
- 4 embedded Gigabit Ethernet ports
- 1 Ethernet port for Sun Integrated Lights Out Manager (ILOM) for remote management
- 1 dual-port 10 GbE PCIe 2.0 network card with Intel 82599 10 GbE controller

 **Note:**

- Sun Fire X4170 M2 Oracle Database Servers ship from the factory with 96 GB of memory with 12 of the 18 DIMM slots populated with 8 GB DIMMs. The optional X2-2 Memory Expansion Kit can be used to populate the remaining 6 empty slots with 16 GB DIMMs to bring the total memory to 192 GB (12 x 8 GB and 6 x 16 GB), or replace the existing 8 GB DIMMs with 16 GB DIMMs and add memory to bring the total memory to 288 GB (18 x 16 GB).

The memory expansion kit is primarily for consolidation workloads where many databases are run on each database server. In this scenario, the CPU usage is often low while the memory usage is very high.

However, there is a downside to populating all the memory slots as the frequency of the memory DIMMs drop to 800 MHz from 1333 MHz. The performance effect of the slower memory appears as increased CPU utilization. The average measured increase in CPU utilization is typically between 5% and 10%. The increase varies greatly by workload. In test workloads, several workloads had almost zero increase, while one workload had as high as a 20% increase.

## 9.2.17 Database Server Components of Oracle Exadata Database Machine X2-8 Full Rack

### Components of Sun Fire X4800 Oracle Database Servers

- 8 Eight-core Intel Xeon X7560 Processors (2.26 GHz)
- 1 TB RAM
- 8 x 300GB 10K RPM SAS Disks
- Disk Controller HBA with 512MB Battery-backed cache
- 4 dual-port 4X QDR InfiniBand PCIe 2.0 Express Modules (EM)
- 2 Network Express Modules (NEM) providing the following:
  - 8 x 10 Gb Ethernet network ports using SFP+ connectors (based on Intel 82599 10 GbE controller)
  - 8 x 1 Gb Ethernet network ports
- 1 Ethernet port for Sun Integrated Lights Out Manager (ILOM) for remote management

### Components of Sun Server X2-8 Oracle Database Server

- 8 Ten-core Intel Xeon E7-8870 Processors (2.40 GHz)

- 2 TB RAM (128 x 16 GB)
- 8 x 300GB 10K RPM SAS Disks
- Disk Controller HBA with 512MB Battery-backed cache
- 4 dual-port 4X QDR InfiniBand PCIe 2.0 Express Modules (EM)
- 2 Network Express Modules (NEM) providing the following:
  - 8 x 10 Gb Ethernet network ports using SFP+ connectors (based on Intel 82599 10 GbE controller)
  - 8 x 1 Gb Ethernet network ports
- 1 Ethernet port for Sun Integrated Lights Out Manager (ILOM) for remote management

## 9.3 Oracle Exadata Storage Server Hardware Components

Each Oracle Exadata Database Machine contains multiple storage servers.

The following sections describe the hardware components for each type of Oracle Exadata Storage Server:

- [Extreme Flash Exadata Storage Server X9M-2 Hardware Components](#)  
Each Oracle Exadata Storage Server X9M-2 Extreme Flash (EF) server includes the following components:
- [High Capacity Exadata Storage Server X9M-2 Hardware Components](#)  
Each Oracle Exadata Storage Server X9M-2 High Capacity (HC) server includes the following components:
- [Extended Exadata Storage Server X9M-2 Hardware Components](#)  
Each Oracle Exadata Storage Server X9M-2 Extended (XT) server includes the following components:
- [Extreme Flash Exadata Storage Server X8M-2 and X8-2 Hardware Components](#)  
Oracle Exadata Storage Server X8-2 and X8M-2 Extreme Flash servers include the following components:
- [High Capacity Exadata Storage Server X8-2 and X8M-2 Hardware Components](#)  
Oracle Exadata Storage Server X8-2 and X8M-2 High Capacity servers include the following components:
- [Extended Exadata Storage Server X8-2 and X8M-2 Hardware Components](#)  
Exadata Extended (XT) Storage Server and X8M-2 Extended (XT) servers include the following components:
- [Extreme Flash Exadata Storage Server X7-2 Hardware Components](#)  
Oracle Exadata Storage Server X7-2 Extreme Flash servers include the following components:
- [High Capacity Exadata Storage Server X7-2 Hardware Components](#)  
Oracle Exadata Storage Server X7-2 High Capacity servers include the following components:
- [Extreme Flash Exadata Storage Server X6-2 Hardware Components](#)  
Oracle Exadata Storage Server X6-2 Extreme Flash servers include the following components:

- [High Capacity Exadata Storage Server X6-2 Hardware Components](#)  
Oracle Exadata Storage Server X6-2 High Capacity servers include the following components:
- [Extreme Flash Exadata Storage Server X5-2 Hardware Components](#)  
Oracle Exadata Storage Server X5-2 Extreme Flash servers include the following components:
- [High Capacity Exadata Storage Server X5-2 Hardware Components](#)  
Oracle Exadata Storage Server X5-2 High Capacity servers include the following components:
- [Exadata Storage Server X4-2L Hardware Components](#)  
Oracle Exadata Storage Server X4-2L servers include the following components:
- [Exadata Storage Server X3-2L Hardware Components](#)  
Oracle Exadata Storage Server X3-2L servers include the following components:
- [Exadata Storage Server with Sun Fire X4270 M2 Servers Hardware Components](#)  
Oracle Exadata Storage Server with Sun Fire X4270 M2 Servers include the following components:
- [Exadata Storage Server with Sun Fire X4275 Servers Hardware Components](#)  
Oracle Exadata Storage Server with Sun Fire X4275 Servers include the following components:

### 9.3.1 Extreme Flash Exadata Storage Server X9M-2 Hardware Components

Each Oracle Exadata Storage Server X9M-2 Extreme Flash (EF) server includes the following components:

- CPU: 2 x 16-core Intel Xeon 8352Y processors (2.2 GHz)
- RAM: 256 GB (16 x 16 GB DDR4 3200 MT/s DIMMs)
- Flash storage: 8 x 6.4 TB NVMe flash devices (PCIe 4.0)
- Persistent memory: 12 x 128 GB modules (Intel Optane Persistent Memory 200 Series)
- System storage: 2 x 240 GB M.2 devices
- RDMA Network Fabric: 1 x dual-port CX5 RDMA Network Fabric card; PCIe 4.0, 2 x 100 Gb/s ports active-active (200 Gb/s combined throughput)
- Administration network: 1 x 1 GbE Base-T Ethernet port
- Integrated Lights Out Manager (ILOM) port for remote management: 1 x 1 GbE Base-T Ethernet port

The X9M-2 EF storage server requires Oracle Exadata System Software release 21.2.0 or later.

### 9.3.2 High Capacity Exadata Storage Server X9M-2 Hardware Components

Each Oracle Exadata Storage Server X9M-2 High Capacity (HC) server includes the following components:

- CPU: 2 x 16-core Intel Xeon 8352Y processors (2.2 GHz)



- RAM: 256 GB (16 x 16 GB DDR4 3200 MT/s DIMMs)
- Disk storage: 12 x 18 TB hard disk drives (HDD), but only 6 HDD on Eighth Rack configurations
- Disk controller Host Bus Adapter (HBA) with 2 GB cache
- Flash storage: 4 x 6.4 TB NVMe flash devices (PCIe 4.0), but only 2 flash devices on Eighth Rack configurations
- Persistent memory: 12 x 128 GB modules (Intel Optane Persistent Memory 200 Series), but only 6 modules on Eighth Rack configurations
- System storage: 2 x 240 GB M.2 devices
- RDMA Network Fabric: 1 x dual-port CX5 RDMA Network Fabric card; PCIe 4.0, 2 x 100 Gb/s ports active-active (200 Gb/s combined throughput)
- Administration network: 1 x 1 GbE Base-T Ethernet port
- Integrated Lights Out Manager (ILOM) port for remote management: 1 x 1 GbE Base-T Ethernet port

The X9M-2 HC storage server requires Oracle Exadata System Software release 21.2.0 or later.

### 9.3.3 Extended Exadata Storage Server X9M-2 Hardware Components

Each Oracle Exadata Storage Server X9M-2 Extended (XT) server includes the following components:

- CPU: 1 x 16-core Intel Xeon 8352Y processor (2.2 GHz)
- RAM: 96 GB (6 x 16 GB DDR4 3200 MT/s DIMMs)
- Disk storage: 12 x 18 TB hard disk drives (HDD)
- Disk controller Host Bus Adapter (HBA) with 2 GB cache
- System storage: 2 x 240 GB M.2 devices
- RDMA Network Fabric: 1 x dual-port CX5 RDMA Network Fabric card; PCIe 4.0, 2 x 100 Gb/s ports active-active (200 Gb/s combined throughput)
- Administration network: 1 x 1 GbE Base-T Ethernet port
- Integrated Lights Out Manager (ILOM) port for remote management: 1 x 1 GbE Base-T Ethernet port

The X9M-2 XT storage server requires Oracle Exadata System Software release 21.2.0 or later.

### 9.3.4 Extreme Flash Exadata Storage Server X8M-2 and X8-2 Hardware Components

Oracle Exadata Storage Server X8-2 and X8M-2 Extreme Flash servers include the following components:

- 2x 16-core Intel Xeon 5218 Processors (2.3GHz)
- 192 GB RAM (12 x 16 GB DIMMs) – full 6 channels

- **X8M-2 only:** 12 x 128 GB Intel Optane™ DC Persistent Memory modules
- 8 x 6.4 TB flash accelerator PCIe cards
- 2 x 240 GB M.2 devices for system partitions (partitioned as 150 GB devices)
- **X8M-2 only:** 1 dual-port (PCIe 3.0), both ports active, 100Gb/s RDMA Network Fabric Card
- **X8-2 only:** 2 x InfiniBand 4X QDR (40 Gb/s) InfiniBand ports (1 dual-port PCIe 3.0 Host Channel Adapter (HCA)), all ports active
- 1 Ethernet port for ILOM for remote management

The X8-2 EF server requires Oracle Exadata System Software release 19.2.0 or later. The X8M-2 EF server requires Oracle Exadata System Software release 19.3.0 or later.

### 9.3.5 High Capacity Exadata Storage Server X8-2 and X8M-2 Hardware Components

Oracle Exadata Storage Server X8-2 and X8M-2 High Capacity servers include the following components:

- 2x 16-core Intel Xeon 5218 Processors (2.3GHz)
- 192 GB RAM (12 x 16 GB DIMMs) – full 6 channels
- **X8M-2 only:** 12 x 128 GB Intel Optane™ DC Persistent Memory modules
- 12 x 14 TB High Capacity SAS disks, but only 6 drives on Eighth Rack configurations
- 2 x 240 GB M.2 devices for system partitions (partitioned to appear as 150 GB devices)
- 4 x 6.4 TB flash accelerator PCIe cards
- Disk controller HBA with 2 GB cache
- **X8M-2 only:** 1 dual-port (PCIe 3.0), both ports active, 100Gb/s RDMA Network Fabric Card
- **X8-2 only:** 2 x InfiniBand 4X QDR (40 Gb/s) InfiniBand ports (1 dual-port PCIe 3.0 Host Channel Adapter (HCA)), all ports active
- 1 Ethernet port for ILOM for remote management

The X8-2 HC server requires Oracle Exadata System Software release 19.2.0 or later. The X8M-2 HC server requires Oracle Exadata System Software release 19.3.0 or later.

### 9.3.6 Extended Exadata Storage Server X8-2 and X8M-2 Hardware Components

Exadata Extended (XT) Storage Server and X8M-2 Extended (XT) servers include the following components:

- 1x 16-core Intel Xeon 5218 Processor (2.3GHz)
- 96 GB RAM (6 x 16 GB DIMMs) – full 6 channels
- 12 x 14 TB High Capacity SAS disks
- 2 x 240 GB M.2 devices for system partitions
- Disk controller HBA with 2 GB cache

- **X8M-2 only:** 1 dual-port (PCIe 3.0), both ports active, 100Gb/s RDMA Network Fabric Card
- **X8-2 only:** 2 x InfiniBand 4X QDR (40 Gb/s) InfiniBand ports (1 dual-port PCIe 3.0 Host Channel Adapter (HCA)), all ports active
- 1 Ethernet port for ILOM for remote management

The X8-2 XT server requires Oracle Exadata System Software release 19.2.0 or later. The X8M-2 XT server requires Oracle Exadata System Software release 19.3.0 or later.

## 9.3.7 Extreme Flash Exadata Storage Server X7-2 Hardware Components

Oracle Exadata Storage Server X7-2 Extreme Flash servers include the following components:

- 2x Intel Xeon Silver 4114 Processors (2.20GHz)
- 192 GB RAM (12 x 16 GB) – full 6 channels
- 8 x 6.4 TB flash accelerator PCIe cards
- 2 x 150 GB M.2 devices for system partitions
- 2 x InfiniBand 4X QDR (40 Gb/s) InfiniBand ports (1 dual-port PCIe 3.0 Host Channel Adapter (HCA)) - all ports active
- 1 Ethernet port for ILOM for remote management

Requires Oracle Exadata System Software release 18.1.0 or later.

## 9.3.8 High Capacity Exadata Storage Server X7-2 Hardware Components

Oracle Exadata Storage Server X7-2 High Capacity servers include the following components:

- 2x Intel Xeon Silver 4114 Processors (2.20GHz)
- 192 GB RAM (12 x 16 GB) – full 6 channels
- 12 x 10 TB High Capacity SAS disks
- 2 x 150 GB M.2 devices for system partitions
- 4 x 6.4 TB flash accelerator PCIe cards
- Disk controller HBA with 2 GB cache
- 2 x InfiniBand 4X QDR (40 Gb/s) InfiniBand ports (1 dual-port PCIe 3.0 Host Channel Adapter (HCA)) - all ports active
- 1 Ethernet port for ILOM for remote management

Requires Oracle Exadata System Software release 18.1.0 or later.

### 9.3.9 Extreme Flash Exadata Storage Server X6-2 Hardware Components

Oracle Exadata Storage Server X6-2 Extreme Flash servers include the following components:

- 2 x 10-Core Intel Xeon CPU E5-2630 v4 (2.2 GHz)
- 128 GB RAM (8 x 16 GB)
- 8 x 3.2 TB 2.5-inch flash accelerator F320 PCIe drives
- 2 x InfiniBand 4X QDR (40 Gb/s) InfiniBand ports (1 dual-port PCIe 3.0 Host Channel Adapter (HCA)) - all ports active
- 4 embedded Gigabit Ethernet ports
- 1 Ethernet port for ILOM for remote management

### 9.3.10 High Capacity Exadata Storage Server X6-2 Hardware Components

Oracle Exadata Storage Server X6-2 High Capacity servers include the following components:

- 2 x 10-Core Intel Xeon CPU E5-2630 v4 (2.2 GHz)
- 128 GB RAM (8 x 16 GB)
- 12 x 8 TB 7.2 K RPM High Capacity SAS disks (in earlier releases, the high capacity disks were 4 TB)
- 4 x 3.2 TB flash accelerator F320 PCIe card
- Disk controller HBA with 1 GB cache
- 2 x InfiniBand 4X QDR (40 Gb/s) InfiniBand ports (1 dual-port PCIe 3.0 Host Channel Adapter (HCA)) - all ports active
- 4 embedded Gigabit Ethernet ports
- 1 Ethernet port for ILOM for remote management

### 9.3.11 Extreme Flash Exadata Storage Server X5-2 Hardware Components

Oracle Exadata Storage Server X5-2 Extreme Flash servers include the following components:

- 2 Eight-Core Intel Xeon CPU E5-2630 v3 (2.40GHz)
- 64 GB RAM (8x 8 GB)
- 8 x 1.6 TB NVMe PCIe 3.0 SSD Extreme Flash disks
- 2 InfiniBand 4 X QDR (40 Gb/s) InfiniBand ports (1 dual-port PCIe 3.0 Host Channel Adapter (HCA))
- 4 embedded Gigabit Ethernet ports
- 1 Ethernet port for ILOM for remote management

## 9.3.12 High Capacity Exadata Storage Server X5-2 Hardware Components

Oracle Exadata Storage Server X5-2 High Capacity servers include the following components:

- 2 Eight-Core Intel Xeon CPU E5-2630 v3 (2.40GHz)
- 96 GB RAM (4x 8 GB and 4x 16 GB)
- 12 x 8 TB 7.2 K RPM High Capacity SAS disks (in earlier releases, the high capacity disks were 4 TB)
- 4 x 1.6 TB flash accelerator F160 PCIe cards
- Disk controller HBA with 1 GB supercap-backed write cache
- 2 InfiniBand 4 X QDR (40 Gb/s) InfiniBand ports (1 dual-port PCIe 3.0 Host Channel Adapter (HCA))
- 4 embedded Gigabit Ethernet ports
- 1 Ethernet port for ILOM for remote management

## 9.3.13 Exadata Storage Server X4-2L Hardware Components

Oracle Exadata Storage Server X4-2L servers include the following components:

- 2 Six-Core Intel Xeon E5-2630 v2 processors (2.6 GHz)
- 96 GB RAM (4 x 8 GB, and 4 x 16 GB))
- 12 x 1.2 TB 10 K RPM High Performance SAS disks or 12 x 4 TB 7.2 K RPM High Capacity SAS disks
- 4 x 800 GB Sun Flash Accelerator F80 PCIe Cards
- Disk controller HBA with 512 MB battery-backed write cache, and swappable BBU
- 2 InfiniBand 4 X QDR (40 Gb/s) InfiniBand ports (1 dual-port PCIe 3.0 Host Channel Adapter (HCA))
- 4 embedded Gigabit Ethernet ports
- 1 Ethernet port for ILOM for remote management

## 9.3.14 Exadata Storage Server X3-2L Hardware Components

Oracle Exadata Storage Server X3-2L servers include the following components:

- 2 Six-Core Intel Xeon E5-2630L processors (2 GHz)
- 64 GB RAM (8 x 8 GB)
- 12 x 600 GB 15 K RPM High Performance SAS disks or 12 x 3 TB 7.2 K RPM High Capacity SAS disks
- 4 x 400 GB Sun Flash Accelerator F40 PCIe Cards
- Disk controller HBA with 512 MB battery-backed write cache

- 2 InfiniBand 4 X QDR (40 Gb/s) InfiniBand ports (1 dual-port PCIe 2.0 Host Channel Adapter (HCA))
- 4 embedded Gigabit Ethernet ports
- 1 Ethernet port for ILOM for remote management

### 9.3.15 Exadata Storage Server with Sun Fire X4270 M2 Servers Hardware Components

Oracle Exadata Storage Server with Sun Fire X4270 M2 Servers include the following components:

- 2 Six-Core Intel Xeon L5640 processors (2.26 GHz)
- 24 GB RAM
- 12 x 600 GB 15 K RPM High Performance SAS disks or 12 x 3 TB 7.2 K RPM High Capacity SAS disks (in earlier releases, the high capacity disks were 2 TB)
- 4 x 96 GB Sun Flash Accelerator F20 PCIe Cards
- Disk controller HBA with 512 MB battery-backed write cache
- Dual-port 4X QDR (40 Gb/s) InfiniBand Host Channel Adapter (HCA)
- 1 embedded Gigabit Ethernet port
- 1 Ethernet port for ILOM for remote management

### 9.3.16 Exadata Storage Server with Sun Fire X4275 Servers Hardware Components

Oracle Exadata Storage Server with Sun Fire X4275 Servers include the following components:

- 2 Quad-Core Intel Xeon E5540 processors (2.53 GHz)
- 24 GB RAM
- 12 x 600 GB 15 K RPM High Performance SAS disks or 12 x 2 TB 7.2 K RPM SATA disks
- 4 x 96 GB Sun Flash Accelerator F20 PCIe Cards
- Disk controller HBA with 512 MB battery-backed write cache
- Dual-port 4X QDR (40 Gb/s) InfiniBand Host Channel Adapter (HCA)
- 1 embedded Gigabit Ethernet port
- 1 Ethernet port for ILOM for remote management

## 9.4 Spares Kit Components for Oracle Exadata Database Machine


Oracle Exadata Database Machines include a spares kit.

**Table 9-3 Spare Kit Components for Exadata Database Machine by Model**

Engineered System	Spare Kit Contents
Oracle Exadata Database Machine X9M-2 and X9M-8	<ul style="list-style-type: none"> <li>1 x 18 TB disk for High Capacity storage servers only</li> <li>1 x 6.4 TB NVMe PCI Flash card</li> </ul>
Oracle Exadata Database Machine X8M-2, X8M-8, X8-2, and X8-8 Full Rack, Half Rack, Quarter Rack, and Eighth Rack	<ul style="list-style-type: none"> <li>1 x 14 TB SAS disk for High Capacity storage servers only</li> <li>1 x Flash Accelerator F640 or F640v2 PCIe card</li> </ul>
Oracle Exadata Database Machine X7-2 and X7-8 Full Rack, Half Rack, Quarter Rack, and Eighth Rack	<ul style="list-style-type: none"> <li>1 x 10 TB 7.2 K RPM SAS disk for High Capacity storage servers only</li> <li>1 x Flash Accelerator F640 PCIe card</li> </ul>
Oracle Exadata Database Machine X6-2 Full Rack, Half Rack, Quarter Rack, and Eighth Rack	<ul style="list-style-type: none"> <li>1 x 8 TB 7.2 K RPM High Capacity SAS disk</li> <li>1 x flash accelerator F320 PCIe card for high capacity storage servers only</li> </ul>
Oracle Exadata Database Machine X5-2 Full Rack, Half Rack, Quarter Rack, and Eighth Rack	<ul style="list-style-type: none"> <li>1 x 8 TB 7.2 K RPM High Capacity SAS disk</li> <li>1 x flash accelerator F160 PCIe card for high capacity storage servers only</li> <li>1 x 1.6 TB solid-state drive for extreme flash storage servers only</li> </ul>
Oracle Exadata Database Machine X5-8 and X6-8	<ul style="list-style-type: none"> <li>1 x 8 TB 7.2 K RPM High Capacity SAS disk</li> <li>1 x flash accelerator F160 PCIe card for high capacity storage servers only</li> </ul>
Oracle Exadata Database Machine X4-2 Full Rack, Half Rack, Quarter Rack, and Eighth Rack	<ul style="list-style-type: none"> <li>1 x 1.2 TB 10 K RPM High Performance SAS disks or 1 x 4 TB 7.2 K RPM High Capacity SAS disks</li> <li>1 x 800 GB Exadata Smart Flash Cache card</li> </ul>
Oracle Exadata Database Machine X4-8	<ul style="list-style-type: none"> <li>1 x 1.6 TB NVMe PCIe 3.0 High Performance or 1 x 4 TB 7.2 K RPM High Capacity SAS disks</li> <li>1 x flash accelerator F160 PCIe card for high capacity storage servers only</li> </ul>
Oracle Exadata Database Machine X3-2 Full Rack	<ul style="list-style-type: none"> <li>2 x 600 GB 15 K RPM High Performance SAS disks or 2 x 3 TB 7.2 K RPM High Capacity SAS disks</li> <li>2 x 400 GB Exadata Smart Flash Cache cards</li> <li>6 x 3 m, and 10 x 5 m InfiniBand cables</li> </ul>
Oracle Exadata Database Machine X3-2 Half Rack	<ul style="list-style-type: none"> <li>1 x 600 GB 15 K RPM High Performance SAS disks or 1 x 3 TB 7.2 K RPM High Capacity SAS disks</li> <li>1 x 400 GB Exadata Smart Flash Cache card</li> <li>6 x 3 m, and 10 x 5 m InfiniBand cables</li> </ul>

**Table 9-3 (Cont.) Spare Kit Components for Exadata Database Machine by Model**



Engineered System	Spare Kit Contents
Oracle Exadata Database Machine X3-2 Quarter Rack and Eighth Rack	<ul style="list-style-type: none"> <li>• 1 x 600 GB 15 K RPM High Performance SAS disks or 1 x 3 TB 7.2 K RPM High Capacity SAS disks</li> <li>• 1 x 400 GB Exadata Smart Flash Cache card</li> <li>• 4 x 5 m InfiniBand cables</li> </ul>
Oracle Exadata Database Machine X3-8 Full Rack with Exadata Storage Server X4-2L Servers	<ul style="list-style-type: none"> <li>• 1 x 1.2 TB 10 K RPM High Performance SAS disks or 1 x 4 TB 7.2 K RPM High Capacity SAS disks</li> <li>• 1 x 400 GB Exadata Smart Flash Cache card</li> </ul>
Oracle Exadata Database Machine X3-8 Full Rack with Exadata Storage Server X3-2 Servers	<ul style="list-style-type: none"> <li>• 2 x 600 GB 15 K RPM High Performance SAS disks or 2 x 3 TB 7.2 K RPM High Capacity SAS disks</li> <li>• 2 x 400 GB Exadata Smart Flash Cache cards</li> <li>• 6 x 3 m, and 10 x 5 m InfiniBand cables</li> </ul>
Oracle Exadata Database Machine X2-2 and Oracle Exadata Database Machine X2-8 Full Rack	<ul style="list-style-type: none"> <li>• 2 x 600 GB 15 K RPM High Performance SAS disks or 2 x 3 TB 7.2 K RPM High Capacity SAS disks</li> <li>• 2 x 96 GB Exadata Smart Flash Cache cards</li> <li>• 6 x 3 m, and 10 x 5 m InfiniBand cables</li> </ul>

 **Note:**

The Oracle Exadata Database Machine X2-2 (with X4170 and X4275 servers) models have 2 TB High Capacity SATA drives.



**Table 9-3 (Cont.) Spare Kit Components for Exadata Database Machine by Model**

Engineered System	Spare Kit Contents
Oracle Exadata Database Machine X2-2 and Oracle Exadata Database Machine X2-8 Half Rack	<ul style="list-style-type: none"> <li>• 1 x 600 GB 15 K RPM High Performance SAS disks or 1 x 3 TB 7.2 K RPM High Capacity SAS disks</li> <li>• 1 x 96 GB Exadata Smart Flash Cache card</li> <li>• 6 x 3 m, and 10 x 5 m InfiniBand cables</li> </ul>
<div style="border-left: 2px solid #0070C0; border-right: 2px solid #0070C0; border-bottom: 2px solid #0070C0; padding: 10px;"> <p> <b>Note:</b></p> <p>The Oracle Exadata Database Machine X2-2 (with X4170 and X4275 servers) models have 2 TB High Capacity SATA drives.</p> </div>	
Oracle Exadata Database Machine X2-2 and Oracle Exadata Database Machine X2-8 Quarter Rack	<ul style="list-style-type: none"> <li>• 1 x 600 GB 15 K RPM High Performance SAS disks or 1 x 3 TB 7.2 K RPM High Capacity SAS disks</li> <li>• 1 x 96 GB Exadata Smart Flash Cache card</li> <li>• 4 x 5 m InfiniBand cables</li> </ul>
<div style="border-left: 2px solid #0070C0; border-right: 2px solid #0070C0; border-bottom: 2px solid #0070C0; padding: 10px;"> <p> <b>Note:</b></p> <p>The Oracle Exadata Database Machine X2-2 (with X4170 and X4275 servers) models have 2 TB High Capacity SATA drives.</p> </div>	

# 10

## Hardware Components of the Exadata Storage Expansion Rack

Oracle Exadata Storage Expansion Rack provides additional storage for Exadata Database Machine.

The additional storage can be used for backups, historical data, and unstructured data. Oracle Exadata Storage Expansion Racks can be used to add space to Exadata Database Machine as follows:

- Add new Oracle Exadata Storage Servers and grid disks to a new Oracle Automatic Storage Management (Oracle ASM) disk group.
- Extend existing disk groups by adding grid disks in Oracle Exadata Storage Expansion Rack.
- Split Oracle Exadata Storage Expansion Rack among multiple Exadata Database Machines.

The following sections describe the components of Oracle Exadata Storage Expansion Racks:

- [Components of Oracle Exadata Storage Expansion Rack X9M-2](#)
- [Components of Oracle Exadata Storage Expansion Rack X8M-2](#)
- [Components of Oracle Exadata Storage Expansion Rack X8-2](#)
- [Components of Oracle Exadata Storage Expansion Rack X7-2](#)
- [Components of Oracle Exadata Storage Expansion Rack X6-2](#)
- [Components of Oracle Exadata Storage Expansion Rack X5-2](#)
- [Components of Oracle Exadata Storage Expansion Rack X4-2](#)
- [Components of Oracle Exadata Storage Expansion Rack X3-2](#)
- [Components of Oracle Exadata Storage Expansion Rack with Exadata Storage Server with Sun Fire X4270 M2 Servers](#)
- [Spares Kit Components for Oracle Exadata Storage Expansion Rack](#)  
Oracle Exadata Storage Expansion Rack include a spares kit.

### 10.1 Components of Oracle Exadata Storage Expansion Rack X9M-2

Oracle Exadata Storage Expansion Rack X9M-2 includes the following components:

- Storage: Between 4 and 19 Exadata Storage Servers X9M-2.  
A base Oracle Exadata Storage Expansion Rack contains 4 High Capacity (HC) or 4 Extreme Flash (EF) storage servers. For a HC base rack, additional HC or Extended (XT)

storage servers may be added to a total of 19 storage servers. For an EF base rack, additional EF or XT storage servers may be added to a total of 19 storage servers.

Raw storage capacity:

- With HC storage servers:
  - \* 4 HC storage servers: 864 TB of raw disk capacity and 102.4 TB of raw flash capacity.
  - \* 19 HC storage servers: 4104 TB of raw disk capacity and 486.4 TB of raw flash capacity.
- With EF storage servers:
  - \* 4 EF storage servers: 204.8 TB of raw flash capacity.
  - \* 19 EF storage servers: 972.8 TB of raw flash capacity.
- With XT storage servers: up to 3240 TB of raw disk capacity, in addition to either 4 HC or 4 EF storage servers.
- RDMA Network Fabric: 3 x RoCE Network Fabric Switches
- Power Distribution Units (PDUs): 2 x 15 kVA (single phase or three phase, high voltage or low voltage)
- Network Connectivity: 1 x Management Network Switch



**Note:**

In the list above, raw capacity is expressed using standard disk drive terminology, with 1 TB = 1,000,000,000,000 bytes. Usable capacity is less.

## 10.2 Components of Oracle Exadata Storage Expansion Rack X8M-2

The Oracle Exadata Storage Expansion Rack X8M-2 includes the following components:

- At least 4 Exadata Storage Server X8M-2 servers with:
  - 6.4 TB Flash Accelerator F640 or F640v2 PCIe cards
  - (High Capacity (HC) Storage Servers only) 14 TB 7.2 K RPM High Capacity SAS disks
- 3 x RoCE Network Fabric Switches
- 2 redundant 15 kVA PDU (single phase or three phase, high voltage or low voltage)
- 1 x Management Network Switch
- 102.4 TB of raw flash capacity for HC storage servers or 204.8 TB of raw flash capacity for Extreme Flash (EF) storage servers
- 672 TB of raw capacity disks for high capacity storage servers only

(In the list above, for raw capacity, 1 GB = 1 billion bytes. Capacity is calculated using normal space terminology of 1 TB = 1024 \* 1024 \* 1024 \* 1024 bytes. Actual formatted capacity is less.)

## 10.3 Components of Oracle Exadata Storage Expansion Rack X8-2

The Oracle Exadata Storage Expansion Rack X8-2 includes the following components:

- 4 Exadata Storage Server X8-2 servers with 6.4 TB Flash Accelerator F640 or F640v2 PCIe cards, and, for High Capacity (HC) Storage Servers only, 14 TB 7.2 K RPM High Capacity SAS disks
- 3 Sun Datacenter InfiniBand Switch 36
- 2 redundant 15 kVA PDU (single phase or three phase, high voltage or low voltage)
- 1x 48-port Cisco Nexus 9348 (Cisco Nexus9000 C9348GC-FXP chassis) Ethernet switch
- 102.4 TB of raw flash capacity for HC storage servers or 204.8 TB of raw flash capacity for Extreme Flash (EF) storage servers
- 672 TB of raw capacity disks for high capacity storage servers only

(In the list above, for raw capacity, 1 GB = 1 billion bytes. Capacity is calculated using normal space terminology of 1 TB = 1024 \* 1024 \* 1024 \* 1024 bytes. Actual formatted capacity is less.)

## 10.4 Components of Oracle Exadata Storage Expansion Rack X7-2

The Oracle Exadata Storage Expansion Rack X7-2 includes the following components:

- 4 Exadata Storage Server X7-2 Servers with 6.4 TB Flash Accelerator F640 PCIe cards or 10 TB 7.2 K RPM High Capacity SAS disks
- 3 Sun Datacenter InfiniBand Switch 36
- 2 redundant 15 kVA PDU (single phase or three phase, high voltage or low voltage)
- 1x 48-port Cisco Nexus 93108-1G (Cisco Nexus9000 C93108TC-EX chassis) or 9348 (Cisco Nexus9000 C9348GC-FXP chassis) Ethernet switch
- 102.4 TB of raw flash capacity for HC storage servers or 204.8 TB of raw flash capacity for Extreme Flash (EF) storage servers
- 480 TB of raw capacity disks for high capacity storage servers only

(In the list above, for raw capacity, 1 GB = 1 billion bytes. Capacity is calculated using normal space terminology of 1 TB = 1024 \* 1024 \* 1024 \* 1024 bytes. Actual formatted capacity is less.)

## 10.5 Components of Oracle Exadata Storage Expansion Rack X6-2

Oracle Exadata Storage Expansion Rack X6-2 is available as a quarter rack. It includes the following components:

- 4 Exadata Storage Server X6-2 Servers with 3.2 TB NVMe PCIe 3.0 High Performance SSD or 8 TB 7.2 K RPM High Capacity SAS disks
- 3 Sun Datacenter InfiniBand Switch 36
- 2 redundant 15 kVA PDU (single phase or three phase, high voltage or low voltage)
- 1 48-port Cisco Catalyst 4948E-F, model number WS-C4948E-F-S Ethernet switch
- 12.8 TB of raw flash capacity for high capacity storage servers only
- 102.4 TB of raw capacity for extreme flash drives, or 384 TB of raw capacity for high capacity disks

(In the list above, for raw capacity, 1 GB = 1 billion bytes. Capacity is calculated using normal space terminology of 1 TB = 1024 \* 1024 \* 1024 \* 1024 bytes. Actual formatted capacity is less.)

## 10.6 Components of Oracle Exadata Storage Expansion Rack X5-2

Oracle Exadata Storage Expansion Rack X5-2 is available as a quarter rack. It includes the following components:

- 4 Exadata Storage Server X5-2 Servers with 1.6 TB NVMe PCIe 3.0 High Performance SSD or 8 TB 7.2 K RPM High Capacity SAS disks (in earlier releases, the high capacity disks were 4 TB)
- 3 Sun Datacenter InfiniBand Switch 36
- 2 redundant 15 kVA PDU (single phase or three phase, high voltage or low voltage)
- 1 48-port Cisco Catalyst 4948E-F, model number WS-C4948E-F-S Ethernet switch
- 12.8 TB of raw flash capacity for high capacity storage servers only
- 51.2 TB (expandable to 76.8 TB) raw storage capacity for high performance disks, or 192 TB raw capacity for high capacity disks

(In the list above, for raw capacity, 1 GB = 1 billion bytes. Capacity is calculated using normal space terminology of 1 TB = 1024 \* 1024 \* 1024 \* 1024 bytes. Actual formatted capacity is less.)

## 10.7 Components of Oracle Exadata Storage Expansion Rack X4-2

Oracle Exadata Storage Expansion Rack X4-2 is available as a full rack, half rack or quarter rack. [Table 10-1](#) lists the components included in each type of Oracle Exadata Storage Expansion Rack X4-2.

In the table below, for raw capacity, 1 GB = 1 billion bytes. Capacity is calculated using normal space terminology of 1 TB = 1024 \* 1024 \* 1024 \* 1024 bytes. Actual formatted capacity is less.

**Table 10-1 Components of Oracle Exadata Storage Expansion Rack X4-2**

Rack	Components
Oracle Exadata Storage Expansion X4-2 Full Rack	<ul style="list-style-type: none"> <li>• 18 Exadata Storage Server X4-2L Servers with 1.2 TB 10 K RPM High Performance SAS disks or 4 TB 7.2 K RPM High Capacity SAS disks</li> <li>• 3 Sun Datacenter InfiniBand Switch 36</li> <li>• 2 redundant 15 kVA PDU (single phase or three phase, high voltage or low voltage)</li> <li>• 1 48-port Cisco Catalyst 4948E-F, model number WS-C4948E-F-S Ethernet switch</li> <li>• 57.6 TB of raw flash capacity</li> <li>• 258 TB raw storage capacity for high performance disks, or 864 TB raw capacity for high capacity disks</li> </ul>
Oracle Exadata Storage Expansion X4-2 Half Rack	<ul style="list-style-type: none"> <li>• 9 Exadata Storage Server X4-2L Servers with 1.2 TB 10 K RPM High Performance SAS disks or 4 TB 7.2 K RPM High Capacity SAS disks</li> <li>• 3 Sun Datacenter InfiniBand Switch 36</li> <li>• 2 redundant 15 kVA PDUs (single phase or three phase, high voltage or low voltage)</li> <li>• 1 48-port Cisco Catalyst 4948E-F, model number WS-C4948E-F-S Ethernet switch</li> <li>• 28.8 TB of raw flash capacity</li> <li>• 129 TB raw storage capacity for high performance disks, or 432 TB raw capacity for high capacity disks</li> </ul>
Oracle Exadata Storage Expansion X4-2 Quarter Rack	<ul style="list-style-type: none"> <li>• 4 Exadata Storage Server X4-2L Servers with 1.2 TB 10 K RPM High Performance SAS disks or 4 TB 7.2 K RPM High Capacity SAS disks</li> <li>• 3 Sun Datacenter InfiniBand Switch 36</li> <li>• 2 redundant 15 kVA PDUs (single phase or three phase, high voltage or low voltage)</li> <li>• 1 48-port Cisco Catalyst 4948E-F, model number WS-C4948E-F-S Ethernet switch</li> <li>• 12.8 TB of raw flash capacity</li> <li>• 57 TB raw storage capacity for high performance disks, or 192 TB raw capacity for high capacity disks</li> </ul>

## 10.8 Components of Oracle Exadata Storage Expansion Rack X3-2

Oracle Exadata Storage Expansion Rack X3-2 is available as a full rack, half rack or quarter rack. [Table 10-2](#) lists the components included in each type of Oracle Exadata Storage Expansion Rack X3-2.

In the table below, for raw capacity, 1 GB = 1 billion bytes. Capacity is calculated using normal space terminology of 1 TB = 1024 \* 1024 \* 1024 \* 1024 bytes. Actual formatted capacity is less.

**Table 10-2 Components of Spares Kit for Oracle Exadata Database Machine X3-2**

Rack	Components
Oracle Exadata Storage Expansion X3-2 Full Rack	<ul style="list-style-type: none"> <li>• 18 Exadata Storage Server X3-2 Servers with 600 GB 15 K RPM High Performance SAS disks or 3 TB 7.2 K RPM High Capacity SAS disks</li> <li>• 3 Sun Datacenter InfiniBand Switch 36</li> <li>• 2 redundant 15 kVA PDU (single phase or three phase, high voltage or low voltage)</li> <li>• 1 48-port Cisco Catalyst 4948E-F, model number WS-C4948E-F-S Ethernet switch</li> <li>• 28.8 TB of raw flash capacity</li> <li>• 128 TB raw storage capacity for high performance disks, or 648 TB raw capacity for high capacity disks</li> </ul>
Oracle Exadata Storage Expansion X3-2 Half Rack	<ul style="list-style-type: none"> <li>• 9 Exadata Storage Server X3-2 Servers with 600 GB 15 K RPM High Performance SAS disks or 3 TB 7.2 K RPM High Capacity SAS disks</li> <li>• 3 Sun Datacenter InfiniBand Switch 36</li> <li>• 2 redundant 15 kVA PDUs (single phase or three phase, high voltage or low voltage)</li> <li>• 1 48-port Cisco Catalyst 4948E-F, model number WS-C4948E-F-S Ethernet switch</li> <li>• 14.4 TB of raw flash capacity</li> <li>• 64 TB raw storage capacity for high performance disks, or 324 TB raw capacity for high capacity disks</li> </ul>

**Table 10-2 (Cont.) Components of Spares Kit for Oracle Exadata Database Machine X3-2**

Rack	Components
Oracle Exadata Storage Expansion X3-2 Quarter Rack	<ul style="list-style-type: none"> <li>• 4 Exadata Storage Server X3-2 Servers with 600 GB 15 K RPM High Performance SAS disks or 3 TB 7.2 K RPM High Capacity SAS disks</li> <li>• 3 Sun Datacenter InfiniBand Switch 36</li> <li>• 2 redundant 15 kVA PDUs (single phase or three phase, high voltage or low voltage)</li> <li>• 1 48-port Cisco Catalyst 4948E-F, model number WS-C4948E-F-S Ethernet switch</li> <li>• 6.4 TB of raw flash capacity</li> <li>• 28 TB raw storage capacity for high performance disks, or 144 TB raw capacity for high capacity disks</li> </ul>

## 10.9 Components of Oracle Exadata Storage Expansion Rack with Exadata Storage Server with Sun Fire X4270 M2 Servers

Oracle Exadata Storage Expansion Rack with Exadata Storage Server with Sun Fire X4270 M2 Servers is available as a full rack, half rack or quarter rack. [Table 10-3](#) lists the components included in each type of Oracle Exadata Storage Expansion Rack with Exadata Storage Server with Sun Fire X4270 M2 Servers.

**Table 10-3 Components of Oracle Exadata Storage Expansion Racks with Exadata Storage Server with Sun Fire X4270 M2 Servers**

Rack	Components
Oracle Exadata Storage Expansion Full Rack	<ul style="list-style-type: none"> <li>• 18 Exadata Storage Server with Sun Fire X4270 M2 Servers with 600 GB 15 K RPM High Performance SAS disks or 3 TB 7.2 K RPM High Capacity SAS disks (in earlier releases, the high capacity disks were 2 TB)</li> <li>• 3 Sun Datacenter InfiniBand Switch 36</li> <li>• 6.75 TB high speed flash</li> <li>• Keyboard, video, and mouse (KVM) hardware</li> <li>• 2 redundant 15 kVA PDU (single phase or three phase, high voltage or low voltage)</li> <li>• 1 48-port Cisco Catalyst 4948, model number WS-C4948-S Ethernet switch</li> </ul>



**Table 10-3 (Cont.) Components of Oracle Exadata Storage Expansion Racks with Exadata Storage Server with Sun Fire X4270 M2 Servers**

Rack	Components
Oracle Exadata Storage Expansion Half Rack	<ul style="list-style-type: none"> <li>• 9 Exadata Storage Server with Sun Fire X4270 M2 Servers with 600 GB 15 K RPM High Performance SAS disks or 3 TB 7.2 K RPM High Capacity SAS disks (in earlier releases, the high capacity disks were 2 TB)</li> <li>• 3 Sun Datacenter InfiniBand Switch 36</li> <li>• 3.4 TB high speed flash</li> <li>• Keyboard, video, and mouse (KVM) hardware</li> <li>• 2 redundant 15 kVA PDUs (single phase or three phase, high voltage or low voltage)</li> <li>• 1 48-port Cisco Catalyst 4948, model number WS-C4948-S Ethernet switch</li> </ul>
Oracle Exadata Storage Expansion Quarter Rack	<ul style="list-style-type: none"> <li>• 4 Exadata Storage Server with Sun Fire X4270 M2 Servers with 600 GB 15 K RPM High Performance SAS disks or 3 TB 7.2 K RPM High Capacity SAS disks (in earlier releases, the high capacity disks were 2 TB)</li> <li>• 3 Sun Datacenter InfiniBand Switch 36</li> <li>• 1.5 TB high speed flash</li> <li>• Keyboard, video, and mouse (KVM) hardware</li> <li>• 2 redundant 15 kVA PDUs (single phase or three phase, high voltage or low voltage)</li> <li>• 1 48-port Cisco Catalyst 4948, model number WS-C4948-S Ethernet switch</li> </ul>

## 10.10 Spares Kit Components for Oracle Exadata Storage Expansion Rack

Oracle Exadata Storage Expansion Rack include a spares kit.

**Table 10-4 Spares Kit Contents by Exadata Storage Server Model**

Engineered System	Spare Kit Contents
Oracle Exadata Storage Expansion Rack X9M-2	<ul style="list-style-type: none"> <li>• 1 x 18 TB disk for High Capacity storage servers only</li> <li>• 1 x 6.4 TB NVMe PCI Flash card</li> </ul>
Oracle Exadata Storage Expansion Rack X8-2 and X8M-2	<ul style="list-style-type: none"> <li>• 1x 14 TB 7.2K RPM High Capacity SAS disk</li> <li>• 1x Flash Accelerator F640 or F640v2 PCIe card</li> </ul>
Oracle Exadata Storage Expansion Rack X7-2	<ul style="list-style-type: none"> <li>• 1x 10 TB 7.2K RPM High Capacity SAS disk</li> <li>• 1x Flash Accelerator F640 PCIe card</li> </ul>

**Table 10-4 (Cont.) Spares Kit Contents by Exadata Storage Server Model**

Engineered System	Spare Kit Contents
Oracle Exadata Storage Expansion Rack X6-2 Full Rack, Half Rack, and Quarter Rack	<ul style="list-style-type: none"> <li>• 1 x 3.2 TB NVMe PCIe 3.0 High Performance SSD or 1 x 8 TB 7.2 K RPM High Capacity SAS disks</li> <li>• 1 x flash accelerator F320 PCIe card for high capacity storage servers only</li> </ul>
Oracle Exadata Storage Expansion Rack X5-2 Full Rack, Half Rack, and Quarter Rack	<ul style="list-style-type: none"> <li>• 1 x 1.6 TB NVMe PCIe 3.0 High Performance SSD or 1 x 8 TB 7.2 K RPM High Capacity SAS disks</li> <li>• 1 x flash accelerator F160 PCIe card for high capacity storage servers only</li> </ul>
Oracle Exadata Storage Expansion Rack X4-2 Full Rack, Half Rack, and Quarter Rack	<ul style="list-style-type: none"> <li>• 1 x 1.2 TB 10 K RPM High Performance SAS disks or 1 x 4 TB 7.2 K RPM High Capacity SAS disks</li> <li>• 1 x 800 GB Exadata Smart Flash Cache card</li> </ul>
Oracle Exadata Storage Expansion Rack X3-2 Full Rack	<ul style="list-style-type: none"> <li>• 2 x 600 GB 15 K RPM High Performance SAS disks or 2 x 3 TB 7.2 K RPM High Capacity SAS disks</li> <li>• 2 x 400 GB Exadata Smart Flash Cache cards</li> <li>• 6 x 3 m, and 10 x 5 m InfiniBand cables</li> </ul>
Oracle Exadata Storage Expansion Rack X3-2 Half Rack	<ul style="list-style-type: none"> <li>• 1 x 600 GB 15 K RPM High Performance SAS disks or 1 x 3 TB 7.2 K RPM High Capacity SAS disks</li> <li>• 1 x 400 GB Exadata Smart Flash Cache card</li> <li>• 6 x 3 m, and 10 x 5 m InfiniBand cables</li> </ul>
Oracle Exadata Storage Expansion Rack X3-2 Quarter Rack	<ul style="list-style-type: none"> <li>• 1 x 600 GB 15 K RPM High Performance SAS disks or 1 x 3 TB 7.2 K RPM High Capacity SAS disks</li> <li>• 1 x 400 GB Exadata Smart Flash Cache card</li> <li>• 4 x 5 m InfiniBand cables</li> </ul>
Oracle Exadata Storage Expansion Rack with Oracle Exadata Storage Server with Sun Fire X4270 M2 Servers Full Rack	<ul style="list-style-type: none"> <li>• 2 x 600 GB 15 K RPM High Performance SAS disks or 2 x 3 TB 7.2 K RPM High Capacity SAS disks</li> <li>• 2 x 96 GB Exadata Smart Flash Cache cards</li> <li>• 6 x 3 m, and 10 x 5 m InfiniBand cables</li> </ul>
Oracle Exadata Storage Expansion Rack with Oracle Exadata Storage Server with Sun Fire X4270 M2 Servers Half Rack	<ul style="list-style-type: none"> <li>• 1 x 600 GB 15 K RPM High Performance SAS disks or 1 x 3 TB 7.2 K RPM High Capacity SAS disks</li> <li>• 1 x 96 GB Exadata Smart Flash Cache cards</li> <li>• 6 x 3 m, and 10 x 5 m InfiniBand cables</li> </ul>

**Table 10-4 (Cont.) Spares Kit Contents by Exadata Storage Server Model**

<b>Engineered System</b>	<b>Spare Kit Contents</b>
Oracle Exadata Storage Expansion Rack with Oracle Exadata Storage Server with Sun Fire X4270 M2 Servers Quarter Rack	<ul style="list-style-type: none"><li>• 1 x 600 GB 15 K RPM High Performance SAS disks or 1 x 3 TB 7.2 K RPM High Capacity SAS disks</li><li>• 1 x 96 GB Exadata Smart Flash Cache cards</li><li>• 4 x 5m InfiniBand cables</li></ul>

# Part III

## Cabling Information for Oracle Exadata Database Machine

Oracle Exadata Database Machine has different cabling tables depending on the hardware model.

- [Cabling Tables for Exadata Database Machine X9M](#)  
This section shows the cable layouts for Exadata Database Machine X9M-2 and X9M-8.
- [Cabling Tables for Exadata Database Machine X8M](#)  
These tables show the cable layouts for Exadata Database Machine X8M-2 and X8M-8.
- [Cabling Tables for Oracle Exadata Database Machine X8-2, X8-8, X7-2, and X7-8](#)
- [Cabling Tables for Oracle Exadata Database Machine X6-2, X6-8, X5-2, and X5-8](#)  
The tables in this chapter show the cable layouts for Oracle Exadata Database Machine X6-2, X6-8, X5-2, and X5-8.
- [Cabling Tables for Oracle Exadata Database Machine X4-2 and Oracle Exadata Database Machine X4-8 Full Rack](#)  
The tables in this chapter show the cable layouts for Oracle Exadata Database Machine X4-2, and Oracle Exadata Database Machine X4-8 Full Rack.
- [Cabling Tables for Oracle Exadata Database Machine X3-2 and Oracle Exadata Database Machine X3-8 Full Rack](#)  
The tables in this chapter show the cable layouts for Oracle Exadata Database Machine X3-2 and Oracle Exadata Database Machine X3-8 Full Rack.
- [Cabling Tables for Oracle Exadata Database Machine X2-2 and Oracle Exadata Database Machine X2-8 Full Rack](#)  
The tables in this chapter show the cable layouts for Oracle Exadata Database Machine X2-2 and Oracle Exadata Database Machine X2-8 Full Rack.
- [Cabling Tables for Oracle Exadata Storage Expansion Rack X9M-2](#)  
This section shows the cable layouts for Oracle Exadata Storage Expansion Rack X9M-2.
- [Cabling Tables for Oracle Exadata Storage Expansion Rack X8M and Earlier](#)

# 11

## Cabling Tables for Exadata Database Machine X9M

This section shows the cable layouts for Exadata Database Machine X9M-2 and X9M-8.

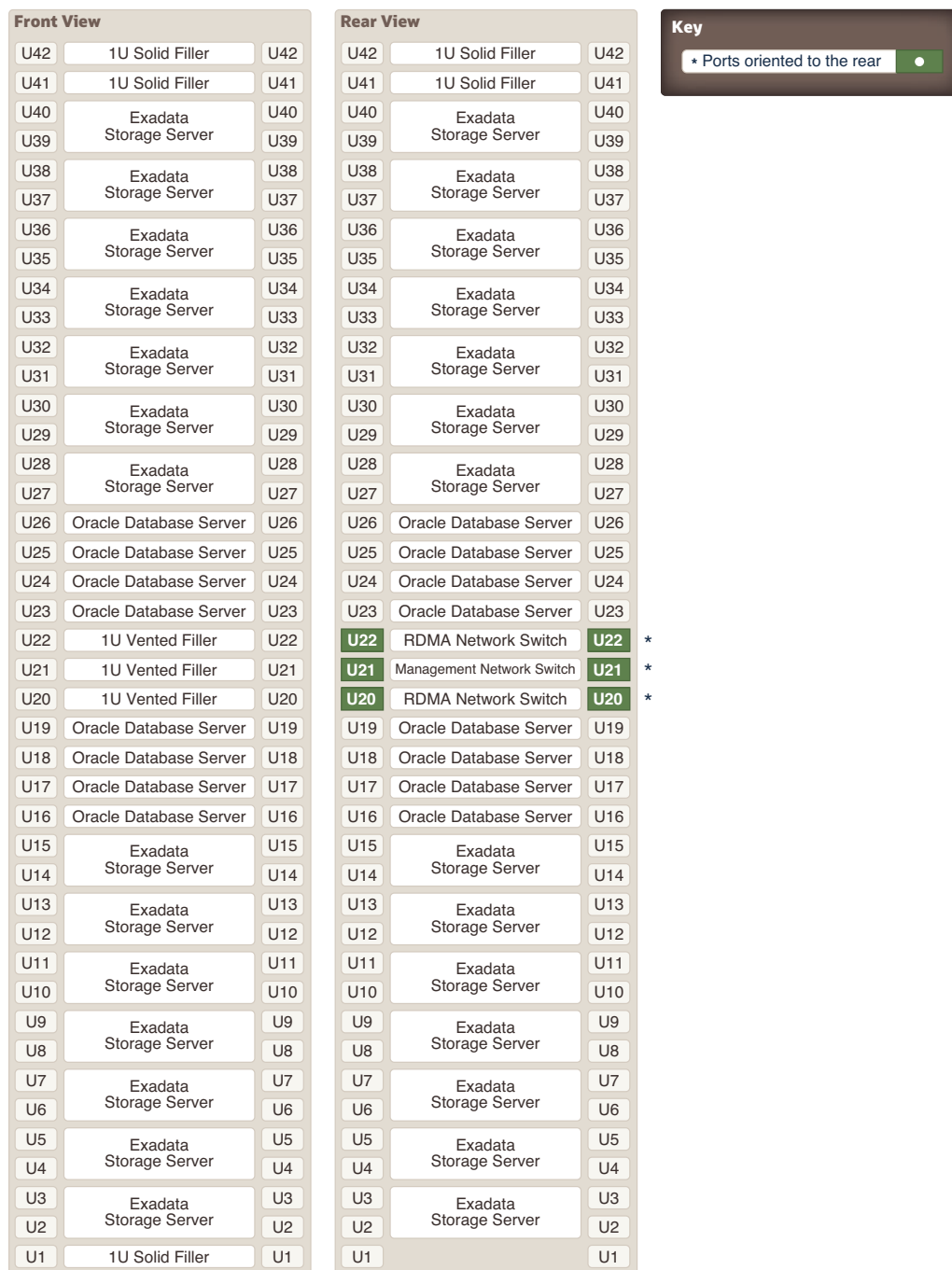
- [Rack Layout](#)  
This topic shows the rack layout for Exadata Database Machine X9M-2 and X9M-8.
- [Integrated Lights Out Manager \(ILOM\) Cabling](#)  
This topic contains the tables for the ILOM network cabling in Exadata Database Machine X9M.
- [Administrative Ethernet Port Cabling](#)  
This topic describes the administrative network cabling in Exadata Database Machine X9M.
- [Single Phase Power Distribution Unit Cabling](#)  
The following describes the cabling routes from each single-phase power distribution unit (PDU) to the component power supplies in Exadata Database Machine X9M-2 and X9M-8.
- [Three-Phase Power Distribution Unit Cabling](#)  
The following describes the cabling routes from each three-phase power distribution unit (PDU) to the component power supplies in Exadata Database Machine X9M-2 and X9M-8.
- [RDMA Network Fabric Network Cabling](#)  
The following describes RDMA Network Fabric cabling for Exadata Database Machine X9M-2 and X9M-8.

### 11.1 Rack Layout

This topic shows the rack layout for Exadata Database Machine X9M-2 and X9M-8.

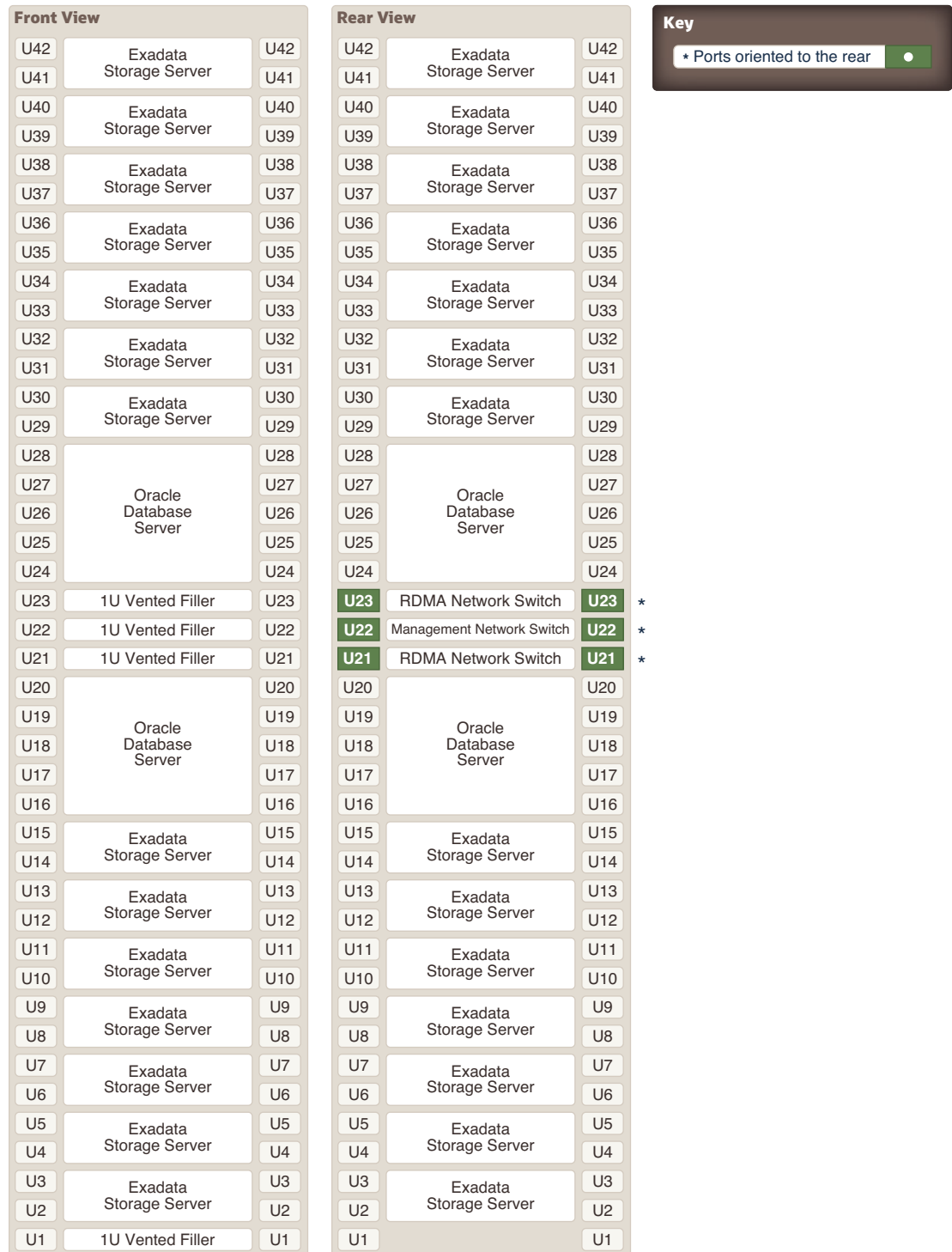
The following image shows the front and rear views of the component positioning in Exadata Database Machine X9M-2 Full Rack. The front view is shown on the left, and the rear view is shown on the right.

**Figure 11-1 Rack Layout of Exadata Database Machine X9M-2 Full Rack**



The following image shows the front and rear views of the component positioning in Exadata Database Machine X9M-8.

**Figure 11-2 Rack Layout of Exadata Database Machine X9M-8**



## 11.2 Integrated Lights Out Manager (ILOM) Cabling

This topic contains the tables for the ILOM network cabling in Exadata Database Machine X9M.

The following tables are in this section:

- [Table 11-1](#) ILOM Cabling for Exadata Database Machine X9M-2 Full Rack
- [Table 11-2](#) ILOM Cabling for Exadata Database Machine X9M-8 Full Rack

In the following tables, *Un* denotes the unit height in the rack, where *n* is the number, such as U20. The cables used for ILOM are red in color.

The following table shows the cable connections from the ILOM port (NET MGT) on the servers to the Management Network Switch:

**Table 11-1 ILOM Cabling for Exadata Database Machine X9M-2 Full Rack**

From Rack Unit	Type of Equipment	Management Network Switch Port
U39	Storage Server	2
U37	Storage Server	4
U35	Storage Server	6
U33	Storage Server	8
U31	Storage Server	10
U29	Storage Server	12
U27	Storage Server	14
U26	Database server	16
U25	Database server	18
U24	Database server	20
U23	Database server	22
U22 (NET MGT 0)	Leaf switch	45
U20 (NET MGT 0)	Leaf switch	46
U19	Database server	24
U18	Database server	26
U17	Database server	28
U16	Database server	30
U14	Storage Server	32
U12	Storage Server	34
U10	Storage Server	36
U8	Storage Server	38
U6	Storage Server	40
U4	Storage Server	42
U2	Storage Server	44

The following table shows the cable connections from the ILOM port on the servers to the Management Network Switch:



**Table 11-2 ILOM Cabling for Exadata Database Machine X9M-8 Full Rack**

From Rack Unit	Type of Equipment	Management Network Switch Port
U41	Storage Server	2
U39	Storage Server	4
U37	Storage Server	6
U35	Storage Server	8
U33	Storage Server	10
U31	Storage Server	12
U29	Storage Server	14
U24	Database server	16
U16	Database server	18
U14	Storage Server	20
U12	Storage Server	22
U10	Storage Server	24
U8	Storage Server	26
U6	Storage Server	28
U4	Storage Server	30
U2	Storage Server	32

## 11.3 Administrative Ethernet Port Cabling

This topic describes the administrative network cabling in Exadata Database Machine X9M.

The Management Network Switch is located in rack unit 21 on Exadata Database Machine X9M-2 racks and in rack unit 22 on Exadata Database Machine X9M-8 racks.

In the following tables, *Un* denotes the unit height in the rack, where *n* is the number, such as U20. The cables used for the Management Network Switch are blue in color. The following tables are in this section:

- [Table 11-3](#) Administrative Network Cabling for Exadata Database Machine X9M-2 Full Rack
- [Table 11-4](#) Administrative Network Cabling for Exadata Database Machine X9M-8 Full Rack

**Table 11-3 Administrative Network Cabling for Exadata Database Machine X9M-2 Full Rack**

From Rack Unit	Type of Equipment	Management Network Switch Port
U39	Storage Server	1
U37	Storage Server	3
U35	Storage Server	5

**Table 11-3 (Cont.) Administrative Network Cabling for Exadata Database Machine X9M-2 Full Rack**

From Rack Unit	Type of Equipment	Management Network Switch Port
U33	Storage Server	7
U31	Storage Server	9
U29	Storage Server	11
U27	Storage Server	13
U26	Database server	15
U25	Database server	17
U24	Database server	19
U23	Database server	21
U22	RDMA Network Fabric Switch	45
U20	RDMA Network Fabric Switch	46
U19	Database server	23
U18	Database server	25
U17	Database server	27
U16	Database server	29
U14	Storage Server	31
U12	Storage Server	33
U10	Storage Server	35
U8	Storage Server	37
U6	Storage Server	39
U4	Storage Server	41
U2	Storage Server	43
U1	RDMA Network Fabric Switch Note that the spine switch is not included by default on Exadata Database Machine X9M-2 racks, but port 47 is still reserved on the Management Network Switch for the spine RDMA Network Fabric switch.	47

**Table 11-4 Administrative Network Cabling for Exadata Database Machine X9M-8 Full Rack**

From Rack Unit	Type of Equipment	Management Network Switch Port
U41	Storage Server	1
U39	Storage Server	3
U37	Storage Server	5

**Table 11-4 (Cont.) Administrative Network Cabling for Exadata Database Machine X9M-8 Full Rack**

From Rack Unit	Type of Equipment	Management Network Switch Port
U35	Storage Server	7
U33	Storage Server	9
U31	Storage Server	11
U29	Storage Server	13
U24	Database server	15
U23	RDMA Network Fabric Switch	33
U21	RDMA Network Fabric Switch	34
U16	Database server	17
U14	Storage Server	19
U12	Storage Server	21
U10	Storage Server	23
U8	Storage Server	25
U6	Storage Server	27
U4	Storage Server	29
U2	Storage Server	31
U1	RDMA Network Fabric Switch Note that the spine switch is not included by default on Exadata Database Machine X9M-8 racks, but port 47 is still reserved on the Management Network Switch for the spine RDMA Network Fabric switch.	35

## 11.4 Single Phase Power Distribution Unit Cabling

The following describes the cabling routes from each single-phase power distribution unit (PDU) to the component power supplies in Exadata Database Machine X9M-2 and X9M-8.

- [Single Phase PDU Cabling for Exadata Database Machine X9M-2 Full Rack](#)  
Single phase cabling for the Exadata Database Machine X9M-2 Full Rack routes from each power distribution unit (PDU) to the power supplies on each server or switch.
- [Single Phase PDU Cabling for Exadata Database Machine X9M-8 Full Rack](#)  
Single phase cabling for the Exadata Database Machine X9M-8 Full Rack routes from each power distribution unit (PDU) to the power supplies on each server or switch.

## 11.4.1 Single Phase PDU Cabling for Exadata Database Machine X9M-2 Full Rack

Single phase cabling for the Exadata Database Machine X9M-2 Full Rack routes from each power distribution unit (PDU) to the power supplies on each server or switch.

The cables are terminated to PDU-A on the left (when looking at the rear of the rack), and routed to the right to enter the cable management arm (CMA). The cables are bundled in groups of four. The PDU connections list the group and outlet on the PDU. So, for example, G5-5 refers to group 5 outlet 5.

**Table 11-5 Single Phase PDU Cabling for Exadata Database Machine X9M-2 Full Rack**

Rack Slot	PSU 0 to PDU-A Outlet	PSU 1 to PDU-B Outlet	Cable Length
U42	G5-6	G0-0	3 meters
U41	G4-6	G1-0	3 meters
U40	G4-2	G1-4	3 meters
U39	G4-4	G1-2	3 meters
U37	G1-5	G4-1	3 meters
U35	G3-1	G2-5	3 meters
U33	G1-3	G4-3	3 meters
U31	G3-3	G2-3	3 meters
U29	G4-0	G1-6	3 meters
U27	G5-2	G0-4	3 meters
U26	G0-6	G5-0	3 meters
U25	G3-0	G2-6	3 meters
U24	G4-1	G1-5	3 meters
U23	G5-0	G0-6	3 meters
U22	G1-6	G4-0	3 meters
U21	G0-4	G5-2	3 meters
U20	G0-3	G5-3	3 meters
U19	G3-2	G2-4	3 meters
U18	G2-5	G3-1	3 meters
U17	G1-2	G4-4	3 meters
U16	G1-4	G4-2	3 meters
U14	G5-3	G0-3	3 meters
U12	G5-4	G0-2	3 meters
U10	G2-3	G3-3	3 meters
U08	G2-4	G3-2	3 meters
U06	G2-6	G3-0	3 meters
U04	G0-2	G5-4	3 meters
U02	G0-5	G5-1	3 meters
U01	G4-3	G1-3	3 meters

## 11.4.2 Single Phase PDU Cabling for Exadata Database Machine X9M-8 Full Rack

Single phase cabling for the Exadata Database Machine X9M-8 Full Rack routes from each power distribution unit (PDU) to the power supplies on each server or switch.

The cables are terminated to PDU-A on the left (when looking at the rear of the rack), and routed to the right to enter the cable management arm (CMA). The cables are bundled in groups of four. The PDU connections in the table below list the group and outlet on the PDU. So, for example, G5-5 refers to group 5 outlet 5.

**Table 11-6 Single Phase PDU Cabling for Exadata Database Machine X9M-8 Full Rack**

Rack Slot	PSU to PDU-A	PDU-A Outlet	PSU to PDU-B	PDU-B Outlet	Cable Length
U41	PS0	G3-5	PS1	G2-1	3 meters
U39	PS0	G4-6	PS1	G1-0	3 meters
U37	PS0	G5-2	PS1	G0-4	3 meters
U35	PS0	G5-0	PS1	G0-6	3 meters
U33	PS0	G2-5	PS1	G3-1	3 meters
U31	PS0	G4-3	PS1	G1-3	3 meters
U29	PS0	G3-6	PS1	G2-0	3 meters
U24	PS2	G2-7	PS3	G3-7	2 meters
U24	PS0	G0-7	PS1	G5-7	2 meters
U23	PS2	G3-1	PS1	G2-5	2 meters
U22	PS2	G2-6	PS1	G3-0	2 meters
U21	PS2	G1-6	PS1	G4-0	2 meters
U16	PS2	G1-7	PS3	G4-7	2 meters
U16	PS0	G3-7	PS1	G2-7	2 meters
U14	PS0	G5-1	PS1	G0-5	3 meters
U12	PS0	G4-1	PS1	G1-5	3 meters
U10 (with 2 DB servers)	PS0	G4-4	PS1	G1-2	3 meters
U10 (with 3 DB servers)	PS2	G4-7	PS3	G1-7	2 meters
U10 (with 3 DB servers)	PS0	G5-7	PS1	G0-7	2 meters
U08	PS0	G0-6	PS1	G5-0	3 meters
U06	PS0	G1-1	PS1	G4-5	3 meters
U04	PS0	G1-0	PS1	G4-6	3 meters
U02	PS0	G0-1	PS1	G5-5	3 meters
U01	PS2	G4-0	PS1	G1-6	3 meters

## 11.5 Three-Phase Power Distribution Unit Cabling

The following describes the cabling routes from each three-phase power distribution unit (PDU) to the component power supplies in Exadata Database Machine X9M-2 and X9M-8.

- [Three-Phase PDU Cabling for Exadata Database Machine X9M-2 Full Rack](#)  
Three-phase cabling for the Exadata Database Machine X9M-2 Full Rack routes from each power distribution unit (PDU) to the power supplies on each server or switch.
- [Three Phase PDU Cabling for Exadata Database Machine X9M-8 Full Rack](#)  
Three-phase cabling for the Exadata Database Machine X9M-8 Full Rack routes from each power distribution unit (PDU) to the power supplies on each server or switch.

## 11.5.1 Three-Phase PDU Cabling for Exadata Database Machine X9M-2 Full Rack

Three-phase cabling for the Exadata Database Machine X9M-2 Full Rack routes from each power distribution unit (PDU) to the power supplies on each server or switch.

The cables are terminated to PDU-A on the left (when looking at the rear of the rack), and routed to the right to enter the cable management arm (CMA). The cables are bundled in groups of four. The PDU connections list the group and outlet on the PDU. So, for example, G5-5 refers to group 5 outlet 5.

**Table 11-7 Three Phase PDU Cabling for Exadata Database Machine X9M-2 Full Rack**

Rack Slot	PSU 0 to PDU-A Outlet	PSU 1 to PDU-B Outlet	Cable Length
U42	G5-4	G2-2	3 meters
U41	G5-2	G2-4	3 meters
U40	G5-1	G2-5	3 meters
U39	G4-6	G1-0	3 meters
U37	G4-1	G1-5	3 meters
U35	G4-5	G1-1	3 meters
U33	G5-5	G2-1	3 meters
U31	G4-2	G1-4	3 meters
U29	G5-3	G2-3	3 meters
U27	G3-2	G0-4	3 meters
U26	G5-0	G2-6	3 meters
U25	G3-0	G0-6	3 meters
U24	G3-1	G0-5	3 meters
U23	G3-5	G0-1	3 meters
U22	G1-6	G4-0	3 meters
U21	G2-6	G5-0	3 meters
U20	G1-5	G4-1	3 meters
U19	G1-1	G4-5	3 meters
U18	G1-4	G4-2	3 meters
U17	G2-1	G5-5	3 meters
U16	G1-3	G4-3	3 meters
U14	G0-5	G3-1	3 meters
U12	G2-5	G5-1	3 meters

**Table 11-7 (Cont.) Three Phase PDU Cabling for Exadata Database Machine X9M-2 Full Rack**

Rack Slot	PSU 0 to PDU-A Outlet	PSU 1 to PDU-B Outlet	Cable Length
U10	G0-3	G3-3	3 meters
U08	G2-3	G5-3	3 meters
U06	G2-4	G5-2	3 meters
U04	G0-6	G3-0	3 meters
U02	G0-0	G3-6	3 meters
U01	G1-0	G4-6	3 meters

## 11.5.2 Three Phase PDU Cabling for Exadata Database Machine X9M-8 Full Rack

Three-phase cabling for the Exadata Database Machine X9M-8 Full Rack routes from each power distribution unit (PDU) to the power supplies on each server or switch.

The cables are terminated to PDU-A on the left (when looking at the rear of the rack), and routed to the right to enter the cable management arm (CMA). The cables are bundled in groups of four. The PDU connections list the group and outlet on the PDU. So, for example, G5-5 refers to group 5 outlet 5.

**Table 11-8 Three Phase PDU Cabling for Exadata Database Machine X9M-8 Full Rack**

Rack Slot	PSU to PDU-A	PDU-A Outlet	PSU to PDU-B	PDU-B Outlet	Cable Length
U41	PS0	G5-5	PS1	G2-1	3 meters
U39	PS0	G5-4	PS1	G2-2	3 meters
U37	PS0	G5-2	PS1	G2-4	3 meters
U35	PS0	G2-4	PS1	G5-2	3 meters
U33	PS0	G3-6	PS1	G0-0	3 meters
U31	PS0	G4-6	PS1	G1-0	3 meters
U29	PS0	G4-4	PS1	G1-2	3 meters
U24	PS2	G3-7	PS3	G0-7	2 meters
U24	PS0	G4-7	PS1	G1-7	2 meters
U23	PS2	G3-1	PS1	G0-5	2 meters
U22	PS2	G3-0	PS1	G0-6	2 meters
U21	PS2	G2-5	PS1	G5-1	2 meters
U16	PS2	G2-7	PS3	G5-7	2 meters
U16	PS0	G1-7	PS1	G4-7	2 meters
U14	PS0	G2-6	PS1	G5-0	3 meters
U12	PS0	G1-0	PS1	G4-6	3 meters
U10 (with 2 DB servers)	PS0	G0-6	PS1	G3-0	3 meters
U10 (with 3 DB servers)	PS2	G5-7	PS3	G2-7	2 meters
U10 (with 3 DB servers)	PS0	G0-7	PS1	G3-7	2 meters

**Table 11-8 (Cont.) Three Phase PDU Cabling for Exadata Database Machine X9M-8 Full Rack**

Rack Slot	PSU to PDU-A	PDU-A Outlet	PSU to PDU-B	PDU-B Outlet	Cable Length
U08	PS0	G0-5	PS1	G3-1	3 meters
U06	PS0	G1-1	PS1	G4-5	3 meters
U04	PS0	G0-2	PS1	G3-4	3 meters
U02	PS0	G0-1	PS1	G3-5	3 meters
U01	PS2	G0-0	PS1	G3-6	3 meters

## 11.6 RDMA Network Fabric Network Cabling

The following describes RDMA Network Fabric cabling for Exadata Database Machine X9M-2 and X9M-8.

- [RDMA Network Fabric Cabling for Exadata Database Machine X9M-2](#)  
This topic contains RDMA Network Fabric cabling details for Exadata Database Machine X9M-2.
- [RDMA Network Fabric Cabling for Exadata Database Machine X9M-8](#)  
This topic contains RDMA Network Fabric cabling details for Exadata Database Machine X9M-8.

### 11.6.1 RDMA Network Fabric Cabling for Exadata Database Machine X9M-2

This topic contains RDMA Network Fabric cabling details for Exadata Database Machine X9M-2.

The RoCE Network Fabric switches are located in rack units 20 and 22 for Exadata Database Machine X9M-2.

You can use the following tables for both flexible and fixed configurations. This first table contains RDMA Network Fabric cabling information for the database servers, each of which occupies 1RU. The second table covers the storage servers, each of which occupies 2RU. The last table contains the inter-switch cabling between the leaf switches.

#### Note:

Not all the slots shown in the tables below will be used in a single configuration. Match the rack component with the appropriate slot in the tables below to determine how to cable that particular component.

In the following tables,  $Un$  denotes the slot in the rack, where  $n$  is the number, such as U20.  $Pn$  denotes the RDMA Network Fabric port  $n$ , where  $n$  is port number, such as P1. The cables used for the RDMA Network Fabric switch are black in color. The following tables are in this section:



- [Table 11-9](#) RDMA Network Fabric for Oracle Exadata Database Machine X9M-2 Database Servers
- [Table 11-10](#) RDMA Network Fabric Cabling for Oracle Exadata Database Machine X9M-2 Storage Servers
- [Table 11-11](#) RDMA Network Fabric Inter-Switch Cabling for Oracle Exadata Database Machine X9M-2

The following table lists the location, ports and cables for the RDMA Network Fabric connections for database servers in an Exadata Database Machine X9M-2 rack.

**Table 11-9 RDMA Network Fabric Cabling for Oracle Exadata Database Machine X9M-2 Database Servers**

From Rack Unit	Port	To RDMA Network Fabric Switch	Port	Description
U39	System Board QSFP28 Port 2	U22	08	3 meters
U39	System Board QSFP28 Port 1	U20	08	3 meters
U37	System Board QSFP28 Port 2	U22	09	3 meters
U37	System Board QSFP28 Port 1	U20	09	3 meters
U35	System Board QSFP28 Port 2	U22	10	3 meters
U35	System Board QSFP28 Port 1	U20	10	3 meters
U33	System Board QSFP28 Port 2	U22	11	3 meters
U33	System Board QSFP28 Port 1	U20	11	3 meters
U31	System Board QSFP28 Port 2	U22	12	3 meters
U31	System Board QSFP28 Port 1	U20	12	3 meters
U29	System Board QSFP28 Port 2	U22	13	3 meters
U29	System Board QSFP28 Port 1	U20	13	3 meters
U27	System Board QSFP28 Port 2	U22	14	3 meters
U27	System Board QSFP28 Port 1	U20	14	3 meters
U26	System Board QSFP28 Port 2	U22	15	3 meters
U26	System Board QSFP28 Port 1	U20	15	3 meters
U25	System Board QSFP28 Port 2	U22	16	3 meters

**Table 11-9 (Cont.) RDMA Network Fabric Cabling for Oracle Exadata Database Machine X9M-2 Database Servers**

From Rack Unit	Port	To RDMA Network Fabric Switch	Port	Description
U25	System Board QSFP28 Port 1	U20	16	3 meters
U24	System Board QSFP28 Port 2	U22	17	3 meters
U24	System Board QSFP28 Port 1	U20	17	3 meters
U23	System Board QSFP28 Port 2	U22	18	3 meters
U23	System Board QSFP28 Port 1	U20	18	3 meters
U19	System Board QSFP28 Port 2	U22	19	3 meters
U19	System Board QSFP28 Port 1	U20	19	3 meters
U18	System Board QSFP28 Port 2	U22	20	3 meters
U18	System Board QSFP28 Port 1	U20	20	3 meters
U17	System Board QSFP28 Port 2	U22	21	3 meters
U17	System Board QSFP28 Port 1	U20	21	3 meters
U16	System Board QSFP28 Port 2	U22	22	3 meters
U16	System Board QSFP28 Port 1	U20	22	3 meters
U14	System Board QSFP28 Port 2	U22	23	3 meters
U14	System Board QSFP28 Port 1	U20	23	3 meters
U12	System Board QSFP28 Port 2	U22	24	3 meters
U12	System Board QSFP28 Port 1	U20	24	3 meters
U10	System Board QSFP28 Port 2	U22	25	3 meters
U10	System Board QSFP28 Port 1	U20	25	3 meters
U08	System Board QSFP28 Port 2	U22	26	3 meters
U08	System Board QSFP28 Port 1	U20	26	3 meters

The following table lists the location, ports and cables for the RDMA Network Fabric connections for storage servers in an Exadata Database Machine X9M-2 rack.

**Table 11-10 RDMA Network Fabric for Oracle Exadata Database Machine X9M-2 Storage Servers**

From Rack Unit	Port	To RDMA Network Fabric Switch	Port	Description
U41	PCIe QSFP28 Port 2	U22	15	3 meters
U41	PCIe QSFP28 Port 1	U20	15	3 meters
U39	PCIe QSFP28 Port 2	U22	08	3 meters
U39	PCIe QSFP28 Port 1	U20	08	3 meters
U37	PCIe QSFP28 Port 2	U22	09	3 meters
U37	PCIe QSFP28 Port 1	U20	09	3 meters
U35	PCIe QSFP28 Port 2	U22	10	3 meters
U35	PCIe QSFP28 Port 1	U20	10	3 meters
U33	PCIe QSFP28 Port 2	U22	11	3 meters
U33	PCIe QSFP28 Port 1	U20	11	3 meters
U31	PCIe QSFP28 Port 2	U22	12	3 meters
U31	PCIe QSFP28 Port 1	U20	12	3 meters
U29	PCIe QSFP28 Port 2	U22	13	3 meters
U29	PCIe QSFP28 Port 1	U20	13	3 meters
U27	PCIe QSFP28 Port 2	U22	14	3 meters
U27	PCIe QSFP28 Port 1	U20	14	3 meters
U25	PCIe QSFP28 Port 2	U22	16	3 meters
U25	PCIe QSFP28 Port 1	U20	16	3 meters
U23	PCIe QSFP28 Port 2	U22	18	3 meters
U23	PCIe QSFP28 Port 1	U20	18	3 meters
U18	PCIe QSFP28 Port 2	U22	20	3 meters
U18	PCIe QSFP28 Port 1	U20	20	3 meters
U14	PCIe QSFP28 Port 2	U22	23	3 meters
U14	PCIe QSFP28 Port 1	U20	23	3 meters
U12	PCIe QSFP28 Port 2	U22	24	3 meters
U12	PCIe QSFP28 Port 1	U20	24	3 meters
U10	PCIe QSFP28 Port 2	U22	25	3 meters
U10	PCIe QSFP28 Port 1	U20	25	3 meters
U08	PCIe QSFP28 Port 2	U22	26	3 meters
U08	PCIe QSFP28 Port 1	U20	26	3 meters
U06	PCIe QSFP28 Port 2	U22	27	3 meters
U06	PCIe QSFP28 Port 1	U20	27	3 meters
U04	PCIe QSFP28 Port 2	U22	28	3 meters
U04	PCIe QSFP28 Port 1	U20	28	3 meters

**Table 11-10 (Cont.) RDMA Network Fabric for Oracle Exadata Database Machine X9M-2 Storage Servers**

From Rack Unit	Port	To RDMA Network Fabric Switch	Port	Description
U02	PCIe QSFP28 Port 2	U22	29	3 meters
U02	PCIe QSFP28 Port 1	U20	29	3 meters

The following table lists the location, ports and cables for the RDMA Network Fabric connections for the leaf switches in an Exadata Database Machine X9M-2 rack.

**Table 11-11 RDMA Network Fabric Inter-Switch Cabling for Oracle Exadata Database Machine X9M-2**

From Rack Unit	Port	To RDMA Network Fabric Switch	Port	Description
U20	04	U22	04	1 meter
U20	05	U22	05	1 meter
U20	06	U22	06	1 meter
U20	07	U22	07	1 meter
U20	30	U22	30	1 meter
U20	31	U22	31	1 meter
U20	32	U22	32	1 meter
U20	33	U22	33	1 meter

## 11.6.2 RDMA Network Fabric Cabling for Exadata Database Machine X9M-8

This topic contains RDMA Network Fabric cabling details for Exadata Database Machine X9M-8.

The RoCE Network Fabric switches are located in rack units 21 and 23 for Exadata Database Machine X9M-8.

The following tables can be used for both flexible and fixed configurations. There are three sets of tables for each Exadata hardware model. One table is for storage servers, which have a 2-slot height (2RU). Another table is for the database servers, which require 5RU. The last table for each hardware model is for the inter-switch cabling, which provides the cabling information for the leaf switches.

### Note:

Not all the slots shown in the tables below will be used in a single configuration. Match the rack component with the appropriate slot in the tables below to determine how to cable that particular component.

In the following tables,  $Un$  denotes the slot in the rack, where  $n$  is the number, such as U23.  $Pn$  denotes the RDMA Network Fabric port  $n$ , where  $n$  is port number, such as P1. The cables used for the RDMA Network Fabric switch are black in color. The following tables are in this section:

- [Table 11-12](#) RDMA Network Fabric Cabling for Oracle Exadata Database Machine X9M-8 Database Servers
- [Table 11-13](#) RDMA Network Fabric Cabling for Oracle Exadata Database Machine X9M-8 Storage Servers
- [Table 11-14](#) RDMA Network Fabric Inter-Switch Cabling for Oracle Exadata Database Machine X9M-8

The following table lists the rack location, ports and cables for the RDMA Network Fabric connections for database servers in an Exadata Database Machine X9M-8 rack.

**Table 11-12 RDMA Network Fabric Cabling for Oracle Exadata Database Machine X9M-8 Database Servers**

From Rack Unit	Port	To RDMA Network Fabric Switch	Port	Description
U24	PCIe 5, P2	U23	15	3 meters
U24	PCIe 5, P1	U21	15	3 meters
U24	PCIe 7, P2	U23	16	3 meters
U24	PCIe 7, P1	U21	16	3 meters
U24	PCIe 9, P2	U23	17	3 meters
U24	PCIe 9, P1	U21	17	3 meters
U24	PCIe 11, P2	U23	18	3 meters
U24	PCIe 11, P1	U21	18	3 meters
U16	PCIe 5, P2	U23	19	3 meters
U16	PCIe 5, P1	U21	19	3 meters
U16	PCIe 7, P2	U23	20	3 meters
U16	PCIe 7, P1	U21	20	3 meters
U16	PCIe 9, P2	U23	21	3 meters
U16	PCIe 9, P1	U21	21	3 meters
U16	PCIe 11, P2	U23	22	3 meters
U16	PCIe 11, P1	U21	22	3 meters
U10	PCIe 5, P2	U23	23	3 meters
U10	PCIe 5, P1	U21	23	3 meters
U10	PCIe 7, P2	U23	24	3 meters
U10	PCIe 7, P1	U21	24	3 meters
U10	PCIe 9, P2	U23	25	3 meters
U10	PCIe 9, P1	U21	25	3 meters

**Table 11-12 (Cont.) RDMA Network Fabric Cabling for Oracle Exadata Database Machine X9M-8 Database Servers**

From Rack Unit	Port	To RDMA Network Fabric Switch	Port	Description
U10	PCIe 11, P2	U23	30 or 8 <b>Note:</b> Port 8 is the target only in a configuration with 3 database servers and 11 storage servers. Otherwise, port 30 is the target.	3 meters
U10	PCIe 11, P1	U21	30 or 8 <b>Note:</b> Port 8 is the target only in a configuration with 3 database servers and 11 storage servers. Otherwise, port 30 is the target.	3 meters

The following table lists the location, ports and cables for the RDMA Network Fabric connections for storage servers in an Exadata Database Machine X9M-8 rack.

**Table 11-13 RDMA Network Fabric Cabling for Oracle Exadata Database Machine X9M-8 Storage Servers**

From Rack Unit	Port	To RDMA Network Fabric Switch	Port	Description
U41	PCIe QSFP28 Port 2	U23	08	3 meters
U41	PCIe QSFP28 Port 1	U21	08	3 meters
U39	PCIe QSFP28 Port 2	U23	09	3 meters
U39	PCIe QSFP28 Port 1	U21	09	3 meters
U37	PCIe QSFP28 Port 2	U23	10	3 meters
U37	PCIe QSFP28 Port 1	U21	10	3 meters
U35	PCIe QSFP28 Port 2	U23	11	3 meters
U35	PCIe QSFP28 Port 1	U21	11	3 meters
U33	PCIe QSFP28 Port 2	U23	12	3 meters
U33	PCIe QSFP28 Port 1	U21	12	3 meters
U31	PCIe QSFP28 Port 2	U23	13	3 meters
U31	PCIe QSFP28 Port 1	U21	13	3 meters
U29	PCIe QSFP28 Port 2	U23	14	3 meters
U29	PCIe QSFP28 Port 1	U21	14	3 meters
U14	PCIe QSFP28 Port 2	U23	23	3 meters
U14	PCIe QSFP28 Port 1	U21	23	3 meters
U12	PCIe QSFP28 Port 2	U23	24	3 meters

**Table 11-13 (Cont.) RDMA Network Fabric Cabling for Oracle Exadata Database Machine X9M-8 Storage Servers**

From Rack Unit	Port	To RDMA Network Fabric Switch	Port	Description
U12	PCIe QSFP28 Port 1	U21	24	3 meters
U10	PCIe QSFP28 Port 2	U23	25	3 meters
U10	PCIe QSFP28 Port 1	U21	25	3 meters
U08	PCIe QSFP28 Port 2	U23	26	3 meters
U08	PCIe QSFP28 Port 1	U21	26	3 meters
U06	PCIe QSFP28 Port 2	U23	27	3 meters
U06	PCIe QSFP28 Port 1	U21	27	3 meters
U04	PCIe QSFP28 Port 2	U23	28	3 meters
U04	PCIe QSFP28 Port 1	U21	28	3 meters
U02	PCIe QSFP28 Port 2	U23	29	3 meters
U02	PCIe QSFP28 Port 1	U21	29	3 meters

The following table lists the location, ports and cables for the RDMA Network Fabric connections for the leaf switches in an Exadata Database Machine X9M-8 rack.

**Table 11-14 RDMA Network Fabric Inter-Switch Cabling for Oracle Exadata Database Machine X9M-8**

From Rack Unit	Port	To RDMA Network Fabric Switch	Port	Description
U21	04	U23	04	1 meter
U21	05	U23	05	1 meter
U21	06	U23	06	1 meter
U21	07	U23	07	1 meter
U21	30 or 34 <b>Note:</b> Port 34 is used only in a configuration with 3 database servers and 11 storage servers. Otherwise, port 30 is used.	U23	30 or 34 <b>Note:</b> Port 34 is used only in a configuration with 3 database servers and 11 storage servers. Otherwise, port 30 is used.	1 meter
U21	31	U23	31	1 meter
U21	32	U23	32	1 meter
U21	33	U23	33	1 meter

# 12

## Cabling Tables for Exadata Database Machine X8M

These tables show the cable layouts for Exadata Database Machine X8M-2 and X8M-8.



### Note:

For ease of reading, the name "Oracle Exadata Rack" is used when information refers to both Exadata Database Machine and Oracle Exadata Storage Expansion Rack.

- [Rack Layout Diagrams](#)  
The diagrams in this topic show the rack layout for Exadata Database Machine X8M-2 and X8M-8.
- [Integrated Lights Out Manager \(ILOM\) Cabling Tables](#)  
This topic contains the tables for the ILOM network cabling.
- [Administrative Ethernet Port Cabling Tables](#)  
This topic contains the tables for the administrative network cabling.
- [Single Phase Power Distribution Unit Cabling Tables](#)  
These tables show the cabling routes from each single-phase power distribution unit (PDU) to the power supplies configured in an Oracle Exadata Database Machine X8M-2 and X8M-8.
- [Three-Phase Power Distribution Unit Cabling Tables](#)  
The following topics contains the tables for a three-phase power distribution unit (PDU) in Exadata Database Machine X8M-2 and X8M-8.
- [RDMA Network Fabric Network Cabling Tables](#)  
This section contains the tables for RDMA Network Fabric network cabling for Exadata Database Machine X8M-2 and X8M-8 racks.

### 12.1 Rack Layout Diagrams

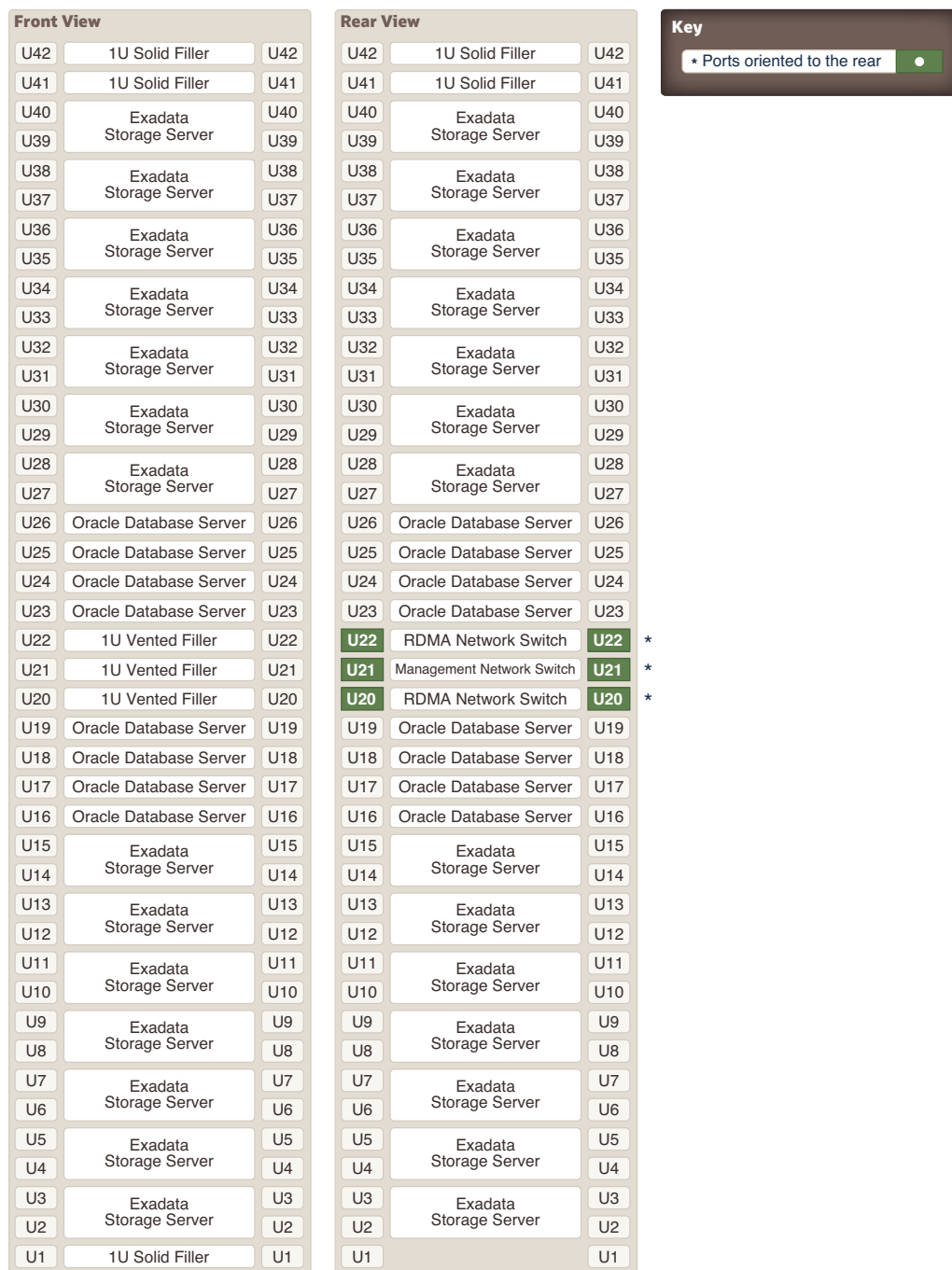
The diagrams in this topic show the rack layout for Exadata Database Machine X8M-2 and X8M-8.

The slot numbers for each component is shown in the following images.

The following image shows the front and rear views of the component positioning in Exadata Database Machine X8M-2 Full Rack. The front view is shown on the left, and the rear view is shown on the right.

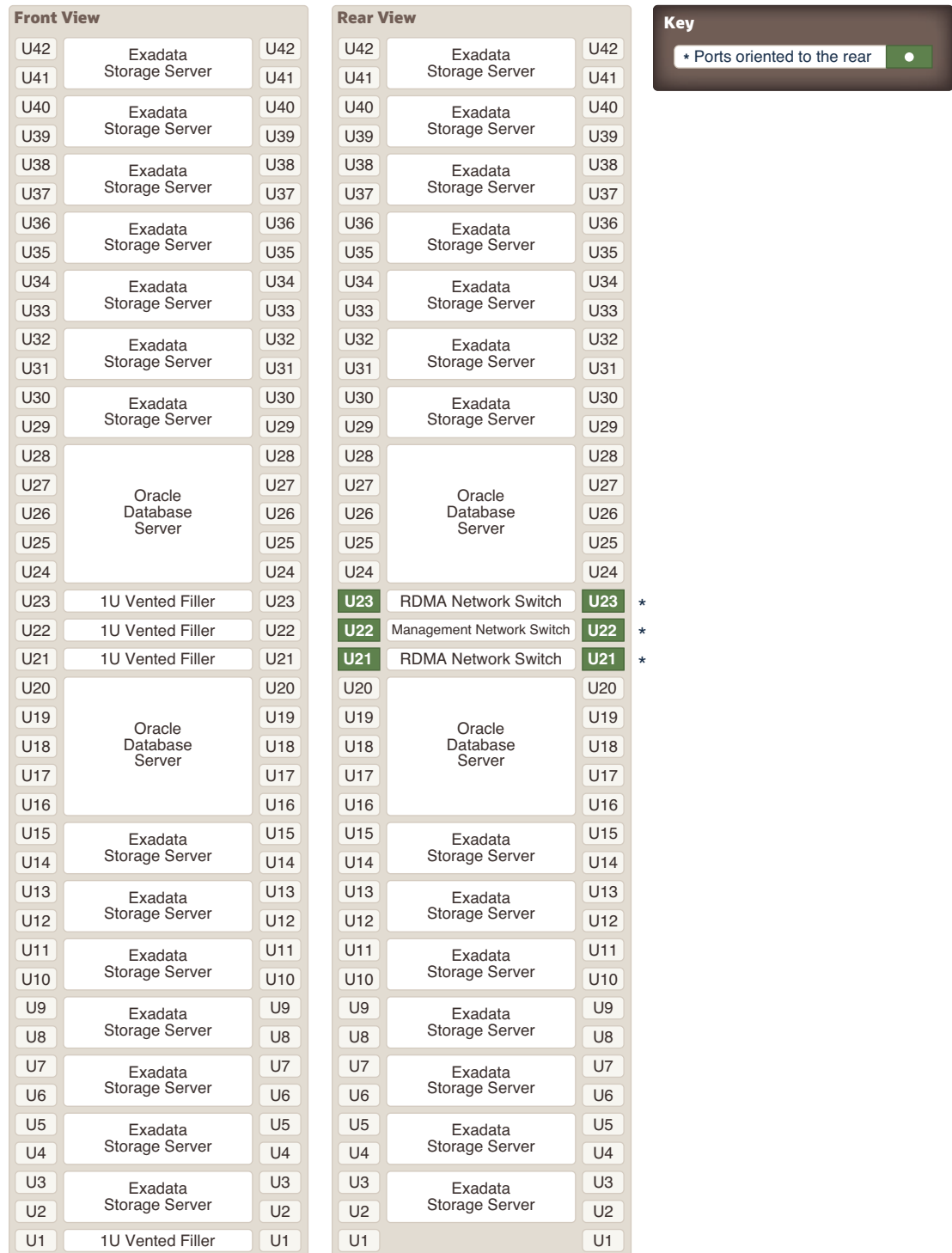


**Figure 12-1 Rack Layout of Exadata Database Machine X8M-2 Full Rack**



The following image shows the front and rear views of the component positioning in Exadata Database Machine X8M-8.

**Figure 12-2 Rack Layout of Exadata Database Machine X8M-8**



## 12.2 Integrated Lights Out Manager (ILOM) Cabling Tables

This topic contains the tables for the ILOM network cabling.

The following tables are in this section:

- [Table 12-1](#) ILOM Cabling for Exadata Database Machine X8M-2 Full Rack
- [Table 12-2](#) ILOM Cabling for Exadata Database Machine X8M-8 Full Rack

In the following tables,  $U_n$  denotes the unit height in the rack, where  $n$  is the number, such as U20. The cables used for ILOM are red in color.

The following table shows the cable connections from the ILOM port (NET MGT) on the servers to the Management Network Switch:

**Table 12-1 ILOM Cabling for Exadata Database Machine X8M-2 Full Rack**

From Rack Unit	Type of Equipment	Management Network Switch Port
U39	Storage Server	2
U37	Storage Server	4
U35	Storage Server	6
U33	Storage Server	8
U31	Storage Server	10
U29	Storage Server	12
U27	Storage Server	14
U26	Database server	16
U25	Database server	18
U24	Database server	20
U23	Database server	22
U22 (NET MGT 0)	Leaf switch	45
U20 (NET MGT 0)	Leaf switch	46
U19	Database server	24
U18	Database server	26
U17	Database server	28
U16	Database server	30
U14	Storage Server	32
U12	Storage Server	34
U10	Storage Server	36
U8	Storage Server	38
U6	Storage Server	40
U4	Storage Server	42
U2	Storage Server	44

The following table shows the cable connections from the ILOM port on the servers to the Management Network Switch:

**Table 12-2 ILOM Cabling for Exadata Database Machine X8M-8 Full Rack**

From Rack Unit	Type of Equipment	Management Network Switch Port
U41	Storage Server	2
U39	Storage Server	4
U37	Storage Server	6
U35	Storage Server	8
U33	Storage Server	10
U31	Storage Server	12
U29	Storage Server	14
U24	Database server	16
U16	Database server	18
U14	Storage Server	20
U12	Storage Server	22
U10	Storage Server	24
U8	Storage Server	26
U6	Storage Server	28
U4	Storage Server	30
U2	Storage Server	32

## 12.3 Administrative Ethernet Port Cabling Tables

This topic contains the tables for the administrative network cabling.

The Management Network Switch is located in rack unit 21 on Exadata Database Machine X8M-2 racks and in rack unit 22 on Exadata Database Machine X8M-8 racks.

In the following tables, *Un* denotes the unit height in the rack, where *n* is the number, such as U20. The cables used for the Management Network Switch are blue in color. The following tables are in this section:

- [Table 12-3](#) Administrative Network Cabling for Exadata Database Machine X8M-2 Full Rack
- [Table 12-4](#) Administrative Network Cabling for Exadata Database Machine X8M-8 Full Rack

The following table shows the cable connections from the Admin port in the rack components to the Management Network Switch:

**Table 12-3 Administrative Network Cabling for Exadata Database Machine X8M-2 Full Rack**

From Rack Unit	Type of Equipment	Management Network Switch Port
U39	Storage Server	1

**Table 12-3 (Cont.) Administrative Network Cabling for Exadata Database Machine X8M-2 Full Rack**

From Rack Unit	Type of Equipment	Management Network Switch Port
U37	Storage Server	3
U35	Storage Server	5
U33	Storage Server	7
U31	Storage Server	9
U29	Storage Server	11
U27	Storage Server	13
U26	Database server	15
U25	Database server	17
U24	Database server	19
U23	Database server	21
U22	RDMA Network Fabric Switch	45
U20	RDMA Network Fabric Switch	46
U19	Database server	23
U18	Database server	25
U17	Database server	27
U16	Database server	29
U14	Storage Server	31
U12	Storage Server	33
U10	Storage Server	35
U8	Storage Server	37
U6	Storage Server	39
U4	Storage Server	41
U2	Storage Server	43
U1	RDMA Network Fabric Switch Note that the spine switch is not included by default on Exadata Database Machine X8M-2 racks, but port 47 is still reserved on the Management Network Switch for the spine RDMA Network Fabric switch.	47

The following table shows the cable connections from the Admin port in the rack components to the Management Network Switch:

**Table 12-4 Administrative Network Cabling for Exadata Database Machine X8M-8 Full Rack**

From Rack Unit	Type of Equipment	Management Network Switch Port
U41	Storage Server	1
U39	Storage Server	3
U37	Storage Server	5
U35	Storage Server	7
U33	Storage Server	9
U31	Storage Server	11
U29	Storage Server	13
U24	Database server	15
U23	RDMA Network Fabric Switch	33
U21	RDMA Network Fabric Switch	34
U16	Database server	17
U14	Storage Server	19
U12	Storage Server	21
U10	Storage Server	23
U8	Storage Server	25
U6	Storage Server	27
U4	Storage Server	29
U2	Storage Server	31
U1	RDMA Network Fabric Switch Note that the spine switch is not included by default on Exadata Database Machine X8M-8 racks, but port 47 is still reserved on the Management Network Switch for the spine RDMA Network Fabric switch.	35

## 12.4 Single Phase Power Distribution Unit Cabling Tables

These tables show the cabling routes from each single-phase power distribution unit (PDU) to the power supplies configured in an Oracle Exadata Database Machine X8M-2 and X8M-8.

- [Single Phase PDU Cabling for Oracle Exadata Database Machine X8M-2 Full Rack](#)  
Single phase cabling for the Oracle Exadata Database Machine X8M-2 Full Rack routes from each power distribution unit (PDU) to the power supplies.
- [Single Phase PDU Cabling for Oracle Exadata Database Machine X8M-8 Full Rack](#)  
Single phase cabling for the Oracle Exadata Database Machine X8M-8 Full Rack routes from each power distribution unit (PDU) to the power supplies.

## 12.4.1 Single Phase PDU Cabling for Oracle Exadata Database Machine X8M-2 Full Rack

Single phase cabling for the Oracle Exadata Database Machine X8M-2 Full Rack routes from each power distribution unit (PDU) to the power supplies.

The cables are terminated to PDU-A on the left (when looking at the rear of the rack), and routed to the right to enter the cable management arm (CMA). The cables are bundled in groups of four. The PDU connections list the group and outlet on the PDU. So, for example, G5-5 refers to group 5 outlet 5.

**Table 12-5 Single Phase PDU Cabling for Oracle Exadata Database Machine X8M-2 Full Rack**

Rack Unit	PS	PDU-A	PDU-B/PS1	Cable Length
U42	PS0	G5-3	G0-3	2 meters
U41	PS0	G5-5	G0-1	2 meters
U40	PS0	G5-6	G0-0	2 meters
U39	PS0	G3-6	G2-0	2 meters
U37	PS0	G3-0	G2-6	2 meters
U35	PS0	G5-4	G0-2	2 meters
U33	PS0	G4-1	G1-5	2 meters
U31	PS0	G5-2	G0-4	2 meters
U29	PS0	G5-1	G0-5	2 meters
U27	PS0	G4-3	G1-3	2 meters
U26	PS0	G4-6	G1-0	2 meters
U25	PS0	G4-5	G1-1	2 meters
U24	PS0	G4-2	G1-4	2 meters
U23	PS0	G4-0	G1-6	2 meters
U22	PS2	G1-6	G4-0	2 meters
U21	PS2	G1-5	G4-1	2 meters
U20	PS2	G1-2	G4-4	2 meters
U19	PS0	G3-2	G2-4	2 meters
U18	PS0	G2-6	G3-0	2 meters
U17	PS0	G0-6	G5-0	2 meters
U16	PS0	G0-3	G5-3	2 meters
U14	PS0	G2-3	G3-3	2 meters
U12	PS0	G2-4	G3-2	2 meters
U10	PS0	G2-0	G3-6	2 meters
U8	PS0	G2-5	G3-1	2 meters
U6	PS0	G0-0	G5-6	2 meters
U4	PS0	G0-1	G5-5	2 meters

**Table 12-5 (Cont.) Single Phase PDU Cabling for Oracle Exadata Database Machine X8M-2 Full Rack**

Rack Unit	PS	PDU-A	PDU-B/PS1	Cable Length
U2	PS0	G1-0	G4-6	2 meters
U1	PS2	G3-5	G2-1	3 meters

## 12.4.2 Single Phase PDU Cabling for Oracle Exadata Database Machine X8M-8 Full Rack

Single phase cabling for the Oracle Exadata Database Machine X8M-8 Full Rack routes from each power distribution unit (PDU) to the power supplies.

The cables are terminated to PDU-A on the left (when looking at the rear of the rack), and routed to the right to enter the cable management arm (CMA). The cables are bundled in groups of four. The PDU connections in the table below list the group and outlet on the PDU. So, for example, G5-5 refers to group 5 outlet 5.

**Table 12-6 Single Phase PDU Cabling for Oracle Exadata Database Machine X8M-8 Full Rack**

Rack Unit	PS	PDU-A	PDU-B/PSU 1	Cable Length
U41	PS0	G3-5	G2-1	2 meters
U39	PS0	G5-4	G0-2	2 meters
U37	PS0	G5-2	G0-4	2 meters
U35	PS0	G5-0	G0-6	2 meters
U33	PS0	G3-4	G2-2	2 meters
U31	PS0	G4-3	G1-3	2 meters
U29	PS0	G3-6	G2-0	2 meters
U24	PS0	G2-7 (PS2)	G3-7 (PS3)	1 meter
U24	PS0	G4-7	G1-7	1 meter
U23	PS2	G3-1	G2-5	2 meters
U22	PS2	G2-6	G3-0	2 meters
U21	PS2	G1-6	G4-0	2 meters
U16	PS0	G1-7 (PS2)	G4-7 (PS3)	1 meter
U16	PS0	G3-7	G2-7	1 meter
U14 (only 2 DB servers)	PS0	G2-0	G3-6	2 meters
U12 (only 2 DB servers)	PS0	G1-3	G4-3	2 meters
U10 (only 2 DB servers)	PS0	G1-0	G4-6	2 meters
U10 (3 DB servers)	PS0	G0-7 (PS2)	G5-7 (PS3)	1 meter
U10 (3 DB servers)	PS0	G5-7	G0-7	2 meters



**Table 12-6 (Cont.) Single Phase PDU Cabling for Oracle Exadata Database Machine X8M-8 Full Rack**

Rack Unit	PS	PDU-A	PDU-B/PSU 1	Cable Length
U8	PS0	G0-6	G5-0	2 meters
U6	PS0	G0-4	G5-2	2 meters
U4	PS0	G0-3	G5-3	2 meters
U2	PS0	G0-1	G5-5	2 meters
U1	PS2	G4-0	G1-6	3 meters

## 12.5 Three-Phase Power Distribution Unit Cabling Tables

The following topics contains the tables for a three-phase power distribution unit (PDU) in Exadata Database Machine X8M-2 and X8M-8.

- [Three-Phase PDU Cabling for Oracle Exadata Database Machine X8M-2 Full Rack](#)  
 Three-phase cabling for the Oracle Exadata Database Machine X8M-2 Full Rack routes from each power distribution unit (PDU) to the power supplies configured in each rack.
- [Three Phase PDU Cabling for Oracle Exadata Database Machine X8M-8 Full Rack](#)  
 Three-phase cabling for the Oracle Exadata Database Machine X8M-8 Full Rack routes from each power distribution unit (PDU) to the power supplies configured in each rack.

### 12.5.1 Three-Phase PDU Cabling for Oracle Exadata Database Machine X8M-2 Full Rack

Three-phase cabling for the Oracle Exadata Database Machine X8M-2 Full Rack routes from each power distribution unit (PDU) to the power supplies configured in each rack.

The cables are terminated to PDU-A on the left (when looking at the rear of the rack), and routed to the right to enter the cable management arm (CMA). The cables are bundled in groups of four. The PDU connections list the group and outlet on the PDU. So, for example, G5-5 refers to group 5 outlet 5.

**Table 12-7 Three Phase PDU Cabling for Oracle Exadata Database Machine X8M-2 Full Rack**

Rack Unit	PDU-A/PSU 0	PDU-B/PSU 1	Cable Length
U42	G5-4	G2-2	2 meters
U41	G5-2	G2-4	2 meters
U40	G5-1	G2-5	2 meters
U39	G5-6	G2-0	2 meters
U37	G3-5	G0-1	2 meters

**Table 12-7 (Cont.) Three Phase PDU Cabling for Oracle Exadata Database Machine X8M-2 Full Rack**

Rack Unit	PDU-A/PSU 0	PDU-B/PSU 1	Cable Length
U35	G3-0	G0-6	2 meters
U33	G5-5	G2-1	2 meters
U31	G5-3	G2-3	2 meters
U29	G4-2	G1-4	2 meters
U27	G3-2	G0-4	2 meters
U26	G5-0	G2-6	2 meters
U25	G4-5	G1-1	2 meters
U24	G3-1	G0-5	2 meters
U23	G4-1	G1-5	2 meters
U22	G1-6	G4-0	2 meters
U21	G2-6	G5-0	2 meters
U20	G1-5	G4-1	2 meters
U19	G1-1	G4-5	2 meters
U18	G1-4	G4-2	2 meters
U17	G2-1	G5-5	2 meters
U16	G2-3	G5-3	2 meters
U14	G0-5	G3-1	2 meters
U12	G2-5	G5-1	2 meters
U10	G0-3	G3-3	2 meters
U8	G1-3	G4-3	2 meters
U6	G2-4	G5-2	2 meters
U4	G0-6	G3-0	2 meters
U2	G0-0	G3-6	2 meters
U1	G1-0	G4-6	3 meters

## 12.5.2 Three Phase PDU Cabling for Oracle Exadata Database Machine X8M-8 Full Rack

Three-phase cabling for the Oracle Exadata Database Machine X8M-8 Full Rack routes from each power distribution unit (PDU) to the power supplies configured in each rack.

The cables are terminated to PDU-A on the left (when looking at the rear of the rack), and routed to the right to enter the cable management arm (CMA). The cables are bundled in groups of four. The PDU connections list the group and outlet on the PDU. So, for example, G5-5 refers to group 5 outlet 5.

**Table 12-8 Three Phase PDU Cabling for Oracle Exadata Database Machine X8M-8 Full Rack**

Rack Unit	PDU-A/PSU 0	PDU-B/PSU 1	Cable Length
U41	G5-5	G2-1	2 meters
U39	G5-4	G2-2	2 meters
U37	G5-2	G2-4	2 meters
U35	G5-1	G2-5	2 meters
U33	G5-0	G2-6	2 meters
U31	G4-6	G1-0	2 meters
U29	G4-4	G1-2	2 meters
U24	G3-7 (PS2)	G0-7 (PS3)	2 meters
U24	G4-7	G1-7	2 meters
U23	G3-1	G0-5	2 meters
U22	G3-0	G0-6	2 meters
U21	G2-5	G5-1	2 meters
U16	G2-7 (PS2)	G5-7 (PS3)	2 meters
U16	G1-7	G4-7	2 meters
U14 (only 2 DB servers)	G1-3	G4-3	2 meters
U12 (only 2 DB servers)	G1-0	G4-6	2 meters
U10 (only 2 DB servers)	G0-6	G3-0	2 meters
U10 (3 DB servers)	G5-7 (PS2)	G2-7 (PS3)	1 meter
U10 (3 DB servers)	G0-7	G3-7	1 meter
U8	G0-5	G3-1	2 meters
U6	G0-4	G3-2	2 meters
U4	G0-2	G3-4	2 meters
U2	G0-1	G3-5	2 meters
U1	G0-0	G3-6	3 meters

## 12.6 RDMA Network Fabric Network Cabling Tables

This section contains the tables for RDMA Network Fabric network cabling for Exadata Database Machine X8M-2 and X8M-8 racks.

- [RDMA Network Fabric Network Cabling Tables for X8M-2 Racks](#)  
This topic contains the tables for RDMA Network Fabric network cabling for Exadata Database Machine X8M-2 racks.
- [RDMA Network Fabric Network Cabling Tables for X8M-8 Racks](#)  
This topic contains the tables for RDMA Network Fabric network cabling for Exadata Database Machine X8M-8 racks.

## 12.6.1 RDMA Network Fabric Network Cabling Tables for X8M-2 Racks

This topic contains the tables for RDMA Network Fabric network cabling for Exadata Database Machine X8M-2 racks.

The RoCE Network Fabric switches are located in rack units 20 and 22 for Exadata Database Machine X8M-2.

You can use the following tables for both flexible and fixed configurations. This first table contains RDMA Network Fabric cabling information for the database servers, each of which occupies 1RU. The second table covers the storage servers, each of which occupies 2RU. The last table contains the inter-switch cabling between the leaf switches.



### Note:

Not all the slots shown in the tables below will be used in a single configuration. Match the rack component with the appropriate slot in the tables below to determine how to cable that particular component.

In the following tables,  $U_n$  denotes the slot in the rack, where  $n$  is the number, such as U20.  $P_n$  denotes the RDMA Network Fabric port  $n$ , where  $n$  is port number, such as P1. The cables used for the RDMA Network Fabric switch are black in color. The following tables are in this section:

- [Table 12-9](#) RDMA Network Fabric Network Cabling for Exadata Database Machine X8M-2 Database Servers
- [Table 12-10](#) RDMA Network Fabric Network Cabling for Exadata Database Machine X8M-2 Storage Servers
- [Table 12-11](#) RDMA Network Fabric Inter-Switch Cabling for Exadata Database Machine X8M-2

The following table lists the location, ports and cables for the RDMA Network Fabric connections for database servers in an Exadata Database Machine X8M-2 rack.

**Table 12-9 RDMA Network Fabric Network Cabling for Oracle Exadata Database Machine X8M-2 Database Servers**

From Rack Unit	Port	To RDMA Network Fabric Switch	Port	Description
U39	PCIe 2, P2	U22	08	3 meters
U39	PCIe 2, P1	U20	08	3 meters
U37	PCIe 2, P2	U22	09	3 meters
U37	PCIe 2, P1	U20	09	3 meters
U35	PCIe 2, P2	U22	10	3 meters
U35	PCIe 2, P1	U20	10	3 meters
U33	PCIe 2, P2	U22	11	3 meters
U33	PCIe 2, P1	U20	11	3 meters
U31	PCIe 2, P2	U22	12	3 meters

**Table 12-9 (Cont.) RDMA Network Fabric Network Cabling for Oracle Exadata Database Machine X8M-2 Database Servers**

From Rack Unit	Port	To RDMA Network Fabric Switch	Port	Description
U31	PCIe 2, P1	U20	12	3 meters
U29	PCIe 2, P2	U22	13	3 meters
U29	PCIe 2, P1	U20	13	3 meters
U27	PCIe 2, P2	U22	14	3 meters
U27	PCIe 2, P1	U20	14	3 meters
U26	PCIe 2, P2	U22	15	3 meters
U26	PCIe 2, P1	U20	15	3 meters
U25	PCIe 2, P2	U22	16	3 meters
U25	PCIe 2, P1	U20	16	3 meters
U24	PCIe 2, P2	U22	17	3 meters
U24	PCIe 2, P1	U20	17	3 meters
U23	PCIe 2, P2	U22	18	3 meters
U23	PCIe 2, P1	U20	18	3 meters
U19	PCIe 2, P2	U22	19	3 meters
U19	PCIe 2, P1	U20	19	3 meters
U18	PCIe 2, P2	U22	20	3 meters
U18	PCIe 2, P1	U20	20	3 meters
U17	PCIe 2, P2	U22	21	3 meters
U17	PCIe 2, P1	U20	21	3 meters
U16	PCIe 2, P2	U22	22	3 meters
U16	PCIe 2, P1	U20	22	3 meters
U14	PCIe 2, P2	U22	23	3 meters
U14	PCIe 2, P1	U20	23	3 meters
U12	PCIe 2, P2	U22	24	3 meters
U12	PCIe 2, P1	U20	24	3 meters
U10	PCIe 2, P2	U22	25	3 meters
U10	PCIe 2, P1	U20	25	3 meters
U08	PCIe 2, P2	U22	26	3 meters
U08	PCIe 2, P1	U20	26	3 meters

The following table lists the location, ports and cables for the RDMA Network Fabric connections for storage servers in an Exadata Database Machine X8M-2 rack.

**Table 12-10 RDMA Network Fabric Network Cabling for Oracle Exadata Database Machine X8M-2 Storage Servers**

From Rack Unit	Port	To RDMA Network Fabric Switch	Port	Description
U41	PCIe 1, P2	U22	15	3 meters
U41	PCIe 1, P1	U20	15	3 meters
U39	PCIe 1, P2	U22	08	3 meters
U39	PCIe 1, P1	U20	08	3 meters
U37	PCIe 1, P2	U22	09	3 meters
U37	PCIe 1, P1	U20	09	3 meters
U35	PCIe 1, P2	U22	10	3 meters
U35	PCIe 1, P1	U20	10	3 meters
U33	PCIe 1, P2	U22	11	3 meters
U33	PCIe 1, P1	U20	11	3 meters
U31	PCIe 1, P2	U22	12	3 meters
U31	PCIe 1, P1	U20	12	3 meters
U29	PCIe 1, P2	U22	13	3 meters
U29	PCIe 1, P1	U20	13	3 meters
U27	PCIe 1, P2	U22	14	3 meters
U27	PCIe 1, P1	U20	14	3 meters
U25	PCIe 1, P2	U22	16	3 meters
U25	PCIe 1, P1	U20	16	3 meters
U23	PCIe 1, P2	U22	18	3 meters
U23	PCIe 1, P1	U20	18	3 meters
U18	PCIe 1, P2	U22	20	3 meters
U18	PCIe 1, P1	U20	20	3 meters
U14	PCIe 1, P2	U22	23	3 meters
U14	PCIe 1, P1	U20	23	3 meters
U12	PCIe 1, P2	U22	24	3 meters
U12	PCIe 1, P1	U20	24	3 meters
U10	PCIe 1, P2	U22	25	3 meters
U10	PCIe 1, P1	U20	25	3 meters
U08	PCIe 1, P2	U22	26	3 meters
U08	PCIe 1, P1	U20	26	3 meters
U06	PCIe 1, P2	U22	27	3 meters
U06	PCIe 1, P1	U20	27	3 meters
U04	PCIe 1, P2	U22	28	3 meters
U04	PCIe 1, P1	U20	28	3 meters
U02	PCIe 1, P2	U22	29	3 meters

**Table 12-10 (Cont.) RDMA Network Fabric Network Cabling for Oracle Exadata Database Machine X8M-2 Storage Servers**

From Rack Unit	Port	To RDMA Network Fabric Switch	Port	Description
U02	PCIe 1, P1	U20	29	3 meters

The following table lists the location, ports and cables for the RDMA Network Fabric connections for the leaf switches in an Exadata Database Machine X8M-2 rack.

**Table 12-11 RDMA Network Fabric Inter-Switch Cabling for Oracle Exadata Database Machine X8M-2**

From Rack Unit	Port	To RDMA Network Fabric Switch	Port	Description
U20	04	U22	04	1 meter
U20	05	U22	05	1 meter
U20	06	U22	06	1 meter
U20	07	U22	07	1 meter
U20	30	U22	30	1 meter
U20	31	U22	31	1 meter
U20	32	U22	32	1 meter
U20	33	U22	33	1 meter

## 12.6.2 RDMA Network Fabric Network Cabling Tables for X8M-8 Racks

This topic contains the tables for RDMA Network Fabric network cabling for Exadata Database Machine X8M-8 racks.

The RoCE Network Fabric switches are located in rack units 21 and 23 for Exadata Database Machine X8M-8.

The following tables can be used for both flexible and fixed configurations. There are three sets of tables for each Exadata hardware model. One table is for storage servers, which have a 2-slot height (2RU). Another table is for the database servers, which require 5RU. The last table for each hardware model is for the inter-switch cabling, which provides the cabling information for the leaf switches.

 **Note:**

Not all the slots shown in the tables below will be used in a single configuration. Match the rack component with the appropriate slot in the tables below to determine how to cable that particular component.

In the following tables,  $U_n$  denotes the slot in the rack, where  $n$  is the number, such as U23.  $P_n$  denotes the RDMA Network Fabric port  $n$ , where  $n$  is port number, such as

P1. The cables used for the RDMA Network Fabric switch are black in color. The following tables are in this section:

- [Table 12-12](#) RDMA Network Fabric Network Cabling for Exadata Database Machine X8M-8 Database Servers
- [Table 12-13](#) RDMA Network Fabric Network Cabling for Exadata Database Machine X8M-8 Storage Servers
- [Table 12-14](#) RDMA Network Fabric Inter-Switch Cabling for Exadata Database Machine X8M-8

The following table lists the rack location, ports and cables for the RDMA Network Fabric connections for database servers in an Exadata Database Machine X8M-8 rack.

**Table 12-12 RDMA Network Fabric Network Cabling for Oracle Exadata Database Machine X8M-8 Database Servers**

From Rack Unit	Port	To RDMA Network Fabric Switch	Port	Description
U24	PCIe 5, P2	U23	15	3 meters
U24	PCIe 5, P1	U21	15	3 meters
U24	PCIe 7, P2	U23	16	3 meters
U24	PCIe 7, P1	U21	16	3 meters
U24	PCIe 9, P2	U23	17	3 meters
U24	PCIe 9, P1	U21	17	3 meters
U24	PCIe 11, P2	U23	18	3 meters
U24	PCIe 11, P1	U21	18	3 meters
U16	PCIe 5, P2	U23	19	3 meters
U16	PCIe 5, P1	U21	19	3 meters
U16	PCIe 7, P2	U23	20	3 meters
U16	PCIe 7, P1	U21	20	3 meters
U16	PCIe 9, P2	U23	21	3 meters
U16	PCIe 9, P1	U21	21	3 meters
U16	PCIe 11, P2	U23	22	3 meters
U16	PCIe 11, P1	U21	22	3 meters
U10	PCIe 5, P2	U23	23	3 meters
U10	PCIe 5, P1	U21	23	3 meters
U10	PCIe 7, P2	U23	24	3 meters
U10	PCIe 7, P1	U21	24	3 meters
U10	PCIe 9, P2	U23	25	3 meters
U10	PCIe 9, P1	U21	25	3 meters



**Table 12-12 (Cont.) RDMA Network Fabric Network Cabling for Oracle Exadata Database Machine X8M-8 Database Servers**

From Rack Unit	Port	To RDMA Network Fabric Switch	Port	Description
U10	PCIe 11, P2	U23	30 or 8	3 meters <b>Note:</b> Port 8 is the target only in a configuration with 3 database servers and 11 storage servers. Otherwise, port 30 is the target.
U10	PCIe 11, P1	U21	30 or 8	3 meters <b>Note:</b> Port 8 is the target only in a configuration with 3 database servers and 11 storage servers. Otherwise, port 30 is the target.

The following table lists the location, ports and cables for the RDMA Network Fabric connections for storage servers in an Exadata Database Machine X8M-8 rack.

**Table 12-13 RDMA Network Fabric Network Cabling for Oracle Exadata Database Machine X8M-8 Storage Servers**

From Rack Unit	Port	To RDMA Network Fabric Switch	Port	Description
U41	PCIe 1, P2	U23	08	3 meters
U41	PCIe 1, P1	U21	08	3 meters
U39	PCIe 1, P2	U23	09	3 meters
U39	PCIe 1, P1	U21	09	3 meters
U37	PCIe 1, P2	U23	10	3 meters
U37	PCIe 1, P1	U21	10	3 meters
U35	PCIe 1, P2	U23	11	3 meters
U35	PCIe 1, P1	U21	11	3 meters
U33	PCIe 1, P2	U23	12	3 meters
U33	PCIe 1, P1	U21	12	3 meters
U31	PCIe 1, P2	U23	13	3 meters
U31	PCIe 1, P1	U21	13	3 meters
U29	PCIe 1, P2	U23	14	3 meters
U29	PCIe 1, P1	U21	14	3 meters
U14	PCIe 1, P2	U23	23	3 meters
U14	PCIe 1, P1	U21	23	3 meters
U12	PCIe 1, P2	U23	24	3 meters

**Table 12-13 (Cont.) RDMA Network Fabric Network Cabling for Oracle Exadata Database Machine X8M-8 Storage Servers**

From Rack Unit	Port	To RDMA Network Fabric Switch	Port	Description
U12	PCIe 1, P1	U21	24	3 meters
U10	PCIe 1, P2	U23	25	3 meters
U10	PCIe 1, P1	U21	25	3 meters
U08	PCIe 1, P2	U23	26	3 meters
U08	PCIe 1, P1	U21	26	3 meters
U06	PCIe 1, P2	U23	27	3 meters
U06	PCIe 1, P1	U21	27	3 meters
U04	PCIe 1, P2	U23	28	3 meters
U04	PCIe 1, P1	U21	28	3 meters
U02	PCIe 1, P2	U23	29	3 meters
U02	PCIe 1, P1	U21	29	3 meters

The following table lists the location, ports and cables for the RDMA Network Fabric connections for the leaf switches in an Exadata Database Machine X8M-8 rack.

**Table 12-14 RDMA Network Fabric Inter-Switch Cabling for Oracle Exadata Database Machine X8M-8**

From Rack Unit	Port	To RDMA Network Fabric Switch	Port	Description
U21	04	U23	04	1 meter
U21	05	U23	05	1 meter
U21	06	U23	06	1 meter
U21	07	U23	07	1 meter
U21	30 or 34 <b>Note:</b> Port 34 is used only in a configuration with 3 database servers and 11 storage servers. Otherwise, port 30 is used.	U23	30 or 34 <b>Note:</b> Port 34 is used only in a configuration with 3 database servers and 11 storage servers. Otherwise, port 30 is used.	1 meter
U21	31	U23	31	1 meter
U21	32	U23	32	1 meter
U21	33	U23	33	1 meter

# 13

## Cabling Tables for Oracle Exadata Database Machine X8-2, X8-8, X7-2, and X7-8

The tables in this chapter show the cable layouts for Oracle Exadata Database Machine X8-2, X8-8, X7-2, and X7-8.



### Note:

For ease of reading, the name "Oracle Exadata Rack" is used when information refers to both Oracle Exadata Database Machine and Oracle Exadata Storage Expansion Rack.

- [Rack Layout Diagrams](#)  
The diagrams in this topic show the rack layout for Oracle Exadata Database Machine X8-2, X8-8, X7-2, and X7-8.
- [Sun Integrated Lights Out Manager Cabling Tables](#)  
This topic contains the tables for the Sun Integrated Lights Out Manager (ILOM) network cabling.
- [Administrative Gigabit Ethernet Port Cabling Tables](#)  
This topic contains the tables for the administrative Gigabit Ethernet network cabling.
- [Single Phase Power Distribution Unit Cabling Tables](#)  
The following topics contains the tables for a single phase power distribution unit (PDU) in an Oracle Exadata Database Machine X8-2, X8-8, X7-2, or X7-8.
- [Three-Phase Power Distribution Unit Cabling Tables](#)  
The following topics contains the tables for a three-phase power distribution unit (PDU) in an Oracle Exadata Database Machine X8-8, X8-2, X7-2, and X7-8.
- [InfiniBand Network Cabling Tables](#)  
This topic contains the tables for InfiniBand network cabling for Oracle Exadata Database Machine X8 and X7 racks.

### 13.1 Rack Layout Diagrams


The diagrams in this topic show the rack layout for Oracle Exadata Database Machine X8-2, X8-8, X7-2, and X7-8.

The slot numbers for each component is shown in the following images.

The following image shows the front and rear views of Oracle Exadata Database Machine X8-2 and X7-2 Full Rack. The front view is shown on the left, and the rear view is shown on the right.

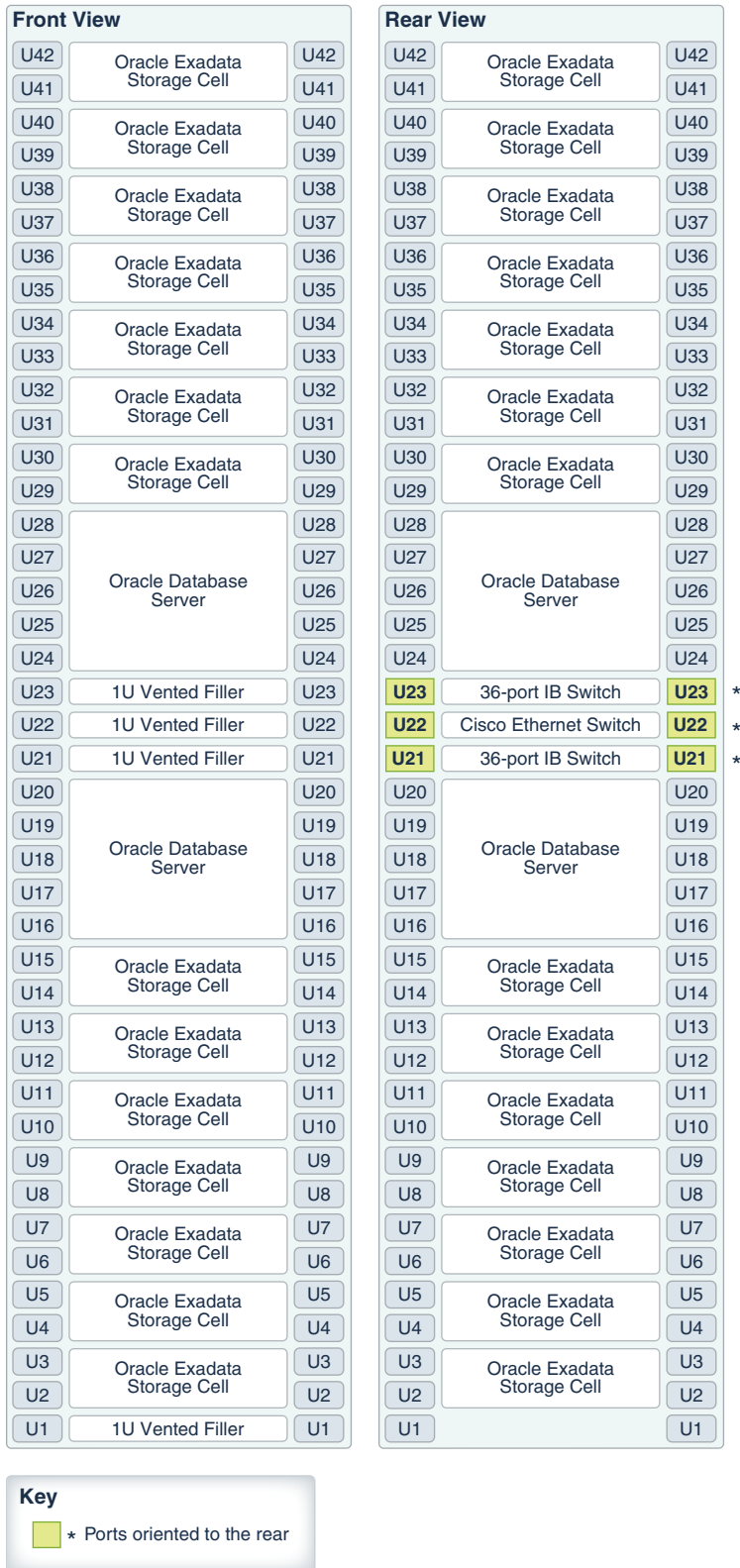
**Figure 13-1 Rack Layout of Oracle Exadata Database Machine X8-2 and X7-2 Full Rack**



**Key**  
 \* Ports oriented to the rear

The following image shows the front and rear views of Oracle Exadata Database Machine X8-8 and X7-8.

**Figure 13-2 Rack Layout of Oracle Exadata Database Machine X8-8 and X7-8**



## 13.2 Sun Integrated Lights Out Manager Cabling Tables

This topic contains the tables for the Sun Integrated Lights Out Manager (ILOM) network cabling.

The following tables are in this section:

- [Table 13-1](#) ILOM Cabling for Oracle Exadata Database Machine X8-2 and X7-2 Full Rack
- [Table 13-2](#) ILOM Cabling for Oracle Exadata Database Machine X8-8 and X7-8 Full Rack

In the following tables, *Un* denotes the unit height in the rack, where *n* is the number, such as U20. The cables used for Integrated Lights Out Manager (ILOM) are red in color.

**Table 13-1 ILOM Cabling for Oracle Exadata Database Machine X8-2 and X7-2 Full Rack**

From Rack Unit	Type of Equipment	Gigabit Ethernet Port
U39	Exadata Storage Server	2
U37	Exadata Storage Server	4
U35	Exadata Storage Server	6
U33	Exadata Storage Server	8
U31	Exadata Storage Server	10
U29	Exadata Storage Server	12
U27	Exadata Storage Server	14
U26	Database server	16
U25	Database server	18
U24	Database server	20
U23	Database server	22
U19	Database server	24
U18	Database server	26
U17	Database server	28
U16	Database server	30
U14	Exadata Storage Server	32
U12	Exadata Storage Server	34
U10	Exadata Storage Server	36
U8	Exadata Storage Server	38
U6	Exadata Storage Server	40
U4	Exadata Storage Server	42
U2	Exadata Storage Server	44

The following table shows the cable connections from the servers to the ILOM switch in Oracle Exadata Database Machine X8-8 and X7-8 Full Rack:

**Table 13-2 ILOM Cabling for Oracle Exadata Database Machine X8-8 and X7-8 Full Rack**

From Rack Unit	Type of Equipment	Gigabit Ethernet Port
U41	Exadata Storage Server	2
U39	Exadata Storage Server	4
U37	Exadata Storage Server	6
U35	Exadata Storage Server	8
U33	Exadata Storage Server	10
U31	Exadata Storage Server	12
U29	Exadata Storage Server	14
U24	Database server	16
U16	Database server	18
U14	Exadata Storage Server	20
U12	Exadata Storage Server	22
U10	Exadata Storage Server	24
U8	Exadata Storage Server	26
U6	Exadata Storage Server	28
U4	Exadata Storage Server	30
U2	Exadata Storage Server	32

## 13.3 Administrative Gigabit Ethernet Port Cabling Tables

This topic contains the tables for the administrative Gigabit Ethernet network cabling.

The Gigabit Ethernet switch is located in rack unit 21 on Oracle Exadata Database Machine X8-2, X8-8, X7-2, and X7-8 racks.

In the following tables, *Un* denotes the unit height in the rack, where *n* is the number, such as U20. The cables used for the Gigabit Ethernet switch are blue in color. The following tables are in this section:

- [Table 13-3](#) Gigabit Ethernet Cabling for Oracle Exadata Database Machine X8-2 and X7-2 Full Rack
- [Table 13-4](#) Gigabit Ethernet Cabling for Oracle Exadata Database Machine X8-8 and X7-8 Full Rack

**Table 13-3 Gigabit Ethernet Cabling for Oracle Exadata Database Machine X8-2 and X7-2 Full Rack**

From Rack Unit	Type of Equipment	Gigabit Ethernet Port
U39	Exadata Storage Server	1
U37	Exadata Storage Server	3
U35	Exadata Storage Server	5
U33	Exadata Storage Server	7

**Table 13-3 (Cont.) Gigabit Ethernet Cabling for Oracle Exadata Database Machine X8-2 and X7-2 Full Rack**

From Rack Unit	Type of Equipment	Gigabit Ethernet Port
U31	Exadata Storage Server	9
U29	Exadata Storage Server	11
U27	Exadata Storage Server	13
U26	Database server	15
U25	Database server	17
U24	Database server	19
U23	Database server	21
U22	Sun Datacenter InfiniBand Switch 36 switch	45
U20	Sun Datacenter InfiniBand Switch 36 switch	46
U19	Database server	23
U18	Database server	25
U17	Database server	27
U16	Database server	29
U14	Exadata Storage Server	31
U12	Exadata Storage Server	33
U10	Exadata Storage Server	35
U8	Exadata Storage Server	37
U6	Exadata Storage Server	39
U4	Exadata Storage Server	41
U2	Exadata Storage Server	43
U1	Sun Datacenter InfiniBand Switch 36 switch Note that the spine switch is no longer included by default on Exadata X4-2 and newer models, but port 47 is still reserved on the Cisco switch for the spine InfiniBand switch.	47

The following table shows the cable connections from the servers to the Gigabit Ethernet switch in Oracle Exadata Database Machine X8-8 and X7-8 Full Rack:

**Table 13-4 Gigabit Ethernet Cabling for Oracle Exadata Database Machine X8-8 and X7-8 Full Rack**

From Rack Unit	Type of Equipment	Gigabit Ethernet Port
U41	Exadata Storage Server	1
U39	Exadata Storage Server	3



**Table 13-4 (Cont.) Gigabit Ethernet Cabling for Oracle Exadata Database Machine X8-8 and X7-8 Full Rack**

From Rack Unit	Type of Equipment	Gigabit Ethernet Port
U37	Exadata Storage Server	5
U35	Exadata Storage Server	7
U33	Exadata Storage Server	9
U31	Exadata Storage Server	11
U29	Exadata Storage Server	13
U24	Database server	15
U23	Sun Datacenter InfiniBand Switch 36	33
U21	Sun Datacenter InfiniBand Switch 36	34
U16	Database server	17
U14	Exadata Storage Server	19
U12	Exadata Storage Server	21
U10	Exadata Storage Server	23
U8	Exadata Storage Server	25
U6	Exadata Storage Server	27
U4	Exadata Storage Server	29
U2	Exadata Storage Server	31
U1	Sun Datacenter InfiniBand Switch 36  Note that the spine switch is no longer included by default on Exadata X4-2 and newer models, but port 47 is still reserved on the Cisco switch for the spine InfiniBand switch.	35

## 13.4 Single Phase Power Distribution Unit Cabling Tables

The following topics contains the tables for a single phase power distribution unit (PDU) in an Oracle Exadata Database Machine X8-2, X8-8, X7-2, or X7-8.

- [Single Phase PDU Cabling for Oracle Exadata Database Machine X8-2 Full Rack](#)  
Single phase cabling for the Oracle Exadata Database Machine X8-2 Full Rack routes from each power distribution unit (PDU) to the power supplies.
- [Single Phase PDU Cabling for Oracle Exadata Database Machine X8-8 Full Rack](#)  
Single phase cabling for the Oracle Exadata Database Machine X8-8 Full Rack routes from each power distribution unit (PDU) to the power supplies.
- [Single Phase PDU Cabling for Oracle Exadata Database Machine X7-2 Full Rack](#)  
Single phase cabling for the Exadata Database Machine X7-2 Full Rack routes from each power distribution unit (PDU) to the power supplies.

- [Single Phase PDU Cabling for Oracle Exadata Database Machine X7-8 Full Rack](#)  
Single phase cabling for the Oracle Exadata Database Machine X7-8 Full Rack routes from each power distribution unit (PDU) to the power supplies.

## 13.4.1 Single Phase PDU Cabling for Oracle Exadata Database Machine X8-2 Full Rack

Single phase cabling for the Oracle Exadata Database Machine X8-2 Full Rack routes from each power distribution unit (PDU) to the power supplies.

The cables are terminated to PDU-A on the left (when looking at the rear of the rack), and routed to the right to enter CMA. The cables are bundled in groups of four. The PDU connections list the group and outlet on the PDU. So, for example, G5-5 refers to group 5 outlet 5.

**Table 13-5 Single Phase PDU Cabling for Oracle Exadata Database Machine X8-2 Full Rack**

Rack Unit	PDU-A/PSU 0	PDU-B/PSU 1	Cable Length
U42	G3-5	G2-1	2 meters
U41	G5-5	G0-1	2 meters
U40	G3-3	G2-3	2 meters
U39	G5-4	G0-2	2 meters
U37	G5-3	G0-3	2 meters
U35	G5-2	G0-4	2 meters
U33	G4-4	G1-2	2 meters
U31	G4-3	G1-3	2 meters
U29	G4-2	G1-4	2 meters
U27	G3-0	G2-6	2 meters
U26	G5-1	G0-5	2 meters
U25	G5-0	G0-6	2 meters
U24	G4-1	G1-5	2 meters
U23	G3-6	G2-0	2 meters
U22	G1-2	G4-4	2 meters
U21	G0-5	G5-1	2 meters
U20	G0-4	G5-2	2 meters
U19	G2-4	G3-2	2 meters
U18	G1-1	G4-5	2 meters
U17	G0-3	G5-3	2 meters
U16	G0-2	G5-4	2 meters
U14	G2-3	G3-3	2 meters
U12	G2-2	G3-4	2 meters
U10	G2-1	G3-5	2 meters
U8	G2-0	G3-6	2 meters

**Table 13-5 (Cont.) Single Phase PDU Cabling for Oracle Exadata Database Machine X8-2 Full Rack**

Rack Unit	PDU-A/PSU 0	PDU-B/PSU 1	Cable Length
U6	G1-0	G4-6	2 meters
U4	G0-1	G5-5	2 meters
U2	G0-0	G5-6	2 meters
U1	G4-0	G1-6	3 meters

## 13.4.2 Single Phase PDU Cabling for Oracle Exadata Database Machine X8-8 Full Rack

Single phase cabling for the Oracle Exadata Database Machine X8-8 Full Rack routes from each power distribution unit (PDU) to the power supplies.

The cables are terminated to PDU-A on the left (when looking at the rear of the rack), and routed to the right to enter CMA. The cables are bundled in groups of four. The PDU connections in the table below list the group and outlet on the PDU. So, for example, G5-5 refers to group 5 outlet 5.

**Table 13-6 Single Phase PDU Cabling for Oracle Exadata Database Machine X8-8 Full Rack**

Rack Unit	PDU-A/PSU 0	PDU-B/PSU 1	Cable Length
U41	G3-5	G2-1	2 meters
U39	G5-4	G0-2	2 meters
U37	G5-2	G0-4	2 meters
U35	G5-0	G0-6	2 meters
U33	G4-6	G1-0	2 meters
U31	G4-3	G1-3	2 meters
U29	G3-6	G2-0	2 meters
U24	G2-7 (PS2)	G3-7 (PS3)	2 meters
U24	G4-7	G1-7	2 meters
U23	G3-1	G2-5	2 meters
U22	G2-6	G3-0	2 meters
U21	G3-0	G2-6	2 meters
U16	G1-7 (PS2)	G4-7 (PS3)	2 meters
U16	G3-7	G2-7	2 meters
U14 (only 2 DB servers)	G2-0	G3-6	2 meters
U12 (only 2 DB servers)	G1-3	G4-3	2 meters
U10 (only 2 DB servers)	G1-0	G4-6	2 meters
U10 (3 DB servers)	G0-7 (PS2)	G5-7 (PS3)	2 meters
U10 (3 DB servers)	G5-7	G0-7	2 meters

**Table 13-6 (Cont.) Single Phase PDU Cabling for Oracle Exadata Database Machine X8-8 Full Rack**

Rack Unit	PDU-A/PSU 0	PDU-B/PSU 1	Cable Length
U8	G0-6	G5-0	2 meters
U6	G0-4	G5-2	2 meters
U4	G0-3	G5-3	2 meters
U2	G0-1	G5-5	2 meters
U1	G0-0	G5-6	3 meters

### 13.4.3 Single Phase PDU Cabling for Oracle Exadata Database Machine X7-2 Full Rack

Single phase cabling for the Exadata Database Machine X7-2 Full Rack routes from each power distribution unit (PDU) to the power supplies.

The cables are terminated to PDU-A on the left, and routed to the right to enter CMA, and are bundled in groups of four.

**Table 13-7 Single Phase PDU Cabling for Oracle Exadata Database Machine X7-2 Full Rack**

Rack Unit	PDU-A/PSU 0	PDU-B/PSU 1	Cable Length
U42	G5-5	G0-1	2 meters
U41	G3-6	G2-0	2 meters
U40	G5-2	G0-4	2 meters
U39	G5-6	G0-0	2 meters
U37	G5-3	G0-3	2 meters
U35	G5-1	G0-5	2 meters
U33	G5-0	G0-6	2 meters
U31	G4-4	G1-2	2 meters
U29	G4-3	G1-3	2 meters
U27	G3-5	G2-1	2 meters
U26	G4-5	G1-1	2 meters
U25	G4-2	G1-4	2 meters
U24	G4-1	G1-5	2 meters
U23	G2-5	G3-1	2 meters
U22	G1-4	G4-2	2 meters
U21	G1-3	G4-3	2 meters
U20	G1-5	G4-1	2 meters
U19	G2-3	G3-3	2 meters
U18	G2-2	G3-4	2 meters

**Table 13-7 (Cont.) Single Phase PDU Cabling for Oracle Exadata Database Machine X7-2 Full Rack**

Rack Unit	PDU-A/PSU 0	PDU-B/PSU 1	Cable Length
U17	G1-6	G4-0	2 meters
U16	G1-2	G4-4	2 meters
U14	G2-4	G3-2	2 meters
U12	G2-1	G3-5	2 meters
U10	G2-0	G3-6	2 meters
U8	G1-0	G4-6	2 meters
U6	G0-6	G5-0	2 meters
U4	G0-4	G5-2	2 meters
U2	G0-2	G5-4	2 meters
U1	G4-0	G1-6	3 meters

### 13.4.4 Single Phase PDU Cabling for Oracle Exadata Database Machine X7-8 Full Rack

Single phase cabling for the Oracle Exadata Database Machine X7-8 Full Rack routes from each power distribution unit (PDU) to the power supplies.

The cables are terminated to PDU-A on the left, and routed to the right to enter CMA, and are bundled in groups of four.

**Table 13-8 Single Phase PDU Cabling for Oracle Exadata Database Machine X7-8 Full Rack**

Rack Unit	PDU-A/PS-00	PDU-B/PS-01	Cable Length
U41	G5-6	G0-0	2 meters
U39	G5-4	G0-2	2 meters
U37	G5-2	G0-4	2 meters
U35	G5-0	G0-6	2 meters
U33	G4-6	G1-0	2 meters
U31	G4-3	G1-3	2 meters
U29	G3-6	G2-0	2 meters
U24	G4-7 (C19) (AC0)	G1-7 (C19) (AC1)	1 meter
U24	G2-7 (C19) (AC2)	G3-7 (C19) (AC3)	1 meter
U23	G3-1	G2-5	2 meters
U22	G2-6 (PS-2)	G3-0 (PS-1)	2 meters
U21	G3-0	G2-6	2 meters
U16	G3-7 (C19) (AC0)	G2-7 (C19) (AC1)	1 meter
U16	G1-7 (C19) (AC2)	G4-7 (C19) (AC3)	1 meter

**Table 13-8 (Cont.) Single Phase PDU Cabling for Oracle Exadata Database Machine X7-8 Full Rack**

Rack Unit	PDU-A/PS-00	PDU-B/PS-01	Cable Length
U14	G2-0	G3-6	2 meters
U12	G1-3	G4-3	2 meters
U10	G1-0	G4-6	2 meters
U8	G0-6	G5-0	2 meters
U6	G0-4	G5-2	2 meters
U4	G0-3	G5-3	2 meters
U2	G0-1	G5-5	2 meters
U1	G0-0	G5-6	2 meters

## 13.5 Three-Phase Power Distribution Unit Cabling Tables

The following topics contains the tables for a three-phase power distribution unit (PDU) in an Oracle Exadata Database Machine X8-8, X8-2, X7-2, and X7-8.

- [Three-Phase PDU Cabling for Oracle Exadata Database Machine X8-2 Full Rack](#)  
Three-phase cabling for the Oracle Exadata Database Machine X8-2 Full Rack routes from each power distribution unit (PDU) to the power supplies configured in each rack.
- [Three Phase PDU Cabling for Oracle Exadata Database Machine X8-8 Full Rack](#)  
Three-phase cabling for the Oracle Exadata Database Machine X8-8 Full Rack routes from each power distribution unit (PDU) to the power supplies configured in each rack.
- [Three-Phase PDU Cabling for Oracle Exadata Database Machine X7-2 Full Rack](#)  
Three-phase cabling for the Oracle Exadata Database Machine X7-2 Full Rack routes from each power distribution unit (PDU) to the power supplies configured in each rack.
- [Three Phase PDU Cabling for Oracle Exadata Database Machine X7-8 Full Rack](#)  
Three-phase cabling for the Exadata Database Machine X7-2 Full Rack routes from each power distribution unit (PDU) to the power supplies configured in each rack.

### 13.5.1 Three-Phase PDU Cabling for Oracle Exadata Database Machine X8-2 Full Rack

Three-phase cabling for the Oracle Exadata Database Machine X8-2 Full Rack routes from each power distribution unit (PDU) to the power supplies configured in each rack.

The cables are terminated to PDU-A on the left (when looking at the rear of the rack), and routed to the right to enter CMA. The cables are bundled in groups of four. The PDU connections list the group and outlet on the PDU. So, for example, G5-5 refers to group 5 outlet 5.

**Table 13-9 Three Phase PDU Cabling for Oracle Exadata Database Machine X8-2 Full Rack**

Rack Unit	PDU-A/PSU 0	PDU-B/PSU 1	Cable Length
U42	G5-6	G2-0	2 meters
U41	G5-3	G2-3	2 meters
U40	G3-5	G0-1	2 meters
U39	G4-3	G1-3	2 meters
U37	G5-2	G2-4	2 meters
U35	G3-2	G0-4	2 meters
U33	G4-2	G1-4	2 meters
U31	G5-1	G2-5	2 meters
U29	G3-6	G0-0	2 meters
U27	G4-1	G1-5	2 meters
U26	G3-1	G0-5	2 meters
U25	G4-0	G1-6	2 meters
U24	G3-0	G0-6	2 meters
U23	G2-6	G5-0	2 meters
U22	G1-5	G4-1	2 meters
U21	G2-4	G5-2	2 meters
U20	G1-4	G4-2	2 meters
U19	G0-6	G3-0	2 meters
U18	G2-3	G5-3	2 meters
U17	G0-2	G3-4	2 meters
U16	G0-1	G3-5	2 meters
U14	G1-3	G4-3	2 meters
U12	G1-2	G4-4	2 meters
U10	G1-1	G4-5	2 meters
U8	G2-2	G5-4	2 meters
U6	G0-0	G3-6	2 meters
U4	G2-1	G5-5	2 meters
U2	G2-0	G5-6	2 meters
U1	G1-0	G4-6	3 meters

## 13.5.2 Three Phase PDU Cabling for Oracle Exadata Database Machine X8-8 Full Rack

Three-phase cabling for the Oracle Exadata Database Machine X8-8 Full Rack routes from each power distribution unit (PDU) to the power supplies configured in each rack.

The cables are terminated to PDU-A on the left (when looking at the rear of the rack), and routed to the right to enter CMA. The cables are bundled in groups of four. The PDU

connections list the group and outlet on the PDU. So, for example, G5-5 refers to group 5 outlet 5.

**Table 13-10 Three Phase PDU Cabling for Oracle Exadata Database Machine X8-8 Full Rack**

Rack Unit	PDU-A/PSU 0	PDU-B/PSU 1	Cable Length
U41	G5-5	G2-1	2 meters
U39	G5-4	G2-2	2 meters
U37	G5-2	G2-4	2 meters
U35	G5-1	G2-5	2 meters
U33	G5-0	G2-6	2 meters
U31	G4-6	G1-0	2 meters
U29	G4-4	G1-2	2 meters
U24	G3-7 (PS2)	G0-7 (PS3)	2 meters
U24	G4-7	G1-7	2 meters
U23	G3-1	G0-5	2 meters
U22	G3-0	G0-6	2 meters
U21	G2-5	G5-1	2 meters
U16	G2-7 (PS2)	G5-7 (PS3)	2 meters
U16	G1-7	G4-7	2 meters
U14 (only 2 DB servers)	G1-3	G4-3	2 meters
U12 (only 2 DB servers)	G1-0	G4-6	2 meters
U10 (only 2 DB servers)	G0-6	G3-0	2 meters
U10 (3 DB servers)	G5-7 (PS2)	G2-7 (PS3)	2 meters
U10 (3 DB servers)	G0-7	G3-7	2 meters
U8	G0-5	G3-1	2 meters
U6	G0-4	G3-2	2 meters
U4	G0-2	G3-4	2 meters
U2	G0-1	G3-5	2 meters
U1	G0-0	G3-6	3 meters

### 13.5.3 Three-Phase PDU Cabling for Oracle Exadata Database Machine X7-2 Full Rack

Three-phase cabling for the Oracle Exadata Database Machine X7-2 Full Rack routes from each power distribution unit (PDU) to the power supplies configured in each rack.

The cables are terminated to PDU-A on the left (when looking at the rear of the rack), and routed to the right to enter CMA. The cables are bundled in groups of four. The PDU connections list the group and outlet on the PDU. So, for example, G5-5 refers to group 5 outlet 5.



**Table 13-11 Three Phase PDU Cabling for Oracle Exadata Database Machine X7-2 Full Rack**

Rack Unit	PDU-A/PSU 0	PDU-B/PSU 1	Cable Length
U42	G5-4	G2-2	2 meters
U41	G5-6	G2-0	2 meters
U40	G4-6	G1-0	2 meters
U39	G4-5	G1-1	2 meters
U37	G3-5	G0-1	2 meters
U35	G5-5	G2-1	2 meters
U33	G4-3	G1-3	2 meters
U31	G3-1	G0-5	2 meters
U29	G4-0	G1-6	2 meters
U27	G5-3	G2-3	2 meters
U26	G5-1	G2-5	2 meters
U25	G3-3	G0-3	2 meters
U24	G4-4	G1-2	2 meters
U23	G3-2	G0-4	2 meters
U22	G2-6	G5-0	2 meters
U21	G1-0	G4-6	2 meters
U20	G0-0	G3-6	2 meters
U19	G2-5	G5-1	2 meters
U18	G0-6	G3-0	2 meters
U17	G1-6	G4-0	2 meters
U16	G2-1	G5-5	2 meters
U14	G1-4	G4-2	2 meters
U12	G2-3	G5-3	2 meters
U10	G2-0	G5-6	2 meters
U8	G1-2	G4-4	2 meters
U6	G1-1	G4-5	2 meters
U4	G0-2	G3-4	2 meters
U2	G0-1	G3-5	2 meters
U1	G2-2	G5-4	3 meters

### 13.5.4 Three Phase PDU Cabling for Oracle Exadata Database Machine X7-8 Full Rack

Three-phase cabling for the Exadata Database Machine X7-2 Full Rack routes from each power distribution unit (PDU) to the power supplies configured in each rack.

The cables are terminated to PDU-A on the left, and routed to the right to enter CMA, and are bundled in groups of four.

**Table 13-12 Three Phase PDU Cabling for Oracle Exadata Database Machine X7-8 Full Rack**

Rack Unit	PDU-A/PS-00	PDU-B/PS-01	Cable Length
U41	G5-5	G2-1	2 meters
U39	G5-4	G2-2	2 meters
U37	G5-2	G2-4	2 meters
U35	G5-1	G2-5	2 meters
U33	G5-0	G2-6	2 meters
U31	G4-6	G1-0	2 meters
U29	G4-4	G1-2	2 meters
U24	AC0 to G4-7 (C19)	AC1 to G1-7 (C19)	1 meter
U24	AC2 to G3-7 (C19)	AC3 to G0-7 (C19)	1 meter
U23	G3-1	G0-5	2 meters
U22	G3-0	G0-6	2 meters
U21	G2-5	G5-1	2 meters
U16	AC0 to G1-7 (C19)	AC1 to G4-7 (C19)	1 meter
U16	AC2 to G2-7 (C19)	AC3 to G5-7 (C19)	1 meter
U14	G1-3	G4-3	2 meters
U12	G1-0	G4-6	2 meters
U10	G0-6	G3-0	2 meters
U8	G0-5	G3-1	2 meters
U6	G0-4	G3-2	2 meters
U4	G0-2	G3-4	2 meters
U2	G0-1	G3-5	2 meters
U1	G0-0	G3-6	2 meters

## 13.6 InfiniBand Network Cabling Tables

This topic contains the tables for InfiniBand network cabling for Oracle Exadata Database Machine X8 and X7 racks.

The Sun Datacenter InfiniBand Switch 36 switches are located in rack units 20 and 22. If present, the optional spine switch is located in rack unit 1.

In the following tables, *Un* denotes the unit height in the rack, where *n* is the number, such as U20. *Pn* denotes the InfiniBand port *n*, where *n* is port number, such as P1. The cables used for the InfiniBand switch are black in color. The following tables are in this section:

- [Table 13-13](#) InfiniBand Network Cabling for Oracle Exadata Database Machine X8-2 and X7-2 Full Rack
- [Table 13-14](#) InfiniBand Network Cabling for Oracle Exadata Database Machine X8-8 and X7-8 Full Rack

The following table lists the location, ports and cables for the InfiniBand connections for Oracle Exadata Database Machine X8-2 and X7-2 Full Rack.

**Table 13-13 InfiniBand Network Cabling for Oracle Exadata Database Machine X8-2 and X7-2 Full Rack**

From InfiniBand Switch Rack Unit	Port	To Rack Unit	Type of Equipment	Port	Cable Description
U22	0A	U39	Oracle Exadata Storage Server	PCle 7, P1	3 meter QDR InfiniBand cable
U22	0B	U37	Oracle Exadata Storage Server	PCle 7, P1	3 meter QDR InfiniBand cable
U22	1A	U35	Oracle Exadata Storage Server	PCle 7, P1	3 meter QDR InfiniBand cable
U22	1B	U33	Oracle Exadata Storage Server	PCle 7, P1	3 meter QDR InfiniBand cable
U22	2A	U31	Oracle Exadata Storage Server	PCle 7, P1	3 meter QDR InfiniBand cable
U22	2B	U29	Oracle Exadata Storage Server	PCle 7, P1	3 meter QDR InfiniBand cable
U22	3B	U27	Oracle Exadata Storage Server	PCle 7, P1	3 meter QDR InfiniBand cable
U22	3A	U26	Oracle Exadata Database Server	PCle 2, P1	2 meter QDR InfiniBand cable
U22	4A	U25	Oracle Exadata Database Server	PCle 2, P1	2 meter QDR InfiniBand cable
U22	4B	U24	Oracle Exadata Database Server	PCle 2, P1	2 meter QDR InfiniBand cable
U22	5A	U23	Oracle Exadata Database Server	PCle 2, P1	2 meter QDR InfiniBand cable
U22	12B	U19	Oracle Exadata Database Server	PCle 2, P2	2 meter QDR InfiniBand cable
U22	13A	U18	Oracle Exadata Database Server	PCle 2, P2	2 meter QDR InfiniBand cable
U22	13B	U17	Oracle Exadata Database Server	PCle 2, P2	2 meter QDR InfiniBand cable

**Table 13-13 (Cont.) InfiniBand Network Cabling for Oracle Exadata Database Machine X8-2 and X7-2 Full Rack**

From InfiniBand Switch Rack Unit	Port	To Rack Unit	Type of Equipment	Port	Cable Description
U22	14B	U16	Oracle Exadata Database Server	PCIe 2, P2	2 meter QDR InfiniBand cable
U22	14A	U14	Oracle Exadata Storage Server	PCIe 7, P2	3 meter QDR InfiniBand cable
U22	15A	U12	Oracle Exadata Storage Server	PCIe 7, P2	3 meter QDR InfiniBand cable
U22	15B	U10	Oracle Exadata Storage Server	PCIe 7, P2	3 meter QDR InfiniBand cable
U22	16A	U8	Oracle Exadata Storage Server	PCIe 7, P2	3 meter QDR InfiniBand cable
U22	16B	U6	Oracle Exadata Storage Server	PCIe 7, P2	3 meter QDR InfiniBand cable
U22	17A	U4	Oracle Exadata Storage Server	PCIe 7, P2	3 meter QDR InfiniBand cable
U22	17B	U2	Oracle Exadata Storage Server	PCIe 7, P2	3 meter QDR InfiniBand cable
U20	0A	U39	Oracle Exadata Storage Server	PCIe 7, P2	3 meter QDR InfiniBand cable
U20	0B	U37	Oracle Exadata Storage Server	PCIe 7, P2	3 meter QDR InfiniBand cable
U20	1A	U35	Oracle Exadata Storage Server	PCIe 7, P2	3 meter QDR InfiniBand cable
U20	1B	U33	Oracle Exadata Storage Server	PCIe 7, P2	3 meter QDR InfiniBand cable
U20	2A	U31	Oracle Exadata Storage Server	PCIe 7, P2	3 meter QDR InfiniBand cable
U20	2B	U29	Oracle Exadata Storage Server	PCIe 7, P2	3 meter QDR InfiniBand cable

**Table 13-13 (Cont.) InfiniBand Network Cabling for Oracle Exadata Database Machine X8-2 and X7-2 Full Rack**

From InfiniBand Switch Rack Unit	Port	To Rack Unit	Type of Equipment	Port	Cable Description
U20	3B	U27	Oracle Exadata Storage Server	PCIe 7, P2	3 meter QDR InfiniBand cable
U20	3A	U26	Oracle Exadata Database Server	PCIe 2, P2	2 meter QDR InfiniBand cable
U20	4A	U25	Oracle Exadata Database Server	PCIe 2, P2	2 meter QDR InfiniBand cable
U20	4B	U24	Oracle Exadata Database Server	PCIe 2, P2	2 meter QDR InfiniBand cable
U20	5A	U23	Oracle Exadata Database Server	PCIe 2, P2	2 meter QDR InfiniBand cable
U20	12B	U19	Oracle Exadata Database Server	PCIe 2, P1	2 meter QDR InfiniBand cable
U20	13A	U18	Oracle Exadata Database Server	PCIe 2, P1	2 meter QDR InfiniBand cable
U20	13B	U17	Oracle Exadata Database Server	PCIe 2, P1	2 meter QDR InfiniBand cable
U20	14B	U16	Oracle Exadata Database Server	PCIe 2, P1	2 meter QDR InfiniBand cable
U20	14A	U14	Oracle Exadata Storage Server	PCIe 7, P1	2 meter QDR InfiniBand cable
U20	15A	U12	Oracle Exadata Storage Server	PCIe 7, P1	3 meter QDR InfiniBand cable
U20	15B	U10	Oracle Exadata Storage Server	PCIe 7, P1	3 meter QDR InfiniBand cable
U20	16A	U8	Oracle Exadata Storage Server	PCIe 7, P1	3 meter QDR InfiniBand cable
U20	16B	U6	Oracle Exadata Storage Server	PCIe 7, P1	3 meter QDR InfiniBand cable

**Table 13-13 (Cont.) InfiniBand Network Cabling for Oracle Exadata Database Machine X8-2 and X7-2 Full Rack**

From InfiniBand Switch Rack Unit	Port	To Rack Unit	Type of Equipment	Port	Cable Description
U20	17A	U4	Oracle Exadata Storage Server	PCIe 7, P1	3 meter QDR InfiniBand cable
U20	17B	U2	Oracle Exadata Storage Server	PCIe 7, P1	3 meter QDR InfiniBand cable
U20	9B	U22	Sun Datacenter InfiniBand Switch 36 switch	9A	1 meter QDR InfiniBand cable
U20	10B	U22	Sun Datacenter InfiniBand Switch 36 switch	10A	1 meter QDR InfiniBand cable
U20	11B	U22	Sun Datacenter InfiniBand Switch 36 switch	11A	1 meter QDR InfiniBand cable
U20	8A	U22	Sun Datacenter InfiniBand Switch 36 switch	8A	1 meter QDR InfiniBand cable
U20	9A	U22	Sun Datacenter InfiniBand Switch 36 switch	9B	1 meter QDR InfiniBand cable
U20	10A	U22	Sun Datacenter InfiniBand Switch 36 switch	10B	1 meter QDR InfiniBand cable
U20	11A	U22	Sun Datacenter InfiniBand Switch 36 switch	11B	1 meter QDR InfiniBand cable
U1 — when added as an optional configuration	1B	U20	Sun Datacenter InfiniBand Switch 36 switch	8B	3 meter QDR InfiniBand cable
U1 — when added as an optional configuration	0B	U22	Sun Datacenter InfiniBand Switch 36 switch	8B	3 meter QDR InfiniBand cable

The following table lists the location, ports and cables for the InfiniBand connections for Oracle Exadata Database Machine X8-8 and X7-8 Full Rack.

**Table 13-14 InfiniBand Network Cabling for Oracle Exadata Database Machine X8-8 and X7-8 Full Rack**

From InfiniBand Switch Rack Unit	Port	To Rack Unit	Type of Equipment	Port	Cable Description
U23	0A	U41	Oracle Exadata Storage Server	3 PCIe3 P1	3 meter QDR InfiniBand cable
U23	0B	U39	Oracle Exadata Storage Server	3 PCIe3 P1	3 meter QDR InfiniBand cable
U23	1A	U37	Oracle Exadata Storage Server	3 PCIe3 P1	3 meter QDR InfiniBand cable
U23	1B	U35	Oracle Exadata Storage Server	3 PCIe3 P1	3 meter QDR InfiniBand cable
U23	2A	U33	Oracle Exadata Storage Server	3 PCIe3 P1	3 meter QDR InfiniBand cable
U23	2B	U31	Oracle Exadata Storage Server	3 PCIe3 P1	3 meter QDR InfiniBand cable
U23	3B	U29	Oracle Exadata Storage Server	3 PCIe3 P1	3 meter QDR InfiniBand cable
U23	3A	U24	Oracle Exadata Database Server	12 PCIe3 P1	2 meter QDR InfiniBand cable
U23	4A	U24	Oracle Exadata Database Server	10 PCIe3 P1	2 meter QDR InfiniBand cable
U23	4B	U24	Oracle Exadata Database Server	8 PCIe3 P1	2 meter QDR InfiniBand cable
U23	5A	U24	Oracle Exadata Database Server	6 PCIe3 P1	2 meter QDR InfiniBand cable
U23	13A	U16	Oracle Exadata Database Server	10 PCIe3 P2	2 meter QDR InfiniBand cable
U23	13B	U16	Oracle Exadata Database Server	8 PCIe3 P2	2 meter QDR InfiniBand cable
U23	14B	U16	Oracle Exadata Database Server	6 PCIe3 P2	2 meter QDR InfiniBand cable

**Table 13-14 (Cont.) InfiniBand Network Cabling for Oracle Exadata Database Machine X8-8 and X7-8 Full Rack**

From InfiniBand Switch Rack Unit	Port	To Rack Unit	Type of Equipment	Port	Cable Description
U23	12B	U16	Oracle Exadata Database Server	12 PCIe3 P2	2 meter QDR InfiniBand cable
U23	14A	U14	Oracle Exadata Storage Server	3 PCIe3 P2	3 meter QDR InfiniBand cable
U23	15A	U12	Oracle Exadata Storage Server	3 PCIe3 P2	3 meter QDR InfiniBand cable
U23	15B	U10	Oracle Exadata Storage Server	3 PCIe3 P2	3 meter QDR InfiniBand cable
U23	16A	U8	Oracle Exadata Storage Server	3 PCIe3 P2	3 meter QDR InfiniBand cable
U23	16B	U6	Oracle Exadata Storage Server	3 PCIe3 P2	3 meter QDR InfiniBand cable
U23	17A	U4	Oracle Exadata Storage Server	3 PCIe3 P2	3 meter QDR InfiniBand cable
U23	17B	U2	Oracle Exadata Storage Server	3 PCIe3 P2	3 meter QDR InfiniBand cable
U21	0A	U41	Oracle Exadata Storage Server	3 PCIe3 P2	3 meter QDR InfiniBand cable
U21	0B	U39	Oracle Exadata Storage Server	3 PCIe3 P2	3 meter QDR InfiniBand cable
U21	1A	U37	Oracle Exadata Storage Server	3 PCIe3 P2	3 meter QDR InfiniBand cable
U21	1B	U35	Oracle Exadata Storage Server	3 PCIe3 P2	3 meter QDR InfiniBand cable
U21	2A	U33	Oracle Exadata Storage Server	3 PCIe3 P2	3 meter QDR InfiniBand cable
U21	2B	U31	Oracle Exadata Storage Server	3 PCIe3 P2	3 meter QDR InfiniBand cable



**Table 13-14 (Cont.) InfiniBand Network Cabling for Oracle Exadata Database Machine X8-8 and X7-8 Full Rack**

From InfiniBand Switch Rack Unit	Port	To Rack Unit	Type of Equipment	Port	Cable Description
U21	3B	U29	Oracle Exadata Storage Server	3 PCIe3 P2	3 meter QDR InfiniBand cable
U21	3A	U24	Oracle Exadata Database Server	12 PCIe3 P2	2 meter QDR InfiniBand cable
U21	4A	U24	Oracle Exadata Database Server	10 PCIe3 P2	2 meter QDR InfiniBand cable
U21	4B	U24	Oracle Exadata Database Server	8 PCIe3 P2	2 meter QDR InfiniBand cable
U21	5A	U24	Oracle Exadata Database Server	6 PCIe3 P2	2 meter QDR InfiniBand cable
U21	12B	U16	Oracle Exadata Database Server	12 PCIe3 P1	2 meter QDR InfiniBand cable
U21	13A	U16	Oracle Exadata Database Server	10 PCIe3 P1	2 meter QDR InfiniBand cable
U21	13B	U16	Oracle Exadata Database Server	8 PCIe3 P1	2 meter QDR InfiniBand cable
U21	14B	U16	Oracle Exadata Database Server	6 PCIe3 P1	2 meter QDR InfiniBand cable
U21	14A	U14	Oracle Exadata Storage Server	3 PCIe3 P1	2 meter QDR InfiniBand cable
U21	15A	U12	Oracle Exadata Storage Server	3 PCIe3 P1	3 meter QDR InfiniBand cable
U21	15B	U10	Oracle Exadata Storage Server	3 PCIe3 P1	3 meter QDR InfiniBand cable
U21	16A	U8	Oracle Exadata Storage Server	3 PCIe3 P1	3 meter QDR InfiniBand cable
U21	16B	U6	Oracle Exadata Storage Server	3 PCIe3 P1	3 meter QDR InfiniBand cable

**Table 13-14 (Cont.) InfiniBand Network Cabling for Oracle Exadata Database Machine X8-8 and X7-8 Full Rack**

From InfiniBand Switch Rack Unit	Port	To Rack Unit	Type of Equipment	Port	Cable Description
U21	17A	U4	Oracle Exadata Storage Server	3 PCIe3 P1	3 meter QDR InfiniBand cable
U21	17B	U2	Oracle Exadata Storage Server	3 PCIe3 P1	3 meter QDR InfiniBand cable
U21	9B	U23	Sun Datacenter InfiniBand Switch 36 switch	9A	1 meter QDR InfiniBand cable
U21	10B	U23	Sun Datacenter InfiniBand Switch 36 switch	10A	1 meter QDR InfiniBand cable
U21	11B	U23	Sun Datacenter InfiniBand Switch 36 switch	11A	1 meter QDR InfiniBand cable
U21	8A	U23	Sun Datacenter InfiniBand Switch 36 switch	8A	1 meter QDR InfiniBand cable
U21	9A	U23	Sun Datacenter InfiniBand Switch 36 switch	9B	1 meter QDR InfiniBand cable
U21	10A	U23	Sun Datacenter InfiniBand Switch 36 switch	10B	1 meter QDR InfiniBand cable
U21	11A	U23	Sun Datacenter InfiniBand Switch 36 switch	11B	1 meter QDR InfiniBand cable
U1 — when added as an optional configuration	1B	U21	Sun Datacenter InfiniBand Switch 36 switch	8B	3 meter QDR InfiniBand cable
U1 — when added as an optional configuration	0B	U23	Sun Datacenter InfiniBand Switch 36 switch	8B	3 meter QDR InfiniBand cable

# 14

## Cabling Tables for Oracle Exadata Database Machine X6-2, X6-8, X5-2, and X5-8

The tables in this chapter show the cable layouts for Oracle Exadata Database Machine X6-2, X6-8, X5-2, and X5-8.

- [Rack Layout Diagrams](#)  
The diagrams in this topic show the rack layout for Oracle Exadata Database Machine X6-2, X6-8, X5-2, and X5-8.
- [Sun Integrated Lights Out Manager Cabling Tables](#)
- [Administrative Gigabit Ethernet Port Cabling Tables](#)  
This section contains the tables for the administrative Gigabit Ethernet network cabling.
- [Single Phase Power Distribution Unit Cabling Tables](#)
- [Three Phase Power Distribution Unit Cabling Tables](#)  
This section contains the tables for three phase cabling from each power distribution unit (PDU) to the power supplies configured in each rack.
- [InfiniBand Network Cabling Tables](#)  
This topic contains the tables for the InfiniBand network cabling for Oracle Exadata Database Machine X5 and X6 racks.

### 14.1 Rack Layout Diagrams

The diagrams in this topic show the rack layout for Oracle Exadata Database Machine X6-2, X6-8, X5-2, and X5-8.



#### Note:

For ease of reading, the name "Oracle Exadata Rack" is used when information refers to both Oracle Exadata Database Machine and Oracle Exadata Storage Expansion Rack.

The following abbreviations are used in the tables:

Abbreviation	Description
$R_n$	Rack $n$ , where $n$ is the number of the rack, such as R1.
$U_n$	Unit height in rack, where $n$ is the number, such as U20.
$P_n$	InfiniBand port $n$ , where $n$ is port number, such as P8A.

The cables used in Oracle Exadata Database Machine are color-coded as follows:

- Black: InfiniBand cables, or AC power jumper cables
- Red: Integrated Lights Out Manager (ILOM) cables
- Blue: Gigabit Ethernet cables

The following figure shows the front and rear views of Oracle Exadata Database Machine X5-2 and X6-2 Full Rack. The front is shown on the left, and the rear is shown on the right.

**Figure 14-1 Rack Layout of Oracle Exadata Database Machine X6-2 and X5-2 Full Rack**

Front View			Rear View		
U42	1U Solid Filler	U42	U42	1U Solid Filler	U42
U41	1U Solid Filler	U41	U41	1U Solid Filler	U41
U40	Oracle Exadata storage cell	U40	U40	Oracle Exadata storage cell	U40
U39		U39	U39		
U38	Oracle Exadata storage cell	U38	U38	Oracle Exadata storage cell	U38
U37		U37	U37		
U36	Oracle Exadata storage cell	U36	U36	Oracle Exadata storage cell	U36
U35		U35	U35		
U34	Oracle Exadata storage cell	U34	U34	Oracle Exadata storage cell	U34
U33		U33	U33		
U32	Oracle Exadata storage cell	U32	U32	Oracle Exadata storage cell	U32
U31		U31	U31		
U30	Oracle Exadata storage cell	U30	U30	Oracle Exadata storage cell	U30
U29		U29	U29		
U28	Oracle Exadata storage cell	U28	U28	Oracle Exadata storage cell	U28
U27		U27	U27		
U26	Oracle Database Server	U26	U26	Oracle Database Server	U26
U25	Oracle Database Server	U25	U25	Oracle Database Server	U25
U24	Oracle Database Server	U24	U24	Oracle Database Server	U24
U23	Oracle Database Server	U23	U23	Oracle Database Server	U23
U22	1U Vented Filler	U22	U22	36-Port IB Switch	U22
U21	1U Vented Filler	U21	U21	Cisco 4948	U21
U20	1U Vented Filler	U20	U20	36-Port IB Switch	U20
U19	Oracle Database Server	U19	U19	Oracle Database Server	U19
U18	Oracle Database Server	U18	U18	Oracle Database Server	U18
U17	Oracle Database Server	U17	U17	Oracle Database Server	U17
U16	Oracle Database Server	U16	U16	Oracle Database Server	U16
U15	Oracle Exadata storage cell	U15	U15	Oracle Exadata storage cell	U15
U14		U14	U14		
U13	Oracle Exadata storage cell	U13	U13	Oracle Exadata storage cell	U13
U12		U12	U12		
U11	Oracle Exadata storage cell	U11	U11	Oracle Exadata storage cell	U11
U10		U10	U10		
U9	Oracle Exadata storage cell	U9	U9	Oracle Exadata storage cell	U9
U8		U8	U8		
U7	Oracle Exadata storage cell	U7	U7	Oracle Exadata storage cell	U7
U6		U6	U6		
U5	Oracle Exadata storage cell	U5	U5	Oracle Exadata storage cell	U5
U4		U4	U4		
U3	Oracle Exadata storage cell	U3	U3	Oracle Exadata storage cell	U3
U2		U2	U2		
U1	1U Solid Filler	U1	U1		U1

 \* Ports oriented to the rear

The following figure shows the front and rear views of Oracle Exadata Database Machine X6-2 and X5-2 Half Rack.

**Figure 14-2 Rack Layout for Oracle Exadata Database Machine X6-2 and X5-2 Half Rack**

Front View			Rear View			
U42	4U Solid Filler	U42	U42		U42	
U41		U41	U41			
U40		U40	U40			
U39		U39	U39			
U38	4U Solid Filler	U38	U38			
U37		U37	U37			
U36		U36	U36			
U35		U35	U35			
U34	2U Solid Filler	U34	U34			
U33		U33	U33			
U32	2U Solid Filler	U32	U32			
U31		U31	U31			
U30	2U Solid Filler	U30	U30			
U29		U29	U29			
U28	2U Solid Filler	U28	U28			
U27		U27	U27			
U26	1U Solid Filler	U26	U26			
U25	1U Solid Filler	U25	U25			
U24	1U Solid Filler	U24	U24			
U23	1U Solid Filler	U23	U23			
U22	1U Vented Filler	U22	U22			
U21	1U Vented Filler	U21	U21			
U20	1U Vented Filler	U20	U20			
U19	Oracle Database Server	U19	U19			
U18	Oracle Database Server	U18	U18			
U17	Oracle Database Server	U17	U17			
U16	Oracle Database Server	U16	U16			
U15	Oracle Exadata storage cell	U15	U15			
U14		U14	U14			
U13	Oracle Exadata storage cell	U13	U13			
U12		U12	U12			
U11	Oracle Exadata storage cell	U11	U11			
U10		U10	U10			
U9	Oracle Exadata storage cell	U9	U9			
U8		U8	U8			
U7	Oracle Exadata storage cell	U7	U7			
U6		U6	U6			
U5	Oracle Exadata storage cell	U5	U5			
U4		U4	U4			
U3	Oracle Exadata storage cell	U3	U3			
U2		U2	U2			
U1	1U Solid Filler	U1	U1			
			U22		U22	*
			U21		U21	*
			U20		U20	*

 \* Ports oriented to the rear

The following figure shows the front and rear views of Oracle Exadata Database Machine X6-2 and X5-2 Quarter Rack, and Oracle Exadata Database Machine X6-2 and X5-2 Eighth Rack.

**Figure 14-3 Rack Layout of Oracle Exadata Database Machine X6-2 and X5-2 Quarter Rack, and Oracle Exadata Database Machine X6-2 and X5-2 Eighth Rack**

Front View			Rear View		
U42		U42	U42		U42
U41	4U Solid Filler	U41	U41		U41
U40		U40	U40		U40
U39		U39	U39		U39
U38		U38	U38		U38
U37	4U Solid Filler	U37	U37		U37
U36		U36	U36		U36
U35		U35	U35		U35
U34		U34	U34		U34
U33	2U Solid Filler	U33	U33		U33
U32	2U Solid Filler	U32	U32		U32
U31	2U Solid Filler	U31	U31		U31
U30	2U Solid Filler	U30	U30		U30
U29	2U Solid Filler	U29	U29		U29
U28	2U Solid Filler	U28	U28		U28
U27	2U Solid Filler	U27	U27		U27
U26	1U Solid Filler	U26	U26		U26
U25	1U Solid Filler	U25	U25		U25
U24	1U Vented Filler	U24	U24		U24
U23	1U Solid Filler	U23	U23		U23
U22	1U Vented Filler	U22	U22	<b>36-Port IB Switch</b>	U22
U21	1U Vented Filler	U21	U21	<b>Cisco 4948</b>	U21
U20	1U Vented Filler	U20	U20	<b>36-Port IB Switch</b>	U20
U19	1U Solid Filler	U19	U19		U19
U18	1U Solid Filler	U18	U18		U18
U17	<b>Oracle Database Server</b>	U17	U17	<b>Oracle Database Server</b>	U17
U16	<b>Oracle Database Server</b>	U16	U16	<b>Oracle Database Server</b>	U16
U15	2U Solid Filler	U15	U15		U15
U14		U14	U14		U14
U13		U13	U13		U13
U12		U12	U12		U12
U11	4U Solid Filler	U11	U11		U11
U10		U10	U10		U10
U9		U9	U9		U9
U8		U8	U8		U8
U7	<b>Oracle Exadata storage cell</b>	U7	U7	<b>Oracle Exadata storage cell</b>	U7
U6	<b>Oracle Exadata storage cell</b>	U6	U6	<b>Oracle Exadata storage cell</b>	U6
U5	<b>Oracle Exadata storage cell</b>	U5	U5	<b>Oracle Exadata storage cell</b>	U5
U4	<b>Oracle Exadata storage cell</b>	U4	U4	<b>Oracle Exadata storage cell</b>	U4
U3	<b>Oracle Exadata storage cell</b>	U3	U3	<b>Oracle Exadata storage cell</b>	U3
U2		U2	U2		U2
U1	1U Solid Filler	U1	U1		U1

 \* Ports oriented to the rear

The following figure shows the front and rear views of Oracle Exadata Database Machine X5-8 and X6-8.

Figure 14-4 Rack Layout of Oracle Exadata Database Machine X5-8 and X6-8

Front View			Rear View				
U42	Oracle Exadata storage cell	U42	U42	Oracle Exadata storage cell	U42		
U41		U41	U41		U41		
U40	Oracle Exadata storage cell	U40	U40	Oracle Exadata storage cell	U40		
U39		U39	U39		U39		
U38	Oracle Exadata storage cell	U38	U38	Oracle Exadata storage cell	U38		
U37		U37	U37		U37		
U36	Oracle Exadata storage cell	U36	U36	Oracle Exadata storage cell	U36		
U35		U35	U35		U35		
U34	Oracle Exadata storage cell	U34	U34	Oracle Exadata storage cell	U34		
U33		U33	U33		U33		
U32	Oracle Exadata storage cell	U32	U32	Oracle Exadata storage cell	U32		
U31		U31	U31		U31		
U30	Oracle Exadata storage cell	U30	U30	Oracle Exadata storage cell	U30		
U29		U29	U29		U29		
U28	Oracle Database Server	U28	U28	Oracle Database Server	U28		
U27		U27	U27		U27		
U26		U26	U26		U26		
U25		U25	U25		U25		
U24		U24	U24		U24		
U23		1U Vented Filler	U23		U23	36-port IB switch	U23
U22		1U Vented Filler	U22		U22	Cisco 4948	U22
U21	1U Vented Filler	U21	U21	36-port IB switch	U21		
U20	Oracle Database Server	U20	U20	Oracle Database Server	U20		
U19		U19	U19		U19		
U18		U18	U18		U18		
U17		U17	U17		U17		
U16		U16	U16		U16		
U15	Oracle Exadata storage cell	U15	U15	Oracle Exadata storage cell	U15		
U14		U14	U14		U14		
U13	Oracle Exadata storage cell	U13	U13	Oracle Exadata storage cell	U13		
U12		U12	U12		U12		
U11	Oracle Exadata storage cell	U11	U11	Oracle Exadata storage cell	U11		
U10		U10	U10		U10		
U9	Oracle Exadata storage cell	U9	U9	Oracle Exadata storage cell	U9		
U8		U8	U8		U8		
U7	Oracle Exadata storage cell	U7	U7	Oracle Exadata storage cell	U7		
U6		U6	U6		U6		
U5	Oracle Exadata storage cell	U5	U5	Oracle Exadata storage cell	U5		
U4		U4	U4		U4		
U3	Oracle Exadata storage cell	U3	U3	Oracle Exadata storage cell	U3		
U2		U2	U2		U2		
U1	1U Vented Filler	U1	U1		U1		

 \* Ports oriented to the rear

## 14.2 Sun Integrated Lights Out Manager Cabling Tables

The following tables are in this section:

- [Table 14-1](#) ILOM Cabling for Oracle Exadata Database Machine X6-2 and X5-2 Full Rack
- [Table 14-2](#) ILOM Cabling for Oracle Exadata Database Machine X6-2 and X5-2 Half Rack
- [Table 14-3](#) ILOM Cabling for Oracle Exadata Database Machine X6-2 and X5-2 Quarter Rack
- [Table 14-4](#) ILOM Cabling for Oracle Exadata Database Machine X5-8 and X6-8 Full Rack

The following table shows the cable connections from the servers to the ILOM switch in Oracle Exadata Database Machine X6-2 and X5-2 Full Rack:

**Table 14-1 ILOM Cabling for Oracle Exadata Database Machine X6-2 and X5-2 Full Rack**

From Rack Unit	Type of Equipment	Gigabit Ethernet Port
U39	Exadata Storage Server	2
U37	Exadata Storage Server	4
U35	Exadata Storage Server	6
U33	Exadata Storage Server	8
U31	Exadata Storage Server	10
U29	Exadata Storage Server	12
U27	Exadata Storage Server	14
U26	Database server	16
U25	Database server	18
U24	Database server	20
U23	Database server	22
U19	Database server	24
U18	Database server	26
U17	Database server	28
U16	Database server	30
U14	Exadata Storage Server	32
U12	Exadata Storage Server	34
U10	Exadata Storage Server	36
U8	Exadata Storage Server	38
U6	Exadata Storage Server	40
U4	Exadata Storage Server	42
U2	Exadata Storage Server	44

The following table shows the cable connections from the servers to the ILOM switch in Oracle Exadata Database Machine X6-2 and X5-2 Half Rack:

**Table 14-2 ILOM Cabling for Oracle Exadata Database Machine X6-2 and X5-2 Half Rack**

From Rack Unit	Type of Equipment	Gigabit Ethernet Port
U19	Database server	24
U18	Database server	26
U17	Database server	28
U16	Database server	30
U14	Exadata Storage Server	32
U12	Exadata Storage Server	34



**Table 14-2 (Cont.) ILOM Cabling for Oracle Exadata Database Machine X6-2 and X5-2 Half Rack**

From Rack Unit	Type of Equipment	Gigabit Ethernet Port
U10	Exadata Storage Server	36
U8	Exadata Storage Server	38
U6	Exadata Storage Server	40
U4	Exadata Storage Server	42
U2	Exadata Storage Server	44

The following table shows the cable connections from the servers to the ILOM switch in Oracle Exadata Database Machine X6-2 and X5-2 Quarter Rack:

**Table 14-3 ILOM Cabling for Oracle Exadata Database Machine X6-2 and X5-2 Quarter Rack**

From Rack Unit	Type of Equipment	Gigabit Ethernet Port
U17	Database server	28
U16	Database server	30
U6	Exadata Storage Server	40
U4	Exadata Storage Server	42
U2	Exadata Storage Server	44

The following table shows the cable connections from the servers to the ILOM switch in Oracle Exadata Database Machine X5-8 and X6-8 Full Rack:

**Table 14-4 ILOM Cabling for Oracle Exadata Database Machine X5-8 and X6-8 Full Rack**

From Rack Unit	Type of Equipment	Gigabit Ethernet Port
U41	Exadata Storage Server	2
U39	Exadata Storage Server	4
U37	Exadata Storage Server	6
U35	Exadata Storage Server	8
U33	Exadata Storage Server	10
U31	Exadata Storage Server	12
U29	Exadata Storage Server	14
U24	Database server	16
U16	Database server	18
U14	Exadata Storage Server	20
U12	Exadata Storage Server	22
U10	Exadata Storage Server	24
U8	Exadata Storage Server	26

**Table 14-4 (Cont.) ILOM Cabling for Oracle Exadata Database Machine X5-8 and X6-8 Full Rack**

From Rack Unit	Type of Equipment	Gigabit Ethernet Port
U6	Exadata Storage Server	28
U4	Exadata Storage Server	30
U2	Exadata Storage Server	32

## 14.3 Administrative Gigabit Ethernet Port Cabling Tables

This section contains the tables for the administrative Gigabit Ethernet network cabling.

The Gigabit Ethernet switch is located in rack unit 21 on Oracle Exadata Database Machine X6-2 and X5-2 racks.

The following tables are in this section:

- [Table 14-5](#) Gigabit Ethernet Cabling for Oracle Exadata Database Machine X6-2 and X5-2 Full Rack
- [Table 14-6](#) Gigabit Ethernet Cabling for Oracle Exadata Database Machine X6-2 and X5-2 Half Rack
- [Table 14-7](#) Gigabit Ethernet Cabling for Oracle Exadata Database Machine X6-2 and X5-2 Quarter Rack
- [Table 14-8](#) Gigabit Ethernet Cabling for Oracle Exadata Database Machine X5-8 and X6-8 Full Rack

The following table shows the cable connections from the servers to the Gigabit Ethernet switch in Oracle Exadata Database Machine X6-2 and X5-2 Full Rack:

**Table 14-5 Gigabit Ethernet Cabling for Oracle Exadata Database Machine X6-2 and X5-2 Full Rack**

From Rack Unit	Type of Equipment	Gigabit Ethernet Port
U39	Exadata Storage Server	1
U37	Exadata Storage Server	3
U35	Exadata Storage Server	5
U33	Exadata Storage Server	7
U31	Exadata Storage Server	9
U29	Exadata Storage Server	11
U27	Exadata Storage Server	13
U26	Database server	15
U25	Database server	17
U24	Database server	19
U23	Database server	21

**Table 14-5 (Cont.) Gigabit Ethernet Cabling for Oracle Exadata Database Machine X6-2 and X5-2 Full Rack**

From Rack Unit	Type of Equipment	Gigabit Ethernet Port
U22	Sun Datacenter InfiniBand Switch 36 switch	45
U20	Sun Datacenter InfiniBand Switch 36 switch	46
U19	Database server	23
U18	Database server	25
U17	Database server	27
U16	Database server	29
U14	Exadata Storage Server	31
U12	Exadata Storage Server	33
U10	Exadata Storage Server	35
U8	Exadata Storage Server	37
U6	Exadata Storage Server	39
U4	Exadata Storage Server	41
U2	Exadata Storage Server	43
U1	Sun Datacenter InfiniBand Switch 36 switch Note that the spine switch is no longer included by default on Exadata X4-2 and newer models, but port 47 is still reserved on Cisco 4948 for the spine InfiniBand switch.	47

The following table shows the cable connections from the servers to the Gigabit Ethernet switch in Oracle Exadata Database Machine X6-2 and X5-2 Half Rack:

**Table 14-6 Gigabit Ethernet Cabling for Oracle Exadata Database Machine X6-2 and X5-2 Half Rack**

From Rack Unit	Type of Equipment	Gigabit Ethernet Port
U22	Sun Datacenter InfiniBand Switch 36 switch	45
U20	Sun Datacenter InfiniBand Switch 36 switch	46
U19	Database server	23
U18	Database server	25
U17	Database server	27
U16	Database server	29
U14	Exadata Storage Server	31
U12	Exadata Storage Server	33

**Table 14-6 (Cont.) Gigabit Ethernet Cabling for Oracle Exadata Database Machine X6-2 and X5-2 Half Rack**

From Rack Unit	Type of Equipment	Gigabit Ethernet Port
U10	Exadata Storage Server	35
U8	Exadata Storage Server	37
U6	Exadata Storage Server	39
U4	Exadata Storage Server	41
U2	Exadata Storage Server	43
U1	Sun Datacenter InfiniBand Switch 36 switch Note that the spine switch is no longer included by default on Exadata X4-2 and newer models, but port 47 is still reserved on Cisco 4948 for the spine InfiniBand switch.	47

The following table shows the cable connections from the servers to the Gigabit Ethernet switch in Oracle Exadata Database Machine X6-2 and X5-2 Quarter Rack:

**Table 14-7 Gigabit Ethernet Cabling for Oracle Exadata Database Machine X6-2 and X5-2 Quarter Rack**

From Rack Unit	Type of Equipment	Gigabit Ethernet Port
U22	Sun Datacenter InfiniBand Switch 36 switch	45
U20	Sun Datacenter InfiniBand Switch 36 switch	46
U17	Database server	27
U16	Database server	29
U6	Exadata Storage Server	39
U4	Exadata Storage Server	41
U2	Exadata Storage Server	43

The following table shows the cable connections from the servers to the Gigabit Ethernet switch in Oracle Exadata Database Machine X5-8 and X6-8 Full Rack:

**Table 14-8 Gigabit Ethernet Cabling for Oracle Exadata Database Machine X5-8 and X6-8 Full Rack**

From Rack Unit	Type of Equipment	Gigabit Ethernet Port
U41	Exadata Storage Server	1
U39	Exadata Storage Server	3
U37	Exadata Storage Server	5
U35	Exadata Storage Server	7

**Table 14-8 (Cont.) Gigabit Ethernet Cabling for Oracle Exadata Database Machine X5-8 and X6-8 Full Rack**

From Rack Unit	Type of Equipment	Gigabit Ethernet Port
U33	Exadata Storage Server	9
U31	Exadata Storage Server	11
U29	Exadata Storage Server	13
U24	Database server	15
U23	Sun Datacenter InfiniBand Switch 36	33
U21	Sun Datacenter InfiniBand Switch 36	34
U16	Database server	17
U14	Exadata Storage Server	19
U12	Exadata Storage Server	21
U10	Exadata Storage Server	23
U8	Exadata Storage Server	25
U6	Exadata Storage Server	27
U4	Exadata Storage Server	29
U2	Exadata Storage Server	31

## 14.4 Single Phase Power Distribution Unit Cabling Tables

This section contains the tables for single phase cabling from each power distribution unit (PDU) to the power supplies configured in each rack. The cables are terminated to PDU-A on the left, and routed to the right to enter CMA, and are bundled in groups of four.

The following tables are in this section:

- [Table 14-9](#) Single Phase PDU Cabling for Oracle Exadata Database Machine X6-2 and X5-2 Full Rack
- [Table 14-10](#) Single Phase PDU Cabling for Oracle Exadata Database Machine X6-2 and X5-2 Half Rack
- [Table 14-11](#) Single Phase PDU Cabling for Oracle Exadata Database Machine X6-2 and X5-2 Quarter Rack
- [Table 14-12](#) Single Phase PDU Cabling for Oracle Exadata Database Machine X5-8 and X6-8 Full Rack

The following table shows the cable connections from the PDUs to the rack units in Oracle Exadata Database Machine X6-2 and X5-2 Full Rack.

**Table 14-9 Single Phase PDU Cabling for Oracle Exadata Database Machine X6-2 and X5-2 Full Rack**

Rack Unit	PDU-A/PS-00	PDU-B/PS-01	Cable Length
U42	G3-6	G2-0	2 meters

**Table 14-9 (Cont.) Single Phase PDU Cabling for Oracle Exadata Database Machine X6-2 and X5-2 Full Rack**

Rack Unit	PDU-A/PS-00	PDU-B/PS-01	Cable Length
U41	G4-5	G1-1	2 meters
U40	G5-4	G0-2	2 meters
U39	G5-6	G0-0	2 meters
U37	G5-3	G0-3	2 meters
U35	G5-1	G0-5	2 meters
U33	G5-0	G0-6	2 meters
U31	G4-4	G1-2	2 meters
U29	G4-3	G1-3	2 meters
U27	G4-2	G1-4	2 meters
U26	G4-1	G1-5	2 meters
U25	G3-5	G2-1	2 meters
U24	G4-0	G1-6	2 meters
U23	G3-3	G2-3	2 meters
U22	G3-1	G2-5	2 meters
U21	G3-0 (Cisco PS-2)	G2-6 (Cisco PS-1)	2 meters
U20	G1-5	G4-1	2 meters
U19	G2-3	G3-3	2 meters
U18	G2-2	G3-4	2 meters
U17	G2-1	G3-5	2 meters
U16	G1-6	G4-0	2 meters
U14	G2-0	G3-6	2 meters
U12	G1-4	G4-2	2 meters
U10	G1-2	G4-4	2 meters
U8	G1-0	G4-6	2 meters
U6	G0-6	G5-0	2 meters
U4	G0-4	G5-2	2 meters
U2	G0-2	G5-4	2 meters
U1	G0-0	G5-6	2 meters

The following table shows the cable connections from the PDUs to the rack units in Oracle Exadata Database Machine X6-2 and X5-2 Half Rack.

**Table 14-10 Single Phase PDU Cabling for Oracle Exadata Database Machine X6-2 and X5-2 Half Rack**

Rack Unit	PDU-A/PS-00	PDU-B/PS-01	Cable Length
U22	G3-1	G2-5	2 meters
U21	G3-0 (Cisco PS-2)	G2-6 (Cisco PS-1)	2 meters

**Table 14-10 (Cont.) Single Phase PDU Cabling for Oracle Exadata Database Machine X6-2 and X5-2 Half Rack**

Rack Unit	PDU-A/PS-00	PDU-B/PS-01	Cable Length
U20	G1-5	G4-1	2 meters
U19	G2-3	G3-3	2 meters
U18	G2-2	G3-4	2 meters
U17	G2-1	G3-5	2 meters
U16	G1-6	G4-0	2 meters
U14	G2-0	G3-6	2 meters
U12	G1-4	G4-2	2 meters
U10	G1-2	G4-4	2 meters
U8	G1-0	G4-6	2 meters
U6	G0-6	G5-0	2 meters
U4	G0-4	G5-2	2 meters
U2	G0-2	G5-4	2 meters

The following table shows the cable connections from the PDUs to the rack units in Oracle Exadata Database Machine X6-2 and X5-2 Quarter Rack.

**Table 14-11 Single Phase PDU Cabling for Oracle Exadata Database Machine X6-2 and X5-2 Quarter Rack**

Rack Unit	PDU-A/PS-00	PDU-B/PS-01	Cable Length
U22	G3-1	G2-5	2 meters
U21	G3-0 (Cisco PS-2)	G2-6 (Cisco PS-1)	2 meters
U20	G1-5	G4-1	2 meters
U17	G2-1	G3-5	2 meters
U16	G1-6	G4-0	2 meters
U6	G0-6	G5-0	2 meters
U4	G0-4	G5-2	2 meters
U2	G0-2	G5-4	2 meters

The following table shows the cable connections from the PDUs to the rack units in Oracle Exadata Database Machine X5-8 and X6-8 Full Rack.

**Table 14-12 Single Phase PDU Cabling for Oracle Exadata Database Machine X5-8 and X6-8 Full Rack**

Rack Unit	PDU-A/PS-00	PDU-B/PS-01	Cable Length
U41	G5-6	G0-0	2 meters
U39	G5-4	G0-2	2 meters
U37	G5-2	G0-4	2 meters

**Table 14-12 (Cont.) Single Phase PDU Cabling for Oracle Exadata Database Machine X5-8 and X6-8 Full Rack**

Rack Unit	PDU-A/PS-00	PDU-B/PS-01	Cable Length
U35	G5-0	G0-6	2 meters
U33	G4-6	G1-0	2 meters
U31	G4-3	G1-3	2 meters
U29	G3-6	G2-0	2 meters
U24	G4-7 (C19) (AC0)	G1-7 (C19) (AC1)	1 meter
U24	G2-7 (C19) (AC2)	G3-7 (C19) (AC3)	1 meter
U23	G3-1	G2-5	2 meters
U22	G2-6 (PS-2)	G3-0 (PS-1)	2 meters
U21	G3-0	G2-6	2 meters
U16	G3-7 (C19) (AC0)	G2-7 (C19) (AC1)	1 meter
U16	G1-7 (C19) (AC2)	G4-7 (C19) (AC3)	1 meter
U14	G2-0	G3-6	2 meters
U12	G1-3	G4-3	2 meters
U10	G1-0	G4-6	2 meters
U8	G0-6	G5-0	2 meters
U6	G0-4	G5-2	2 meters
U4	G0-3	G5-3	2 meters
U2	G0-1	G5-5	2 meters
U1	G0-0	G5-6	2 meters

## 14.5 Three Phase Power Distribution Unit Cabling Tables

This section contains the tables for three phase cabling from each power distribution unit (PDU) to the power supplies configured in each rack.

The cables are terminated to PDU-A on the left, and routed to the right to enter CMA, and are bundled in groups of four.

The following tables are in this section:

- [Table 14-13](#) Three Phase PDU Cabling for Oracle Exadata Database Machine X6-2 and X5-2 Full Rack
- [Table 14-14](#) Three Phase PDU Cabling for Oracle Exadata Database Machine X6-2 and X5-2 Half Rack
- [Table 14-15](#) Three Phase PDU Cabling for Oracle Exadata Database Machine X6-2 and X5-2 Quarter Rack
- [Table 14-16](#) Three Phase PDU Cabling for Oracle Exadata Database Machine X5-8 and X6-8 Full Rack

The following table shows the cable connections from the PDUs to the rack units in Oracle Exadata Database Machine X6-2 and X5-2 Full Rack.



**Table 14-13 Three Phase PDU Cabling for Oracle Exadata Database Machine X6-2 and X5-2 Full Rack**

Rack Unit	PDU-A/PS-00	PDU-B/PS-01	Cable Length
U42	G5-4	G2-2	2 meters
U41	G5-5	G2-1	2 meters
U40	G3-6	G0-0	2 meters
U39	G5-6	G2-0	2 meters
U37	G5-3	G2-3	2 meters
U35	G5-0	G2-6	2 meters
U33	G5-2	G2-4	2 meters
U31	G4-4	G1-2	2 meters
U29	G4-2	G1-4	2 meters
U27	G4-1	G1-5	2 meters
U26	G5-1	G2-5	2 meters
U25	G3-5	G0-1	2 meters
U24	G3-4	G0-2	2 meters
U23	G3-3	G0-3	2 meters
U22	G3-2	G0-4	2 meter
U21	G3-0	G0-6	2 meters
U20	G2-4	G5-2	2 meters
U19	G2-3	G5-3	2 meters
U18	G2-2	G5-4	2 meters
U17	G2-1	G5-5	2 meters
U16	G1-6	G4-0	2 meters
U14	G1-5	G4-1	2 meters
U12	G1-4	G4-2	2 meters
U10	G1-2	G4-4	2 meters
U8	G1-0	G4-6	2 meters
U6	G0-6	G3-0	2 meters
U4	G0-4	G3-2	2 meters
U2	G0-2	G3-4	2 meters
U0	G0-0	G3-6	2 meters

The following table shows the cable connections from the PDUs to the rack units in Oracle Exadata Database Machine X6-2 and X5-2 Half Rack.

**Table 14-14 Three Phase PDU Cabling for Oracle Exadata Database Machine X6-2 and X5-2 Half Rack**

Rack Unit	PDU-A/PS-00	PDU-B/PS-01	Cable Length
U22	G3-2	G0-4	2 meter

**Table 14-14 (Cont.) Three Phase PDU Cabling for Oracle Exadata Database Machine X6-2 and X5-2 Half Rack**

Rack Unit	PDU-A/PS-00	PDU-B/PS-01	Cable Length
U21	G3-0	G0-6	2 meters
U20	G2-4	G5-2	2 meters
U19	G2-3	G5-3	2 meters
U18	G2-2	G5-4	2 meters
U17	G2-1	G5-5	2 meters
U16	G1-6	G4-0	2 meters
U14	G1-5	G4-1	2 meters
U12	G1-4	G4-2	2 meters
U10	G1-2	G4-4	2 meters
U8	G1-0	G4-6	2 meters
U6	G0-6	G3-0	2 meters
U4	G0-4	G3-2	2 meters
U2	G0-2	G3-4	2 meters

The following table shows the cable connections from the PDUs to the rack units in Oracle Exadata Database Machine X6-2 and X5-2 Quarter Rack.

**Table 14-15 Three Phase PDU Cabling for Oracle Exadata Database Machine X6-2 and X5-2 Quarter Rack**

Rack Unit	PDU-A/PS-00	PDU-B/PS-01	Cable Length
U22	G3-2	G0-4	2 meter
U21	G3-0	G0-6	2 meters
U20	G2-4	G5-2	2 meters
U17	G2-1	G5-5	2 meters
U16	G1-6	G4-0	2 meters
U6	G0-6	G3-0	2 meters
U4	G0-4	G3-2	2 meters
U2	G0-2	G3-4	2 meters

The following table shows the cable connections from the PDUs to the rack units in Oracle Exadata Database Machine X5-8 and X6-8 Full Rack.

**Table 14-16 Three Phase PDU Cabling for Oracle Exadata Database Machine X5-8 and X6-8 Full Rack**

Rack Unit	PDU-A/PS-00	PDU-B/PS-01	Cable Length
U41	G5-5	G2-1	2 meters
U39	G5-4	G2-2	2 meters

**Table 14-16 (Cont.) Three Phase PDU Cabling for Oracle Exadata Database Machine X5-8 and X6-8 Full Rack**

Rack Unit	PDU-A/PS-00	PDU-B/PS-01	Cable Length
U37	G5-2	G2-4	2 meters
U35	G5-1	G2-5	2 meters
U33	G5-0	G2-6	2 meters
U31	G4-6	G1-0	2 meters
U29	G4-4	G1-2	2 meters
U24	AC0 to G4-7 (C19)	AC1 to G1-7 (C19)	1 meter
U24	AC2 to G3-7 (C19)	AC3 to G0-7 (C19)	1 meter
U23	G3-1	G0-5	2 meters
U22	G3-0	G0-6	2 meters
U21	G2-5	G5-1	2 meters
U16	AC0 to G1-7 (C19)	AC1 to G4-7 (C19)	1 meter
U16	AC2 to G2-7 (C19)	AC3 to G5-7 (C19)	1 meter
U14	G1-3	G4-3	2 meters
U12	G1-0	G4-6	2 meters
U10	G0-6	G3-0	2 meters
U8	G0-5	G3-1	2 meters
U6	G0-4	G3-2	2 meters
U4	G0-2	G3-4	2 meters
U2	G0-1	G3-5	2 meters
U1	G0-0	G3-6	2 meters

## 14.6 InfiniBand Network Cabling Tables

This topic contains the tables for the InfiniBand network cabling for Oracle Exadata Database Machine X5 and X6 racks.

In two-socket systems, the Sun Datacenter InfiniBand Switch 36 switches are located in rack units 20 and 22. In eight-socket systems, the Sun Datacenter InfiniBand Switch 36 switches are located in rack units 21 and 23. If present, the optional spine switch is located in rack unit 1.

The following tables are in this topic:

- [Table 14-17](#) InfiniBand Network Cabling for Oracle Exadata Database Machine X6-2 and Oracle Exadata Database Machine X5-2 Full Rack
- [Table 14-18](#) InfiniBand Network Cabling for Oracle Exadata Database Machine X6-2 and X5-2 Half Rack
- [Table 14-19](#) InfiniBand Network Cabling for Oracle Exadata Database Machine X6-2 and X5-2 Quarter Rack
- [Table 14-20](#) InfiniBand Network Cabling for Oracle Exadata Database Machine X5-8 and X6-8 Full Rack

The following table lists the location, ports and cables for the InfiniBand connections for Oracle Exadata Database Machine X6-2 and X5-2 Full Rack.

**Table 14-17 InfiniBand Network Cabling for Oracle Exadata Database Machine X6-2 and X5-2 Full Rack**

From InfiniBand Switch Rack Unit	Port	To Rack Unit	Type of Equipment	Port	Cable Description
U22	0A	U39	Oracle Exadata Storage Server	PCIe 3, P1	3 meter QDR InfiniBand cable
U22	0B	U37	Oracle Exadata Storage Server	PCIe 3, P1	3 meter QDR InfiniBand cable
U22	1A	U35	Oracle Exadata Storage Server	PCIe 3, P1	3 meter QDR InfiniBand cable
U22	1B	U33	Oracle Exadata Storage Server	PCIe 3, P1	3 meter QDR InfiniBand cable
U22	2A	U31	Oracle Exadata Storage Server	PCIe 3, P1	3 meter QDR InfiniBand cable
U22	2B	U29	Oracle Exadata Storage Server	PCIe 3, P1	3 meter QDR InfiniBand cable
U22	3B	U27	Oracle Exadata Storage Server	PCIe 3, P1	3 meter QDR InfiniBand cable
U22	3A	U26	Oracle Exadata Database Server	PCIe 3, P1	2 meter QDR InfiniBand cable
U22	4A	U25	Oracle Exadata Database Server	PCIe 3, P1	2 meter QDR InfiniBand cable
U22	4B	U24	Oracle Exadata Database Server	PCIe 3, P1	2 meter QDR InfiniBand cable
U22	5A	U23	Oracle Exadata Database Server	PCIe 3, P1	2 meter QDR InfiniBand cable

**Table 14-17 (Cont.) InfiniBand Network Cabling for Oracle Exadata Database Machine X6-2 and X5-2 Full Rack**

From InfiniBand Switch Rack Unit	Port	To Rack Unit	Type of Equipment	Port	Cable Description
U22	12B	U19	Oracle Exadata Database Server	PCIe 3, P2	2 meter QDR InfiniBand cable
U22	13A	U18	Oracle Exadata Database Server	PCIe 3, P2	2 meter QDR InfiniBand cable
U22	13B	U17	Oracle Exadata Database Server	PCIe 3, P2	2 meter QDR InfiniBand cable
U22	14B	U16	Oracle Exadata Database Server	PCIe 3, P2	2 meter QDR InfiniBand cable
U22	14A	U14	Oracle Exadata Storage Server	PCIe 3, P2	3 meter QDR InfiniBand cable
U22	15A	U12	Oracle Exadata Storage Server	PCIe 3, P2	3 meter QDR InfiniBand cable
U22	15B	U10	Oracle Exadata Storage Server	PCIe 3, P2	3 meter QDR InfiniBand cable
U22	16A	U8	Oracle Exadata Storage Server	PCIe 3, P2	3 meter QDR InfiniBand cable
U22	16B	U6	Oracle Exadata Storage Server	PCIe 3, P2	3 meter QDR InfiniBand cable
U22	17A	U4	Oracle Exadata Storage Server	PCIe 3, P2	3 meter QDR InfiniBand cable
U22	17B	U2	Oracle Exadata Storage Server	PCIe 3, P2	3 meter QDR InfiniBand cable

**Table 14-17 (Cont.) InfiniBand Network Cabling for Oracle Exadata Database Machine X6-2 and X5-2 Full Rack**

From InfiniBand Switch Rack Unit	Port	To Rack Unit	Type of Equipment	Port	Cable Description
U20	0A	U39	Oracle Exadata Storage Server	PCIe 3, P2	3 meter QDR InfiniBand cable
U20	0B	U37	Oracle Exadata Storage Server	PCIe 3, P2	3 meter QDR InfiniBand cable
U20	1A	U35	Oracle Exadata Storage Server	PCIe 3, P2	3 meter QDR InfiniBand cable
U20	1B	U33	Oracle Exadata Storage Server	PCIe 3, P2	3 meter QDR InfiniBand cable
U20	2A	U31	Oracle Exadata Storage Server	PCIe 3, P2	3 meter QDR InfiniBand cable
U20	2B	U29	Oracle Exadata Storage Server	PCIe 3, P2	3 meter QDR InfiniBand cable
U20	3B	U27	Oracle Exadata Storage Server	PCIe 3, P2	3 meter QDR InfiniBand cable
U20	3A	U26	Oracle Exadata Database Server	PCIe 3, P2	2 meter QDR InfiniBand cable
U20	4A	U25	Oracle Exadata Database Server	PCIe 3, P2	2 meter QDR InfiniBand cable
U20	4B	U24	Oracle Exadata Database Server	PCIe 3, P2	2 meter QDR InfiniBand cable
U20	5A	U23	Oracle Exadata Database Server	PCIe 3, P2	2 meter QDR InfiniBand cable

**Table 14-17 (Cont.) InfiniBand Network Cabling for Oracle Exadata Database Machine X6-2 and X5-2 Full Rack**

From InfiniBand Switch Rack Unit	Port	To Rack Unit	Type of Equipment	Port	Cable Description
U20	12B	U19	Oracle Exadata Database Server	PCIe 3, P1	2 meter QDR InfiniBand cable
U20	13A	U18	Oracle Exadata Database Server	PCIe 3, P1	2 meter QDR InfiniBand cable
U20	13B	U17	Oracle Exadata Database Server	PCIe 3, P1	2 meter QDR InfiniBand cable
U20	14B	U16	Oracle Exadata Database Server	PCIe 3, P1	2 meter QDR InfiniBand cable
U20	14A	U14	Oracle Exadata Storage Server	PCIe 3, P1	2 meter QDR InfiniBand cable
U20	15A	U12	Oracle Exadata Storage Server	PCIe 3, P1	3 meter QDR InfiniBand cable
U20	15B	U10	Oracle Exadata Storage Server	PCIe 3, P1	3 meter QDR InfiniBand cable
U20	16A	U8	Oracle Exadata Storage Server	PCIe 3, P1	3 meter QDR InfiniBand cable
U20	16B	U6	Oracle Exadata Storage Server	PCIe 3, P1	3 meter QDR InfiniBand cable
U20	17A	U4	Oracle Exadata Storage Server	PCIe 3, P1	3 meter QDR InfiniBand cable
U20	17B	U2	Oracle Exadata Storage Server	PCIe 3, P1	3 meter QDR InfiniBand cable

**Table 14-17 (Cont.) InfiniBand Network Cabling for Oracle Exadata Database Machine X6-2 and X5-2 Full Rack**

From InfiniBand Switch Rack Unit	Port	To Rack Unit	Type of Equipment	Port	Cable Description
U20	9B	U22	Sun Datacenter InfiniBand Switch 36 switch	9A	1 meter QDR InfiniBand cable
U20	10B	U22	Sun Datacenter InfiniBand Switch 36 switch	10A	1 meter QDR InfiniBand cable
U20	11B	U22	Sun Datacenter InfiniBand Switch 36 switch	11A	1 meter QDR InfiniBand cable
U20	8A	U22	Sun Datacenter InfiniBand Switch 36 switch	8A	1 meter QDR InfiniBand cable
U20	9A	U22	Sun Datacenter InfiniBand Switch 36 switch	9B	1 meter QDR InfiniBand cable
U20	10A	U22	Sun Datacenter InfiniBand Switch 36 switch	10B	1 meter QDR InfiniBand cable
U20	11A	U22	Sun Datacenter InfiniBand Switch 36 switch	11B	1 meter QDR InfiniBand cable
U1 — when added as an optional configuration	1B	U20	Sun Datacenter InfiniBand Switch 36 switch	8B	3 meter QDR InfiniBand cable
U1 — when added as an optional configuration	0B	U22	Sun Datacenter InfiniBand Switch 36 switch	8B	3 meter QDR InfiniBand cable



The following table lists the location, ports and cables for the InfiniBand connections for Oracle Exadata Database Machine X6-2 and X5-2 Half Rack.

**Table 14-18 InfiniBand Network Cabling for Oracle Exadata Database Machine X6-2 and X5-2 Half Rack**

From InfiniBand Switch Rack Unit	Port	To Rack Unit	Type of Equipment	Port	Cable Description
U22	12B	U19	Oracle Exadata Database Server	PCIe 3, P2	2 meter QDR InfiniBand cable
U22	13A	U18	Oracle Exadata Database Server	PCIe 3, P2	2 meter QDR InfiniBand cable
U22	13B	U17	Oracle Exadata Database Server	PCIe 3, P2	2 meter QDR InfiniBand cable
U22	14B	U16	Oracle Exadata Database Server	PCIe 3, P2	2 meter QDR InfiniBand cable
U22	14A	U14	Oracle Exadata Storage Server	PCIe 3, P2	3 meter QDR InfiniBand cable
U22	15A	U12	Oracle Exadata Storage Server	PCIe 3, P2	3 meter QDR InfiniBand cable
U22	15B	U10	Oracle Exadata Storage Server	PCIe 3, P2	3 meter QDR InfiniBand cable
U22	16A	U8	Oracle Exadata Storage Server	PCIe 3, P2	3 meter QDR InfiniBand cable
U22	16B	U6	Oracle Exadata Storage Server	PCIe 3, P2	3 meter QDR InfiniBand cable
U22	17A	U4	Oracle Exadata Storage Server	PCIe 3, P2	3 meter QDR InfiniBand cable
U22	17B	U2	Oracle Exadata Storage Server	PCIe 3, P2	3 meter QDR InfiniBand cable
U20	12B	U19	Oracle Exadata Database Server	PCIe 3, P1	2 meter QDR InfiniBand cable
U20	13A	U18	Oracle Exadata Database Server	PCIe 3, P1	2 meter QDR InfiniBand cable
U20	13B	U17	Oracle Exadata Database Server	PCIe 3, P1	2 meter QDR InfiniBand cable

**Table 14-18 (Cont.) InfiniBand Network Cabling for Oracle Exadata Database Machine X6-2 and X5-2 Half Rack**

From InfiniBand Switch Rack Unit	Port	To Rack Unit	Type of Equipment	Port	Cable Description
U20	14B	U16	Oracle Exadata Database Server	PCIe 3, P1	2 meter QDR InfiniBand cable
U20	14A	U14	Oracle Exadata Storage Server	PCIe 3, P1	2 meter QDR InfiniBand cable
U20	15A	U12	Oracle Exadata Storage Server	PCIe 3, P1	3 meter QDR InfiniBand cable
U20	15B	U10	Oracle Exadata Storage Server	PCIe 3, P1	3 meter QDR InfiniBand cable
U20	16A	U8	Oracle Exadata Storage Server	PCIe 3, P1	3 meter QDR InfiniBand cable
U20	16B	U6	Oracle Exadata Storage Server	PCIe 3, P1	3 meter QDR InfiniBand cable
U20	17A	U4	Oracle Exadata Storage Server	PCIe 3, P1	3 meter QDR InfiniBand cable
U20	17B	U2	Oracle Exadata Storage Server	PCIe 3, P1	3 meter QDR InfiniBand cable
U20	9B	U22	Sun Datacenter InfiniBand Switch 36 switch	9A	1 meter QDR InfiniBand cable
U20	10B	U22	Sun Datacenter InfiniBand Switch 36 switch	10A	1 meter QDR InfiniBand cable
U20	11B	U22	Sun Datacenter InfiniBand Switch 36 switch	11A	1 meter QDR InfiniBand cable
U20	8A	U22	Sun Datacenter InfiniBand Switch 36 switch	8A	1 meter QDR InfiniBand cable
U20	9A	U22	Sun Datacenter InfiniBand Switch 36 switch	9B	1 meter QDR InfiniBand cable

**Table 14-18 (Cont.) InfiniBand Network Cabling for Oracle Exadata Database Machine X6-2 and X5-2 Half Rack**

From InfiniBand Switch Rack Unit	Port	To Rack Unit	Type of Equipment	Port	Cable Description
U20	10A	U22	Sun Datacenter InfiniBand Switch 36 switch	10B	1 meter QDR InfiniBand cable
U20	11A	U22	Sun Datacenter InfiniBand Switch 36 switch	11B	1 meter QDR InfiniBand cable
U1 — when added as an optional configuration	1B	U20	Sun Datacenter InfiniBand Switch 36 switch	8B	3 meter QDR InfiniBand cable
U1 — when added as an optional configuration	0B	U22	Sun Datacenter InfiniBand Switch 36 switch	8B	3 meter QDR InfiniBand cable

The following table lists the location, ports and cables for the InfiniBand connections for Oracle Exadata Database Machine X6-2 and Oracle Exadata Database Machine X5-2 Quarter Rack.

 **Note:**

The same rules and restrictions for Oracle Exadata Database Machine X5-2 and Oracle Exadata Database Machine X6-2 Quarter Rack apply to Oracle Exadata Database Machine X5-2 and Oracle Exadata Database Machine X6-2 Eighth Rack.

**Table 14-19 InfiniBand Network Cabling for Oracle Exadata Database Machine X6-2 and X5-2 Quarter Rack**

From InfiniBand Switch Rack Unit	Port	To Rack Unit	Type of Equipment	Port	Cable Description
U22	13B	U17	Oracle Exadata Database Server	PCIe 3, P2	2 meter QDR InfiniBand cable
U22	14B	U16	Oracle Exadata Database Server	PCIe 3, P2	2 meter QDR InfiniBand cable
U22	16B	U6	Oracle Exadata Storage Server	PCIe 3, P2	3 meter QDR InfiniBand cable

**Table 14-19 (Cont.) InfiniBand Network Cabling for Oracle Exadata Database Machine X6-2 and X5-2 Quarter Rack**

From InfiniBand Switch Rack Unit	Port	To Rack Unit	Type of Equipment	Port	Cable Description
U22	17A	U4	Oracle Exadata Storage Server	PCIe 3, P2	3 meter QDR InfiniBand cable
U22	17B	U2	Oracle Exadata Storage Server	PCIe 3, P2	3 meter QDR InfiniBand cable
U20	13B	U17	Oracle Exadata Database Server	PCIe 3, P1	2 meter QDR InfiniBand cable
U20	14B	U16	Oracle Exadata Database Server	PCIe 3, P1	2 meter QDR InfiniBand cable
U20	16B	U6	Oracle Exadata Storage Server	PCIe 3, P1	3 meter QDR InfiniBand cable
U20	17A	U4	Oracle Exadata Storage Server	PCIe 3, P1	3 meter QDR InfiniBand cable
U20	17B	U2	Oracle Exadata Storage Server	PCIe 3, P1	3 meter QDR InfiniBand cable
U20	9B	U22	Sun Datacenter InfiniBand Switch 36 switch	9A	1 meter QDR InfiniBand cable
U20	10B	U22	Sun Datacenter InfiniBand Switch 36 switch	10A	1 meter QDR InfiniBand cable
U20	11B	U22	Sun Datacenter InfiniBand Switch 36 switch	11A	1 meter QDR InfiniBand cable
U20	8A	U22	Sun Datacenter InfiniBand Switch 36 switch	8A	1 meter QDR InfiniBand cable
U20	9A	U22	Sun Datacenter InfiniBand Switch 36 switch	9B	1 meter QDR InfiniBand cable
U20	10A	U22	Sun Datacenter InfiniBand Switch 36 switch	10B	1 meter QDR InfiniBand cable

**Table 14-19 (Cont.) InfiniBand Network Cabling for Oracle Exadata Database Machine X6-2 and X5-2 Quarter Rack**

From InfiniBand Switch Rack Unit	Port	To Rack Unit	Type of Equipment	Port	Cable Description
U20	11A	U22	Sun Datacenter InfiniBand Switch 36 switch	11B	1 meter QDR InfiniBand cable
U1 — when added as an optional configuration	1B	U20	Sun Datacenter InfiniBand Switch 36 switch	8B	3 meter QDR InfiniBand cable
U1 — when added as an optional configuration	0B	U22	Sun Datacenter InfiniBand Switch 36 switch	8B	3 meter QDR InfiniBand cable

The following table lists the location, ports and cables for the InfiniBand connections for Oracle Exadata Database Machine X5-8 and X6-8 Full Rack.

**Table 14-20 InfiniBand Network Cabling for Oracle Exadata Database Machine X5-8 and X6-8 Full Rack**

From InfiniBand Switch Rack Unit	Port	To Rack Unit	Type of Equipment	Port	Cable Description
U23	0A	U41	Oracle Exadata Storage Server	3 PCIe3 P1	3 meter QDR InfiniBand cable
U23	0B	U39	Oracle Exadata Storage Server	3 PCIe3 P1	3 meter QDR InfiniBand cable
U23	1A	U37	Oracle Exadata Storage Server	3 PCIe3 P1	3 meter QDR InfiniBand cable
U23	1B	U35	Oracle Exadata Storage Server	3 PCIe3 P1	3 meter QDR InfiniBand cable
U23	2A	U33	Oracle Exadata Storage Server	3 PCIe3 P1	3 meter QDR InfiniBand cable
U23	2B	U31	Oracle Exadata Storage Server	3 PCIe3 P1	3 meter QDR InfiniBand cable
U23	3B	U29	Oracle Exadata Storage Server	3 PCIe3 P1	3 meter QDR InfiniBand cable

**Table 14-20 (Cont.) InfiniBand Network Cabling for Oracle Exadata Database Machine X5-8 and X6-8 Full Rack**

From InfiniBand Switch Rack Unit	Port	To Rack Unit	Type of Equipment	Port	Cable Description
U23	3A	U24	Oracle Exadata Database Server	12 PCIe3 P1	2 meter QDR InfiniBand cable
U23	4A	U24	Oracle Exadata Database Server	10 PCIe3 P1	2 meter QDR InfiniBand cable
U23	4B	U24	Oracle Exadata Database Server	8 PCIe3 P1	2 meter QDR InfiniBand cable
U23	5A	U24	Oracle Exadata Database Server	6 PCIe3 P1	2 meter QDR InfiniBand cable
U23	13A	U16	Oracle Exadata Database Server	10 PCIe3 P2	2 meter QDR InfiniBand cable
U23	13B	U16	Oracle Exadata Database Server	8 PCIe3 P2	2 meter QDR InfiniBand cable
U23	14B	U16	Oracle Exadata Database Server	6 PCIe3 P2	2 meter QDR InfiniBand cable
U23	12B	U16	Oracle Exadata Database Server	12 PCIe3 P2	2 meter QDR InfiniBand cable
U23	14A	U14	Oracle Exadata Storage Server	3 PCIe3 P2	3 meter QDR InfiniBand cable
U23	15A	U12	Oracle Exadata Storage Server	3 PCIe3 P2	3 meter QDR InfiniBand cable
U23	15B	U10	Oracle Exadata Storage Server	3 PCIe3 P2	3 meter QDR InfiniBand cable
U23	16A	U8	Oracle Exadata Storage Server	3 PCIe3 P2	3 meter QDR InfiniBand cable
U23	16B	U6	Oracle Exadata Storage Server	3 PCIe3 P2	3 meter QDR InfiniBand cable
U23	17A	U4	Oracle Exadata Storage Server	3 PCIe3 P2	3 meter QDR InfiniBand cable

**Table 14-20 (Cont.) InfiniBand Network Cabling for Oracle Exadata Database Machine X5-8 and X6-8 Full Rack**

From InfiniBand Switch Rack Unit	Port	To Rack Unit	Type of Equipment	Port	Cable Description
U23	17B	U2	Oracle Exadata Storage Server	3 PCIe3 P2	3 meter QDR InfiniBand cable
U21	0A	U41	Oracle Exadata Storage Server	3 PCIe3 P2	3 meter QDR InfiniBand cable
U21	0B	U39	Oracle Exadata Storage Server	3 PCIe3 P2	3 meter QDR InfiniBand cable
U21	1A	U37	Oracle Exadata Storage Server	3 PCIe3 P2	3 meter QDR InfiniBand cable
U21	1B	U35	Oracle Exadata Storage Server	3 PCIe3 P2	3 meter QDR InfiniBand cable
U21	2A	U33	Oracle Exadata Storage Server	3 PCIe3 P2	3 meter QDR InfiniBand cable
U21	2B	U31	Oracle Exadata Storage Server	3 PCIe3 P2	3 meter QDR InfiniBand cable
U21	3B	U29	Oracle Exadata Storage Server	3 PCIe3 P2	3 meter QDR InfiniBand cable
U21	3A	U24	Oracle Exadata Database Server	12 PCIe3 P2	2 meter QDR InfiniBand cable
U21	4A	U24	Oracle Exadata Database Server	10 PCIe3 P2	2 meter QDR InfiniBand cable
U21	4B	U24	Oracle Exadata Database Server	8 PCIe3 P2	2 meter QDR InfiniBand cable
U21	5A	U24	Oracle Exadata Database Server	6 PCIe3 P2	2 meter QDR InfiniBand cable
U21	12B	U16	Oracle Exadata Database Server	12 PCIe3 P1	2 meter QDR InfiniBand cable
U21	13A	U16	Oracle Exadata Database Server	10 PCIe3 P1	2 meter QDR InfiniBand cable

**Table 14-20 (Cont.) InfiniBand Network Cabling for Oracle Exadata Database Machine X5-8 and X6-8 Full Rack**

From InfiniBand Switch Rack Unit	Port	To Rack Unit	Type of Equipment	Port	Cable Description
U21	13B	U16	Oracle Exadata Database Server	8 PCIe3 P1	2 meter QDR InfiniBand cable
U21	14B	U16	Oracle Exadata Database Server	6 PCIe3 P1	2 meter QDR InfiniBand cable
U21	14A	U14	Oracle Exadata Storage Server	3 PCIe3 P1	2 meter QDR InfiniBand cable
U21	15A	U12	Oracle Exadata Storage Server	3 PCIe3 P1	3 meter QDR InfiniBand cable
U21	15B	U10	Oracle Exadata Storage Server	3 PCIe3 P1	3 meter QDR InfiniBand cable
U21	16A	U8	Oracle Exadata Storage Server	3 PCIe3 P1	3 meter QDR InfiniBand cable
U21	16B	U6	Oracle Exadata Storage Server	3 PCIe3 P1	3 meter QDR InfiniBand cable
U21	17A	U4	Oracle Exadata Storage Server	3 PCIe3 P1	3 meter QDR InfiniBand cable
U21	17B	U2	Oracle Exadata Storage Server	3 PCIe3 P1	3 meter QDR InfiniBand cable
U21	9B	U23	Sun Datacenter InfiniBand Switch 36 switch	9A	1 meter QDR InfiniBand cable
U21	10B	U23	Sun Datacenter InfiniBand Switch 36 switch	10A	1 meter QDR InfiniBand cable
U21	11B	U23	Sun Datacenter InfiniBand Switch 36 switch	11A	1 meter QDR InfiniBand cable
U21	8A	U23	Sun Datacenter InfiniBand Switch 36 switch	8A	1 meter QDR InfiniBand cable



**Table 14-20 (Cont.) InfiniBand Network Cabling for Oracle Exadata Database Machine X5-8 and X6-8 Full Rack**

From InfiniBand Switch Rack Unit	Port	To Rack Unit	Type of Equipment	Port	Cable Description
U21	9A	U23	Sun Datacenter InfiniBand Switch 36 switch	9B	1 meter QDR InfiniBand cable
U21	10A	U23	Sun Datacenter InfiniBand Switch 36 switch	10B	1 meter QDR InfiniBand cable
U21	11A	U23	Sun Datacenter InfiniBand Switch 36 switch	11B	1 meter QDR InfiniBand cable
U1 — when added as an optional configuration	1B	U21	Sun Datacenter InfiniBand Switch 36 switch	8B	3 meter QDR InfiniBand cable
U1 — when added as an optional configuration	0B	U23	Sun Datacenter InfiniBand Switch 36 switch	8B	3 meter QDR InfiniBand cable

# 15

## Cabling Tables for Oracle Exadata Database Machine X4-2 and Oracle Exadata Database Machine X4-8 Full Rack

The tables in this chapter show the cable layouts for Oracle Exadata Database Machine X4-2, and Oracle Exadata Database Machine X4-8 Full Rack.

- [Rack Layout Diagrams](#)  
The diagrams in this topic show the rack layout for Oracle Exadata Database Machine X4-2 and Oracle Exadata Database Machine X4-8.
- [Sun Integrated Lights Out Manager Cabling Tables](#)
- [Administrative Gigabit Ethernet Port Cabling Tables](#)
- [Single Phase Power Distribution Unit Cabling Tables](#)
- [Three Phase Power Distribution Unit Cabling Tables](#)
- [InfiniBand Network Cabling Tables](#)  
This topic contains the tables for the InfiniBand network cabling for Oracle Exadata Database Machine X4 racks.

### 15.1 Rack Layout Diagrams

The diagrams in this topic show the rack layout for Oracle Exadata Database Machine X4-2 and Oracle Exadata Database Machine X4-8.



#### Note:

For ease of reading, the name "Oracle Exadata Rack" is used when information refers to both Oracle Exadata Database Machine X4-2 and Oracle Exadata Storage Expansion Rack.

The following abbreviations are used in the tables:




Abbreviation	Description
$Rn$	Rack $n$ , where $n$ is the number of the rack, such as R1.
$Un$	Unit height in rack, where $n$ is the number, such as U20.
$Pn$	InfiniBand port $n$ , where $n$ is port number, such as P8A.

The cables used in Oracle Exadata Database Machine are color-coded as follows:

- Black: InfiniBand cables, or AC power jumper cables
- Red: Integrated Lights Out Manager (ILOM) cables
- Blue: Gigabit Ethernet cables

The following diagram shows the front and rear views of Oracle Exadata Database Machine X4-2 Full Rack. The front is shown on the left, and the rear is shown on the right.




**Figure 15-1 Rack Layout of Oracle Exadata Database Machine X4-2 Full Rack**

Front View			Rear View		
U42	1U Solid Filler	U42	U42	1U Solid Filler	U42
U41	1U Solid Filler	U41	U41	1U Solid Filler	U41
U40	Oracle Exadata storage cell	U40	U40	Oracle Exadata storage cell	U40
U39		U39	U39		
U38	Oracle Exadata storage cell	U38	U38	Oracle Exadata storage cell	U38
U37		U37	U37		
U36	Oracle Exadata storage cell	U36	U36	Oracle Exadata storage cell	U36
U35		U35	U35		
U34	Oracle Exadata storage cell	U34	U34	Oracle Exadata storage cell	U34
U33		U33	U33		
U32	Oracle Exadata storage cell	U32	U32	Oracle Exadata storage cell	U32
U31		U31	U31		
U30	Oracle Exadata storage cell	U30	U30	Oracle Exadata storage cell	U30
U29		U29	U29		
U28	Oracle Exadata storage cell	U28	U28	Oracle Exadata storage cell	U28
U27		U27	U27		
U26	Oracle Database Server	U26	U26	Oracle Database Server	U26
U25	Oracle Database Server	U25	U25	Oracle Database Server	U25
U24	Oracle Database Server	U24	U24	Oracle Database Server	U24
U23	Oracle Database Server	U23	U23	Oracle Database Server	U23
U22	1U Vented Filler	U22	 U22	36-Port IB Switch	U22
U21	1U Vented Filler	U21	 U21	Cisco 4948	U21
U20	1U Vented Filler	U20	 U20	36-Port IB Switch	U20
U19	Oracle Database Server	U19	U19	Oracle Database Server	U19
U18	Oracle Database Server	U18	U18	Oracle Database Server	U18
U17	Oracle Database Server	U17	U17	Oracle Database Server	U17
U16	Oracle Database Server	U16	U16	Oracle Database Server	U16
U15	Oracle Exadata storage cell	U15	U15	Oracle Exadata storage cell	U15
U14		U14	U14		
U13	Oracle Exadata storage cell	U13	U13	Oracle Exadata storage cell	U13
U12		U12	U12		
U11	Oracle Exadata storage cell	U11	U11	Oracle Exadata storage cell	U11
U10		U10	U10		
U9	Oracle Exadata storage cell	U9	U9	Oracle Exadata storage cell	U9
U8		U8	U8		
U7	Oracle Exadata storage cell	U7	U7	Oracle Exadata storage cell	U7
U6		U6	U6		
U5	Oracle Exadata storage cell	U5	U5	Oracle Exadata storage cell	U5
U4		U4	U4		
U3	Oracle Exadata storage cell	U3	U3	Oracle Exadata storage cell	U3
U2		U2	U2		
U1	1U Solid Filler	U1	U1		U1

 \* Ports oriented to the rear

The next diagram shows the front and rear views of Oracle Exadata Database Machine X4-2 Half Rack.

**Figure 15-2 Rack Layout for Oracle Exadata Database Machine X4-2 Half Rack**

Front View			Rear View			
U42	4U Solid Filler	U42	U42		U42	
U41		U41	U41			
U40		U40	U40			
U39		U39	U39			
U38	4U Solid Filler	U38	U38			
U37		U37	U37			
U36		U36	U36			
U35		U35	U35			
U34	2U Solid Filler	U34	U34			
U33		U33	U33			
U32	2U Solid Filler	U32	U32			
U31		U31	U31			
U30	2U Solid Filler	U30	U30			
U29		U29	U29			
U28	2U Solid Filler	U28	U28			
U27		U27	U27			
U26	1U Solid Filler	U26	U26			
U25	1U Solid Filler	U25	U25			
U24	1U Solid Filler	U24	U24			
U23	1U Solid Filler	U23	U23			
U22	1U Vented Filler	U22	U22			
U21	1U Vented Filler	U21	U21			
U20	1U Vented Filler	U20	U20			
U19	Oracle Database Server	U19	U19			
U18	Oracle Database Server	U18	U18			
U17	Oracle Database Server	U17	U17			
U16	Oracle Database Server	U16	U16			
U15	Oracle Exadata storage cell	U15	U15			
U14		U14	U14			
U13	Oracle Exadata storage cell	U13	U13			
U12		U12	U12			
U11	Oracle Exadata storage cell	U11	U11			
U10		U10	U10			
U9	Oracle Exadata storage cell	U9	U9			
U8		U8	U8			
U7	Oracle Exadata storage cell	U7	U7			
U6		U6	U6			
U5	Oracle Exadata storage cell	U5	U5			
U4		U4	U4			
U3	Oracle Exadata storage cell	U3	U3			
U2		U2	U2			
U1	1U Solid Filler	U1	U1			
			U22		U22	*
			U21		U21	*
			U20		U20	*

 \* Ports oriented to the rear

The next diagram shows the front and rear views of Oracle Exadata Database Machine X4-2 Quarter Rack, and Oracle Exadata Database Machine X4-2 Eighth Rack.

**Figure 15-3 Rack Layout of Oracle Exadata Database Machine X4-2 Quarter Rack, and Oracle Exadata Database Machine X4-2 Eighth Rack**

Front View			Rear View		
U42	4U Solid Filler	U42	U42		U42
U41		U41	U41		
U40		U40	U40		
U39		U39	U39		
U38	4U Solid Filler	U38	U38		U38
U37		U37	U37		
U36		U36	U36		
U35		U35	U35		
U34	2U Solid Filler	U34	U34		U34
U33		U33	U33		
U32	2U Solid Filler	U32	U32		U32
U31		U31	U31		
U30	2U Solid Filler	U30	U30		U30
U29		U29	U29		
U28	2U Solid Filler	U28	U28		U28
U27		U27	U27		
U26	1U Solid Filler	U26	U26		U26
U25	1U Solid Filler	U25	U25		U25
U24	1U Vented Filler	U24	U24		U24
U23	1U Solid Filler	U23	U23		U23
U22	1U Vented Filler	U22	U22		U22
U21	1U Vented Filler	U21	U21		U21
U20	1U Vented Filler	U20	U20		U20
U19	1U Solid Filler	U19	U19		U19
U18	1U Solid Filler	U18	U18		U18
U17	Oracle Database Server	U17	U17		U17
U16	Oracle Database Server	U16	U16		U16
U15	2U Solid Filler	U15	U15		U15
U14		U14	U14		
U13		U13	U13		
U12	2U Solid Filler	U12	U12		U12
U11		U11	U11		
U10		U10	U10		
U9	4U Solid Filler	U9	U9		U9
U8		U8	U8		
U7		U7	U7		
U6		U6	U6		
U5	Oracle Exadata storage cell	U5	U5		U5
U4	Oracle Exadata storage cell	U4	U4		U4
U3	Oracle Exadata storage cell	U3	U3		U3
U2	1U Solid Filler	U2	U2		U2
U1		U1	U1		
U22			36-Port IB Switch	U22	
U21			Cisco 4948	U21	
U20			36-Port IB Switch	U20	

 \* Ports oriented to the rear

The next diagram shows the front and rear views of Oracle Exadata Database Machine X4-8 Full Rack.

**Figure 15-4 Rack Layout of Oracle Exadata Database Machine X4-8 Full Rack**

Front View			Rear View		
U42	Oracle Exadata storage cell	U42	U42	Oracle Exadata storage cell	U42
U41		U41	U41		U41
U40	Oracle Exadata storage cell	U40	U40	Oracle Exadata storage cell	U40
U39		U39	U39		U39
U38	Oracle Exadata storage cell	U38	U38	Oracle Exadata storage cell	U38
U37		U37	U37		U37
U36	Oracle Exadata storage cell	U36	U36	Oracle Exadata storage cell	U36
U35		U35	U35		U35
U34	Oracle Exadata storage cell	U34	U34	Oracle Exadata storage cell	U34
U33		U33	U33		U33
U32	Oracle Exadata storage cell	U32	U32	Oracle Exadata storage cell	U32
U31		U31	U31		U31
U30	Oracle Exadata storage cell	U30	U30	Oracle Exadata storage cell	U30
U29		U29	U29		U29
U28	Oracle Database Server	U28	U28	Oracle Database Server	U28
U27		U27	U27		U27
U26		U26	U26		U26
U25		U25	U25		U25
U24		U24	U24		U24
U23		1U Vented Filler	U23		U23
U22	1U Vented Filler	U22	U22	Cisco 4948	U22
U21	1U Vented Filler	U21	U21	36-port IB switch	U21
U20	Oracle Database Server	U20	U20	Oracle Database Server	U20
U19		U19	U19		U19
U18		U18	U18		U18
U17		U17	U17		U17
U16		U16	U16		U16
U15	Oracle Exadata storage cell	U15	U15	Oracle Exadata storage cell	U15
U14		U14	U14		U14
U13	Oracle Exadata storage cell	U13	U13	Oracle Exadata storage cell	U13
U12		U12	U12		U12
U11	Oracle Exadata storage cell	U11	U11	Oracle Exadata storage cell	U11
U10		U10	U10		U10
U9	Oracle Exadata storage cell	U9	U9	Oracle Exadata storage cell	U9
U8		U8	U8		U8
U7	Oracle Exadata storage cell	U7	U7	Oracle Exadata storage cell	U7
U6		U6	U6		U6
U5	Oracle Exadata storage cell	U5	U5	Oracle Exadata storage cell	U5
U4		U4	U4		U4
U3	Oracle Exadata storage cell	U3	U3	Oracle Exadata storage cell	U3
U2		U2	U2		U2
U1	1U Vented Filler	U1	U1		U1

 \* Ports oriented to the rear

## 15.2 Sun Integrated Lights Out Manager Cabling Tables

This section contains the tables for the Sun Integrated Lights Out Manager (ILOM) network cabling. The ILOM port on the servers is labeled NET MGT, and connects to the Gigabit Ethernet port located in rack unit 21 on Oracle Exadata Database Machine X4-2 racks. The ILOM port connects to the Gigabit Ethernet port located in rack unit 22 on Oracle Exadata Database Machine X4-8 Full Rack racks.

The following tables are in this section:

- [Table 15-1](#)
- [Table 15-2](#)

- [Table 15-3](#)
- [Table 15-4](#)

[Table 15-1](#) shows the cable connections from the servers to the ILOM switch in Oracle Exadata Database Machine X4-2 Full Rack:

**Table 15-1 ILOM Cabling for Oracle Exadata Database Machine X4-2 Full Rack**

From Rack Unit	Type of Equipment	Gigabit Ethernet Port
U39	Exadata Storage Server	2
U37	Exadata Storage Server	4
U35	Exadata Storage Server	6
U33	Exadata Storage Server	8
U31	Exadata Storage Server	10
U29	Exadata Storage Server	12
U27	Exadata Storage Server	14
U26	Database server	16
U25	Database server	18
U24	Database server	20
U23	Database server	22
U19	Database server	24
U18	Database server	26
U17	Database server	28
U16	Database server	30
U14	Exadata Storage Server	32
U12	Exadata Storage Server	34
U10	Exadata Storage Server	36
U8	Exadata Storage Server	38
U6	Exadata Storage Server	40
U4	Exadata Storage Server	42
U2	Exadata Storage Server	44

[Table 15-2](#) shows the cable connections from the servers to the ILOM switch in Oracle Exadata Database Machine X4-2 Half Rack:

**Table 15-2 ILOM Cabling for Oracle Exadata Database Machine X4-2 Half Rack**

From Rack Unit	Type of Equipment	Gigabit Ethernet Port
U19	Database server	24
U18	Database server	26
U17	Database server	28
U16	Database server	30
U14	Exadata Storage Server	32

**Table 15-2 (Cont.) ILOM Cabling for Oracle Exadata Database Machine X4-2 Half Rack**

From Rack Unit	Type of Equipment	Gigabit Ethernet Port
U12	Exadata Storage Server	34
U10	Exadata Storage Server	36
U8	Exadata Storage Server	38
U6	Exadata Storage Server	40
U4	Exadata Storage Server	42
U2	Exadata Storage Server	44

Table 15-3 shows the cable connections from the servers to the ILOM switch in Oracle Exadata Database Machine X4-2 Quarter Rack:

**Table 15-3 ILOM Cabling for Oracle Exadata Database Machine X4-2 Quarter Rack**

From Rack Unit	Type of Equipment	Gigabit Ethernet Port
U17	Database server	28
U16	Database server	30
U6	Exadata Storage Server	40
U4	Exadata Storage Server	42
U2	Exadata Storage Server	44

Table 15-4 shows the cable connections from the servers to the ILOM switch in Oracle Exadata Database Machine X4-8 Full Rack:

**Table 15-4 ILOM Cabling for Oracle Exadata Database Machine X4-8 Full Rack**

From Rack Unit	Type of Equipment	Gigabit Ethernet Port
U41	Exadata Storage Server	2
U39	Exadata Storage Server	4
U37	Exadata Storage Server	6
U35	Exadata Storage Server	8
U33	Exadata Storage Server	10
U31	Exadata Storage Server	12
U29	Exadata Storage Server	14
U24	Database server	16
U16	Database server	18
U14	Exadata Storage Server	20
U12	Exadata Storage Server	22
U10	Exadata Storage Server	24
U8	Exadata Storage Server	26
U6	Exadata Storage Server	28



**Table 15-4 (Cont.) ILOM Cabling for Oracle Exadata Database Machine X4-8 Full Rack**

From Rack Unit	Type of Equipment	Gigabit Ethernet Port
U4	Exadata Storage Server	30
U2	Exadata Storage Server	32

## 15.3 Administrative Gigabit Ethernet Port Cabling Tables

This section contains the tables for the administrative Gigabit Ethernet network cabling. The Gigabit Ethernet switch is located in rack unit 21 on Oracle Exadata Database Machine X4-2 racks.

The following tables are in this section:

- [Table 15-5](#)
- [Table 15-6](#)
- [Table 15-7](#)
- [Table 15-8](#)

[Table 15-5](#) shows the cable connections from the servers to the Gigabit Ethernet switch in Oracle Exadata Database Machine X4-2 Full Rack:

**Table 15-5 Gigabit Ethernet Cabling for Oracle Exadata Database Machine X4-2 Full Rack**

From Rack Unit	Type of Equipment	Gigabit Ethernet Port
U39	Exadata Storage Server	1
U37	Exadata Storage Server	3
U35	Exadata Storage Server	5
U33	Exadata Storage Server	7
U31	Exadata Storage Server	9
U29	Exadata Storage Server	11
U27	Exadata Storage Server	13
U26	Database server	15
U25	Database server	17
U24	Database server	19
U23	Database server	21
U22	Sun Datacenter InfiniBand Switch 36 switch	45
U20	Sun Datacenter InfiniBand Switch 36 switch	46
U19	Database server	23
U18	Database server	25
U17	Database server	27

**Table 15-5 (Cont.) Gigabit Ethernet Cabling for Oracle Exadata Database Machine X4-2 Full Rack**

From Rack Unit	Type of Equipment	Gigabit Ethernet Port
U16	Database server	29
U14	Exadata Storage Server	31
U12	Exadata Storage Server	33
U10	Exadata Storage Server	35
U8	Exadata Storage Server	37
U6	Exadata Storage Server	39
U4	Exadata Storage Server	41
U2	Exadata Storage Server	43
U1	Sun Datacenter InfiniBand Switch 36 switch Note that the spine switch is no longer included by default on Exadata X4-2 and newer models, but port 47 is still reserved on Cisco 4948 for the spine InfiniBand switch.	47

Table 15-6 shows the cable connections from the servers to the Gigabit Ethernet switch in Oracle Exadata Database Machine X4-2 Half Rack:

**Table 15-6 Gigabit Ethernet Cabling for Oracle Exadata Database Machine X4-2 Half Rack**

From Rack Unit	Type of Equipment	Gigabit Ethernet Port
U22	Sun Datacenter InfiniBand Switch 36 switch	45
U20	Sun Datacenter InfiniBand Switch 36 switch	46
U19	Database server	23
U18	Database server	25
U17	Database server	27
U16	Database server	29
U14	Exadata Storage Server	31
U12	Exadata Storage Server	33
U10	Exadata Storage Server	35
U8	Exadata Storage Server	37
U6	Exadata Storage Server	39
U4	Exadata Storage Server	41
U2	Exadata Storage Server	43

**Table 15-6 (Cont.) Gigabit Ethernet Cabling for Oracle Exadata Database Machine X4-2 Half Rack**

From Rack Unit	Type of Equipment	Gigabit Ethernet Port
U1	Sun Datacenter InfiniBand Switch 36 switch  Note that the spine switch is no longer included by default on Exadata X4-2 and newer models, but port 47 is still reserved on Cisco 4948 for the spine InfiniBand switch.	47

Table 15-7 shows the cable connections from the servers to the Gigabit Ethernet switch in Oracle Exadata Database Machine X4-2 Quarter Rack:

**Table 15-7 Gigabit Ethernet Cabling for Oracle Exadata Database Machine X4-2 Quarter Rack**

From Rack Unit	Type of Equipment	Gigabit Ethernet Port
U22	Sun Datacenter InfiniBand Switch 36 switch	45
U20	Sun Datacenter InfiniBand Switch 36 switch	46
U17	Database server	27
U16	Database server	29
U6	Exadata Storage Server	39
U4	Exadata Storage Server	41
U2	Exadata Storage Server	43

Table 15-8 shows the cable connections from the servers to the Gigabit Ethernet switch in Oracle Exadata Database Machine X4-8 Full Rack:

**Table 15-8 Gigabit Ethernet Cabling for Oracle Exadata Database Machine X4-8 Full Rack**

From Rack Unit	Type of Equipment	Gigabit Ethernet Port
U41	Exadata Storage Server	1
U39	Exadata Storage Server	3
U37	Exadata Storage Server	5
U35	Exadata Storage Server	7
U33	Exadata Storage Server	9
U31	Exadata Storage Server	11
U29	Exadata Storage Server	13
U24	Database server	15

**Table 15-8 (Cont.) Gigabit Ethernet Cabling for Oracle Exadata Database Machine X4-8 Full Rack**

From Rack Unit	Type of Equipment	Gigabit Ethernet Port
U23	Sun Datacenter InfiniBand Switch 36	33
U21	Sun Datacenter InfiniBand Switch 36	34
U16	Database server	17
U14	Exadata Storage Server	19
U12	Exadata Storage Server	21
U10	Exadata Storage Server	23
U8	Exadata Storage Server	25
U6	Exadata Storage Server	27
U4	Exadata Storage Server	29
U2	Exadata Storage Server	31

## 15.4 Single Phase Power Distribution Unit Cabling Tables

This section contains the tables for single phase cabling from each power distribution unit (PDU) to the power supplies configured in each rack. The cables are terminated to PDU-A on the left, and routed to the right to enter CMA, and are bundled in groups of four.

The following tables are in this section:

- [Table 15-9](#)
- [Table 15-10](#)
- [Table 15-11](#)
- [Table 15-12](#)

[Table 15-9](#) shows the cable connections from the PDUs to the rack units in Oracle Exadata Database Machine X4-2 Full Rack.

**Table 15-9 Single Phase PDU Cabling for Oracle Exadata Database Machine X4-2 Full Rack**

Rack Unit	PDU-A/PS-00	PDU-B/PS-01	Cable Length
U39	G5-6	G0-0	2 meters
U37	G5-3	G0-3	2 meters
U35	G5-0	G0-6	2 meters
U33	G4-6	G1-0	2 meters
U31	G4-4	G1-2	2 meters
U29	G4-2	G1-4	2 meters
U27	G3-6	G2-0	2 meters
U26	G4-0	G1-6	2 meters

**Table 15-9 (Cont.) Single Phase PDU Cabling for Oracle Exadata Database Machine X4-2 Full Rack**

Rack Unit	PDU-A/PS-00	PDU-B/PS-01	Cable Length
U25	G3-5	G2-1	2 meters
U24	G3-4	G2-2	2 meters
U23	G3-3	G2-3	2 meters
U22	G3-1	G2-5	2 meters
U21	G3-0 (Cisco PS-2)	G2-6 (Cisco PS-1)	2 meters
U20	G2-4	G3-2	2 meters
U19	G2-3	G3-3	2 meters
U18	G2-2	G3-4	2 meters
U17	G2-1	G3-5	2 meters
U16	G1-6	G4-0	2 meters
U14	G2-0	G3-6	2 meters
U12	G1-4	G4-2	2 meters
U10	G1-2	G4-4	2 meters
U8	G1-0	G4-6	2 meters
U6	G0-6	G5-0	2 meters
U4	G0-4	G5-2	2 meters
U2	G0-2	G5-4	2 meters

Table 15-10 shows the cable connections from the PDUs to the rack units in Oracle Exadata Database Machine X4-2 Half Rack.

**Table 15-10 Single Phase PDU Cabling for Oracle Exadata Database Machine X4-2 Half Rack**

Rack Unit	PDU-A/PS-00	PDU-B/PS-01	Cable Length
U22	G3-1	G2-5	2 meters
U21	G3-0 (Cisco PS-2)	G2-6 (Cisco PS-1)	2 meters
U20	G2-4	G3-2	2 meters
U19	G2-3	G3-3	2 meters
U18	G2-2	G3-4	2 meters
U17	G2-1	G3-5	2 meters
U16	G1-6	G4-0	2 meters
U14	G2-0	G3-6	2 meters
U12	G1-4	G4-2	2 meters
U10	G1-2	G4-4	2 meters
U8	G1-0	G4-6	2 meters
U6	G0-6	G5-0	2 meters
U4	G0-4	G5-2	2 meters

**Table 15-10 (Cont.) Single Phase PDU Cabling for Oracle Exadata Database Machine X4-2 Half Rack**

Rack Unit	PDU-A/PS-00	PDU-B/PS-01	Cable Length
U2	G0-2	G5-4	2 meters

Table 15-11 shows the cable connections from the PDUs to the rack units in Oracle Exadata Database Machine X4-2 Quarter Rack.

**Table 15-11 Single Phase PDU Cabling for Oracle Exadata Database Machine X4-2 Quarter Rack**

Rack Unit	PDU-A/PS-00	PDU-B/PS-01	Cable Length
U22	G3-1	G2-5	2 meters
U21	G3-0 (Cisco PS-2)	G2-6 (Cisco PS-1)	2 meters
U20	G2-4	G3-2	2 meters
U17	G2-1	G3-5	2 meters
U16	G1-6	G4-0	2 meters
U6	G0-6	G5-0	2 meters
U4	G0-4	G5-2	2 meters
U2	G0-2	G5-4	2 meters

Table 15-12 shows the cable connections from the PDUs to the rack units in Oracle Exadata Database Machine X4-8 Full Rack.

**Table 15-12 Single Phase PDU Cabling for Oracle Exadata Database Machine X4-8 Full Rack**

Rack Unit	PDU-A/PS-00	PDU-B/PS-01	Cable Length
U41	G5-6	G0-0	2 meters
U39	G5-4	G0-2	2 meters
U37	G5-2	G0-4	2 meters
U35	G5-0	G0-6	2 meters
U33	G4-6	G1-0	2 meters
U31	G4-3	G1-3	2 meters
U29	G3-6	G2-0	2 meters
U24	G4-7 (C19) (AC0)	G1-7 (C19) (AC1)	1 meter
U24	G2-7 (C19) (AC2)	G3-7 (C19) (AC3)	1 meter
U23	G3-1	G2-5	2 meters
U22	G2-6 (PS-2)	G3-0 (PS-1)	2 meters
U21	G3-0	G2-6	2 meters
U16	G3-7 (C19) (AC0)	G2-7 (C19) (AC1)	1 meter
U16	G1-7 (C19) (AC2)	G4-7 (C19) (AC3)	1 meter

**Table 15-12 (Cont.) Single Phase PDU Cabling for Oracle Exadata Database Machine X4-8 Full Rack**

Rack Unit	PDU-A/PS-00	PDU-B/PS-01	Cable Length
U14	G2-0	G3-6	2 meters
U12	G1-3	G4-3	2 meters
U10	G1-0	G4-6	2 meters
U8	G0-6	G5-0	2 meters
U6	G0-4	G5-2	2 meters
U4	G0-3	G5-3	2 meters
U2	G0-1	G5-5	2 meters
U1	G0-0	G5-6	2 meters

## 15.5 Three Phase Power Distribution Unit Cabling Tables

This section contains the tables for three phase cabling from each power distribution unit (PDU) to the power supplies configured in each rack. The cables are terminated to PDU-A on the left, and routed to the right to enter CMA, and are bundled in groups of four.

The following tables are in this section:

- [Table 15-13](#)
- [Table 15-14](#)
- [Table 15-15](#)
- [Table 15-16](#)

[Table 15-13](#) shows the cable connections from the PDUs to the rack units in Oracle Exadata Database Machine X4-2 Full Rack.

**Table 15-13 Three Phase PDU Cabling for Oracle Exadata Database Machine X4-2 Full Rack**

Rack Unit	PDU-A/PS-00	PDU-B/PS-01	Cable Length
U39	G5-6	G2-0	2 meters
U37	G5-3	G2-3	2 meters
U35	G5-0	G2-6	2 meters
U33	G4-6	G1-0	2 meters
U31	G4-4	G1-2	2 meters
U29	G4-2	G1-4	2 meters
U27	G3-6	G0-0	2 meters
U26	G4-0	G1-6	2 meters
U25	G3-5	G0-1	2 meters
U24	G3-4	G0-2	2 meters

**Table 15-13 (Cont.) Three Phase PDU Cabling for Oracle Exadata Database Machine X4-2 Full Rack**

Rack Unit	PDU-A/PS-00	PDU-B/PS-01	Cable Length
U23	G3-3	G0-3	2 meters
U22	G3-1	G0-5	2 meter
U21	G3-0	G0-6	2 meters
U20	G2-4	G5-2	2 meters
U19	G2-3	G5-3	2 meters
U18	G2-2	G5-4	2 meters
U17	G2-1	G5-5	2 meters
U16	G1-6	G4-0	2 meters
U14	G2-0	G5-6	2 meters
U12	G1-4	G4-2	2 meters
U10	G1-2	G4-4	2 meters
U8	G1-0	G4-6	2 meters
U6	G0-6	G3-0	2 meters
U4	G0-4	G3-2	2 meters
U2	G0-2	G3-4	2 meters

[Table 15-14](#) shows the cable connections from the PDUs to the rack units in Oracle Exadata Database Machine X4-2 Half Rack.

**Table 15-14 Three Phase PDU Cabling for Oracle Exadata Database Machine X4-2 Half Rack**

Rack Unit	PDU-A/PS-00	PDU-B/PS-01	Cable Length
U22	G3-1	G0-5	2 meter
U21	G3-0	G0-6	2 meters
U20	G2-4	G5-2	2 meters
U19	G2-3	G5-3	2 meters
U18	G2-2	G5-4	2 meters
U17	G2-1	G5-5	2 meters
U16	G1-6	G4-0	2 meters
U14	G2-0	G5-6	2 meters
U12	G1-4	G4-2	2 meters
U10	G1-2	G4-4	2 meters
U8	G1-0	G4-6	2 meters
U6	G0-6	G3-0	2 meters
U4	G0-4	G3-2	2 meters
U2	G0-2	G3-4	2 meters



Table 15-15 shows the cable connections from the PDUs to the rack units in Oracle Exadata Database Machine X4-2 Quarter Rack.

**Table 15-15 Three Phase PDU Cabling for Oracle Exadata Database Machine X4-2 Quarter Rack**

Rack Unit	PDU-A/PS-00	PDU-B/PS-01	Cable Length
U22	G3-1	G0-5	2 meter
U21	G3-0	G0-6	2 meters
U20	G2-4	G5-2	2 meters
U17	G2-1	G5-5	2 meters
U16	G1-6	G4-0	2 meters
U6	G0-6	G3-0	2 meters
U4	G0-4	G3-2	2 meters
U2	G0-2	G3-4	2 meters

Table 15-16 shows the cable connections from the PDUs to the rack units in Oracle Exadata Database Machine X4-8 Full Rack.

**Table 15-16 Three Phase PDU Cabling for Oracle Exadata Database Machine X4-8 Full Rack**

Rack Unit	PDU-A/PS-00	PDU-B/PS-01	Cable Length
U41	G5-5	G2-1	2 meters
U39	G5-4	G2-2	2 meters
U37	G5-2	G2-4	2 meters
U35	G5-1	G2-5	2 meters
U33	G5-0	G2-6	2 meters
U31	G4-6	G1-0	2 meters
U29	G4-4	G1-2	2 meters
U24	AC0 to G4-7 (C19)	AC1 to G1-7 (C19)	1 meter
U24	AC2 to G3-7 (C19)	AC3 to G0-7 (C19)	1 meter
U23	G3-1	G0-5	2 meters
U22	G3-0	G0-6	2 meters
U21	G2-5	G5-1	2 meters
U16	AC0 to G1-7 (C19)	AC1 to G4-7 (C19)	1 meter
U16	AC2 to G2-7 (C19)	AC3 to G5-7 (C19)	1 meter
U14	G1-3	G4-3	2 meters
U12	G1-0	G4-6	2 meters
U10	G0-6	G3-0	2 meters
U8	G0-5	G3-1	2 meters
U6	G0-4	G3-2	2 meters
U4	G0-2	G3-4	2 meters

**Table 15-16 (Cont.) Three Phase PDU Cabling for Oracle Exadata Database Machine X4-8 Full Rack**

Rack Unit	PDU-A/PS-00	PDU-B/PS-01	Cable Length
U2	G0-1	G3-5	2 meters
U1	G0-0	G3-6	2 meters

## 15.6 InfiniBand Network Cabling Tables

This topic contains the tables for the InfiniBand network cabling for Oracle Exadata Database Machine X4 racks.

In Oracle Exadata Database Machine X4-2, the Sun Datacenter InfiniBand Switch 36 switches are located in rack slots 20 and 22. In Oracle Exadata Database Machine X4-8, the Sun Datacenter InfiniBand Switch 36 switches are located in rack units 21 and 23. If present, the optional spine switch is located in rack unit 1.

The following tables are in this section:

- [Table 15-17](#) InfiniBand Network Cabling for Oracle Exadata Database Machine X4-2 Full Rack
- [Table 15-18](#) InfiniBand Network Cabling for Oracle Exadata Database Machine X4-2 Half Rack
- [Table 15-19](#) InfiniBand Network Cabling for Oracle Exadata Database Machine X4-2 Quarter Rack and Oracle Exadata Database Machine X4-2 Eighth Rack
- [Table 15-20](#) InfiniBand Network Cabling for Oracle Exadata Database Machine X4-8 Full Rack

The following table lists the location, ports and cables for the InfiniBand connections for Oracle Exadata Database Machine X4-2 Full Rack.

**Table 15-17 InfiniBand Network Cabling for Oracle Exadata Database Machine X4-2 Full Rack**

From InfiniBand Switch Rack Unit	Port	To Rack Unit	Type of Equipment	Port	Cable Description
U22	0A	U39	Oracle Exadata Storage Server	PCIe 3, P1	3 meter QDR InfiniBand cable
U22	0B	U37	Oracle Exadata Storage Server	PCIe 3, P1	3 meter QDR InfiniBand cable
U22	1A	U35	Oracle Exadata Storage Server	PCIe 3, P1	3 meter QDR InfiniBand cable
U22	1B	U33	Oracle Exadata Storage Server	PCIe 3, P1	3 meter QDR InfiniBand cable

**Table 15-17 (Cont.) InfiniBand Network Cabling for Oracle Exadata Database Machine X4-2 Full Rack**

From InfiniBand Switch Rack Unit	Port	To Rack Unit	Type of Equipment	Port	Cable Description
U22	2A	U31	Oracle Exadata Storage Server	PCIe 3, P1	3 meter QDR InfiniBand cable
U22	2B	U29	Oracle Exadata Storage Server	PCIe 3, P1	3 meter QDR InfiniBand cable
U22	3B	U27	Oracle Exadata Storage Server	PCIe 3, P1	3 meter QDR InfiniBand cable
U22	3A	U26	Oracle Exadata Database Server	PCIe 3, P1	2 meter QDR InfiniBand cable
U22	4A	U25	Oracle Exadata Database Server	PCIe 3, P1	2 meter QDR InfiniBand cable
U22	4B	U24	Oracle Exadata Database Server	PCIe 3, P1	2 meter QDR InfiniBand cable
U22	5A	U23	Oracle Exadata Database Server	PCIe 3, P1	2 meter QDR InfiniBand cable
U22	12B	U19	Oracle Exadata Database Server	PCIe 3, P2	2 meter QDR InfiniBand cable
U22	13A	U18	Oracle Exadata Database Server	PCIe 3, P2	2 meter QDR InfiniBand cable
U22	13B	U17	Oracle Exadata Database Server	PCIe 3, P2	2 meter QDR InfiniBand cable
U22	14B	U16	Oracle Exadata Database Server	PCIe 3, P2	2 meter QDR InfiniBand cable
U22	14A	U14	Oracle Exadata Storage Server	PCIe 3, P2	3 meter QDR InfiniBand cable
U22	15A	U12	Oracle Exadata Storage Server	PCIe 3, P2	3 meter QDR InfiniBand cable
U22	15B	U10	Oracle Exadata Storage Server	PCIe 3, P2	3 meter QDR InfiniBand cable

**Table 15-17 (Cont.) InfiniBand Network Cabling for Oracle Exadata Database Machine X4-2 Full Rack**

From InfiniBand Switch Rack Unit	Port	To Rack Unit	Type of Equipment	Port	Cable Description
U22	16A	U8	Oracle Exadata Storage Server	PCIe 3, P2	3 meter QDR InfiniBand cable
U22	16B	U6	Oracle Exadata Storage Server	PCIe 3, P2	3 meter QDR InfiniBand cable
U22	17A	U4	Oracle Exadata Storage Server	PCIe 3, P2	3 meter QDR InfiniBand cable
U22	17B	U2	Oracle Exadata Storage Server	PCIe 3, P2	3 meter QDR InfiniBand cable
U20	0A	U39	Oracle Exadata Storage Server	PCIe 3, P2	3 meter QDR InfiniBand cable
U20	0B	U37	Oracle Exadata Storage Server	PCIe 3, P2	3 meter QDR InfiniBand cable
U20	1A	U35	Oracle Exadata Storage Server	PCIe 3, P2	3 meter QDR InfiniBand cable
U20	1B	U33	Oracle Exadata Storage Server	PCIe 3, P2	3 meter QDR InfiniBand cable
U20	2A	U31	Oracle Exadata Storage Server	PCIe 3, P2	3 meter QDR InfiniBand cable
U20	2B	U29	Oracle Exadata Storage Server	PCIe 3, P2	3 meter QDR InfiniBand cable
U20	3B	U27	Oracle Exadata Storage Server	PCIe 3, P2	3 meter QDR InfiniBand cable
U20	3A	U26	Oracle Exadata Database Server	PCIe 3, P2	2 meter QDR InfiniBand cable
U20	4A	U25	Oracle Exadata Database Server	PCIe 3, P2	2 meter QDR InfiniBand cable
U20	4B	U24	Oracle Exadata Database Server	PCIe 3, P2	2 meter QDR InfiniBand cable

**Table 15-17 (Cont.) InfiniBand Network Cabling for Oracle Exadata Database Machine X4-2 Full Rack**

From InfiniBand Switch Rack Unit	Port	To Rack Unit	Type of Equipment	Port	Cable Description
U20	5A	U23	Oracle Exadata Database Server	PCIe 3, P2	2 meter QDR InfiniBand cable
U20	12B	U19	Oracle Exadata Database Server	PCIe 3, P1	2 meter QDR InfiniBand cable
U20	13A	U18	Oracle Exadata Database Server	PCIe 3, P1	2 meter QDR InfiniBand cable
U20	13B	U17	Oracle Exadata Database Server	PCIe 3, P1	2 meter QDR InfiniBand cable
U20	14B	U16	Oracle Exadata Database Server	PCIe 3, P1	2 meter QDR InfiniBand cable
U20	14A	U14	Oracle Exadata Storage Server	PCIe 3, P1	2 meter QDR InfiniBand cable
U20	15A	U12	Oracle Exadata Storage Server	PCIe 3, P1	3 meter QDR InfiniBand cable
U20	15B	U10	Oracle Exadata Storage Server	PCIe 3, P1	3 meter QDR InfiniBand cable
U20	16A	U8	Oracle Exadata Storage Server	PCIe 3, P1	3 meter QDR InfiniBand cable
U20	16B	U6	Oracle Exadata Storage Server	PCIe 3, P1	3 meter QDR InfiniBand cable
U20	17A	U4	Oracle Exadata Storage Server	PCIe 3, P1	3 meter QDR InfiniBand cable
U20	17B	U2	Oracle Exadata Storage Server	PCIe 3, P1	3 meter QDR InfiniBand cable
U20	9B	U22	Sun Datacenter InfiniBand Switch 36 switch	9A	1 meter QDR InfiniBand cable
U20	10B	U22	Sun Datacenter InfiniBand Switch 36 switch	10A	1 meter QDR InfiniBand cable

**Table 15-17 (Cont.) InfiniBand Network Cabling for Oracle Exadata Database Machine X4-2 Full Rack**

From InfiniBand Switch Rack Unit	Port	To Rack Unit	Type of Equipment	Port	Cable Description
U20	11B	U22	Sun Datacenter InfiniBand Switch 36 switch	11A	1 meter QDR InfiniBand cable
U20	8A	U22	Sun Datacenter InfiniBand Switch 36 switch	8A	1 meter QDR InfiniBand cable
U20	9A	U22	Sun Datacenter InfiniBand Switch 36 switch	9B	1 meter QDR InfiniBand cable
U20	10A	U22	Sun Datacenter InfiniBand Switch 36 switch	10B	1 meter QDR InfiniBand cable
U20	11A	U22	Sun Datacenter InfiniBand Switch 36 switch	11B	1 meter QDR InfiniBand cable
U1 — when added as an optional configuration	1B	U20	Sun Datacenter InfiniBand Switch 36 switch	8B	3 meter QDR InfiniBand cable
U1 — when added as an optional configuration	0B	U22	Sun Datacenter InfiniBand Switch 36 switch	8B	3 meter QDR InfiniBand cable

The following table lists the location, ports and cables for the InfiniBand connections for Oracle Exadata Database Machine X4-2 Half Rack.

**Table 15-18 InfiniBand Network Cabling for Oracle Exadata Database Machine X4-2 Half Rack**

From InfiniBand Switch Rack Unit	Port	To Rack Unit	Type of Equipment	Port	Cable Description
U22	12B	U19	Oracle Exadata Database Server	PCIe 3, P2	2 meter QDR InfiniBand cable
U22	13A	U18	Oracle Exadata Database Server	PCIe 3, P2	2 meter QDR InfiniBand cable

**Table 15-18 (Cont.) InfiniBand Network Cabling for Oracle Exadata Database Machine X4-2 Half Rack**

From InfiniBand Switch Rack Unit	Port	To Rack Unit	Type of Equipment	Port	Cable Description
U22	13B	U17	Oracle Exadata Database Server	PCIe 3, P2	2 meter QDR InfiniBand cable
U22	14B	U16	Oracle Exadata Database Server	PCIe 3, P2	2 meter QDR InfiniBand cable
U22	14A	U14	Oracle Exadata Storage Server	PCIe 3, P2	3 meter QDR InfiniBand cable
U22	15A	U12	Oracle Exadata Storage Server	PCIe 3, P2	3 meter QDR InfiniBand cable
U22	15B	U10	Oracle Exadata Storage Server	PCIe 3, P2	3 meter QDR InfiniBand cable
U22	16A	U8	Oracle Exadata Storage Server	PCIe 3, P2	3 meter QDR InfiniBand cable
U22	16B	U6	Oracle Exadata Storage Server	PCIe 3, P2	3 meter QDR InfiniBand cable
U22	17A	U4	Oracle Exadata Storage Server	PCIe 3, P2	3 meter QDR InfiniBand cable
U22	17B	U2	Oracle Exadata Storage Server	PCIe 3, P2	3 meter QDR InfiniBand cable
U20	12B	U19	Oracle Exadata Database Server	PCIe 3, P1	2 meter QDR InfiniBand cable
U20	13A	U18	Oracle Exadata Database Server	PCIe 3, P1	2 meter QDR InfiniBand cable
U20	13B	U17	Oracle Exadata Database Server	PCIe 3, P1	2 meter QDR InfiniBand cable
U20	14B	U16	Oracle Exadata Database Server	PCIe 3, P1	2 meter QDR InfiniBand cable
U20	14A	U14	Oracle Exadata Storage Server	PCIe 3, P1	2 meter QDR InfiniBand cable

**Table 15-18 (Cont.) InfiniBand Network Cabling for Oracle Exadata Database Machine X4-2 Half Rack**

From InfiniBand Switch Rack Unit	Port	To Rack Unit	Type of Equipment	Port	Cable Description
U20	15A	U12	Oracle Exadata Storage Server	PCIe 3, P1	3 meter QDR InfiniBand cable
U20	15B	U10	Oracle Exadata Storage Server	PCIe 3, P1	3 meter QDR InfiniBand cable
U20	16A	U8	Oracle Exadata Storage Server	PCIe 3, P1	3 meter QDR InfiniBand cable
U20	16B	U6	Oracle Exadata Storage Server	PCIe 3, P1	3 meter QDR InfiniBand cable
U20	17A	U4	Oracle Exadata Storage Server	PCIe 3, P1	3 meter QDR InfiniBand cable
U20	17B	U2	Oracle Exadata Storage Server	PCIe 3, P1	3 meter QDR InfiniBand cable
U20	9B	U22	Sun Datacenter InfiniBand Switch 36 switch	9A	1 meter QDR InfiniBand cable
U20	10B	U22	Sun Datacenter InfiniBand Switch 36 switch	10A	1 meter QDR InfiniBand cable
U20	11B	U22	Sun Datacenter InfiniBand Switch 36 switch	11A	1 meter QDR InfiniBand cable
U20	8A	U22	Sun Datacenter InfiniBand Switch 36 switch	8A	1 meter QDR InfiniBand cable
U20	9A	U22	Sun Datacenter InfiniBand Switch 36 switch	9B	1 meter QDR InfiniBand cable
U20	10A	U22	Sun Datacenter InfiniBand Switch 36 switch	10B	1 meter QDR InfiniBand cable



**Table 15-18 (Cont.) InfiniBand Network Cabling for Oracle Exadata Database Machine X4-2 Half Rack**

From InfiniBand Switch Rack Unit	Port	To Rack Unit	Type of Equipment	Port	Cable Description
U20	11A	U22	Sun Datacenter InfiniBand Switch 36 switch	11B	1 meter QDR InfiniBand cable
U1 — when added as an optional configuration	1B	U20	Sun Datacenter InfiniBand Switch 36 switch	8B	3 meter QDR InfiniBand cable
U1 — when added as an optional configuration	0B	U22	Sun Datacenter InfiniBand Switch 36 switch	8B	3 meter QDR InfiniBand cable

The following table lists the location, ports and cables for the InfiniBand connections for Oracle Exadata Database Machine X4-2 Quarter Rack and Oracle Exadata Database Machine X4-2 Eighth Rack.

 **Note:**

The same rules and restrictions apply to Oracle Exadata Database Machine X4-2 Eighth Rack as for Oracle Exadata Database Machine X4-2 Quarter Rack.

**Table 15-19 InfiniBand Network Cabling for Oracle Exadata Database Machine X4-2 Quarter Rack and Oracle Exadata Database Machine X4-2 Eighth Rack**

From InfiniBand Switch Rack Unit	Port	To Rack Unit	Type of Equipment	Port	Cable Description
U22	13B	U17	Oracle Exadata Database Server	PCIe 3, P2	2 meter QDR InfiniBand cable
U22	14B	U16	Oracle Exadata Database Server	PCIe 3, P2	2 meter QDR InfiniBand cable
U22	16B	U6	Oracle Exadata Storage Server	PCIe 3, P2	3 meter QDR InfiniBand cable

**Table 15-19 (Cont.) InfiniBand Network Cabling for Oracle Exadata Database Machine X4-2 Quarter Rack and Oracle Exadata Database Machine X4-2 Eighth Rack**

From InfiniBand Switch Rack Unit	Port	To Rack Unit	Type of Equipment	Port	Cable Description
U22	17A	U4	Oracle Exadata Storage Server	PCIe 3, P2	3 meter QDR InfiniBand cable
U22	17B	U2	Oracle Exadata Storage Server	PCIe 3, P2	3 meter QDR InfiniBand cable
U20	13B	U17	Oracle Exadata Database Server	PCIe 3, P1	2 meter QDR InfiniBand cable
U20	14B	U16	Oracle Exadata Database Server	PCIe 3, P1	2 meter QDR InfiniBand cable
U20	16B	U6	Oracle Exadata Storage Server	PCIe 3, P1	3 meter QDR InfiniBand cable
U20	17A	U4	Oracle Exadata Storage Server	PCIe 3, P1	3 meter QDR InfiniBand cable
U20	17B	U2	Oracle Exadata Storage Server	PCIe 3, P1	3 meter QDR InfiniBand cable
U20	9B	U22	Sun Datacenter InfiniBand Switch 36 switch	9A	1 meter QDR InfiniBand cable
U20	10B	U22	Sun Datacenter InfiniBand Switch 36 switch	10A	1 meter QDR InfiniBand cable
U20	11B	U22	Sun Datacenter InfiniBand Switch 36 switch	11A	1 meter QDR InfiniBand cable

**Table 15-19 (Cont.) InfiniBand Network Cabling for Oracle Exadata Database Machine X4-2 Quarter Rack and Oracle Exadata Database Machine X4-2 Eighth Rack**

From InfiniBand Switch Rack Unit	Port	To Rack Unit	Type of Equipment	Port	Cable Description
U20	8A	U22	Sun Datacenter InfiniBand Switch 36 switch	8A	1 meter QDR InfiniBand cable
U20	9A	U22	Sun Datacenter InfiniBand Switch 36 switch	9B	1 meter QDR InfiniBand cable
U20	10A	U22	Sun Datacenter InfiniBand Switch 36 switch	10B	1 meter QDR InfiniBand cable
U20	11A	U22	Sun Datacenter InfiniBand Switch 36 switch	11B	1 meter QDR InfiniBand cable
U1 — when added as an optional configuration	1B	U20	Sun Datacenter InfiniBand Switch 36 switch	8B	3 meter QDR InfiniBand cable
U1 — when added as an optional configuration	0B	U22	Sun Datacenter InfiniBand Switch 36 switch	8B	3 meter QDR InfiniBand cable

The following table lists the location, ports and cables for the InfiniBand connections for Oracle Exadata Database Machine X4-8 Full Rack.

**Table 15-20 InfiniBand Network Cabling for Oracle Exadata Database Machine X4-8 Full Rack**

From InfiniBand Switch Rack Unit	Port	To Rack Unit	Type of Equipment	Port	Cable Description
U23	0A	U41	Oracle Exadata Storage Server	3 PCIe3 P1	3 meter QDR InfiniBand cable

**Table 15-20 (Cont.) InfiniBand Network Cabling for Oracle Exadata Database Machine X4-8 Full Rack**

From InfiniBand Switch Rack Unit	Port	To Rack Unit	Type of Equipment	Port	Cable Description
U23	0B	U39	Oracle Exadata Storage Server	3 PCIe3 P1	3 meter QDR InfiniBand cable
U23	1A	U37	Oracle Exadata Storage Server	3 PCIe3 P1	3 meter QDR InfiniBand cable
U23	1B	U35	Oracle Exadata Storage Server	3 PCIe3 P1	3 meter QDR InfiniBand cable
U23	2A	U33	Oracle Exadata Storage Server	3 PCIe3 P1	3 meter QDR InfiniBand cable
U23	2B	U31	Oracle Exadata Storage Server	3 PCIe3 P1	3 meter QDR InfiniBand cable
U23	3B	U29	Oracle Exadata Storage Server	3 PCIe3 P1	3 meter QDR InfiniBand cable
U23	3A	U24	Oracle Exadata Database Server	12 PCIe3 P1	2 meter QDR InfiniBand cable
U23	4A	U24	Oracle Exadata Database Server	10 PCIe3 P1	2 meter QDR InfiniBand cable
U23	4B	U24	Oracle Exadata Database Server	8 PCIe3 P1	2 meter QDR InfiniBand cable
U23	5A	U24	Oracle Exadata Database Server	6 PCIe3 P1	2 meter QDR InfiniBand cable
U23	13A	U16	Oracle Exadata Database Server	10 PCIe3 P2	2 meter QDR InfiniBand cable

**Table 15-20 (Cont.) InfiniBand Network Cabling for Oracle Exadata Database Machine X4-8 Full Rack**

From InfiniBand Switch Rack Unit	Port	To Rack Unit	Type of Equipment	Port	Cable Description
U23	13B	U16	Oracle Exadata Database Server	8 PCIe3 P2	2 meter QDR InfiniBand cable
U23	14B	U16	Oracle Exadata Database Server	6 PCIe3 P2	2 meter QDR InfiniBand cable
U23	12B	U16	Oracle Exadata Database Server	12 PCIe3 P2	2 meter QDR InfiniBand cable
U23	14A	U14	Oracle Exadata Storage Server	3 PCIe3 P2	3 meter QDR InfiniBand cable
U23	15A	U12	Oracle Exadata Storage Server	3 PCIe3 P2	3 meter QDR InfiniBand cable
U23	15B	U10	Oracle Exadata Storage Server	3 PCIe3 P2	3 meter QDR InfiniBand cable
U23	16A	U8	Oracle Exadata Storage Server	3 PCIe3 P2	3 meter QDR InfiniBand cable
U23	16B	U6	Oracle Exadata Storage Server	3 PCIe3 P2	3 meter QDR InfiniBand cable
U23	17A	U4	Oracle Exadata Storage Server	3 PCIe3 P2	3 meter QDR InfiniBand cable
U23	17B	U2	Oracle Exadata Storage Server	3 PCIe3 P2	3 meter QDR InfiniBand cable
U21	0A	U41	Oracle Exadata Storage Server	3 PCIe3 P2	3 meter QDR InfiniBand cable

**Table 15-20 (Cont.) InfiniBand Network Cabling for Oracle Exadata Database Machine X4-8 Full Rack**

From InfiniBand Switch Rack Unit	Port	To Rack Unit	Type of Equipment	Port	Cable Description
U21	0B	U39	Oracle Exadata Storage Server	3 PCIe3 P2	3 meter QDR InfiniBand cable
U21	1A	U37	Oracle Exadata Storage Server	3 PCIe3 P2	3 meter QDR InfiniBand cable
U21	1B	U35	Oracle Exadata Storage Server	3 PCIe3 P2	3 meter QDR InfiniBand cable
U21	2A	U33	Oracle Exadata Storage Server	3 PCIe3 P2	3 meter QDR InfiniBand cable
U21	2B	U31	Oracle Exadata Storage Server	3 PCIe3 P2	3 meter QDR InfiniBand cable
U21	3B	U29	Oracle Exadata Storage Server	3 PCIe3 P2	3 meter QDR InfiniBand cable
U21	3A	U24	Oracle Exadata Database Server	12 PCIe3 P2	2 meter QDR InfiniBand cable
U21	4A	U24	Oracle Exadata Database Server	10 PCIe3 P2	2 meter QDR InfiniBand cable
U21	4B	U24	Oracle Exadata Database Server	8 PCIe3 P2	2 meter QDR InfiniBand cable
U21	5A	U24	Oracle Exadata Database Server	6 PCIe3 P2	2 meter QDR InfiniBand cable
U21	12B	U16	Oracle Exadata Database Server	12 PCIe3 P1	2 meter QDR InfiniBand cable

**Table 15-20 (Cont.) InfiniBand Network Cabling for Oracle Exadata Database Machine X4-8 Full Rack**

From InfiniBand Switch Rack Unit	Port	To Rack Unit	Type of Equipment	Port	Cable Description
U21	13A	U16	Oracle Exadata Database Server	10 PCIe3 P1	2 meter QDR InfiniBand cable
U21	13B	U16	Oracle Exadata Database Server	8 PCIe3 P1	2 meter QDR InfiniBand cable
U21	14B	U16	Oracle Exadata Database Server	6 PCIe3 P1	2 meter QDR InfiniBand cable
U21	14A	U14	Oracle Exadata Storage Server	3 PCIe3 P1	2 meter QDR InfiniBand cable
U21	15A	U12	Oracle Exadata Storage Server	3 PCIe3 P1	3 meter QDR InfiniBand cable
U21	15B	U10	Oracle Exadata Storage Server	3 PCIe3 P1	3 meter QDR InfiniBand cable
U21	16A	U8	Oracle Exadata Storage Server	3 PCIe3 P1	3 meter QDR InfiniBand cable
U21	16B	U6	Oracle Exadata Storage Server	3 PCIe3 P1	3 meter QDR InfiniBand cable
U21	17A	U4	Oracle Exadata Storage Server	3 PCIe3 P1	3 meter QDR InfiniBand cable
U21	17B	U2	Oracle Exadata Storage Server	3 PCIe3 P1	3 meter QDR InfiniBand cable
U21	9B	U23	Sun Datacenter InfiniBand Switch 36 switch	9A	1 meter QDR InfiniBand cable

**Table 15-20 (Cont.) InfiniBand Network Cabling for Oracle Exadata Database Machine X4-8 Full Rack**

From InfiniBand Switch Rack Unit	Port	To Rack Unit	Type of Equipment	Port	Cable Description
U21	10B	U23	Sun Datacenter InfiniBand Switch 36 switch	10A	1 meter QDR InfiniBand cable
U21	11B	U23	Sun Datacenter InfiniBand Switch 36 switch	11A	1 meter QDR InfiniBand cable
U21	8A	U23	Sun Datacenter InfiniBand Switch 36 switch	8A	1 meter QDR InfiniBand cable
U21	9A	U23	Sun Datacenter InfiniBand Switch 36 switch	9B	1 meter QDR InfiniBand cable
U21	10A	U23	Sun Datacenter InfiniBand Switch 36 switch	10B	1 meter QDR InfiniBand cable
U21	11A	U23	Sun Datacenter InfiniBand Switch 36 switch	11B	1 meter QDR InfiniBand cable
U1 — when added as an optional configuration	1B	U21	Sun Datacenter InfiniBand Switch 36 switch	8B	3 meter QDR InfiniBand cable
U1 — when added as an optional configuration	0B	U23	Sun Datacenter InfiniBand Switch 36 switch	8B	3 meter QDR InfiniBand cable



# 16

## Cabling Tables for Oracle Exadata Database Machine X3-2 and Oracle Exadata Database Machine X3-8 Full Rack

The tables in this chapter show the cable layouts for Oracle Exadata Database Machine X3-2 and Oracle Exadata Database Machine X3-8 Full Rack.

- [Rack Layout Diagrams](#)  
The diagrams in this topic show the rack layout for Oracle Exadata Database Machine X3-2 and Oracle Exadata Database Machine X3-8.
- [Sun Integrated Lights Out Manager Cabling Tables](#)
- [Administrative Gigabit Ethernet Port Cabling Tables](#)
- [Single Phase Power Distribution Unit Cabling Tables](#)
- [Three Phase Power Distribution Unit Cabling Tables](#)
- [InfiniBand Network Cabling Tables](#)

### 16.1 Rack Layout Diagrams

The diagrams in this topic show the rack layout for Oracle Exadata Database Machine X3-2 and Oracle Exadata Database Machine X3-8.



#### Note:

For ease of reading, the name "Oracle Exadata Rack" is used when information refers to both Oracle Exadata Database Machine X3-2 and Oracle Exadata Storage Expansion Rack X3-2.

The following abbreviations are used in the tables:

Abbreviation	Description
$Rn$	Rack $n$ , where $n$ is the number of the rack, such as R1.
$Un$	Unit height in rack, where $n$ is the number, such as U20.
$Pn$	InfiniBand port $n$ , where $n$ is port number, such as P8A.

The cables used in Oracle Exadata Database Machine are color-coded as follows:


- Black: InfiniBand cables, or AC power jumper cables
- Red: Integrated Lights Out Manager (ILOM) cables

- Blue: Gigabit Ethernet cables

The following diagram shows the front and rear views of Oracle Exadata Database Machine X3-2 Full Rack. The front is shown on the left, and the rear is shown on the right.

**Figure 16-1 Rack Layout of Oracle Exadata Database Machine X3-2 Full Rack**

Front View			Rear View		
U42	1U Solid Filler	U42	U42	1U Solid Filler	U42
U41	1U Solid Filler	U41	U41	1U Solid Filler	U41
U40	Oracle Exadata storage cell	U40	U40	Oracle Exadata storage cell	U40
U39		U39	U39		
U38	Oracle Exadata storage cell	U38	U38	Oracle Exadata storage cell	U38
U37		U37	U37		
U36	Oracle Exadata storage cell	U36	U36	Oracle Exadata storage cell	U36
U35		U35	U35		
U34	Oracle Exadata storage cell	U34	U34	Oracle Exadata storage cell	U34
U33		U33	U33		
U32	Oracle Exadata storage cell	U32	U32	Oracle Exadata storage cell	U32
U31		U31	U31		
U30	Oracle Exadata storage cell	U30	U30	Oracle Exadata storage cell	U30
U29		U29	U29		
U28	Oracle Exadata storage cell	U28	U28	Oracle Exadata storage cell	U28
U27		U27	U27		
U26	Oracle Database Server	U26	U26	Oracle Database Server	U26
U25	Oracle Database Server	U25	U25	Oracle Database Server	U25
U24	Oracle Database Server	U24	U24	Oracle Database Server	U24
U23	Oracle Database Server	U23	U23	Oracle Database Server	U23
U22	1U Vented Filler	U22	U22	36-Port IB Switch	U22
U21	1U Vented Filler	U21	U21	Cisco 4948	U21
U20	1U Vented Filler	U20	U20	36-Port IB Switch	U20
U19	Oracle Database Server	U19	U19	Oracle Database Server	U19
U18	Oracle Database Server	U18	U18	Oracle Database Server	U18
U17	Oracle Database Server	U17	U17	Oracle Database Server	U17
U16	Oracle Database Server	U16	U16	Oracle Database Server	U16
U15	Oracle Exadata storage cell	U15	U15	Oracle Exadata storage cell	U15
U14		U14	U14		
U13	Oracle Exadata storage cell	U13	U13	Oracle Exadata storage cell	U13
U12		U12	U12		
U11	Oracle Exadata storage cell	U11	U11	Oracle Exadata storage cell	U11
U10		U10	U10		
U9	Oracle Exadata storage cell	U9	U9	Oracle Exadata storage cell	U9
U8		U8	U8		
U7	Oracle Exadata storage cell	U7	U7	Oracle Exadata storage cell	U7
U6		U6	U6		
U5	Oracle Exadata storage cell	U5	U5	Oracle Exadata storage cell	U5
U4		U4	U4		
U3	Oracle Exadata storage cell	U3	U3	Oracle Exadata storage cell	U3
U2		U2	U2		
U1	1U Vented Filler	U1	U1	36-Port IB Switch	U1

 \* Ports oriented to the rear

The next diagram shows the front and rear views of Oracle Exadata Database Machine X3-2 Half Rack.



**Note:**

The Sun Datacenter InfiniBand Switch 36 switch in rack position U1 is included in Oracle Exadata Database Machine X3-2 Half Racks.

**Figure 16-2 Rack Layout for Oracle Exadata Database Machine X3-2 Half Rack**

Front View			Rear View		
U42	4U Solid Filler	U42	U42		U42
U41		U41	U41		
U40		U40	U40		
U39		U39	U39		
U38	4U Solid Filler	U38	U38		U38
U37		U37	U37		
U36		U36	U36		
U35		U35	U35		
U34	2U Solid Filler	U34	U34		U34
U33		U33	U33		
U32	2U Solid Filler	U32	U32		U32
U31		U31	U31		
U30	2U Solid Filler	U30	U30		U30
U29		U29	U29		
U28	2U Solid Filler	U28	U28		U28
U27		U27	U27		
U26	1U Solid Filler	U26	U26		U26
U25	1U Solid Filler	U25	U25		U25
U24	1U Solid Filler	U24	U24		U24
U23	1U Solid Filler	U23	U23		U23
U22	1U Vented Filler	U22	U22	<b>36-Port IB Switch</b>	U22 *
U21	1U Vented Filler	U21	U21	<b>Cisco 4948</b>	U21 *
U20	1U Vented Filler	U20	U20	<b>36-Port IB Switch</b>	U20 *
U19	<b>Oracle Database Server</b>	U19	U19	<b>Oracle Database Server</b>	U19
U18	<b>Oracle Database Server</b>	U18	U18	<b>Oracle Database Server</b>	U18
U17	<b>Oracle Database Server</b>	U17	U17	<b>Oracle Database Server</b>	U17
U16	<b>Oracle Database Server</b>	U16	U16	<b>Oracle Database Server</b>	U16
U15	<b>Oracle Exadata storage cell</b>	U15	U15	<b>Oracle Exadata storage cell</b>	U15
U14		U14	U14		
U13	<b>Oracle Exadata storage cell</b>	U13	U13	<b>Oracle Exadata storage cell</b>	U13
U12		U12	U12		
U11	<b>Oracle Exadata storage cell</b>	U11	U11	<b>Oracle Exadata storage cell</b>	U11
U10		U10	U10		
U9	<b>Oracle Exadata storage cell</b>	U9	U9	<b>Oracle Exadata storage cell</b>	U9
U8		U8	U8		
U7	<b>Oracle Exadata storage cell</b>	U7	U7	<b>Oracle Exadata storage cell</b>	U7
U6		U6	U6		
U5	<b>Oracle Exadata storage cell</b>	U5	U5	<b>Oracle Exadata storage cell</b>	U5
U4		U4	U4		
U3	<b>Oracle Exadata storage cell</b>	U3	U3	<b>Oracle Exadata storage cell</b>	U3
U2		U2	U2		
U1	1U Vented Filler	U1	U1	<b>36-Port IB Switch</b>	U1

 \* Ports oriented to the rear

The next diagram shows the front and rear views of Oracle Exadata Database Machine X3-2 Quarter Rack.

**Figure 16-3 Rack Layout of Oracle Exadata Database Machine X3-2 Quarter Rack**

Front View			Rear View		
U42		U42	U42		U42
U41	4U Solid Filler	U41	U41		U41
U40		U40	U40		U40
U39		U39	U39		U39
U38	4U Solid Filler	U38	U38		U38
U37		U37	U37		U37
U36		U36	U36		U36
U35		U35	U35		U35
U34	2U Solid Filler	U34	U34		U34
U33		U33	U33		U33
U32	2U Solid Filler	U32	U32		U32
U31		U31	U31		U31
U30	2U Solid Filler	U30	U30		U30
U29		U29	U29		U29
U28	2U Solid Filler	U28	U28		U28
U27		U27	U27		U27
U26	1U Solid Filler	U26	U26		U26
U25	1U Solid Filler	U25	U25		U25
U24	1U Vented Filler	U24	U24		U24
U23	1U Solid Filler	U23	U23		U23
U22	1U Vented Filler	U22	U22	<b>36-Port IB Switch</b>	U22
U21	1U Vented Filler	U21	U21	<b>Cisco 4948</b>	U21
U20	1U Vented Filler	U20	U20	<b>36-Port IB Switch</b>	U20
U19	1U Solid Filler	U19	U19		U19
U18	1U Solid Filler	U18	U18		U18
U17	<b>Oracle Database Server</b>	U17	U17	<b>Oracle Database Server</b>	U17
U16	<b>Oracle Database Server</b>	U16	U16	<b>Oracle Database Server</b>	U16
U15	2U Solid Filler	U15	U15		U15
U14		U14	U14		U14
U13		U13	U13		U13
U12	2U Solid Filler	U12	U12		U12
U11		U11	U11		U11
U10	4U Solid Filler	U10	U10		U10
U9		U9	U9		U9
U8		U8	U8		U8
U7		<b>Oracle Exadata storage cell</b>	U7	U7	<b>Oracle Exadata storage cell</b>
U6		U6	U6		U6
U5	<b>Oracle Exadata storage cell</b>	U5	U5	<b>Oracle Exadata storage cell</b>	U5
U4		U4	U4		U4
U3	<b>Oracle Exadata storage cell</b>	U3	U3	<b>Oracle Exadata storage cell</b>	U3
U2		U2	U2		U2
U1	1U Solid Filler	U1	U1		U1

 \* Ports oriented to the rear

The next diagram shows the front and rear views of Oracle Exadata Database Machine X3-8 Full Rack.

**Figure 16-4 Rack Layout of Oracle Exadata Database Machine X3-8 Full Rack**

Front View			Rear View		
U42	Oracle Exadata storage cell	U42	U42	Oracle Exadata storage cell	U42
U41		U41	U41		U41
U40	Oracle Exadata storage cell	U40	U40	Oracle Exadata storage cell	U40
U39		U39	U39		U39
U38	Oracle Exadata storage cell	U38	U38	Oracle Exadata storage cell	U38
U37		U37	U37		U37
U36	Oracle Exadata storage cell	U36	U36	Oracle Exadata storage cell	U36
U35		U35	U35		U35
U34	Oracle Exadata storage cell	U34	U34	Oracle Exadata storage cell	U34
U33		U33	U33		U33
U32	Oracle Exadata storage cell	U32	U32	Oracle Exadata storage cell	U32
U31		U31	U31		U31
U30	Oracle Exadata storage cell	U30	U30	Oracle Exadata storage cell	U30
U29		U29	U29		U29
U28	Oracle Database Server	U28	U28	Oracle Database Server	U28
U27		U27	U27		U27
U26		U26	U26		U26
U25		U25	U25		U25
U24		U24	U24		U24
U23		1U Vented Filler	U23		U23
U22	1U Vented Filler	U22	U22	Cisco 4948	U22
U21	1U Vented Filler	U21	U21	36-port IB switch	U21
U20	Oracle Database Server	U20	U20	Oracle Database Server	U20
U19		U19	U19		U19
U18		U18	U18		U18
U17		U17	U17		U17
U16		U16	U16		U16
U15	Oracle Exadata storage cell	U15	U15	Oracle Exadata storage cell	U15
U14		U14	U14		U14
U13	Oracle Exadata storage cell	U13	U13	Oracle Exadata storage cell	U13
U12		U12	U12		U12
U11	Oracle Exadata storage cell	U11	U11	Oracle Exadata storage cell	U11
U10		U10	U10		U10
U9	Oracle Exadata storage cell	U9	U9	Oracle Exadata storage cell	U9
U8		U8	U8		U8
U7	Oracle Exadata storage cell	U7	U7	Oracle Exadata storage cell	U7
U6		U6	U6		U6
U5	Oracle Exadata storage cell	U5	U5	Oracle Exadata storage cell	U5
U4		U4	U4		U4
U3	Oracle Exadata storage cell	U3	U3	Oracle Exadata storage cell	U3
U2		U2	U2		U2
U1	1U Vented Filler	U1	U1		U1

 \* Ports oriented to the rear

 **Note:**

Oracle Exadata Database Machine X3-8 Full Racks with Exadata Storage Server X3-2 Servers include a Sun Datacenter InfiniBand Switch 36 switch in rack unit 1.

## 16.2 Sun Integrated Lights Out Manager Cabling Tables

This section contains the tables for the Sun Integrated Lights Out Manager (ILOM) network cabling. The ILOM port on the servers is labeled NET MGT, and connects to the Gigabit Ethernet port located in rack unit 21 on Oracle Exadata Database Machine X2-2 racks. The

ILOM port connects to the Gigabit Ethernet port located in rack unit 22 on Oracle Exadata Database Machine X2-8 Full Rack racks.

The following tables are in this section:

- [Table 16-1](#)
- [Table 16-2](#)
- [Table 16-3](#)
- [Table 16-4](#)

[Table 16-1](#) shows the cable connections from the servers to the ILOM switch in Oracle Exadata Database Machine X3-2 Full Rack:

**Table 16-1 ILOM Cabling for Oracle Exadata Database Machine X3-2 Full Rack**

From Rack Unit	Type of Equipment	Gigabit Ethernet Port
U39	Exadata Storage Server	2
U37	Exadata Storage Server	4
U35	Exadata Storage Server	6
U33	Exadata Storage Server	8
U31	Exadata Storage Server	10
U29	Exadata Storage Server	12
U27	Exadata Storage Server	14
U26	Database server	16
U25	Database server	18
U24	Database server	20
U23	Database server	22
U19	Database server	24
U18	Database server	26
U17	Database server	28
U16	Database server	30
U14	Exadata Storage Server	32
U12	Exadata Storage Server	34
U10	Exadata Storage Server	36
U8	Exadata Storage Server	38
U6	Exadata Storage Server	40
U4	Exadata Storage Server	42
U2	Exadata Storage Server	44

[Table 16-2](#) shows the cable connections from the servers to the ILOM switch in Oracle Exadata Database Machine X3-2 Half Rack:

**Table 16-2 ILOM Cabling for Oracle Exadata Database Machine X3-2 Half Rack**

From Rack Unit	Type of Equipment	Gigabit Ethernet Port
U19	Database server	24
U18	Database server	26
U17	Database server	28
U16	Database server	30
U14	Exadata Storage Server	32
U12	Exadata Storage Server	34
U10	Exadata Storage Server	36
U8	Exadata Storage Server	38
U6	Exadata Storage Server	40
U4	Exadata Storage Server	42
U2	Exadata Storage Server	44

Table 16-3 shows the cable connections from the servers to the ILOM switch in Oracle Exadata Database Machine X3-2 Quarter Rack:

**Table 16-3 ILOM Cabling for Oracle Exadata Database Machine X3-2 Quarter Rack**

From Rack Unit	Type of Equipment	Gigabit Ethernet Port
U17	Database server	28
U16	Database server	30
U6	Exadata Storage Server	40
U4	Exadata Storage Server	42
U2	Exadata Storage Server	44

Table 16-4 shows the cable connections from the servers to the ILOM switch in Oracle Exadata Database Machine X3-8 Full Rack:

**Table 16-4 ILOM Cabling for Oracle Exadata Database Machine X3-8 Full Rack**

From Rack Unit	Type of Equipment	Gigabit Ethernet Port
U41	Exadata Storage Server	2
U39	Exadata Storage Server	4
U37	Exadata Storage Server	6
U35	Exadata Storage Server	8
U33	Exadata Storage Server	10
U31	Exadata Storage Server	12
U29	Exadata Storage Server	14
U24	Database server	16
U16	Database server	18

**Table 16-4 (Cont.) ILOM Cabling for Oracle Exadata Database Machine X3-8 Full Rack**

From Rack Unit	Type of Equipment	Gigabit Ethernet Port
U14	Exadata Storage Server	20
U12	Exadata Storage Server	22
U10	Exadata Storage Server	24
U8	Exadata Storage Server	26
U6	Exadata Storage Server	28
U4	Exadata Storage Server	30
U2	Exadata Storage Server	32

## 16.3 Administrative Gigabit Ethernet Port Cabling Tables

This section contains the tables for the administrative Gigabit Ethernet network cabling. The Gigabit Ethernet switch is located in rack unit 21 on Oracle Exadata Database Machine X3-2 racks. The Gigabit Ethernet switch is located in rack unit 22 on Oracle Exadata Database Machine X3-8 Full Rack racks.

The following tables are in this section:

- [Table 16-5](#)
- [Table 16-6](#)
- [Table 16-7](#)
- [Table 16-8](#)

[Table 16-5](#) shows the cable connections from the servers to the Gigabit Ethernet switch in Oracle Exadata Database Machine X3-2 Full Rack:

**Table 16-5 Gigabit Ethernet Cabling for Oracle Exadata Database Machine X3-2 Full Rack**

From Rack Unit	Type of Equipment	Gigabit Ethernet Port
U39	Exadata Storage Server	1
U37	Exadata Storage Server	3
U35	Exadata Storage Server	5
U33	Exadata Storage Server	7
U31	Exadata Storage Server	9
U29	Exadata Storage Server	11
U27	Exadata Storage Server	13
U26	Database server	15
U25	Database server	17
U24	Database server	19
U23	Database server	21



**Table 16-5 (Cont.) Gigabit Ethernet Cabling for Oracle Exadata Database Machine X3-2 Full Rack**

From Rack Unit	Type of Equipment	Gigabit Ethernet Port
U22	Sun Datacenter InfiniBand Switch 36 switch	45
U20	Sun Datacenter InfiniBand Switch 36 switch	46
U19	Database server	23
U18	Database server	25
U17	Database server	27
U16	Database server	29
U14	Exadata Storage Server	31
U12	Exadata Storage Server	33
U10	Exadata Storage Server	35
U8	Exadata Storage Server	37
U6	Exadata Storage Server	39
U4	Exadata Storage Server	41
U2	Exadata Storage Server	43
U1	Sun Datacenter InfiniBand Switch 36 switch	47

Table 16-6 shows the cable connections from the servers to the Gigabit Ethernet switch in Oracle Exadata Database Machine X3-2 Half Rack:

**Table 16-6 Gigabit Ethernet Cabling for Oracle Exadata Database Machine X3-2 Half Rack**

From Rack Unit	Type of Equipment	Gigabit Ethernet Port
U22	Sun Datacenter InfiniBand Switch 36 switch	45
U20	Sun Datacenter InfiniBand Switch 36 switch	46
U19	Database server	23
U18	Database server	25
U17	Database server	27
U16	Database server	29
U14	Exadata Storage Server	31
U12	Exadata Storage Server	33
U10	Exadata Storage Server	35
U8	Exadata Storage Server	37
U6	Exadata Storage Server	39
U4	Exadata Storage Server	41

**Table 16-6 (Cont.) Gigabit Ethernet Cabling for Oracle Exadata Database Machine X3-2 Half Rack**

From Rack Unit	Type of Equipment	Gigabit Ethernet Port
U2	Exadata Storage Server	43
U1	Sun Datacenter InfiniBand Switch 36 switch	47

Table 16-7 shows the cable connections from the servers to the Gigabit Ethernet switch in Oracle Exadata Database Machine X3-2 Quarter Rack:

**Table 16-7 Gigabit Ethernet Cabling for Oracle Exadata Database Machine X3-2 Quarter Rack**

From Rack Unit	Type of Equipment	Gigabit Ethernet Port
U22	Sun Datacenter InfiniBand Switch 36 switch	45
U20	Sun Datacenter InfiniBand Switch 36 switch	46
U17	Database server	27
U16	Database server	29
U6	Exadata Storage Server	39
U4	Exadata Storage Server	41
U2	Exadata Storage Server	43

Table 16-8 shows the cable connections from the servers to the Gigabit Ethernet switch in Oracle Exadata Database Machine X3-8 Full Rack:

**Table 16-8 Gigabit Ethernet Cabling for Oracle Exadata Database Machine X3-8 Full Rack**

From Rack Unit	Type of Equipment	Gigabit Ethernet Port
U41	Exadata Storage Server	1
U39	Exadata Storage Server	3
U37	Exadata Storage Server	5
U35	Exadata Storage Server	7
U33	Exadata Storage Server	9
U31	Exadata Storage Server	11
U29	Exadata Storage Server	13
U24	Database server	15
U23	Sun Datacenter InfiniBand Switch 36	33
U21	Sun Datacenter InfiniBand Switch 36	34
U16	Database server	17

**Table 16-8 (Cont.) Gigabit Ethernet Cabling for Oracle Exadata Database Machine X3-8 Full Rack**

From Rack Unit	Type of Equipment	Gigabit Ethernet Port
U14	Exadata Storage Server	19
U12	Exadata Storage Server	21
U10	Exadata Storage Server	23
U8	Exadata Storage Server	25
U6	Exadata Storage Server	27
U4	Exadata Storage Server	29
U2	Exadata Storage Server	31

 **Note:**

Oracle Exadata Database Machine X3-8 Full Racks with Exadata Storage Server X3-2 Servers include a Sun Datacenter InfiniBand Switch 36 switch in rack unit 1, and use port 35 for the Gigabit Ethernet port.

## 16.4 Single Phase Power Distribution Unit Cabling Tables

This section contains the tables for single phase cabling from each power distribution unit (PDU) to the power supplies configured in each rack. The cables are terminated to PDU-A on the left, and routed to the right to enter CMA, and are bundled in groups of four.

The following tables are in this section:

- [Table 16-9](#)
- [Table 16-10](#)
- [Table 16-11](#)
- [Table 16-12](#)

[Table 16-9](#) shows the cable connections from the PDUs to the rack units in Oracle Exadata Database Machine X3-2 Full Rack.

**Table 16-9 Single Phase PDU Cabling for Oracle Exadata Database Machine X3-2 Full Rack**

Rack Unit	PDU-A/PS-00	PDU-B/PS-01	Cable Length
U39	G5-6	G0-0	2 meters
U37	G5-3	G0-3	2 meters
U35	G5-0	G0-6	2 meters
U33	G4-6	G1-0	2 meters
U31	G4-4	G1-2	2 meters
U29	G4-2	G1-4	2 meters

**Table 16-9 (Cont.) Single Phase PDU Cabling for Oracle Exadata Database Machine X3-2 Full Rack**

Rack Unit	PDU-A/PS-00	PDU-B/PS-01	Cable Length
U27	G3-6	G2-0	2 meters
U26	G4-0	G1-6	2 meters
U25	G3-5	G2-1	2 meters
U24	G3-4	G2-2	2 meters
U23	G3-3	G2-3	2 meters
U22	G3-1	G2-5	2 meters
U21	G3-0	G2-6	2 meters
U20	G2-4	G3-2	2 meters
U19	G2-3	G3-3	2 meters
U18	G2-2	G3-4	2 meters
U17	G2-1	G3-5	2 meters
U16	G1-6	G4-0	2 meters
U14	G2-0	G3-6	2 meters
U12	G1-4	G4-2	2 meters
U10	G1-2	G4-4	2 meters
U8	G1-0	G4-6	2 meters
U6	G0-6	G5-0	2 meters
U4	G0-4	G5-2	2 meters
U2	G0-2	G5-4	2 meters
U1	G0-0	G5-6	2 meters

Table 16-10 shows the cable connections from the PDUs to the rack units in Oracle Exadata Database Machine X3-2 Half Rack.

**Table 16-10 Single Phase PDU Cabling for Oracle Exadata Database Machine X3-2 Half Rack**

Rack Unit	PDU-A/PS-00	PDU-B/PS-01	Cable Length
U22	G3-1	G2-5	2 meters
U21	G3-0	G2-6	2 meters
U20	G2-4	G3-2	2 meters
U19	G2-3	G3-3	2 meters
U18	G2-2	G3-4	2 meters
U17	G2-1	G3-5	2 meters
U16	G1-6	G4-0	2 meters
U14	G2-0	G3-6	2 meters
U12	G1-4	G4-2	2 meters
U10	G1-2	G4-4	2 meters

**Table 16-10 (Cont.) Single Phase PDU Cabling for Oracle Exadata Database Machine X3-2 Half Rack**

Rack Unit	PDU-A/PS-00	PDU-B/PS-01	Cable Length
U8	G1-0	G4-6	2 meters
U6	G0-6	G5-0	2 meters
U4	G0-4	G5-2	2 meters
U2	G0-2	G5-4	2 meters
U1	G0-0	G5-6	2 meters

Table 16-11 shows the cable connections from the PDUs to the rack units in Oracle Exadata Database Machine X3-2 Quarter Rack.

**Table 16-11 Single Phase PDU Cabling for Oracle Exadata Database Machine X3-2 Quarter Rack**

Rack Unit	PDU-A/PS-00	PDU-B/PS-01	Cable Length
U22	G3-1	G2-5	2 meters
U21	G3-0	G2-6	2 meters
U20	G2-4	G3-2	2 meters
U17	G2-1	G3-5	2 meters
U16	G1-6	G4-0	2 meters
U6	G0-6	G5-0	2 meters
U4	G0-4	G5-2	2 meters
U2	G0-2	G5-4	2 meters
U1	G0-0	G5-6	2 meters

Table 16-12 shows the cable connections from the PDUs to the rack units in Oracle Exadata Database Machine X3-8 Full Rack.

**Table 16-12 Single Phase PDU Cabling for Oracle Exadata Database Machine X3-8 Full Rack**

Rack Unit	PDU-A/PS-00	PDU-B/PS-01	Cable Length
U41	G5-6	G0-0	2 meters
U39	G5-4	G0-2	2 meters
U37	G5-2	G0-4	2 meters
U35	G5-0	G0-6	2 meters
U33	G4-6	G1-0	2 meters
U31	G4-3	G1-3	2 meters
U29	G3-6	G2-0	2 meters
U24	G4-0	G1-6	1 meter
U24	G2-1	G3-5	1 meter

**Table 16-12 (Cont.) Single Phase PDU Cabling for Oracle Exadata Database Machine X3-8 Full Rack**

Rack Unit	PDU-A/PS-00	PDU-B/PS-01	Cable Length
U23	G3-1	G2-5	2 meters
U22	G2-6	G3-0	2 meters
U21	G3-0	G2-6	2 meters
U16	G3-5	G2-1	1 meter
U16	G1-6	G4-0	1 meter
U14	G2-0	G3-6	2 meters
U12	G1-3	G4-3	2 meters
U10	G1-0	G4-6	2 meters
U8	G0-6	G5-0	2 meters
U6	G0-4	G5-2	2 meters
U4	G0-3	G5-3	2 meters
U2	G0-1	G5-5	2 meters
U1	G0-0	G5-6	2 meters

## 16.5 Three Phase Power Distribution Unit Cabling Tables

This section contains the tables for three phase cabling from each power distribution unit (PDU) to the power supplies configured in each rack. The cables are terminated to PDU-A on the left, and routed to the right to enter CMA, and are bundled in groups of four.

The following tables are in this section:

- [Table 16-13](#)
- [Table 16-14](#)
- [Table 16-15](#)
- [Table 16-16](#)

[Table 16-13](#) shows the cable connections from the PDUs to the rack units in Oracle Exadata Database Machine X3-2 Full Rack.

**Table 16-13 Three Phase PDU Cabling for Oracle Exadata Database Machine X3-2 Full Rack**

Rack Unit	PDU-A/PS-00	PDU-B/PS-01	Cable Length
U39	G5-6	G2-0	2 meters
U37	G5-3	G2-3	2 meters
U35	G5-0	G2-6	2 meters
U33	G4-6	G1-0	2 meters
U31	G4-4	G1-2	2 meters

**Table 16-13 (Cont.) Three Phase PDU Cabling for Oracle Exadata Database Machine X3-2 Full Rack**

Rack Unit	PDU-A/PS-00	PDU-B/PS-01	Cable Length
U29	G4-2	G1-4	2 meters
U27	G3-6	G0-0	2 meters
U26	G4-0	G1-6	2 meters
U25	G3-5	G0-1	2 meters
U24	G3-4	G0-2	2 meters
U23	G3-3	G0-3	2 meters
U22	G3-1	G0-5	2 meter
U21	G3-0	G0-6	2 meters
U20	G2-4	G5-2	2 meters
U19	G2-3	G5-3	2 meters
U18	G2-2	G5-4	2 meters
U17	G2-1	G5-5	2 meters
U16	G1-6	G4-0	2 meters
U14	G2-0	G5-6	2 meters
U12	G1-4	G4-2	2 meters
U10	G1-2	G4-4	2 meters
U8	G1-0	G4-6	2 meters
U6	G0-6	G3-0	2 meters
U4	G0-4	G3-2	2 meters
U2	G0-2	G3-4	2 meters
U1	G0-0	G3-6	2 meters

[Table 16-14](#) shows the cable connections from the PDUs to the rack units in Oracle Exadata Database Machine X3-2 Half Rack.

**Table 16-14 Three Phase PDU Cabling for Oracle Exadata Database Machine X3-2 Half Rack**

Rack Unit	PDU-A/PS-00	PDU-B/PS-01	Cable Length
U22	G3-1	G0-5	2 meter
U21	G3-0	G0-6	2 meters
U20	G2-4	G5-2	2 meters
U19	G2-3	G5-3	2 meters
U18	G2-2	G5-4	2 meters
U17	G2-1	G5-5	2 meters
U16	G1-6	G4-0	2 meters
U14	G2-0	G5-6	2 meters
U12	G1-4	G4-2	2 meters

**Table 16-14 (Cont.) Three Phase PDU Cabling for Oracle Exadata Database Machine X3-2 Half Rack**

Rack Unit	PDU-A/PS-00	PDU-B/PS-01	Cable Length
U10	G1-2	G4-4	2 meters
U8	G1-0	G4-6	2 meters
U6	G0-6	G3-0	2 meters
U4	G0-4	G3-2	2 meters
U2	G0-2	G3-4	2 meters
U1	G0-0	G3-6	2 meters

Table 16-15 shows the cable connections from the PDUs to the rack units in Oracle Exadata Database Machine X3-2 Quarter Rack.

**Table 16-15 Three Phase PDU Cabling for Oracle Exadata Database Machine X3-2 Quarter Rack**

Rack Unit	PDU-A/PS-00	PDU-B/PS-01	Cable Length
U22	G3-1	G0-5	2 meter
U21	G3-0	G0-6	2 meters
U20	G2-4	G5-2	2 meters
U17	G2-1	G5-5	2 meters
U16	G1-6	G4-0	2 meters
U6	G0-6	G3-0	2 meters
U4	G0-4	G3-2	2 meters
U2	G0-2	G3-4	2 meters
U1	G0-0	G3-6	2 meters

Table 16-16 shows the cable connections from the PDUs to the rack units in Oracle Exadata Database Machine X3-8 Full Rack.

**Table 16-16 Three Phase PDU Cabling for Oracle Exadata Database Machine X3-8 Full Rack**

Rack Unit	PDU-A/PS-00	PDU-B/PS-01	Cable Length
U41	G5-5	G2-1	2 meters
U39	G5-4	G2-2	2 meters
U37	G5-2	G2-4	2 meters
U35	G5-1	G2-5	2 meters
U33	G5-0	G2-6	2 meters
U31	G4-6	G1-0	2 meters
U29	G4-4	G1-2	2 meters
U24	G4-1	G1-5	1 meter



**Table 16-16 (Cont.) Three Phase PDU Cabling for Oracle Exadata Database Machine X3-8 Full Rack**

Rack Unit	PDU-A/PS-00	PDU-B/PS-01	Cable Length
U24	G3-6	G0-0	1 meter
U23	G3-3	G0-3	2 meters
U22	G3-0	G0-6	2 meters
U21	G2-5	G5-1	2 meters
U16	G2-1	G5-5	2 meter
U16	G1-6	G4-0	1 meter
U14	G1-3	G4-3	2 meters
U12	G1-0	G4-6	2 meters
U10	G0-6	G3-0	2 meters
U8	G0-5	G3-1	2 meters
U6	G0-4	G3-2	2 meters
U4	G0-2	G3-4	2 meters
U2	G0-1	G3-5	2 meters
U1	G0-0	G3-6	2 meters

## 16.6 InfiniBand Network Cabling Tables

This section contains the tables for the InfiniBand network cabling. The Sun Datacenter InfiniBand Switch 36 switches are located in located in rack unit 1, 20 and 22.

The following tables are in this section:

- [Table 16-17](#)
- [Table 16-18](#)
- [Table 16-19](#)
- [Table 16-20](#)
- [Table 16-21](#)

[Table 16-17](#) lists the location, ports and cables for the InfiniBand connections for Oracle Exadata Database Machine X3-2 Full Rack.

**Table 16-17 InfiniBand Network Cabling for Oracle Exadata Database Machine X3-2 Full Rack**

From InfiniBand Switch Rack Unit	Port	To Rack Unit	Type of Equipment	Port	Cable Description
U22	0A	U39	Exadata Storage Server	PCIe 3, P1	3 meter QDR InfiniBand cable

**Table 16-17 (Cont.) InfiniBand Network Cabling for Oracle Exadata Database Machine X3-2 Full Rack**

From InfiniBand Switch Rack Unit	Port	To Rack Unit	Type of Equipment	Port	Cable Description
U22	0B	U37	Exadata Storage Server	PCIe 3, P1	3 meter QDR InfiniBand cable
U22	1A	U35	Exadata Storage Server	PCIe 3, P1	3 meter QDR InfiniBand cable
U22	1B	U33	Exadata Storage Server	PCIe 3, P1	3 meter QDR InfiniBand cable
U22	2A	U31	Exadata Storage Server	PCIe 3, P1	3 meter QDR InfiniBand cable
U22	2B	U29	Exadata Storage Server	PCIe 3, P1	3 meter QDR InfiniBand cable
U22	3A	U27	Exadata Storage Server	PCIe 3, P1	3 meter QDR InfiniBand cable
U22	3B	U26	Database server	PCIe 3, P1	2 meter QDR InfiniBand cable
U22	4A	U25	Database server	PCIe 3, P1	2 meter QDR InfiniBand cable
U22	4B	U24	Database server	PCIe 3, P1	2 meter QDR InfiniBand cable
U22	5A	U23	Database server	PCIe 3, P1	2 meter QDR InfiniBand cable
U22	12B	U19	Database server	PCIe 3, P2	2 meter QDR InfiniBand cable
U22	13A	U18	Database server	PCIe 3, P2	2 meter QDR InfiniBand cable
U22	13B	U17	Database server	PCIe 3, P2	2 meter QDR InfiniBand cable
U22	14A	U16	Database server	PCIe 3, P2	2 meter QDR InfiniBand cable

**Table 16-17 (Cont.) InfiniBand Network Cabling for Oracle Exadata Database Machine X3-2 Full Rack**

From InfiniBand Switch Rack Unit	Port	To Rack Unit	Type of Equipment	Port	Cable Description
U22	14B	U14	Exadata Storage Server	PCIe 3, P2	3 meter QDR InfiniBand cable
U22	15A	U12	Exadata Storage Server	PCIe 3, P2	3 meter QDR InfiniBand cable
U22	15B	U10	Exadata Storage Server	PCIe 3, P2	3 meter QDR InfiniBand cable
U22	16A	U8	Exadata Storage Server	PCIe 3, P2	3 meter QDR InfiniBand cable
U22	16B	U6	Exadata Storage Server	PCIe 3, P2	3 meter QDR InfiniBand cable
U22	17A	U4	Exadata Storage Server	PCIe 3, P2	3 meter QDR InfiniBand cable
U22	17B	U2	Exadata Storage Server	PCIe 3, P2	3 meter QDR InfiniBand cable
U20	0A	U39	Exadata Storage Server	PCIe 3, P2	3 meter QDR InfiniBand cable
U20	0B	U37	Exadata Storage Server	PCIe 3, P2	3 meter QDR InfiniBand cable
U20	1A	U35	Exadata Storage Server	PCIe 3, P2	3 meter QDR InfiniBand cable
U20	1B	U33	Exadata Storage Server	PCIe 3, P2	3 meter QDR InfiniBand cable
U20	2A	U31	Exadata Storage Server	PCIe 3, P2	3 meter QDR InfiniBand cable
U20	2B	U29	Exadata Storage Server	PCIe 3, P2	3 meter QDR InfiniBand cable
U20	3A	U27	Exadata Storage Server	PCIe 3, P2	3 meter QDR InfiniBand cable

**Table 16-17 (Cont.) InfiniBand Network Cabling for Oracle Exadata Database Machine X3-2 Full Rack**

From InfiniBand Switch Rack Unit	Port	To Rack Unit	Type of Equipment	Port	Cable Description
U20	3B	U26	Database server	PCIe 3, P2	2 meter QDR InfiniBand cable
U20	4A	U25	Database server	PCIe 3, P2	2 meter QDR InfiniBand cable
U20	4B	U24	Database server	PCIe 3, P2	2 meter QDR InfiniBand cable
U20	5A	U23	Database server	PCIe 3, P2	2 meter QDR InfiniBand cable
U20	12B	U19	Database Server	PCIe 3, P1	2 meter QDR InfiniBand cable
U20	13A	U18	Database server	PCIe 3, P1	2 meter QDR InfiniBand cable
U20	13B	U17	Database server	PCIe 3, P1	2 meter QDR InfiniBand cable
U20	14A	U16	Database server	PCIe 3, P1	2 meter QDR InfiniBand cable
U20	14B	U14	Exadata Storage Server	PCIe 3, P1	2 meter QDR InfiniBand cable
U20	15A	U12	Exadata Storage Server	PCIe 3, P1	3 meter QDR InfiniBand cable
U20	15B	U10	Exadata Storage Server	PCIe 3, P1	3 meter QDR InfiniBand cable
U20	16A	U8	Exadata Storage Server	PCIe 3, P1	3 meter QDR InfiniBand cable
U20	16B	U6	Exadata Storage Server	PCIe 3, P1	3 meter QDR InfiniBand cable
U20	17A	U4	Exadata Storage Server	PCIe 3, P1	3 meter QDR InfiniBand cable

**Table 16-17 (Cont.) InfiniBand Network Cabling for Oracle Exadata Database Machine X3-2 Full Rack**

From InfiniBand Switch Rack Unit	Port	To Rack Unit	Type of Equipment	Port	Cable Description
U20	17B	U2	Exadata Storage Server	PCIe 3, P1	3 meter QDR InfiniBand cable
U22	8B	U1	Sun Datacenter InfiniBand Switch 36 switch	0B	3 meter QDR InfiniBand cable
U20	8B	U1	Sun Datacenter InfiniBand Switch 36 switch	1B	3 meter QDR InfiniBand cable
U20	9B	U22	Sun Datacenter InfiniBand Switch 36 switch	9A	1 meter QDR InfiniBand cable
U20	10B	U22	Sun Datacenter InfiniBand Switch 36 switch	10A	1 meter QDR InfiniBand cable
U20	11B	U22	Sun Datacenter InfiniBand Switch 36 switch	11A	1 meter QDR InfiniBand cable
U20	8A	U22	Sun Datacenter InfiniBand Switch 36 switch	8A	1 meter QDR InfiniBand cable
U20	9A	U22	Sun Datacenter InfiniBand Switch 36 switch	9B	1 meter QDR InfiniBand cable
U20	10A	U22	Sun Datacenter InfiniBand Switch 36 switch	10B	1 meter QDR InfiniBand cable
U20	11A	U22	Sun Datacenter InfiniBand Switch 36 switch	11B	1 meter QDR InfiniBand cable
U1	1B	U20	Sun Datacenter InfiniBand Switch 36 switch	8B	3 meter QDR InfiniBand cable

**Table 16-17 (Cont.) InfiniBand Network Cabling for Oracle Exadata Database Machine X3-2 Full Rack**

From InfiniBand Switch Rack Unit	Port	To Rack Unit	Type of Equipment	Port	Cable Description
U1	0B	U22	Sun Datacenter InfiniBand Switch 36 switch	8B	3 meter QDR InfiniBand cable

Table 16-18 lists the location, ports and cables for the InfiniBand connections for Oracle Exadata Database Machine X3-2 Half Rack.



**Note:**

The Sun Datacenter InfiniBand Switch 36 switch in rack position U1 is included in Oracle Exadata Database Machine X3-2 Half Racks.

**Table 16-18 InfiniBand Network Cabling for Oracle Exadata Database Machine X3-2 Half Rack**

From InfiniBand Switch Rack Unit	Port	To Rack Unit	Type of Equipment	Port	Cable Description
U22	12B	U19	Database server	PCIe 3, P2	2 meter QDR InfiniBand cable
U22	13A	U18	Database server	PCIe 3, P2	2 meter QDR InfiniBand cable
U22	13B	U17	Database server	PCIe 3, P2	2 meter QDR InfiniBand cable
U22	14A	U16	Database server	PCIe 3, P2	2 meter QDR InfiniBand cable
U22	14B	U14	Exadata Storage Server	PCIe 3, P2	3 meter QDR InfiniBand cable
U22	15A	U12	Exadata Storage Server	PCIe 3, P2	3 meter QDR InfiniBand cable
U22	15B	U10	Exadata Storage Server	PCIe 3, P2	3 meter QDR InfiniBand cable

**Table 16-18 (Cont.) InfiniBand Network Cabling for Oracle Exadata Database Machine X3-2 Half Rack**

From InfiniBand Switch Rack Unit	Port	To Rack Unit	Type of Equipment	Port	Cable Description
U22	16A	U8	Exadata Storage Server	PCIe 3, P2	3 meter QDR InfiniBand cable
U22	16B	U6	Exadata Storage Server	PCIe 3, P2	3 meter QDR InfiniBand cable
U22	17A	U4	Exadata Storage Server	PCIe 3, P2	3 meter QDR InfiniBand cable
U22	17B	U2	Exadata Storage Server	PCIe 3, P2	3 meter QDR InfiniBand cable
U20	12B	U19	Database Server	PCIe 3, P1	2 meter QDR InfiniBand cable
U20	13A	U18	Database server	PCIe 3, P1	2 meter QDR InfiniBand cable
U20	13B	U17	Database server	PCIe 3, P1	2 meter QDR InfiniBand cable
U20	14A	U16	Database server	PCIe 3, P1	2 meter QDR InfiniBand cable
U20	14B	U14	Exadata Storage Server	PCIe 3, P1	2 meter QDR InfiniBand cable
U20	15A	U12	Exadata Storage Server	PCIe 3, P1	3 meter QDR InfiniBand cable
U20	15B	U10	Exadata Storage Server	PCIe 3, P1	3 meter QDR InfiniBand cable
U20	16A	U8	Exadata Storage Server	PCIe 3, P1	3 meter QDR InfiniBand cable
U20	16B	U6	Exadata Storage Server	PCIe 3, P1	3 meter QDR InfiniBand cable
U20	17A	U4	Exadata Storage Server	PCIe 3, P1	3 meter QDR InfiniBand cable

**Table 16-18 (Cont.) InfiniBand Network Cabling for Oracle Exadata Database Machine X3-2 Half Rack**

From InfiniBand Switch Rack Unit	Port	To Rack Unit	Type of Equipment	Port	Cable Description
U20	17B	U2	Exadata Storage Server	PCIe 3, P1	3 meter QDR InfiniBand cable
U20	9B	U22	Sun Datacenter InfiniBand Switch 36 switch	9A	1 meter QDR InfiniBand cable
U20	10B	U22	Sun Datacenter InfiniBand Switch 36 switch	10A	1 meter QDR InfiniBand cable
U20	11B	U22	Sun Datacenter InfiniBand Switch 36 switch	11A	1 meter QDR InfiniBand cable
U20	8A	U22	Sun Datacenter InfiniBand Switch 36 switch	8A	1 meter QDR InfiniBand cable
U20	9A	U22	Sun Datacenter InfiniBand Switch 36 switch	9B	1 meter QDR InfiniBand cable
U20	10A	U22	Sun Datacenter InfiniBand Switch 36 switch	10B	1 meter QDR InfiniBand cable
U20	11A	U22	Sun Datacenter InfiniBand Switch 36 switch	11B	1 meter QDR InfiniBand cable
U1	1B	U20	Sun Datacenter InfiniBand Switch 36 switch	8B	3 meter QDR InfiniBand cable



**Table 16-18 (Cont.) InfiniBand Network Cabling for Oracle Exadata Database Machine X3-2 Half Rack**

From InfiniBand Switch Rack Unit	Port	To Rack Unit	Type of Equipment	Port	Cable Description
U1	0B	U22	Sun Datacenter InfiniBand Switch 36 switch	8B	3 meter QDR InfiniBand cable

Table 16-19 lists the location, ports and cables for the InfiniBand connections for Oracle Exadata Database Machine X3-2 Quarter Rack and Oracle Exadata Database Machine X3-2 Eighth Rack.



**Note:**

The same rules and restrictions apply to Oracle Exadata Database Machine X3-2 Eighth Rack as for Oracle Exadata Database Machine X3-2 Quarter Rack.

**Table 16-19 InfiniBand Network Cabling for Oracle Exadata Database Machine X3-2 Quarter Rack and Oracle Exadata Database Machine X3-2 Eighth Rack**

From InfiniBand Switch Rack Unit	Port	To Rack Unit	Type of Equipment	Port	Cable Description
U22	13B	U17	Database server	PCIe 3, P2	2 meter QDR InfiniBand cable
U22	14A	U16	Database server	PCIe 3, P2	2 meter QDR InfiniBand cable
U22	16B	U6	Exadata Storage Server	PCIe 3, P2	3 meter QDR InfiniBand cable
U22	17A	U4	Exadata Storage Server	PCIe 3, P2	3 meter QDR InfiniBand cable
U22	17B	U2	Exadata Storage Server	PCIe 3, P2	3 meter QDR InfiniBand cable
U20	13B	U17	Database server	PCIe 3, P1	2 meter QDR InfiniBand cable

**Table 16-19 (Cont.) InfiniBand Network Cabling for Oracle Exadata Database Machine X3-2 Quarter Rack and Oracle Exadata Database Machine X3-2 Eighth Rack**

From InfiniBand Switch Rack Unit	Port	To Rack Unit	Type of Equipment	Port	Cable Description
U20	14A	U16	Database server	PCIe 3, P1	2 meter QDR InfiniBand cable
U20	16B	U6	Exadata Storage Server	PCIe 3, P1	3 meter QDR InfiniBand cable
U20	17A	U4	Exadata Storage Server	PCIe 3, P1	3 meter QDR InfiniBand cable
U20	17B	U2	Exadata Storage Server	PCIe 3, P1	3 meter QDR InfiniBand cable
U20	9B	U22	Sun Datacenter InfiniBand Switch 36 switch	9A	1 meter QDR InfiniBand cable
U20	10B	U22	Sun Datacenter InfiniBand Switch 36 switch	10A	1 meter QDR InfiniBand cable
U20	11B	U22	Sun Datacenter InfiniBand Switch 36 switch	11A	1 meter QDR InfiniBand cable
U20	8A	U22	Sun Datacenter InfiniBand Switch 36 switch	8A	1 meter QDR InfiniBand cable
U20	9A	U22	Sun Datacenter InfiniBand Switch 36 switch	9B	1 meter QDR InfiniBand cable
U20	10A	U22	Sun Datacenter InfiniBand Switch 36 switch	10B	1 meter QDR InfiniBand cable
U20	11A	U22	Sun Datacenter InfiniBand Switch 36 switch	11B	1 meter QDR InfiniBand cable

Table 16-20 lists the location, ports and cables for the InfiniBand connections for Oracle Exadata Database Machine X3-8 Full Rack with Exadata Storage Server X4-2L Servers.

**Table 16-20 InfiniBand Network Cabling for Oracle Exadata Database Machine X3-8 Full Rack with Exadata Storage Server X4-2L Servers**

From InfiniBand Switch Rack Unit	Port	To Rack Unit	Type of Equipment	Port	Cable Description
U23	0A	U41	Exadata Storage Server	PCIe 3, P1	3 meter QDR InfiniBand cable
U23	0B	U39	Exadata Storage Server	PCIe 3, P1	3 meter QDR InfiniBand cable
U23	1A	U37	Exadata Storage Server	PCIe 3, P1	3 meter QDR InfiniBand cable
U23	1B	U35	Exadata Storage Server	PCIe 3, P1	3 meter QDR InfiniBand cable
U23	2A	U33	Exadata Storage Server	PCIe 3, P1	3 meter QDR InfiniBand cable
U23	2B	U31	Exadata Storage Server	PCIe 3, P1	3 meter QDR InfiniBand cable
U23	3A	U29	Exadata Storage Server	PCIe 3, P1	3 meter QDR InfiniBand cable
U23	3B	U24	Database server	EM-3.0 P-O	2 meter QDR InfiniBand cable
U23	4A	U24	Database server	EM-2.0 P-O	2 meter QDR InfiniBand cable
U23	4B	U24	Database server	EM-1.0 P-O	2 meter QDR InfiniBand cable
U23	5A	U24	Database server	EM-0.0 P-O	2 meter QDR InfiniBand cable
U23	13A	U16	Database server	EM-2.0 P-1	2 meter QDR InfiniBand cable
U23	13B	U16	Database server	EM-1.0 P-1	2 meter QDR InfiniBand cable
U23	14A	U16	Database server	EM-0.0 P-1	2 meter QDR InfiniBand cable

**Table 16-20 (Cont.) InfiniBand Network Cabling for Oracle Exadata Database Machine X3-8 Full Rack with Exadata Storage Server X4-2L Servers**

From InfiniBand Switch Rack Unit	Port	To Rack Unit	Type of Equipment	Port	Cable Description
U23	12B	U16	Database server	EM-3.0 P-1	2 meter QDR InfiniBand cable
U23	14B	U14	Exadata Storage Server	PCIe 3, P2	3 meter QDR InfiniBand cable
U23	15A	U12	Exadata Storage Server	PCIe 3, P2	3 meter QDR InfiniBand cable
U23	15B	U10	Exadata Storage Server	PCIe 3, P2	3 meter QDR InfiniBand cable
U23	16A	U8	Exadata Storage Server	PCIe 3, P2	3 meter QDR InfiniBand cable
U23	16B	U6	Exadata Storage Server	PCIe 3, P2	3 meter QDR InfiniBand cable
U23	17A	U4	Exadata Storage Server	PCIe 3, P2	3 meter QDR InfiniBand cable
U23	17B	U2	Exadata Storage Server	PCIe 3, P2	3 meter QDR InfiniBand cable
U21	0A	U41	Exadata Storage Server	PCIe 3, P2	3 meter QDR InfiniBand cable
U21	0B	U39	Exadata Storage Server	PCIe 3, P2	3 meter QDR InfiniBand cable
U21	1A	U37	Exadata Storage Server	PCIe 3, P2	3 meter QDR InfiniBand cable
U21	1B	U35	Exadata Storage Server	PCIe 3, P2	3 meter QDR InfiniBand cable
U21	2A	U33	Exadata Storage Server	PCIe 3, P2	3 meter QDR InfiniBand cable
U21	2B	U31	Exadata Storage Server	PCIe 3, P2	3 meter QDR InfiniBand cable

**Table 16-20 (Cont.) InfiniBand Network Cabling for Oracle Exadata Database Machine X3-8 Full Rack with Exadata Storage Server X4-2L Servers**

From InfiniBand Switch Rack Unit	Port	To Rack Unit	Type of Equipment	Port	Cable Description
U21	3A	U29	Exadata Storage Server	PCIe 3, P2	3 meter QDR InfiniBand cable
U21	3B	U24	Database server	EM-3.0 P-1	2 meter QDR InfiniBand cable
U21	4A	U24	Database server	EM-2.0 P-1	2 meter QDR InfiniBand cable
U21	4B	U24	Database server	EM-1.0 P-1	2 meter QDR InfiniBand cable
U21	5A	U24	Database server	EM-0.0 P-1	2 meter QDR InfiniBand cable
U21	12B	U16	Database Server	EM-3.0 P-O	2 meter QDR InfiniBand cable
U21	13A	U16	Database server	EM-2.0 P-O	2 meter QDR InfiniBand cable
U21	13B	U16	Database server	EM-1.0 P-O	2 meter QDR InfiniBand cable
U21	14A	U16	Database server	EM-0.0 P-O	2 meter QDR InfiniBand cable
U21	14B	U14	Exadata Storage Server	PCIe 3, P1	2 meter QDR InfiniBand cable
U21	15A	U12	Exadata Storage Server	PCIe 3, P1	3 meter QDR InfiniBand cable
U21	15B	U10	Exadata Storage Server	PCIe 3, P1	3 meter QDR InfiniBand cable
U21	16A	U8	Exadata Storage Server	PCIe 3, P1	3 meter QDR InfiniBand cable
U21	16B	U6	Exadata Storage Server	PCIe 3, P1	3 meter QDR InfiniBand cable

**Table 16-20 (Cont.) InfiniBand Network Cabling for Oracle Exadata Database Machine X3-8 Full Rack with Exadata Storage Server X4-2L Servers**

From InfiniBand Switch Rack Unit	Port	To Rack Unit	Type of Equipment	Port	Cable Description
U21	17A	U4	Exadata Storage Server	PCIe 3, P1	3 meter QDR InfiniBand cable
U21	17B	U2	Exadata Storage Server	PCIe 3, P1	3 meter QDR InfiniBand cable
U21	9B	U23	Sun Datacenter InfiniBand Switch 36 switch	9A	1 meter QDR InfiniBand cable
U21	10B	U23	Sun Datacenter InfiniBand Switch 36 switch	10A	1 meter QDR InfiniBand cable
U21	11B	U23	Sun Datacenter InfiniBand Switch 36 switch	11A	1 meter QDR InfiniBand cable
U21	8A	U23	Sun Datacenter InfiniBand Switch 36 switch	8A	1 meter QDR InfiniBand cable
U21	9A	U23	Sun Datacenter InfiniBand Switch 36 switch	9B	1 meter QDR InfiniBand cable
U21	10A	U23	Sun Datacenter InfiniBand Switch 36 switch	10B	1 meter QDR InfiniBand cable
U21	11A	U23	Sun Datacenter InfiniBand Switch 36 switch	11B	1 meter QDR InfiniBand cable

[Table 16-21](#) lists the location, ports and cables for the InfiniBand connections for Oracle Exadata Database Machine X3-8 Full Rack with Exadata Storage Server X3-2 Servers.

**Table 16-21 InfiniBand Network Cabling for Oracle Exadata Database Machine X3-8 Full Rack with Exadata Storage Server X3-2 Servers**

From InfiniBand Switch Rack Unit	Port	To Rack Unit	Type of Equipment	Port	Cable Description
U23	0A	U41	Exadata Storage Server	PCIe 3, P1	3 meter QDR InfiniBand cable
U23	0B	U39	Exadata Storage Server	PCIe 3, P1	3 meter QDR InfiniBand cable
U23	1A	U37	Exadata Storage Server	PCIe 3, P1	3 meter QDR InfiniBand cable
U23	1B	U35	Exadata Storage Server	PCIe 3, P1	3 meter QDR InfiniBand cable
U23	2A	U33	Exadata Storage Server	PCIe 3, P1	3 meter QDR InfiniBand cable
U23	2B	U31	Exadata Storage Server	PCIe 3, P1	3 meter QDR InfiniBand cable
U23	3A	U29	Exadata Storage Server	PCIe 3, P1	3 meter QDR InfiniBand cable
U23	3B	U24	Database server	EM-3.0 P-O	2 meter QDR InfiniBand cable
U23	4A	U24	Database server	EM-2.0 P-O	2 meter QDR InfiniBand cable
U23	4B	U24	Database server	EM-1.0 P-O	2 meter QDR InfiniBand cable
U23	5A	U24	Database server	EM-0.0 P-O	2 meter QDR InfiniBand cable
U23	13A	U16	Database server	EM-2.0 P-1	2 meter QDR InfiniBand cable
U23	13B	U16	Database server	EM-1.0 P-1	2 meter QDR InfiniBand cable
U23	14A	U16	Database server	EM-0.0 P-1	2 meter QDR InfiniBand cable

**Table 16-21 (Cont.) InfiniBand Network Cabling for Oracle Exadata Database Machine X3-8 Full Rack with Exadata Storage Server X3-2 Servers**

From InfiniBand Switch Rack Unit	Port	To Rack Unit	Type of Equipment	Port	Cable Description
U23	12B	U16	Database server	EM-3.0 P-1	2 meter QDR InfiniBand cable
U23	14B	U14	Exadata Storage Server	PCIe 3, P2	3 meter QDR InfiniBand cable
U23	15A	U12	Exadata Storage Server	PCIe 3, P2	3 meter QDR InfiniBand cable
U23	15B	U10	Exadata Storage Server	PCIe 3, P2	3 meter QDR InfiniBand cable
U23	16A	U8	Exadata Storage Server	PCIe 3, P2	3 meter QDR InfiniBand cable
U23	16B	U6	Exadata Storage Server	PCIe 3, P2	3 meter QDR InfiniBand cable
U23	17A	U4	Exadata Storage Server	PCIe 3, P2	3 meter QDR InfiniBand cable
U23	17B	U2	Exadata Storage Server	PCIe 3, P2	3 meter QDR InfiniBand cable
U21	0A	U41	Exadata Storage Server	PCIe 3, P2	3 meter QDR InfiniBand cable
U21	0B	U39	Exadata Storage Server	PCIe 3, P2	3 meter QDR InfiniBand cable
U21	1A	U37	Exadata Storage Server	PCIe 3, P2	3 meter QDR InfiniBand cable
U21	1B	U35	Exadata Storage Server	PCIe 3, P2	3 meter QDR InfiniBand cable
U21	2A	U33	Exadata Storage Server	PCIe 3, P2	3 meter QDR InfiniBand cable
U21	2B	U31	Exadata Storage Server	PCIe 3, P2	3 meter QDR InfiniBand cable



**Table 16-21 (Cont.) InfiniBand Network Cabling for Oracle Exadata Database Machine X3-8 Full Rack with Exadata Storage Server X3-2 Servers**

From InfiniBand Switch Rack Unit	Port	To Rack Unit	Type of Equipment	Port	Cable Description
U21	3A	U29	Exadata Storage Server	PCIe 3, P2	3 meter QDR InfiniBand cable
U21	3B	U24	Database server	EM-3.0 P-1	2 meter QDR InfiniBand cable
U21	4A	U24	Database server	EM-2.0 P-1	2 meter QDR InfiniBand cable
U21	4B	U24	Database server	EM-1.0 P-1	2 meter QDR InfiniBand cable
U21	5A	U24	Database server	EM-0.0 P-1	2 meter QDR InfiniBand cable
U21	12B	U16	Database Server	EM-3.0 P-O	2 meter QDR InfiniBand cable
U21	13A	U16	Database server	EM-2.0 P-O	2 meter QDR InfiniBand cable
U21	13B	U16	Database server	EM-1.0 P-O	2 meter QDR InfiniBand cable
U21	14A	U16	Database server	EM-0.0 P-O	2 meter QDR InfiniBand cable
U21	14B	U14	Exadata Storage Server	PCIe 3, P1	2 meter QDR InfiniBand cable
U21	15A	U12	Exadata Storage Server	PCIe 3, P1	3 meter QDR InfiniBand cable
U21	15B	U10	Exadata Storage Server	PCIe 3, P1	3 meter QDR InfiniBand cable
U21	16A	U8	Exadata Storage Server	PCIe 3, P1	3 meter QDR InfiniBand cable
U21	16B	U6	Exadata Storage Server	PCIe 3, P1	3 meter QDR InfiniBand cable

**Table 16-21 (Cont.) InfiniBand Network Cabling for Oracle Exadata Database Machine X3-8 Full Rack with Exadata Storage Server X3-2 Servers**

From InfiniBand Switch Rack Unit	Port	To Rack Unit	Type of Equipment	Port	Cable Description
U21	17A	U4	Exadata Storage Server	PCIe 3, P1	3 meter QDR InfiniBand cable
U21	17B	U2	Exadata Storage Server	PCIe 3, P1	3 meter QDR InfiniBand cable
U23	8B	U1	Sun Datacenter InfiniBand Switch 36 switch	0B	3 meter QDR InfiniBand cable
U21	8B	U1	Sun Datacenter InfiniBand Switch 36 switch	1B	3 meter QDR InfiniBand cable
U21	9B	U23	Sun Datacenter InfiniBand Switch 36 switch	9A	1 meter QDR InfiniBand cable
U21	10B	U23	Sun Datacenter InfiniBand Switch 36 switch	10A	1 meter QDR InfiniBand cable
U21	11B	U23	Sun Datacenter InfiniBand Switch 36 switch	11A	1 meter QDR InfiniBand cable
U21	8A	U23	Sun Datacenter InfiniBand Switch 36 switch	8A	1 meter QDR InfiniBand cable
U21	9A	U23	Sun Datacenter InfiniBand Switch 36 switch	9B	1 meter QDR InfiniBand cable
U21	10A	U23	Sun Datacenter InfiniBand Switch 36 switch	10B	1 meter QDR InfiniBand cable
U21	11A	U23	Sun Datacenter InfiniBand Switch 36 switch	11B	1 meter QDR InfiniBand cable

**Table 16-21 (Cont.) InfiniBand Network Cabling for Oracle Exadata Database Machine X3-8 Full Rack with Exadata Storage Server X3-2 Servers**

From InfiniBand Switch Rack Unit	Port	To Rack Unit	Type of Equipment	Port	Cable Description
U1	1B	U21	Sun Datacenter InfiniBand Switch 36 switch	8B	3 meter QDR InfiniBand cable
U1	0B	U23	Sun Datacenter InfiniBand Switch 36 switch	8B	3 meter QDR InfiniBand cable

# 17

## Cabling Tables for Oracle Exadata Database Machine X2-2 and Oracle Exadata Database Machine X2-8 Full Rack

The tables in this chapter show the cable layouts for Oracle Exadata Database Machine X2-2 and Oracle Exadata Database Machine X2-8 Full Rack.

- [Rack Layout Diagrams](#)  
The diagrams in this topic show the rack layout for Oracle Exadata Database Machine X2-2 and Oracle Exadata Database Machine X2-8 Full Rack.
- [Keyboard, Video and Mouse Network Cabling Tables](#)
- [Sun Integrated Lights Out Manager Cabling Tables](#)
- [Administrative Gigabit Ethernet Port Cabling Tables](#)
- [Single Phase Power Distribution Unit Cabling Tables](#)
- [Three Phase Power Distribution Unit Cabling Tables](#)
- [InfiniBand Network Cabling Tables](#)

### 17.1 Rack Layout Diagrams

The diagrams in this topic show the rack layout for Oracle Exadata Database Machine X2-2 and Oracle Exadata Database Machine X2-8 Full Rack.



#### Note:

For ease of reading, the name "Oracle Exadata Rack" is used when information refers to both Oracle Exadata Database Machine and Oracle Exadata Storage Expansion Rack.

The following abbreviations are used in the tables:

Abbreviation	Description
$Rn$	Rack $n$ , where $n$ is the number of the rack, such as R1.
$Un$	Unit height in rack, where $n$ is the number, such as U20.
$Pn$	InfiniBand port $n$ , where $n$ is port number, such as P8A.

The cables used in Oracle Exadata Database Machine are color-coded as follows:

- Black: InfiniBand cables, or AC power jumper cables

- Red: Integrated Lights Out Manager (ILOM) cables
- Blue: Gigabit Ethernet cables
- Orange: KVM switch cables (not used in Oracle Exadata Database Machine X2-8 Full Rack)

The following table shows the front and rear views of Oracle Exadata Database Machine X2-2 Full Rack. The front is shown on the left, and the rear is shown on the right.

**Figure 17-1 Rack Layout of Oracle Exadata Database Machine X2-2 Full Rack**

Front View			Rear View		
U42	Oracle Exadata storage cell	U42	U42	Oracle Exadata storage cell	U42
U41		U41	U41		U41
U40	Oracle Exadata storage cell	U40	U40	Oracle Exadata storage cell	U40
U39		U39	U39		U39
U38	Oracle Exadata storage cell	U38	U38	Oracle Exadata storage cell	U38
U37		U37	U37		U37
U36	Oracle Exadata storage cell	U36	U36	Oracle Exadata storage cell	U36
U35		U35	U35		U35
U34	Oracle Exadata storage cell	U34	U34	Oracle Exadata storage cell	U34
U33		U33	U33		U33
U32	Oracle Exadata storage cell	U32	U32	Oracle Exadata storage cell	U32
U31		U31	U31		U31
U30	Oracle Exadata storage cell	U30	U30	Oracle Exadata storage cell	U30
U29		U29	U29		U29
U28	Oracle Database Server	U28	U28	Oracle Database Server	U28
U27	Oracle Database Server	U27	U27	Oracle Database Server	U27
U26	Oracle Database Server	U26	U26	Oracle Database Server	U26
U25	Oracle Database Server	U25	U25	Oracle Database Server	U25
U24	1U Vented Filler	U24	U24	36-Port IB Switch	U24
U23	KVM LCD	U23	U23	KVM LCD	U23
U22	1U Vented Filler	U22	U22	KVM Switch	U22
U21	1U Vented Filler	U21	U21	Cisco 4948	U21
U20	1U Vented Filler	U20	U20	36-Port IB Switch	U20
U19	Oracle Database Server	U19	U19	Oracle Database Server	U19
U18	Oracle Database Server	U18	U18	Oracle Database Server	U18
U17	Oracle Database Server	U17	U17	Oracle Database Server	U17
U16	Oracle Database Server	U16	U16	Oracle Database Server	U16
U15	Oracle Exadata storage cell	U15	U15	Oracle Exadata storage cell	U15
U14		U14	U14		U14
U13	Oracle Exadata storage cell	U13	U13	Oracle Exadata storage cell	U13
U12		U12	U12		U12
U11	Oracle Exadata storage cell	U11	U11	Oracle Exadata storage cell	U11
U10		U10	U10		U10
U9	Oracle Exadata storage cell	U9	U9	Oracle Exadata storage cell	U9
U8		U8	U8		U8
U7	Oracle Exadata storage cell	U7	U7	Oracle Exadata storage cell	U7
U6		U6	U6		U6
U5	Oracle Exadata storage cell	U5	U5	Oracle Exadata storage cell	U5
U4		U4	U4		U4
U3	Oracle Exadata storage cell	U3	U3	Oracle Exadata storage cell	U3
U2		U2	U2		U2
U1	1U Vented Filler	U1	U1	36-Port IB Switch	U1

 \* Ports oriented to the rear

The following table shows the front and rear views of Oracle Exadata Database Machine X2-2 Half Rack.

 **Note:**

The Sun Datacenter InfiniBand Switch 36 switch in rack position U1 is included in Oracle Exadata Database Machine X2-2 Half Racks with the Sun Fire X4170 M2 Oracle Database Servers.

**Figure 17-2 Rack Layout for Oracle Exadata Database Machine X2-2 Half Rack**

Front View			Rear View		
U42	4U Solid Filler	U42	U42		U42
U41		U41	U41		
U40		U40	U40		
U39		U39	U39		
U38	4U Solid Filler	U38	U38		U38
U37		U37	U37		
U36		U36	U36		
U35		U35	U35		
U34	2U Solid Filler	U34	U34		U34
U33		U33	U33		
U32	2U Solid Filler	U32	U32		U32
U31		U31	U31		
U30	2U Solid Filler	U30	U30		U30
U29		U29	U29		
U28	2U Solid Filler	U28	U28		U28
U27		U27	U27		
U26	1U Solid Filler	U26	U26		U26
U25	1U Solid Filler	U25	U25		U25
U24	1U Vented Filler	U24	U24	<b>36-Port IB Switch</b>	U24
U23	<b>KVM LCD</b>	U23	U23	<b>KVM LCD</b>	U23
U22	1U Vented Filler	U22	U22	<b>KVM Switch</b>	U22
U21	1U Vented Filler	U21	U21	<b>Cisco 4948</b>	U21
U20	1U Vented Filler	U20	U20	<b>36-Port IB Switch</b>	U20
U19	<b>Oracle Database Server</b>	U19	U19	<b>Oracle Database Server</b>	U19
U18	<b>Oracle Database Server</b>	U18	U18	<b>Oracle Database Server</b>	U18
U17	<b>Oracle Database Server</b>	U17	U17	<b>Oracle Database Server</b>	U17
U16	<b>Oracle Database Server</b>	U16	U16	<b>Oracle Database Server</b>	U16
U15	Oracle Exadata storage cell	U15	U15	Oracle Exadata storage cell	U15
U14		U14	U14		
U13	Oracle Exadata storage cell	U13	U13	Oracle Exadata storage cell	U13
U12		U12	U12		
U11	Oracle Exadata storage cell	U11	U11	Oracle Exadata storage cell	U11
U10		U10	U10		
U9	Oracle Exadata storage cell	U9	U9	Oracle Exadata storage cell	U9
U8		U8	U8		
U7	Oracle Exadata storage cell	U7	U7	Oracle Exadata storage cell	U7
U6		U6	U6		
U5	Oracle Exadata storage cell	U5	U5	Oracle Exadata storage cell	U5
U4		U4	U4		
U3	Oracle Exadata storage cell	U3	U3	Oracle Exadata storage cell	U3
U2		U2	U2		
U1	1U Vented Filler	U1	U1	<b>36-Port IB Switch</b>	U1

 \* Ports oriented to the rear

The following table shows the front and rear views of Oracle Exadata Database Machine X2-2 Quarter Rack.

**Figure 17-3 Rack Layout of Oracle Exadata Database Machine X2-2 Quarter Rack**

Front View			Rear View		
U42	4U Solid Filler	U42	U42		U42
U41		U41	U41		
U40		U40	U40		
U39		U39	U39		
U38	4U Solid Filler	U38	U38		U38
U37		U37	U37		
U36		U36	U36		
U35		U35	U35		
U34	2U Solid Filler	U34	U34		U34
U33		U33	U33		
U32	2U Solid Filler	U32	U32		U32
U31		U31	U31		
U30	2U Solid Filler	U30	U30		U30
U29		U29	U29		
U28	2U Solid Filler	U28	U28		U28
U27		U27	U27		
U26	1U Solid Filler	U26	U26		U26
U25	1U Solid Filler	U25	U25		U25
U24	1U Vented Filler	U24	U24		U24
U23	<b>KVM LCD</b>	U23	U23		U23
U22	1U Vented Filler	U22	U22		U22
U21	1U Vented Filler	U21	U21		U21
U20	1U Vented Filler	U20	U20		U20
U19	1U Solid Filler	U19	U19		U19
U18	1U Solid Filler	U18	U18		U18
U17	<b>Oracle Database Server</b>	U17	U17		U17
U16	<b>Oracle Database Server</b>	U16	U16		U16
U15	2U Solid Filler	U15	U15		U15
U14		U14	U14		
U13		U13	U13		
U12	2U Solid Filler	U12	U12		U12
U11		U11	U11		
U10		U10	U10		
U9	4U Solid Filler	U9	U9		U9
U8		U8	U8		
U7		U7	U7		
U6		U6	U6		
U5	<b>Oracle Exadata storage cell</b>	U5	U5		U5
U4	<b>Oracle Exadata storage cell</b>	U4	U4		U4
U3	<b>Oracle Exadata storage cell</b>	U3	U3		U3
U2		U2	U2		
U1	1U Solid Filler	U1	U1		U1
U24		U24	<b>36-Port IB Switch</b>	U24	
U23		U23	<b>KVM LCD</b>	U23	
U22		U22	<b>KVM Switch</b>	U22	
U21		U21	<b>Cisco 4948</b>	U21	
U20		U20	<b>36-Port IB Switch</b>	U20	

 \* Ports oriented to the rear

The following table shows the front and rear views of Oracle Exadata Database Machine X2-8 Full Rack.

**Figure 17-4 Rack Layout of Oracle Exadata Database Machine X2-8 Full Rack**

Front View			Rear View		
U42	Oracle Exadata storage cell	U42	U42	Oracle Exadata storage cell	U42
U41		U41	U41		U41
U40	Oracle Exadata storage cell	U40	U40	Oracle Exadata storage cell	U40
U39		U39	U39		U39
U38	Oracle Exadata storage cell	U38	U38	Oracle Exadata storage cell	U38
U37		U37	U37		U37
U36	Oracle Exadata storage cell	U36	U36	Oracle Exadata storage cell	U36
U35		U35	U35		U35
U34	Oracle Exadata storage cell	U34	U34	Oracle Exadata storage cell	U34
U33		U33	U33		U33
U32	Oracle Exadata storage cell	U32	U32	Oracle Exadata storage cell	U32
U31		U31	U31		U31
U30	Oracle Exadata storage cell	U30	U30	Oracle Exadata storage cell	U30
U29		U29	U29		U29
U28	Oracle Database Server	U28	U28	Oracle Database Server	U28
U27		U27	U27		U27
U26		U26	U26		U26
U25		U25	U25		U25
U24		U24	U24		U24
U23		1U Vented Filler	U23		U23
U22	1U Vented Filler	U22	U22	Cisco 4948	U22
U21	1U Vented Filler	U21	U21	36-port IB switch	U21
U20	Oracle Database Server	U20	U20	Oracle Database Server	U20
U19		U19	U19		U19
U18		U18	U18		U18
U17		U17	U17		U17
U16		U16	U16		U16
U15	Oracle Exadata storage cell	U15	U15	Oracle Exadata storage cell	U15
U14		U14	U14		U14
U13	Oracle Exadata storage cell	U13	U13	Oracle Exadata storage cell	U13
U12		U12	U12		U12
U11	Oracle Exadata storage cell	U11	U11	Oracle Exadata storage cell	U11
U10		U10	U10		U10
U9	Oracle Exadata storage cell	U9	U9	Oracle Exadata storage cell	U9
U8		U8	U8		U8
U7	Oracle Exadata storage cell	U7	U7	Oracle Exadata storage cell	U7
U6		U6	U6		U6
U5	Oracle Exadata storage cell	U5	U5	Oracle Exadata storage cell	U5
U4		U4	U4		U4
U3	Oracle Exadata storage cell	U3	U3	Oracle Exadata storage cell	U3
U2		U2	U2		U2
U1	1U Vented Filler	U1	U1	36-Port IB Switch	U1

 \* Ports oriented to the rear

## 17.2 Keyboard, Video and Mouse Network Cabling Tables

This section contains the tables for the keyboard, video and mouse (KVM) network cabling. The KVM port on the servers is labeled SER MGT, and connects to the KVM switch is located in rack unit 22. The following tables are in this section:

- [Table 17-1](#)
- [Table 17-2](#)
- [Table 17-3](#)

[Table 17-1](#) shows the cable connections from the servers to the KVM switch in Oracle Exadata Database Machine X2-2 Full Rack:



**Table 17-1 KVM Cabling for Oracle Exadata Database Machine X2-2 Full Rack**

From Rack Unit	Type of Equipment	KVM Port
U41	Exadata Storage Server	1
U39	Exadata Storage Server	2
U37	Exadata Storage Server	3
U35	Exadata Storage Server	4
U33	Exadata Storage Server	5
U31	Exadata Storage Server	6
U29	Exadata Storage Server	7
U28	Database server	8
U27	Database server	9
U26	Database server	10
U25	Database server	11
U19	Database server	12
U18	Database server	13
U17	Database server	14
U16	Database server	15
U14	Exadata Storage Server	16
U12	Exadata Storage Server	17
U10	Exadata Storage Server	18
U8	Exadata Storage Server	19
U6	Exadata Storage Server	20
U4	Exadata Storage Server	21
U2	Exadata Storage Server	22

Table 17-2 shows the cable connections from the servers to the KVM switch in Oracle Exadata Database Machine X2-2 Half Rack:

**Table 17-2 KVM Cabling for Oracle Exadata Database Machine X2-2 Half Rack**

From Rack Unit	Type of Equipment	KVM Port
U19	Database server	12
U18	Database server	13
U17	Database server	14
U16	Database server	15
U14	Exadata Storage Server	16
U12	Exadata Storage Server	17
U10	Exadata Storage Server	18
U8	Exadata Storage Server	19
U6	Exadata Storage Server	20

**Table 17-2 (Cont.) KVM Cabling for Oracle Exadata Database Machine X2-2 Half Rack**

From Rack Unit	Type of Equipment	KVM Port
U4	Exadata Storage Server	21
U2	Exadata Storage Server	22

[Table 17-3](#) shows the cable connections from the servers to the KVM switch in Oracle Exadata Database Machine X2-2 Quarter Rack:

**Table 17-3 KVM Cabling for Oracle Exadata Database Machine X2-2 Quarter Rack**

From Rack Unit	Type of Equipment	KVM Port
U17	Database server	14
U16	Database server	15
U6	Exadata Storage Server	20
U4	Exadata Storage Server	21
U2	Exadata Storage Server	22

## 17.3 Sun Integrated Lights Out Manager Cabling Tables

This section contains the tables for the Sun Integrated Lights Out Manager (ILOM) network cabling. The ILOM port on the servers is labeled NET MGT, and connects to the Gigabit Ethernet port located in rack unit 21 on Oracle Exadata Database Machine X2-2 racks. The ILOM port connects to the Gigabit Ethernet port located in rack unit 22 on Oracle Exadata Database Machine X2-8 Full Rack racks.

The following tables are in this section:

- [Table 17-4](#)
- [Table 17-5](#)
- [Table 17-6](#)
- [Table 17-7](#)

[Table 17-4](#) shows the cable connections from the servers to the ILOM switch in Oracle Exadata Database Machine X2-2 Full Rack:

**Table 17-4 ILOM Cabling for Oracle Exadata Database Machine X2-2 Full Rack**

From Rack Unit	Type of Equipment	Gigabit Ethernet Port
U41	Exadata Storage Server	2
U39	Exadata Storage Server	4
U37	Exadata Storage Server	6
U35	Exadata Storage Server	8
U33	Exadata Storage Server	10
U31	Exadata Storage Server	12

**Table 17-4 (Cont.) ILOM Cabling for Oracle Exadata Database Machine X2-2 Full Rack**

From Rack Unit	Type of Equipment	Gigabit Ethernet Port
U29	Exadata Storage Server	14
U28	Database server	16
U27	Database server	18
U26	Database server	20
U25	Database server	22
U19	Database server	24
U18	Database server	26
U17	Database server	28
U16	Database server	30
U14	Exadata Storage Server	32
U12	Exadata Storage Server	34
U10	Exadata Storage Server	36
U8	Exadata Storage Server	38
U6	Exadata Storage Server	40
U4	Exadata Storage Server	42
U2	Exadata Storage Server	44

Table 17-5 shows the cable connections from the servers to the ILOM switch in Oracle Exadata Database Machine X2-2 Half Rack:

**Table 17-5 ILOM Cabling for Oracle Exadata Database Machine X2-2 Half Rack**

From Rack Unit	Type of Equipment	Gigabit Ethernet Port
U19	Database server	24
U18	Database server	26
U17	Database server	28
U16	Database server	30
U14	Exadata Storage Server	32
U12	Exadata Storage Server	34
U10	Exadata Storage Server	36
U8	Exadata Storage Server	38
U6	Exadata Storage Server	40
U4	Exadata Storage Server	42
U2	Exadata Storage Server	44

Table 17-6 shows the cable connections from the servers to the ILOM switch in Oracle Exadata Database Machine X2-2 Quarter Rack:

**Table 17-6 ILOM Cabling for Oracle Exadata Database Machine X2-2 Quarter Rack**

From Rack Unit	Type of Equipment	Gigabit Ethernet Port
U17	Database server	28
U16	Database server	30
U6	Exadata Storage Server	40
U4	Exadata Storage Server	42
U2	Exadata Storage Server	44

Table 17-7 shows the cable connections from the servers to the ILOM switch in Oracle Exadata Database Machine X2-8 Full Rack:

**Table 17-7 ILOM Cabling for Oracle Exadata Database Machine X2-8 Full Rack**

From Rack Unit	Type of Equipment	Gigabit Ethernet Port
U41	Exadata Storage Server	2
U39	Exadata Storage Server	4
U37	Exadata Storage Server	6
U35	Exadata Storage Server	8
U33	Exadata Storage Server	10
U31	Exadata Storage Server	12
U29	Exadata Storage Server	14
U24	Database server	16
U16	Database server	18
U14	Exadata Storage Server	20
U12	Exadata Storage Server	22
U10	Exadata Storage Server	24
U8	Exadata Storage Server	26
U6	Exadata Storage Server	28
U4	Exadata Storage Server	30
U2	Exadata Storage Server	32

## 17.4 Administrative Gigabit Ethernet Port Cabling Tables

This section contains the tables for the administrative Gigabit Ethernet network cabling. The Gigabit Ethernet switch is located in rack unit 21 on Oracle Exadata Database Machine X2-2 racks. The Gigabit Ethernet switch is located in rack unit 22 on Oracle Exadata Database Machine X2-8 Full Rack racks.

The following tables are in this section:

- [Table 17-8](#)
- [Table 17-9](#)
- [Table 17-10](#)

- [Table 17-11](#)

[Table 17-8](#) shows the cable connections from the servers to the Gigabit Ethernet switch in Oracle Exadata Database Machine X2-2 Full Rack:

**Table 17-8 Gigabit Ethernet Cabling for Oracle Exadata Database Machine X2-2 Full Rack**

From Rack Unit	Type of Equipment	Gigabit Ethernet Port
U41	Exadata Storage Server	1
U39	Exadata Storage Server	3
U37	Exadata Storage Server	5
U35	Exadata Storage Server	7
U33	Exadata Storage Server	9
U31	Exadata Storage Server	11
U29	Exadata Storage Server	13
U28	Database server	15
U27	Database server	17
U26	Database server	19
U25	Database server	21
U24	Sun Datacenter InfiniBand Switch 36 switch	45
U20	Sun Datacenter InfiniBand Switch 36 switch	46
U19	Database server	23
U18	Database server	25
U17	Database server	27
U16	Database server	29
U14	Exadata Storage Server	31
U12	Exadata Storage Server	33
U10	Exadata Storage Server	35
U8	Exadata Storage Server	37
U6	Exadata Storage Server	39
U4	Exadata Storage Server	41
U2	Exadata Storage Server	43
U1	Sun Datacenter InfiniBand Switch 36 switch	47

[Table 17-9](#) shows the cable connections from the servers to the Gigabit Ethernet switch in Oracle Exadata Database Machine X2-2 Half Rack:

**Table 17-9 Gigabit Ethernet Cabling for Oracle Exadata Database Machine X2-2 Half Rack**

From Rack Unit	Type of Equipment	Gigabit Ethernet Port
U24	Sun Datacenter InfiniBand Switch 36 switch	45
U20	Sun Datacenter InfiniBand Switch 36 switch	46
U19	Database server	23
U18	Database server	25
U17	Database server	27
U16	Database server	29
U14	Exadata Storage Server	31
U12	Exadata Storage Server	33
U10	Exadata Storage Server	35
U8	Exadata Storage Server	37
U6	Exadata Storage Server	39
U4	Exadata Storage Server	41
U2	Exadata Storage Server	43
U1	Sun Datacenter InfiniBand Switch 36 switch	47

Table 17-10 shows the cable connections from the servers to the Gigabit Ethernet switch in Oracle Exadata Database Machine X2-2 Quarter Rack:

**Table 17-10 Gigabit Ethernet Cabling for Oracle Exadata Database Machine X2-2 Quarter Rack**

From Rack Unit	Type of Equipment	Gigabit Ethernet Port
U24	Sun Datacenter InfiniBand Switch 36 switch	45
U20	Sun Datacenter InfiniBand Switch 36 switch	46
U17	Database server	27
U16	Database server	29
U6	Exadata Storage Server	39
U4	Exadata Storage Server	41
U2	Exadata Storage Server	43

Table 17-11 shows the cable connections from the servers to the Gigabit Ethernet switch in Oracle Exadata Database Machine X2-8 Full Rack:

**Table 17-11 Gigabit Ethernet Cabling for Oracle Exadata Database Machine X2-8 Full Rack**

From Rack Unit	Type of Equipment	Gigabit Ethernet Port
U41	Exadata Storage Server	1
U39	Exadata Storage Server	3
U37	Exadata Storage Server	5
U35	Exadata Storage Server	7
U33	Exadata Storage Server	9
U31	Exadata Storage Server	11
U29	Exadata Storage Server	13
U24	Database server	15
U23	Sun Datacenter InfiniBand Switch 36	33
U21	Sun Datacenter InfiniBand Switch 36	34
U16	Database server	17
U14	Exadata Storage Server	19
U12	Exadata Storage Server	21
U10	Exadata Storage Server	23
U8	Exadata Storage Server	25
U6	Exadata Storage Server	27
U4	Exadata Storage Server	29
U2	Exadata Storage Server	31
U1	Sun Datacenter InfiniBand Switch 36	35

## 17.5 Single Phase Power Distribution Unit Cabling Tables

This section contains the tables for single phase cabling from each power distribution unit (PDU) to the power supplies configured in each rack. The cables are terminated to PDU-A on the left, and routed to the right to enter CMA, and are bundled in groups of four.

The following tables are in this section:

- [Table 17-12](#)
- [Table 17-13](#)
- [Table 17-14](#)
- [Table 17-15](#)

[Table 17-12](#) shows the cable connections from the PDUs to the rack units in Oracle Exadata Database Machine X2-2 Full Rack.

**Table 17-12 Single Phase PDU Cabling for Oracle Exadata Database Machine X2-2 Full Rack**

Rack Unit	PDU-A/PS-00	PDU-B/PS-01	Cable Length
U41	G5-6	G0-0	2 meters
U39	G5-3	G0-3	2 meters
U37	G5-0	G0-6	2 meters
U35	G4-6	G1-0	2 meters
U33	G4-4	G1-2	2 meters
U31	G4-2	G1-4	2 meters
U29	G3-6	G2-0	2 meters
U28	G4-0	G1-6	2 meters
U27	G3-5	G2-1	2 meters
U26	G3-4	G2-2	2 meters
U25	G3-3	G2-3	2 meters
U24	G3-1	G2-5	1 meters
U23	N/A	G3-0	included
U22	G2-5	G3-1	2 meter
U21	G3-0	G2-6	2 meters
U20	G2-4	G3-2	2 meters
U19	G2-3	G3-3	2 meters
U18	G2-2	G3-4	2 meters
U17	G2-1	G3-5	2 meters
U16	G1-6	G4-0	2 meters
U14	G2-0	G3-6	2 meters
U12	G1-4	G4-2	2 meters
U10	G1-2	G4-4	2 meters
U8	G1-0	G4-6	2 meters
U6	G0-6	G5-0	2 meters
U4	G0-4	G5-2	2 meters
U2	G0-2	G5-4	2 meters
U1	G0-0	G5-6	2 meters

Table 17-13 shows the cable connections from the PDUs to the rack units in Oracle Exadata Database Machine X2-2 Half Rack.

**Table 17-13 Single Phase PDU Cabling for Oracle Exadata Database Machine X2-2 Half Rack**

Rack Unit	PDU-A/PS-00	PDU-B/PS-01	Cable Length
U24	G3-1	G2-5	1 meters
U23	N/A	G3-0	included



**Table 17-13 (Cont.) Single Phase PDU Cabling for Oracle Exadata Database Machine X2-2 Half Rack**

Rack Unit	PDU-A/PS-00	PDU-B/PS-01	Cable Length
U22	G2-5	G3-1	2 meter
U21	G3-0	G2-6	2 meters
U20	G2-4	G3-2	2 meters
U19	G2-3	G3-3	2 meters
U18	G2-2	G3-4	2 meters
U17	G2-1	G3-5	2 meters
U16	G1-6	G4-0	2 meters
U14	G2-0	G3-6	2 meters
U12	G1-4	G4-2	2 meters
U10	G1-2	G4-4	2 meters
U8	G1-0	G4-6	2 meters
U6	G0-6	G5-0	2 meters
U4	G0-4	G5-2	2 meters
U2	G0-2	G5-4	2 meters
U1	G0-0	G5-6	2 meters

Table 17-14 shows the cable connections from the PDUs to the rack units in Oracle Exadata Database Machine X2-2 Quarter Rack.

**Table 17-14 Single Phase PDU Cabling for Oracle Exadata Database Machine X2-2 Quarter Rack**

Rack Unit	PDU-A/PS-00	PDU-B/PS-01	Cable Length
U24	G3-1	G2-5	1 meters
U23	N/A	G3-0	included
U22	G2-5	G3-1	2 meter
U21	G3-0	G2-6	2 meters
U20	G2-4	G3-2	2 meters
U17	G2-1	G3-5	2 meters
U16	G1-6	G4-0	2 meters
U6	G0-6	G5-0	2 meters
U4	G0-4	G5-2	2 meters
U2	G0-2	G5-4	2 meters
U1	G0-0	G5-6	2 meters

Table 17-15 shows the cable connections from the PDUs to the rack units in Oracle Exadata Database Machine X2-8 Full Rack.

**Table 17-15 Single Phase PDU Cabling for Oracle Exadata Database Machine X2-8 Full Rack**

Rack Unit	PDU-A/PS-00	PDU-B/PS-01	Cable Length
U41	G5-6	G0-0	2 meters
U39	G5-4	G0-2	2 meters
U37	G5-2	G0-4	2 meters
U35	G5-0	G0-6	2 meters
U33	G4-6	G1-0	2 meters
U31	G4-3	G1-3	2 meters
U29	G3-6	G2-0	2 meters
U24	G4-0	G1-6	1 meter
U24	G3-5	G2-1	1 meter
U23	G3-1	G2-5	2 meters
U22	G2-6	G3-0	2 meters
U21	G3-0	G2-6	2 meters
U16	G2-1	G3-5	1 meter
U16	G1-6	G4-0	1 meter
U14	G2-0	G3-6	2 meters
U12	G1-3	G4-3	2 meters
U10	G1-0	G4-6	2 meters
U8	G0-6	G5-0	2 meters
U6	G0-4	G5-2	2 meters
U4	G0-3	G5-3	2 meters
U2	G0-1	G5-5	2 meters
U1	G0-0	G5-6	2 meters

## 17.6 Three Phase Power Distribution Unit Cabling Tables

This section contains the tables for three phase cabling from each power distribution unit (PDU) to the power supplies configured in each rack. The cables are terminated to PDU-A on the left, and routed to the right to enter CMA, and are bundled in groups of four.

The following tables are in this section:

- [Table 17-16](#)
- [Table 17-17](#)
- [Table 17-18](#)
- [Table 17-19](#)

[Table 17-16](#) shows the cable connections from the PDUs to the rack units in Oracle Exadata Database Machine X2-2 Full Rack.

**Table 17-16 Three Phase PDU Cabling for Oracle Exadata Database Machine X2-2 Full Rack**

Rack Unit	PDU-A/PS-00	PDU-B/PS-01	Cable Length
U41	G5-6	G2-0	2 meters
U39	G5-3	G2-3	2 meters
U37	G5-0	G2-6	2 meters
U35	G4-6	G1-0	2 meters
U33	G4-4	G1-2	2 meters
U31	G4-2	G1-4	2 meters
U29	G3-6	G0-0	2 meters
U28	G4-0	G1-6	2 meters
U27	G3-5	G0-1	2 meters
U26	G3-4	G0-2	2 meters
U25	G3-3	G0-3	2 meters
U24	G3-1	G0-5	1 meters
U23	N/A	G5-0	included
U22	G2-5	G5-1	2 meter
U21	G3-0	G0-6	2 meters
U20	G2-4	G5-2	2 meters
U19	G2-3	G5-3	2 meters
U18	G2-2	G5-4	2 meters
U17	G2-1	G5-5	2 meters
U16	G1-6	G4-0	2 meters
U14	G2-0	G5-6	2 meters
U12	G1-4	G4-2	2 meters
U10	G1-2	G4-4	2 meters
U8	G1-0	G4-6	2 meters
U6	G0-6	G3-0	2 meters
U4	G0-4	G3-2	2 meters
U2	G0-2	G3-4	2 meters
U1	G0-0	G3-6	2 meters

Table 17-17 shows the cable connections from the PDUs to the rack units in Oracle Exadata Database Machine X2-2 Half Rack.

**Table 17-17 Three Phase PDU Cabling for Oracle Exadata Database Machine X2-2 Half Rack**

Rack Unit	PDU-A/PS-00	PDU-B/PS-01	Cable Length
U24	G3-1	G0-5	1 meters
U23	N/A	G5-0	included

**Table 17-17 (Cont.) Three Phase PDU Cabling for Oracle Exadata Database Machine X2-2 Half Rack**

Rack Unit	PDU-A/PS-00	PDU-B/PS-01	Cable Length
U22	G2-5	G5-1	2 meter
U21	G3-0	G0-6	2 meters
U20	G2-4	G5-2	2 meters
U19	G2-3	G5-3	2 meters
U18	G2-2	G5-4	2 meters
U17	G2-1	G5-5	2 meters
U16	G1-6	G4-0	2 meters
U14	G2-0	G5-6	2 meters
U12	G1-4	G4-2	2 meters
U10	G1-2	G4-4	2 meters
U8	G1-0	G4-6	2 meters
U6	G0-6	G3-0	2 meters
U4	G0-4	G3-2	2 meters
U2	G0-2	G3-4	2 meters
U1	G0-0	G3-6	2 meters

[Table 17-18](#) shows the cable connections from the PDUs to the rack units in Oracle Exadata Database Machine X2-2 Quarter Rack.

**Table 17-18 Three Phase PDU Cabling for Oracle Exadata Database Machine X2-2 Quarter Rack**

Rack Unit	PDU-A/PS-00	PDU-B/PS-01	Cable Length
U24	G3-1	G0-5	1 meters
U23	N/A	G5-0	included
U22	G2-5	G5-1	2 meter
U21	G3-0	G0-6	2 meters
U20	G2-4	G5-2	2 meters
U17	G2-1	G5-5	2 meters
U16	G1-6	G4-0	2 meters
U6	G0-6	G3-0	2 meters
U4	G0-4	G3-2	2 meters
U2	G0-2	G3-4	2 meters
U1	G0-0	G3-6	2 meters

[Table 17-19](#) shows the cable connections from the PDUs to the rack units in Oracle Exadata Database Machine X2-8 Full Rack.

**Table 17-19 Three Phase PDU Cabling for Oracle Exadata Database Machine X2-8 Full Rack**

Rack Unit	PDU-A/PS-00	PDU-B/PS-01	Cable Length
U41	G5-5	G2-1	2 meters
U39	G5-4	G2-2	2 meters
U37	G5-2	G2-4	2 meters
U35	G5-1	G2-5	2 meters
U33	G5-0	G2-6	2 meters
U31	G4-6	G1-0	2 meters
U29	G4-4	G1-2	2 meters
U24	G4-1	G1-5	1 meter
U24	G3-6	G0-0	1 meter
U23	G3-3	G0-3	2 meters
U22	G3-0	G0-6	2 meters
U21	G2-5	G5-1	2 meters
U16	G2-1	G5-5	1 meter
U16	G1-6	G4-0	1 meter
U14	G1-3	G4-3	2 meters
U12	G1-0	G4-6	2 meters
U10	G0-6	G3-0	2 meters
U8	G0-5	G3-1	2 meters
U6	G0-4	G3-2	2 meters
U4	G0-2	G3-4	2 meters
U2	G0-1	G3-5	2 meters
U1	G0-0	G3-6	2 meters

## 17.7 InfiniBand Network Cabling Tables

This section contains the tables for the InfiniBand network cabling. The Sun Datacenter InfiniBand Switch 36 switches are located in located in rack unit 1, 20 and 24.

The following tables are in this section:

- [Table 17-20](#)
- [Table 17-21](#)
- [Table 17-22](#)
- [Table 17-23](#)

[Table 17-20](#) lists the location, ports and cables for the InfiniBand connections for Oracle Exadata Database Machine X2-2 Full Rack.

**Table 17-20 InfiniBand Network Cabling for Oracle Exadata Database Machine X2-2 Full Rack**

From InfiniBand Switch Rack Unit	Port	To Rack Unit	Type of Equipment	Port	Cable Description
U24	0A	U41	Exadata Storage Server	PCIe 3, P1	3 meter QDR InfiniBand cable
U24	0B	U39	Exadata Storage Server	PCIe 3, P1	3 meter QDR InfiniBand cable
U24	1A	U37	Exadata Storage Server	PCIe 3, P1	3 meter QDR InfiniBand cable
U24	1B	U35	Exadata Storage Server	PCIe 3, P1	3 meter QDR InfiniBand cable
U24	2A	U33	Exadata Storage Server	PCIe 3, P1	3 meter QDR InfiniBand cable
U24	2B	U31	Exadata Storage Server	PCIe 3, P1	3 meter QDR InfiniBand cable
U24	3A	U29	Exadata Storage Server	PCIe 3, P1	3 meter QDR InfiniBand cable
U24	3B	U28	Database server	PCIe 2, P1	2 meter QDR InfiniBand cable
U24	4A	U27	Database server	PCIe 2, P1	2 meter QDR InfiniBand cable
U24	4B	U26	Database server	PCIe 2, P1	2 meter QDR InfiniBand cable
U24	5A	U25	Database server	PCIe 2, P1	2 meter QDR InfiniBand cable
U24	12B	U19	Database server	PCIe 2, P2	2 meter QDR InfiniBand cable
U24	13A	U18	Database server	PCIe 2, P2	2 meter QDR InfiniBand cable
U24	13B	U17	Database server	PCIe 2, P2	2 meter QDR InfiniBand cable

**Table 17-20 (Cont.) InfiniBand Network Cabling for Oracle Exadata Database Machine X2-2 Full Rack**

From InfiniBand Switch Rack Unit	Port	To Rack Unit	Type of Equipment	Port	Cable Description
U24	14A	U16	Database server	PCIe 2, P2	2 meter QDR InfiniBand cable
U24	14B	U14	Exadata Storage Server	PCIe 3, P2	3 meter QDR InfiniBand cable
U24	15A	U12	Exadata Storage Server	PCIe 3, P2	3 meter QDR InfiniBand cable
U24	15B	U10	Exadata Storage Server	PCIe 3, P2	3 meter QDR InfiniBand cable
U24	16A	U8	Exadata Storage Server	PCIe 3, P2	3 meter QDR InfiniBand cable
U24	16B	U6	Exadata Storage Server	PCIe 3, P2	3 meter QDR InfiniBand cable
U24	17A	U4	Exadata Storage Server	PCIe 3, P2	3 meter QDR InfiniBand cable
U24	17B	U2	Exadata Storage Server	PCIe 3, P2	3 meter QDR InfiniBand cable
U20	0A	U41	Exadata Storage Server	PCIe 3, P2	3 meter QDR InfiniBand cable
U20	0B	U39	Exadata Storage Server	PCIe 3, P2	3 meter QDR InfiniBand cable
U20	1A	U37	Exadata Storage Server	PCIe 3, P2	3 meter QDR InfiniBand cable
U20	1B	U35	Exadata Storage Server	PCIe 3, P2	3 meter QDR InfiniBand cable
U20	2A	U33	Exadata Storage Server	PCIe 3, P2	3 meter QDR InfiniBand cable
U20	2B	U31	Exadata Storage Server	PCIe 3, P2	3 meter QDR InfiniBand cable

**Table 17-20 (Cont.) InfiniBand Network Cabling for Oracle Exadata Database Machine X2-2 Full Rack**

From InfiniBand Switch Rack Unit	Port	To Rack Unit	Type of Equipment	Port	Cable Description
U20	3A	U29	Exadata Storage Server	PCIe 3, P2	3 meter QDR InfiniBand cable
U20	3B	U28	Database server	PCIe 2, P2	2 meter QDR InfiniBand cable
U20	4A	U27	Database server	PCIe 2, P2	2 meter QDR InfiniBand cable
U20	4B	U26	Database server	PCIe 2, P2	2 meter QDR InfiniBand cable
U20	5A	U25	Database server	PCIe 2, P2	2 meter QDR InfiniBand cable
U20	12B	U19	Database Server	PCIe 2, P1	2 meter QDR InfiniBand cable
U20	13A	U18	Database server	PCIe 2, P1	2 meter QDR InfiniBand cable
U20	13B	U17	Database server	PCIe 2, P1	2 meter QDR InfiniBand cable
U20	14A	U16	Database server	PCIe 2, P1	2 meter QDR InfiniBand cable
U20	14B	U14	Exadata Storage Server	PCIe 3, P1	2 meter QDR InfiniBand cable
U20	15A	U12	Exadata Storage Server	PCIe 3, P1	3 meter QDR InfiniBand cable
U20	15B	U10	Exadata Storage Server	PCIe 3, P1	3 meter QDR InfiniBand cable
U20	16A	U8	Exadata Storage Server	PCIe 3, P1	3 meter QDR InfiniBand cable
U20	16B	U6	Exadata Storage Server	PCIe 3, P1	3 meter QDR InfiniBand cable



**Table 17-20 (Cont.) InfiniBand Network Cabling for Oracle Exadata Database Machine X2-2 Full Rack**

From InfiniBand Switch Rack Unit	Port	To Rack Unit	Type of Equipment	Port	Cable Description
U20	17A	U4	Exadata Storage Server	PCIe 3, P1	3 meter QDR InfiniBand cable
U20	17B	U2	Exadata Storage Server	PCIe 3, P1	3 meter QDR InfiniBand cable
U24	8B	U1	Sun Datacenter InfiniBand Switch 36 switch	0B	3 meter QDR InfiniBand cable
U20	8B	U1	Sun Datacenter InfiniBand Switch 36 switch	1B	3 meter QDR InfiniBand cable
U20	9B	U24	Sun Datacenter InfiniBand Switch 36 switch	9A	1 meter QDR InfiniBand cable
U20	10B	U24	Sun Datacenter InfiniBand Switch 36 switch	10A	1 meter QDR InfiniBand cable
U20	11B	U24	Sun Datacenter InfiniBand Switch 36 switch	11A	1 meter QDR InfiniBand cable
U20	8A	U24	Sun Datacenter InfiniBand Switch 36 switch	8A	1 meter QDR InfiniBand cable
U20	9A	U24	Sun Datacenter InfiniBand Switch 36 switch	9B	1 meter QDR InfiniBand cable
U20	10A	U24	Sun Datacenter InfiniBand Switch 36 switch	10B	1 meter QDR InfiniBand cable
U20	11A	U24	Sun Datacenter InfiniBand Switch 36 switch	11B	1 meter QDR InfiniBand cable

**Table 17-20 (Cont.) InfiniBand Network Cabling for Oracle Exadata Database Machine X2-2 Full Rack**

From InfiniBand Switch Rack Unit	Port	To Rack Unit	Type of Equipment	Port	Cable Description
U1	1B	U20	Sun Datacenter InfiniBand Switch 36 switch	8B	3 meter QDR InfiniBand cable
U1	0B	U24	Sun Datacenter InfiniBand Switch 36 switch	8B	3 meter QDR InfiniBand cable

Table 17-21 lists the location, ports and cables for the InfiniBand connections for Oracle Exadata Database Machine X2-2 Half Rack.



**Note:**

The Sun Datacenter InfiniBand Switch 36 switch in rack position U1 is included in Oracle Exadata Database Machine X2-2 Half Racks with Sun Fire X4170 M2 Oracle Database Servers.

**Table 17-21 InfiniBand Network Cabling for Oracle Exadata Database Machine X2-2 Half Rack**

From InfiniBand Switch Rack Unit	Port	To Rack Unit	Type of Equipment	Port	Cable Description
U24	12B	U19	Database server	PCIe 2, P2	2 meter QDR InfiniBand cable
U24	13A	U18	Database server	PCIe 2, P2	2 meter QDR InfiniBand cable
U24	13B	U17	Database server	PCIe 2, P2	2 meter QDR InfiniBand cable
U24	14A	U16	Database server	PCIe 2, P2	2 meter QDR InfiniBand cable
U24	14B	U14	Exadata Storage Server	PCIe 3, P2	3 meter QDR InfiniBand cable

**Table 17-21 (Cont.) InfiniBand Network Cabling for Oracle Exadata Database Machine X2-2 Half Rack**

From InfiniBand Switch Rack Unit	Port	To Rack Unit	Type of Equipment	Port	Cable Description
U24	15A	U12	Exadata Storage Server	PCIe 3, P2	3 meter QDR InfiniBand cable
U24	15B	U10	Exadata Storage Server	PCIe 3, P2	3 meter QDR InfiniBand cable
U24	16A	U8	Exadata Storage Server	PCIe 3, P2	3 meter QDR InfiniBand cable
U24	16B	U6	Exadata Storage Server	PCIe 3, P2	3 meter QDR InfiniBand cable
U24	17A	U4	Exadata Storage Server	PCIe 3, P2	3 meter QDR InfiniBand cable
U24	17B	U2	Exadata Storage Server	PCIe 3, P2	3 meter QDR InfiniBand cable
U20	12B	U19	Database Server	PCIe 2, P1	2 meter QDR InfiniBand cable
U20	13A	U18	Database server	PCIe 2, P1	2 meter QDR InfiniBand cable
U20	13B	U17	Database server	PCIe 2, P1	2 meter QDR InfiniBand cable
U20	14A	U16	Database server	PCIe 2, P1	2 meter QDR InfiniBand cable
U20	14B	U14	Exadata Storage Server	PCIe 3, P1	2 meter QDR InfiniBand cable
U20	15A	U12	Exadata Storage Server	PCIe 3, P1	3 meter QDR InfiniBand cable
U20	15B	U10	Exadata Storage Server	PCIe 3, P1	3 meter QDR InfiniBand cable
U20	16A	U8	Exadata Storage Server	PCIe 3, P1	3 meter QDR InfiniBand cable

**Table 17-21 (Cont.) InfiniBand Network Cabling for Oracle Exadata Database Machine X2-2 Half Rack**

From InfiniBand Switch Rack Unit	Port	To Rack Unit	Type of Equipment	Port	Cable Description
U20	16B	U6	Exadata Storage Server	PCIe 3, P1	3 meter QDR InfiniBand cable
U20	17A	U4	Exadata Storage Server	PCIe 3, P1	3 meter QDR InfiniBand cable
U20	17B	U2	Exadata Storage Server	PCIe 3, P1	3 meter QDR InfiniBand cable
U20	9B	U24	Sun Datacenter InfiniBand Switch 36 switch	9A	1 meter QDR InfiniBand cable
U20	10B	U24	Sun Datacenter InfiniBand Switch 36 switch	10A	1 meter QDR InfiniBand cable
U20	11B	U24	Sun Datacenter InfiniBand Switch 36 switch	11A	1 meter QDR InfiniBand cable
U20	8A	U24	Sun Datacenter InfiniBand Switch 36 switch	8A	1 meter QDR InfiniBand cable
U20	9A	U24	Sun Datacenter InfiniBand Switch 36 switch	9B	1 meter QDR InfiniBand cable
U20	10A	U24	Sun Datacenter InfiniBand Switch 36 switch	10B	1 meter QDR InfiniBand cable
U20	11A	U24	Sun Datacenter InfiniBand Switch 36 switch	11B	1 meter QDR InfiniBand cable
U1	1B	U20	Sun Datacenter InfiniBand Switch 36 switch	8B	3 meter QDR InfiniBand cable
U1	0B	U24	Sun Datacenter InfiniBand Switch 36 switch	8B	3 meter QDR InfiniBand cable

Table 17-22 lists the location, ports and cables for the InfiniBand connections for Oracle Exadata Database Machine X2-2 Quarter Rack.

**Table 17-22 InfiniBand Network Cabling for Oracle Exadata Database Machine X2-2 Quarter Rack**

From InfiniBand Switch Rack Unit	Port	To Rack Unit	Type of Equipment	Port	Cable Description
U24	13B	U17	Database server	PCIe 2, P2	2 meter QDR InfiniBand cable
U24	14A	U16	Database server	PCIe 2, P2	2 meter QDR InfiniBand cable
U24	16B	U6	Exadata Storage Server	PCIe 3, P2	3 meter QDR InfiniBand cable
U24	17A	U4	Exadata Storage Server	PCIe 3, P2	3 meter QDR InfiniBand cable
U24	17B	U2	Exadata Storage Server	PCIe 3, P2	3 meter QDR InfiniBand cable
U20	13B	U17	Database server	PCIe 2, P1	2 meter QDR InfiniBand cable
U20	14A	U16	Database server	PCIe 2, P1	2 meter QDR InfiniBand cable
U20	16B	U6	Exadata Storage Server	PCIe 3, P1	3 meter QDR InfiniBand cable
U20	17A	U4	Exadata Storage Server	PCIe 3, P1	3 meter QDR InfiniBand cable
U20	17B	U2	Exadata Storage Server	PCIe 3, P1	3 meter QDR InfiniBand cable
U20	9B	U24	Sun Datacenter InfiniBand Switch 36 switch	9A	1 meter QDR InfiniBand cable
U20	10B	U24	Sun Datacenter InfiniBand Switch 36 switch	10A	1 meter QDR InfiniBand cable

**Table 17-22 (Cont.) InfiniBand Network Cabling for Oracle Exadata Database Machine X2-2 Quarter Rack**

From InfiniBand Switch Rack Unit	Port	To Rack Unit	Type of Equipment	Port	Cable Description
U20	11B	U24	Sun Datacenter InfiniBand Switch 36 switch	11A	1 meter QDR InfiniBand cable
U20	8A	U24	Sun Datacenter InfiniBand Switch 36 switch	8A	1 meter QDR InfiniBand cable
U20	9A	U24	Sun Datacenter InfiniBand Switch 36 switch	9B	1 meter QDR InfiniBand cable
U20	10A	U24	Sun Datacenter InfiniBand Switch 36 switch	10B	1 meter QDR InfiniBand cable
U20	11A	U24	Sun Datacenter InfiniBand Switch 36 switch	11B	1 meter QDR InfiniBand cable

[Table 17-23](#) lists the location, ports and cables for the InfiniBand connections for Oracle Exadata Database Machine X2-8 Full Rack.

**Table 17-23 InfiniBand Network Cabling for Oracle Exadata Database Machine X2-8 Full Rack**

From InfiniBand Switch Rack Unit	Port	To Rack Unit	Type of Equipment	Port	Cable Description
U23	0A	U41	Exadata Storage Server	PCIe 3, P1	3 meter QDR InfiniBand cable
U23	0B	U39	Exadata Storage Server	PCIe 3, P1	3 meter QDR InfiniBand cable
U23	1A	U37	Exadata Storage Server	PCIe 3, P1	3 meter QDR InfiniBand cable

**Table 17-23 (Cont.) InfiniBand Network Cabling for Oracle Exadata Database Machine X2-8 Full Rack**

From InfiniBand Switch Rack Unit	Port	To Rack Unit	Type of Equipment	Port	Cable Description
U23	1B	U35	Exadata Storage Server	PCIe 3, P1	3 meter QDR InfiniBand cable
U23	2A	U33	Exadata Storage Server	PCIe 3, P1	3 meter QDR InfiniBand cable
U23	2B	U31	Exadata Storage Server	PCIe 3, P1	3 meter QDR InfiniBand cable
U23	3A	U29	Exadata Storage Server	PCIe 3, P1	3 meter QDR InfiniBand cable
U23	3B	U24	Database server	EM-3.0 P-O	2 meter QDR InfiniBand cable
U23	4A	U24	Database server	EM-2.0 P-O	2 meter QDR InfiniBand cable
U23	4B	U24	Database server	EM-1.0 P-O	2 meter QDR InfiniBand cable
U23	5A	U24	Database server	EM-0.0 P-O	2 meter QDR InfiniBand cable
U23	13A	U16	Database server	EM-2.0 P-1	2 meter QDR InfiniBand cable
U23	13B	U16	Database server	EM-1.0 P-1	2 meter QDR InfiniBand cable
U23	14A	U16	Database server	EM-0.0 P-1	2 meter QDR InfiniBand cable
U23	12B	U16	Database server	EM-3.0 P-1	2 meter QDR InfiniBand cable
U23	14B	U14	Exadata Storage Server	PCIe 3, P2	3 meter QDR InfiniBand cable
U23	15A	U12	Exadata Storage Server	PCIe 3, P2	3 meter QDR InfiniBand cable

**Table 17-23 (Cont.) InfiniBand Network Cabling for Oracle Exadata Database Machine X2-8 Full Rack**

From InfiniBand Switch Rack Unit	Port	To Rack Unit	Type of Equipment	Port	Cable Description
U23	15B	U10	Exadata Storage Server	PCIe 3, P2	3 meter QDR InfiniBand cable
U23	16A	U8	Exadata Storage Server	PCIe 3, P2	3 meter QDR InfiniBand cable
U23	16B	U6	Exadata Storage Server	PCIe 3, P2	3 meter QDR InfiniBand cable
U23	17A	U4	Exadata Storage Server	PCIe 3, P2	3 meter QDR InfiniBand cable
U23	17B	U2	Exadata Storage Server	PCIe 3, P2	3 meter QDR InfiniBand cable
U21	0A	U41	Exadata Storage Server	PCIe 3, P2	3 meter QDR InfiniBand cable
U21	0B	U39	Exadata Storage Server	PCIe 3, P2	3 meter QDR InfiniBand cable
U21	1A	U37	Exadata Storage Server	PCIe 3, P2	3 meter QDR InfiniBand cable
U21	1B	U35	Exadata Storage Server	PCIe 3, P2	3 meter QDR InfiniBand cable
U21	2A	U33	Exadata Storage Server	PCIe 3, P2	3 meter QDR InfiniBand cable
U21	2B	U31	Exadata Storage Server	PCIe 3, P2	3 meter QDR InfiniBand cable
U21	3A	U29	Exadata Storage Server	PCIe 3, P2	3 meter QDR InfiniBand cable
U21	3B	U24	Database server	EM-3.0 P-1	2 meter QDR InfiniBand cable
U21	4A	U24	Database server	EM-2.0 P-1	2 meter QDR InfiniBand cable



**Table 17-23 (Cont.) InfiniBand Network Cabling for Oracle Exadata Database Machine X2-8 Full Rack**

From InfiniBand Switch Rack Unit	Port	To Rack Unit	Type of Equipment	Port	Cable Description
U21	4B	U24	Database server	EM-1.0 P-1	2 meter QDR InfiniBand cable
U21	5A	U24	Database server	EM-0.0 P-1	2 meter QDR InfiniBand cable
U21	12B	U16	Database Server	EM-3.0 P-O	2 meter QDR InfiniBand cable
U21	13A	U16	Database server	EM-2.0 P-O	2 meter QDR InfiniBand cable
U21	13B	U16	Database server	EM-1.0 P-O	2 meter QDR InfiniBand cable
U21	14A	U16	Database server	EM-0.0 P-O	2 meter QDR InfiniBand cable
U21	14B	U14	Exadata Storage Server	PCIe 3, P1	2 meter QDR InfiniBand cable
U21	15A	U12	Exadata Storage Server	PCIe 3, P1	3 meter QDR InfiniBand cable
U21	15B	U10	Exadata Storage Server	PCIe 3, P1	3 meter QDR InfiniBand cable
U21	16A	U8	Exadata Storage Server	PCIe 3, P1	3 meter QDR InfiniBand cable
U21	16B	U6	Exadata Storage Server	PCIe 3, P1	3 meter QDR InfiniBand cable
U21	17A	U4	Exadata Storage Server	PCIe 3, P1	3 meter QDR InfiniBand cable
U21	17B	U2	Exadata Storage Server	PCIe 3, P1	3 meter QDR InfiniBand cable
U23	8B	U1	Sun Datacenter InfiniBand Switch 36 switch	0B	3 meter QDR InfiniBand cable

**Table 17-23 (Cont.) InfiniBand Network Cabling for Oracle Exadata Database Machine X2-8 Full Rack**

From InfiniBand Switch Rack Unit	Port	To Rack Unit	Type of Equipment	Port	Cable Description
U21	8B	U1	Sun Datacenter InfiniBand Switch 36 switch	1B	3 meter QDR InfiniBand cable
U21	9B	U23	Sun Datacenter InfiniBand Switch 36 switch	9A	1 meter QDR InfiniBand cable
U21	10B	U23	Sun Datacenter InfiniBand Switch 36 switch	10A	1 meter QDR InfiniBand cable
U21	11B	U23	Sun Datacenter InfiniBand Switch 36 switch	11A	1 meter QDR InfiniBand cable
U21	8A	U23	Sun Datacenter InfiniBand Switch 36 switch	8A	1 meter QDR InfiniBand cable
U21	9A	U23	Sun Datacenter InfiniBand Switch 36 switch	9B	1 meter QDR InfiniBand cable
U21	10A	U23	Sun Datacenter InfiniBand Switch 36 switch	10B	1 meter QDR InfiniBand cable
U21	11A	U23	Sun Datacenter InfiniBand Switch 36 switch	11B	1 meter QDR InfiniBand cable
U1	1B	U21	Sun Datacenter InfiniBand Switch 36 switch	8B	3 meter QDR InfiniBand cable
U1	0B	U23	Sun Datacenter InfiniBand Switch 36 switch	8B	3 meter QDR InfiniBand cable

# 18

## Cabling Tables for Oracle Exadata Storage Expansion Rack X9M-2

This section shows the cable layouts for Oracle Exadata Storage Expansion Rack X9M-2.

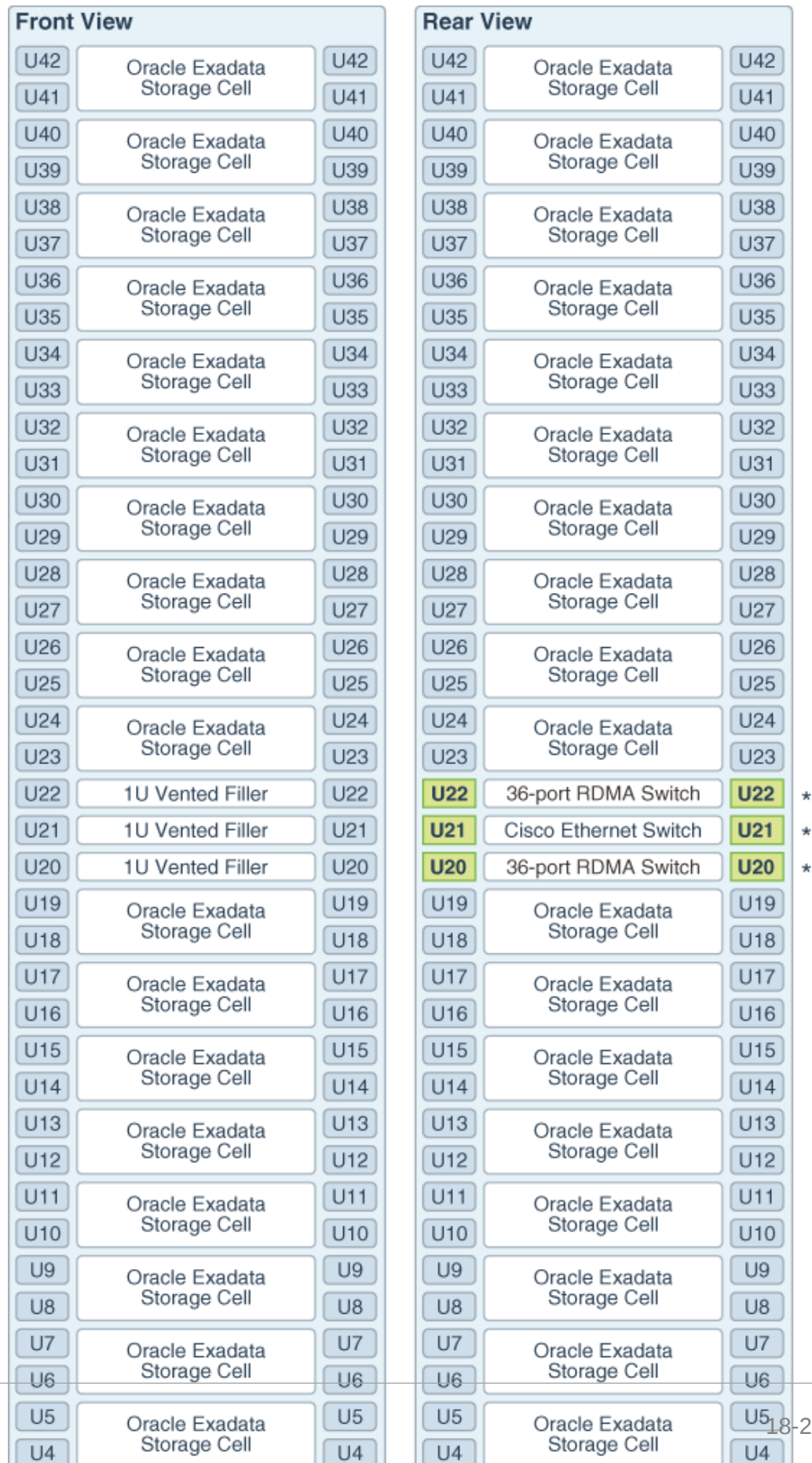
- [Rack Layout](#)  
This topic shows the component placement within Oracle Exadata Storage Expansion Rack X9M-2.
- [Integrated Lights Out Manager \(ILOM\) Cabling](#)  
This topic shows the ILOM network cabling for Oracle Exadata Storage Expansion Rack X9M-2.
- [Administrative Network Cabling](#)  
This topic shows the Administrative network cabling for the Oracle Exadata Storage Expansion Rack X9M-2.
- [Single Phase Power Distribution Unit Cabling](#)  
This topic shows the cabling routes from each single-phase power distribution unit (PDU) to the power supplies configured in each Oracle Exadata Storage Expansion Rack X9M-2.
- [Three Phase Power Distribution Unit Cabling](#)  
This topic shows the cabling routes from each three-phase power distribution unit (PDU) to the power supplies configured in Oracle Exadata Storage Expansion Rack X9M-2.
- [RDMA Network Fabric Cabling](#)  
Use the following RDMA Network Fabric cabling information for Oracle Exadata Storage Expansion Rack X9M-2.

### 18.1 Rack Layout

This topic shows the component placement within Oracle Exadata Storage Expansion Rack X9M-2.

The following image shows the front and rear of Oracle Exadata Storage Expansion Rack X9M-2 configured with the maximum of 19 storage servers. The front is shown on the left, and the rear is shown on the right.

Figure 18-1 Rack Layout of Oracle Exadata Storage Expansion Rack X9M-2



## 18.2 Integrated Lights Out Manager (ILOM) Cabling

This topic shows the ILOM network cabling for Oracle Exadata Storage Expansion Rack X9M-2.

The ILOM port on the servers is labeled NET MGT, and connects to the Management Network Switch located in rack unit 21 on Oracle Exadata Storage Expansion Racks.

The following table shows the cable connections from the servers to the ILOM switch in Oracle Exadata Storage Expansion Rack X9M-2:

**Table 18-1 ILOM Cabling for Oracle Exadata Storage Expansion Rack X9M-2**

From Rack Unit	Type of Equipment	Gigabit Ethernet Port
U41	Storage Server	16
U39	Storage Server	2
U37	Storage Server	4
U35	Storage Server	6
U33	Storage Server	8
U31	Storage Server	10
U29	Storage Server	12
U27	Storage Server	14
U25	Storage Server	18
U23	Storage Server	22
U18	Storage Server	26
U16	Storage Server	30
U14	Storage Server	32
U12	Storage Server	34
U10	Storage Server	36
U8	Storage Server	38
U6	Storage Server	40
U4	Storage Server	42
U2	Storage Server	44
PDU-A	PDU	19
PDU-B	PDU	20

## 18.3 Administrative Network Cabling

This topic shows the Administrative network cabling for the Oracle Exadata Storage Expansion Rack X9M-2.

The port on the storage servers is labeled NET0, and connects to the Management Network Switch located in rack unit 21 on Oracle Exadata Storage Expansion Racks.

The following table shows the cable connections from the rack components to the Management Network Switch in Oracle Exadata Storage Expansion Rack X9M-2

**Table 18-2 Administrative Network Cabling for Oracle Exadata Storage Expansion Rack X9M-2**

From Rack Unit	Type of Equipment	Management Network Switch Port
U41	Storage Server	15
U39	Storage Server	1
U37	Storage Server	3
U35	Storage Server	5
U33	Storage Server	7
U31	Storage Server	9
U29	Storage Server	11
U27	Storage Server	13
U25	Storage Server	17
U23	Storage Server	21
U22	RDMA Network Fabric leaf switch	45
U20	RDMA Network Fabric leaf switch	46
U18	Storage Server	25
U16	Storage Server	29
U14	Storage Server	31
U12	Storage Server	33
U10	Storage Server	35
U8	Storage Server	37
U6	Storage Server	39
U4	Storage Server	41
U2	Storage Server	43
U1	RDMA Network Fabric spine switch	47

## 18.4 Single Phase Power Distribution Unit Cabling

This topic shows the cabling routes from each single-phase power distribution unit (PDU) to the power supplies configured in each Oracle Exadata Storage Expansion Rack X9M-2.

The cables are terminated to PDU-A on the left (when looking at the rear of the rack), and routed to the right to enter cable management arm (CMA). The cables are bundled in groups of four. The PDU connections list the group and outlet on the PDU. So, for example, G5-5 refers to group 5 outlet 5.

The following table shows the cable connections from the PDUs to the rack units in Oracle Exadata Storage Expansion Rack X9M-2.

**Table 18-3 Single Phase PDU Cabling for Oracle Exadata Storage Expansion Rack X9M-2**

Rack Slot	PDU-A / PSU 0	PDU-B / PSU 1	Cable Length
U42	G5-6	G0-0	3 meters
U41	G4-6	G1-0	3 meters
U40	G4-2	G1-4	3 meters
U39	G4-4	G1-2	3 meters
U37	G1-5	G4-1	3 meters
U35	G3-1	G2-5	3 meters
U33	G1-3	G4-3	3 meters
U31	G3-3	G2-3	3 meters
U29	G4-0	G1-6	3 meters
U27	G5-2	G0-4	3 meters
U26	G0-6	G5-0	3 meters
U25	G3-0	G2-6	3 meters
U24	G4-1	G1-5	3 meters
U23	G5-0	G0-6	3 meters
U22	G1-6	G4-0	3 meters
U21	G0-4	G5-2	3 meters
U20	G0-3	G5-3	3 meters
U19	G3-2	G2-4	3 meters
U18	G2-5	G3-1	3 meters
U17	G1-2	G4-4	3 meters
U16	G1-4	G4-2	3 meters
U14	G5-3	G0-3	3 meters
U12	G5-4	G0-2	3 meters
U10	G2-3	G3-3	3 meters
U08	G2-4	G3-2	3 meters
U06	G2-6	G3-0	3 meters
U04	G0-2	G5-4	3 meters
U02	G0-5	G5-1	3 meters
U01	G4-3	G1-3	3 meters

## 18.5 Three Phase Power Distribution Unit Cabling

This topic shows the cabling routes from each three-phase power distribution unit (PDU) to the power supplies configured in Oracle Exadata Storage Expansion Rack X9M-2.

The cables are terminated to PDU-A on the left (when looking at the rear of the rack), and routed to the right to enter cable management arm (CMA). The cables are bundled in groups of four. The PDU connections list the group and outlet on the PDU. So, for example, G5-5 refers to group 5 outlet 5.

The following table shows the cable connections from the PDUs to the rack units in Oracle Exadata Storage Expansion Rack X9M-2.

**Table 18-4 Three Phase PDU Cabling for Oracle Exadata Storage Expansion Rack X9M-2**

Rack Slot	PDU-A / PSU 0	PDU-B / PSU 1	Cable Length
U42	G5-4	G2-2	3 meters
U41	G5-2	G2-4	3 meters
U40	G5-1	G2-5	3 meters
U39	G4-6	G1-0	3 meters
U37	G4-1	G1-5	3 meters
U35	G4-5	G1-1	3 meters
U33	G5-5	G2-1	3 meters
U31	G4-2	G1-4	3 meters
U29	G5-3	G2-3	3 meters
U27	G3-2	G0-4	3 meters
U26	G5-0	G2-6	3 meters
U25	G3-0	G0-6	3 meters
U24	G3-1	G0-5	3 meters
U23	G3-5	G0-1	3 meters
U22	G1-6	G4-0	3 meters
U21	G2-6	G5-0	3 meters
U20	G1-5	G4-1	3 meters
U19	G1-1	G4-5	3 meters
U18	G1-4	G4-2	3 meters
U17	G2-1	G5-5	3 meters
U16	G1-3	G4-3	3 meters
U14	G0-5	G3-1	3 meters
U12	G2-5	G5-1	3 meters
U10	G0-3	G3-3	3 meters
U08	G2-3	G5-3	3 meters
U06	G2-4	G5-2	3 meters
U04	G0-6	G3-0	3 meters
U02	G0-0	G3-6	3 meters
U01	G1-0	G4-6	3 meters

## 18.6 RDMA Network Fabric Cabling

Use the following RDMA Network Fabric cabling information for Oracle Exadata Storage Expansion Rack X9M-2.



**Table 18-5 RDMA Network Fabric Cabling for Oracle Exadata Storage Expansion Rack X9M-2 Full Rack**

From Rack Unit	Port	To RDMA Network Fabric Switch Rack Unit	Port	Description
U41	PCle 1, P2	U22	15	3 meters
U41	PCle 1, P1	U20	15	3 meters
U39	PCle 1, P2	U22	08	3 meters
U39	PCle 1, P1	U20	08	3 meters
U37	PCle 1, P2	U22	09	3 meters
U37	PCle 1, P1	U20	09	3 meters
U35	PCle 1, P2	U22	10	3 meters
U35	PCle 1, P1	U20	10	3 meters
U33	PCle 1, P2	U22	11	3 meters
U33	PCle 1, P1	U20	11	3 meters
U31	PCle 1, P2	U22	12	3 meters
U31	PCle 1, P1	U20	12	3 meters
U29	PCle 1, P2	U22	13	3 meters
U29	PCle 1, P1	U20	13	3 meters
U27	PCle 1, P2	U22	14	3 meters
U27	PCle 1, P1	U20	14	3 meters
U25	PCle 1, P2	U22	16	3 meters
U25	PCle 1, P1	U20	16	3 meters
U23	PCle 1, P2	U22	18	3 meters
U23	PCle 1, P1	U20	18	3 meters
U18	PCle 1, P2	U22	20	3 meters
U18	PCle 1, P1	U20	20	3 meters
U14	PCle 1, P2	U22	23	3 meters
U14	PCle 1, P1	U20	23	3 meters
U12	PCle 1, P2	U22	24	3 meters
U12	PCle 1, P1	U20	24	3 meters
U10	PCle 1, P2	U22	25	3 meters
U10	PCle 1, P1	U20	25	3 meters
U08	PCle 1, P2	U22	26	3 meters
U08	PCle 1, P1	U20	26	3 meters
U06	PCle 1, P2	U22	27	3 meters
U06	PCle 1, P1	U20	27	3 meters
U04	PCle 1, P2	U22	28	3 meters
U04	PCle 1, P1	U20	28	3 meters
U02	PCle 1, P2	U22	29	3 meters

**Table 18-5 (Cont.) RDMA Network Fabric Cabling for Oracle Exadata Storage Expansion Rack X9M-2 Full Rack**

From Rack Unit	Port	To RDMA Network Fabric Switch Rack Unit	Port	Description
U02	PCIe 1, P1	U20	29	3 meters
U1	PCIe 1, P2	U22		3 meters
U1	PCIe 1, P1	U20		3 meters

# 19

## Cabling Tables for Oracle Exadata Storage Expansion Rack X8M and Earlier

### Note:

For ease of reading, the name "Oracle Exadata Rack" is used when information refers to both Oracle Exadata Database Machine and Oracle Exadata Storage Expansion Rack.

- [Storage Expansion Rack Layout Diagrams](#)  
These tables show the component placement within Oracle Exadata Storage Expansion Rack.
- [Integrated Lights Out Manager \(ILOM\) Cabling Tables](#)  
These tables show the ILOM network cabling for the Oracle Exadata Storage Expansion Racks.
- [Administrative Network Cabling Tables](#)  
These tables show the Administrative network cabling for the Oracle Exadata Storage Expansion Racks.
- [Single Phase Power Distribution Unit Cabling Tables](#)  
These tables show the cabling routes from each single-phase power distribution unit (PDU) to the power supplies configured in each Oracle Exadata Storage Expansion Rack.
- [Three Phase Power Distribution Unit Cabling Tables](#)  
These tables show the cabling routes from each three-phase power distribution unit (PDU) to the power supplies configured in each Oracle Exadata Storage Expansion Rack.
- [RDMA Network Fabric Network Cabling Tables](#)  
These tables show the RDMA Network Fabric network cabling connections for the Oracle Exadata Storage Expansion Rack.

### 19.1 Storage Expansion Rack Layout Diagrams

These tables show the component placement within Oracle Exadata Storage Expansion Rack.

#### **Oracle Exadata Storage Expansion Rack X5 to X8M**

The following image shows the front and rear of Oracle Exadata Storage Expansion Full Rack for X5 to X8M. The front is shown on the left, and the rear is shown on the right.

**Figure 19-1 Rack Layout of Oracle Exadata Storage Expansion Full Rack X5 to X8M**



### Oracle Exadata Storage Expansion Rack X3-2 and X4-2

The following image shows the front and rear of Oracle Exadata Storage Expansion X4-2 Full Rack, and Oracle Exadata Storage Expansion X3-2 Full Rack. The front is shown on the left, and the rear is shown on the right.

**Figure 19-2 Rack Layout of Oracle Exadata Storage Expansion X4-2 Full Rack, and Oracle Exadata Storage Expansion X3-2 Full Rack**

Front View			Rear View		
U42	1 U Solid Filler	U42	U42	1 U Solid Filler	U42
U41	1 U Solid Filler	U41	U41	1 U Solid Filler	U41
U40	Oracle Exadata storage cell	U40	U40	Oracle Exadata storage cell	U40
U39		U39	U39		
U38	Oracle Exadata storage cell	U38	U38	Oracle Exadata storage cell	U38
U37		U37	U37		
U36	Oracle Exadata storage cell	U36	U36	Oracle Exadata storage cell	U36
U35		U35	U35		
U34	Oracle Exadata storage cell	U34	U34	Oracle Exadata storage cell	U34
U33		U33	U33		
U32	Oracle Exadata storage cell	U32	U32	Oracle Exadata storage cell	U32
U31		U31	U31		
U30	Oracle Exadata storage cell	U30	U30	Oracle Exadata storage cell	U30
U29		U29	U29		
U28	Oracle Exadata storage cell	U28	U28	Oracle Exadata storage cell	U28
U27		U27	U27		
U26	Oracle Exadata storage cell	U26	U26	Oracle Exadata storage cell	U26
U25		U25	U25		
U24	Oracle Exadata storage cell	U24	U24	Oracle Exadata storage cell	U24
U23		U23	U23		
U22	1U Vented Filler	U22	U22	36-Port IB Switch	U22
U21	1U Vented Filler	U21	U21	Cisco 4948	U21
U20	1U Vented Filler	U20	U20	36-Port IB Switch	U20
U19	Oracle Exadata storage cell	U19	U19	Oracle Exadata storage cell	U19
U18		U18	U18		
U17	Oracle Exadata storage cell	U17	U17	Oracle Exadata storage cell	U17
U16		U16	U16		
U15	Oracle Exadata storage cell	U15	U15	Oracle Exadata storage cell	U15
U14		U14	U14		
U13	Oracle Exadata storage cell	U13	U13	Oracle Exadata storage cell	U13
U12		U12	U12		
U11	Oracle Exadata storage cell	U11	U11	Oracle Exadata storage cell	U11
U10		U10	U10		
U9	Oracle Exadata storage cell	U9	U9	Oracle Exadata storage cell	U9
U8		U8	U8		
U7	Oracle Exadata storage cell	U7	U7	Oracle Exadata storage cell	U7
U6		U6	U6		
U5	Oracle Exadata storage cell	U5	U5	Oracle Exadata storage cell	U5
U4		U4	U4		
U3	Oracle Exadata storage cell	U3	U3	Oracle Exadata storage cell	U3
U2		U2	U2		
U1	1U Vented Filler	U1	U1	36-Port IB Switch	U1

 \* Ports oriented to the rear

The following image shows the front and rear of Oracle Exadata Storage Expansion X4-2 Half Rack, and Oracle Exadata Storage Expansion X3-2 Half Rack. The front is shown on the left, and the rear is shown on the right.

**Figure 19-3 Rack Layout of Oracle Exadata Storage Expansion X4-2 Half Rack, and Oracle Exadata Storage Expansion X3-2 Half Rack**

Front View			Rear View		
U42	4U Solid Filler	U42	U42	36-Port IB Switch	U42
U41		U41	U41		U41
U40		U40	U40		U40
U39	4U Solid Filler	U39	U39	36-Port IB Switch	U39
U38		U38	U38		U38
U37		U37	U37		U37
U36	4U Solid Filler	U36	U36	36-Port IB Switch	U36
U35		U35	U35		U35
U34		U34	U34		U34
U33	2U Solid Filler	U33	U33	36-Port IB Switch	U33
U32	2U Solid Filler	U32	U32	Cisco 4948	U32
U31	2U Solid Filler	U31	U31	36-Port IB Switch	U31
U30	2U Solid Filler	U30	U30	36-Port IB Switch	U30
U29	2U Solid Filler	U29	U29	36-Port IB Switch	U29
U28	2U Solid Filler	U28	U28	36-Port IB Switch	U28
U27	2U Solid Filler	U27	U27	36-Port IB Switch	U27
U26	1U Solid Filler	U26	U26	36-Port IB Switch	U26
U25	1U Solid Filler	U25	U25	36-Port IB Switch	U25
U24	1U Vented Filler	U24	U24	36-Port IB Switch	U24
U23	1U Vented Filler	U23	U23	36-Port IB Switch	U23
U22	36-Port IB Switch	U22	U22	36-Port IB Switch	U22
U21	1U Vented Filler	U21	U21	Cisco 4948	U21
U20	1U Vented Filler	U20	U20	36-Port IB Switch	U20
U19	Oracle Exadata storage cell	U19	U19	Oracle Exadata storage cell	U19
U18	Oracle Exadata storage cell	U18	U18	Oracle Exadata storage cell	U18
U17	Oracle Exadata storage cell	U17	U17	Oracle Exadata storage cell	U17
U16	Oracle Exadata storage cell	U16	U16	Oracle Exadata storage cell	U16
U15	Oracle Exadata storage cell	U15	U15	Oracle Exadata storage cell	U15
U14	Oracle Exadata storage cell	U14	U14	Oracle Exadata storage cell	U14
U13	Oracle Exadata storage cell	U13	U13	Oracle Exadata storage cell	U13
U12	Oracle Exadata storage cell	U12	U12	Oracle Exadata storage cell	U12
U11	Oracle Exadata storage cell	U11	U11	Oracle Exadata storage cell	U11
U10	Oracle Exadata storage cell	U10	U10	Oracle Exadata storage cell	U10
U9	Oracle Exadata storage cell	U9	U9	Oracle Exadata storage cell	U9
U8	Oracle Exadata storage cell	U8	U8	Oracle Exadata storage cell	U8
U7	Oracle Exadata storage cell	U7	U7	Oracle Exadata storage cell	U7
U6	Oracle Exadata storage cell	U6	U6	Oracle Exadata storage cell	U6
U5	Oracle Exadata storage cell	U5	U5	Oracle Exadata storage cell	U5
U4	Oracle Exadata storage cell	U4	U4	Oracle Exadata storage cell	U4
U3	Oracle Exadata storage cell	U3	U3	Oracle Exadata storage cell	U3
U2	Oracle Exadata storage cell	U2	U2	Oracle Exadata storage cell	U2
U1	1U Vented Filler	U1	U1	36-Port IB Switch	U1

 \* Ports oriented to the rear

The following image shows the front and rear of Oracle Exadata Storage Expansion X4-2 Quarter Rack, and Oracle Exadata Storage Expansion X3-2 Quarter Rack. The front is shown on the left, and the rear is shown on the right.

**Figure 19-4 Rack Layout of Oracle Exadata Storage Expansion X4-2 Quarter Rack, and Oracle Exadata Storage Expansion X3-2 Quarter Rack**

Front View			Rear View		
U42		U42	U42		U42
U41	4U Solid Filler	U41	U41		U41
U40		U40	U40		U40
U39		U39	U39		U39
U38	4U Solid Filler	U38	U38		U38
U37		U37	U37		U37
U36		U36	U36		U36
U35		U35	U35		U35
U34	2U Solid Filler	U34	U34		U34
U33		U33	U33		U33
U32	2U Solid Filler	U32	U32		U32
U31		U31	U31		U31
U30	2U Solid Filler	U30	U30		U30
U29		U29	U29		U29
U28	2U Solid Filler	U28	U28		U28
U27		U27	U27		U27
U26	1U Solid Filler	U26	U26		U26
U25	1U Solid Filler	U25	U25		U25
U24	1U Vented Filler	U24	U24		U24
U23	1U Vented Filler	U23	U23		U23
U22	1U Vented Filler	U22	U22	<b>36-Port IB Switch</b>	U22
U21	1U Vented Filler	U21	U21	<b>Cisco 4948</b>	U21
U20	1U Vented Filler	U20	U20	<b>36-Port IB Switch</b>	U20
U19	1U Solid Filler	U19	U19		U19
U18	1U Solid Filler	U18	U18		U18
U17	<b>2U Solid filler</b>	U17	U17		U17
U16		U16	U16		U16
U15	2U Solid Filler	U15	U15		U15
U14		U14	U14		U14
U13	2U Solid Filler	U13	U13		U13
U12		U12	U12		U12
U11	2U Solid Filler	U11	U11		U11
U10		U10	U10		U10
U9	Oracle Exadata storage cell	U9	U9	Oracle Exadata storage cell	U9
U8		U8	U8	Oracle Exadata storage cell	U8
U7	Oracle Exadata storage cell	U7	U7	Oracle Exadata storage cell	U7
U6		U6	U6	Oracle Exadata storage cell	U6
U5	Oracle Exadata storage cell	U5	U5	Oracle Exadata storage cell	U5
U4		U4	U4	Oracle Exadata storage cell	U4
U3	Oracle Exadata storage cell	U3	U3	Oracle Exadata storage cell	U3
U2		U2	U2	Oracle Exadata storage cell	U2
U1	1U Solid Filler	U1	U1		U1


 \* Ports oriented to the rear

**Oracle Exadata Storage Expansion Full Rack with Exadata Storage Server with Sun Fire X4270 M2 Servers**

The following image shows the front and rear views of Oracle Exadata Storage Expansion Full Rack with Exadata Storage Server with Sun Fire X4270 M2 Servers. The front is shown on the left, and the rear is shown on the right.

**Figure 19-5 Rack Layout of Oracle Exadata Storage Expansion Full Rack with Exadata Storage Server with Sun Fire X4270 M2 Servers**

Front View			Rear View		
U42	Oracle Exadata storage cell	U42	U42	Oracle Exadata storage cell	U42
U41		U41	U41		U41
U40	Oracle Exadata storage cell	U40	U40	Oracle Exadata storage cell	U40
U39		U39	U39		U39
U38	Oracle Exadata storage cell	U38	U38	Oracle Exadata storage cell	U38
U37		U37	U37		U37
U36	Oracle Exadata storage cell	U36	U36	Oracle Exadata storage cell	U36
U35		U35	U35		U35
U34	Oracle Exadata storage cell	U34	U34	Oracle Exadata storage cell	U34
U33		U33	U33		U33
U32	Oracle Exadata storage cell	U32	U32	Oracle Exadata storage cell	U32
U31		U31	U31		U31
U30	Oracle Exadata storage cell	U30	U30	Oracle Exadata storage cell	U30
U29		U29	U29		U29
U28	Oracle Exadata storage cell	U28	U28	Oracle Exadata storage cell	U28
U27		U27	U27		U27
U26	Oracle Exadata storage cell	U26	U26	Oracle Exadata storage cell	U26
U25		U25	U25		U25
U24	1U Vented Filler	U24	U24	<b>36-Port IB Switch</b>	U24
U23	<b>KVM LCD</b>	U23	U23	<b>KVM LCD</b>	U23
U22	1U Vented Filler	U22	U22	<b>KVM Switch</b>	U22
U21	1U Vented Filler	U21	U21	<b>Cisco 4948</b>	U21
U20	1U Vented Filler	U20	U20	<b>36-Port IB Switch</b>	U20
U19	Oracle Exadata storage cell	U19	U19	Oracle Exadata storage cell	U19
U18		U18	U18		U18
U17	Oracle Exadata storage cell	U17	U17	Oracle Exadata storage cell	U17
U16		U16	U16		U16
U15	Oracle Exadata storage cell	U15	U15	Oracle Exadata storage cell	U15
U14		U14	U14		U14
U13	Oracle Exadata storage cell	U13	U13	Oracle Exadata storage cell	U13
U12		U12	U12		U12
U11	Oracle Exadata storage cell	U11	U11	Oracle Exadata storage cell	U11
U10		U10	U10		U10
U9	Oracle Exadata storage cell	U9	U9	Oracle Exadata storage cell	U9
U8		U8	U8		U8
U7	Oracle Exadata storage cell	U7	U7	Oracle Exadata storage cell	U7
U6		U6	U6		U6
U5	Oracle Exadata storage cell	U5	U5	Oracle Exadata storage cell	U5
U4		U4	U4		U4
U3	Oracle Exadata storage cell	U3	U3	Oracle Exadata storage cell	U3
U2		U2	U2		U2
U1	1U Vented Filler	U1	U1	<b>36-Port IB Switch</b>	U1

 \* Ports oriented to the rear

The following image shows the front and rear views of Oracle Exadata Storage Expansion Half Rack with Exadata Storage Server with Sun Fire X4270 M2 Servers. The front is shown on the left, and the rear is shown on the right.



**Figure 19-6 Rack Layout of Oracle Exadata Storage Expansion Half Rack with Exadata Storage Server with Sun Fire X4270 M2 Servers**

Front View			Rear View		
U42	4U Solid Filler	U42	U42		U42
U41		U41	U41		U41
U40		U40	U40		U40
U39		U39	U39		U39
U38	4U Solid Filler	U38	U38		U38
U37		U37	U37		U37
U36		U36	U36		U36
U35		U35	U35		U35
U34	2U Solid Filler	U34	U34		U34
U33		U33	U33		U33
U32	2U Solid Filler	U32	U32		U32
U31		U31	U31		U31
U30	2U Solid Filler	U30	U30		U30
U29		U29	U29		U29
U28	2U Solid Filler	U28	U28		U28
U27		U27	U27		U27
U26	1U Solid Filler	U26	U26		U26
U25	1U Solid Filler	U25	U25		U25
U24	1U Vented Filler	U24	U24	<b>36-Port IB Switch</b>	U24
U23	<b>KVM LCD</b>	U23	U23	<b>KVM LCD</b>	U23
U22	1U Vented Filler	U22	U22	<b>KVM Switch</b>	U22
U21	1U Vented Filler	U21	U21	<b>Cisco 4948</b>	U21
U20	1U Vented Filler	U20	U20	<b>36-Port IB Switch</b>	U20
U19	Oracle Exadata storage cell	U19	U19	Oracle Exadata storage cell	U19
U18		U18	U18	Oracle Exadata storage cell	U18
U17	Oracle Exadata storage cell	U17	U17	Oracle Exadata storage cell	U17
U16		U16	U16	Oracle Exadata storage cell	U16
U15	Oracle Exadata storage cell	U15	U15	Oracle Exadata storage cell	U15
U14		U14	U14	Oracle Exadata storage cell	U14
U13	Oracle Exadata storage cell	U13	U13	Oracle Exadata storage cell	U13
U12		U12	U12	Oracle Exadata storage cell	U12
U11	Oracle Exadata storage cell	U11	U11	Oracle Exadata storage cell	U11
U10		U10	U10	Oracle Exadata storage cell	U10
U9	Oracle Exadata storage cell	U9	U9	Oracle Exadata storage cell	U9
U8		U8	U8	Oracle Exadata storage cell	U8
U7	Oracle Exadata storage cell	U7	U7	Oracle Exadata storage cell	U7
U6		U6	U6	Oracle Exadata storage cell	U6
U5	Oracle Exadata storage cell	U5	U5	Oracle Exadata storage cell	U5
U4		U4	U4	Oracle Exadata storage cell	U4
U3	Oracle Exadata storage cell	U3	U3	Oracle Exadata storage cell	U3
U2		U2	U2	Oracle Exadata storage cell	U2
U1	1U Vented Filler	U1	U1	<b>36-Port IB Switch</b>	U1

 \* Ports oriented to the rear

The following image shows the front and rear views of Oracle Exadata Storage Expansion Quarter Rack with Exadata Storage Server with Sun Fire X4270 M2 Servers. The front is shown on the left, and the rear is shown on the right.

**Figure 19-7 Rack Layout of Oracle Exadata Storage Expansion Quarter Rack with Exadata Storage Server with Sun Fire X4270 M2 Servers**

Front View			Rear View		
U42		U42	U42		U42
U41	4U Solid Filler	U41	U41		U41
U40		U40	U40		U40
U39		U39	U39		U39
U38	4U Solid Filler	U38	U38		U38
U37		U37	U37		U37
U36		U36	U36		U36
U35		U35	U35		U35
U34	2U Solid Filler	U34	U34		U34
U33		U33	U33		U33
U32	2U Solid Filler	U32	U32		U32
U31	2U Solid Filler	U31	U31		U31
U30	2U Solid Filler	U30	U30		U30
U29	2U Solid Filler	U29	U29		U29
U28	2U Solid Filler	U28	U28		U28
U27	2U Solid Filler	U27	U27		U27
U26	1U Solid Filler	U26	U26		U26
U25	1U Solid Filler	U25	U25		U25
U24	1U Vented Filler	U24	U24	<b>36-Port IB Switch</b>	U24 *
U23	<b>KVM LCD</b>	U23	U23	<b>KVM LCD</b>	U23
U22	1U Vented Filler	U22	U22	<b>KVM Switch</b>	U22 *
U21	1U Vented Filler	U21	U21	<b>Cisco 4948</b>	U21 *
U20	1U Vented Filler	U20	U20	<b>36-Port IB Switch</b>	U20 *
U19	1U Solid Filler	U19	U19		U19
U18	1U Solid Filler	U18	U18		U18
U17	<b>2U Solid filler</b>	U17	U17		U17
U16		U16	U16		U16
U15	2U Solid Filler	U15	U15		U15
U14	2U Solid Filler	U14	U14		U14
U13	2U Solid Filler	U13	U13		U13
U12		U12	U12		U12
U11	2U Solid Filler	U11	U11		U11
U10		U10	U10		U10
U9	Oracle Exadata storage cell	U9	Oracle Exadata storage cell		U9
U8		U8	Oracle Exadata storage cell		U8
U7	Oracle Exadata storage cell	U7	Oracle Exadata storage cell		U7
U6	Oracle Exadata storage cell	U6	Oracle Exadata storage cell		U6
U5	Oracle Exadata storage cell	U5	Oracle Exadata storage cell		U5
U4	Oracle Exadata storage cell	U4	Oracle Exadata storage cell		U4
U3	Oracle Exadata storage cell	U3	Oracle Exadata storage cell		U3
U2		U2	Oracle Exadata storage cell		U2
U1	1U Solid Filler	U1	U1		U1

 \* Ports oriented to the rear

## 19.2 Integrated Lights Out Manager (ILOM) Cabling Tables

These tables show the ILOM network cabling for the Oracle Exadata Storage Expansion Racks.

The ILOM port on the servers is labeled NET MGT, and connects to the Management Network Switch located in rack unit 21 on Oracle Exadata Storage Expansion Racks.

- [Table 19-1](#) ILOM Cabling for Oracle Exadata Storage Expansion Rack X6-2, X7-2, X8-2, and X8M-2
- [Table 19-2](#) ILOM Cabling for Oracle Exadata Storage Expansion Rack X5-2
- [Table 19-3](#) ILOM Cabling for Oracle Exadata Storage Expansion Rack X4-2 Full Rack, and Oracle Exadata Storage Expansion Rack X3-2 Full Rack
- [Table 19-4](#) ILOM Cabling for Oracle Exadata Storage Expansion Rack X4-2 Half Rack, and Oracle Exadata Storage Expansion Rack X3-2 Half Rack

- [Table 19-5](#) ILOM Cabling for Oracle Exadata Storage Expansion Rack X4-2 Quarter Rack, and Oracle Exadata Storage Expansion Rack X3-2 Quarter Rack
- [Table 19-6](#) ILOM Cabling for Oracle Exadata Storage Expansion Rack Full Rack with Storage Server with Sun Fire X4270 M2 Servers
- [Table 19-7](#) ILOM Cabling for Oracle Exadata Storage Expansion Rack Half Rack with Storage Server with Sun Fire X4270 M2 Servers
- [Table 19-8](#) ILOM Cabling for Oracle Exadata Storage Expansion Rack Quarter Rack with Storage Server with Sun Fire X4270 M2 Servers

The following table shows the cable connections from the servers to the ILOM switch in Oracle Exadata Storage Expansion Rack X6-2 and X7-2:

**Table 19-1 ILOM Cabling for Oracle Exadata Storage Expansion Rack X6-2, X7-2, X8-2, and X8M-2**

From Rack Unit	Type of Equipment	Gigabit Ethernet Port
U41	Storage Server	16
U39	Storage Server	2
U37	Storage Server	4
U35	Storage Server	6
U33	Storage Server	8
U31	Storage Server	10
U29	Storage Server	12
U27	Storage Server	14
U25	Storage Server	18
U23	Storage Server	22
U18	Storage Server	26
U16	Storage Server	30
U14	Storage Server	32
U12	Storage Server	34
U10	Storage Server	36
U8	Storage Server	38
U6	Storage Server	40
U4	Storage Server	42
U2	Storage Server	44
PDU-A	PDU	19
PDU-B	PDU	20

The following table shows the cable connections from the servers to the ILOM switch in Oracle Exadata Storage Expansion Rack X5-2:

**Table 19-2 ILOM Cabling for Oracle Exadata Storage Expansion Rack X5-2**

From Rack Unit	Type of Equipment	Gigabit Ethernet Port
U41	Storage Server	16
U39	Storage Server	2
U37	Storage Server	4
U35	Storage Server	6
U33	Storage Server	8
U31	Storage Server	10
U29	Storage Server	12
U27	Storage Server	14
U25	Storage Server	18
U23	Storage Server	22
U18	Storage Server	26
U16	Storage Server	30
U14	Storage Server	32
U12	Storage Server	34
U10	Storage Server	36
U8	Storage Server	38
U6	Storage Server	40
U4	Storage Server	42
U2	Storage Server	44

The following table shows the cable connections from the servers to the ILOM switch in Oracle Exadata Storage Expansion X4-2 Full Rack, and Oracle Exadata Storage Expansion X3-2 Full Rack:

**Table 19-3 ILOM Cabling for Oracle Exadata Storage Expansion Rack X4-2 Full Rack, and Oracle Exadata Storage Expansion Rack X3-2 Full Rack**

From Rack Unit	Type of Equipment	Gigabit Ethernet Port
U39	Storage Server	2
U37	Storage Server	4
U35	Storage Server	6
U33	Storage Server	8
U31	Storage Server	10
U29	Storage Server	12
U27	Storage Server	14
U25	Storage Server	18
U23	Storage Server	22
U18	Storage Server	26
U16	Storage Server	30

**Table 19-3 (Cont.) ILOM Cabling for Oracle Exadata Storage Expansion Rack X4-2 Full Rack, and Oracle Exadata Storage Expansion Rack X3-2 Full Rack**

From Rack Unit	Type of Equipment	Gigabit Ethernet Port
U14	Storage Server	32
U12	Storage Server	34
U10	Storage Server	36
U8	Storage Server	38
U6	Storage Server	40
U4	Storage Server	42
U2	Storage Server	44

The following table shows the cable connections from the servers to the ILOM switch in Oracle Exadata Storage Expansion Rack X4-2 Half Rack, and Oracle Exadata Storage Expansion Rack X3-2 Half Rack:

**Table 19-4 ILOM Cabling for Oracle Exadata Storage Expansion Rack X4-2 Half Rack, and Oracle Exadata Storage Expansion Rack X3-2 Half Rack**

From Rack Unit	Type of Equipment	Gigabit Ethernet Port
U18	Storage Server	26
U16	Storage Server	30
U14	Storage Server	32
U12	Storage Server	34
U10	Storage Server	36
U8	Storage Server	38
U6	Storage Server	40
U4	Storage Server	42
U2	Storage Server	44

The following table shows the cable connections from the servers to the ILOM switch in Oracle Exadata Storage Expansion Rack X4-2 Quarter Rack, and Oracle Exadata Storage Expansion Rack X3-2 Quarter Rack:

**Table 19-5 ILOM Cabling for Oracle Exadata Storage Expansion Rack X4-2 Quarter Rack, and Oracle Exadata Storage Expansion Rack X3-2 Quarter Rack**

From Rack Unit	Type of Equipment	Gigabit Ethernet Port
U8	Storage Server	38
U6	Storage Server	40
U4	Storage Server	42
U2	Storage Server	44

The following table shows the cable connections from the servers to the ILOM switch in Oracle Exadata Storage Expansion Rack Full Rack with Exadata Storage Server with Sun Fire X4270 M2 Servers:

**Table 19-6 ILOM Cabling for Oracle Exadata Storage Expansion Rack Full Rack with Exadata Storage Server with Sun Fire X4270 M2 Servers**

From Rack Unit	Type of Equipment	Gigabit Ethernet Port
U41	Storage Server	2
U39	Storage Server	4
U37	Storage Server	6
U35	Storage Server	8
U33	Storage Server	10
U31	Storage Server	12
U29	Storage Server	14
U27	Storage Server	18
U25	Storage Server	22
U18	Storage Server	26
U16	Storage Server	30
U14	Storage Server	32
U12	Storage Server	34
U10	Storage Server	36
U8	Storage Server	38
U6	Storage Server	40
U4	Storage Server	42
U2	Storage Server	44

The following table shows the cable connections from the servers to the ILOM switch in Oracle Exadata Storage Expansion Rack Half Rack with Exadata Storage Server with Sun Fire X4270 M2 Servers:

**Table 19-7 ILOM Cabling for Oracle Exadata Storage Expansion Rack Half Rack with Exadata Storage Server with Sun Fire X4270 M2 Servers**

From Rack Unit	Type of Equipment	Gigabit Ethernet Port
U18	Storage Server	26
U16	Storage Server	30
U14	Storage Server	32
U12	Storage Server	34
U10	Storage Server	36
U8	Storage Server	38
U6	Storage Server	40
U4	Storage Server	42
U2	Storage Server	44

The following table shows the cable connections from the servers to the ILOM switch in Oracle Exadata Storage Expansion Rack Quarter Rack with Exadata Storage Server with Sun Fire X4270 M2 Servers:

**Table 19-8 ILOM Cabling for Oracle Exadata Storage Expansion Rack Quarter Rack with Exadata Storage Server with Sun Fire X4270 M2 Servers**

From Rack Unit	Type of Equipment	Gigabit Ethernet Port
U8	Storage Server	38
U6	Storage Server	40
U4	Storage Server	42
U2	Storage Server	44

## 19.3 Administrative Network Cabling Tables

These tables show the Administrative network cabling for the Oracle Exadata Storage Expansion Racks.

The port on the storage servers is labeled NET0, and connects to the Management Network Switch located in rack unit 21 on Oracle Exadata Storage Expansion Racks.

- [Table 19-9](#) Administrative Network Cabling for Oracle Exadata Storage Expansion Rack X6-2, X7-2, X8-2, and X8M-2
- [Table 19-10](#) Administrative Network Cabling for Oracle Exadata Storage Expansion Rack X5-2
- [Table 19-11](#) Administrative Network Cabling for Oracle Exadata Storage Expansion Rack X4-2 Full Rack, and Oracle Exadata Storage Expansion Rack X3-2 Full Rack
- [Table 19-12](#) Administrative Network Cabling for Oracle Exadata Storage Expansion Rack X4-2 Half Rack, and Oracle Exadata Storage Expansion Rack X3-2 Half Rack
- [Table 19-13](#) Administrative Network Cabling for Oracle Exadata Storage Expansion Rack X4-2 Quarter Rack, and Oracle Exadata Storage Expansion Rack X3-2 Quarter Rack
- [Table 19-14](#) Administrative Network Cabling for Oracle Exadata Storage Expansion Rack Full Rack with Exadata Storage Server with Sun Fire X4270 M2 Servers
- [Table 19-15](#) Administrative Network Cabling for Oracle Exadata Storage Expansion Rack Half Rack with Exadata Storage Server with Sun Fire X4270 M2 Servers
- [Table 19-16](#) Administrative Network Cabling for Oracle Exadata Storage Expansion Rack Quarter Rack with Exadata Storage Server with Sun Fire X4270 M2 Servers

The following table shows the cable connections from the rack components to the Management Network Switch in Oracle Exadata Storage Expansion Rack X6-2, X7-2, X8-2, and X8M-2

**Table 19-9 Administrative Network Cabling for Oracle Exadata Storage Expansion Rack X6-2, X7-2, X8-2, and X8M-2**

From Rack Unit	Type of Equipment	Management Network Switch Port
U41	Storage Server	15

**Table 19-9 (Cont.) Administrative Network Cabling for Oracle Exadata Storage Expansion Rack X6-2, X7-2, X8-2, and X8M-2**

From Rack Unit	Type of Equipment	Management Network Switch Port
U39	Storage Server	1
U37	Storage Server	3
U35	Storage Server	5
U33	Storage Server	7
U31	Storage Server	9
U29	Storage Server	11
U27	Storage Server	13
U25	Storage Server	17
U23	Storage Server	21
U22	RDMA Network Fabric leaf switch	45
U20	RDMA Network Fabric leaf switch	46
U18	Storage Server	25
U16	Storage Server	29
U14	Storage Server	31
U12	Storage Server	33
U10	Storage Server	35
U8	Storage Server	37
U6	Storage Server	39
U4	Storage Server	41
U2	Storage Server	43
U1	RDMA Network Fabric spine switch	47

The following table shows the cable connections from the rack components to the Management Network Switch in Oracle Exadata Storage Expansion Rack X5-2

**Table 19-10 Administrative Network Cabling for Oracle Exadata Storage Expansion Rack X5-2**

From Rack Unit	Type of Equipment	Management Network Switch Port
U41	Storage Server	15
U39	Storage Server	1
U37	Storage Server	3
U35	Storage Server	5
U33	Storage Server	7



**Table 19-10 (Cont.) Administrative Network Cabling for Oracle Exadata Storage Expansion Rack X5-2**

From Rack Unit	Type of Equipment	Management Network Switch Port
U31	Storage Server	9
U29	Storage Server	11
U27	Storage Server	13
U25	Storage Server	17
U23	Storage Server	21
U22	RDMA Network Fabric leaf switch	45
U20	RDMA Network Fabric leaf switch	46
U18	Storage Server	25
U16	Storage Server	29
U14	Storage Server	31
U12	Storage Server	33
U10	Storage Server	35
U8	Storage Server	37
U6	Storage Server	39
U4	Storage Server	41
U2	Storage Server	43
U1	RDMA Network Fabric spine switch	47
PDU-A	PDU	19
PDU-B	PDU	20

The following table shows the cable connections from the rack components to the Management Network Switch in Oracle Exadata Storage Expansion Rack X4-2 Full Rack, and Oracle Exadata Storage Expansion Rack X3-2 Full Rack:

**Table 19-11 Administrative Network Cabling for Oracle Exadata Storage Expansion Rack X4-2 Full Rack, and Oracle Exadata Storage Expansion Rack X3-2 Full Rack**

From Rack Unit	Type of Equipment	Management Network Switch Port
U39	Storage Server	1
U37	Storage Server	3
U35	Storage Server	5
U33	Storage Server	7
U31	Storage Server	9
U29	Storage Server	11

**Table 19-11 (Cont.) Administrative Network Cabling for Oracle Exadata Storage Expansion Rack X4-2 Full Rack, and Oracle Exadata Storage Expansion Rack X3-2 Full Rack**

From Rack Unit	Type of Equipment	Management Network Switch Port
U27	Storage Server	13
U25	Storage Server	17
U23	Storage Server	21
U24	RDMA Network Fabric leaf switch	45
U20	RDMA Network Fabric leaf switch	46
U18	Storage Server	25
U16	Storage Server	29
U14	Storage Server	31
U12	Storage Server	33
U10	Storage Server	35
U8	Storage Server	37
U6	Storage Server	39
U4	Storage Server	41
U2	Storage Server	43
U1	RDMA Network Fabric spine switch	47
PDU-A	PDU	16
PDU-B	PDU	20

The following table shows the cable connections from the rack components to the Management Network Switch in Oracle Exadata Storage Expansion Rack X4-2 Half Rack, and Oracle Exadata Storage Expansion Rack X3-2 Half Rack:

**Table 19-12 Administrative Network Cabling for Oracle Exadata Storage Expansion Rack X4-2 Half Rack, and Oracle Exadata Storage Expansion Rack X3-2 Half Rack**

From Rack Unit	Type of Equipment	Management Network Switch Port
U22	RDMA Network Fabric leaf switch	45
U20	RDMA Network Fabric leaf switch	46
U18	Storage Server	25
U16	Storage Server	29
U14	Storage Server	31
U12	Storage Server	33

**Table 19-12 (Cont.) Administrative Network Cabling for Oracle Exadata Storage Expansion Rack X4-2 Half Rack, and Oracle Exadata Storage Expansion Rack X3-2 Half Rack**

From Rack Unit	Type of Equipment	Management Network Switch Port
U10	Storage Server	35
U8	Storage Server	37
U6	Storage Server	39
U4	Storage Server	41
U2	Storage Server	43
U1	RDMA Network Fabric spine switch	47
PDU-A	PDU	16
PDU-B	PDU	20

The following table shows the cable connections from the rack components to the Management Network Switch in Oracle Exadata Storage Expansion Rack X4-2 Quarter Rack, and Oracle Exadata Storage Expansion Rack X3-2 Quarter Rack:

**Table 19-13 Administrative Network Cabling for Oracle Exadata Storage Expansion Rack X4-2 Quarter Rack, and Oracle Exadata Storage Expansion Rack X3-2 Quarter Rack**

From Rack Unit	Type of Equipment	Management Network Switch Port
U22	RDMA Network Fabric leaf switch	45
U20	RDMA Network Fabric leaf switch	46
U8	Storage Server	37
U6	Storage Server	39
U4	Storage Server	41
U2	Exadata Storage Server	43
PDU-A	PDU	16
PDU-B	PDU	20

The following table shows the cable connections from the rack components to the Management Network Switch in Oracle Exadata Storage Expansion Full Rack with Exadata Storage Server with Sun Fire X4270 M2 Servers:

**Table 19-14 Administrative Network Cabling for Oracle Exadata Storage Expansion Full Rack with Exadata Storage Server with Sun Fire X4270 M2 Servers**

From Rack Unit	Type of Equipment	Management Network Switch Port
U41	Storage Server	1
U39	Storage Server	3
U37	Storage Server	5
U35	Storage Server	7
U33	Storage Server	9
U31	Storage Server	11
U29	Storage Server	13
U27	Storage Server	17
U25	Storage Server	21
U24	RDMA Network Fabric leaf switch	45
U20	RDMA Network Fabric leaf switch	46
U18	Storage Server	25
U16	Storage Server	29
U14	Storage Server	31
U12	Storage Server	33
U10	Storage Server	35
U8	Storage Server	37
U6	Storage Server	39
U4	Storage Server	41
U2	Storage Server	43
U1	RDMA Network Fabric spine switch	47
PDU-A	PDU	16
PDU-B	PDU	20

The following table shows the cable connections from the rack components to the Management Network Switch in Oracle Exadata Storage Expansion Half Rack with Exadata Storage Server with Sun Fire X4270 M2 Servers:

**Table 19-15 Administrative Network Cabling for Oracle Exadata Storage Expansion Half Rack with Exadata Storage Server with Sun Fire X4270 M2 Servers**

From Rack Unit	Type of Equipment	Management Network Switch Port
U24	RDMA Network Fabric leaf switch	45
U20	RDMA Network Fabric leaf switch	46
U18	Storage Server	25
U16	Storage Server	29
U14	Storage Server	31
U12	Storage Server	33
U10	Storage Server	35
U8	Storage Server	37
U6	Storage Server	39
U4	Storage Server	41
U2	Storage Server	43
U1	RDMA Network Fabric spine switch	47
PDU-A	PDU	16
PDU-B	PDU	20

The following table shows the cable connections from the rack components to the Management Network Switch in Oracle Exadata Storage Expansion Quarter Rack with Exadata Storage Server with Sun Fire X4270 M2 Servers:

**Table 19-16 Administrative Network Cabling for Oracle Exadata Storage Expansion Quarter Rack with Exadata Storage Server with Sun Fire X4270 M2 Servers**

From Rack Unit	Type of Equipment	Management Network Switch Port
U24	RDMA Network Fabric leaf switch	45
U20	RDMA Network Fabric leaf switch	46
U8	Storage Server	37
U6	Storage Server	39
U4	Storage Server	41
U2	Storage Server	43
PDU-A	PDU	16
PDU-B	PDU	20

## 19.4 Single Phase Power Distribution Unit Cabling Tables

These tables show the cabling routes from each single-phase power distribution unit (PDU) to the power supplies configured in each Oracle Exadata Storage Expansion Rack.

The cables are terminated to PDU-A on the left (when looking at the rear of the rack), and routed to the right to enter cable management arm (CMA). The cables are bundled in groups of four. The PDU connections list the group and outlet on the PDU. So, for example, G5-5 refers to group 5 outlet 5.

- [Table 19-17](#) Single Phase PDU Cabling for Oracle Exadata Storage Expansion Rack X8M-2
- [Table 19-18](#) Single Phase PDU Cabling for Oracle Exadata Storage Expansion Rack X8-2
- [Single Phase PDU Cabling for Oracle Exadata Storage Expansion Rack X7-2](#)  
Single Phase PDU Cabling for Oracle Exadata Storage Expansion Rack X7-2
- [Table 19-20](#) Single Phase PDU Cabling for Oracle Exadata Storage Expansion Rack X6-2
- [Table 19-21](#) Single Phase PDU Cabling for Oracle Exadata Storage Expansion Rack X5-2
- [Table 19-22](#) Single Phase PDU Cabling for Oracle Exadata Storage Expansion X4-2 Full Rack, and Oracle Exadata Storage Expansion X3-2 Full Rack
- [Table 19-23](#) Single Phase PDU Cabling for Oracle Exadata Storage Expansion X4-2 Half Rack, and Oracle Exadata Storage Expansion X3-2 Half Rack
- [Table 19-24](#) Single Phase PDU Cabling for Oracle Exadata Storage Expansion X4-2 Quarter Rack, and Oracle Exadata Storage Expansion X3-2 Quarter Rack
- [Table 19-25](#) Single Phase PDU Cabling for Oracle Exadata Storage Expansion Full Rack with Exadata Storage Server with Sun Fire X4270 M2 Servers
- [Table 19-26](#) Single Phase PDU Cabling for Oracle Exadata Storage Expansion Half Rack with Exadata Storage Server with Sun Fire X4270 M2 Servers
- [Table 19-27](#) Single Phase PDU Cabling for Oracle Exadata Storage Expansion Quarter Rack with Exadata Storage Server with Sun Fire X4270 M2 Servers

The following table shows the cable connections from the PDUs to the rack units in Oracle Exadata Storage Expansion Rack X8M-2.

**Table 19-17 Single Phase PDU Cabling for Oracle Exadata Storage Expansion Rack X8M-2**

Rack Unit	PS	PDU-A	PDU-B/PS1	Cable Length
U42	PS0	G5-3	G0-3	2 meters
U41	PS0	G5-5	G0-1	2 meters
U40	PS0	G5-6	G0-0	2 meters
U39	PS0	G3-6	G2-0	2 meters
U37	PS0	G3-0	G2-6	2 meters

**Table 19-17 (Cont.) Single Phase PDU Cabling for Oracle Exadata Storage Expansion Rack X8M-2**

Rack Unit	PS	PDU-A	PDU-B/PS1	Cable Length
U35	PS0	G5-4	G0-2	2 meters
U33	PS0	G4-1	G1-5	2 meters
U31	PS0	G5-2	G0-4	2 meters
U29	PS0	G5-1	G0-5	2 meters
U27	PS0	G4-3	G1-3	2 meters
U26	PS0	G4-6	G1-0	2 meters
U25	PS0	G4-5	G1-1	2 meters
U24	PS0	G4-2	G1-4	2 meters
U23	PS0	G4-0	G1-6	2 meters
U22	PS2	G1-6	G4-0	2 meters
U21	PS2	G1-5	G4-1	2 meters
U20	PS2	G1-2	G4-4	2 meters
U19	PS0	G3-2	G2-4	2 meters
U18	PS0	G2-6	G3-0	2 meters
U17	PS0	G0-6	G5-0	2 meters
U16	PS0	G0-3	G5-3	2 meters
U14	PS0	G2-3	G3-3	2 meters
U12	PS0	G2-4	G3-2	2 meters
U10	PS0	G2-0	G3-6	2 meters
U8	PS0	G2-5	G3-1	2 meters
U6	PS0	G0-0	G5-6	2 meters
U4	PS0	G0-1	G5-5	2 meters
U2	PS0	G1-0	G4-6	2 meters
U1	PS2	G3-5	G2-1	3 meters

The following table shows the cable connections from the PDUs to the rack units in Oracle Exadata Storage Expansion Rack X8-2.

**Table 19-18 Single Phase PDU Cabling for Oracle Exadata Storage Expansion Rack X8-2**

Rack Unit	PDU-A/PSU 0	PDU-B/PSU 1	Cable Length
U42	G3-5	G2-1	2 meters
U41	G5-5	G0-1	2 meters
U40	G3-3	G2-3	2 meters
U39	G5-4	G0-2	2 meters
U37	G5-3	G0-3	2 meters
U35	G5-2	G0-4	2 meters

**Table 19-18 (Cont.) Single Phase PDU Cabling for Oracle Exadata Storage Expansion Rack X8-2**

Rack Unit	PDU-A/PSU 0	PDU-B/PSU 1	Cable Length
U33	G4-4	G1-2	2 meters
U31	G4-3	G1-3	2 meters
U29	G4-2	G1-4	2 meters
U27	G3-0	G2-6	2 meters
U26	G5-1	G0-5	2 meters
U25	G5-0	G0-6	2 meters
U24	G4-1	G1-5	2 meters
U23	G3-6	G2-0	2 meters
U22	G1-2	G4-4	2 meters
U21	G0-5	G5-1	2 meters
U20	G0-4	G5-2	2 meters
U19	G2-4	G3-2	2 meters
U18	G1-1	G4-5	2 meters
U17	G0-3	G5-3	2 meters
U16	G0-2	G5-4	2 meters
U14	G2-3	G3-3	2 meters
U12	G2-2	G3-4	2 meters
U10	G2-1	G3-5	2 meters
U8	G2-0	G3-6	2 meters
U6	G1-0	G4-6	2 meters
U4	G0-1	G5-5	2 meters
U2	G0-0	G5-6	2 meters
U1	G4-0	G1-6	3 meters

The following table shows the cable connections from the PDUs to the rack units in Oracle Exadata Storage Expansion Rack X7-2.

**Table 19-19 Single Phase PDU Cabling for Oracle Exadata Storage Expansion Rack X7-2**

Rack Unit	PDU-A/PSU 0	PDU-B/PSU 1	Cable Length
U42	G5-5	G0-1	2 meters
U41	G3-6	G2-0	2 meters
U40	G5-2	G0-4	2 meters
U39	G5-6	G0-0	2 meters
U37	G5-3	G0-3	2 meters
U35	G5-1	G0-5	2 meters
U33	G5-0	G0-6	2 meters



**Table 19-19 (Cont.) Single Phase PDU Cabling for Oracle Exadata Storage Expansion Rack X7-2**

Rack Unit	PDU-A/PSU 0	PDU-B/PSU 1	Cable Length
U31	G4-4	G1-2	2 meters
U29	G4-3	G1-3	2 meters
U27	G3-5	G2-1	2 meters
U26	G4-5	G1-1	2 meters
U25	G4-2	G1-4	2 meters
U24	G4-1	G1-5	2 meters
U23	G2-5	G3-1	2 meters
U22	G1-4	G4-2	2 meters
U21	G1-3	G4-3	2 meters
U20	G1-5	G4-1	2 meters
U19	G2-3	G3-3	2 meters
U18	G2-2	G3-4	2 meters
U17	G1-6	G4-0	2 meters
U16	G1-2	G4-4	2 meters
U14	G2-4	G3-2	2 meters
U12	G2-1	G3-5	2 meters
U10	G2-0	G3-6	2 meters
U8	G1-0	G4-6	2 meters
U6	G0-6	G5-0	2 meters
U4	G0-4	G5-2	2 meters
U2	G0-2	G5-4	2 meters
U1	G4-0	G1-6	3 meters

The following table shows the cable connections from the PDUs to the rack units in Oracle Exadata Storage Expansion Rack X6-2.

**Table 19-20 Single Phase PDU Cabling for Oracle Exadata Storage Expansion Rack X6-2**

Rack Unit	PDU-A/PS-00	PDU-B/PS-01	Cable Length
U42	G3-6	G2-0	2 meters
U41	G4-5	G1-1	2 meters
U40	G5-4	G0-2	2 meters
U39	G5-6	G0-0	2 meters
U37	G5-3	G0-3	2 meters
U35	G5-0	G0-6	2 meters
U33	G4-6	G1-0	2 meters
U31	G4-4	G1-2	2 meters

**Table 19-20 (Cont.) Single Phase PDU Cabling for Oracle Exadata Storage Expansion Rack X6-2**

Rack Unit	PDU-A/PS-00	PDU-B/PS-01	Cable Length
U29	G4-2	G1-4	2 meters
U27	G3-6	G2-0	2 meters
U25	G3-5	G2-1	2 meters
U23	G3-3	G2-3	2 meters
U22	G3-1	G2-5	2 meter
U21	G3-0	G2-6	2 meters
U20	G2-4	G3-2	2 meters
U18	G2-2	G3-4	2 meters
U16	G1-6	G4-0	2 meters
U14	G2-0	G3-6	2 meters
U12	G1-4	G4-2	2 meters
U10	G1-2	G4-4	2 meters
U8	G1-0	G4-6	2 meters
U6	G0-6	G5-0	2 meters
U4	G0-4	G5-2	2 meters
U2	G0-2	G5-4	2 meters
U1	G0-0	G5-6	2 meters

The following table shows the cable connections from the PDUs to the rack units in Oracle Exadata Storage Expansion Rack X5-2.

**Table 19-21 Single Phase PDU Cabling for Oracle Exadata Storage Expansion Rack X5-2**

Rack Unit	PDU-A/PS-00	PDU-B/PS-01	Cable Length
U41	G4-5	G1-1	2 meters
U39	G5-6	G0-0	2 meters
U37	G5-3	G0-3	2 meters
U35	G5-0	G0-6	2 meters
U33	G4-6	G1-0	2 meters
U31	G4-4	G1-2	2 meters
U29	G4-2	G1-4	2 meters
U27	G3-6	G2-0	2 meters
U25	G3-5	G2-1	2 meters
U23	G3-3	G2-3	2 meters
U22	G3-1	G2-5	2 meter
U21	G3-0	G2-6	2 meters
U20	G2-4	G3-2	2 meters

**Table 19-21 (Cont.) Single Phase PDU Cabling for Oracle Exadata Storage Expansion Rack X5-2**

Rack Unit	PDU-A/PS-00	PDU-B/PS-01	Cable Length
U18	G2-2	G3-4	2 meters
U16	G1-6	G4-0	2 meters
U14	G2-0	G3-6	2 meters
U12	G1-4	G4-2	2 meters
U10	G1-2	G4-4	2 meters
U8	G1-0	G4-6	2 meters
U6	G0-6	G5-0	2 meters
U4	G0-4	G5-2	2 meters
U2	G0-2	G5-4	2 meters
U1	G0-0	G5-6	2 meters

The following table shows the cable connections from the PDUs to the rack units in Oracle Exadata Storage Expansion X4-2 Full Rack, and Oracle Exadata Storage Expansion X3-2 Full Rack.

**Table 19-22 Single Phase PDU Cabling for Oracle Exadata Storage Expansion X4-2 Full Rack, and Oracle Exadata Storage Expansion X3-2 Full Rack**

Rack Unit	PDU-A/PS-00	PDU-B/PS-01	Cable Length
U39	G5-6	G0-0	2 meters
U37	G5-3	G0-3	2 meters
U35	G5-0	G0-6	2 meters
U33	G4-6	G1-0	2 meters
U31	G4-4	G1-2	2 meters
U29	G4-2	G1-4	2 meters
U27	G3-6	G2-0	2 meters
U25	G3-5	G2-1	2 meters
U23	G3-3	G2-3	2 meters
U22	G3-1	G2-5	2 meter
U21	G3-0	G2-6	2 meters
U20	G2-4	G3-2	2 meters
U18	G2-2	G3-4	2 meters
U16	G1-6	G4-0	2 meters
U14	G2-0	G3-6	2 meters
U12	G1-4	G4-2	2 meters
U10	G1-2	G4-4	2 meters
U8	G1-0	G4-6	2 meters
U6	G0-6	G5-0	2 meters

**Table 19-22 (Cont.) Single Phase PDU Cabling for Oracle Exadata Storage Expansion X4-2 Full Rack, and Oracle Exadata Storage Expansion X3-2 Full Rack**

Rack Unit	PDU-A/PS-00	PDU-B/PS-01	Cable Length
U4	G0-4	G5-2	2 meters
U2	G0-2	G5-4	2 meters
U1	G0-0	G5-6	2 meters

The following table shows the cable connections from the PDUs to the rack units in Oracle Exadata Storage Expansion X4-2 Half Rack, and Oracle Exadata Storage Expansion X3-2 Half Rack.

**Table 19-23 Single Phase PDU Cabling for Oracle Exadata Storage Expansion X4-2 Half Rack, and Oracle Exadata Storage Expansion X3-2 Half Rack**

Rack Unit	PDU-A/PS-00	PDU-B/PS-01	Cable Length
U22	G3-1	G2-5	2 meter
U21	G3-0	G2-6	2 meters
U20	G2-4	G3-2	2 meters
U18	G2-2	G3-4	2 meters
U16	G1-6	G4-0	2 meters
U14	G2-0	G3-6	2 meters
U12	G1-4	G4-2	2 meters
U10	G1-2	G4-4	2 meters
U8	G1-0	G4-6	2 meters
U6	G0-6	G5-0	2 meters
U4	G0-4	G5-2	2 meters
U2	G0-2	G5-4	2 meters
U1	G0-0	G5-6	2 meters

The following table shows the cable connections from the PDUs to the rack units in Oracle Exadata Storage Expansion X4-2 Quarter Rack, and Oracle Exadata Storage Expansion X3-2 Quarter Rack.

**Table 19-24 Single Phase PDU Cabling for Oracle Exadata Storage Expansion X4-2 Quarter Rack, and Oracle Exadata Storage Expansion X3-2 Quarter Rack**

Rack Unit	PDU-A/PS-00	PDU-B/PS-01	Cable Length
U22	G3-1	G2-5	2 meters
U21	G3-0	G2-6	2 meters
U20	G2-4	G3-2	2 meters
U8	G1-0	G4-6	2 meters
U6	G0-6	G5-0	2 meters
U4	G0-4	G5-2	2 meters

**Table 19-24 (Cont.) Single Phase PDU Cabling for Oracle Exadata Storage Expansion X4-2 Quarter Rack, and Oracle Exadata Storage Expansion X3-2 Quarter Rack**

Rack Unit	PDU-A/PS-00	PDU-B/PS-01	Cable Length
U2	G0-2	G5-4	2 meters
U1	G0-0	G5-6	2 meters

The following table shows the cable connections from the PDUs to the rack units in Oracle Exadata Storage Expansion Full Rack with Exadata Storage Server with Sun Fire X4270 M2 Servers.

**Table 19-25 Single Phase PDU Cabling for Oracle Exadata Storage Expansion Full Rack with Exadata Storage Server with Sun Fire X4270 M2 Servers**

Rack Unit	PDU-A/PS-00	PDU-B/PS-01	Cable Length
U41	G5-6	G0-0	2 meters
U39	G5-3	G0-3	2 meters
U37	G5-0	G0-6	2 meters
U35	G4-6	G1-0	2 meters
U33	G4-4	G1-2	2 meters
U31	G4-2	G1-4	2 meters
U29	G3-6	G2-0	2 meters
U27	G3-5	G2-1	2 meters
U25	G3-3	G2-3	2 meters
U24	G3-1	G2-5	2 meters
U23	N/A	G3-0	included
U22	G3-1	G2-5	2 meter
U21	G3-0	G2-6	2 meters
U20	G2-4	G3-2	2 meters
U18	G2-2	G3-4	2 meters
U16	G1-6	G4-0	2 meters
U14	G2-0	G3-6	2 meters
U12	G1-4	G4-2	2 meters
U10	G1-2	G4-4	2 meters
U8	G1-0	G4-6	2 meters
U6	G0-6	G5-0	2 meters
U4	G0-4	G5-2	2 meters
U2	G0-2	G5-4	2 meters
U1	G0-0	G5-6	2 meters

The following table shows the cable connections from the PDUs to the rack units in Oracle Exadata Storage Expansion Half Rack with Exadata Storage Server with Sun Fire X4270 M2 Servers.

**Table 19-26 Single Phase PDU Cabling for Oracle Exadata Storage Expansion Half Rack with Exadata Storage Server with Sun Fire X4270 M2 Servers**

Rack Unit	PDU-A/PS-00	PDU-B/PS-01	Cable Length
U22	G3-1	G2-5	2 meter
U21	G3-0	G2-6	2 meters
U20	G2-4	G3-2	2 meters
U18	G2-2	G3-4	2 meters
U16	G1-6	G4-0	2 meters
U14	G2-0	G3-6	2 meters
U12	G1-4	G4-2	2 meters
U10	G1-2	G4-4	2 meters
U8	G1-0	G4-6	2 meters
U6	G0-6	G5-0	2 meters
U4	G0-4	G5-2	2 meters
U2	G0-2	G5-4	2 meters

The following table shows the cable connections from the PDUs to the rack units in Oracle Exadata Storage Expansion Quarter Rack with Exadata Storage Server with Sun Fire X4270 M2 Servers.

**Table 19-27 Single Phase PDU Cabling for Oracle Exadata Storage Expansion Quarter Rack with Exadata Storage Server with Sun Fire X4270 M2 Servers**

Rack Unit	PDU-A/PS-00	PDU-B/PS-01	Cable Length
U22	G3-1	G2-5	2 meters
U21	G3-0	G2-6	2 meters
U20	G2-4	G3-2	2 meters
U8	G1-0	G4-6	2 meters
U6	G0-6	G5-0	2 meters
U4	G0-4	G5-2	2 meters
U2	G0-2	G5-4	2 meters

## 19.5 Three Phase Power Distribution Unit Cabling Tables

These tables show the cabling routes from each three-phase power distribution unit (PDU) to the power supplies configured in each Oracle Exadata Storage Expansion Rack.

The cables are terminated to PDU-A on the left (when looking at the rear of the rack), and routed to the right to enter cable management arm (CMA). The cables are

bundled in groups of four. The PDU connections list the group and outlet on the PDU. So, for example, G5-5 refers to group 5 outlet 5.

The following tables are in this section:

- [Table 19-28](#) Three Phase PDU Cabling for Oracle Exadata Storage Expansion Rack X8M-2
- [Table 19-29](#) Three Phase PDU Cabling for Oracle Exadata Storage Expansion Rack X8-2
- [Table 19-30](#) Three Phase PDU Cabling for Oracle Exadata Storage Expansion Rack X7-2
- [Table 19-31](#) Three Phase PDU Cabling for Oracle Exadata Storage Expansion Rack X6-2
- [Table 19-32](#) Three Phase PDU Cabling for Oracle Exadata Storage Expansion Rack X5-2
- [Table 19-33](#) Three Phase PDU Cabling for Oracle Exadata Storage Expansion X4-2 Full Rack, and Oracle Exadata Storage Expansion X3-2 Full Rack
- [Table 19-34](#) Three Phase PDU Cabling for Oracle Exadata Storage Expansion X4-2 Half Rack, and Oracle Exadata Storage Expansion X3-2 Half Rack
- [Table 19-35](#) Three Phase PDU Cabling for Oracle Exadata Storage Expansion X4-2 Quarter Rack, and Oracle Exadata Storage Expansion X3-2 Quarter Rack
- [Table 19-36](#) Three Phase PDU Cabling for Oracle Exadata Storage Expansion Rack with Exadata Storage Server with Sun Fire X4270 M2 Servers
- [Table 19-37](#) Three Phase PDU Cabling for Oracle Exadata Storage Expansion Half Rack with Exadata Storage Server with Sun Fire X4270 M2 Servers
- [Table 19-38](#) Three Phase PDU Cabling for Oracle Exadata Storage Expansion Quarter Rack with Exadata Storage Server with Sun Fire X4270 M2 Servers

The following table shows the cable connections from the PDUs to the rack units in Oracle Exadata Storage Expansion Rack X8M-2.

**Table 19-28 Three Phase PDU Cabling for Oracle Exadata Storage Expansion Rack X8M-2**

Rack Unit	PDU-A/PSU 0	PDU-B/PSU 1	Cable Length
U42	G5-4	G2-2	2 meters
U41	G5-2	G2-4	2 meters
U40	G5-1	G2-5	2 meters
U39	G5-6	G2-0	2 meters
U37	G3-5	G0-1	2 meters
U35	G3-0	G0-6	2 meters
U33	G5-5	G2-1	2 meters
U31	G5-3	G2-3	2 meters
U29	G4-2	G1-4	2 meters
U27	G3-2	G0-4	2 meters
U26	G5-0	G2-6	2 meters
U25	G4-5	G1-1	2 meters
U24	G3-1	G0-5	2 meters

**Table 19-28 (Cont.) Three Phase PDU Cabling for Oracle Exadata Storage Expansion Rack X8M-2**

Rack Unit	PDU-A/PSU 0	PDU-B/PSU 1	Cable Length
U23	G4-1	G1-5	2 meters
U22	G1-6	G4-0	2 meters
U21	G2-6	G5-0	2 meters
U20	G1-5	G4-1	2 meters
U19	G1-1	G4-5	2 meters
U18	G1-4	G4-2	2 meters
U17	G2-1	G5-5	2 meters
U16	G2-3	G5-3	2 meters
U14	G0-5	G3-1	2 meters
U12	G2-5	G5-1	2 meters
U10	G0-3	G3-3	2 meters
U8	G1-3	G4-3	2 meters
U6	G2-4	G5-2	2 meters
U4	G0-6	G3-0	2 meters
U2	G0-0	G3-6	2 meters
U1	G1-0	G4-6	3 meters

The following table shows the cable connections from the PDUs to the rack units in Oracle Exadata Storage Expansion Rack X8-2.

**Table 19-29 Three Phase PDU Cabling for Oracle Exadata Storage Expansion Rack X8-2**

Rack Unit	PDU-A/PSU 0	PDU-B/PSU 1	Cable Length
U42	G5-6	G2-0	2 meters
U41	G5-3	G2-3	2 meters
U40	G3-5	G0-1	2 meters
U39	G4-3	G1-3	2 meters
U37	G5-2	G2-4	2 meters
U35	G3-2	G0-4	2 meters
U33	G4-2	G1-4	2 meters
U31	G5-1	G2-5	2 meters
U29	G3-6	G0-0	2 meters
U27	G4-1	G1-5	2 meters
U26	G3-1	G0-5	2 meters
U25	G4-0	G1-6	2 meters
U24	G3-0	G0-6	2 meters
U23	G2-6	G5-0	2 meters



**Table 19-29 (Cont.) Three Phase PDU Cabling for Oracle Exadata Storage Expansion Rack X8-2**

Rack Unit	PDU-A/PSU 0	PDU-B/PSU 1	Cable Length
U22	G1-5	G4-1	2 meters
U21	G2-4	G5-2	2 meters
U20	G1-4	G4-2	2 meters
U19	G0-6	G3-0	2 meters
U18	G2-3	G5-3	2 meters
U17	G0-2	G3-4	2 meters
U16	G0-1	G3-5	2 meters
U14	G1-3	G4-3	2 meters
U12	G1-2	G4-4	2 meters
U10	G1-1	G4-5	2 meters
U8	G2-2	G5-4	2 meters
U6	G0-0	G3-6	2 meters
U4	G2-1	G5-5	2 meters
U2	G2-0	G5-6	2 meters
U1	G1-0	G4-6	3 meters

The following table shows the cable connections from the PDUs to the rack units in Oracle Exadata Storage Expansion Rack X7-2.

**Table 19-30 Three Phase PDU Cabling for Oracle Exadata Storage Expansion Rack X7-2**

Rack Unit	PDU-A/PSU 0	PDU-B/PSU 1	Cable Length
U42	G5-4	G2-2	2 meters
U41	G5-6	G2-0	2 meters
U40	G4-6	G1-0	2 meters
U39	G4-5	G1-1	2 meters
U37	G3-5	G0-1	2 meters
U35	G5-5	G2-1	2 meters
U33	G4-3	G1-3	2 meters
U31	G3-1	G0-5	2 meters
U29	G4-0	G1-6	2 meters
U27	G5-3	G2-3	2 meters
U26	G5-1	G2-5	2 meters
U25	G3-3	G0-3	2 meters
U24	G4-4	G1-2	2 meters
U23	G3-2	G0-4	2 meters
U22	G2-6	G5-0	2 meter

**Table 19-30 (Cont.) Three Phase PDU Cabling for Oracle Exadata Storage Expansion Rack X7-2**

Rack Unit	PDU-A/PSU 0	PDU-B/PSU 1	Cable Length
U21	G1-0	G4-6	2 meters
U20	G0-0	G3-6	2 meters
U19	G2-5	G5-1	2 meters
U18	G0-6	G3-0	2 meters
U17	G1-6	G4-0	2 meters
U16	G2-1	G5-5	2 meters
U14	G1-4	G4-2	2 meters
U12	G2-3	G5-3	2 meters
U10	G2-0	G5-6	2 meters
U8	G1-2	G4-4	2 meters
U6	G1-1	G4-5	2 meters
U4	G0-2	G3-4	2 meters
U2	G0-1	G3-5	2 meters
U1	G2-2	G5-4	3 meters

The following table shows the cable connections from the PDUs to the rack units in Oracle Exadata Storage Expansion Rack X6-2.

**Table 19-31 Three Phase PDU Cabling for Oracle Exadata Storage Expansion Rack X6-2**

Rack Unit	PDU-A/PSU 0	PDU-B/PSU 1	Cable Length
U42	G5-4	G2-2	2 meters
U41	G5-5	G2-1	2 meters
U40	G3-6	G0-0	2 meters
U39	G5-6	G2-0	2 meters
U37	G5-3	G2-3	2 meters
U35	G5-0	G2-6	2 meters
U33	G5-2	G2-4	2 meters
U31	G4-4	G1-2	2 meters
U29	G4-2	G1-4	2 meters
U27	G4-1	G1-5	2 meters
U26	G5-1	G2-5	2 meters
U25	G3-5	G0-1	2 meters
U24	G3-4	G0-2	2 meters
U23	G3-3	G0-3	2 meters
U22	G3-2	G0-4	2 meter
U21	G3-0	G0-6	2 meters

**Table 19-31 (Cont.) Three Phase PDU Cabling for Oracle Exadata Storage Expansion Rack X6-2**

Rack Unit	PDU-A/PSU 0	PDU-B/PSU 1	Cable Length
U20	G2-4	G5-2	2 meters
U19	G2-3	G5-3	2 meters
U18	G2-2	G5-4	2 meters
U17	G2-1	G5-5	2 meters
U16	G1-6	G4-0	2 meters
U14	G1-5	G4-1	2 meters
U12	G1-4	G4-2	2 meters
U10	G1-2	G4-4	2 meters
U8	G1-0	G4-6	2 meters
U6	G0-6	G3-0	2 meters
U4	G0-4	G3-2	2 meters
U2	G0-2	G3-4	2 meters
U1	G0-0	G3-6	3 meters

The following table shows the cable connections from the PDUs to the rack units in Oracle Exadata Storage Expansion Rack X5-2.

**Table 19-32 Three Phase PDU Cabling for Oracle Exadata Storage Expansion Rack X5-2**

Rack Unit	PDU-A/PS-00	PDU-B/PS-01	Cable Length
U41	G4-5	G1-1	2 meters
U39	G5-6	G2-0	2 meters
U37	G5-3	G2-3	2 meters
U35	G5-0	G2-6	2 meters
U33	G4-6	G1-0	2 meters
U31	G4-4	G1-2	2 meters
U29	G4-2	G1-4	2 meters
U27	G3-6	G0-0	2 meters
U25	G3-5	G0-1	2 meters
U23	G3-3	G0-3	2 meters
U22	G2-5	G5-1	1 meter
U21	G3-0	G0-6	2 meters
U20	G2-4	G5-2	2 meters
U18	G2-2	G5-4	2 meters
U16	G1-6	G4-0	2 meters
U14	G2-0	G5-6	2 meters
U12	G1-4	G4-2	2 meters

**Table 19-32 (Cont.) Three Phase PDU Cabling for Oracle Exadata Storage Expansion Rack X5-2**

Rack Unit	PDU-A/PS-00	PDU-B/PS-01	Cable Length
U10	G1-2	G4-4	2 meters
U8	G1-0	G4-6	2 meters
U6	G0-6	G3-0	2 meters
U4	G0-4	G3-2	2 meters
U2	G0-2	G3-4	2 meters
U1	G0-0	G3-6	2 meters

The following table shows the cable connections from the PDUs to the rack units in Oracle Exadata Storage Expansion X4-2 Full Rack, and Oracle Exadata Storage Expansion X3-2 Full Rack.

**Table 19-33 Three Phase PDU Cabling for Oracle Exadata Storage Expansion X4-2 Full Rack, and Oracle Exadata Storage Expansion X3-2 Full Rack**

Rack Unit	PDU-A/PS-00	PDU-B/PS-01	Cable Length
U39	G5-6	G2-0	2 meters
U37	G5-3	G2-3	2 meters
U35	G5-0	G2-6	2 meters
U33	G4-6	G1-0	2 meters
U31	G4-4	G1-2	2 meters
U29	G4-2	G1-4	2 meters
U27	G3-6	G0-0	2 meters
U25	G3-5	G0-1	2 meters
U23	G3-3	G0-3	2 meters
U22	G2-5	G5-1	1 meter
U21	G3-0	G0-6	2 meters
U20	G2-4	G5-2	2 meters
U18	G2-2	G5-4	2 meters
U16	G1-6	G4-0	2 meters
U14	G2-0	G5-6	2 meters
U12	G1-4	G4-2	2 meters
U10	G1-2	G4-4	2 meters
U8	G1-0	G4-6	2 meters
U6	G0-6	G3-0	2 meters
U4	G0-4	G3-2	2 meters
U2	G0-2	G3-4	2 meters
U1	G0-0	G3-6	2 meters

The following table shows the cable connections from the PDUs to the rack units in Oracle Exadata Storage Expansion X4-2 Half Rack, and Oracle Exadata Storage Expansion X3-2 Half Rack.

**Table 19-34 Three Phase PDU Cabling for Oracle Exadata Storage Expansion X4-2 Half Rack, and Oracle Exadata Storage Expansion X3-2 Half Rack**

Rack Unit	PDU-A/PS-00	PDU-B/PS-01	Cable Length
U22	G3-1	G0-5	1 meter
U21	G3-0	G0-6	2 meters
U20	G2-4	G5-2	2 meters
U18	G2-2	G5-4	2 meters
U16	G1-6	G4-0	2 meters
U14	G2-0	G5-6	2 meters
U12	G1-4	G4-2	2 meters
U10	G1-2	G4-4	2 meters
U8	G1-0	G4-6	2 meters
U6	G0-6	G3-0	2 meters
U4	G0-4	G3-2	2 meters
U2	G0-2	G3-4	2 meters
U1	G0-0	G3-6	2 meters

The following table shows the cable connections from the PDUs to the rack units in Oracle Exadata Storage Expansion X4-2 Quarter Rack, and Oracle Exadata Storage Expansion X3-2 Quarter Rack.

**Table 19-35 Three Phase PDU Cabling for Oracle Exadata Storage Expansion X4-2 Quarter Rack, and Oracle Exadata Storage Expansion X3-2 Quarter Rack**

Rack Unit	PDU-A/PS-00	PDU-B/PS-01	Cable Length
U22	G3-1	G0-5	1 meter
U21	G3-0	G0-6	2 meters
U20	G2-4	G5-2	2 meters
U8	G1-0	G4-6	2 meters
U6	G0-6	G3-0	2 meters
U4	G0-4	G3-2	2 meters
U2	G0-2	G3-4	2 meters
U1	G0-0	G3-6	2 meters

The following table shows the cable connections from the PDUs to the rack units in Oracle Exadata Storage Expansion Full Rack with Exadata Storage Server with Sun Fire X4270 M2 Servers.

**Table 19-36 Three Phase PDU Cabling for Oracle Exadata Storage Expansion Rack with Exadata Storage Server with Sun Fire X4270 M2 Servers**

Rack Unit	PDU-A/PS-00	PDU-B/PS-01	Cable Length
U41	G5-6	G2-0	2 meters
U39	G5-3	G2-3	2 meters
U37	G5-0	G2-6	2 meters
U35	G4-6	G1-0	2 meters
U33	G4-4	G1-2	2 meters
U31	G4-2	G1-4	2 meters
U29	G3-6	G0-0	2 meters
U27	G3-5	G0-1	2 meters
U25	G3-3	G0-3	2 meters
U24	G3-1	G0-5	2 meters
U23	N/A	G5-0	included
U22	G2-5	G5-1	1 meter
U21	G3-0	G0-6	2 meters
U20	G2-4	G5-2	2 meters
U18	G2-2	G5-4	2 meters
U16	G1-6	G4-0	2 meters
U14	G2-0	G5-6	2 meters
U12	G1-4	G4-2	2 meters
U10	G1-2	G4-4	2 meters
U8	G1-0	G4-6	2 meters
U6	G0-6	G3-0	2 meters
U4	G0-4	G3-2	2 meters
U2	G0-2	G3-4	2 meters
U1	G0-0	G3-6	2 meters

The following table shows the cable connections from the PDUs to the rack units in Oracle Exadata Storage Expansion Half Rack with Exadata Storage Server with Sun Fire X4270 M2 Servers.

**Table 19-37 Three Phase PDU Cabling for Oracle Exadata Storage Expansion Half Rack with Exadata Storage Server with Sun Fire X4270 M2 Servers**

Rack Unit	PDU-A/PS-00	PDU-B/PS-01	Cable Length
U24	G3-1	G0-5	2 meters
U23	N/A	G5-0	included
U22	G2-5	G5-1	1 meter
U21	G3-0	G0-6	2 meters
U20	G2-4	G5-2	2 meters

**Table 19-37 (Cont.) Three Phase PDU Cabling for Oracle Exadata Storage Expansion Half Rack with Exadata Storage Server with Sun Fire X4270 M2 Servers**

Rack Unit	PDU-A/PS-00	PDU-B/PS-01	Cable Length
U18	G2-2	G5-4	2 meters
U16	G1-6	G4-0	2 meters
U14	G2-0	G5-6	2 meters
U12	G1-4	G4-2	2 meters
U10	G1-2	G4-4	2 meters
U8	G1-0	G4-6	2 meters
U6	G0-6	G3-0	2 meters
U4	G0-4	G3-2	2 meters
U2	G0-2	G3-4	2 meters
U1	G0-0	G3-6	2 meters

The following table shows the cable connections from the PDUs to the rack units in Oracle Exadata Storage Expansion Quarter Rack with Exadata Storage Server with Sun Fire X4270 M2 Servers.

**Table 19-38 Three Phase PDU Cabling for Oracle Exadata Storage Expansion Quarter Rack with Exadata Storage Server with Sun Fire X4270 M2 Servers**

Rack Unit	PDU-A/PS-00	PDU-B/PS-01	Cable Length
U24	G3-1	G0-5	2 meters
U23	N/A	G5-0	included
U22	G2-5	G5-1	1 meter
U21	G3-0	G0-6	2 meters
U20	G2-4	G5-2	2 meters
U8	G1-0	G4-6	2 meters
U6	G0-6	G3-0	2 meters
U4	G0-4	G3-2	2 meters
U2	G0-2	G3-4	2 meters

## 19.6 RDMA Network Fabric Network Cabling Tables

These tables show the RDMA Network Fabric network cabling connections for the Oracle Exadata Storage Expansion Rack.

- [RDMA Network Fabric Cabling for Oracle Exadata Storage Expansion Rack X8M-2](#)  
Use the following RDMA Network Fabric cabling information for the Oracle Exadata Storage Expansion Rack X8M-2
- [InfiniBand Network Cabling for Oracle Exadata Storage Expansion X7-2, X6-2 and X5-2](#)  
Use the following InfiniBand cabling information for the Exadata Storage Expansion X7-2, X6-2 and X5-2 systems.

- [InfiniBand Network Cabling for Oracle Exadata Storage Expansion Rack X4-2 and X3-2](#)  
Use the following InfiniBand cabling information for the Oracle Exadata Storage Expansion Rack X4-2 and X3-2.
- [InfiniBand Network Cabling for Oracle Exadata Storage Expansion with Sun Fire X4270 M2 Servers](#)  
Use the following InfiniBand cabling information for the Oracle Exadata Storage Expansion Server with Sun Fire X4270 M2 servers.

## 19.6.1 RDMA Network Fabric Cabling for Oracle Exadata Storage Expansion Rack X8M-2

Use the following RDMA Network Fabric cabling information for the Oracle Exadata Storage Expansion Rack X8M-2

**Table 19-39 RDMA Network Fabric Cabling for Oracle Exadata Storage Expansion Rack X8M-2 Full Rack**

From Rack Unit	Port	To RDMA Network Fabric Switch Rack Unit	Port	Description
U41	PCle 1, P2	U22	15	3 meters
U41	PCle 1, P1	U20	15	3 meters
U39	PCle 1, P2	U22	08	3 meters
U39	PCle 1, P1	U20	08	3 meters
U37	PCle 1, P2	U22	09	3 meters
U37	PCle 1, P1	U20	09	3 meters
U35	PCle 1, P2	U22	10	3 meters
U35	PCle 1, P1	U20	10	3 meters
U33	PCle 1, P2	U22	11	3 meters
U33	PCle 1, P1	U20	11	3 meters
U31	PCle 1, P2	U22	12	3 meters
U31	PCle 1, P1	U20	12	3 meters
U29	PCle 1, P2	U22	13	3 meters
U29	PCle 1, P1	U20	13	3 meters
U27	PCle 1, P2	U22	14	3 meters
U27	PCle 1, P1	U20	14	3 meters
U25	PCle 1, P2	U22	16	3 meters
U25	PCle 1, P1	U20	16	3 meters
U23	PCle 1, P2	U22	18	3 meters
U23	PCle 1, P1	U20	18	3 meters
U18	PCle 1, P2	U22	20	3 meters
U18	PCle 1, P1	U20	20	3 meters



**Table 19-39 (Cont.) RDMA Network Fabric Cabling for Oracle Exadata Storage Expansion Rack X8M-2 Full Rack**

From Rack Unit	Port	To RDMA Network Fabric Switch Rack Unit	Port	Description
U14	PCle 1, P2	U22	23	3 meters
U14	PCle 1, P1	U20	23	3 meters
U12	PCle 1, P2	U22	24	3 meters
U12	PCle 1, P1	U20	24	3 meters
U10	PCle 1, P2	U22	25	3 meters
U10	PCle 1, P1	U20	25	3 meters
U08	PCle 1, P2	U22	26	3 meters
U08	PCle 1, P1	U20	26	3 meters
U06	PCle 1, P2	U22	27	3 meters
U06	PCle 1, P1	U20	27	3 meters
U04	PCle 1, P2	U22	28	3 meters
U04	PCle 1, P1	U20	28	3 meters
U02	PCle 1, P2	U22	29	3 meters
U02	PCle 1, P1	U20	29	3 meters
U1	PCle 1, P2	U22		3 meters
U1	PCle 1, P1	U20		3 meters

## 19.6.2 InfiniBand Network Cabling for Oracle Exadata Storage Expansion X7-2, X6-2 and X5-2

Use the following InfiniBand cabling information for the Exadata Storage Expansion X7-2, X6-2 and X5-2 systems.

**Table 19-40 InfiniBand Network Cabling for Oracle Exadata Storage Expansion X7-2, X6-2 and X5-2 Full Rack**

From InfiniBand Switch Rack Unit	Port	To Rack Unit	Port
U22	6B	U41	PCle 3, P1
U22	0A	U39	PCle 3, P1
U22	0B	U37	PCle 3, P1
U22	1A	U35	PCle 3, P1
U22	1B	U33	PCle 3, P1
U22	2A	U31	PCle 3, P1
U22	2B	U29	PCle 3, P1
U22	3B	U27	PCle 2, P1

**Table 19-40 (Cont.) InfiniBand Network Cabling for Oracle Exadata Storage Expansion X7-2, X6-2 and X5-2 Full Rack**

From InfiniBand Switch Rack Unit	Port	To Rack Unit	Port
U22	4A	U25	PCle 2, P1
U22	5A	U23	PCle 2, P1
U20	13A	U18	PCle 2, P1
U20	14B	U16	PCle 3, P1
U20	14A	U14	PCle 3, P1
U20	15A	U12	PCle 3, P1
U20	15B	U10	PCle 3, P1
U20	16A	U08	PCle 3, P1
U20	16B	U06	PCle 3, P1
U20	17A	U04	PCle 3, P1
U20	17B	U02	PCle 3, P1
U20	6B	U41	PCle 3, P2
U20	0A	U39	PCle 3, P2
U20	0B	U37	PCle 3, P2
U20	1A	U35	PCle 3, P2
U20	1B	U33	PCle 3, P2
U20	2A	U31	PCle 3, P2
U20	2B	U29	PCle 3, P2
U20	3B	U27	PCle 2, P2
U20	4A	U25	PCle 2, P2
U20	5A	U23	PCle 2, P2
U22	13A	U18	PCle 2, P2
U22	14B	U16	PCle 3, P2
U22	14A	U14	PCle 3, P2
U22	15A	U12	PCle 3, P2
U22	15B	U10	PCle 3, P2
U22	16A	U08	PCle 3, P2
U22	16B	U06	PCle 3, P2
U22	17A	U04	PCle 3, P2
U22	17B	U02	PCle 3, P2
U1	1B	U20	8B
U1	0B	U22	8B

## 19.6.3 InfiniBand Network Cabling for Oracle Exadata Storage Expansion Rack X4-2 and X3-2

Use the following InfiniBand cabling information for the Oracle Exadata Storage Expansion Rack X4-2 and X3-2.

- [Oracle Exadata Storage Expansion Rack X4-2 and X3-2 Full Rack](#) InfiniBand Network Cabling for Oracle Exadata Storage Expansion Rack X4-2 and X3-2 Full Rack
- [Oracle Exadata Storage Expansion Rack X4-2 and X3-2 Half Rack](#) InfiniBand Network Cabling for Oracle Exadata Storage Expansion Rack X4-2 and X3-2 Half Rack
- [Oracle Exadata Storage Expansion Rack X4-2 and X3-2 Quarter Rack](#) InfiniBand Network Cabling for Oracle Exadata Storage Expansion Rack X4-2 and X3-2 Quarter Rack

### Oracle Exadata Storage Expansion Rack X4-2 and X3-2 Full Rack

The following table lists the location, ports and cables for the InfiniBand connections for Oracle Exadata Storage Expansion Rack X4-2 Full Rack, and Oracle Exadata Storage Expansion Rack X3-2 Full Rack.

**Table 19-41 InfiniBand Network Cabling for Oracle Exadata Storage Expansion Rack X4-2 and X3-2 Full Rack**

From InfiniBand Switch Rack Unit	Port	To Rack Unit	Type of Equipment	Port	Cable Description
U22	0A	U39	Oracle Exadata Storage Server	PCIe 3, P1	3 meter QDR InfiniBand cable
U22	0B	U37	Oracle Exadata Storage Server	PCIe 3, P1	3 meter QDR InfiniBand cable
U22	1A	U35	Oracle Exadata Storage Server	PCIe 3, P1	3 meter QDR InfiniBand cable
U22	1B	U33	Oracle Exadata Storage Server	PCIe 3, P1	3 meter QDR InfiniBand cable
U22	2A	U31	Oracle Exadata Storage Server	PCIe 3, P1	3 meter QDR InfiniBand cable
U22	2B	U29	Oracle Exadata Storage Server	PCIe 3, P1	3 meter QDR InfiniBand cable
U22	3A	U27	Oracle Exadata Storage Server	PCIe 3, P1	3 meter QDR InfiniBand cable
U22	4A	U25	Oracle Exadata Storage Server	PCIe 2, P1	2 meter QDR InfiniBand cable

**Table 19-41 (Cont.) InfiniBand Network Cabling for Oracle Exadata Storage Expansion Rack X4-2 and X3-2 Full Rack**

From InfiniBand Switch Rack Unit	Port	To Rack Unit	Type of Equipment	Port	Cable Description
U22	5A	U23	Oracle Exadata Storage Server	PCIe 2, P1	2 meter QDR InfiniBand cable
U22	13A	U18	Oracle Exadata Storage Server	PCIe 2, P2	2 meter QDR InfiniBand cable
U22	14A	U16	Oracle Exadata Storage Server	PCIe 2, P2	2 meter QDR InfiniBand cable
U22	14B	U14	Oracle Exadata Storage Server	PCIe 3, P2	3 meter QDR InfiniBand cable
U22	15A	U12	Oracle Exadata Storage Server	PCIe 3, P2	3 meter QDR InfiniBand cable
U22	15B	U10	Oracle Exadata Storage Server	PCIe 3, P2	3 meter QDR InfiniBand cable
U22	16A	U8	Oracle Exadata Storage Server	PCIe 3, P2	3 meter QDR InfiniBand cable
U22	16B	U6	Oracle Exadata Storage Server	PCIe 3, P2	3 meter QDR InfiniBand cable
U22	17A	U4	Oracle Exadata Storage Server	PCIe 3, P2	3 meter QDR InfiniBand cable
U22	17B	U2	Oracle Exadata Storage Server	PCIe 3, P2	3 meter QDR InfiniBand cable
U20	0A	U39	Oracle Exadata Storage Server	PCIe 3, P2	3 meter QDR InfiniBand cable
U20	0B	U37	Oracle Exadata Storage Server	PCIe 3, P2	3 meter QDR InfiniBand cable
U20	1A	U35	Oracle Exadata Storage Server	PCIe 3, P2	3 meter QDR InfiniBand cable
U20	1B	U33	Oracle Exadata Storage Server	PCIe 3, P2	3 meter QDR InfiniBand cable

**Table 19-41 (Cont.) InfiniBand Network Cabling for Oracle Exadata Storage Expansion Rack X4-2 and X3-2 Full Rack**

From InfiniBand Switch Rack Unit	Port	To Rack Unit	Type of Equipment	Port	Cable Description
U20	2A	U31	Oracle Exadata Storage Server	PCIe 3, P2	3 meter QDR InfiniBand cable
U20	2B	U29	Oracle Exadata Storage Server	PCIe 3, P2	3 meter QDR InfiniBand cable
U20	3A	U27	Oracle Exadata Storage Server	PCIe 3, P2	3 meter QDR InfiniBand cable
U20	4A	U25	Oracle Exadata Storage Server	PCIe 2, P2	3 meter QDR InfiniBand cable
U20	5A	U23	Oracle Exadata Storage Server	PCIe 2, P2	3 meter QDR InfiniBand cable
U20	13A	U18	Oracle Exadata Storage Server	PCIe 2, P1	3 meter QDR InfiniBand cable
U20	14A	U16	Oracle Exadata Storage Server	PCIe 2, P1	3 meter QDR InfiniBand cable
U20	14B	U14	Oracle Exadata Storage Server	PCIe 3, P1	3 meter QDR InfiniBand cable
U20	15A	U12	Oracle Exadata Storage Server	PCIe 3, P1	3 meter QDR InfiniBand cable
U20	15B	U10	Oracle Exadata Storage Server	PCIe 3, P1	3 meter QDR InfiniBand cable
U20	16A	U8	Oracle Exadata Storage Server	PCIe 3, P1	3 meter QDR InfiniBand cable
U20	16B	U6	Oracle Exadata Storage Server	PCIe 3, P1	3 meter QDR InfiniBand cable
U20	17A	U4	Oracle Exadata Storage Server	PCIe 3, P1	3 meter QDR InfiniBand cable
U20	17B	U2	Oracle Exadata Storage Server	PCIe 3, P1	3 meter QDR InfiniBand cable

**Table 19-41 (Cont.) InfiniBand Network Cabling for Oracle Exadata Storage Expansion Rack X4-2 and X3-2 Full Rack**

From InfiniBand Switch Rack Unit	Port	To Rack Unit	Type of Equipment	Port	Cable Description
U20	9B	U22	Sun Datacenter InfiniBand Switch 36 switch	9A	2 meter QDR InfiniBand cable
U20	10B	U22	Sun Datacenter InfiniBand Switch 36 switch	10A	2 meter QDR InfiniBand cable
U20	11B	U22	Sun Datacenter InfiniBand Switch 36 switch	11A	2 meter QDR InfiniBand cable
U20	8A	U22	Sun Datacenter InfiniBand Switch 36 switch	8A	2 meter QDR InfiniBand cable
U20	9A	U22	Sun Datacenter InfiniBand Switch 36 switch	9B	2 meter QDR InfiniBand cable
U20	10A	U22	Sun Datacenter InfiniBand Switch 36 switch	10B	2 meter QDR InfiniBand cable
U20	11A	U22	Sun Datacenter InfiniBand Switch 36 switch	11B	2 meter QDR InfiniBand cable
U1	1B	U20	Sun Datacenter InfiniBand Switch 36 switch	8B	3 meter QDR InfiniBand cable
U1	0B	U22	Sun Datacenter InfiniBand Switch 36 switch	8B	3 meter QDR InfiniBand cable

**Oracle Exadata Storage Expansion Rack X4-2 and X3-2 Half Rack**

The following table lists the location, ports and cables for the InfiniBand connections for Oracle Exadata Storage Expansion Rack X4-2 Half Rack, and Oracle Exadata Storage Expansion Rack X3-2 Half Rack.

**Table 19-42 InfiniBand Network Cabling for Oracle Exadata Storage Expansion Rack X4-2 and X3-2 Half Rack**

From InfiniBand Switch Rack Unit	Port	To Rack Unit	Type of Equipment	Port	Cable Description
U22	13A	U18	Oracle Exadata Storage Server	PCIe 2, P2	3 meter QDR InfiniBand cable
U22	14A	U16	Oracle Exadata Storage Server	PCIe 2, P2	3 meter QDR InfiniBand cable
U22	14B	U14	Oracle Exadata Storage Server	PCIe 3, P2	3 meter QDR InfiniBand cable
U22	15A	U12	Oracle Exadata Storage Server	PCIe 3, P2	3 meter QDR InfiniBand cable
U22	15B	U10	Oracle Exadata Storage Server	PCIe 3, P2	3 meter QDR InfiniBand cable
U22	16A	U8	Oracle Exadata Storage Server	PCIe 3, P2	3 meter QDR InfiniBand cable
U22	16B	U6	Oracle Exadata Storage Server	PCIe 3, P2	3 meter QDR InfiniBand cable
U22	17A	U4	Oracle Exadata Storage Server	PCIe 3, P2	3 meter QDR InfiniBand cable
U22	17B	U2	Oracle Exadata Storage Server	PCIe 3, P2	3 meter QDR InfiniBand cable
U20	13A	U18	Oracle Exadata Storage Server	PCIe 2, P1	3 meter QDR InfiniBand cable
U20	14A	U16	Oracle Exadata Storage Server	PCIe 2, P1	3 meter QDR InfiniBand cable
U20	14B	U14	Oracle Exadata Storage Server	PCIe 3, P1	3 meter QDR InfiniBand cable
U20	15A	U12	Oracle Exadata Storage Server	PCIe 3, P1	3 meter QDR InfiniBand cable
U20	15B	U10	Oracle Exadata Storage Server	PCIe 3, P1	3 meter QDR InfiniBand cable

**Table 19-42 (Cont.) InfiniBand Network Cabling for Oracle Exadata Storage Expansion Rack X4-2 and X3-2 Half Rack**

From InfiniBand Switch Rack Unit	Port	To Rack Unit	Type of Equipment	Port	Cable Description
U20	16A	U8	Oracle Exadata Storage Server	PCIe 3, P1	3 meter QDR InfiniBand cable
U20	16B	U6	Oracle Exadata Storage Server	PCIe 3, P1	3 meter QDR InfiniBand cable
U20	17A	U4	Oracle Exadata Storage Server	PCIe 3, P1	3 meter QDR InfiniBand cable
U20	17B	U2	Oracle Exadata Storage Server	PCIe 3, P1	3 meter QDR InfiniBand cable
U20	9B	U22	Sun Datacenter InfiniBand Switch 36 switch	9A	2 meter QDR InfiniBand cable
U20	10B	U22	Sun Datacenter InfiniBand Switch 36 switch	10A	2 meter QDR InfiniBand cable
U20	11B	U22	Sun Datacenter InfiniBand Switch 36 switch	11A	2 meter QDR InfiniBand cable
U20	8A	U22	Sun Datacenter InfiniBand Switch 36 switch	8A	2 meter QDR InfiniBand cable
U20	9A	U22	Sun Datacenter InfiniBand Switch 36 switch	9B	2 meter QDR InfiniBand cable
U20	10A	U22	Sun Datacenter InfiniBand Switch 36 switch	10B	2 meter QDR InfiniBand cable
U20	11A	U22	Sun Datacenter InfiniBand Switch 36 switch	11B	2 meter QDR InfiniBand cable
U1	1B	U20	Sun Datacenter InfiniBand Switch 36 switch	8B	3 meter QDR InfiniBand cable



**Table 19-42 (Cont.) InfiniBand Network Cabling for Oracle Exadata Storage Expansion Rack X4-2 and X3-2 Half Rack**

From InfiniBand Switch Rack Unit	Port	To Rack Unit	Type of Equipment	Port	Cable Description
U1	0B	U22	Sun Datacenter InfiniBand Switch 36 switch	8B	3 meter QDR InfiniBand cable

**Oracle Exadata Storage Expansion Rack X4-2 and X3-2 Quarter Rack**

The following table lists the location, ports and cables for the InfiniBand connections for Oracle Exadata Storage Expansion Rack X4-2 Quarter Rack, and Oracle Exadata Storage Expansion Rack X3-2 Quarter Rack.

**Table 19-43 InfiniBand Network Cabling for Oracle Exadata Storage Expansion Rack X4-2 and X3-2 Quarter Rack**

From InfiniBand Switch Rack Unit	Port	To Rack Unit	Type of Equipment	Port	Cable Description
U22	16A	U8	Oracle Exadata Storage Server	PCIe 2, P2	3 meter QDR InfiniBand cable
U22	16B	U6	Oracle Exadata Storage Server	PCIe 3, P2	3 meter QDR InfiniBand cable
U22	17A	U4	Oracle Exadata Storage Server	PCIe 3, P2	3 meter QDR InfiniBand cable
U22	17B	U2	Oracle Exadata Storage Server	PCIe 3, P2	3 meter QDR InfiniBand cable
U20	16A	U8	Oracle Exadata Storage Server	PCIe 2, P1	2 meter QDR InfiniBand cable
U20	16B	U6	Oracle Exadata Storage Server	PCIe 3, P1	3 meter QDR InfiniBand cable
U20	17A	U4	Oracle Exadata Storage Server	PCIe 3, P1	3 meter QDR InfiniBand cable
U20	17B	U2	Oracle Exadata Storage Server	PCIe 3, P1	3 meter QDR InfiniBand cable

**Table 19-43 (Cont.) InfiniBand Network Cabling for Oracle Exadata Storage Expansion Rack X4-2 and X3-2 Quarter Rack**

From InfiniBand Switch Rack Unit	Port	To Rack Unit	Type of Equipment	Port	Cable Description
U20	9B	U22	Sun Datacenter InfiniBand Switch 36 switch	9A	2 meter QDR InfiniBand cable
U20	10B	U22	Sun Datacenter InfiniBand Switch 36 switch	10A	2 meter QDR InfiniBand cable
U20	11B	U22	Sun Datacenter InfiniBand Switch 36 switch	11A	2 meter QDR InfiniBand cable
U20	8A	U22	Sun Datacenter InfiniBand Switch 36 switch	8A	2 meter QDR InfiniBand cable
U20	9A	U22	Sun Datacenter InfiniBand Switch 36 switch	9B	2 meter QDR InfiniBand cable
U20	10A	U22	Sun Datacenter InfiniBand Switch 36 switch	10B	2 meter QDR InfiniBand cable
U20	11A	U22	Sun Datacenter InfiniBand Switch 36 switch	11B	2 meter QDR InfiniBand cable
U1	1B	U20	Sun Datacenter InfiniBand Switch 36 switch	8B	3 meter QDR InfiniBand cable
U1	0B	U22	Sun Datacenter InfiniBand Switch 36 switch	8B	3 meter QDR InfiniBand cable

## 19.6.4 InfiniBand Network Cabling for Oracle Exadata Storage Expansion with Sun Fire X4270 M2 Servers

Use the following InfiniBand cabling information for the Oracle Exadata Storage Expansion Server with Sun Fire X4270 M2 servers.

- [Exadata Storage Expansion Full Rack with Sun Fire X4270 M2 Servers](#)

- [Exadata Storage Expansion Half Rack with Sun Fire X4270 M2 Servers](#)
- [Exadata Storage Expansion Quarter Rack with Sun Fire X4270 M2 Servers](#)

**Exadata Storage Expansion Full Rack with Sun Fire X4270 M2 Servers**

Table 19-44 lists the location, ports and cables for the InfiniBand connections for Oracle Exadata Storage Expansion Full Rack with Exadata Storage Server with Sun Fire X4270 M2 Servers.

**Table 19-44 InfiniBand Network Cabling for Oracle Exadata Storage Expansion Full Rack with Sun Fire X4270 M2 Servers**

From InfiniBand Switch Rack Unit	Port	To Rack Unit	Type of Equipment	Port	Cable Description
U24	0A	U41	Exadata Storage Server	PCIe 3, P1	3 meter QDR InfiniBand cable
U24	0B	U39	Exadata Storage Server	PCIe 3, P1	3 meter QDR InfiniBand cable
U24	1A	U37	Exadata Storage Server	PCIe 3, P1	3 meter QDR InfiniBand cable
U24	1B	U35	Exadata Storage Server	PCIe 3, P1	3 meter QDR InfiniBand cable
U24	2A	U33	Exadata Storage Server	PCIe 3, P1	3 meter QDR InfiniBand cable
U24	2B	U31	Exadata Storage Server	PCIe 3, P1	3 meter QDR InfiniBand cable
U24	3A	U29	Exadata Storage Server	PCIe 3, P1	3 meter QDR InfiniBand cable
U24	4A	U27	Exadata Storage Server	PCIe 2, P1	2 meter QDR InfiniBand cable
U24	5A	U25	Exadata Storage Server	PCIe 2, P1	2 meter QDR InfiniBand cable
U24	13A	U18	Exadata Storage Server	PCIe 2, P2	2 meter QDR InfiniBand cable
U24	14A	U16	Exadata Storage Server	PCIe 2, P2	2 meter QDR InfiniBand cable
U24	14B	U14	Exadata Storage Server	PCIe 3, P2	3 meter QDR InfiniBand cable

**Table 19-44 (Cont.) InfiniBand Network Cabling for Oracle Exadata Storage Expansion Full Rack with Sun Fire X4270 M2 Servers**

From InfiniBand Switch Rack Unit	Port	To Rack Unit	Type of Equipment	Port	Cable Description
U24	15A	U12	Exadata Storage Server	PCIe 3, P2	3 meter QDR InfiniBand cable
U24	15B	U10	Exadata Storage Server	PCIe 3, P2	3 meter QDR InfiniBand cable
U24	16A	U8	Exadata Storage Server	PCIe 3, P2	3 meter QDR InfiniBand cable
U24	16B	U6	Exadata Storage Server	PCIe 3, P2	3 meter QDR InfiniBand cable
U24	17A	U4	Exadata Storage Server	PCIe 3, P2	3 meter QDR InfiniBand cable
U24	17B	U2	Exadata Storage Server	PCIe 3, P2	3 meter QDR InfiniBand cable
U20	0A	U41	Exadata Storage Server	PCIe 3, P2	3 meter QDR InfiniBand cable
U20	0B	U39	Exadata Storage Server	PCIe 3, P2	3 meter QDR InfiniBand cable
U20	1A	U37	Exadata Storage Server	PCIe 3, P2	3 meter QDR InfiniBand cable
U20	1B	U35	Exadata Storage Server	PCIe 3, P2	3 meter QDR InfiniBand cable
U20	2A	U33	Exadata Storage Server	PCIe 3, P2	3 meter QDR InfiniBand cable
U20	2B	U31	Exadata Storage Server	PCIe 3, P2	3 meter QDR InfiniBand cable
U20	3A	U29	Exadata Storage Server	PCIe 3, P2	3 meter QDR InfiniBand cable
U20	4A	U27	Exadata Storage Server	PCIe 2, P2	2 meter QDR InfiniBand cable

**Table 19-44 (Cont.) InfiniBand Network Cabling for Oracle Exadata Storage Expansion Full Rack with Sun Fire X4270 M2 Servers**

From InfiniBand Switch Rack Unit	Port	To Rack Unit	Type of Equipment	Port	Cable Description
U20	5A	U25	Exadata Storage Server	PCIe 2, P2	2 meter QDR InfiniBand cable
U20	13A	U18	Exadata Storage Server	PCIe 2, P1	2 meter QDR InfiniBand cable
U20	14A	U16	Exadata Storage Server	PCIe 2, P1	2 meter QDR InfiniBand cable
U20	14B	U14	Exadata Storage Server	PCIe 3, P1	2 meter QDR InfiniBand cable
U20	15A	U12	Exadata Storage Server	PCIe 3, P1	3 meter QDR InfiniBand cable
U20	15B	U10	Exadata Storage Server	PCIe 3, P1	3 meter QDR InfiniBand cable
U20	16A	U8	Exadata Storage Server	PCIe 3, P1	3 meter QDR InfiniBand cable
U20	16B	U6	Exadata Storage Server	PCIe 3, P1	3 meter QDR InfiniBand cable
U20	17A	U4	Exadata Storage Server	PCIe 3, P1	3 meter QDR InfiniBand cable
U20	17B	U2	Exadata Storage Server	PCIe 3, P1	3 meter QDR InfiniBand cable
U20	9B	U24	Sun Datacenter InfiniBand Switch 36 switch	9A	2 meter QDR InfiniBand cable
U20	10B	U24	Sun Datacenter InfiniBand Switch 36 switch	10A	2 meter QDR InfiniBand cable
U20	11B	U24	Sun Datacenter InfiniBand Switch 36 switch	11A	2 meter QDR InfiniBand cable

**Table 19-44 (Cont.) InfiniBand Network Cabling for Oracle Exadata Storage Expansion Full Rack with Sun Fire X4270 M2 Servers**

From InfiniBand Switch Rack Unit	Port	To Rack Unit	Type of Equipment	Port	Cable Description
U20	8A	U24	Sun Datacenter InfiniBand Switch 36 switch	8A	2 meter QDR InfiniBand cable
U20	9A	U24	Sun Datacenter InfiniBand Switch 36 switch	9B	2 meter QDR InfiniBand cable
U20	10A	U24	Sun Datacenter InfiniBand Switch 36 switch	10B	2 meter QDR InfiniBand cable
U20	11A	U24	Sun Datacenter InfiniBand Switch 36 switch	11B	2 meter QDR InfiniBand cable
U1	1B	U20	Sun Datacenter InfiniBand Switch 36 switch	8B	3 meter QDR InfiniBand cable
U1	0B	U24	Sun Datacenter InfiniBand Switch 36 switch	8B	3 meter QDR InfiniBand cable

**Exadata Storage Expansion Half Rack with Sun Fire X4270 M2 Servers**

Table 19-45 lists the location, ports and cables for the InfiniBand connections for Oracle Exadata Storage Expansion Half Rack with Exadata Storage Server with Sun Fire X4270 M2 Servers.

**Table 19-45 InfiniBand Network Cabling for Oracle Exadata Storage Expansion Half Rack with Sun Fire X4270 M2 Servers**

From InfiniBand Switch Rack Unit	Port	To Rack Unit	Type of Equipment	Port	Cable Description
U24	13A	U18	Exadata Storage Server	PCIe 2, P2	2 meter QDR InfiniBand cable
U24	14A	U16	Exadata Storage Server	PCIe 2, P2	2 meter QDR InfiniBand cable

**Table 19-45 (Cont.) InfiniBand Network Cabling for Oracle Exadata Storage Expansion Half Rack with Sun Fire X4270 M2 Servers**

From InfiniBand Switch Rack Unit	Port	To Rack Unit	Type of Equipment	Port	Cable Description
U24	14B	U14	Exadata Storage Server	PCIe 3, P2	3 meter QDR InfiniBand cable
U24	15A	U12	Exadata Storage Server	PCIe 3, P2	3 meter QDR InfiniBand cable
U24	15B	U10	Exadata Storage Server	PCIe 3, P2	3 meter QDR InfiniBand cable
U24	16A	U8	Exadata Storage Server	PCIe 3, P2	3 meter QDR InfiniBand cable
U24	16B	U6	Exadata Storage Server	PCIe 3, P2	3 meter QDR InfiniBand cable
U24	17A	U4	Exadata Storage Server	PCIe 3, P2	3 meter QDR InfiniBand cable
U24	17B	U2	Exadata Storage Server	PCIe 3, P2	3 meter QDR InfiniBand cable
U20	13A	U18	Exadata Storage Server	PCIe 2, P1	2 meter QDR InfiniBand cable
U20	14A	U16	Exadata Storage Server	PCIe 2, P1	2 meter QDR InfiniBand cable
U20	14B	U14	Exadata Storage Server	PCIe 3, P1	2 meter QDR InfiniBand cable
U20	15A	U12	Exadata Storage Server	PCIe 3, P1	3 meter QDR InfiniBand cable
U20	15B	U10	Exadata Storage Server	PCIe 3, P1	3 meter QDR InfiniBand cable
U20	16A	U8	Exadata Storage Server	PCIe 3, P1	3 meter QDR InfiniBand cable
U20	16B	U6	Exadata Storage Server	PCIe 3, P1	3 meter QDR InfiniBand cable

**Table 19-45 (Cont.) InfiniBand Network Cabling for Oracle Exadata Storage Expansion Half Rack with Sun Fire X4270 M2 Servers**

From InfiniBand Switch Rack Unit	Port	To Rack Unit	Type of Equipment	Port	Cable Description
U20	17A	U4	Exadata Storage Server	PCIe 3, P1	3 meter QDR InfiniBand cable
U20	17B	U2	Exadata Storage Server	PCIe 3, P1	3 meter QDR InfiniBand cable
U20	9B	U24	Sun Datacenter InfiniBand Switch 36 switch	9A	2 meter QDR InfiniBand cable
U20	10B	U24	Sun Datacenter InfiniBand Switch 36 switch	10A	2 meter QDR InfiniBand cable
U20	11B	U24	Sun Datacenter InfiniBand Switch 36 switch	11A	2 meter QDR InfiniBand cable
U20	8A	U24	Sun Datacenter InfiniBand Switch 36 switch	8A	2 meter QDR InfiniBand cable
U20	9A	U24	Sun Datacenter InfiniBand Switch 36 switch	9B	2 meter QDR InfiniBand cable
U20	10A	U24	Sun Datacenter InfiniBand Switch 36 switch	10B	2 meter QDR InfiniBand cable
U20	11A	U24	Sun Datacenter InfiniBand Switch 36 switch	11B	2 meter QDR InfiniBand cable
U1	1B	U20	Sun Datacenter InfiniBand Switch 36 switch	8B	3 meter QDR InfiniBand cable



**Table 19-45 (Cont.) InfiniBand Network Cabling for Oracle Exadata Storage Expansion Half Rack with Sun Fire X4270 M2 Servers**

From InfiniBand Switch Rack Unit	Port	To Rack Unit	Type of Equipment	Port	Cable Description
U1	0B	U24	Sun Datacenter InfiniBand Switch 36 switch	8B	3 meter QDR InfiniBand cable

**Exadata Storage Expansion Quarter Rack with Sun Fire X4270 M2 Servers**

[Table 19-46](#) lists the location, ports and cables for the InfiniBand connections for Oracle Exadata Storage Expansion Quarter Rack with Exadata Storage Server with Sun Fire X4270 M2 Servers.

**Table 19-46 InfiniBand Network Cabling for Oracle Exadata Storage Expansion Quarter Rack with Sun Fire X4270 M2 Servers**

From InfiniBand Switch Rack Unit	Port	To Rack Unit	Type of Equipment	Port	Cable Description
U24	16A	U8	Exadata Storage Server	PCIe 2, P2	2 meter QDR InfiniBand cable
U24	16B	U6	Exadata Storage Server	PCIe 3, P2	3 meter QDR InfiniBand cable
U24	17A	U4	Exadata Storage Server	PCIe 3, P2	3 meter QDR InfiniBand cable
U24	17B	U2	Exadata Storage Server	PCIe 3, P2	3 meter QDR InfiniBand cable
U20	16A	U8	Exadata Storage Server	PCIe 2, P1	2 meter QDR InfiniBand cable
U20	16B	U6	Exadata Storage Server	PCIe 3, P1	3 meter QDR InfiniBand cable
U20	17A	U4	Exadata Storage Server	PCIe 3, P1	3 meter QDR InfiniBand cable
U20	17B	U2	Exadata Storage Server	PCIe 3, P1	3 meter QDR InfiniBand cable

**Table 19-46 (Cont.) InfiniBand Network Cabling for Oracle Exadata Storage Expansion Quarter Rack with Sun Fire X4270 M2 Servers**

From InfiniBand Switch Rack Unit	Port	To Rack Unit	Type of Equipment	Port	Cable Description
U20	9B	U24	Sun Datacenter InfiniBand Switch 36 switch	9A	2 meter QDR InfiniBand cable
U20	10B	U24	Sun Datacenter InfiniBand Switch 36 switch	10A	2 meter QDR InfiniBand cable
U20	11B	U24	Sun Datacenter InfiniBand Switch 36 switch	11A	2 meter QDR InfiniBand cable
U20	8A	U24	Sun Datacenter InfiniBand Switch 36 switch	8A	2 meter QDR InfiniBand cable
U20	9A	U24	Sun Datacenter InfiniBand Switch 36 switch	9B	2 meter QDR InfiniBand cable
U20	10A	U24	Sun Datacenter InfiniBand Switch 36 switch	10B	2 meter QDR InfiniBand cable
U20	11A	U24	Sun Datacenter InfiniBand Switch 36 switch	11B	2 meter QDR InfiniBand cable

# A

## Components of Exadata Database Machine

The components of Exadata Database Machine described in this topic are current as of the time of release.

Refer to the latest release notes and patch updates for any changes.

### Note:

The components and specifications listed in this appendix are for the database servers only. The components of database servers upgraded from an earlier release may not match the ones shown here.

The specifications for Oracle Exadata Storage Servers are not listed because they cannot be modified by the customer.

- Operating system: Oracle Linux
- Disk and file systems: There are four hard disks in each database server of a 2-socket Exadata Database Machine. There are eight hard disks in each database server of a 8-socket Oracle Exadata Database Machine, or, starting with Exadata Database Machine X7-8, two flash accelerator PCIe cards, 6.4 TB each.  
  
The disk partitions on a database server in Exadata Database Machine are configured with two file systems, and a swap partition. The root (/) file system is 30 GB, the /u01 file system is 100 GB, and the swap partition is 24 GB.
- Services: Nonessential services are disabled on database servers. Enabled services include SSH for remote access, and after deployment, listeners. SSH only accepts incoming connections from the management network and RDMA Network Fabric network. Oracle Enterprise Manager Cloud Control agents can be installed and enabled after deployment, as an option.
- User accounts: The only non-default user accounts created during deployment are those required for software ownership of Oracle Grid Infrastructure and Oracle Database Oracle homes (ORACLE\_HOMES). The user account names are chosen by the customer with the Oracle Exadata Deployment Assistant (OEDA) utility.
- RPM packages: Refer to My Oracle Support note 888828.1 for the instructions to obtain the current list of RPM packages.
- [Obtaining Information about Exadata Database Machine Components](#)  
Using operating system commands, you can obtain the information about the components in Exadata Database Machine servers.

### Related Topics

- [Exadata Database Machine and Exadata Storage Server Supported Versions \(My Oracle Support Doc ID 888828.1\)](#)

## A.1 Obtaining Information about Exadata Database Machine Components

Using operating system commands, you can obtain the information about the components in Exadata Database Machine servers.

The component information can be obtained as follows:

- Kernel version: Run one of the following commands as the `root` user:

```
# uname -a
# uname -r
```

- Oracle Linux release: Run one of the following commands as the `root` user:

```
# cat /etc/oracle-release
# cat /etc/enterprise-release
```

- List of all packages: Run the following command as the `root` user:

```
rpm -qa --queryformat="%{name}-%{version}-%{release}.%{arch}\n"
```

- List of RDMA Network Fabric packages: The main package names can be obtained from the list of RPMs file `ofedrpllist`. The file can be extracted by running the following command as the `root` user:

```
tar -pjxvf /opt/oracle.cellos/iso/cellbits/ofed.tbz ofedrpllist
```

In addition to the packages listed in the file, check if there are any `ofa` RPMs installed using the following command:

```
rpm -qa --queryformat="%{name}-%{version}-%{release}.%{arch}\n" |
grep -i ofa
```

- List of services: Run the following command as the `root` user:

```
chkconfig --list | grep ':on'
```